



FCC Test Report

APPLICANT : ZTE CORPORATION
EQUIPMENT : LTE/WCDMA Multi-Mode Digital Mobile Phone
BRAND NAME : ZTE
MODEL NAME : Z2321A
FCC ID : SRQ-Z2321A
STANDARD : FCC 47 CFR FCC Part 15 Subpart B
CLASSIFICATION : Certification

The product was received on Nov. 28, 2017 and testing was completed on Dec. 15, 2017. We, Sporton International (Shenzhen) Inc., would like to declare that the tested sample has been evaluated in accordance with the test procedures given in ANSI C63.4-2014 and has been in compliance with the applicable technical standards.

The test results in this report apply exclusively to the tested model / sample. Without written approval of Sporton International (Shenzhen) Inc., the test report shall not be reproduced except in full.



Approved by: Eric Shih / Manager

Sporton International (Shenzhen) Inc.

**1/F, 2/F, Bldg 5, Shiling Industrial Zone, Xinwei Village, Xili, Nanshan Shenzhen City
Guangdong Province 518055 China**



TABLE OF CONTENTS

REVISION HISTORY..... 3

SUMMARY OF TEST RESULT 4

1. GENERAL DESCRIPTION 5

 1.1. Applicant..... 5

 1.2. Manufacturer 5

 1.3. Product Feature of Equipment Under Test 5

 1.4. Product Specification of Equipment Under Test 6

 1.5. Modification of EUT 6

 1.6. Test Location 7

 1.7. Applicable Standards 7

2. TEST CONFIGURATION OF EQUIPMENT UNDER TEST 8

 2.1. Test Mode 8

 2.2. Connection Diagram of Test System 9

 2.3. Support Unit used in test configuration and system 10

 2.4. EUT Operation Test Setup 10

3. TEST RESULT 11

 3.1. Test of AC Conducted Emission Measurement 11

 3.2. Test of Radiated Emission Measurement 17

4. LIST OF MEASURING EQUIPMENT 22

5. UNCERTAINTY OF EVALUATION 23

APPENDIX A. SETUP PHOTOGRAPHS



REVISION HISTORY

REPORT NO.	VERSION	DESCRIPTION	ISSUED DATE
FC7N2807	Rev. 01	Initial issue of report	Jan. 16, 2018



SUMMARY OF TEST RESULT

Report Section	FCC Rule	Description	Limit	Result	Remark
3.1	15.107	AC Conducted Emission	< 15.107 limits	PASS	Under limit 9.30 dB at 0.620 MHz
3.2	15.109	Radiated Emission	< 15.109 limits	PASS	Under limit 3.37 dB at 250.190 MHz



1. General Description

1.1. Applicant

ZTE CORPORATION

ZTE Plaza, Keji Road South, Hi-Tech, Industrial Park, Nanshan District, Shenzhen, Guangdong, 518057, P.R.China

1.2. Manufacturer

ZTE CORPORATION

ZTE Plaza, Keji Road South, Hi-Tech, Industrial Park, Nanshan District, Shenzhen, Guangdong, 518057, P.R.China

1.3. Product Feature of Equipment Under Test

Product Feature	
Equipment	LTE/WCDMA Multi-Mode Digital Mobile Phone
Brand Name	ZTE
Model Name	Z2321A
FCC ID	SRQ-Z2321A
EUT supports Radios application	WCDMA/HSPA/HSPA+ (16QAM uplink is not supported)/LTE Bluetooth v2.0+EDR/Bluetooth v4.2 LE
IMEI Code	Conduction: 867075030003739 Radiation: 867075030006807
HW Version	Z2321AHW1.0
SW Version	Z2321AV1.0.0B01
EUT Stage	Identical Prototype

Remark: The above EUT's information was declared by manufacturer. Please refer to the specifications or user's manual for more detailed description.



1.4. Product Specification of Equipment Under Test

Standards-related Product Specification	
Tx Frequency	WCDMA Band V: 826.4 MHz ~ 846.6 MHz WCDMA Band II: 1852.4 MHz ~ 1907.6 MHz LTE Band 2 : 1850.7 MHz ~ 1909.3 MHz LTE Band 4 : 1710.7 MHz ~ 1754.3 MHz LTE Band 5 : 824.7 MHz ~ 848.3 MHz LTE Band 12 : 699.7 MHz ~ 715.3 MHz Bluetooth: 2402 MHz ~ 2480 MHz
Rx Frequency	WCDMA Band V: 871.4 MHz ~ 891.6 MHz WCDMA Band II: 1932.4 MHz ~ 1987.6 MHz LTE Band 2 : 1930.7 MHz ~ 1989.3 MHz LTE Band 4 : 2110.7 MHz ~ 2154.3 MHz LTE Band 5 : 869.7 MHz ~ 893.3 MHz LTE Band 12 : 729.7 MHz ~ 745.3 MHz Bluetooth: 2402 MHz ~ 2480 MHz GPS : 1.57542 GHz FM : 88 MHz ~ 108 MHz
Antenna Type	WWAN : PIFA Antenna Bluetooth : PIFA Antenna GPS : PIFA Antenna FM : External Headset Antenna
Type of Modulation	WCDMA : BPSK (Uplink) HSDPA : QPSK (Uplink) HSUPA: QPSK (Uplink) HSPA+ : 16QAM uplink is not supported LTE: QPSK / 16QAM Bluetooth LE : GFSK Bluetooth (1Mbps) : GFSK Bluetooth (2Mbps) : $\pi/4$ -DQPSK Bluetooth (3Mbps) : 8-DPSK GPS : BPSK FM

1.5. Modification of EUT

No modifications are made to the EUT during all test items.



1.6. Test Location

Sporton International (Shenzhen) Inc. is accredited to ISO 17025 by National Voluntary Laboratory Accreditation Program (NVLAP code: 600156-0) and the FCC designation No. are CN5018 and CN5019

Test Site	Sporton International (Shenzhen) Inc.	
Test Site Location	1/F, 2/F, Bldg 5, Shiling Industrial Zone, Xinwei Village, Xili, Nanshan Shenzhen City Guangdong Province 518055 China TEL: +86-755-8637-9589 FAX: +86-755-8637-9595	
Test Site No.	Sporton Site No.	FCC Test Firm Registration No.
	CO01-SZ	251365

Test Site	Sporton International (Shenzhen) Inc.	
Test Site Location	No. 3 Bldg the third floor of south, Shahe River west, Fengzeyuan Warehouse, Nanshan District Shenzhen City Guangdong Province 518055 China TEL: +86-755-3320-2398	
Test Site No.	Sporton Site No.	FCC Test Firm Registration No.
	03CH01-SZ	577730

Note: The test site complies with ANSI C63.4 2014 requirement.

1.7. Applicable Standards

According to the specifications of the manufacturer, the EUT must comply with the requirements of the following standards:

- FCC 47 CFR FCC Part 15 Subpart B
- ANSI C63.4-2014

Remark: All test items were verified and recorded according to the standards and without any deviation during the test.



2. Test Configuration of Equipment Under Test

2.1. Test Mode

The EUT has been associated with peripherals pursuant to ANSI C63.4-2014 and configuration operated in a manner tended to maximize its emission characteristics in a typical application.

Frequency range investigated: conduction (150 kHz to 30 MHz), radiation (30MHz to the 5th harmonic of the highest fundamental frequency or to 40 GHz, whichever is lower).

Test Items	Function Type
AC Conducted Emission	Mode 1: WCDMA Band V Idle + Bluetooth Idle + Earphone + Camera(Rear) + USB Cable (Charging from Adapter) + SD Card <Fig.1> Mode 2: WCDMA Band II Idle + Bluetooth Idle + Earphone + MPEG4 + USB Cable (Charging from Adapter) + SD Card <Fig.1> Mode 3: LTE Band 2 Idle + Bluetooth Idle + Earphone + Play Music (From SD Card) + USB Cable (Charging from Adapter) + SD Card <Fig.1> Mode 4: LTE Band 4 Idle + Bluetooth Idle + Earphone + GPS RX + USB Cable (Data Link with Notebook) + SD Card <Fig.2>
Radiated Emissions < 1GHz	Mode 1: WCDMA Band V Idle + Bluetooth Idle + Earphone + Camera(Rear) + USB Cable (Charging from Adapter) + SD Card <Fig.1> Mode 2: WCDMA Band II Idle + Bluetooth Idle + Earphone + MPEG4 + USB Cable (Charging from Adapter) + SD Card <Fig.1> Mode 3: LTE Band 2 Idle + Bluetooth Idle + Earphone + Play Music (From SD Card) + USB Cable (Charging from Adapter) + SD Card <Fig.1> Mode 4: LTE Band 4 Idle + Bluetooth Idle + Earphone + GPS RX + USB Cable (Data Link with Notebook) + SD Card + Battery <Fig.2>
Radiated Emissions ≥ 1GHz	Mode 1: LTE Band 4 Idle + Bluetooth Idle + Earphone + GPS RX + USB Cable (Data Link with Notebook) + SD Card + Battery <Fig.2>
Remark:	
<ol style="list-style-type: none"> The worst case of AC is mode 1; and the USB data link mode is mode 4, the test data of these modes are reported. The worst case of RE < 1G is mode 4; only the test data of this mode was reported. Data Link with Notebook means data application transferred mode between EUT and Notebook. 	

2.2. Connection Diagram of Test System

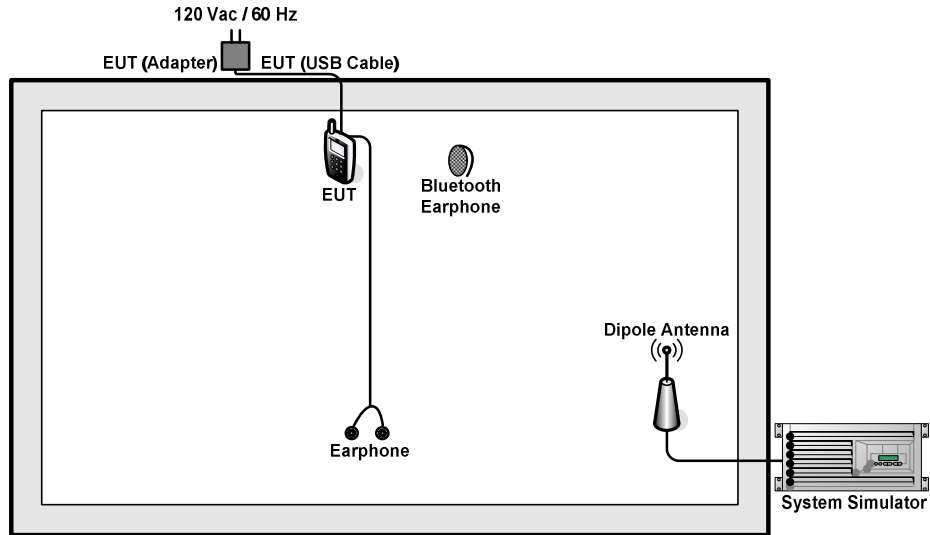

<Fig. 1>

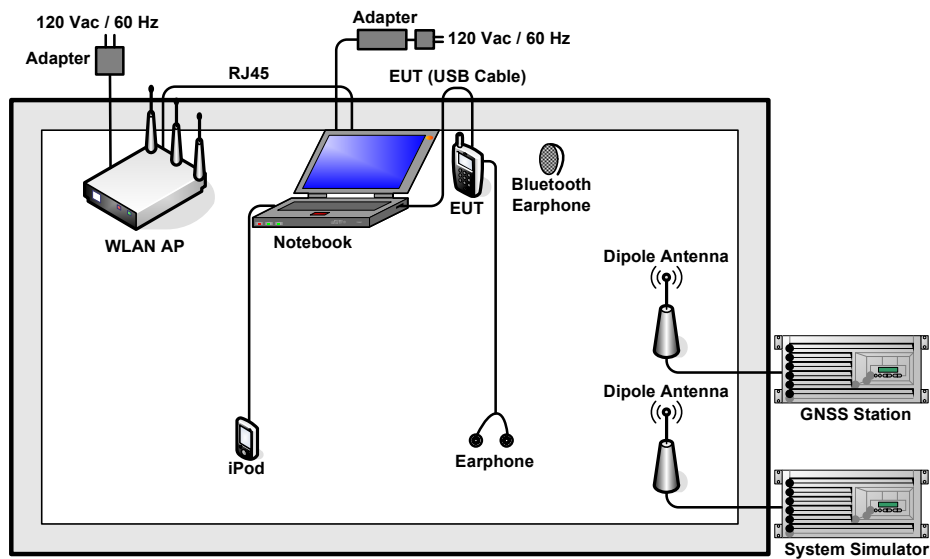

<Fig. 2>

2.3. Support Unit used in test configuration and system

Item	Equipment	Trade Name	Model Name	FCC ID	Data Cable	Power Cord
1.	System Simulator	Anritsu	MT8820C	N/A	N/A	Unshielded,1.8m
2.	GNSS Station	RACELOGIC	18645	N/A	N/A	Unshielded,1.8m
3.	WLAN AP	D-Link	DIR-820L	KA2IR820LA1	N/A	Unshielded,1.8m
4.	WLAN AP	ASUS	RT-AC66U	MSQ-RTAC66U	N/A	Unshielded,1.8m
5.	Bluetooth Earphone	Samsung	EO-MG900	PYAHS-107W	N/A	N/A
6.	Notebook	Lenovo	E540	FCC DoC	N/A	AC I/P: Unshielded, 1.2 m DC O/P: Shielded, 1.8 m
7.	SD Card	Kingston	MicroSD HC	FCC DoC	N/A	N/A
8.	SD Card	Kingston	SDC4/16GB 122	FCC DoC	N/A	N/A
9.	iPod nano 8GB	Apple	MC690ZP/A	FCC DoC	Shielded, 1.2m	N/A
10.	iPod	Apple	MC525 ZP/A	DoC	Shielded, 1.0m	N/A
11.	Earphone	Apple	MC690ZP/A	N/A	Unshielded,1.6m	N/A

2.4. EUT Operation Test Setup

The EUT was in WCDMA or LTE idle mode during the testing. The EUT was synchronized to the BCCH, and is in continuous receiving mode by setting system simulator's paging reorganization.

At the same time, the EUT was attached to the Bluetooth earphone, and the following programs installed in the EUT were programmed during the test.

1. Data application is transferred between Notebook and EUT via USB cable.
2. Execute "GPS Test" to make the EUT receive continuous signals from GNSS station.
3. Execute "Video player" to play MPEG4 files.
4. Turn on camera to capture images.
5. Play Music from SD Card.

3. Test Result

3.1. Test of AC Conducted Emission Measurement

3.1.1 Limits of AC Conducted Emission

For equipment that is designed to be connected to the public utility (AC) power line, the radio frequency voltage that is conducted back onto the AC power line on any frequency or frequencies within the band 150 kHz to 30 MHz shall not exceed the limits in the following table.

Frequency of emission (MHz)	Conducted limit (dBuV)	
	Quasi-peak	Average
0.15-0.5	66 to 56*	56 to 46*
0.5-5	56	46
5-30	60	50

*Decreases with the logarithm of the frequency.

3.1.2 Measuring Instruments

The measuring equipment is listed in the section 4 of this test report.

3.1.3 Test Procedure

1. The EUT was placed 0.4 meter from the conducting wall of the shielding room was kept at least 80 centimeters from any other grounded conducting surface.
2. Connect EUT to the power mains through a line impedance stabilization network (LISN).
3. All the support units are connecting to the other LISN.
4. The LISN provides 50 ohm coupling impedance for the measuring instrument.
5. The FCC states that a 50 ohm, 50 microhenry LISN should be used.
6. Both sides of AC line were checked for maximum conducted interference.
7. The frequency range from 150 kHz to 30 MHz was searched.
8. Set the test-receiver system to Peak Detect Function and specified bandwidth (IF Bandwidth = 9kHz) with Maximum Hold Mode. Then measurement is also conducted by Average Detector and Quasi-Peak Detector Function respectively.

3.1.4 Test Setup

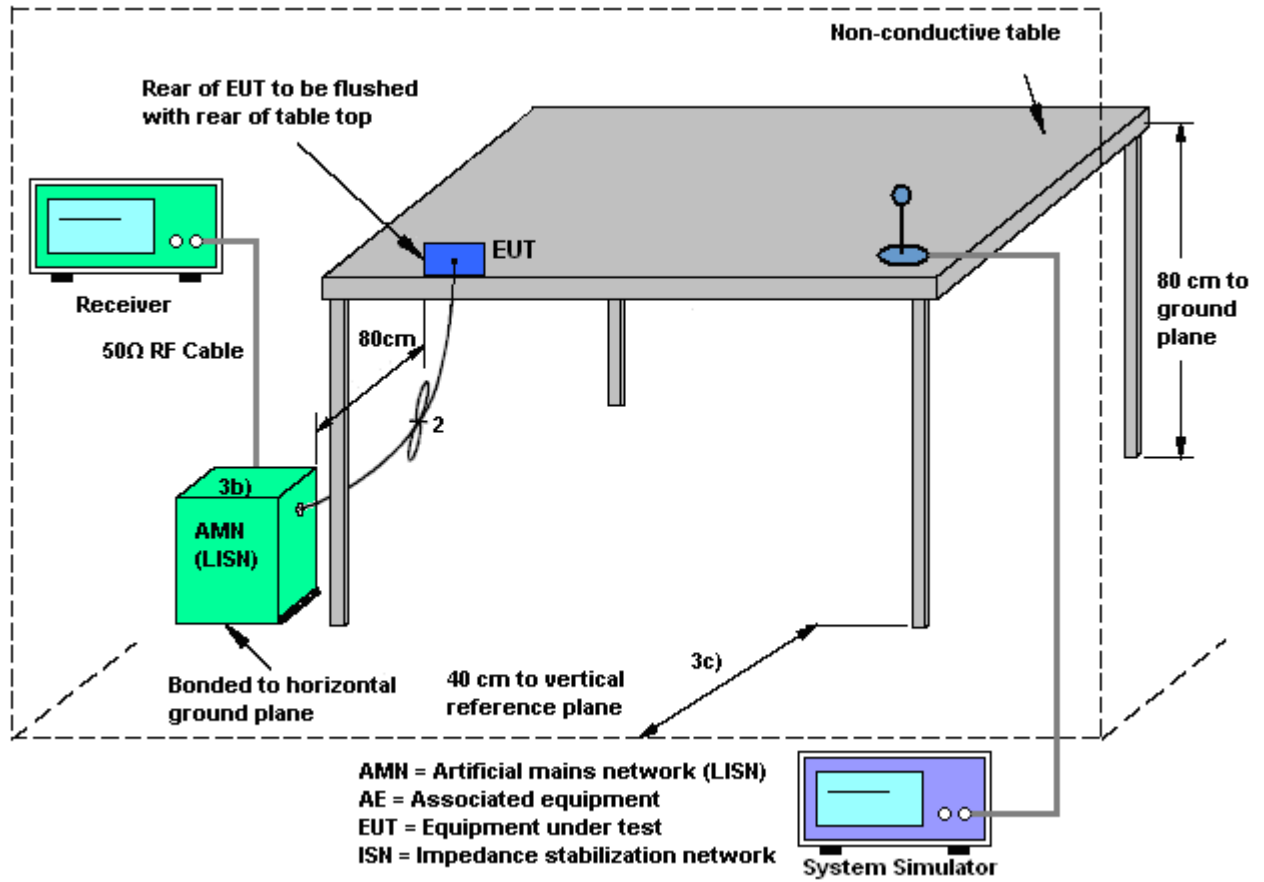



3.1.5 Test Result of AC Conducted Emission

Test Mode :	Mode 1	Temperature :	22~25°C
Test Engineer :	Peng Wang	Relative Humidity :	50~55%
Test Voltage :	120Vac / 60Hz	Phase :	Line
Function Type :	WCDMA Band V Idle + Bluetooth Idle + Earphone + Camera(Rear) + USB Cable (Charging from Adapter) + SD Card		

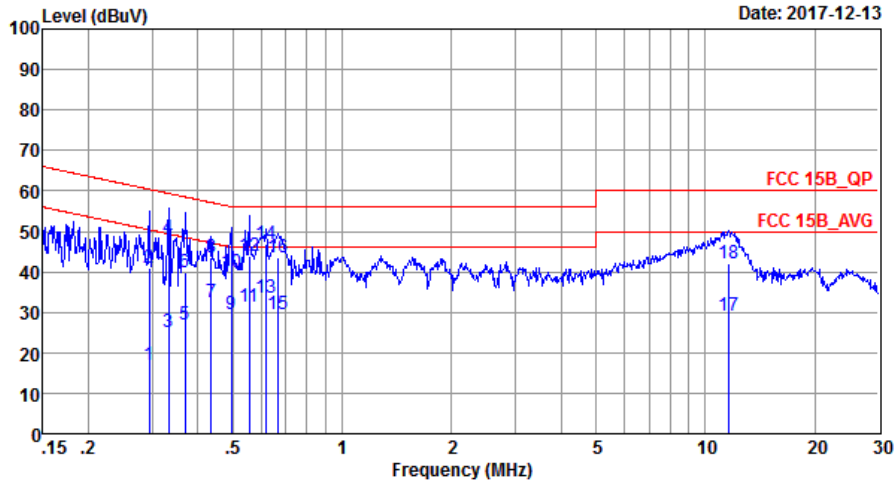

Site : CO01-SZ
Condition: FCC 15B_QP LISN_20170907_L LINE

Mode : Mode 1
IMEI : 867075030003739

	Freq	Level	Over	Limit	Read	LISN	Cable	
	MHz	dBuV	Limit	Line	Level	Factor	Loss	Remark
			dB	dBuV	dBuV	dB	dB	
1	0.29	16.81	-33.60	50.41	6.70	0.03	10.08	Average
2	0.29	40.91	-19.50	60.41	30.80	0.03	10.08	QP
3	0.33	25.01	-24.39	49.40	14.90	0.03	10.08	Average
4	0.33	48.51	-10.89	59.40	38.40	0.03	10.08	QP
5	0.37	27.11	-21.41	48.52	17.00	0.03	10.08	Average
6	0.37	39.91	-18.61	58.52	29.80	0.03	10.08	QP
7	0.44	32.51	-14.64	47.15	22.40	0.03	10.08	Average
8	0.44	43.41	-13.74	57.15	33.30	0.03	10.08	QP
9	0.49	29.60	-16.50	46.10	19.50	0.02	10.08	Average
10	0.49	39.90	-16.20	56.10	29.80	0.02	10.08	QP
11	0.56	31.50	-14.50	46.00	21.40	0.02	10.08	Average
12	0.56	43.90	-12.10	56.00	33.80	0.02	10.08	QP
13	0.62	33.60	-12.40	46.00	23.50	0.02	10.08	Average
14 *	0.62	46.70	-9.30	56.00	36.60	0.02	10.08	QP
15	0.67	29.70	-16.30	46.00	19.60	0.02	10.08	Average
16	0.67	43.40	-12.60	56.00	33.30	0.02	10.08	QP
17	11.62	28.98	-21.02	50.00	18.21	0.41	10.36	Average
18	11.62	42.18	-17.82	60.00	31.41	0.41	10.36	QP



Test Mode :	Mode 1	Temperature :	22~25°C
Test Engineer :	Peng Wang	Relative Humidity :	50~55%
Test Voltage :	120Vac / 60Hz	Phase :	Neutral
Function Type :	WCDMA Band V Idle + Bluetooth Idle + Earphone + Camera(Rear) + USB Cable (Charging from Adapter) + SD Card		

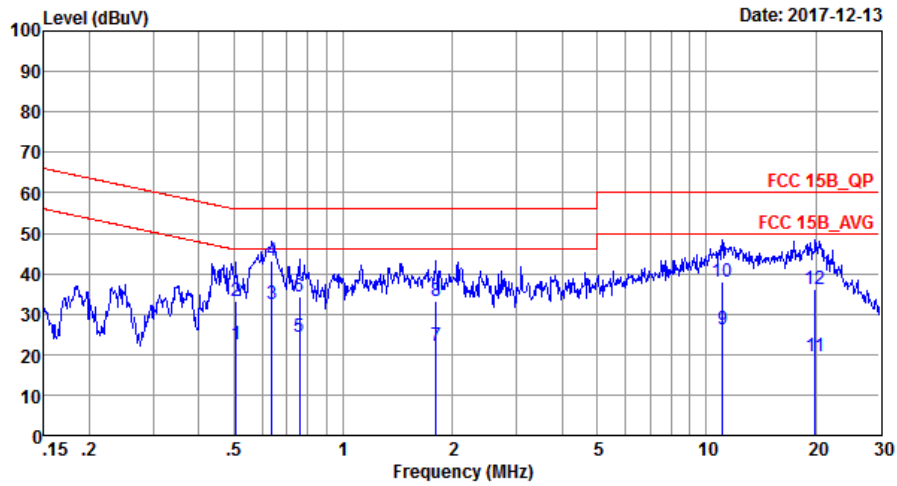

Site : C001-SZ
Condition: FCC 15B_QP LISN_20170907_N NEUTRAL

Mode : Mode 1
IMEI : 867075030003739

	Freq	Level	Over Limit	Limit Line	Read Level	LISN Factor	Cable Loss	Remark
	MHz	dBuV	dB	dBuV	dBuV	dB	dB	
1	0.51	22.60	-23.40	46.00	12.50	0.02	10.08	Average
2	0.51	33.20	-22.80	56.00	23.10	0.02	10.08	QP
3	0.64	32.30	-13.70	46.00	22.20	0.02	10.08	Average
4 *	0.64	43.20	-12.80	56.00	33.10	0.02	10.08	QP
5	0.76	24.51	-21.49	46.00	14.40	0.03	10.08	Average
6	0.76	34.31	-21.69	56.00	24.20	0.03	10.08	QP
7	1.80	21.96	-24.04	46.00	11.80	0.05	10.11	Average
8	1.80	33.26	-22.74	56.00	23.10	0.05	10.11	QP
9	11.08	26.26	-23.74	50.00	15.70	0.20	10.36	Average
10	11.08	38.16	-21.84	60.00	27.60	0.20	10.36	QP
11	19.95	19.63	-30.37	50.00	8.70	0.58	10.35	Average
12	19.95	36.23	-23.77	60.00	25.30	0.58	10.35	QP



Test Mode :	Mode 4	Temperature :	22~25°C
Test Engineer :	Peng Wang	Relative Humidity :	50~55%
Test Voltage :	120Vac / 60Hz	Phase :	Line
Function Type :	LTE Band 4 Idle + Bluetooth Idle + Earphone + GPS RX + USB Cable (Data Link with Notebook) + SD Card		

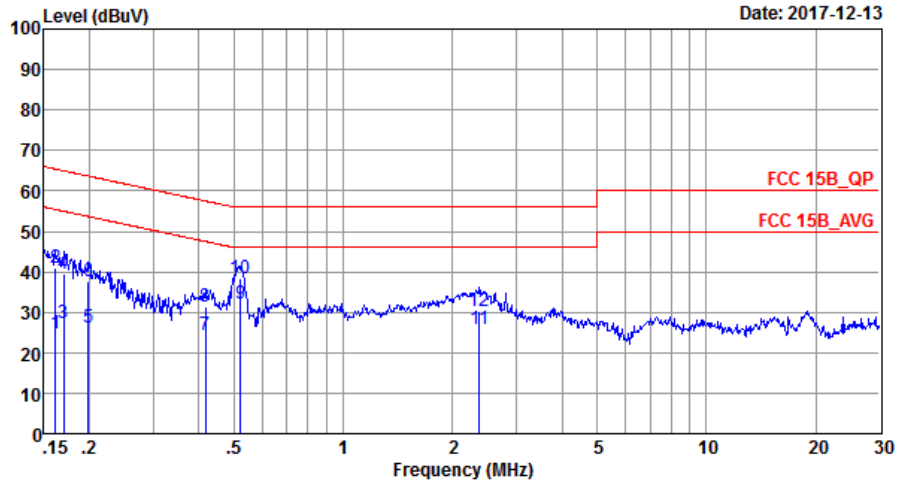

Site : CO01-SZ
 Condition: FCC 15B_QP LISN_20170907_L LINE
 Project : 7N2807

IMEI : 867075030003739

	Freq	Level	Over Limit	Limit Line	Read Level	LISN Factor	Cable Loss	Remark
	MHz	dBuV	dB	dBuV	dBuV	dB	dB	
1	0.16	24.59	-30.79	55.38	14.50	0.03	10.06	Average
2	0.16	40.99	-24.39	65.38	30.90	0.03	10.06	QP
3	0.17	27.19	-27.75	54.94	17.09	0.03	10.07	Average
4	0.17	39.49	-25.45	64.94	29.39	0.03	10.07	QP
5	0.20	26.20	-27.47	53.67	16.10	0.03	10.07	Average
6	0.20	37.50	-26.17	63.67	27.40	0.03	10.07	QP
7	0.42	24.31	-23.20	47.51	14.20	0.03	10.08	Average
8	0.42	31.21	-26.30	57.51	21.10	0.03	10.08	QP
9 *	0.52	32.00	-14.00	46.00	21.90	0.02	10.08	Average
10	0.52	38.50	-17.50	56.00	28.40	0.02	10.08	QP
11	2.37	25.95	-20.05	46.00	15.70	0.13	10.12	Average
12	2.37	30.35	-25.65	56.00	20.10	0.13	10.12	QP



Test Mode :	Mode 4	Temperature :	22~25°C
Test Engineer :	Peng Wang	Relative Humidity :	50~55%
Test Voltage :	120Vac / 60Hz	Phase :	Neutral
Function Type :	LTE Band 4 Idle + Bluetooth Idle + Earphone + GPS RX + USB Cable (Data Link with Notebook) + SD Card		

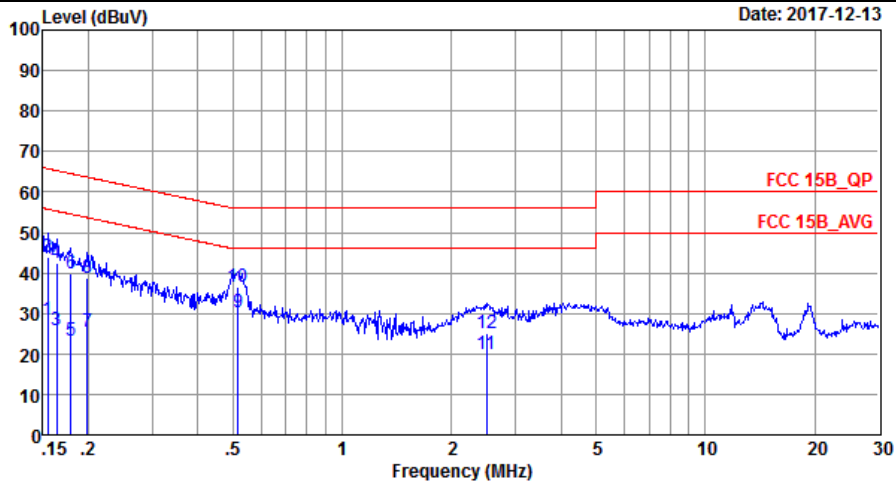

Site : C001-SZ
 Condition: FCC 15B QP LISN_20170907_N NEUTRAL

Mode : Mode 4
 IMEI : 867075030003739

	Freq	Level	Over Limit	Limit Line	Read Level	LISN Factor	Cable Loss	Remark
	MHz	dBuV	dB	dBuV	dBuV	dB	dB	
1	0.15	28.39	-27.36	55.75	18.30	0.03	10.06	Average
2	0.15	43.99	-21.76	65.75	33.90	0.03	10.06	QP
3	0.16	25.79	-29.51	55.30	15.70	0.03	10.06	Average
4	0.16	42.39	-22.91	65.30	32.30	0.03	10.06	QP
5	0.18	23.10	-31.45	54.55	13.00	0.03	10.07	Average
6	0.18	39.80	-24.75	64.55	29.70	0.03	10.07	QP
7	0.20	25.60	-28.07	53.67	15.50	0.03	10.07	Average
8	0.20	38.60	-25.07	63.67	28.50	0.03	10.07	QP
9 *	0.52	30.10	-15.90	46.00	20.00	0.02	10.08	Average
10	0.52	36.40	-19.60	56.00	26.30	0.02	10.08	QP
11	2.50	20.06	-25.94	46.00	9.89	0.04	10.13	Average
12	2.50	24.96	-31.04	56.00	14.79	0.04	10.13	QP



3.2. Test of Radiated Emission Measurement

3.2.1. Limit of Radiated Emission

The emissions from an unintentional radiator shall not exceed the field strength levels specified in the following table:

Frequency (MHz)	Field Strength (microvolts/meter)	Measurement Distance (meters)
30 – 88	100	3
88 – 216	150	3
216 - 960	200	3
Above 960	500	3

3.2.2. Measuring Instruments

The measuring equipment is listed in the section 4 of this test report.



3.2.3. Test Procedures

1. The EUT was placed on a turntable with 0.8 meter above ground.
2. The EUT was set 3 meters from the interference receiving antenna, which was mounted on the top of a variable height antenna tower.
3. The table was rotated 360 degrees to determine the position of the highest radiation.
4. The antenna is a Bi-Log antenna and its height is adjusted between one to four meters above ground to find the maximum value of the field strength for both horizontal polarization and vertical polarization of the antenna.
5. For each suspected emission, the EUT was arranged to its worst case and then tune the antenna tower (from 1 m to 4 m) and turntable (from 0 degree to 360 degrees) to find the maximum reading.
6. Set the test-receiver system to Peak Detect Function and specified bandwidth with Maximum Hold Mode (RBW=120kHz/VBW=300kHz for frequency below 1GHz; RBW=1MHz VBW=3MHz (Peak), RBW=1MHz/VBW=10Hz (Average) for frequency above 1GHz).
7. If the emission level of the EUT in peak mode was 3 dB lower than the limit specified, peak values of EUT will be reported. Otherwise, the emission will be repeated by using the quasi-peak method and reported.
8. Emission level (dB μ V/m) = 20 log Emission level (μ V/m)
9. Corrected Reading: Antenna Factor + Cable Loss + Read Level - Preamp Factor = Level

3.2.4. Test Setup of Radiated Emission

For radiated emissions from 30MHz to 1GHz

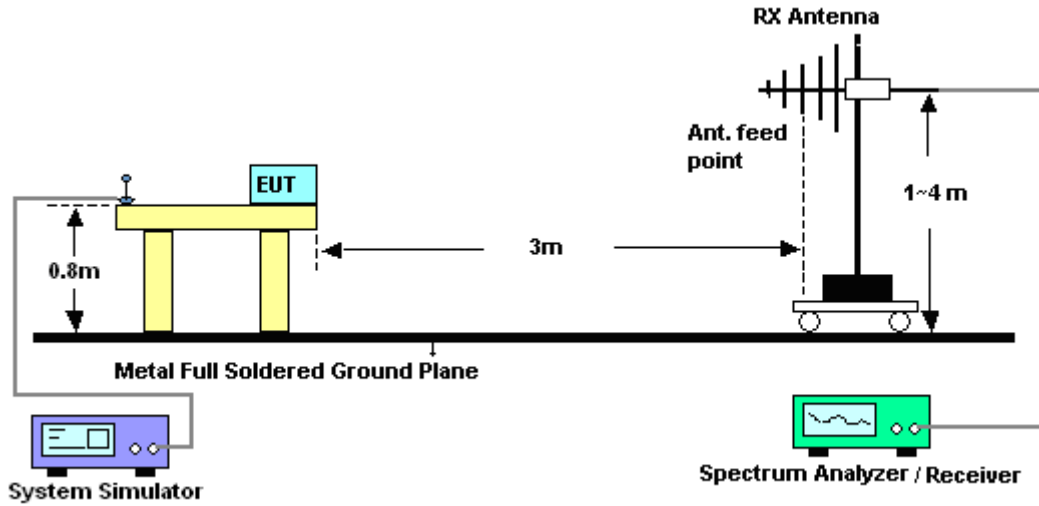

For radiated emissions above 1GHz

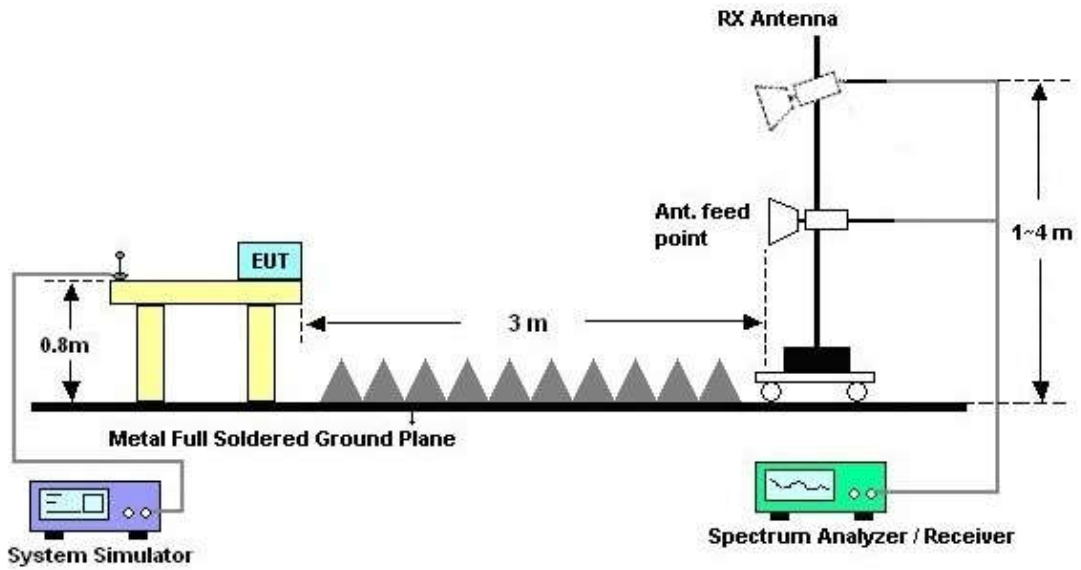



3.2.5. Test Result of Radiated Emission

Test Mode :	Mode 4	Temperature :	24~25°C
Test Engineer :	Clear Peng	Relative Humidity :	48~49%
Test Distance :	3m	Polarization :	Horizontal
Function Type :	LTE Band 4 Idle + Bluetooth Idle + Earphone + GPS RX + USB Cable (Data Link with Notebook) + SD Card + Battery		
Remark :	#7 is system simulator signal which can be ignored.		

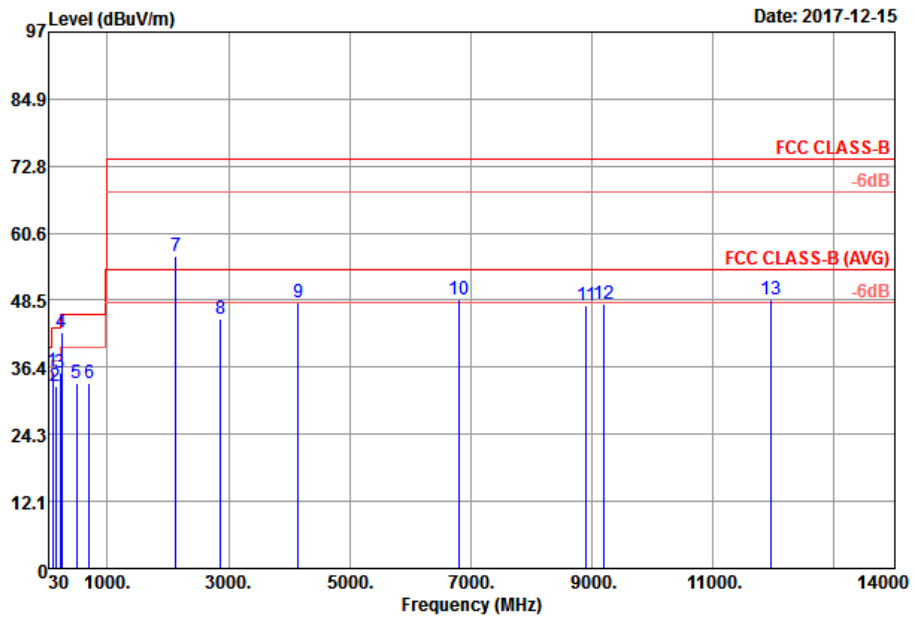

Site : 03CH01-SZ
 Condition : FCC CLASS-B 3m HF_ANT(3117)_119436 HORIZONTAL

Mode : Mode 4
 IMEI : 867075030006807/01

	Freq	Level	Over Limit	Limit Line	ReadAntenna Level	Cable Factor	Preamp Loss	A/Pos	T/Pos	Remark
	MHz	dBuV/m	dB	dBuV/m	dBuV	dB/m	dB	cm	deg	
1	99.84	35.59	-7.91	43.50	47.64	18.60	0.85	31.50	---	Peak
2	150.28	32.85	-10.65	43.50	44.85	18.10	1.30	31.40	---	Peak
3	218.18	35.48	-10.52	46.00	46.28	18.62	1.71	31.13	---	Peak
4	250.19	42.63	-3.37	46.00	51.37	20.40	1.86	31.00	100	Peak
5	497.54	33.54	-12.46	46.00	37.31	24.63	2.70	31.10	---	Peak
6	697.36	33.54	-12.46	46.00	33.80	27.68	3.26	31.20	---	Peak
7	2132.00	56.43			76.83	31.47	6.29	58.16	---	Peak
8	2864.00	45.05	-28.95	74.00	62.21	32.23	8.05	57.44	---	Peak
9	4152.00	47.97	-26.03	74.00	63.51	33.49	10.31	59.34	---	Peak
10	6798.00	48.61	-25.39	74.00	56.34	34.97	15.85	58.55	---	Peak
11	8910.00	47.53	-26.47	74.00	53.51	36.10	12.81	54.89	---	Peak
12	9188.00	47.96	-26.04	74.00	53.61	36.28	13.04	54.97	---	Peak
13	11946.00	48.75	-25.25	74.00	50.02	38.42	14.99	54.68	100	Peak



Test Mode :	Mode 4	Temperature :	24~25°C
Test Engineer :	Clear Peng	Relative Humidity :	48~49%
Test Distance :	3m	Polarization :	Vertical
Function Type :	LTE Band 4 Idle + Bluetooth Idle + Earphone + GPS RX + USB Cable (Data Link with Notebook) + SD Card + Battery		
Remark :	#7 is system simulator signal which can be ignored.		

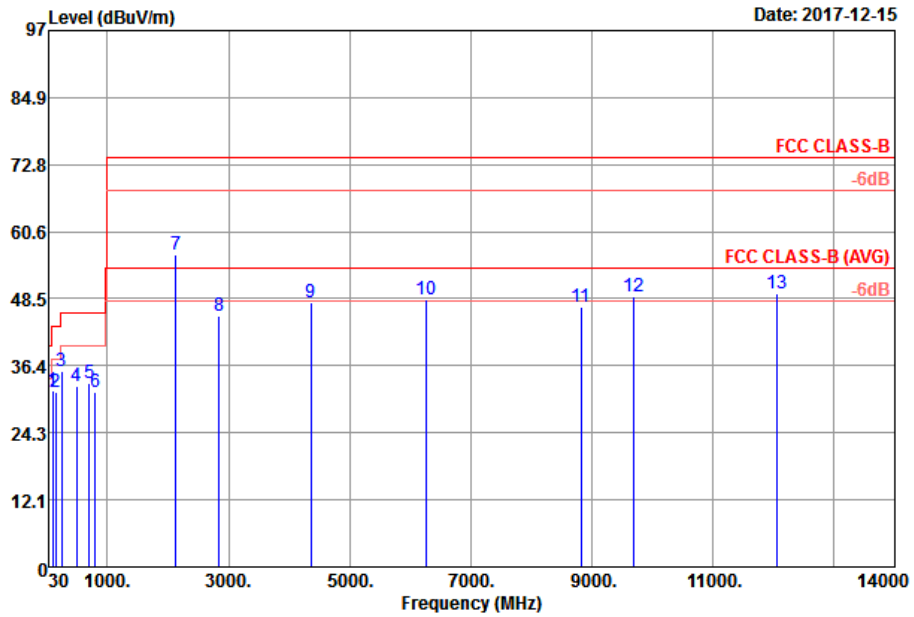

Site : 03CH01-SZ
 Condition : FCC CLASS-B 3m HF_ANT(3117)_119436 VERTICAL
 Mode : Mode 4
 IMEI : 867075030006807/01

	Freq	Level	Over	Limit	ReadAntenna	Cable	Preamp	A/Pos	T/Pos	Remark	
	MHz	dBuV/m	dB	dBuV/m	dBuV	dB/m	dB	dB	cm	deg	
1	99.84	31.81	-11.69	43.50	43.86	18.60	0.85	31.50	---	---	Peak
2	150.28	31.65	-11.85	43.50	43.65	18.10	1.30	31.40	---	---	Peak
3	250.19	35.34	-10.66	46.00	44.08	20.40	1.86	31.00	100	0	Peak
4	497.54	32.61	-13.39	46.00	36.38	24.63	2.70	31.10	---	---	Peak
5	699.30	33.30	-12.70	46.00	33.54	27.69	3.27	31.20	---	---	Peak
6	800.18	31.51	-14.49	46.00	32.80	26.40	3.61	31.30	---	---	Peak
7	2132.00	56.56			76.96	31.47	6.29	58.16	---	---	Peak
8	2850.00	45.46	-28.54	74.00	62.97	32.17	7.77	57.45	---	---	Peak
9	4358.00	47.82	-26.18	74.00	62.61	33.73	10.45	58.97	---	---	Peak
10	6270.00	48.34	-25.66	74.00	57.00	34.69	14.31	57.66	---	---	Peak
11	8822.00	47.08	-26.92	74.00	53.26	36.02	12.77	54.97	---	---	Peak
12	9700.00	49.03	-24.97	74.00	54.51	36.57	13.39	55.44	---	---	Peak
13	12060.00	49.52	-24.48	74.00	50.84	38.51	15.01	54.84	100	0	Peak



4. List of Measuring Equipment

Instrument	Manufacturer	Model No.	Serial No.	Characteristics	Calibration Date	Test Date	Due Date	Remark
EMI Receiver	R&S	ESR7	101630	9kHz~7GHz;	Jan. 06, 2017	Dec. 13, 2017	Jan. 05, 2018	Conduction (CO01-SZ)
AC LISN	EMCO	3816/2SH	00103912	9kHz~30MHz	Jan. 05, 2017	Dec. 13, 2017	Jan. 04, 2018	Conduction (CO01-SZ)
AC LISN (for auxiliary equipment)	MessTec	3816/2SH	00103892	9kHz~30MHz	Jan. 05, 2017	Dec. 13, 2017	Jan. 04, 2018	Conduction (CO01-SZ)
AC Power Source	Chroma	61601	616010001985	N/A	NCR	Dec. 13, 2017	NCR	Conduction (CO01-SZ)
EMI Test Receiver&SA	Agilent	N9038A	MY52260185	20Hz~26.5GHz	Apr. 20, 2017	Dec. 15, 2017	Apr. 19, 2018	Radiation (03CH01-SZ)
EXA Spectrum Analyzer	KEYSIGHT	N9010A	MY55150213	10Hz~44GHz	Apr. 20, 2017	Dec. 15, 2017	Apr. 19, 2018	Radiation (03CH01-SZ)
Bilog Antenna	TeseQ	CBL6112D	23188	30MHz-2GHz	Apr. 25, 2017	Dec. 15, 2017	Apr. 24, 2018	Radiation (03CH01-SZ)
Double Ridge Horn Antenna	ETS Lindgren	3117	119436	1GHz~18GHz	Jul. 28, 2017	Dec. 15, 2017	Jul. 27, 2018	Radiation (03CH01-SZ)
Amplifier	Burgeon	BPA-530	102209	0.01~3000Mhz	Apr. 20, 2017	Dec. 15, 2017	Apr. 19, 2018	Radiation (03CH01-SZ)
HF Amplifier	MITEQ	AMF-7D-0010 1800-30-10P-R	1989346	1GHz~18GHz	Jul. 27, 2017	Dec. 15, 2017	Jul. 26, 2018	Radiation (03CH01-SZ)
AC Power Source	Chroma	61601	N/A	N/A	NCR	Dec. 15, 2017	NCR	Radiation (03CH01-SZ)
Turn Table	EM	EM1000	N/A	0~360 degree	NCR	Dec. 15, 2017	NCR	Radiation (03CH01-SZ)
Antenna Mast	EM	EM1000	N/A	1 m~4 m	NCR	Dec. 15, 2017	NCR	Radiation (03CH01-SZ)

NCR: No Calibration Required



5. Uncertainty of Evaluation

Uncertainty of Conducted Emission Measurement (150 kHz ~ 30 MHz)

Measuring Uncertainty for a Level of Confidence of 95% ($U = 2Uc(y)$)	2.5dB
---	-------

Uncertainty of Radiated Emission Measurement (30 MHz ~ 1000 MHz)

Measuring Uncertainty for a Level of Confidence of 95% ($U = 2Uc(y)$)	5.1dB
---	-------

Uncertainty of Radiated Emission Measurement (1000 MHz ~ 18000 MHz)

Measuring Uncertainty for a Level of Confidence of 95% ($U = 2Uc(y)$)	5.2dB
---	-------