



# EMC TEST REPORT

**Applicant** ZTE Corporation  
**FCC ID** SRQ-T3000  
**Product** WiFi6 Router  
**Model** T3000  
**Report No.** R2201A0022-E1  
**Issue Date** March 14, 2022

TA Technology (Shanghai) Co., Ltd. tested the above equipment in accordance with the requirements in **FCC Code CFR47 Part15B (2021)/ ANSI C63.4 (2014)**. The test results show that the equipment tested is capable of demonstrating compliance with the requirements as documented in this report.

*Wei Liu*

Prepared by: Wei Liu

*Guangchang Fan*

Approved by: Guangchang Fan

---

**TA Technology (Shanghai) Co., Ltd.**

No.145, Jintang Rd, Tangzhen Industry Park, Pudong Shanghai, China

TEL: +86-021-50791141/2/3

FAX: +86-021-50791141/2/3-8000



## Table of Contents

1	Test Laboratory.....	4
1.1	Notes of the Test Report.....	4
1.2	Test facility.....	4
1.3	Testing Location.....	4
2	General Description of Equipment under Test.....	5
2.1	Applicant and Manufacturer Information.....	5
2.2	General information.....	5
2.3	Applied Standards.....	6
2.4	Test Mode.....	7
3	Test Case Results.....	8
3.1	Radiated Emission.....	8
3.2	Conducted Emission.....	13
4	Main Test Instruments.....	17
	ANNEX A: The EUT Appearance.....	18
	ANNEX B: Test Setup Photos.....	19



### Summary of measurement results

Number	Test Case	Clause in FCC Rules	Conclusion
1	Radiated Emission	FCC Part15.109, ANSI C63.4-2014	PASS
2	Conducted Emission	FCC Part15.107, ANSI C63.4-2014	PASS
Date of Testing: January 12, 2022~ March 1, 2022			
Date of Sample Received: January 6, 2022			
Note: All indications of Pass/Fail in this report are opinions expressed by TA Technology (Shanghai) Co., Ltd. based on interpretations and/or observations of test results. Measurement Uncertainties were not taken into account and are published for informational purposes only.			

## 1 Test Laboratory

### 1.1 Notes of the Test Report

This report shall not be reproduced in full or partial, without the written approval of **TA technology (shanghai) co., Ltd.** The results documented in this report apply only to the tested sample, under the conditions and modes of operation as described herein. Measurement Uncertainties were not taken into account and are published for informational purposes only. This report is written to support regulatory compliance of the applicable standards stated above.

### 1.2 Test facility

#### **FCC (Designation number: CN1179, Test Firm Registration Number: 446626)**

TA Technology (Shanghai) Co., Ltd. has been listed on the US Federal Communications Commission list of test facilities recognized to perform measurements.

#### **A2LA (Certificate Number: 3857.01)**

TA Technology (Shanghai) Co., Ltd. has been listed by American Association for Laboratory Accreditation to perform measurement.

### 1.3 Testing Location

Company: TA Technology (Shanghai) Co., Ltd.  
Address: No.145, Jintang Rd, Tangzhen Industry Park, Pudong Shanghai, China  
City: Shanghai  
Post code: 201201  
Country: P. R. China  
Contact: Fan Guangchang  
Telephone: +86-021-50791141/2/3  
Fax: +86-021-50791141/2/3-8000  
Website: <http://www.ta-shanghai.com>  
E-mail: [fanguangchang@ta-shanghai.com](mailto:fanguangchang@ta-shanghai.com)

## 2 General Description of Equipment under Test

### 2.1 Applicant and Manufacturer Information

<b>Applicant</b>	ZTE Corporation
<b>Applicant address</b>	ZTE Plaza, Keji Road South, Hi-Tech, Industrial Park, Nanshan District, Shenzhen, Guangdong, 518057, P.R.China
<b>Manufacturer</b>	ZTE Corporation
<b>Manufacturer address</b>	ZTE Plaza, Keji Road South, Hi-Tech, Industrial Park, Nanshan District, Shenzhen, Guangdong, 518057, P.R.China

### 2.2 General information

EUT Description			
Device Type	Movable Device		
Model	T3000		
SN	324215830119		
HW Version	T3000GHW1.0		
SW Version	T3000GV0.0.0B01		
Power Rating	DC 12V from Adapter.		
Connecting I/O Port(s)	Please refer to the User's Manual.		
Antenna Type	PCB Antenna		
Frequency	Band	Tx (MHz)	Rx (MHz)
	Wi-Fi 2.4G	2400 ~ 2483.5	2400 ~ 2483.5
	Wi-Fi 5G(U-NII-1)	5150 ~ 5250	5150 ~ 5250
	Wi-Fi 5G(U-NII-3)	5725 ~ 5850	5725 ~ 5850
EUT Accessory			
Adapter 1	Manufacturer: BAIJUNDA Model: STC-A1215C55A-Z Input: 100-240V~50/60Hz 0.5A Output: 12.0V $\overline{\text{---}}$ 1.5A		
Adapter 2	Manufacturer: RUIJING Model: STC-A1215C55A-Z Input: 100-240V~50/60Hz 0.5A Output: 12.0V $\overline{\text{---}}$ 1.5A		
Auxiliary test equipment			
PC	PC Manufacturer: Dell Model: E5430 (SN : R98M9 A02)		
Note: 1. The EUT is sent from the applicant to TA and the information of the EUT is declared by the applicant. 2. There are more than one Adapter, each one should be applied throughout the compliance test respectively, however, only the worst case (Adapter 2,) will be recorded in this report.			



## 2.3 Applied Standards

According to the specifications of the manufacturer, it must comply with the requirements of the following standards:

### Test standards

**FCC Code CFR47 Part15B (2021)**

**ANSI C63.4 (2014)**

## 2.4 Test Mode

Test Mode	
Mode 1	Adapter + EUT + LAN/WAN Port + WLAN Receiver
Mode 2	Adapter + EUT + LAN/WAN Port + WLAN Traffic

During the test, the preliminary test was performed in all modes with all adapters; an adapter 2 is selected as the worst condition. The test data of the worst-case condition was recorded in this report.

### 3 Test Case Results

#### 3.1 Radiated Emission

##### Ambient condition

Temperature	Relative humidity	Pressure
15°C~35°C	30%~60%	101.5kPa

##### Methods of Measurement

The EUT is placed on a non-metallic table 0.8m above the horizontal metal reference ground plane. The distance between EUT and receive antenna should be 3 meters. During the test, the EUT was operating in its typical mode. The test method is according to ANSI C63.4-2014. Sweep the whole frequency band through the range from 30MHz to the 5th harmonic of the carrier. During the test, the height of receive antenna shall be moved from 1 to 4 meters, and the antenna shall be performed under horizontal and vertical polarization. The turn table shall be rotated from 0 to 360 degrees for detecting the maximum of radiated signal level.

The data of cable loss and antenna factor has been calibrated in full testing frequency range before the testing. During the test, the EUT is worked at maximum output power.

Set the spectrum analyzer in the following:

Below 1GHz:

RBW=100 kHz / VBW=300 kHz / Sweep=AUTO

Above 1GHz:

(a) PEAK Detector: RBW=1MHz / VBW=3MHz / Sweep=AUTO

(b) AVERAGE Detector: RBW=1MHz / VBW=3MHz / Sweep=AUTO

The radiated emission was measured in the following position: EUT stand-up position (Z axis), lie-down position (X, Y axis). The worst emission was found in lie-down position (X axis) and the worst case was recorded.



## Test Setup

### Below 1GHz

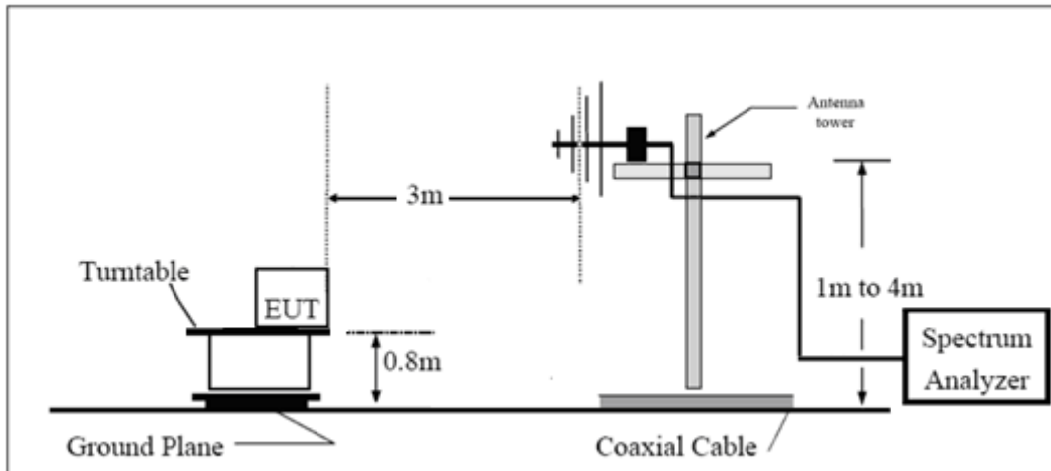

### Above 1GHz

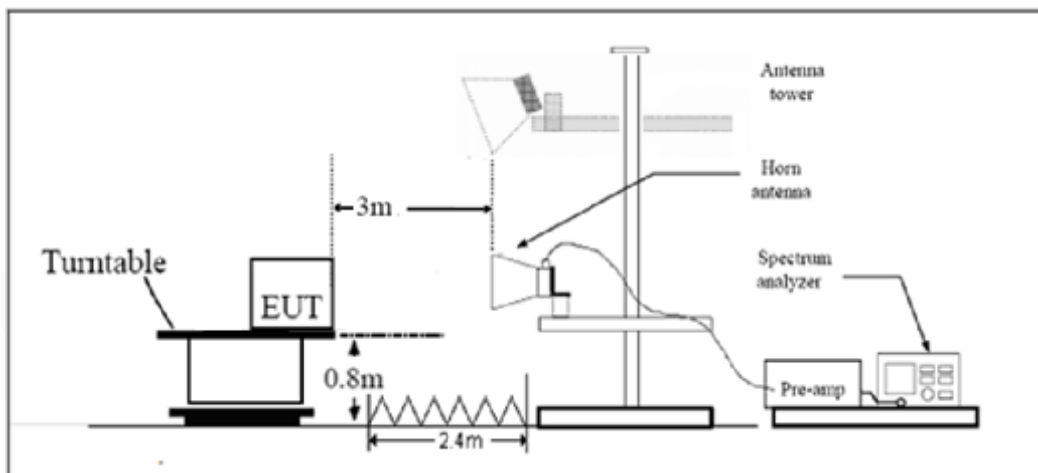

Note: Area side: 2.4mX3.6m

Antenna Tower meets ANSI C63.4 requirements for measurements above 1 GHz by keeping the antenna aimed at the EUT during the antenna's ascent/ descent along the antenna mast.

**Limits****Class B**

Frequency (MHz)	Field Strength (dB $\mu$ V/m)	Detector
30 -88	40.0	Quasi-peak
88-216	43.5	Quasi-peak
216 – 960	46.0	Quasi-peak
960-1000	54.0	Quasi-peak
1000-5 <sup>th</sup> harmonic of the highest frequency or 40GHz, which is lower	54 74	Average Peak

**Measurement Uncertainty**

The assessed measurement uncertainty to ensure 95% confidence level for the normal distribution is with the coverage factor  $k = 1.96$ .

Frequency	Uncertainty
30MHz~200MHz	4.17 dB
200MHz~1000MHz	4.84 dB
1GHz~18GHz	4.35 dB

### Test Results

Sweep the whole frequency band through the range from 30MHz to the 5th harmonic of the carrier. The Emissions in the frequency band 18GHz – 40GHz is more than 20dB below the limit are not reported.

The following graphs display the maximum values of horizontal and vertical by software. For above 1GHz, Blue trace uses the peak detection, Green trace uses the average detection.

A font (  $\text{Level in dB } \mu\text{V/m}$  ) in the test plot = (level in dB  $\mu\text{V/m}$ )

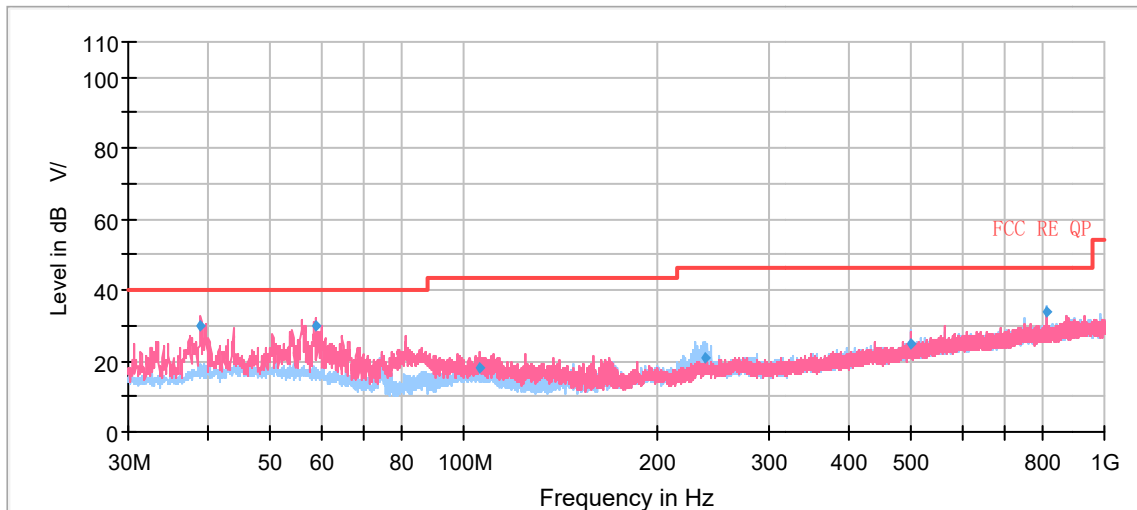

Radiated Emission from 30MHz to 1GHz

Frequency (MHz)	Quasi-Peak (dBuV/m)	Limit (dBuV/m)	Margin (dB)	Height (cm)	Polarization	Azimuth (deg)	Correct Factor (dB)
38.956333	29.66	40.00	10.34	100.0	V	105.0	19
58.712000	29.89	40.00	10.11	100.0	V	133.0	20
105.692333	17.86	43.50	25.64	100.0	V	124.0	19
238.694667	21.08	46.00	24.92	125.0	H	183.0	19
500.029667	25.03	46.00	20.97	100.0	H	22.0	25
812.523667	33.85	46.00	12.15	100.0	H	80.0	29

**Remark: 1. Correction Factor = Antenna factor + Insertion loss(cable loss+amplifier gain)**

**2. Margin = Limit – Quasi-Peak**

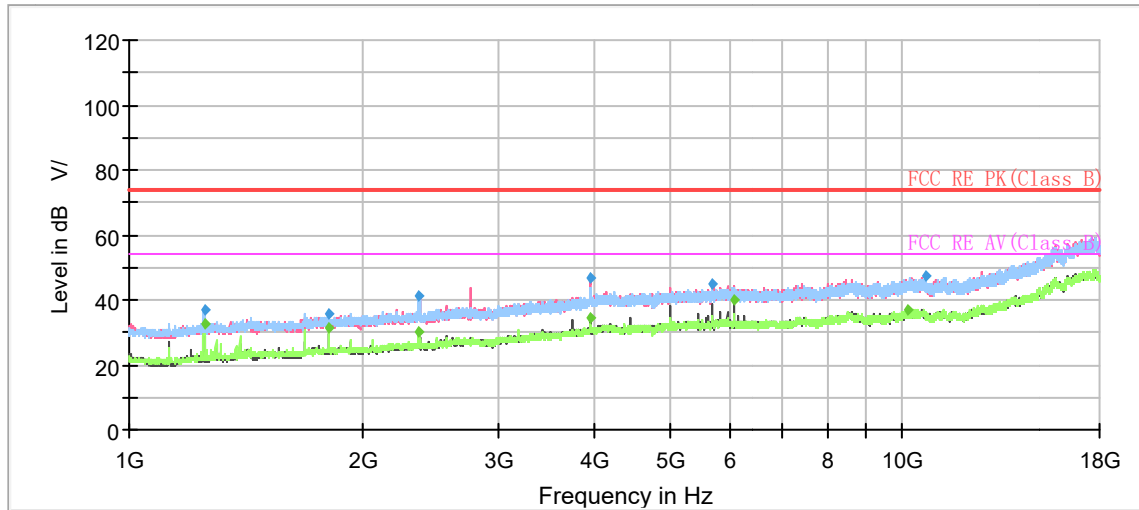

Radiated Emission from 1GHz to 18GHz

Frequency (MHz)	Peak (dBuV/m)	Average (dBuV/m)	Limit (dBuV/m)	Margin (dB)	Height (cm)	Polarization	Azimuth (deg)	Correct Factor (dB)
1249.900000	---	32.84	54.00	21.16	125.0	H	139.0	-17
1249.900000	37.04	---	74.00	36.96	100.0	H	139.0	-17
1812.600000	---	31.68	54.00	22.32	136.0	H	205.0	-14
1812.600000	35.76	---	74.00	38.24	100.0	H	205.0	-14
2371.900000	---	30.25	54.00	23.75	200.0	V	328.0	-11
2374.733333	41.45	---	74.00	32.56	200.0	V	328.0	-11
3944.400000	---	34.27	54.00	19.73	198.0	V	0.0	-4
3950.633333	47.01	---	74.00	26.99	200.0	V	0.0	-4
5688.033333	44.71	---	74.00	29.29	100.0	V	175.0	0
6062.600000	---	39.73	54.00	14.27	200.0	V	162.0	0
10150.533333	---	37.08	54.00	16.92	200.0	V	294.0	5
10715.500000	47.42	---	74.00	26.58	192.0	V	229.0	5

### 3.2 Conducted Emission

#### Ambient condition

Temperature	Relative humidity	Pressure
15°C~35°C	30%~60%	101.5kPa

#### Methods of Measurement

The EUT is placed on a non-metallic table of 80cm height above the horizontal metal reference ground plane. During the test, the EUT was operating in its typical mode. The test method is according to ANSI C63.4-2014. Connect the AC power line of the EUT to the L.I.S.N. Use EMI receiver to detect the average and Quasi-peak value. RBW is set to 9 kHz, VBW is set to 30kHz. The measurement result should include both L line and N line.

During the test, EUT is connected to a laptop via a USB cable in the case of Transfer Data mode. The EUT is used as the peripheral equipment of the PC. The data is transferred from EUT to PC; PC is connected to server via a long LAN cable.

#### Test Setup

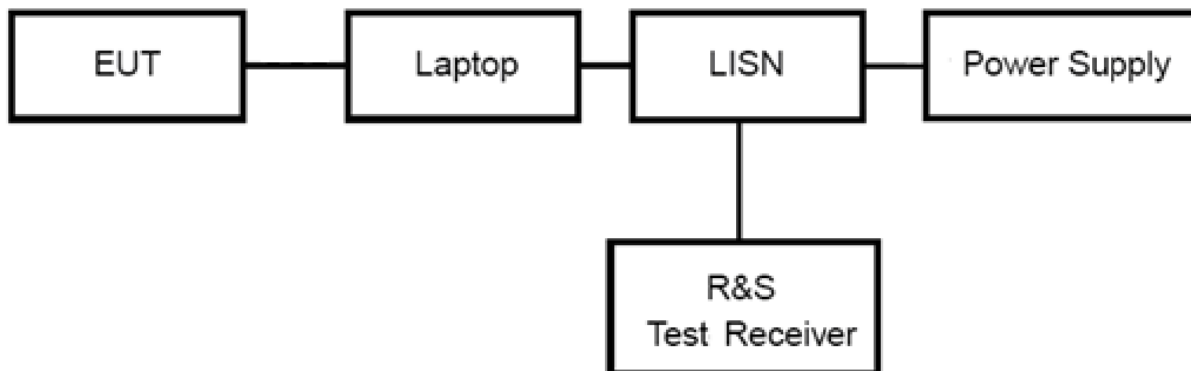

Note: Power Supply is AC Power source and it is used to change the voltage 120V/60Hz.

#### Limits

Frequency (MHz)	Conducted Limits(dBμV)	
	Quasi-peak	Average
0.15 - 0.5	66 to 56 *	56 to 46 *
0.5 - 5	56	46
5 - 30	60	50

\*: Decreases with the logarithm of the frequency.

#### Measurement Uncertainty



The assessed measurement uncertainty to ensure 95% confidence level for the normal distribution is with the coverage factor  $k = 1.96$ .  $U = 2.57$  dB.

**Test Results**

Following plots, Blue trace uses the peak detection; Green trace uses the average detection.

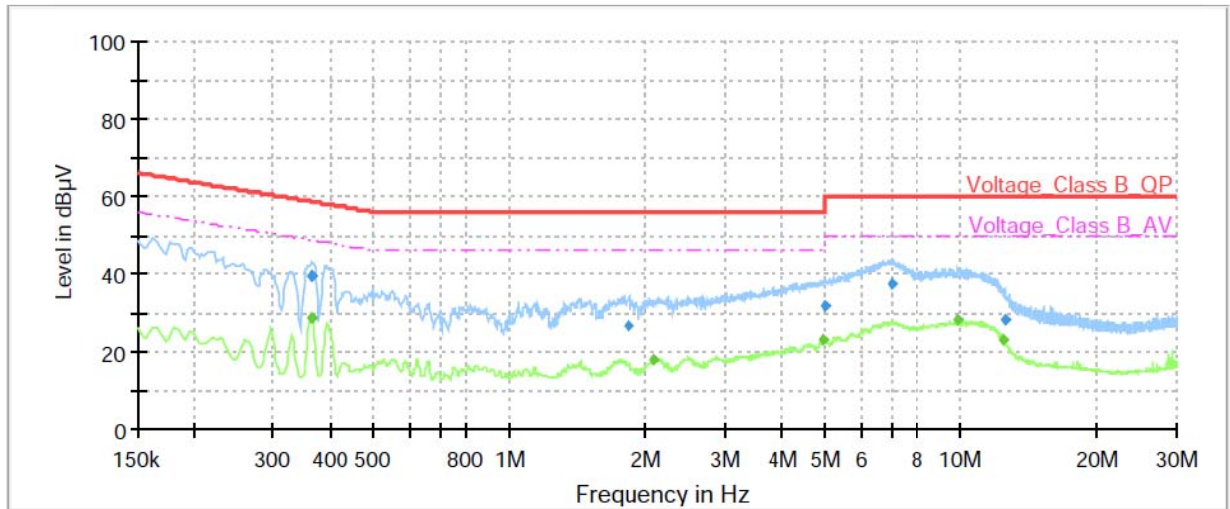

Frequency (MHz)	QuasiPeak (dBµV)	Average (dBµV)	Limit (dBµV)	Margin (dB)	Meas. Time (ms)	Bandwidth (kHz)	Line	Filter	Corr. (dB)
0.36	---	28.69	48.69	20.00	1000.00	9.000	L1	ON	21
0.36	39.27	---	58.69	19.42	1000.00	9.000	L1	ON	21
0.36	---	28.53	48.64	20.11	1000.00	9.000	L1	ON	21
0.36	39.25	---	58.64	19.39	1000.00	9.000	L1	ON	21
1.84	26.81	---	56.00	29.19	1000.00	9.000	L1	ON	20
2.09	---	18.06	46.00	27.94	1000.00	9.000	L1	ON	20
4.96	---	22.92	46.00	23.08	1000.00	9.000	L1	ON	19
5.00	31.65	---	56.00	24.35	1000.00	9.000	L1	ON	19
6.99	37.25	---	60.00	22.75	1000.00	9.000	L1	ON	20
9.81	---	27.97	50.00	22.03	1000.00	9.000	L1	ON	20
12.41	---	23.06	50.00	26.94	1000.00	9.000	L1	ON	20
12.46	28.20	---	60.00	31.80	1000.00	9.000	L1	ON	20

**Remark: Correct factor=cable loss + LISN factor**

L line

Conducted Emission from 150 KHz to 30 MHz

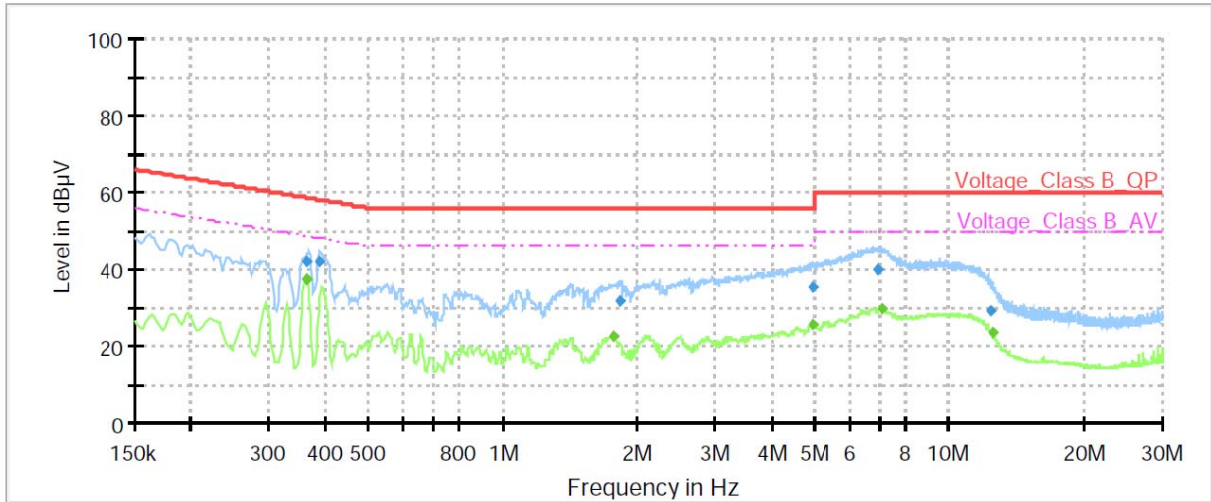

Frequency (MHz)	QuasiPeak (dBµV)	Average (dBµV)	Limit (dBµV)	Margin (dB)	Meas. Time (ms)	Bandwidth (kHz)	Line	Filter	Corr. (dB)
0.36	---	37.67	48.69	11.02	1000.00	9.000	N	ON	21
0.36	41.83	---	58.69	16.86	1000.00	9.000	N	ON	21
0.36	---	37.50	48.64	11.14	1000.00	9.000	N	ON	21
0.39	42.13	---	58.10	15.97	1000.00	9.000	N	ON	21
1.76	---	22.79	46.00	23.21	1000.00	9.000	N	ON	20
1.84	31.67	---	56.00	24.33	1000.00	9.000	N	ON	20
4.93	35.54	---	56.00	20.46	1000.00	9.000	N	ON	19
4.96	---	25.77	46.00	20.23	1000.00	9.000	N	ON	19
6.91	40.03	---	60.00	19.97	1000.00	9.000	N	ON	20
7.08	---	29.80	50.00	20.20	1000.00	9.000	N	ON	20
12.45	29.24	---	60.00	30.76	1000.00	9.000	N	ON	20
12.48	---	23.49	50.00	26.51	1000.00	9.000	N	ON	20

Remark: Correct factor=cable loss + LISN factor

N line

Conducted Emission from 150 KHz to 30 MHz



## 4 Main Test Instruments

Name	Manufacturer	Type	Serial Number	Calibration Date	Expiration Time
Spectrum Analyzer	R&S	FSV30	103591	2021-05-15	2022-05-14
EMI Test Receiver	R&S	ESCI7	100936	2021-05-15	2022-05-14
Trilog Antenna	SCHWARZBECK	VULB 9163	391	2019-12-16	2022-12-15
Horn Antenna	R&S	HF907	102723	2020-08-11	2023-08-10
LISN	R&S	ENV216	102191	2020-12-13	2022-12-12
EMI Test Receiver	R&S	ESR	101667	2021-05-15	2022-05-14
Test software	R&S	EMC32	10.35.10	/	/
Test software	EMC32	R&S	9.26.0	/	/

\*\*\*\*\*END OF REPORT \*\*\*\*\*



## ANNEX A: The EUT Appearance

The EUT Appearance are submitted separately.



## **ANNEX B: Test Setup Photos**

**The Test Setup Photos are submitted separately.**