



RF TEST REPORT

Applicant ZTE Corporation
FCC ID SRQ-R219Z
Product Vodafone Mobile WiFi
Marketing R219z
Model R219z
Report No. R1911A0657-R3V1
Issue Date December 18, 2019

TA Technology (Shanghai) Co., Ltd. tested the above equipment in accordance with the requirements in **FCC CFR47 Part 2 (2018)/ FCC CFR47 Part 27C (2018)**. The test results show that the equipment tested is capable of demonstrating compliance with the requirements as documented in this report.

Performed by: Peng Tao

Approved by: Kai Xu

TA Technology (Shanghai) Co., Ltd.

No.145, Jintang Rd, Tangzhen Industry Park, Pudong Shanghai, China

TEL: +86-021-50791141/2/3

FAX: +86-021-50791141/2/3-8000



TABLE OF CONTENT

1	Test Laboratory	4
1.1	Notes of the Test Report	4
1.2	Testing Location	4
2	General Description of Equipment under Test	5
2.1	Applicant and Manufacturer Information	5
2.2	General information	5
3	Applied Standards	7
4	Test Configuration	8
5	Test Case Results	9
5.1	RF Power Output and Effective Radiated Power	9
5.2	Occupied Bandwidth	17
5.3	Band Edge Compliance	25
5.4	Peak-to-Average Power Ratio (PAPR)	35
5.5	Frequency Stability	38
5.6	Spurious Emissions at Antenna Terminals	41
5.7	Radiates Spurious Emission	45
6	Main Test Instruments	49



Summary of Measurement Results

Number	Test Case	Clause in FCC rules	Verdict
1	RF power output and Effective Radiated Power	2.1046 /27.50(h)(2)	PASS
2	Occupied Bandwidth	2.1049	PASS
3	Band Edge Compliance	/27.53(m)	PASS
4	Peak-to-Average Power Ratio	27.50(d)/KDB971168 D01(5.7)	PASS
5	Frequency Stability	2.1055 / 27.54	PASS
6	Spurious Emissions at Antenna Terminals	2.1051 /27.53(m)	PASS
7	Radiates Spurious Emission	2.1053 /27.53(m)	PASS
Note: PASS: The EUT complies with the essential requirements in the standard. FAIL: The EUT does not comply with the essential requirements in the standard.			
Date of Testing: November 13, 2019~ December 6, 2019			



1 Test Laboratory

1.1 Notes of the Test Report

This report shall not be reproduced in full or partial, without the written approval of **TA technology (shanghai) co., Ltd.** The results documented in this report apply only to the tested sample, under the conditions and modes of operation as described herein .Measurement Uncertainties were not taken into account and are published for informational purposes only. This report is written to support regulatory compliance of the applicable standards stated above.

1.2 Testing Location

Company: TA Technology (Shanghai) Co., Ltd.
Address: No.145, Jintang Rd, Tangzhen Industry Park, Pudong Shanghai, China
City: Shanghai
Post code: 201201
Country: P. R. China
Contact: Xu Kai
Telephone: +86-021-50791141/2/3
Fax: +86-021-50791141/2/3-8000
Website: <http://www.ta-shanghai.com>
E-mail: xukai@ta-shanghai.com

2 General Description of Equipment under Test

2.1 Applicant and Manufacturer Information

Applicant	ZTE Corporation
Applicant address	ZTE Plaza, Keji Road South, Shenzhen, China
Manufacturer	ZTE Corporation
Manufacturer address	ZTE Plaza, Keji Road South, Shenzhen, China

2.2 General information

EUT Description			
Model	R219z		
IMEI	35337311000068		
Hardware Version	dwhA_G1		
Software Version	BD_R219zV1.0		
Power Supply	Battery/AC adapter		
Antenna Type	Internal Antenna		
Antenna Gain	2.6dBi		
Test Mode(s)	LTE Band 7;		
Test Modulation	(LTE)QPSK 16QAM 64QAM;		
LTE Category	4		
Maximum E.I.R.P.	LTE Band 7:	24.79dBm	
Rated Power Supply Voltage:	3.8V		
Extreme Voltage	Minimum: 3.6V Maximum: 4.35V		
Extreme Temperature	Lowest: 0°C Highest: +35°C		
Operating Frequency Range(s)	Mode	Tx (MHz)	Rx (MHz)
	LTE Band 7	2500 ~ 2570	2620 ~ 2690
EUT Accessory			
Adapter 1	Manufacturer: SHENZHEN RUIJING INDUSTRIAL CO.,LTD. Model: STA-A51D-A		
Adapter 2	Manufacturer: Jiangxi Jian Aohai Technology Co., Ltd. Model: STA-A51D-A		
Battery	Manufacturer: ZHONGSHAN TIANMAO BATTERY CO.,LTD. Model: Li3820T43P3h715345		
USB Cable 1	Manufacturer: Shen Zhen Shi Yi HUA XING Electron Co.,Ltd Model: USB-MU5-W-100-M		
USB Cable 2	Manufacturer: King Power Electronics Co., Ltd. Model: USB-MU5-W-100-M		
Note: The information of the EUT is declared by the manufacturer.			



2. There is more than one USB cable, each one should be applied throughout the compliance test respectively, and however, only the worst case (USB cable 1) will be recorded in this report.



3 Applied Standards

According to the specifications of the manufacturer, it must comply with the requirements of the following standards:

Test standards:

FCC CFR47 Part 27C (2018)

ANSI C63.26 (2015)

Reference standard:

FCC CFR47 Part 2 (2018)

KDB 971168 D01 Power Meas License Digital Systems v03r01

4 Test Configuration

Radiated measurements are performed by rotating the EUT in three different orthogonal test planes. EUT stand-up position (Z axis), lie-down position (X, Y axis). Receiver antenna polarization (horizontal and vertical), the worst emission was found in position (Z axis, vertical polarization) and the worst case was recorded.

All mode and data rates and positions and RB size and modulations were investigated. Subsequently, only the worst case emissions are reported.

The following testing in LTE is set based on the maximum RF Output Power.

The following testing in different Bandwidth is set to detail in the following table:

Test modes are chosen to be reported as the worst case configuration below for LTE Band 7:

Test items	Bandwidth (MHz)						Modulation			RB			Test Channel		
	1.4	3	5	10	15	20	QP SK	16 QA M	64 QA M	1	50%	100%	L	M	H
RF power output	-	-	O	O	O	O	O	O	O	O	O	O	O	O	O
Effective Isotropic Radiated power	-	-	O	O	O	O	O	O	O	O	O	O	O	O	O
Occupied Bandwidth	-	-	O	O	O	O	O	O	O	-	-	O	O	O	O
Band Edge Compliance	-	-	O	O	O	O	O	O	O	O	-	O	O	-	O
Peak-to-Average Power Ratio	-	-	O	O	O	O	O	O	O	-	-	O	O	O	O
Frequency Stability	-	-	O	O	O	O	O	O	O	O	O	O	O	O	O
Spurious Emissions at Antenna Terminals	-	-	O	O	O	O	O	-	-	O	-	-	O	O	O
Radiates Spurious Emission	-	-	O	-	-	O	O	-	-	O	-	-	-	O	-

Note

1. The mark "O" means that this configuration is chosen for testing.
2. The mark "-" means that this configuration is not testing.

5 Test Case Results

5.1 RF Power Output and Effective Radiated Power

Ambient condition

Temperature	Relative humidity	Pressure
23°C ~25°C	45%~50%	101.5kPa

Methods of Measurement

During the process of the testing, The EUT is controlled by the Base Station Simulator to ensure max power transmission and proper modulation.

1. The testing follows FCC KDB 971168 D01 v03r01 Section 5.8 and ANSI C63.26 (2015).

- a) Connect the equipment as illustrated. Mount the equipment with the manufacturer specified antenna in a vertical orientation on a manufacturer specified mounting surface located on a non-conducting rotating platform of a RF anechoic chamber (preferred) or a standard radiation site.
 - b) Key the transmitter, then rotate the EUT 360° azimuthally and record spectrum analyzer power level (LVL) measurements at angular increments that are sufficiently small to permit resolution of all peaks. If a standard radiation test site is used, raise and lower the test antenna to obtain a maximum reading at each angular increment. (Note: several batteries may be needed to offset the effect of battery voltage droop, which should not exceed 5% of the manufactured specified battery voltage during transmission).
 - c) Replace the transmitter under test with a vertically polarized half-wave dipole (or an antenna whose gain is known relative to an ideal half-wave dipole). The center of the antenna should be at the same location as the center of the antenna under test.
 - d) Connect the antenna to a signal generator with a known output power and record the path loss (in dB) as LOSS. If a standard radiation test site is used, raise and lower the test antenna to obtain a maximum reading. $LOSS = \text{Generator Output Power (dBm)} - \text{Analyzer reading (dBm)}$
 - e) Determine the effective radiated output power at each angular position from the readings in steps b) and d) using the following equation: $ERP \text{ (dBm)} = \text{LVL (dBm)} + \text{LOSS (dB)}$
 - f) The maximum ERP is the maximum value determined in the preceding step.
 - g) When calculating ERP, in addition to knowing the antenna radiation and matching characteristics, it is necessary to know the loss values of all elements (e.g. transmission line attenuation, mismatches, filters, combiners) interposed between the point where transmitter output power is measured, and the point where power is applied to the antenna. ERP can then be calculated as follows:
 $EIRP \text{ (dBm)} = \text{Output Power (dBm)} - \text{Losses (dB)} + \text{Antenna Gain (dBi)}$
where: dBd refers to gain relative to an ideal dipole.
 $EIRP \text{ (dBm)} = ERP \text{ (dBm)} + 2.15 \text{ (dB.)}$
- The RB allocation refers to section 5.1, using the maximum output power configuration.

Test Setup

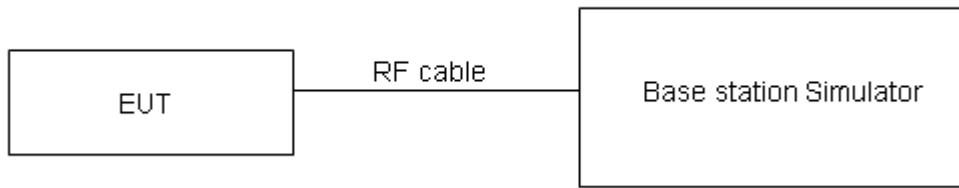

The loss between RF output port of the EUT and the input port of the tester has been taken into consideration.

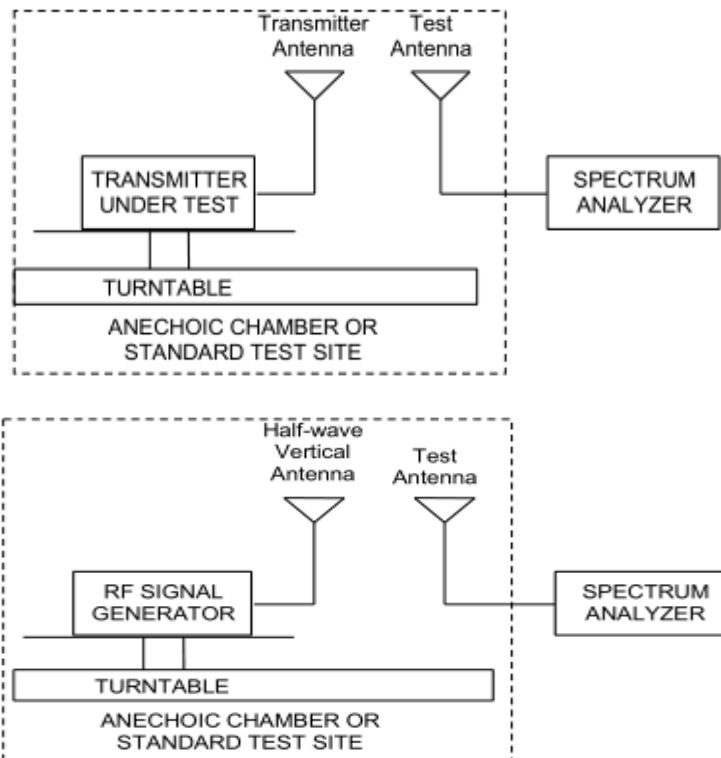

Note: Area side:2.4mX3.6m

The radiated emission was measured in the following position: EUT stand-up position (Z axis), lie-down position (X, Y axis). The worst emission was found in stand-up position (Z axis) and the worst case was recorded.

Limits

No specific RF power output requirements in part 2.1046.

Rule Part 27.50(h) (2) specifies that “Mobile and other user stations. Mobile stations are limited to 2.0 watts EIRP. All user stations are limited to 2.0 watts transmitter output power.”

Part 27.50(h)(2) Limit	≤ 2 W (33 dBm)
------------------------	----------------

Measurement Uncertainty

The assessed measurement uncertainty to ensure 95% confidence level for the normal distribution is with the coverage factor $k = 2$, $U=0.4$ dB for RF power output, $k = 2$, $U= 1.19$ dB for EIRP.



Test Results

Band	Bandwidth (MHz)	UL Channel	RB Size	RB Position	Modulation	Power (dBm)	EIRP
LTE Band7	5	20775	1	#0	QPSK	20.87	23.47
LTE Band7	5	20775	1	#Mid	QPSK	20.58	23.18
LTE Band7	5	20775	1	#Max	QPSK	21.03	23.63
LTE Band7	5	20775	12	#0	QPSK	19.63	22.23
LTE Band7	5	20775	12	#Mid	QPSK	19.63	22.23
LTE Band7	5	20775	12	#Max	QPSK	19.73	22.33
LTE Band7	5	20775	25	#0	QPSK	19.67	22.27
LTE Band7	5	20775	1	#0	QAM16	19.70	22.30
LTE Band7	5	20775	1	#Mid	QAM16	19.44	22.04
LTE Band7	5	20775	1	#Max	QAM16	19.90	22.50
LTE Band7	5	20775	12	#0	QAM16	18.77	21.37
LTE Band7	5	20775	12	#Mid	QAM16	18.78	21.38
LTE Band7	5	20775	12	#Max	QAM16	18.87	21.47
LTE Band7	5	20775	25	#0	QAM16	18.86	21.46
LTE Band7	5	21100	1	#0	QPSK	20.74	23.34
LTE Band7	5	21100	1	#Mid	QPSK	20.23	22.83
LTE Band7	5	21100	1	#Max	QPSK	20.64	23.24
LTE Band7	5	21100	12	#0	QPSK	19.40	22.00
LTE Band7	5	21100	12	#Mid	QPSK	19.40	22.00
LTE Band7	5	21100	12	#Max	QPSK	19.32	21.92
LTE Band7	5	21100	25	#0	QPSK	19.37	21.97
LTE Band7	5	21100	1	#0	QAM16	19.49	22.09
LTE Band7	5	21100	1	#Mid	QAM16	19.01	21.61
LTE Band7	5	21100	1	#Max	QAM16	19.44	22.04
LTE Band7	5	21100	12	#0	QAM16	18.67	21.27
LTE Band7	5	21100	12	#Mid	QAM16	18.68	21.28
LTE Band7	5	21100	12	#Max	QAM16	18.60	21.20
LTE Band7	5	21100	25	#0	QAM16	18.59	21.19
LTE Band7	5	21425	1	#0	QPSK	21.13	23.73
LTE Band7	5	21425	1	#Mid	QPSK	20.90	23.50
LTE Band7	5	21425	1	#Max	QPSK	21.21	23.81
LTE Band7	5	21425	12	#0	QPSK	19.62	22.22
LTE Band7	5	21425	12	#Mid	QPSK	19.63	22.23
LTE Band7	5	21425	12	#Max	QPSK	19.59	22.19
LTE Band7	5	21425	25	#0	QPSK	19.61	22.21
LTE Band7	5	21425	1	#0	QAM16	19.70	22.30
LTE Band7	5	21425	1	#Mid	QAM16	19.28	21.88
LTE Band7	5	21425	1	#Max	QAM16	19.65	22.25
LTE Band7	5	21425	12	#0	QAM16	18.60	21.20



LTE Band7	5	21425	12	#Mid	QAM16	18.63	21.23
LTE Band7	5	21425	12	#Max	QAM16	18.59	21.19
LTE Band7	5	21425	25	#0	QAM16	18.67	21.27
LTE Band7	10	20800	1	#0	QPSK	21.26	23.86
LTE Band7	10	20800	1	#Mid	QPSK	20.35	22.95
LTE Band7	10	20800	1	#Max	QPSK	22.19	24.79
LTE Band7	10	20800	25	#0	QPSK	19.59	22.19
LTE Band7	10	20800	25	#Mid	QPSK	19.62	22.22
LTE Band7	10	20800	25	#Max	QPSK	20.20	22.80
LTE Band7	10	20800	50	#0	QPSK	19.70	22.30
LTE Band7	10	20800	1	#0	QAM16	20.09	22.69
LTE Band7	10	20800	1	#Mid	QAM16	19.24	21.84
LTE Band7	10	20800	1	#Max	QAM16	20.78	23.38
LTE Band7	10	20800	25	#0	QAM16	18.79	21.39
LTE Band7	10	20800	25	#Mid	QAM16	18.80	21.40
LTE Band7	10	20800	25	#Max	QAM16	19.16	21.76
LTE Band7	10	20800	50	#0	QAM16	18.90	21.50
LTE Band7	10	21100	1	#0	QPSK	21.11	23.71
LTE Band7	10	21100	1	#Mid	QPSK	19.95	22.55
LTE Band7	10	21100	1	#Max	QPSK	20.99	23.59
LTE Band7	10	21100	25	#0	QPSK	19.33	21.93
LTE Band7	10	21100	25	#Mid	QPSK	19.35	21.95
LTE Band7	10	21100	25	#Max	QPSK	19.31	21.91
LTE Band7	10	21100	50	#0	QPSK	19.38	21.98
LTE Band7	10	21100	1	#0	QAM16	19.76	22.36
LTE Band7	10	21100	1	#Mid	QAM16	18.68	21.28
LTE Band7	10	21100	1	#Max	QAM16	19.74	22.34
LTE Band7	10	21100	25	#0	QAM16	18.57	21.17
LTE Band7	10	21100	25	#Mid	QAM16	18.58	21.18
LTE Band7	10	21100	25	#Max	QAM16	18.54	21.14
LTE Band7	10	21100	50	#0	QAM16	18.59	21.19
LTE Band7	10	21400	1	#0	QPSK	21.63	24.23
LTE Band7	10	21400	1	#Mid	QPSK	20.52	23.12
LTE Band7	10	21400	1	#Max	QPSK	21.61	24.21
LTE Band7	10	21400	25	#0	QPSK	19.23	21.83
LTE Band7	10	21400	25	#Mid	QPSK	19.25	21.85
LTE Band7	10	21400	25	#Max	QPSK	19.37	21.97
LTE Band7	10	21400	50	#0	QPSK	19.43	22.03
LTE Band7	10	21400	1	#0	QAM16	19.52	22.12
LTE Band7	10	21400	1	#Mid	QAM16	18.70	21.30
LTE Band7	10	21400	1	#Max	QAM16	19.68	22.28
LTE Band7	10	21400	25	#0	QAM16	18.18	20.78
LTE Band7	10	21400	25	#Mid	QAM16	18.20	20.80



LTE Band7	10	21400	25	#Max	QAM16	18.39	20.99
LTE Band7	10	21400	50	#0	QAM16	18.48	21.08
LTE Band7	15	20825	1	#0	QPSK	21.01	23.61
LTE Band7	15	20825	1	#Mid	QPSK	20.40	23.00
LTE Band7	15	20825	1	#Max	QPSK	21.11	23.71
LTE Band7	15	20825	36	#0	QPSK	19.80	22.40
LTE Band7	15	20825	36	#Mid	QPSK	19.52	22.12
LTE Band7	15	20825	36	#Max	QPSK	19.60	22.20
LTE Band7	15	20825	75	#0	QPSK	20.07	22.67
LTE Band7	15	20825	1	#0	QAM16	20.03	22.63
LTE Band7	15	20825	1	#Mid	QAM16	19.39	21.99
LTE Band7	15	20825	1	#Max	QAM16	19.97	22.57
LTE Band7	15	20825	36	#0	QAM16	18.86	21.46
LTE Band7	15	20825	36	#Mid	QAM16	18.74	21.34
LTE Band7	15	20825	36	#Max	QAM16	18.82	21.42
LTE Band7	15	20825	75	#0	QAM16	19.01	21.61
LTE Band7	15	21100	1	#0	QPSK	20.77	23.37
LTE Band7	15	21100	1	#Mid	QPSK	19.95	22.55
LTE Band7	15	21100	1	#Max	QPSK	20.93	23.53
LTE Band7	15	21100	36	#0	QPSK	19.68	22.28
LTE Band7	15	21100	36	#Mid	QPSK	19.69	22.29
LTE Band7	15	21100	36	#Max	QPSK	19.66	22.26
LTE Band7	15	21100	75	#0	QPSK	19.72	22.32
LTE Band7	15	21100	1	#0	QAM16	19.78	22.38
LTE Band7	15	21100	1	#Mid	QAM16	18.83	21.43
LTE Band7	15	21100	1	#Max	QAM16	19.82	22.42
LTE Band7	15	21100	36	#0	QAM16	18.67	21.27
LTE Band7	15	21100	36	#Mid	QAM16	18.69	21.29
LTE Band7	15	21100	36	#Max	QAM16	18.65	21.25
LTE Band7	15	21100	75	#0	QAM16	18.68	21.28
LTE Band7	15	21375	1	#0	QPSK	21.38	23.98
LTE Band7	15	21375	1	#Mid	QPSK	20.39	22.99
LTE Band7	15	21375	1	#Max	QPSK	21.53	24.13
LTE Band7	15	21375	36	#0	QPSK	19.24	21.84
LTE Band7	15	21375	36	#Mid	QPSK	19.26	21.86
LTE Band7	15	21375	36	#Max	QPSK	19.52	22.12
LTE Band7	15	21375	75	#0	QPSK	19.40	22.00
LTE Band7	15	21375	1	#0	QAM16	19.73	22.33
LTE Band7	15	21375	1	#Mid	QAM16	18.76	21.36
LTE Band7	15	21375	1	#Max	QAM16	19.72	22.32
LTE Band7	15	21375	36	#0	QAM16	18.24	20.84
LTE Band7	15	21375	36	#Mid	QAM16	18.26	20.86
LTE Band7	15	21375	36	#Max	QAM16	18.86	21.46



LTE Band7	15	21375	75	#0	QAM16	18.48	21.08
LTE Band7	20	20850	1	#0	QPSK	20.91	23.51
LTE Band7	20	20850	1	#Mid	QPSK	20.72	23.32
LTE Band7	20	20850	1	#Max	QPSK	21.19	23.79
LTE Band7	20	20850	50	#0	QPSK	19.90	22.50
LTE Band7	20	20850	50	#Mid	QPSK	19.92	22.52
LTE Band7	20	20850	50	#Max	QPSK	19.94	22.54
LTE Band7	20	20850	100	#0	QPSK	20.22	22.82
LTE Band7	20	20850	1	#0	QAM16	19.59	22.19
LTE Band7	20	20850	1	#Mid	QAM16	19.57	22.17
LTE Band7	20	20850	1	#Max	QAM16	20.13	22.73
LTE Band7	20	20850	50	#0	QAM16	18.86	21.46
LTE Band7	20	20850	50	#Mid	QAM16	18.87	21.47
LTE Band7	20	20850	50	#Max	QAM16	18.90	21.50
LTE Band7	20	20850	100	#0	QAM16	19.19	21.79
LTE Band7	20	21100	1	#0	QPSK	20.77	23.37
LTE Band7	20	21100	1	#Mid	QPSK	20.15	22.75
LTE Band7	20	21100	1	#Max	QPSK	20.95	23.55
LTE Band7	20	21100	50	#0	QPSK	19.60	22.20
LTE Band7	20	21100	50	#Mid	QPSK	19.61	22.21
LTE Band7	20	21100	50	#Max	QPSK	19.59	22.19
LTE Band7	20	21100	100	#0	QPSK	19.66	22.26
LTE Band7	20	21100	1	#0	QAM16	19.46	22.06
LTE Band7	20	21100	1	#Mid	QAM16	18.81	21.41
LTE Band7	20	21100	1	#Max	QAM16	19.71	22.31
LTE Band7	20	21100	50	#0	QAM16	18.59	21.19
LTE Band7	20	21100	50	#Mid	QAM16	18.59	21.19
LTE Band7	20	21100	50	#Max	QAM16	18.59	21.19
LTE Band7	20	21100	100	#0	QAM16	18.63	21.23
LTE Band7	20	21350	1	#0	QPSK	20.45	23.05
LTE Band7	20	21350	1	#Mid	QPSK	20.64	23.24
LTE Band7	20	21350	1	#Max	QPSK	21.52	24.12
LTE Band7	20	21350	50	#0	QPSK	19.20	21.80
LTE Band7	20	21350	50	#Mid	QPSK	19.23	21.83
LTE Band7	20	21350	50	#Max	QPSK	19.50	22.10
LTE Band7	20	21350	100	#0	QPSK	19.45	22.05
LTE Band7	20	21350	1	#0	QAM16	19.01	21.61
LTE Band7	20	21350	1	#Mid	QAM16	18.95	21.55
LTE Band7	20	21350	1	#Max	QAM16	19.73	22.33
LTE Band7	20	21350	50	#0	QAM16	18.19	20.79
LTE Band7	20	21350	50	#Mid	QAM16	18.21	20.81
LTE Band7	20	21350	50	#Max	QAM16	18.82	21.42
LTE Band7	20	21350	100	#0	QAM16	18.52	21.12



LTE Band7	5	20775	1	#0	QAM64	19.68	22.28
LTE Band7	5	20775	1	#Mid	QAM64	19.38	21.98
LTE Band7	5	20775	1	#Max	QAM64	19.90	22.50
LTE Band7	5	20775	12	#0	QAM64	18.78	21.38
LTE Band7	5	20775	12	#Mid	QAM64	18.75	21.35
LTE Band7	5	20775	12	#Max	QAM64	18.84	21.44
LTE Band7	5	20775	25	#0	QAM64	18.78	21.38
LTE Band7	5	21100	1	#0	QAM64	19.53	22.13
LTE Band7	5	21100	1	#Mid	QAM64	19.09	21.69
LTE Band7	5	21100	1	#Max	QAM64	19.66	22.26
LTE Band7	5	21100	12	#0	QAM64	18.52	21.12
LTE Band7	5	21100	12	#Mid	QAM64	18.58	21.18
LTE Band7	5	21100	12	#Max	QAM64	18.47	21.07
LTE Band7	5	21100	25	#0	QAM64	18.49	21.09
LTE Band7	5	21425	1	#0	QAM64	19.48	22.08
LTE Band7	5	21425	1	#Mid	QAM64	19.12	21.72
LTE Band7	5	21425	1	#Max	QAM64	19.28	21.88
LTE Band7	5	21425	12	#0	QAM64	18.65	21.25
LTE Band7	5	21425	12	#Mid	QAM64	18.60	21.20
LTE Band7	5	21425	12	#Max	QAM64	18.51	21.11
LTE Band7	5	21425	25	#0	QAM64	18.59	21.19
LTE Band7	10	20800	1	#0	QAM64	20.37	22.97
LTE Band7	10	20800	1	#Mid	QAM64	19.54	22.14
LTE Band7	10	20800	1	#Max	QAM64	20.49	23.09
LTE Band7	10	20800	25	#0	QAM64	19.00	21.60
LTE Band7	10	20800	25	#Mid	QAM64	18.99	21.59
LTE Band7	10	20800	25	#Max	QAM64	19.11	21.71
LTE Band7	10	20800	50	#0	QAM64	19.08	21.68
LTE Band7	10	21100	1	#0	QAM64	20.14	22.74
LTE Band7	10	21100	1	#Mid	QAM64	18.91	21.51
LTE Band7	10	21100	1	#Max	QAM64	19.91	22.51
LTE Band7	10	21100	25	#0	QAM64	18.70	21.30
LTE Band7	10	21100	25	#Mid	QAM64	18.71	21.31
LTE Band7	10	21100	25	#Max	QAM64	18.66	21.26
LTE Band7	10	21100	50	#0	QAM64	18.70	21.30
LTE Band7	10	21400	1	#0	QAM64	19.82	22.42
LTE Band7	10	21400	1	#Mid	QAM64	18.90	21.50
LTE Band7	10	21400	1	#Max	QAM64	20.01	22.61
LTE Band7	10	21400	25	#0	QAM64	18.44	21.04
LTE Band7	10	21400	25	#Mid	QAM64	18.43	21.03
LTE Band7	10	21400	25	#Max	QAM64	18.69	21.29
LTE Band7	10	21400	50	#0	QAM64	18.86	21.46
LTE Band7	15	20825	1	#0	QAM64	20.25	22.85



LTE Band7	15	20825	1	#Mid	QAM64	19.52	22.12
LTE Band7	15	20825	1	#Max	QAM64	20.42	23.02
LTE Band7	15	20825	36	#0	QAM64	19.33	21.93
LTE Band7	15	20825	36	#Mid	QAM64	19.33	21.93
LTE Band7	15	20825	36	#Max	QAM64	19.11	21.71
LTE Band7	15	20825	75	#0	QAM64	19.33	21.93
LTE Band7	15	21100	1	#0	QAM64	20.11	22.71
LTE Band7	15	21100	1	#Mid	QAM64	19.10	21.70
LTE Band7	15	21100	1	#Max	QAM64	19.88	22.48
LTE Band7	15	21100	36	#0	QAM64	18.83	21.43
LTE Band7	15	21100	36	#Mid	QAM64	18.83	21.43
LTE Band7	15	21100	36	#Max	QAM64	18.78	21.38
LTE Band7	15	21100	75	#0	QAM64	18.81	21.41
LTE Band7	15	21375	1	#0	QAM64	19.24	21.84
LTE Band7	15	21375	1	#Mid	QAM64	18.69	21.29
LTE Band7	15	21375	1	#Max	QAM64	19.95	22.55
LTE Band7	15	21375	36	#0	QAM64	18.05	20.65
LTE Band7	15	21375	36	#Mid	QAM64	18.05	20.65
LTE Band7	15	21375	36	#Max	QAM64	18.75	21.35
LTE Band7	15	21375	75	#0	QAM64	18.58	21.18
LTE Band7	20	20850	1	#0	QAM64	20.15	22.75
LTE Band7	20	20850	1	#Mid	QAM64	19.21	21.81
LTE Band7	20	20850	1	#Max	QAM64	20.23	22.83
LTE Band7	20	20850	50	#0	QAM64	19.14	21.74
LTE Band7	20	20850	50	#Mid	QAM64	19.14	21.74
LTE Band7	20	20850	50	#Max	QAM64	18.89	21.49
LTE Band7	20	20850	100	#0	QAM64	19.16	21.76
LTE Band7	20	21100	1	#0	QAM64	19.74	22.34
LTE Band7	20	21100	1	#Mid	QAM64	19.16	21.76
LTE Band7	20	21100	1	#Max	QAM64	19.81	22.41
LTE Band7	20	21100	50	#0	QAM64	18.70	21.30
LTE Band7	20	21100	50	#Mid	QAM64	18.71	21.31
LTE Band7	20	21100	50	#Max	QAM64	18.64	21.24
LTE Band7	20	21100	100	#0	QAM64	18.74	21.34
LTE Band7	20	21350	1	#0	QAM64	19.22	21.82
LTE Band7	20	21350	1	#Mid	QAM64	18.98	21.58
LTE Band7	20	21350	1	#Max	QAM64	19.93	22.53
LTE Band7	20	21350	50	#0	QAM64	18.30	20.90
LTE Band7	20	21350	50	#Mid	QAM64	18.30	20.90
LTE Band7	20	21350	50	#Max	QAM64	18.98	21.58
LTE Band7	20	21350	100	#0	QAM64	18.78	21.38

5.2 Occupied Bandwidth

Ambient condition

Temperature	Relative humidity	Pressure
23°C ~25°C	45%~50%	101.5kPa

Method of Measurement

The EUT was connected to Spectrum Analyzer and Base Station Simulator via power Splitter. The occupied bandwidth is measured using spectrum analyzer.

RBW is set to 100 kHz, VBW is set to 300 kHz for LTE Band 7(5MHz).

RBW is set to 200 kHz, VBW is set to 620kHz for LTE Band 7(10MHz).

RBW is set to 300 kHz, VBW is set to 910kHz for LTE Band 7(15MHz).

RBW is set to 430 kHz, VBW is set to 1.2MHz for LTE Band 7(20MHz).

99% power and -26dBc occupied bandwidths are recorded. Spectrum analyzer plots are included on the following pages.

Test Setup

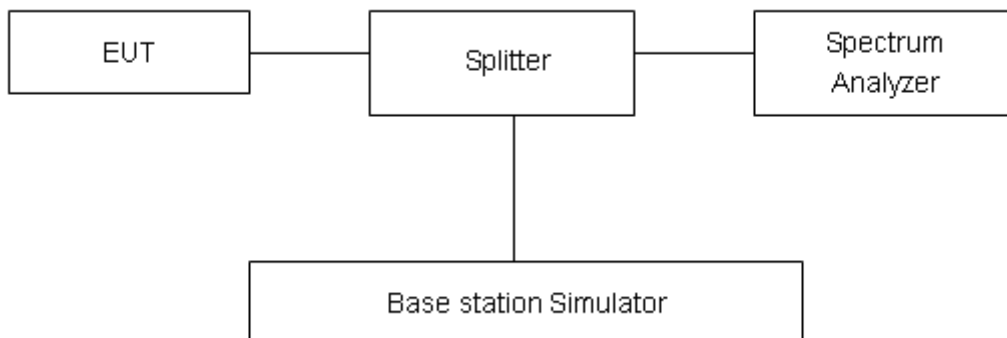

Limits

No specific occupied bandwidth requirements in part 2.1049.

Measurement Uncertainty

The assessed measurement uncertainty to ensure 95% confidence level for the normal distribution is with the coverage factor $k = 2$, $U=624\text{Hz}$.



Test Result

LTE Band 7						
RB	Modulation	Bandwidth (MHz)	Channel	Frequency (MHz)	99% Power Bandwidth(MHz)	-26dBc Bandwidth(MHz)
100%	QPSK	5	20775	2502.5	4.5253	5.178
			21100	2535	4.5515	5.152
			21425	2567.5	4.5377	5.135
		10	20800	2505	9.0178	10.450
			21100	2535	9.0059	10.300
			21400	2565	9.0136	10.230
		15	20825	2507.5	13.5210	15.420
			21100	2535	13.5340	15.800
			21375	2562.5	13.5210	15.550
		20	20850	2510	18.0140	19.410
			21100	2535	18.0830	19.760
			21350	2560	17.9900	19.610
	16QAM	5	20775	2502.5	4.5308	5.098
			21100	2535	4.5255	5.055
			21425	2567.5	4.5446	5.076
		10	20800	2505	9.0216	10.450
			21100	2535	9.0237	10.360
			21400	2565	9.0202	10.390
		15	20825	2507.5	13.5050	15.650
			21100	2535	13.5300	15.570
			21375	2562.5	13.5540	15.580
		20	20850	2510	17.9910	19.660
			21100	2535	18.0150	19.760
			21350	2560	18.0340	19.710
	64QAM	5	20775	2502.5	4.5453	5.095
			21100	2535	4.5323	5.108
			21425	2567.5	4.5374	5.173
		10	20800	2505	9.0174	10.230
			21100	2535	9.0296	10.390
			21400	2565	9.0244	10.220
15		20825	2507.5	13.5380	15.720	
		21100	2535	13.5450	15.600	
		21375	2562.5	13.5210	15.810	
20		20850	2510	18.0060	19.420	
		21100	2535	18.0070	19.680	
		21350	2560	18.0190	19.710	



LTE Band 7 QPSK 5MHz CH-Low

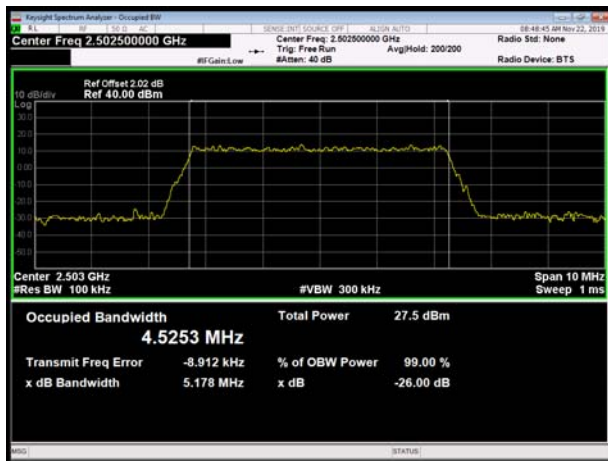

LTE Band 7 QPSK 10MHz CH-Low

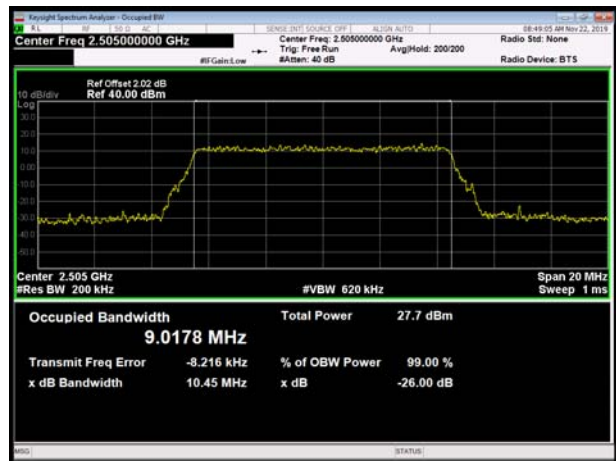

LTE Band 7 QPSK 5MHz CH-Middle



LTE Band 7 QPSK 10MHz CH-Middle



LTE Band 7 QPSK 5MHz CH-High



LTE Band 7 QPSK 10MHz CH-High





LTE Band 7 QPSK 15MHz CH-Low

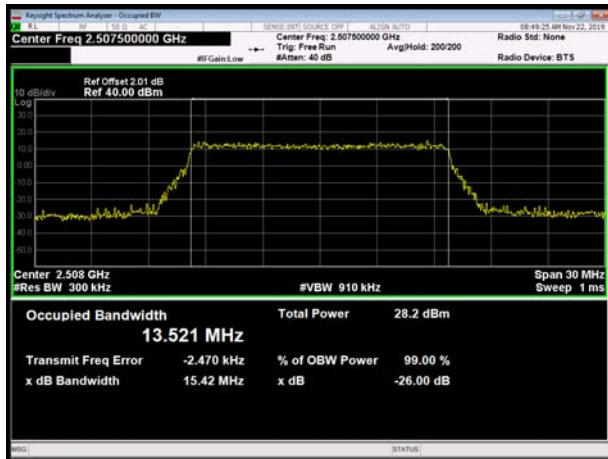

LTE Band 7 QPSK 20MHz CH-Low

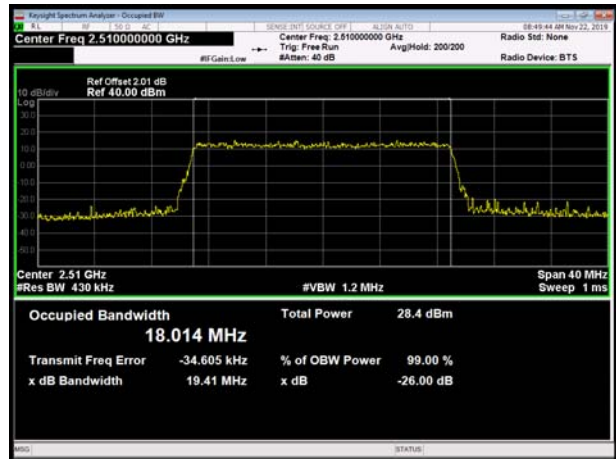

LTE Band 7 QPSK 15MHz CH-Middle

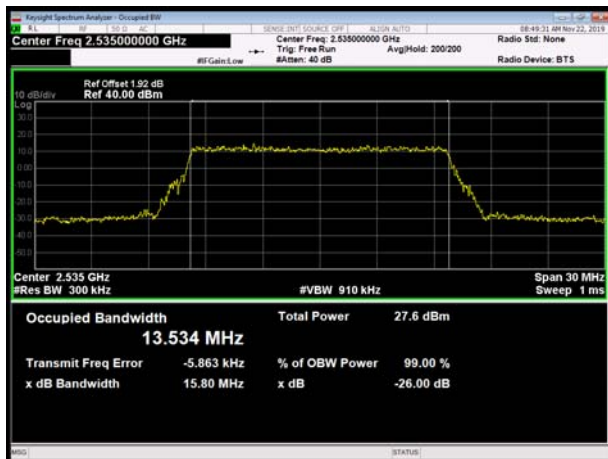

LTE Band 7 QPSK 20MHz CH-Middle

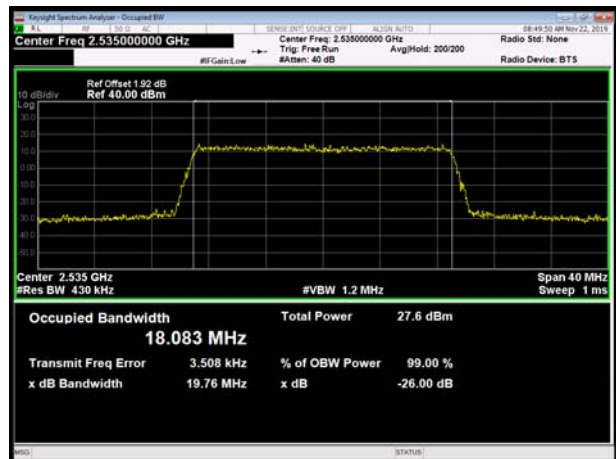

LTE Band 7 QPSK 15MHz CH-High

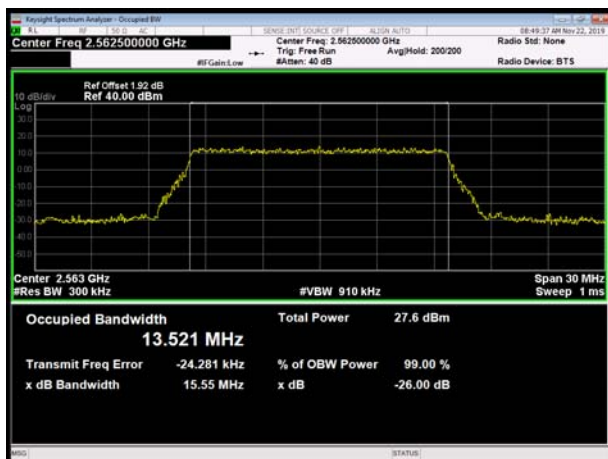

LTE Band 7 QPSK 20MHz CH-High

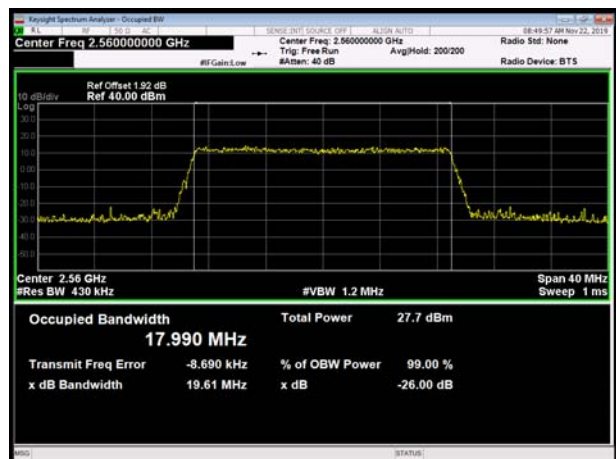



LTE Band 7 16QAM 5MHz CH-Low



LTE Band 7 16QAM 10MHz CH-Low



LTE Band 7 16QAM 5MHz CH-Middle



LTE Band 7 16QAM 10MHz CH-Middle



LTE Band 7 16QAM 5MHz CH-High



LTE Band 7 16QAM 10MHz CH-High





LTE Band 7 16QAM 15MHz CH-Low

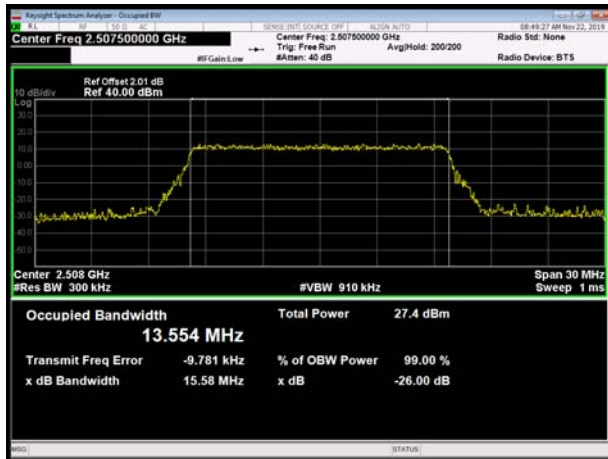

LTE Band 7 16QAM 20MHz CH-Low

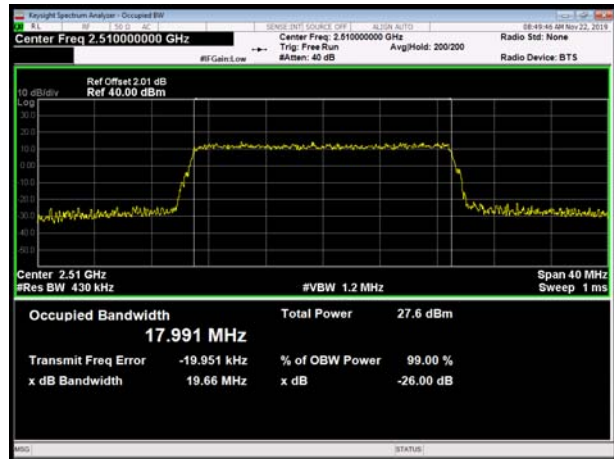

LTE Band 7 16QAM 15MHz CH-Middle

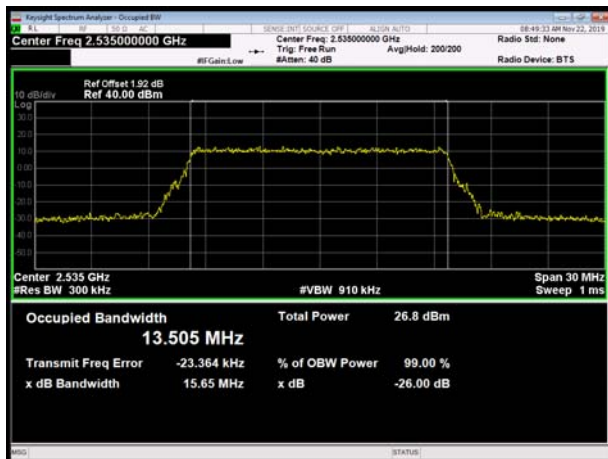

LTE Band 7 16QAM 20MHz CH-Middle

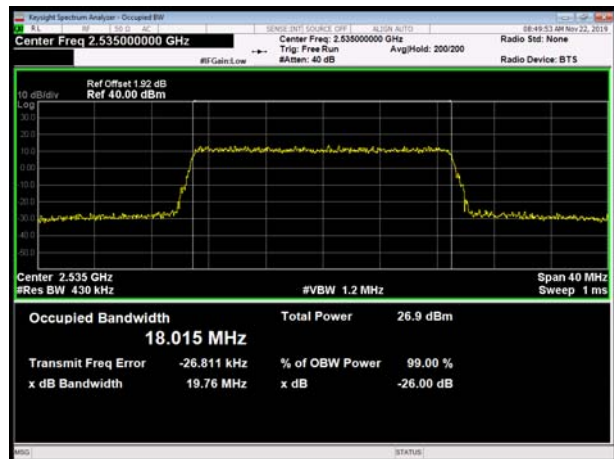

LTE Band 7 16QAM 15MHz CH-High

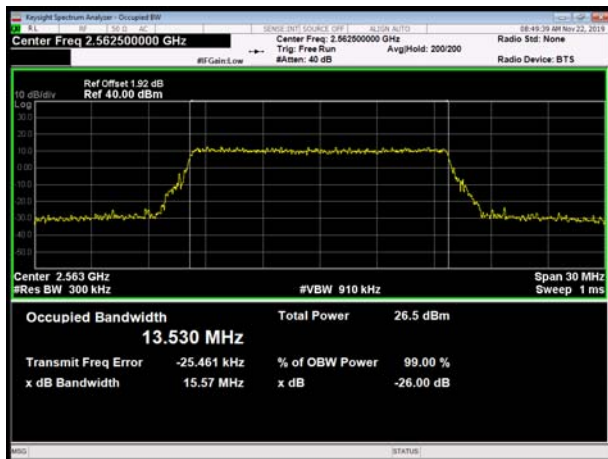

LTE Band 7 16QAM 20MHz CH-High





LTE Band 7 64QAM 5MHz CH-Low

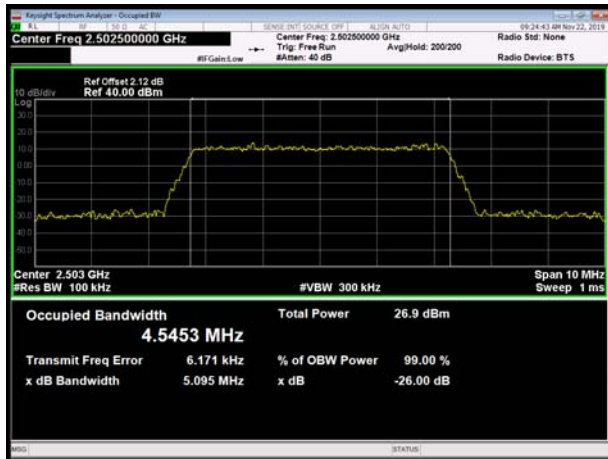

LTE Band 7 64QAM 10MHz CH-Low



LTE Band 7 64QAM 5MHz CH-Middle

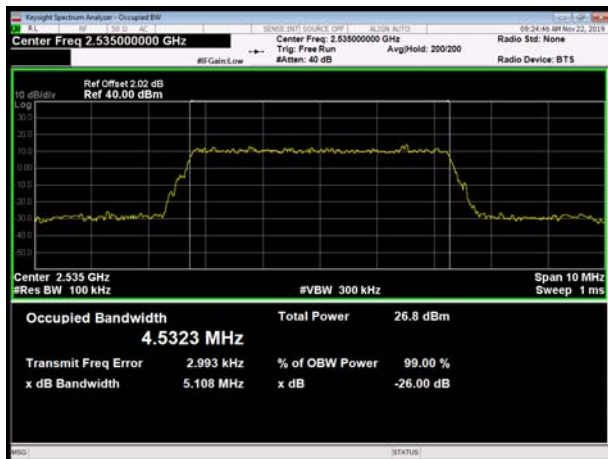

LTE Band 7 64QAM 10MHz CH-Middle



LTE Band 7 64QAM 5MHz CH-High



LTE Band 7 64QAM 10MHz CH-High





LTE Band 7 64QAM 15MHz CH-Low

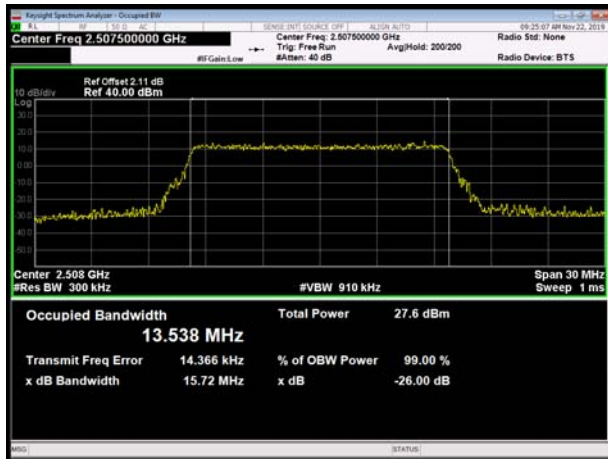

LTE Band 7 64QAM 20MHz CH-Low

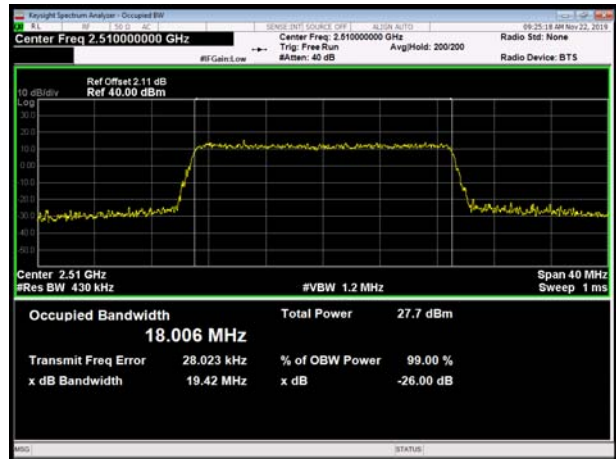

LTE Band 7 64QAM 15MHz CH-Middle

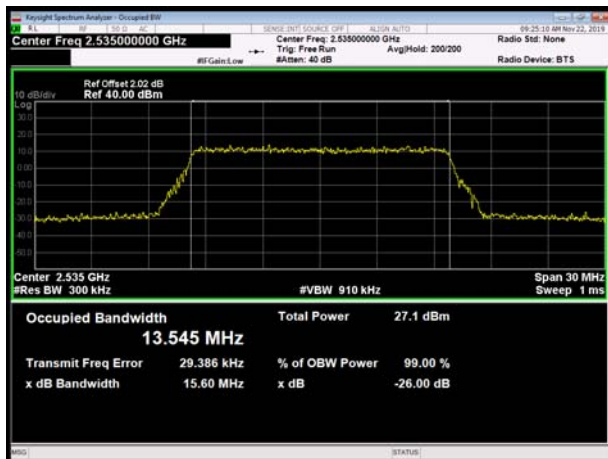

LTE Band 7 64QAM 20MHz CH-Middle

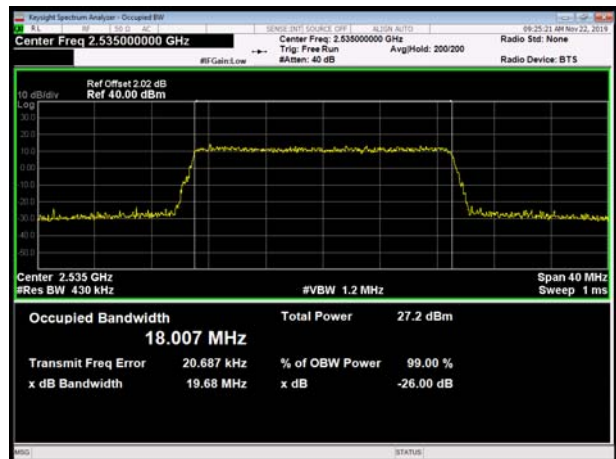

LTE Band 7 64QAM 15MHz CH-High

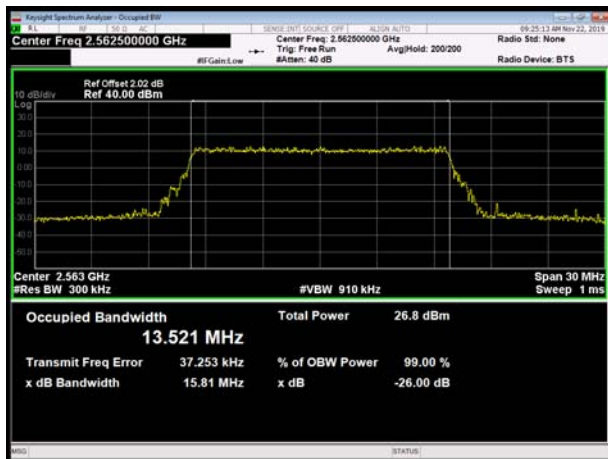

LTE Band 7 64QAM 20MHz CH-High



5.3 Band Edge Compliance

Ambient condition

Temperature	Relative humidity	Pressure
23°C ~25°C	45%~50%	101.5kPa

Method of Measurement

The EUT was connected to Spectrum Analyzer and Base Station Simulator via power Splitter. The band edge of the lowest and highest channels were measured.

The testing follows KDB 971168 D01 v03r01 Section 6.0

The EUT was connected to spectrum analyzer and system simulator via a power divider.

RBW is set to 50 kHz, VBW is set to 200 kHz for LTE Band 7 (5MHz).

RBW is set to 100 kHz, VBW is set to 300kHz for LTE Band 7 (10MHz).

RBW is set to 200 kHz, VBW is set to 1MHz for LTE Band 7 (15MHz/20MHz).

on spectrum analyzer.

Set spectrum analyzer with RMS detector.

The RF fundamental frequency should be excluded against the limit line in the operating frequency band.

Checked that all the results comply with the emission limit line.

Test Setup

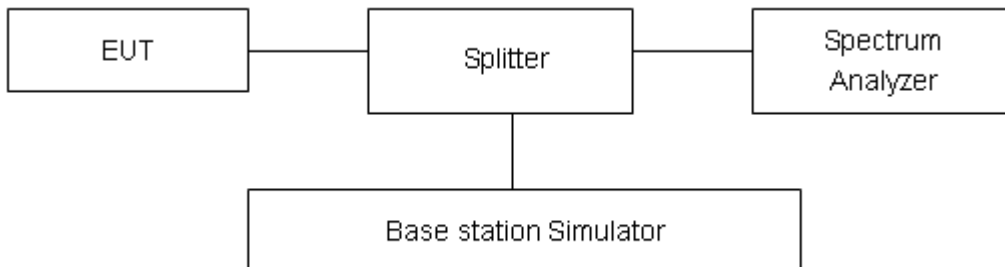

Limits

Rule Part 27.53(m) (4) specifies that “for BRS and EBS stations. For mobile digital stations, the attenuation factor shall be not less than $40 + 10 \log (P)$ dB on all frequencies between the channel edge and 5 megahertz from the channel edge, $43 + 10 \log (P)$ dB on all frequencies between 5 megahertz and X megahertz from the channel edge, and $55 + 10 \log (P)$ dB on all frequencies more than X megahertz from the channel edge, where X is the greater of 6 megahertz or the actual emission bandwidth as defined in paragraph (m)(4) of this section. In addition, the attenuation factor shall not be less that $43 + 10 \log (P)$ dB on all frequencies between 2490.5 MHz and 2496 MHz and $55 + 10 \log (P)$ dB at or below 2490.5 MHz. Mobile Satellite Service licensees operating on



frequencies below 2495 MHz may also submit a documented interference complaint against BRS licensees operating on channel BRS Channel 1 on the same terms and conditions as adjacent channel BRS or EBS licensees.

Example:

The limit line is derived from $43 + 10\log(P)$ dB below the transmitter power P (Watts)

$= P(W) - [43 + 10\log(P)]$ (dB)

$= [30 + 10\log(P)]$ (dBm) - $[43 + 10\log(P)]$ (dB) = -13dBm.

Measurement Uncertainty

The assessed measurement uncertainty to ensure 95% confidence level for the normal distribution is with the coverage factor $k = 1.96$, $U=0.684$ dB.



Test Result

All the test traces in the plots shows the test results clearly.

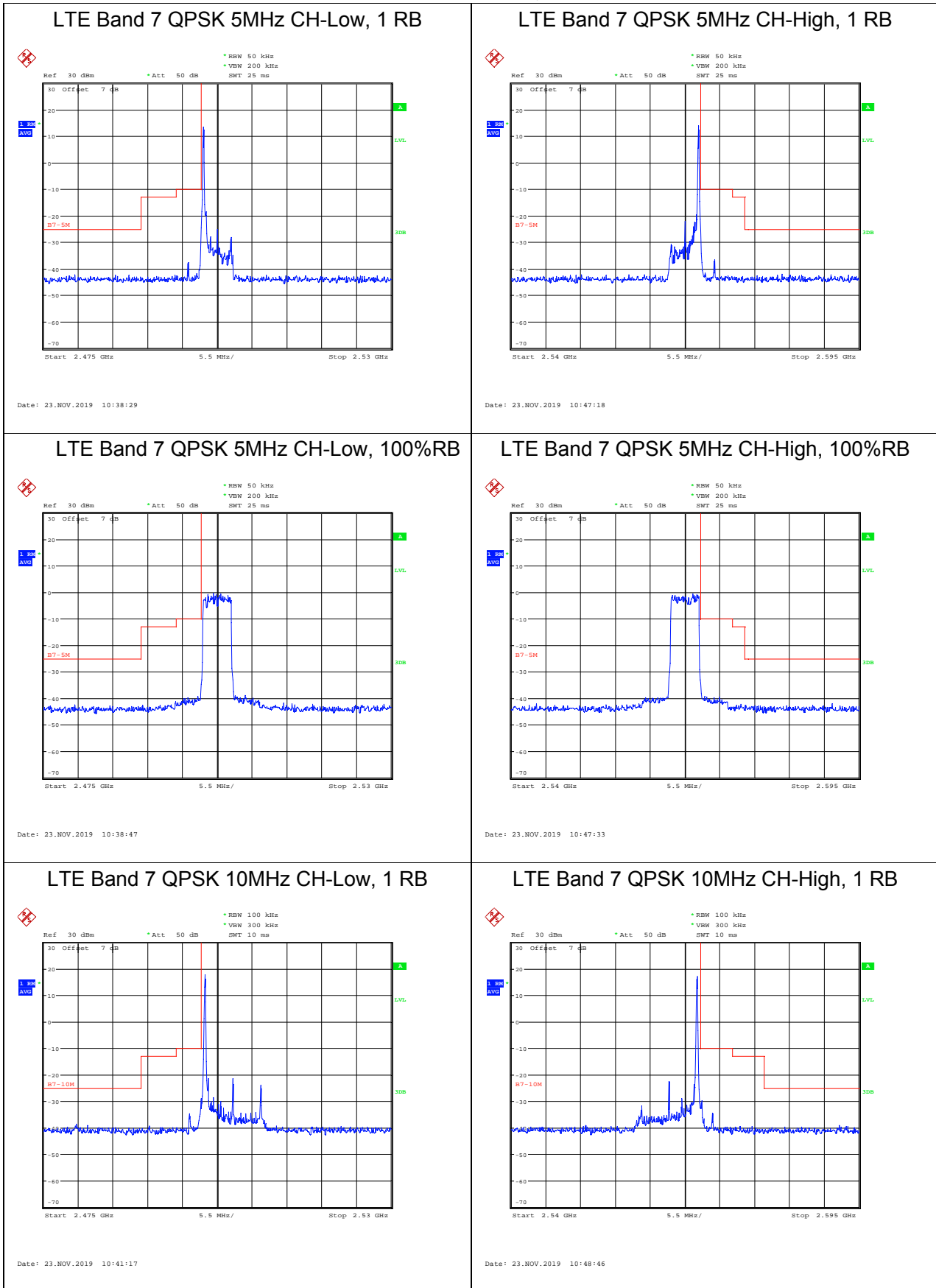



LTE Band 7 QPSK 10MHz CH-Low, 100%RB

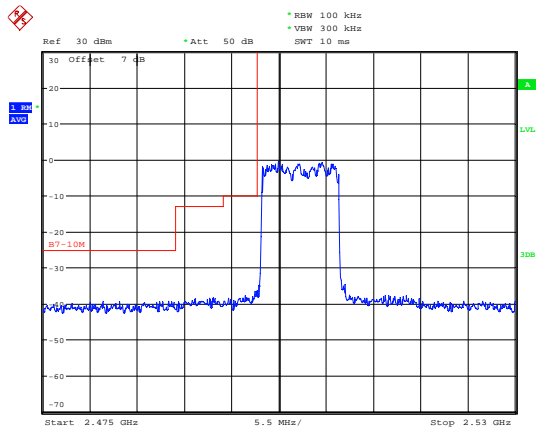

Date: 23.NOV.2019 10:41:31

LTE Band 7 QPSK 10MHz CH-High, 100%RB

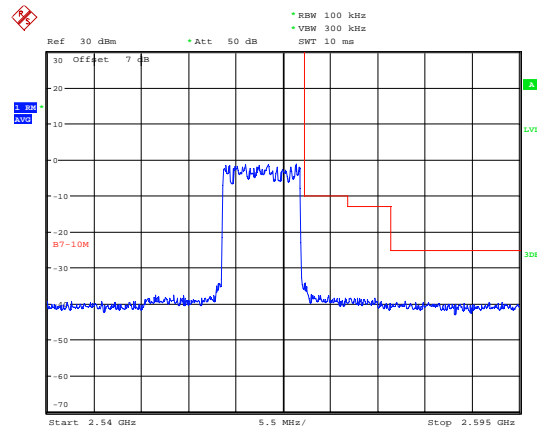

Date: 23.NOV.2019 10:48:58

LTE Band 7 QPSK 15MHz CH-Low, 1 RB

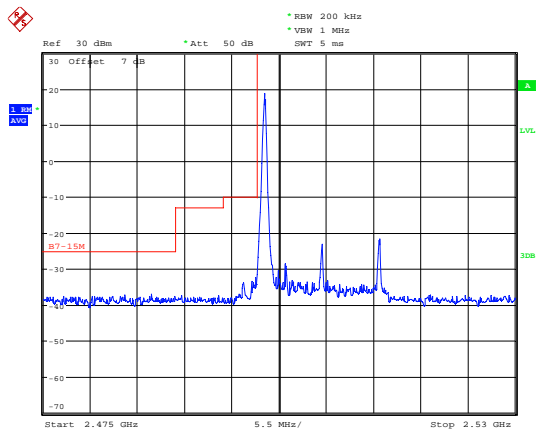

Date: 23.NOV.2019 10:43:13

LTE Band 7 QPSK 15MHz CH-High, 1 RB

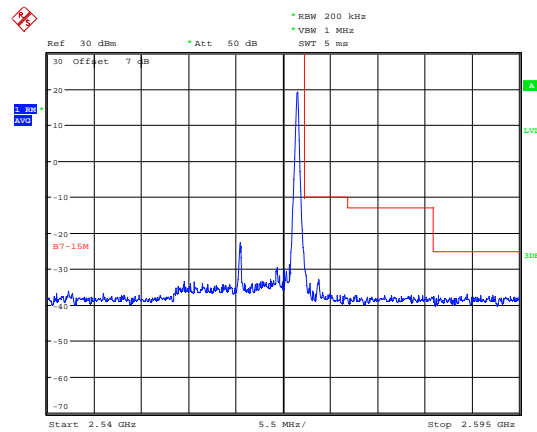

Date: 23.NOV.2019 10:50:18

LTE Band 7 QPSK 15MHz CH-Low, 100%RB

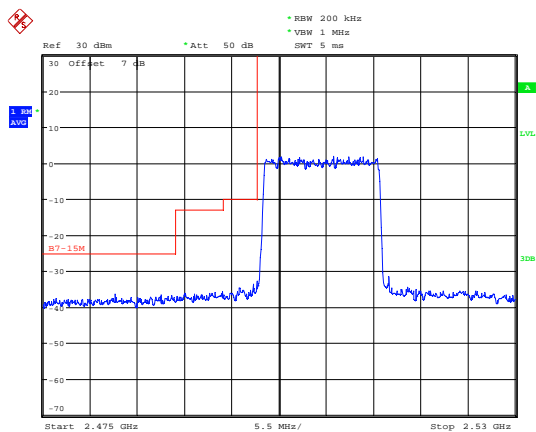

Date: 23.NOV.2019 10:43:26

LTE Band 7 QPSK 15MHz CH-High, 100%RB

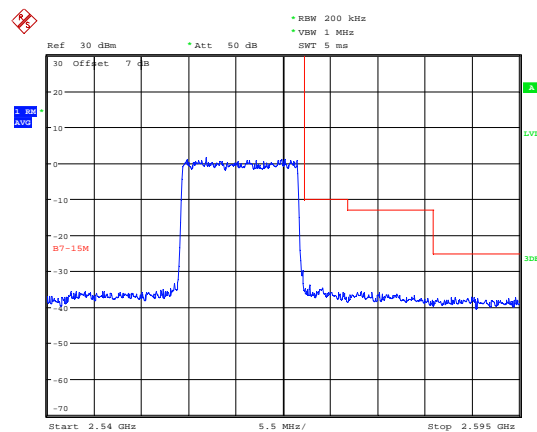

Date: 23.NOV.2019 10:50:30



LTE Band 7 QPSK 20MHz CH-Low, 1 RB

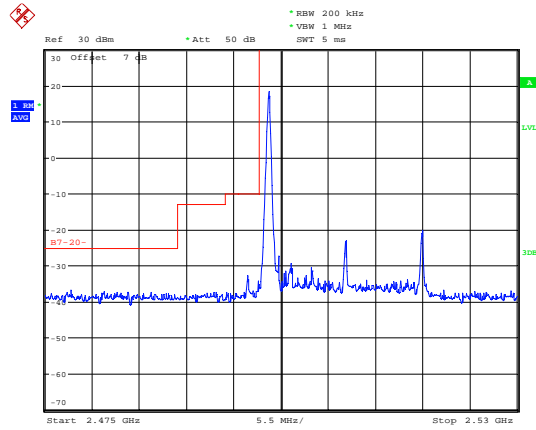

Date: 23.NOV.2019 10:44:35

LTE Band 7 QPSK 20MHz CH-High, 1 RB

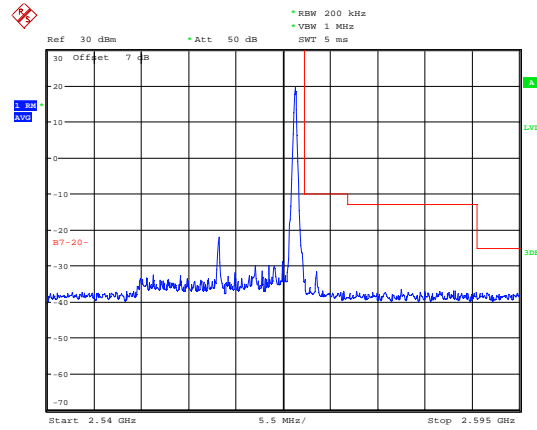

Date: 23.NOV.2019 10:51:33

LTE Band 7 QPSK 20MHz CH-Low, 100%RB

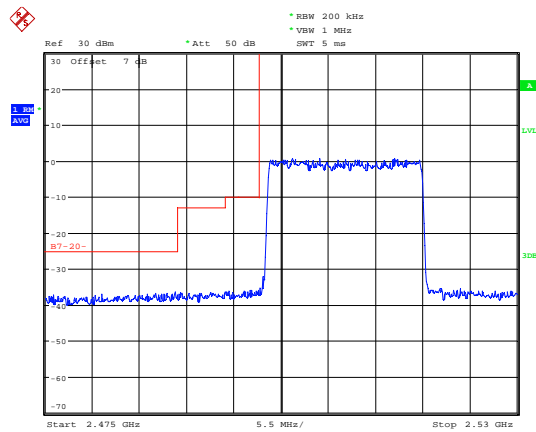

Date: 23.NOV.2019 10:44:48

LTE Band 7 QPSK 20MHz CH-High, 100%RB

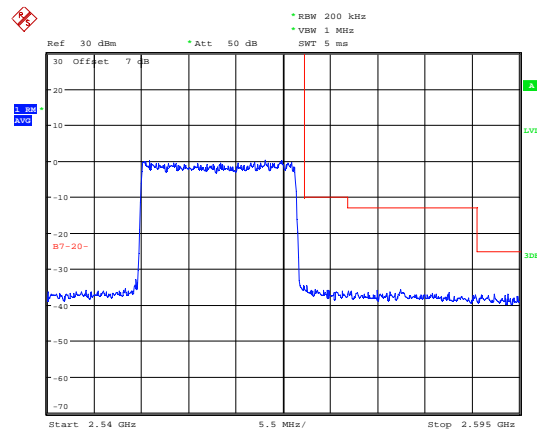

Date: 23.NOV.2019 10:51:45

LTE Band 7 16QAM 5MHz CH-Low, 1 RB

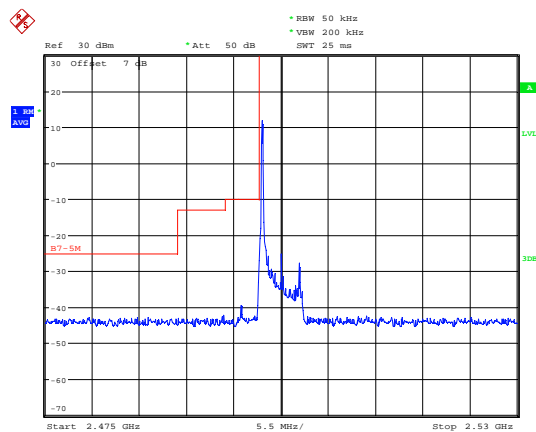

Date: 23.NOV.2019 10:39:01

LTE Band 7 16QAM 5MHz CH-High, 1 RB

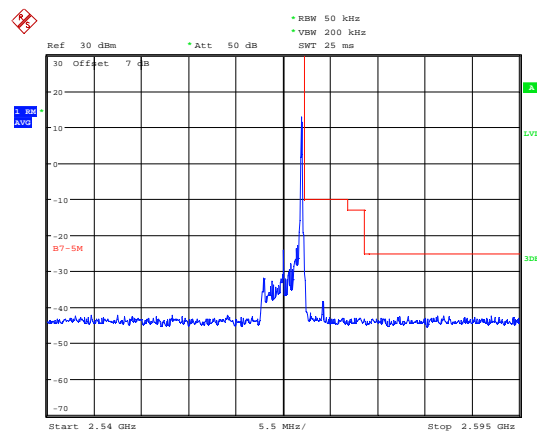

Date: 23.NOV.2019 10:47:47



LTE Band 7 16QAM 5MHz CH-Low, 100%RB

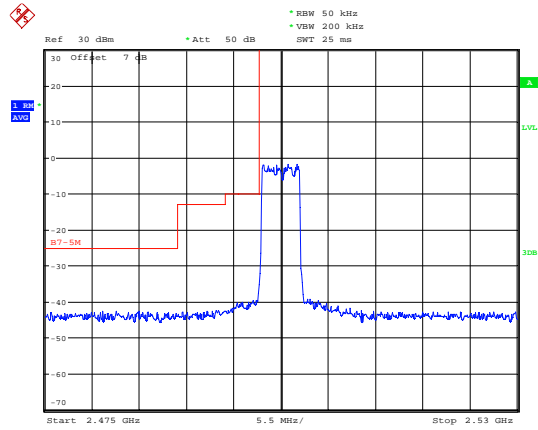

Date: 23.NOV.2019 10:40:23

LTE Band 7 16QAM 5MHz CH-High, 100%RB

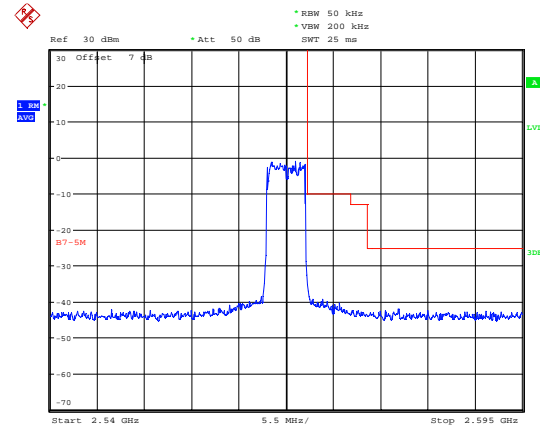

Date: 23.NOV.2019 10:47:59

LTE Band 7 16QAM 10MHz CH-Low, 1 RB

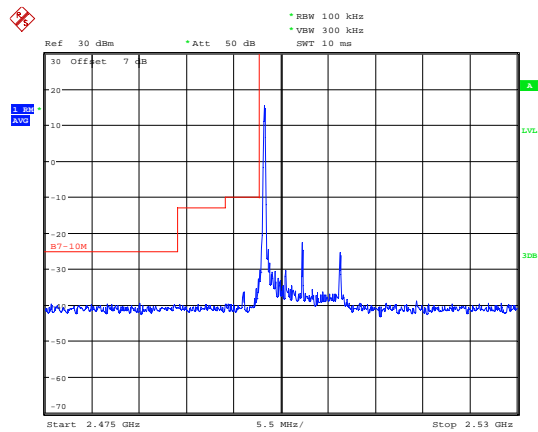

Date: 23.NOV.2019 10:41:44

LTE Band 7 16QAM 10MHz CH-High, 1 RB

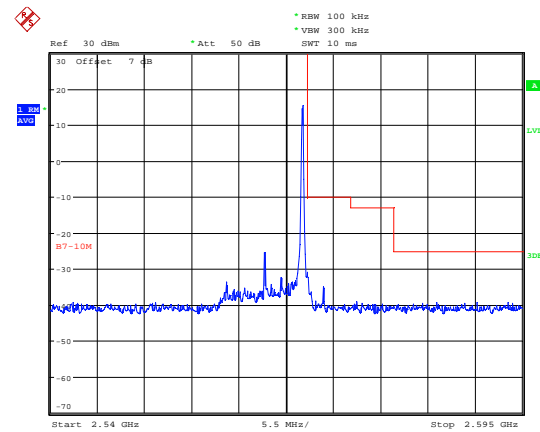

Date: 23.NOV.2019 10:49:23

LTE Band 7 16QAM 10MHz CH-Low, 100%RB

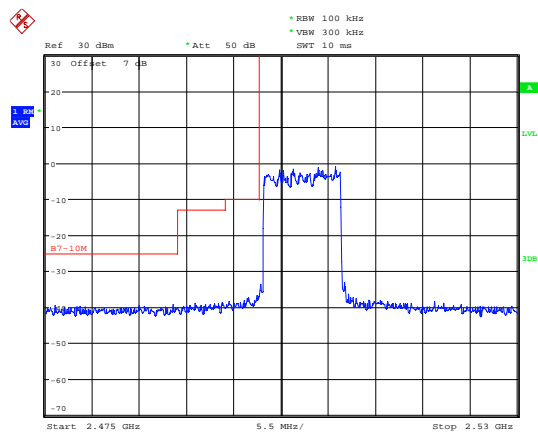

Date: 23.NOV.2019 10:42:00

LTE Band 7 16QAM 10MHz CH-High, 100%RB

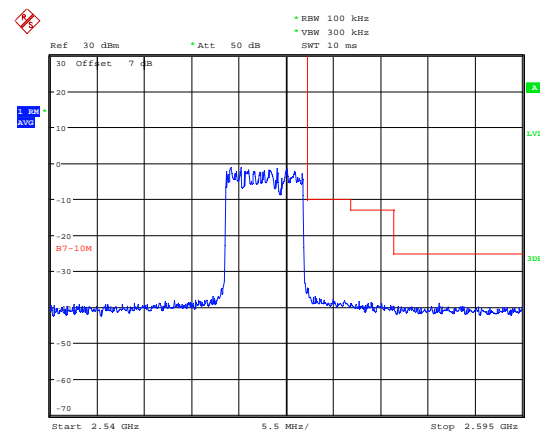

Date: 23.NOV.2019 10:49:36



LTE Band 7 16QAM 15MHz CH-Low, 1 RB

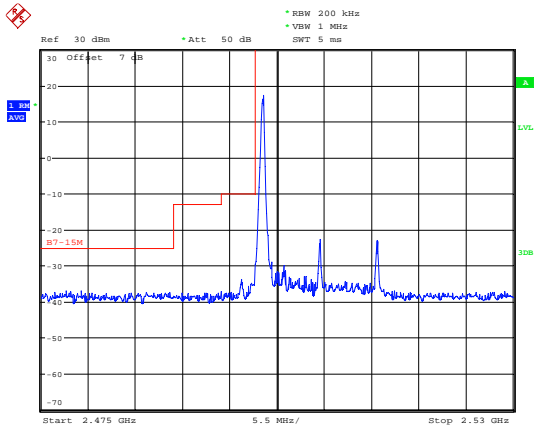

Date: 23.NOV.2019 10:43:39

LTE Band 7 16QAM 15MHz CH-High, 1 RB

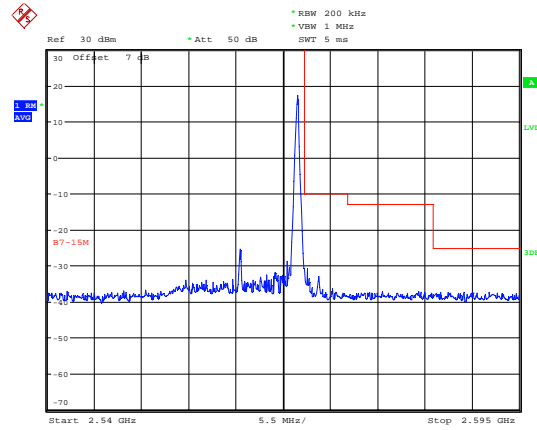

Date: 23.NOV.2019 10:50:43

LTE Band 7 16QAM 15MHz CH-Low, 100%RB

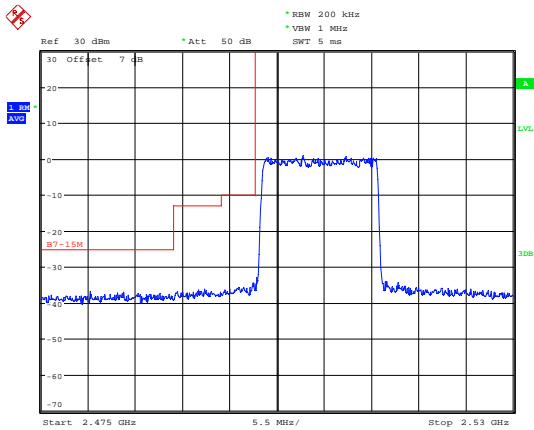

Date: 23.NOV.2019 10:43:52

LTE Band 7 16QAM 15MHz CH-High, 100%RB

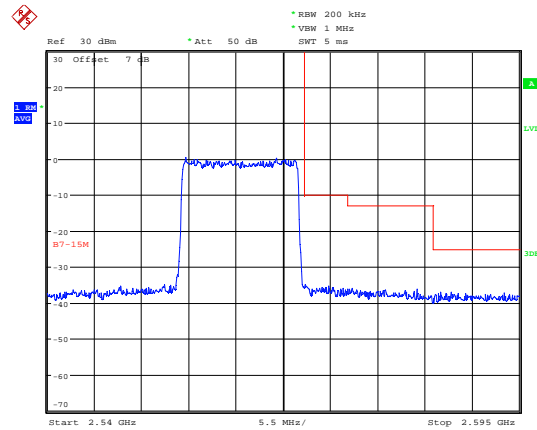

Date: 23.NOV.2019 10:50:54

LTE Band 7 16QAM 20MHz CH-Low, 1 RB

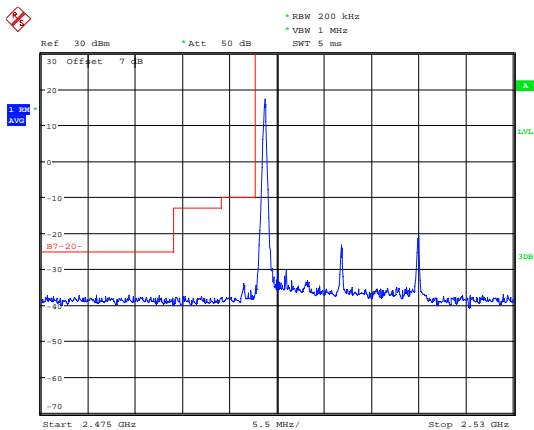

Date: 23.NOV.2019 10:45:05

LTE Band 7 16QAM 20MHz CH-High, 1 RB

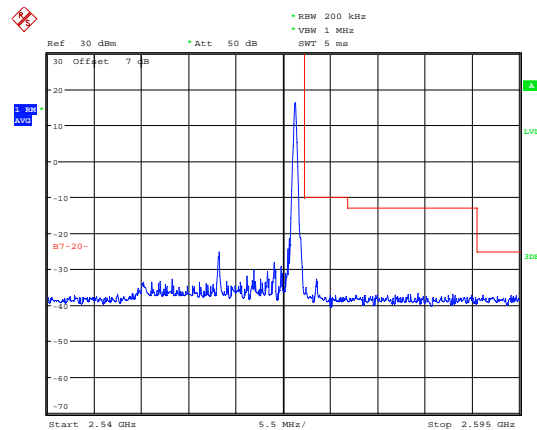

Date: 23.NOV.2019 10:52:00



LTE Band 7 16QAM 20MHz CH-Low, 100%RB

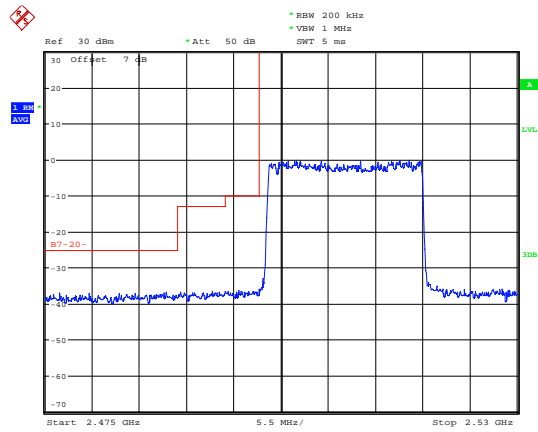

Date: 23.NOV.2019 10:45:18

LTE Band 7 16QAM 20MHz CH-High, 100%RB

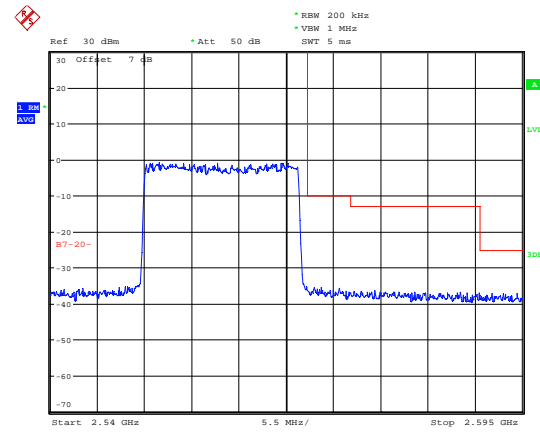

Date: 23.NOV.2019 10:52:12

LTE Band 7 64QAM 5MHz CH-Low, 1 RB

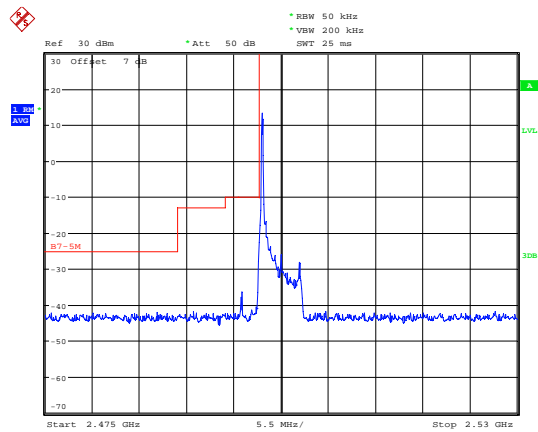

Date: 25.NOV.2019 14:06:09

LTE Band 7 64QAM 5MHz CH-High, 1 RB

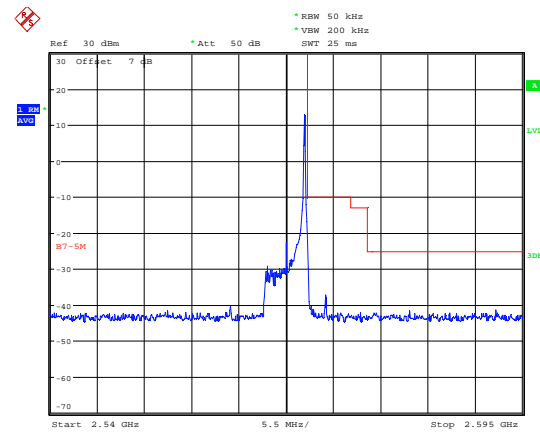

Date: 25.NOV.2019 14:11:27

LTE Band 7 64QAM 5MHz CH-Low, 100%RB

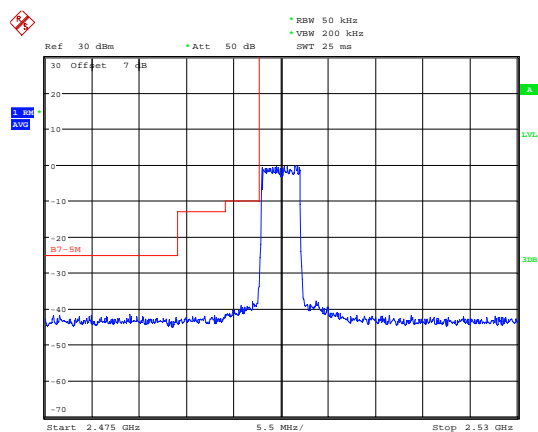

Date: 25.NOV.2019 14:06:26

LTE Band 7 64QAM 5MHz CH-High, 100%RB

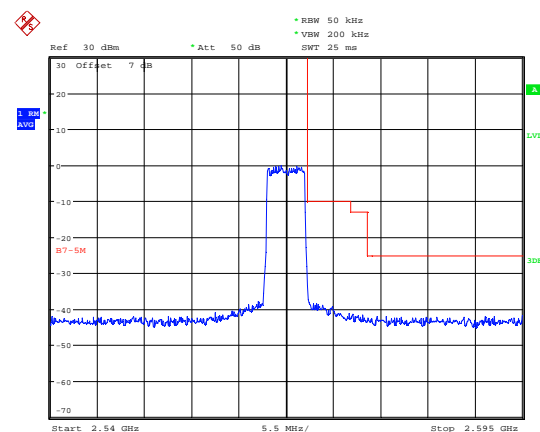

Date: 25.NOV.2019 14:11:42



LTE Band 7 64QAM 10MHz CH-Low, 1 RB

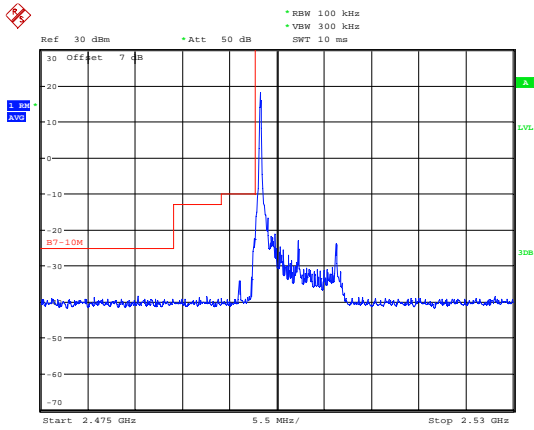

Date: 25.NOV.2019 14:07:31

LTE Band 7 64QAM 10MHz CH-High, 1 RB

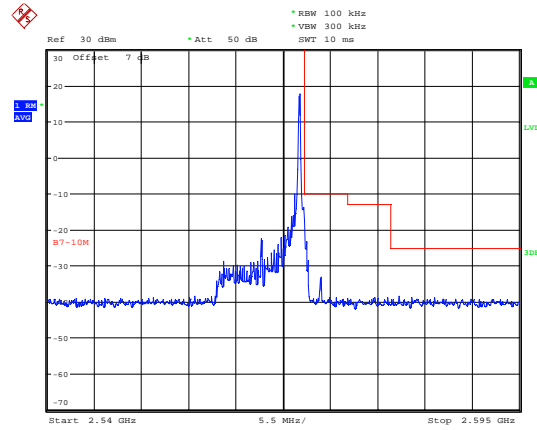

Date: 25.NOV.2019 14:12:35

LTE Band 7 64QAM 10MHz CH-Low, 100%RB

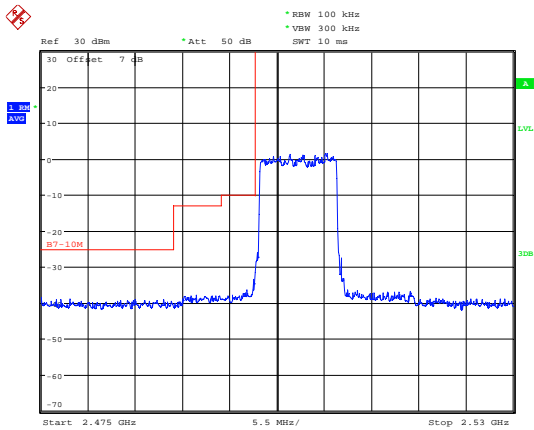

Date: 25.NOV.2019 14:07:44

LTE Band 7 64QAM 10MHz CH-High, 100%RB

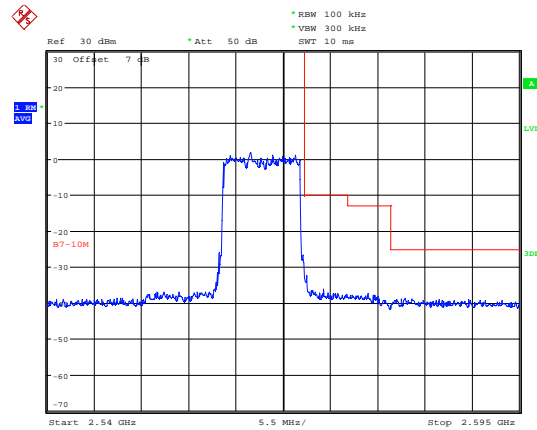

Date: 25.NOV.2019 14:12:49

LTE Band 7 64QAM 15MHz CH-Low, 1 RB

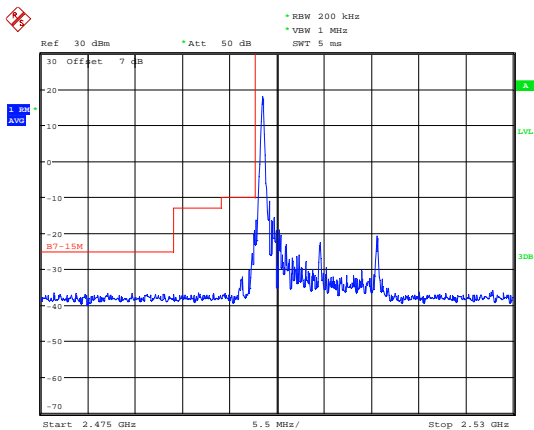

Date: 25.NOV.2019 14:08:57

LTE Band 7 64QAM 15MHz CH-High, 1 RB

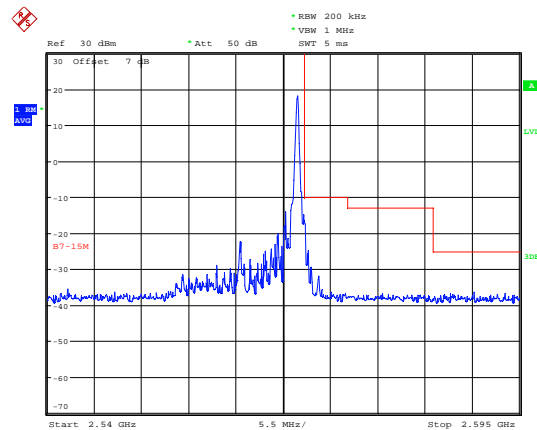

Date: 25.NOV.2019 14:14:06



LTE Band 7 64QAM 15MHz CH-Low, 100%RB

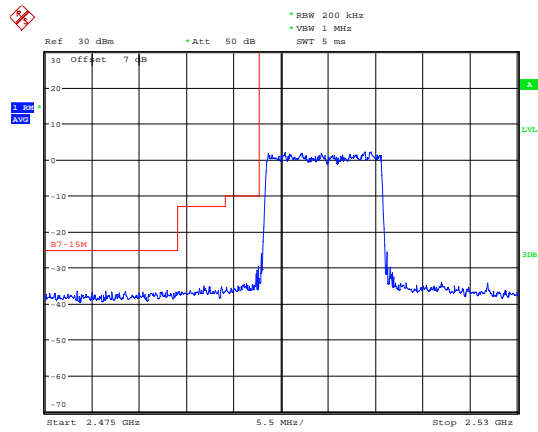

Date: 25.NOV.2019 14:09:11

LTE Band 7 64QAM 15MHz CH-High, 100%RB

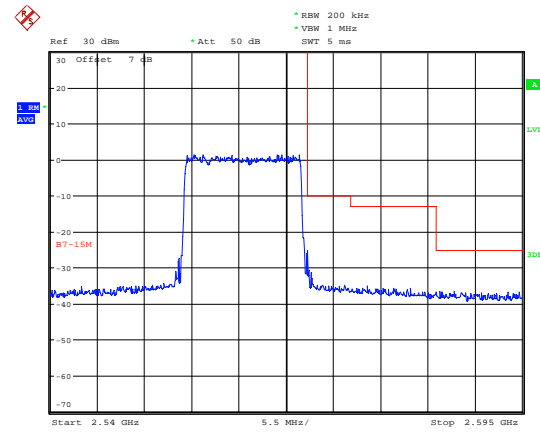

Date: 25.NOV.2019 14:14:20

LTE Band 7 64QAM 20MHz CH-Low, 1 RB

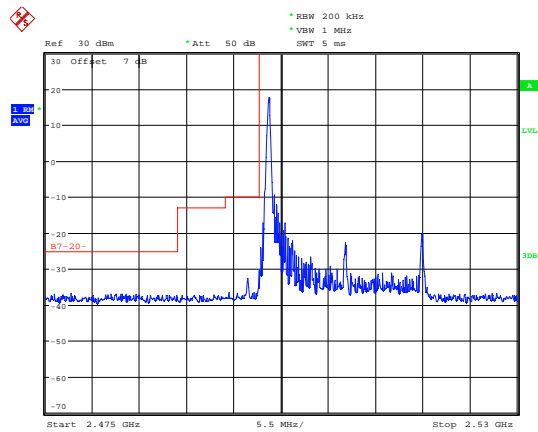

Date: 25.NOV.2019 14:09:54

LTE Band 7 64QAM 20MHz CH-High, 1 RB

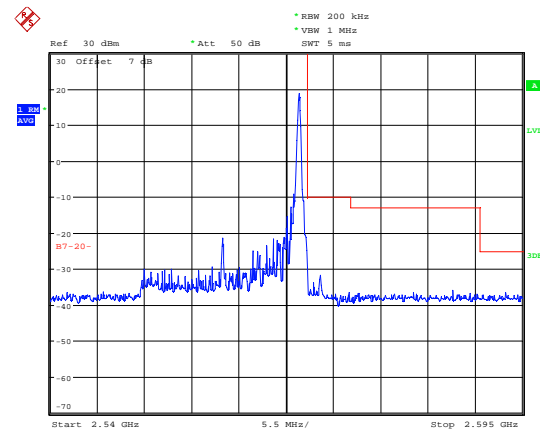

Date: 25.NOV.2019 14:15:10

LTE Band 7 64QAM 20MHz CH-Low, 100%RB

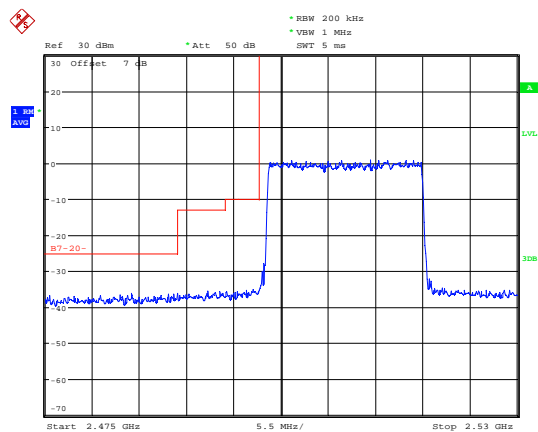

Date: 25.NOV.2019 14:10:09

LTE Band 7 64QAM 20MHz CH-High, 100%RB

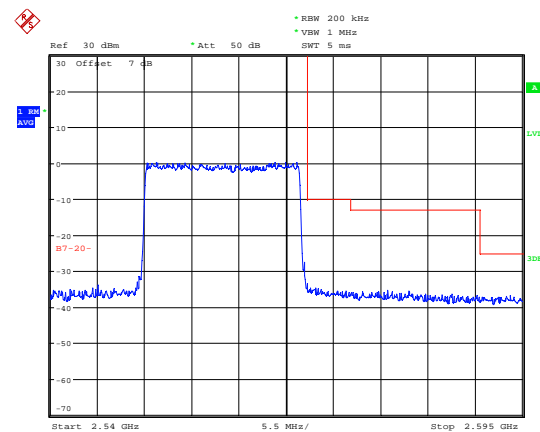

Date: 25.NOV.2019 14:15:24

5.4 Peak-to-Average Power Ratio (PAPR)

Ambient condition

Temperature	Relative humidity	Pressure
23°C ~25°C	45%~50%	101.5kPa

Methods of Measurement

Measure the total peak power and record as Ppk. And measure the total average power and record as PAvg. Both the peak and average power levels must be expressed in the same logarithmic units (e.g., dBm). Determine the PAPR from:

$$PAPR (dB) = Ppk (dBm) - PAvg (dBm).$$

Test Setup

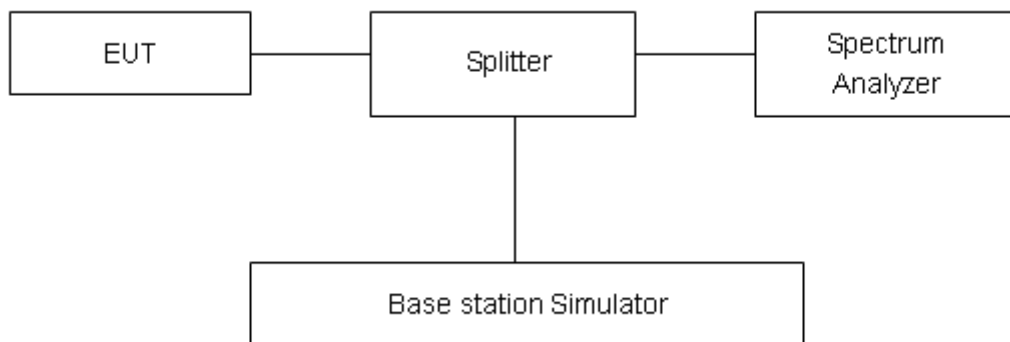

Limits

Rule Part 27.50(d)(5) Equipment employed must be authorized in accordance with the provisions of 24.51. Power measurements for transmissions by stations authorized under this section may be made either in accordance with a Commission-approved average power technique or in compliance with paragraph (d)(6) of this section. In measuring transmissions in this band using an average power technique, the peak-to-average ratio (PAR) of the transmission may not exceed 13 dB.

Measurement Uncertainty

The assessed measurement uncertainty to ensure 95% confidence level for the normal distribution is with the coverage factor $k = 2$, $U = 0.4$ dB.



Test Results

LTE Band 7								
Modulation	Bandwidth (MHz)	Channel	Frequency (MHz)	Peak (dBm)	Avg (dBm)	PAPR (dB)	Limit (dB)	Conclusion
QPSK	5	20775	2502.5	25.48	20.04	5.44	≤13	PASS
		21100	2535	25.34	19.56	5.78	≤13	PASS
		21425	2567.5	25.32	19.62	5.70	≤13	PASS
	10	20800	2505	25.55	19.98	5.57	≤13	PASS
		21100	2535	25.34	19.59	5.75	≤13	PASS
		21400	2565	25.40	19.71	5.69	≤13	PASS
	15	20825	2507.5	26.16	20.27	5.89	≤13	PASS
		21100	2535	25.73	19.65	6.08	≤13	PASS
		21375	2562.5	25.78	19.74	6.04	≤13	PASS
	20	20850	2510	26.02	20.32	5.70	≤13	PASS
		21100	2535	25.48	19.67	5.81	≤13	PASS
		21350	2560	25.62	19.83	5.79	≤13	PASS
16QAM	5	20775	2502.5	25.44	19.13	6.31	≤13	PASS
		21100	2535	25.22	18.79	6.43	≤13	PASS
		21425	2567.5	25.21	18.80	6.41	≤13	PASS
	10	20800	2505	25.44	19.15	6.29	≤13	PASS
		21100	2535	25.25	18.82	6.43	≤13	PASS
		21400	2565	25.04	18.64	6.40	≤13	PASS
	15	20825	2507.5	25.82	19.44	6.38	≤13	PASS
		21100	2535	25.38	18.88	6.50	≤13	PASS
		21375	2562.5	25.21	18.68	6.53	≤13	PASS
	20	20850	2510	25.87	19.47	6.40	≤13	PASS
		21100	2535	25.37	18.90	6.47	≤13	PASS
		21350	2560	25.35	18.89	6.46	≤13	PASS
64QAM	5	20775	2502.5	25.46	19.20	6.26	≤13	PASS
		21100	2535	25.40	18.98	6.42	≤13	PASS
		21425	2567.5	25.27	18.85	6.42	≤13	PASS
	10	20800	2505	25.70	19.40	6.30	≤13	PASS
		21100	2535	25.46	19.05	6.41	≤13	PASS
		21400	2565	25.33	18.95	6.38	≤13	PASS
	15	20825	2507.5	26.07	19.72	6.35	≤13	PASS



		21100	2535	25.60	19.11	6.49	≤13	PASS
		21375	2562.5	25.36	18.86	6.50	≤13	PASS
	20	20850	2510	26.12	19.78	6.34	≤13	PASS
		21100	2535	25.64	19.17	6.47	≤13	PASS
		21350	2560	25.47	18.99	6.48	≤13	PASS

5.5 Frequency Stability

Ambient condition

Temperature	Relative humidity	Pressure
23°C ~25°C	45%~50%	101.5kPa

Method of Measurement

Frequency Stability (Temperature Variation)

The temperature inside the climate chamber is varied from -30°C to +55°C in 10°C step size.

(1) With all power removed, the temperature was decreased to -10°C and permitted to stabilize for three hours.

(2) Measure the carrier frequency with the test equipment in a “call mode”. These measurements should be made within 1 minute of powering up the mobile station, to prevent significant self warming.

(3) Repeat the above measurements at 10°C increments from -30°C to +55°C. Allow at least 1.5 hours at each temperature, un-powered, before making measurements.

Frequency Stability (Voltage Variation)

The frequency stability shall be measured with variation of primary supply voltage as follows:

(1) Vary primary supply voltage from 85 to 115 percent of the nominal value for other than hand carried battery equipment.

(2) For hand carried, battery powered equipment, reduce primary supply voltage to the battery-operating end point which shall be specified by the manufacturer.

This transceiver is specified to operate with an input voltage of between 3.6 V and 4.35 V, with a nominal voltage of 3.8V.

Test setup

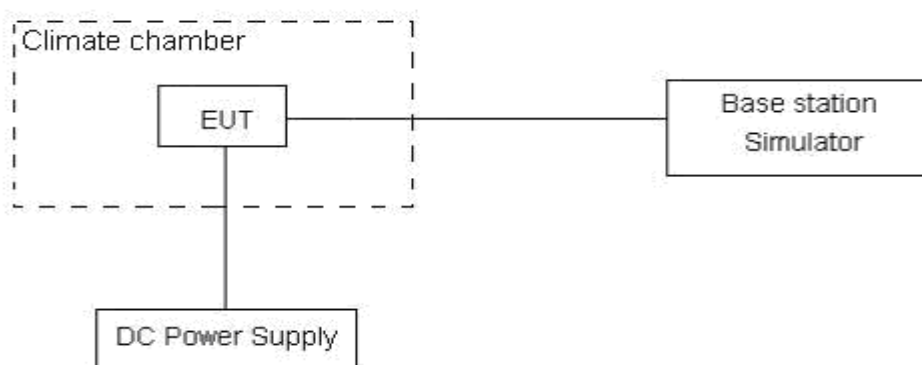

Limits

The frequency stability shall be sufficient to ensure that the fundamental emissions stay within the authorized bands of operation.

Measurement Uncertainty

The assessed measurement uncertainty to ensure 99.75% confidence level for the normal distribution is with the coverage factor $k = 3, U = 0.01\text{ppm}$.



Test Result

LTE Band 7								
Condition		Freq.Error	Freq.Error	Freq.Error	Frequency	Frequency	Frequency	Verdict
BANDWIDTH	5MHz	(Hz)	(Hz)	(Hz)	Stability	Stability	Stability	
Temperature	Voltage	64QAM	16QAM	QPSK	(ppm)	(ppm)	(ppm)	
Normal (25°C)	Normal	9.00	1.12	17.72	0.00478	0.00060	0.00943	PASS
Extreme (55°C)		17.63	4.63	16.44	0.00938	0.00246	0.00874	PASS
Extreme (50°C)		11.49	6.29	13.21	0.00611	0.00335	0.00703	PASS
Extreme (40°C)		14.20	5.24	2.01	0.00755	0.00279	0.00107	PASS
Extreme (30°C)		14.82	9.06	12.35	0.00788	0.00482	0.00657	PASS
Extreme (20°C)		13.40	15.05	15.58	0.00713	0.00801	0.00829	PASS
Extreme (10°C)		11.68	6.15	2.51	0.00621	0.00327	0.00133	PASS
Extreme (0°C)		6.90	8.19	9.40	0.00367	0.00436	0.00500	PASS
Extreme (-10°C)		12.49	8.10	5.32	0.00664	0.00431	0.00283	PASS
Extreme (-20°C)		2.12	14.44	10.54	0.00113	0.00768	0.00561	PASS
Extreme (-30°C)		7.46	11.43	16.70	0.00397	0.00608	0.00888	PASS
25°C	LV	3.25	15.56	15.80	0.00173	0.00828	0.00840	PASS
	HV	10.05	14.35	10.97	0.00534	0.00763	0.00584	PASS
Condition		Freq.Error	Freq.Error	Freq.Error	Frequency	Frequency	Frequency	Verdict
BANDWIDTH	10MHz	(Hz)	(Hz)	(Hz)	Stability	Stability	Stability	
Temperature	Voltage	64QAM	16QAM	QPSK	(ppm)	(ppm)	(ppm)	
Normal (25°C)	Normal	17.69	14.78	13.96	0.00941	0.00786	0.00743	PASS
Extreme (55°C)		9.43	17.98	2.59	0.00502	0.00957	0.00138	PASS
Extreme (50°C)		6.43	8.67	16.94	0.00342	0.00461	0.00901	PASS
Extreme (40°C)		2.69	16.17	14.80	0.00143	0.00860	0.00787	PASS
Extreme (30°C)		5.45	17.24	1.34	0.00290	0.00917	0.00071	PASS
Extreme (20°C)		14.83	5.20	4.70	0.00789	0.00277	0.00250	PASS
Extreme (10°C)		5.24	13.01	4.72	0.00279	0.00692	0.00251	PASS
Extreme (0°C)		4.66	10.81	16.07	0.00248	0.00575	0.00855	PASS
Extreme (-10°C)		17.32	14.31	4.39	0.00922	0.00761	0.00234	PASS
Extreme (-20°C)		5.67	14.17	13.66	0.00302	0.00754	0.00727	PASS
Extreme (-30°C)		14.19	16.86	1.63	0.00755	0.00897	0.00087	PASS
25°C	LV	8.87	16.07	7.49	0.00472	0.00855	0.00399	PASS
	HV	3.78	2.03	3.68	0.00201	0.00108	0.00196	PASS
Condition		Freq.Error	Freq.Error	Freq.Error	Frequency	Frequency	Frequency	Verdict
BANDWIDTH	15MHz	(Hz)	(Hz)	(Hz)	Stability	Stability	Stability	
Temperature	Voltage	64QAM	16QAM	QPSK	(ppm)	(ppm)	(ppm)	
		64QAM	16QAM	QPSK	64QAM	16QAM	QPSK	



Normal (25°C)	Normal	17.51	17.86	6.97	0.00932	0.00950	0.00371	PASS
Extreme (55°C)		4.37	16.98	11.32	0.00233	0.00903	0.00602	PASS
Extreme (50°C)		1.12	10.39	17.77	0.00059	0.00553	0.00945	PASS
Extreme (40°C)		3.59	7.71	3.51	0.00191	0.00410	0.00187	PASS
Extreme (30°C)		5.38	10.14	9.13	0.00286	0.00540	0.00486	PASS
Extreme (20°C)		1.98	13.65	14.95	0.00105	0.00726	0.00795	PASS
Extreme (10°C)		14.76	11.89	1.07	0.00785	0.00632	0.00057	PASS
Extreme (0°C)		7.50	14.38	9.55	0.00399	0.00765	0.00508	PASS
Extreme (-10°C)		12.89	14.36	1.61	0.00686	0.00764	0.00086	PASS
Extreme (-20°C)		6.39	8.77	13.79	0.00340	0.00467	0.00734	PASS
Extreme (-30°C)		6.73	5.71	9.57	0.00358	0.00304	0.00509	PASS
25°C	LV	4.84	5.21	6.34	0.00258	0.00277	0.00337	PASS
	HV	16.39	2.89	12.94	0.00872	0.00154	0.00688	PASS
Condition		Freq.Error	Freq.Error	Freq.Error	Frequency	Frequency	Frequency	Verdict
BANDWIDTH	20MHz	(Hz)	(Hz)	(Hz)	Stability	Stability	Stability	
Temperature	Voltage	64QAM	16QAM	QPSK	(ppm)	(ppm)	(ppm)	
Normal (25°C)	Normal	11.63	17.28	7.08	0.00618	0.00919	0.00377	PASS
Extreme (55°C)		4.44	11.93	6.40	0.00236	0.00635	0.00340	PASS
Extreme (50°C)		9.91	8.46	3.61	0.00527	0.00450	0.00192	PASS
Extreme (40°C)		8.18	9.59	14.33	0.00435	0.00510	0.00762	PASS
Extreme (30°C)		4.59	17.31	3.95	0.00244	0.00920	0.00210	PASS
Extreme (20°C)		10.99	5.05	5.15	0.00584	0.00268	0.00274	PASS
Extreme (10°C)		12.64	2.85	13.64	0.00672	0.00152	0.00726	PASS
Extreme (0°C)		5.01	13.12	16.69	0.00267	0.00698	0.00888	PASS
Extreme (-10°C)		14.25	13.90	11.58	0.00758	0.00739	0.00616	PASS
Extreme (-20°C)		2.40	17.08	2.30	0.00128	0.00909	0.00122	PASS
Extreme (-30°C)		4.91	9.86	3.58	0.00261	0.00525	0.00190	PASS
25°C	LV	13.64	6.45	3.18	0.00725	0.00343	0.00169	PASS
	HV	10.50	8.05	7.94	0.00559	0.00428	0.00423	PASS

5.6 Spurious Emissions at Antenna Terminals

Ambient condition

Temperature	Relative humidity	Pressure
23°C ~25°C	45%~50%	101.5kPa

Method of Measurement

The EUT was connected to Spectrum Analyzer and Base Station Simulator via power Splitter. The measurement is carried out using a spectrum analyzer. The spectrum analyzer scans from 9kHz to the 10th harmonic of the carrier. The peak detector is used.

RBW is set to 100kHz, VBW is set to 300kHz for 30MHz~1GHz

RBW is set to 1MHz, VBW is set to 3MHz for above 1GHz, Sweep is set to ATUO.

Of those disturbances below (limit – 20 dB), the mark is not required for the EUT.

The modulation mode and RB allocation refer to section 5.1, using the maximum output power configuration.

Test setup

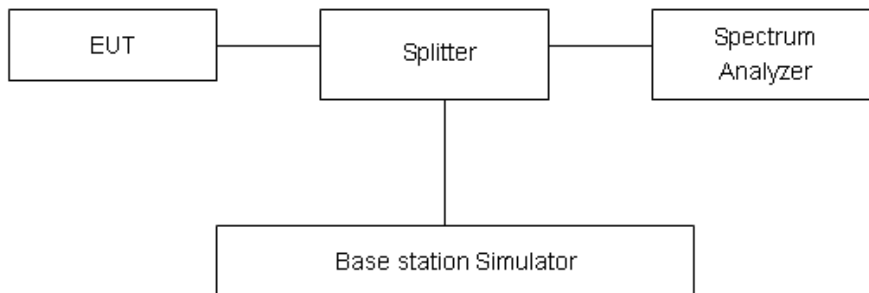

Limits

LTE -7 Rule Part 27.53(m) $55 + 10 \log (P)$ dB on all frequencies more than X megahertz from the channel edge, where X is the greater of 6 megahertz or the actual emission bandwidth as defined in paragraph (m)(4) of this section.

Part 27.53(m) Limit	-25 dBm
---------------------	---------

Measurement Uncertainty

The assessed measurement uncertainty to ensure 99.75% confidence level for the normal distribution is with the coverage factor $k = 1.96$.

Frequency	Uncertainty
9kHz-1GHz	0.684 dB



1GHz-27GHz	1.407 dB
------------	----------



Test Result

Sweep the whole frequency band through the range from 9kHz to the 10th harmonic of the carrier, the emissions more than 20 dB below the limit are not reported.

The signal beyond the limit is carrier.

LTE Band 7 5MHz CH-Low 9kHz~26GHz

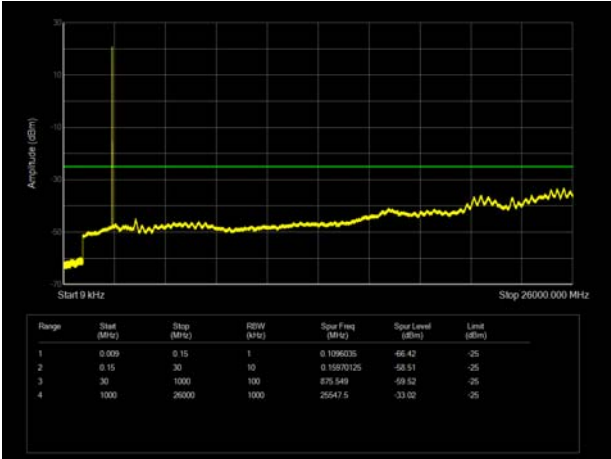

LTE Band 7 10MHz CH-Low 9kHz~26GHz

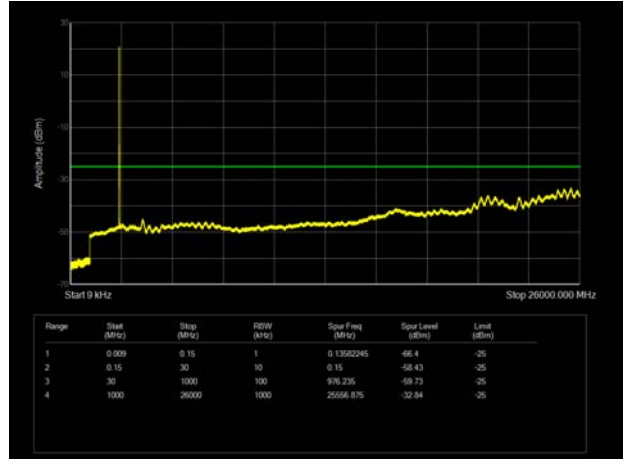

LTE Band 7 5MHz CH-Middle 9kHz~26GHz

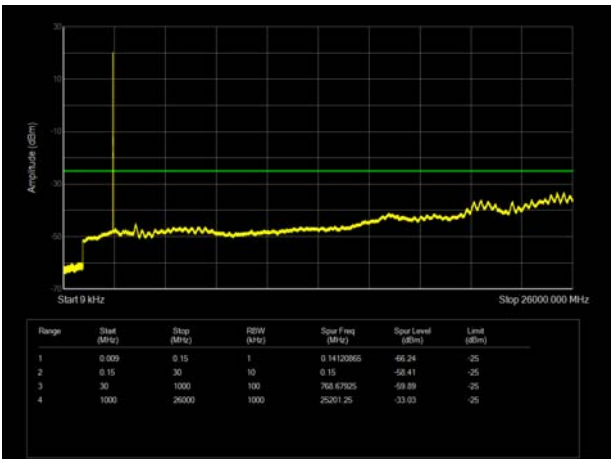

LTE Band 7 10MHz CH-Middle 9kHz~26GHz

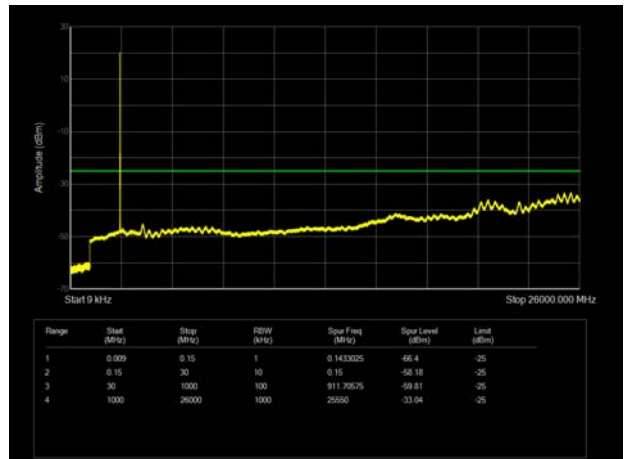

LTE Band 7 5MHz CH-High 9kHz~26GHz

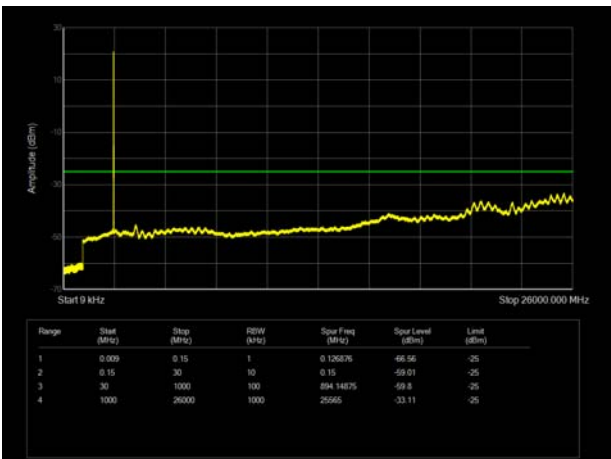

LTE Band 7 10MHz CH-High 9kHz~26GHz

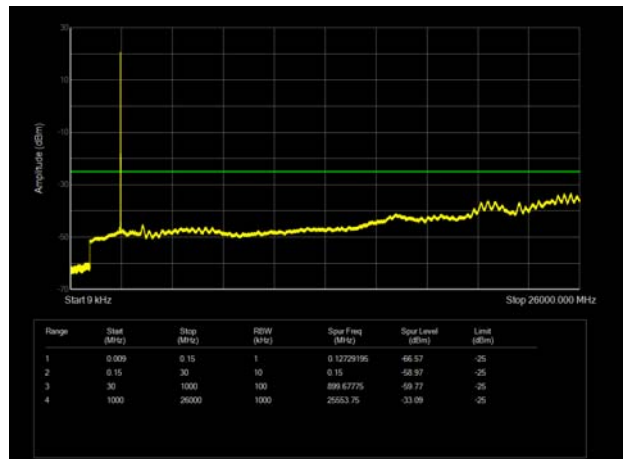



LTE Band 7 15MHz CH-Low 9kHz~26GHz

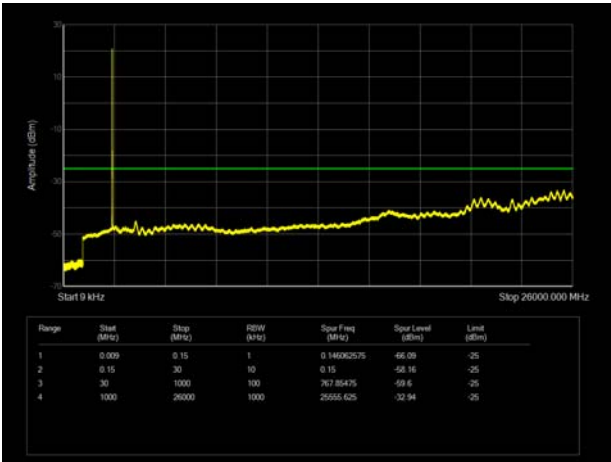

LTE Band 7 20MHz CH-Low 9kHz~26GHz

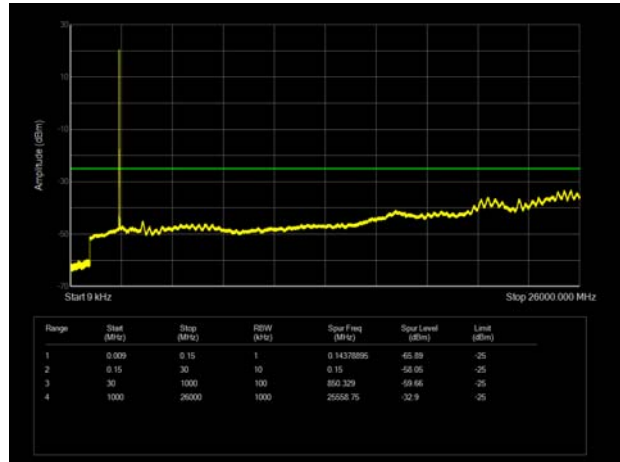

LTE Band 7 15MHz CH-Middle 9kHz~26GHz

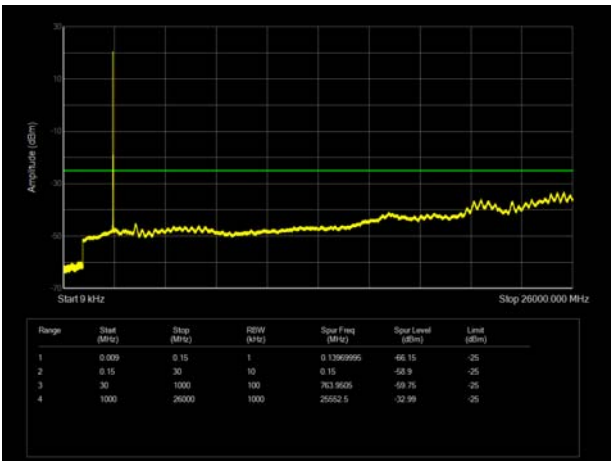

LTE Band 7 20MHz CH-Middle 9kHz~26GHz

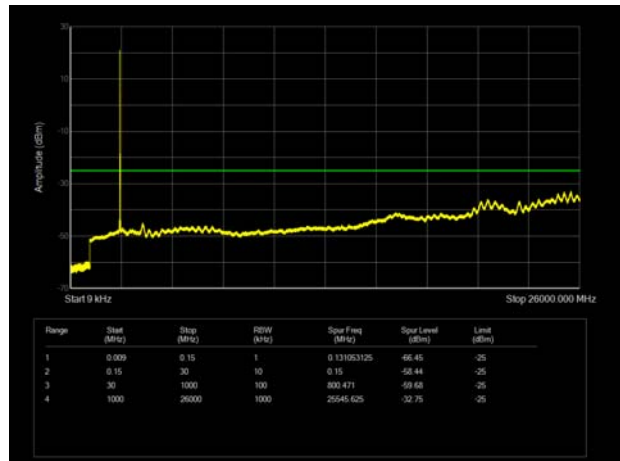

LTE Band 7 15MHz CH-High 9kHz~26GHz

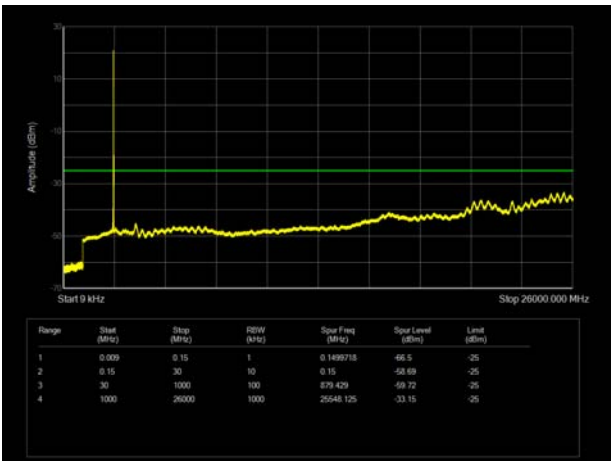

LTE Band 7 20MHz CH-High 9kHz~26GHz

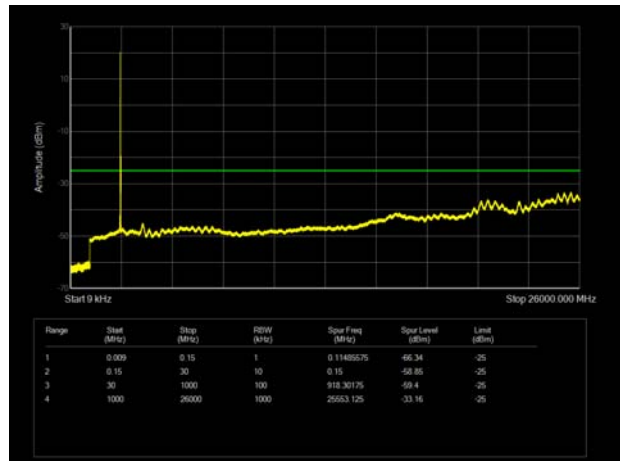

5.7 Radiates Spurious Emission

Ambient condition

Temperature	Relative humidity	Pressure
23°C ~25°C	45%~50%	101.5kPa

Method of Measurement

1. The testing follows FCC KDB 971168 D01 v03r01 Section 5.8 and ANSI C63.26 (2015).
2. Below 1GHz: The EUT is placed on a turntable 0.8 meters above the ground in the chamber, 3 meter away from the antenna. The maximal emission value is acquired by adjusting the antenna height, polarisation and turntable azimuth. Normally, the height range of antenna is 1 m to 4 m, the azimuth range of turntable is 0° to 360°, and the receive antenna has two polarizations Vertical (V) and Horizontal (H). Above 1GHz: (Note: the FCC's permission to use 1.5m as an alternative per TCBC Conf call of Dec. 2, 2014.) The EUT is placed on a turntable 1.5 meters above the ground in the chamber, 3 meter away from the antenna. The maximal emission value is acquired by adjusting the antenna height, polarisation and turntable azimuth. Normally, the height range of antenna is 1 m to 4 m, the azimuth range of turntable is 0° to 360°, and the receive antenna has two polarizations Vertical (V) and Horizontal (H).
3. A loop antenna, A log-periodic antenna or horn antenna shall be substituted in place of the EUT. The log-periodic antenna will be driven by a signal generator and the level will be adjusted till the same power value on the spectrum analyzer or receiver. The level of the spurious emissions can be calculated through the level of the signal generator, cable loss, the gain of the substitution antenna and the reading of the spectrum analyzer or receiver.
4. The EUT is then put into continuously transmitting mode at its maximum power level during the test. Set Test Receiver or Spectrum RBW=200Hz,VBW=600Hz for 9kHz150kHz , RBW=10kHz, VBW=30kHz 150kHz-30MHz ,RBW=100kHz,VBW=300kHz for 30MHz to 1GHz and RBW=1MHz, VBW=3MHz for above 1GHz And the maximum value of the receiver should be recorded as (Pr).
5. The EUT shall be replaced by a substitution antenna. In the chamber, an substitution antenna for the frequency band of interest is placed at the reference point of the chamber. An RF Signal source for the frequency band of interest is connected to the substitution antenna with a cable that has been constructed to not interfere with the radiation pattern of the antenna. A power (PMea) is applied to the input of the substitution antenna, and adjust the level of the signal generator output until the value of the receiver reach the previously recorded (Pr). The power of signal source (PMea) is recorded. The test should be performed by rotating the test item and adjusting the receiving antenna polarization.
6. A amplifier should be connected to the Signal Source output port. And the cable should be connect between the Amplifier and the Substitution Antenna. The cable loss (Pcl) ,the Substitution Antenna Gain (Ga) and the Amplifier Gain (PAg) should be recorded after test.
7. The measurement results are obtained as described below:
Power(EIRP)=PMea- PAg - Pcl + Ga
The measurement results are amend as described below:
Power(EIRP)=PMea- Pcl + Ga
8. This value is EIRP since the measurement is calibrated using an antenna of known gain (2.15 dBi) and known input power. ERP can be calculated from EIRP by subtracting the gain of the dipole, ERP

= EIRP-2.15dBi.

The modulation mode and RB allocation refer to section 5.1, using the maximum output power configuration.

Test setup

9KHz ~ 30MHz

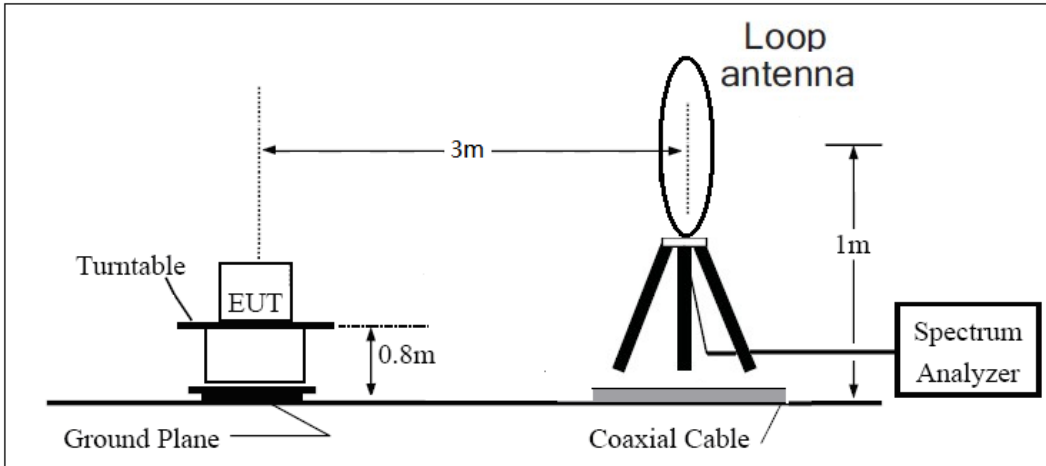

30MHz ~ 1GHz

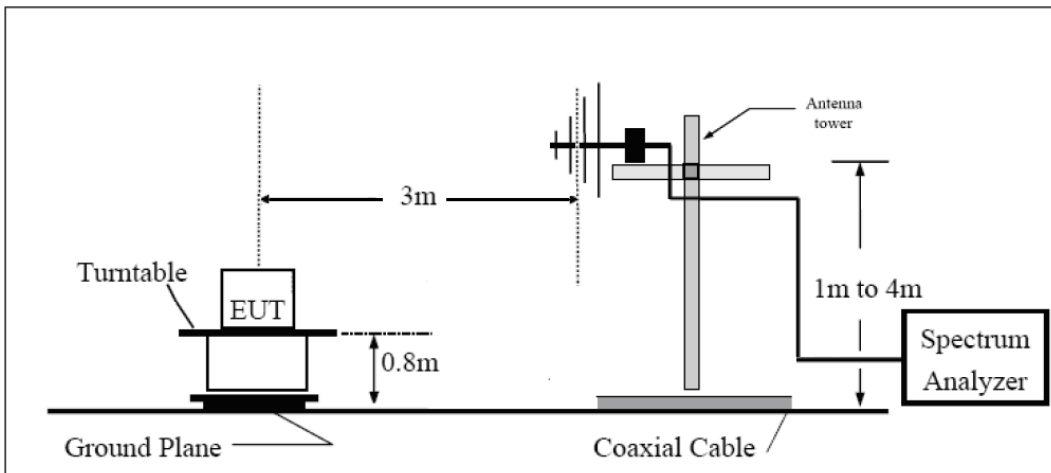

Above 1GHz

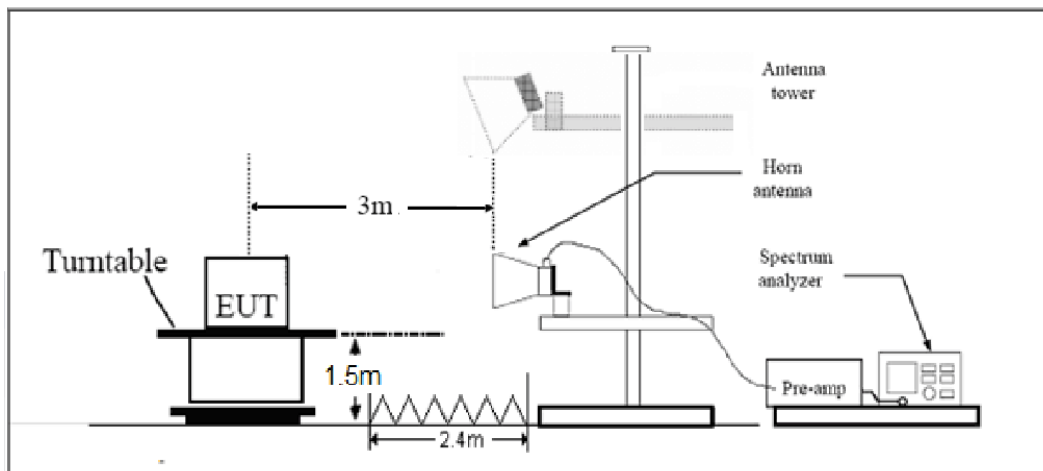

Note: Area side:2.4mX3.6m

**Limits**

Rule Part 27.53(m) $55 + 10 \log (P)$ dB on all frequencies more than X megahertz from the channel edge, where X is the greater of 6 megahertz or the actual emission bandwidth as defined in paragraph (m)(4) of this section.

Part 27.53(m) Limit	-25 dBm
---------------------	---------

Measurement Uncertainty

The assessed measurement uncertainty to ensure 95% confidence level for the normal distribution is with the coverage factor $k = \pm 1.96$, $U = \pm 3.55$ dB.

**Test Result**

Sweep the whole frequency band through the range from 9kHz to the 10th harmonic of the carrier, the emissions below the noise floor will not be recorded in the report.

LTE Band 7 QPSK 5MHz CH-Middle, RB 1

Harmonic	Frequency (MHz)	SG (dBm)	Cable Loss (dB)	Gain (dBi)	Antenna Polarization	EIRP Level (dBm)	Limit (dBm)	Margin (dB)	Azimuth (deg)
2	5065.8	-59.00	2.00	9.15	Horizontal	-51.85	-25.00	26.85	45
3	7598.6	-56.61	2.50	11.35	Horizontal	-47.76	-25.00	22.76	90
4	10130.6	-49.98	4.20	12.05	Horizontal	-42.13	-25.00	17.13	135
5	12675.0	-51.09	5.20	12.85	Horizontal	-43.44	-25.00	18.44	270
6	15210.0	-54.63	5.50	14.23	Horizontal	-45.90	-25.00	20.90	0
7	17745.0	-52.21	5.70	14.15	Horizontal	-43.76	-25.00	18.76	135
8	20280.0	--	--	--	--	--	--	--	--
9	22815.0	--	--	--	--	--	--	--	--
10	25350.0	--	--	--	--	--	--	--	--

Note: 1.The other Spurious RF Radiated emissions level is no more than noise floor.

2. The worst emission was found in the antenna is Horizontal position.

LTE Band 7 QPSK 20MHz CH-Middle, RB 1

Harmonic	Frequency (MHz)	SG (dBm)	Cable Loss (dB)	Gain (dBi)	Antenna Polarization	EIRP Level (dBm)	Limit (dBm)	Margin (dB)	Azimuth (deg)
2	5052.4	-61.75	2.00	10.15	Horizontal	-53.60	-25.00	28.60	0
3	7605.0	-52.45	2.50	11.35	Horizontal	-43.60	-25.00	18.60	45
4	10140.0	-53.45	4.20	12.05	Horizontal	-45.60	-25.00	20.60	135
5	12675.0	-54.85	5.20	14.85	Horizontal	-45.20	-25.00	20.20	90
6	15210.0	-53.43	5.50	13.23	Horizontal	-45.70	-25.00	20.70	225
7	17745.0	-49.85	5.70	12.15	Horizontal	-43.40	-25.00	18.40	135
8	20280.0	--	--	--	--	--	--	--	--
9	22815.0	--	--	--	--	--	--	--	--
10	25350.0	--	--	--	--	--	--	--	--

Note: 1.The other Spurious RF Radiated emissions level is no more than noise floor.

2. The worst emission was found in the antenna is Horizontal position.



6 Main Test Instruments

Name	Manufacturer	Type	Serial Number	Calibration Date	Expiration Date
Base Station Simulator	R&S	CMW500	113824	2019-05-19	2020-05-18
Power Splitter	Hua Xiang	SHX-GF2-2-13	10120101	/	/
Spectrum Analyzer	Key sight	N9010A	MY50210259	2019-05-19	2020-05-18
Signal Analyzer	R&S	FSV30	100815	2018-12-16	2019-12-15
Loop Antenna	SCHWARZBECK	FMZB1519	1519-047	2017-09-26	2020-09-25
Trilog Antenna	SCHWARZBECK	VUBL 9163	9163-201	2017-11-18	2020-11-17
Horn Antenna	R&S	HF907	100126	2018-07-07	2020-07-06
Horn Antenna	ETS-Lindgren	3160-09	00102643	2018-06-20	2020-06-19
Signal generator	R&S	SMB 100A	102594	2019-05-19	2020-05-18
Climatic Chamber	ESPEC	SU-242	93000506	2017-12-17	2020-12-16
Preamplifier	R&S	SCU18	102327	2019-05-19	2020-05-18
MOB COMMS DC SUPPLY	Keysight	66319D	MY43004105	2019-05-19	2020-05-18
RF Cable	Agilent	SMA 15cm	0001	2019-06-14	2019-12-13
Software	R&S	EMC32	9.26.0	/	/

*****END OF REPORT *****