



RF TEST REPORT

Applicant	ZTE Corporation
FCC ID	SRQ-MF928
Product	LTE ufi Hotspot
Model	MF928
Report No.	R2006A0416-R2
Issue Date	July 16, 2020

TA Technology (Shanghai) Co., Ltd. tested the above equipment in accordance with the requirements in **FCC CFR47 Part 2 (2019)/ FCC CFR 47 Part 24E (2019)**. The test results show that the equipment tested is capable of demonstrating compliance with the requirements as documented in this report.

Performed by: Peng Tao

Approved by: Kai Xu

TA Technology (Shanghai) Co., Ltd.

No.145, Jintang Rd, Tangzhen Industry Park, Pudong Shanghai, China

TEL: +86-021-50791141/2/3

FAX: +86-021-50791141/2/3-8000



TABLE OF CONTENT

1. Test Laboratory	4
1.1. Notes of the test report.....	4
1.2. Testing Location	4
2. General Description of Equipment under Test.....	5
2.1. Applicant and Manufacturer Information	5
2.2. General information.....	5
3. Applied Standards.....	7
4. Test Configuration.....	8
5. Test Case Results.....	9
5.1. RF Power Output and Effective Radiated Power	9
5.2. Occupied Bandwidth	17
5.3. Band Edge Compliance.....	26
5.4. Peak-to-Average Power Ratio (PAPR)	35
5.5. Frequency Stability.....	37
5.6. Spurious Emissions at Antenna Terminals	40
5.7. Radiates Spurious Emission	50
6. Main Test Instruments	62



Summary of measurement results

No.	Test Case	Clause in FCC rules	Verdict
1	RF Power Output and Effective Isotropic Radiated Power	2.1046 24.232(c)	PASS
2	Occupied Bandwidth	2.1049	PASS
3	Band Edge Compliance	2.1051 /24.238(a)	PASS
4	Peak-to-Average Power Ratio	24.232/KDB 971168 D01(5.7)	PASS
5	Frequency Stability	2.1055 / 24.235	PASS
6	Spurious Emissions at Antenna Terminals	2.1051 / 24.238(a)	PASS
7	Radiates Spurious Emission	2.1053 / 24.238(a)	PASS

Date of Testing: March 9, 2018 ~ March 27, 2018 and June 23, 2020 ~ July 14, 2020

Note: PASS: The EUT complies with the essential requirements in the standard.
FAIL: The EUT does not comply with the essential requirements in the standard.
All indications of Pass/Fail in this report are opinions expressed by TA Technology (Shanghai) Co., Ltd. based on interpretations and/or observations of test results. Measurement Uncertainties were not taken into account and are published for informational purposes only.



1. Test Laboratory

1.1. Notes of the test report

This report shall not be reproduced in full or partial, without the written approval of **TA technology (shanghai) co., Ltd.** The results documented in this report apply only to the tested sample, under the conditions and modes of operation as described herein. Measurement Uncertainties were not taken into account and are published for informational purposes only. This report is written to support regulatory compliance of the applicable standards stated above.

1.2. Test facility

FCC (Designation number: CN1179, Test Firm Registration Number: 446626)

TA Technology (Shanghai) Co., Ltd. has been listed on the US Federal Communications Commission list of test facilities recognized to perform electromagnetic emissions measurements.

A2LA (Certificate Number: 3857.01)

TA Technology (Shanghai) Co., Ltd. has been listed by American Association for Laboratory Accreditation to perform electromagnetic emission measurement.

1.3. Testing Location

Company: TA Technology (Shanghai) Co., Ltd.
Address: No.145, Jintang Rd, Tangzhen Industry Park, Pudong
City: Shanghai
Post code: 201201
Country: P. R. China
Contact: Xu Kai
Telephone: +86-021-50791141/2/3
Fax: +86-021-50791141/2/3-8000
Website: <http://www.ta-shanghai.com>
E-mail: xukai@ta-shanghai.com

2. General Description of Equipment under Test

2.3. Applicant and Manufacturer Information

Applicant	ZTE Corporation
Applicant address	ZTE Plaza, Keji Road South, Hi-Tech, Industrial Park, Nanshan District, Shenzhen, Guangdong, 518057, P.R.China
Manufacturer	ZTE Corporation
Manufacturer address	ZTE Plaza, Keji Road South, Hi-Tech, Industrial Park, Nanshan District, Shenzhen, Guangdong, 518057, P.R.China

2.4. General information

EUT Description			
Model	MF928		
IMEI	866987050000794		
Hardware Version	MF928-1.0.0		
Software Version	BD_RWMF928V0.0.0B02		
Power Supply	Battery/AC adapter		
Antenna Type	Internal Antenna		
Antenna Gain	2.23 dBi		
Test Mode(s)	LTE Band 2;		
Test Modulation	(LTE)QPSK,16QAM		
LTE Category	4		
Maximum E.I.R.P	LTE Band 2:	25.73 dBm	
Rated Power Supply Voltage	3.8V		
Extreme Voltage	Minimum: 3.4V Maximum: 4.35V		
Extreme Temperature	Lowest: -20°C Highest: +55°C		
Frequency Range(s)	Band	Tx (MHz)	Rx (MHz)
	LTE Band 2	1850 ~ 1910	1930 ~ 1990
EUT Accessory			
Adapter 1	Manufacturer: DONGGUAN AOHAJ POWER TECHNOLOGY CO., LTD. Model: STC-A51D-Z		
Adapter 2	Manufacturer: SHENZHEN RUIJING INDUSTRIAL CO LTD Model: STC-A51D-Z		
Battery	Manufacturer: HARBIN COSLIGHT POWER CO LTD Model: Li3820T43P3h715345		
USB Cable 1	Manufacturer: LUXSHARE-ICT 100cm Cable, Shielded		
USB Cable 2	Manufacturer: kingpower-tech 100cm Cable, Shielded		



Note: 1. The EUT is sent from the applicant to TA and the information of the EUT is declared by the applicant.

2. There is more than USB cable, each one should be applied throughout the compliance test respectively, and however, only the worst case (USB cable 1) will be recorded in this report.

3. Applied Standards

According to the specifications of the manufacturer, it must comply with the requirements of the following standards:

Test standards:

FCC CFR 47 Part 24E (2019)

ANSI C63.26 (2015)

Reference standard:

FCC CFR47 Part 2 (2019)

KDB 971168 D01 Power Meas License Digital Systems v03r01

4. Test Configuration

Radiated measurements are performed by rotating the EUT in three different orthogonal test planes. EUT stand-up position (Z axis), lie-down position (X, Y axis). Receiver antenna polarization (horizontal and vertical), the worst emission was found in position (Z axis, horizontal polarization) and the worst case was recorded.

All mode and data rates and positions and RB size and modulations were investigated.

Subsequently, only the worst case emissions are reported.

The following testing in LTE is set based on the maximum RF Output Power.

Test modes are chosen to be reported as the worst case configuration below for LTE Band 2:

Test items	Bandwidth (MHz)						Modulation		RB			Test Channel		
	1.4	3	5	10	15	20	QPSK	16QAM	1	50%	100%	L	M	H
RF Power Output and Effective Isotropic Radiated Power	O	O	O	O	O	O	O	O	O	O	O	O	O	O
Occupied Bandwidth	O	O	O	O	O	O	O	O	-	-	O	O	O	O
Band Edge Compliance	O	O	O	O	O	O	O	O	O	-	O	O	-	O
Peak-to-Average Power Ratio	O	O	O	O	O	O	O	O	-	-	O	O	O	O
Frequency Stability	O	O	O	O	O	O	O	O	O	O	O	O	O	O
Conducted Spurious Emissions	O	O	O	O	O	O	O	-	O	-	-	O	O	O
Radiates Spurious Emission	O	-	O	-	-	O	O	-	O	-	-	O	O	O
Note	1. The mark "O" means that this configuration is chosen for testing. 2. The mark "-" means that this configuration is not testing.													

5. Test Case Results

5.1.RF Power Output and Effective Isotropic Radiated Power

Ambient condition

Temperature	Relative humidity	Pressure
23°C ~25°C	45%~50%	101.5kPa

Methods of Measurement

During the process of the testing, The EUT is controlled by the Base Station Simulator to ensure max power transmission and proper modulation.

The testing follows FCC KDB 971168 v03r01 Section 5.8 and ANSI C63.26 (2015).

- a) Connect the equipment as illustrated. Mount the equipment with the manufacturer specified antenna in a vertical orientation on a manufacturer specified mounting surface located on a non-conducting rotating platform of a RF anechoic chamber (preferred) or a standard radiation site.
- b) Key the transmitter, then rotate the EUT 360° azimuthally and record spectrum analyzer power level (LVL) measurements at angular increments that are sufficiently small to permit resolution of all peaks. If a standard radiation test site is used, raise and lower the test antenna to obtain a maximum reading at each angular increment. (Note: several batteries may be needed to offset the effect of battery voltage droop, which should not exceed 5% of the manufactured specified battery voltage during transmission).
- c) Replace the transmitter under test with a vertically polarized half-wave dipole (or an antenna whose gain is known relative to an ideal half-wave dipole). The center of the antenna should be at the same location as the center of the antenna under test.
- d) Connect the antenna to a signal generator with a known output power and record the path loss (in dB) as LOSS. If a standard radiation test site is used, raise and lower the test antenna to obtain a maximum reading. $LOSS = \text{Generator Output Power (dBm)} - \text{Analyzer reading (dBm)}$
- e) Determine the effective radiated output power at each angular position from the readings in steps b) and d) using the following equation: $ERP \text{ (dBm)} = \text{LVL (dBm)} + \text{LOSS (dB)}$
- f) The maximum ERP is the maximum value determined in the preceding step.
- g) When calculating ERP, in addition to knowing the antenna radiation and matching characteristics, it is necessary to know the loss values of all elements (e.g.transmission line attenuation, mismatches, filters, combiners) interposed between the point where transmitter output power is measured, and the point where power is applied to the antenna. ERP can then be calculated as follows:
 $EIRP \text{ (dBm)} = \text{Output Power (dBm)} - \text{Losses (dB)} + \text{Antenna Gain (dBi)}$
where:dBd refers to gain relative to an ideal dipole.
 $EIRP \text{ (dBm)} = ERP \text{ (dBm)} + 2.15 \text{ (dB.)}$

The RB allocation refers to section 5.1, using the maximum output power configuration.

Test Setup

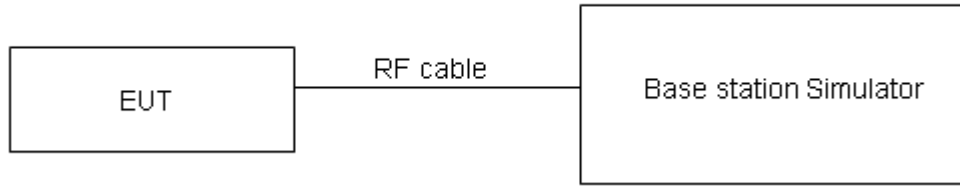

The loss between RF output port of the EUT and the input port of the tester has been taken into consideration.

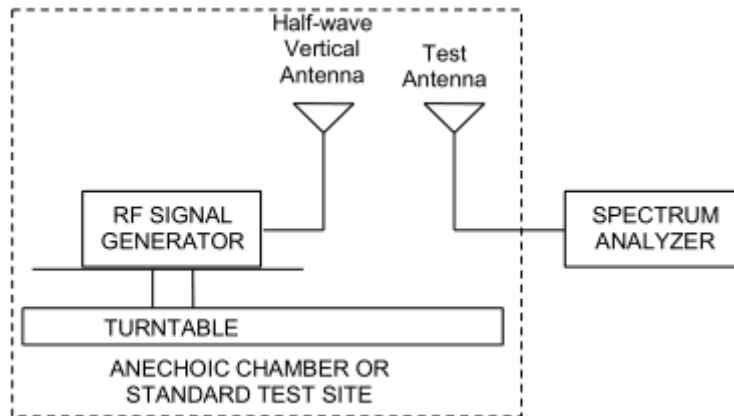
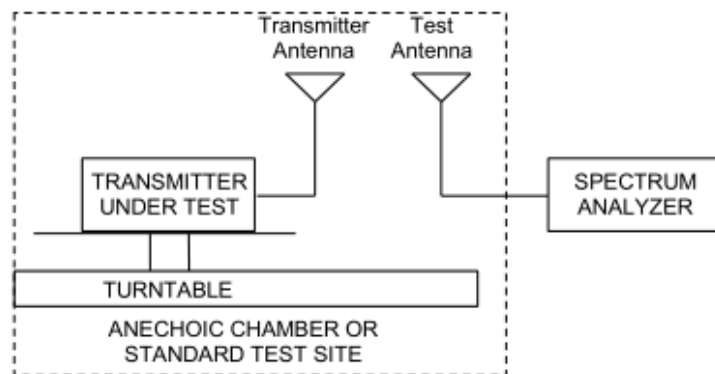

Limits

No specific RF power output requirements in part 2.1046.

Rule Part 24.232(c) Mobile and portable stations are limited to 2 watts EIRP.

Rule Part 24.232(e) Peak transmit power must be measured over any interval of continuous transmission using instrumentation calibrated in terms of an rms-equivalent voltage.

Limit	$\leq 2\text{ W (33 dBm)}$
-------	----------------------------

Measurement Uncertainty

The assessed measurement uncertainty to ensure 95% confidence level for the normal distribution is with the coverage factor $k = 2$, $U = 0.4\text{ dB}$ for RF power output, $k = 2$, $U = 1.19\text{ dB}$ for EIRP.



Test Results

Band	Bandwidth (MHz)	UL Channel	RB Size	RB Position	Modulation	Power (dBm)	EIRP (dBm)
LTE Band2	1.4	18607	1	#0	QPSK	23.30	25.53
LTE Band2	1.4	18607	1	#Mid	QPSK	23.29	25.52
LTE Band2	1.4	18607	1	#Max	QPSK	23.22	25.45
LTE Band2	1.4	18607	3	#0	QPSK	23.12	25.35
LTE Band2	1.4	18607	3	#Mid	QPSK	23.11	25.34
LTE Band2	1.4	18607	3	#Max	QPSK	23.13	25.36
LTE Band2	1.4	18607	6	#0	QPSK	22.05	24.28
LTE Band2	1.4	18607	1	#0	QAM16	22.33	24.56
LTE Band2	1.4	18607	1	#Mid	QAM16	22.44	24.67
LTE Band2	1.4	18607	1	#Max	QAM16	22.18	24.41
LTE Band2	1.4	18607	3	#0	QAM16	22.27	24.50
LTE Band2	1.4	18607	3	#Mid	QAM16	22.27	24.50
LTE Band2	1.4	18607	3	#Max	QAM16	22.30	24.53
LTE Band2	1.4	18607	6	#0	QAM16	20.98	23.21
LTE Band2	1.4	18900	1	#0	QPSK	22.90	25.13
LTE Band2	1.4	18900	1	#Mid	QPSK	23.07	25.30
LTE Band2	1.4	18900	1	#Max	QPSK	22.96	25.19
LTE Band2	1.4	18900	3	#0	QPSK	23.35	25.58
LTE Band2	1.4	18900	3	#Mid	QPSK	23.34	25.57
LTE Band2	1.4	18900	3	#Max	QPSK	23.30	25.53
LTE Band2	1.4	18900	6	#0	QPSK	22.10	24.33
LTE Band2	1.4	18900	1	#0	QAM16	22.72	24.95
LTE Band2	1.4	18900	1	#Mid	QAM16	22.65	24.88
LTE Band2	1.4	18900	1	#Max	QAM16	22.51	24.74
LTE Band2	1.4	18900	3	#0	QAM16	21.89	24.12
LTE Band2	1.4	18900	3	#Mid	QAM16	21.97	24.20
LTE Band2	1.4	18900	3	#Max	QAM16	21.99	24.22
LTE Band2	1.4	18900	6	#0	QAM16	20.96	23.19
LTE Band2	1.4	19193	1	#0	QPSK	23.42	25.65
LTE Band2	1.4	19193	1	#Mid	QPSK	23.26	25.49
LTE Band2	1.4	19193	1	#Max	QPSK	23.19	25.42
LTE Band2	1.4	19193	3	#0	QPSK	23.30	25.53
LTE Band2	1.4	19193	3	#Mid	QPSK	23.30	25.53
LTE Band2	1.4	19193	3	#Max	QPSK	23.05	25.28
LTE Band2	1.4	19193	6	#0	QPSK	22.16	24.39
LTE Band2	1.4	19193	1	#0	QAM16	22.33	24.56
LTE Band2	1.4	19193	1	#Mid	QAM16	22.07	24.30
LTE Band2	1.4	19193	1	#Max	QAM16	21.97	24.20
LTE Band2	1.4	19193	3	#0	QAM16	22.34	24.57



LTE Band2	1.4	19193	3	#Mid	QAM16	22.34	24.57
LTE Band2	1.4	19193	3	#Max	QAM16	22.14	24.37
LTE Band2	1.4	19193	6	#0	QAM16	21.19	23.42
LTE Band2	3	18615	1	#0	QPSK	23.25	25.48
LTE Band2	3	18615	1	#Mid	QPSK	23.16	25.39
LTE Band2	3	18615	1	#Max	QPSK	23.19	25.42
LTE Band2	3	18615	8	#0	QPSK	22.07	24.30
LTE Band2	3	18615	8	#Mid	QPSK	22.07	24.30
LTE Band2	3	18615	8	#Max	QPSK	22.09	24.32
LTE Band2	3	18615	15	#0	QPSK	22.06	24.29
LTE Band2	3	18615	1	#0	QAM16	22.40	24.63
LTE Band2	3	18615	1	#Mid	QAM16	22.43	24.66
LTE Band2	3	18615	1	#Max	QAM16	22.46	24.69
LTE Band2	3	18615	8	#0	QAM16	20.87	23.10
LTE Band2	3	18615	8	#Mid	QAM16	20.88	23.11
LTE Band2	3	18615	8	#Max	QAM16	20.81	23.04
LTE Band2	3	18615	15	#0	QAM16	20.96	23.19
LTE Band2	3	18900	1	#0	QPSK	23.32	25.55
LTE Band2	3	18900	1	#Mid	QPSK	23.34	25.57
LTE Band2	3	18900	1	#Max	QPSK	23.34	25.57
LTE Band2	3	18900	8	#0	QPSK	22.13	24.36
LTE Band2	3	18900	8	#Mid	QPSK	22.13	24.36
LTE Band2	3	18900	8	#Max	QPSK	22.09	24.32
LTE Band2	3	18900	15	#0	QPSK	22.09	24.32
LTE Band2	3	18900	1	#0	QAM16	22.52	24.75
LTE Band2	3	18900	1	#Mid	QAM16	22.81	25.04
LTE Band2	3	18900	1	#Max	QAM16	22.78	25.01
LTE Band2	3	18900	8	#0	QAM16	21.42	23.65
LTE Band2	3	18900	8	#Mid	QAM16	21.42	23.65
LTE Band2	3	18900	8	#Max	QAM16	21.38	23.61
LTE Band2	3	18900	15	#0	QAM16	21.27	23.50
LTE Band2	3	19185	1	#0	QPSK	23.18	25.41
LTE Band2	3	19185	1	#Mid	QPSK	23.25	25.48
LTE Band2	3	19185	1	#Max	QPSK	23.31	25.54
LTE Band2	3	19185	8	#0	QPSK	22.26	24.49
LTE Band2	3	19185	8	#Mid	QPSK	22.26	24.49
LTE Band2	3	19185	8	#Max	QPSK	22.42	24.65
LTE Band2	3	19185	15	#0	QPSK	22.16	24.39
LTE Band2	3	19185	1	#0	QAM16	22.00	24.23
LTE Band2	3	19185	1	#Mid	QAM16	21.65	23.88
LTE Band2	3	19185	1	#Max	QAM16	21.59	23.82
LTE Band2	3	19185	8	#0	QAM16	21.20	23.43
LTE Band2	3	19185	8	#Mid	QAM16	21.17	23.40



LTE Band2	3	19185	8	#Max	QAM16	21.05	23.28
LTE Band2	3	19185	15	#0	QAM16	21.23	23.46
LTE Band2	5	18625	1	#0	QPSK	23.00	25.23
LTE Band2	5	18625	1	#Mid	QPSK	23.04	25.27
LTE Band2	5	18625	1	#Max	QPSK	22.92	25.15
LTE Band2	5	18625	12	#0	QPSK	21.99	24.22
LTE Band2	5	18625	12	#Mid	QPSK	22.09	24.32
LTE Band2	5	18625	12	#Max	QPSK	21.99	24.22
LTE Band2	5	18625	25	#0	QPSK	22.03	24.26
LTE Band2	5	18625	1	#0	QAM16	22.43	24.66
LTE Band2	5	18625	1	#Mid	QAM16	22.41	24.64
LTE Band2	5	18625	1	#Max	QAM16	22.40	24.63
LTE Band2	5	18625	12	#0	QAM16	20.97	23.20
LTE Band2	5	18625	12	#Mid	QAM16	20.97	23.20
LTE Band2	5	18625	12	#Max	QAM16	20.95	23.18
LTE Band2	5	18625	25	#0	QAM16	21.16	23.39
LTE Band2	5	18900	1	#0	QPSK	23.10	25.33
LTE Band2	5	18900	1	#Mid	QPSK	23.22	25.45
LTE Band2	5	18900	1	#Max	QPSK	23.13	25.36
LTE Band2	5	18900	12	#0	QPSK	22.05	24.28
LTE Band2	5	18900	12	#Mid	QPSK	22.15	24.38
LTE Band2	5	18900	12	#Max	QPSK	22.11	24.34
LTE Band2	5	18900	25	#0	QPSK	22.11	24.34
LTE Band2	5	18900	1	#0	QAM16	22.34	24.57
LTE Band2	5	18900	1	#Mid	QAM16	22.41	24.64
LTE Band2	5	18900	1	#Max	QAM16	22.33	24.56
LTE Band2	5	18900	12	#0	QAM16	20.82	23.05
LTE Band2	5	18900	12	#Mid	QAM16	20.77	23.00
LTE Band2	5	18900	12	#Max	QAM16	20.58	22.81
LTE Band2	5	18900	25	#0	QAM16	20.92	23.15
LTE Band2	5	19175	1	#0	QPSK	23.21	25.44
LTE Band2	5	19175	1	#Mid	QPSK	23.10	25.33
LTE Band2	5	19175	1	#Max	QPSK	23.07	25.30
LTE Band2	5	19175	12	#0	QPSK	22.11	24.34
LTE Band2	5	19175	12	#Mid	QPSK	22.11	24.34
LTE Band2	5	19175	12	#Max	QPSK	22.08	24.31
LTE Band2	5	19175	25	#0	QPSK	22.16	24.39
LTE Band2	5	19175	1	#0	QAM16	22.13	24.36
LTE Band2	5	19175	1	#Mid	QAM16	21.84	24.07
LTE Band2	5	19175	1	#Max	QAM16	21.80	24.03
LTE Band2	5	19175	12	#0	QAM16	21.27	23.50
LTE Band2	5	19175	12	#Mid	QAM16	21.17	23.40
LTE Band2	5	19175	12	#Max	QAM16	21.04	23.27



LTE Band2	5	19175	25	#0	QAM16	21.20	23.43
LTE Band2	10	18650	1	#0	QPSK	23.04	25.27
LTE Band2	10	18650	1	#Mid	QPSK	23.03	25.26
LTE Band2	10	18650	1	#Max	QPSK	23.04	25.27
LTE Band2	10	18650	25	#0	QPSK	21.98	24.21
LTE Band2	10	18650	25	#Mid	QPSK	21.97	24.20
LTE Band2	10	18650	25	#Max	QPSK	22.01	24.24
LTE Band2	10	18650	50	#0	QPSK	21.89	24.12
LTE Band2	10	18650	1	#0	QAM16	21.88	24.11
LTE Band2	10	18650	1	#Mid	QAM16	22.50	24.73
LTE Band2	10	18650	1	#Max	QAM16	21.64	23.87
LTE Band2	10	18650	25	#0	QAM16	21.01	23.24
LTE Band2	10	18650	25	#Mid	QAM16	21.02	23.25
LTE Band2	10	18650	25	#Max	QAM16	21.08	23.31
LTE Band2	10	18650	50	#0	QAM16	20.92	23.15
LTE Band2	10	18900	1	#0	QPSK	23.17	25.40
LTE Band2	10	18900	1	#Mid	QPSK	23.45	25.68
LTE Band2	10	18900	1	#Max	QPSK	23.10	25.33
LTE Band2	10	18900	25	#0	QPSK	22.09	24.32
LTE Band2	10	18900	25	#Mid	QPSK	22.10	24.33
LTE Band2	10	18900	25	#Max	QPSK	22.05	24.28
LTE Band2	10	18900	50	#0	QPSK	22.09	24.32
LTE Band2	10	18900	1	#0	QAM16	22.14	24.37
LTE Band2	10	18900	1	#Mid	QAM16	22.95	25.18
LTE Band2	10	18900	1	#Max	QAM16	22.66	24.89
LTE Band2	10	18900	25	#0	QAM16	21.24	23.47
LTE Band2	10	18900	25	#Mid	QAM16	21.03	23.26
LTE Band2	10	18900	25	#Max	QAM16	21.19	23.42
LTE Band2	10	18900	50	#0	QAM16	21.08	23.31
LTE Band2	10	19150	1	#0	QPSK	23.02	25.25
LTE Band2	10	19150	1	#Mid	QPSK	23.43	25.66
LTE Band2	10	19150	1	#Max	QPSK	23.27	25.50
LTE Band2	10	19150	25	#0	QPSK	22.12	24.35
LTE Band2	10	19150	25	#Mid	QPSK	22.12	24.35
LTE Band2	10	19150	25	#Max	QPSK	22.19	24.42
LTE Band2	10	19150	50	#0	QPSK	22.26	24.49
LTE Band2	10	19150	1	#0	QAM16	21.72	23.95
LTE Band2	10	19150	1	#Mid	QAM16	21.98	24.21
LTE Band2	10	19150	1	#Max	QAM16	21.64	23.87
LTE Band2	10	19150	25	#0	QAM16	21.29	23.52
LTE Band2	10	19150	25	#Mid	QAM16	21.29	23.52
LTE Band2	10	19150	25	#Max	QAM16	21.22	23.45
LTE Band2	10	19150	50	#0	QAM16	21.27	23.50



LTE Band2	15	18675	1	#0	QPSK	23.12	25.35
LTE Band2	15	18675	1	#Mid	QPSK	23.18	25.41
LTE Band2	15	18675	1	#Max	QPSK	23.05	25.28
LTE Band2	15	18675	36	#0	QPSK	21.91	24.14
LTE Band2	15	18675	36	#Mid	QPSK	21.92	24.15
LTE Band2	15	18675	36	#Max	QPSK	22.04	24.27
LTE Band2	15	18675	75	#0	QPSK	21.91	24.14
LTE Band2	15	18675	1	#0	QAM16	22.09	24.32
LTE Band2	15	18675	1	#Mid	QAM16	22.16	24.39
LTE Band2	15	18675	1	#Max	QAM16	21.33	23.56
LTE Band2	15	18675	36	#0	QAM16	20.81	23.04
LTE Band2	15	18675	36	#Mid	QAM16	20.81	23.04
LTE Band2	15	18675	36	#Max	QAM16	20.89	23.12
LTE Band2	15	18675	75	#0	QAM16	20.96	23.19
LTE Band2	15	18900	1	#0	QPSK	22.79	25.02
LTE Band2	15	18900	1	#Mid	QPSK	23.23	25.46
LTE Band2	15	18900	1	#Max	QPSK	23.00	25.23
LTE Band2	15	18900	36	#0	QPSK	22.04	24.27
LTE Band2	15	18900	36	#Mid	QPSK	22.04	24.27
LTE Band2	15	18900	36	#Max	QPSK	21.96	24.19
LTE Band2	15	18900	75	#0	QPSK	21.91	24.14
LTE Band2	15	18900	1	#0	QAM16	22.35	24.58
LTE Band2	15	18900	1	#Mid	QAM16	22.63	24.86
LTE Band2	15	18900	1	#Max	QAM16	22.38	24.61
LTE Band2	15	18900	36	#0	QAM16	20.96	23.19
LTE Band2	15	18900	36	#Mid	QAM16	21.06	23.29
LTE Band2	15	18900	36	#Max	QAM16	21.02	23.25
LTE Band2	15	18900	75	#0	QAM16	20.95	23.18
LTE Band2	15	19125	1	#0	QPSK	23.03	25.26
LTE Band2	15	19125	1	#Mid	QPSK	23.05	25.28
LTE Band2	15	19125	1	#Max	QPSK	22.88	25.11
LTE Band2	15	19125	36	#0	QPSK	22.07	24.30
LTE Band2	15	19125	36	#Mid	QPSK	21.97	24.20
LTE Band2	15	19125	36	#Max	QPSK	22.08	24.31
LTE Band2	15	19125	75	#0	QPSK	21.98	24.21
LTE Band2	15	19125	1	#0	QAM16	21.54	23.77
LTE Band2	15	19125	1	#Mid	QAM16	21.72	23.95
LTE Band2	15	19125	1	#Max	QAM16	21.66	23.89
LTE Band2	15	19125	36	#0	QAM16	21.04	23.27
LTE Band2	15	19125	36	#Mid	QAM16	21.03	23.26
LTE Band2	15	19125	36	#Max	QAM16	21.11	23.34
LTE Band2	15	19125	75	#0	QAM16	21.03	23.26
LTE Band2	20	18700	1	#0	QPSK	22.92	25.15



LTE Band2	20	18700	1	#Mid	QPSK	23.25	25.48
LTE Band2	20	18700	1	#Max	QPSK	22.73	24.96
LTE Band2	20	18700	50	#0	QPSK	21.89	24.12
LTE Band2	20	18700	50	#Mid	QPSK	21.88	24.11
LTE Band2	20	18700	50	#Max	QPSK	21.96	24.19
LTE Band2	20	18700	100	#0	QPSK	21.87	24.10
LTE Band2	20	18700	1	#0	QAM16	22.22	24.45
LTE Band2	20	18700	1	#Mid	QAM16	22.34	24.57
LTE Band2	20	18700	1	#Max	QAM16	22.16	24.39
LTE Band2	20	18700	50	#0	QAM16	20.92	23.15
LTE Band2	20	18700	50	#Mid	QAM16	20.91	23.14
LTE Band2	20	18700	50	#Max	QAM16	20.99	23.22
LTE Band2	20	18700	100	#0	QAM16	21.02	23.25
LTE Band2	20	18900	1	#0	QPSK	23.05	25.28
LTE Band2	20	18900	1	#Mid	QPSK	23.50	25.73
LTE Band2	20	18900	1	#Max	QPSK	23.03	25.26
LTE Band2	20	18900	50	#0	QPSK	21.91	24.14
LTE Band2	20	18900	50	#Mid	QPSK	21.92	24.15
LTE Band2	20	18900	50	#Max	QPSK	21.98	24.21
LTE Band2	20	18900	100	#0	QPSK	21.97	24.20
LTE Band2	20	18900	1	#0	QAM16	21.41	23.64
LTE Band2	20	18900	1	#Mid	QAM16	21.77	24.00
LTE Band2	20	18900	1	#Max	QAM16	21.48	23.71
LTE Band2	20	18900	50	#0	QAM16	20.85	23.08
LTE Band2	20	18900	50	#Mid	QAM16	20.91	23.14
LTE Band2	20	18900	50	#Max	QAM16	21.02	23.25
LTE Band2	20	18900	100	#0	QAM16	21.03	23.26
LTE Band2	20	19100	1	#0	QPSK	23.20	25.43
LTE Band2	20	19100	1	#Mid	QPSK	23.06	25.29
LTE Band2	20	19100	1	#Max	QPSK	23.09	25.32
LTE Band2	20	19100	50	#0	QPSK	22.01	24.24
LTE Band2	20	19100	50	#Mid	QPSK	21.97	24.20
LTE Band2	20	19100	50	#Max	QPSK	22.14	24.37
LTE Band2	20	19100	100	#0	QPSK	22.03	24.26
LTE Band2	20	19100	1	#0	QAM16	22.16	24.39
LTE Band2	20	19100	1	#Mid	QAM16	22.42	24.65
LTE Band2	20	19100	1	#Max	QAM16	21.93	24.16
LTE Band2	20	19100	50	#0	QAM16	21.12	23.35
LTE Band2	20	19100	50	#Mid	QAM16	21.12	23.35
LTE Band2	20	19100	50	#Max	QAM16	21.01	23.24
LTE Band2	20	19100	100	#0	QAM16	21.19	23.42

5.2. Occupied Bandwidth

Ambient condition

Temperature	Relative humidity	Pressure
23°C ~25°C	45%~50%	101.5kPa

Method of Measurement

The EUT was connected to Spectrum Analyzer and Base Station Simulator via power Splitter. The occupied bandwidth is measured using spectrum analyzer.

RBW is set to 51kHz, VBW is set to 160kHz for LTE Band 2 (1.4MHz),

RBW is set to 100kHz, VBW is set to 300kHz for LTE Band 2 (3MHz/5MHz),

RBW is set to 300kHz, VBW is set to 1MHz for LTE Band 2 (10MHz/15MHz/20MHz).

99% power and -26dBc occupied bandwidths are recorded. Spectrum analyzer plots are included on the following pages.

Test Setup

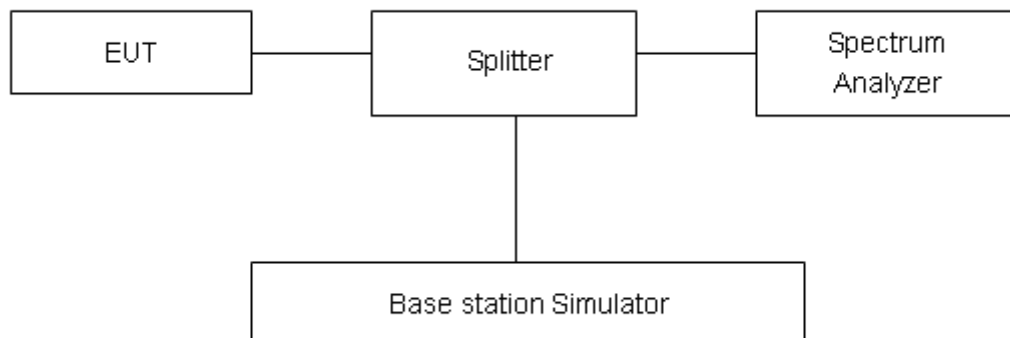

Limits

No specific occupied bandwidth requirements in part 2.1049.

Measurement Uncertainty

The assessed measurement uncertainty to ensure 95% confidence level for the normal distribution is with the coverage factor $k = 2$, $U = 624\text{Hz}$.



Test Result

LTE Band 2					
Modulation	Bandwidth (MHz)	Channel	Frequency (MHz)	99% Power Bandwidth(MHz)	-26dBc Bandwidth(MHz)
QPSK	1.4	18607	1850.7	1.1246	1.363
		18900	1880.0	1.1240	1.363
		19193	1909.3	1.1347	1.371
	3	18615	1851.5	2.7455	3.075
		18900	1880	2.7518	3.060
		19185	1908.5	2.7461	3.070
	5	18625	1852.5	4.5306	5.009
		18900	1880	4.5130	5.024
		19175	1907.5	4.5066	5.008
	10	18650	1855	9.0447	10.100
		18900	1880	9.0102	10.090
		19150	1905	9.0438	10.050
	15	18675	1857.5	13.4590	14.830
		18900	1880	13.4130	14.690
		19125	1902.5	13.4740	14.720
20	18700	1860	17.8610	19.190	
	18900	1880	17.8610	19.240	
	19100	1900	17.9130	19.520	
16QAM	1.4	18607	1850.7	1.1298	1.351
		18900	1880.0	1.1226	1.318
		19193	1909.3	1.1257	1.382
	3	18615	1851.5	2.7652	3.073
		18900	1880	2.7367	3.066
		19185	1908.5	2.7354	3.084
	5	18625	1852.5	4.5114	5.047
		18900	1880	4.5315	5.041
		19175	1907.5	4.5341	5.035
	10	18650	1855	9.0465	9.992
		18900	1880	9.0077	10.030
		19150	1905	9.0258	10.070



	15	18675	1857.5	13.4420	14.720
		18900	1880	13.4260	14.680
		19125	1902.5	13.4620	14.780
	20	18700	1860	17.8940	19.300
		18900	1880	17.8700	19.410
		19100	1900	17.8820	19.360

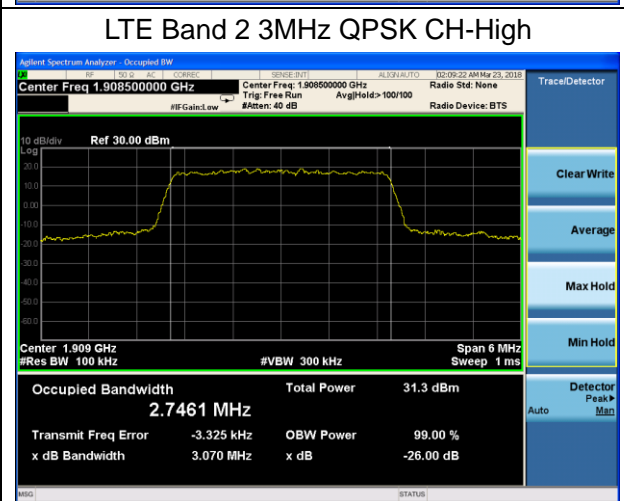
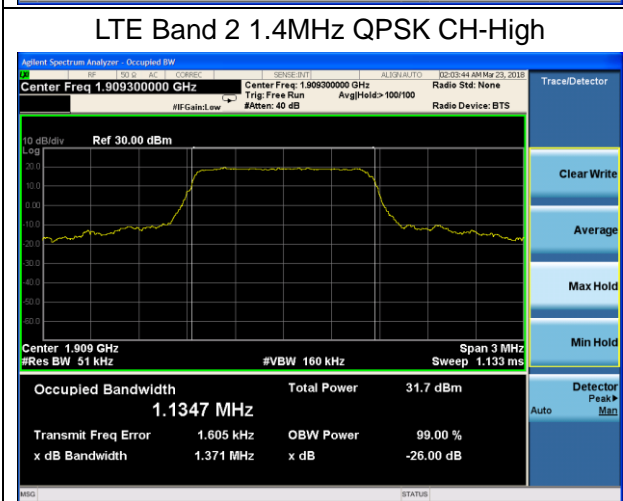
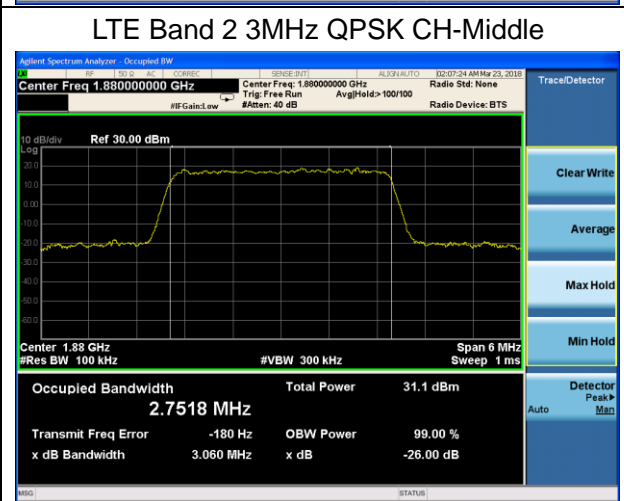
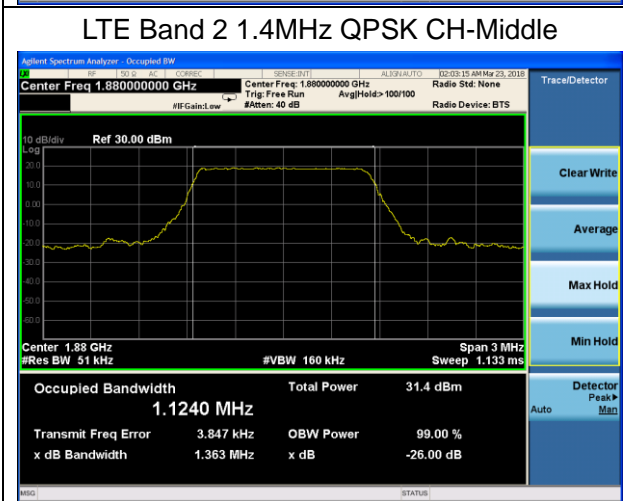
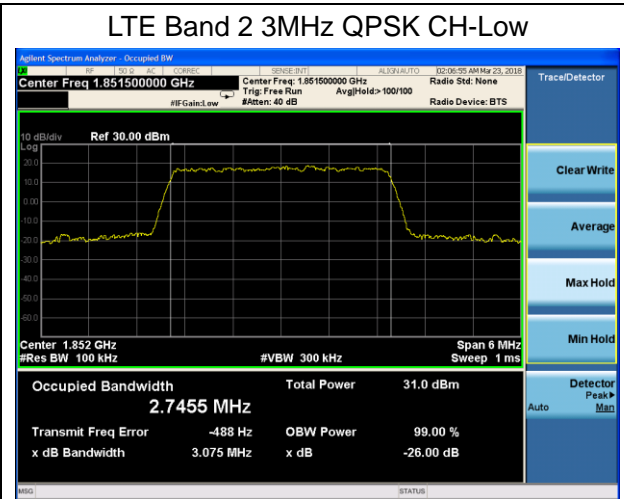
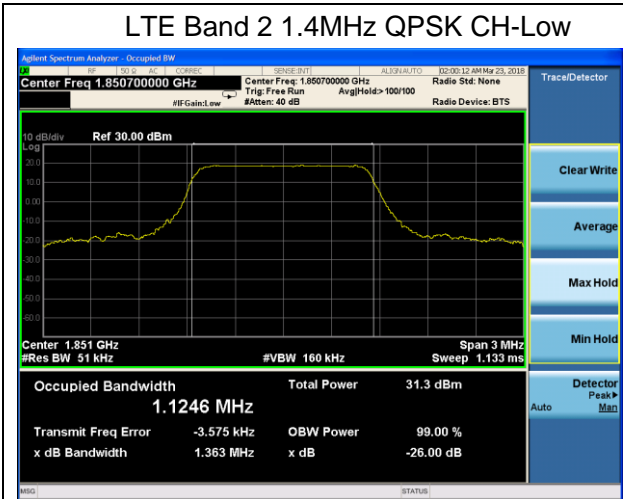

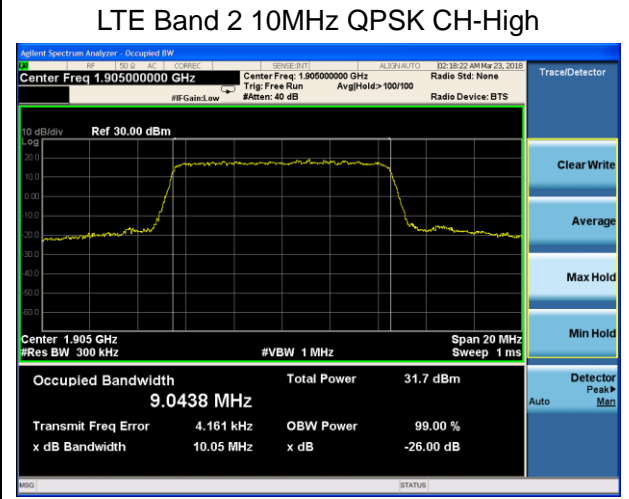
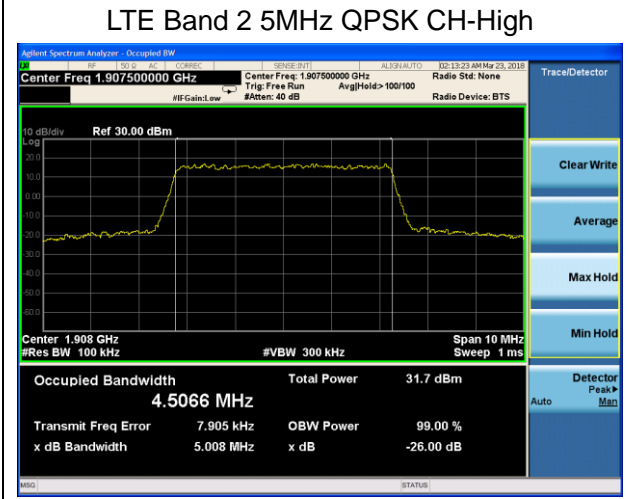
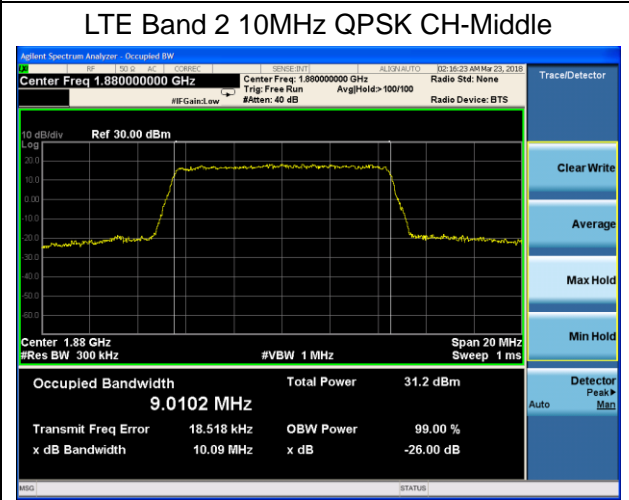
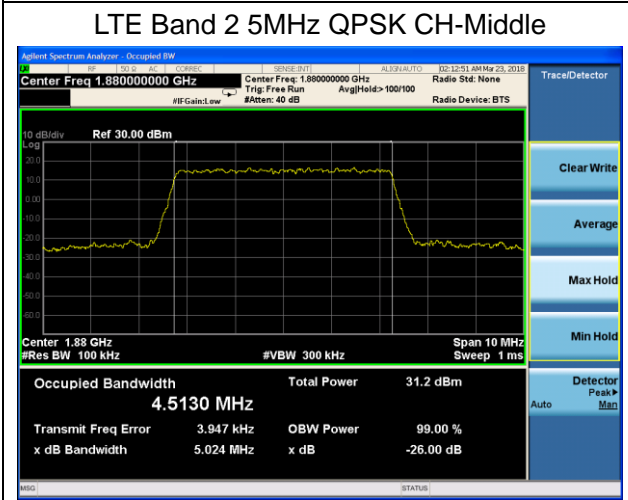
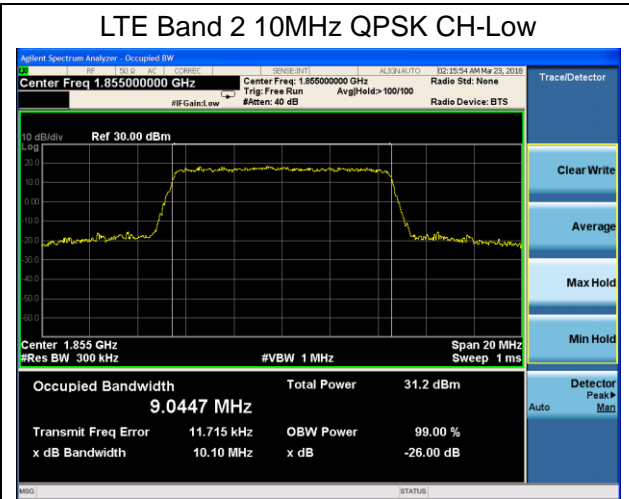
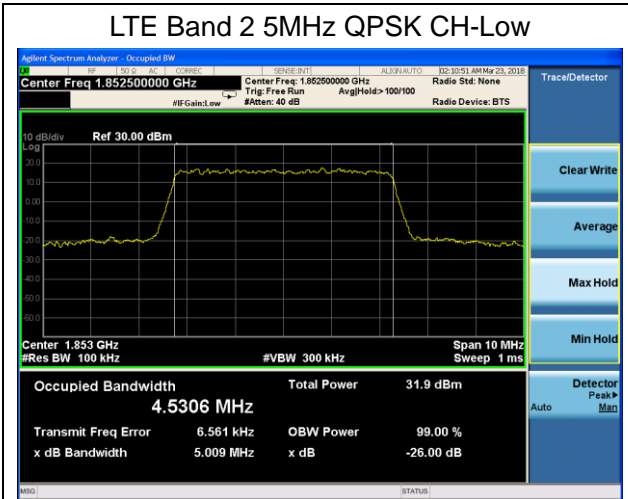

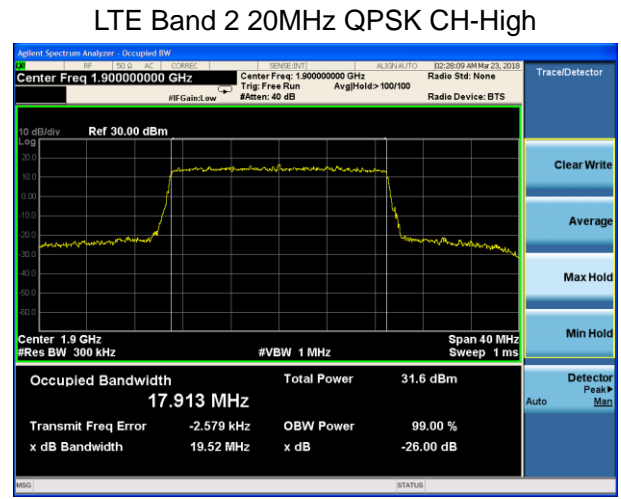
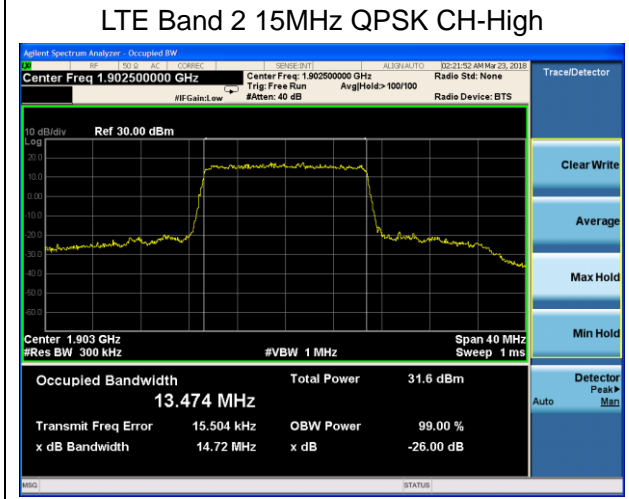
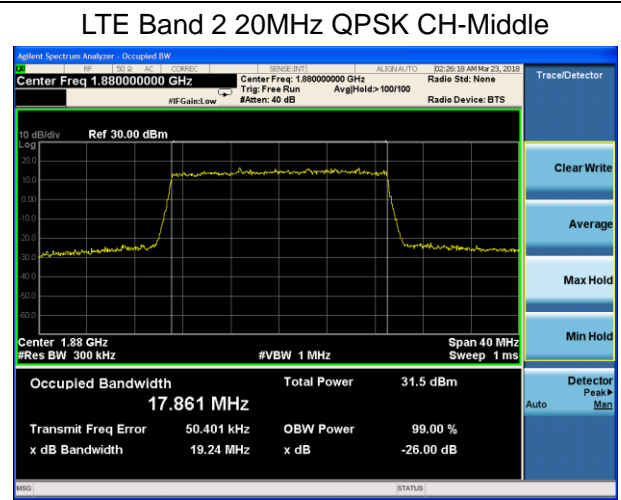
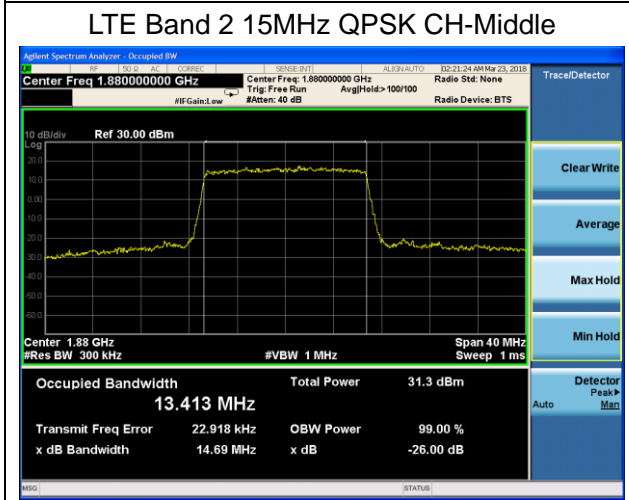
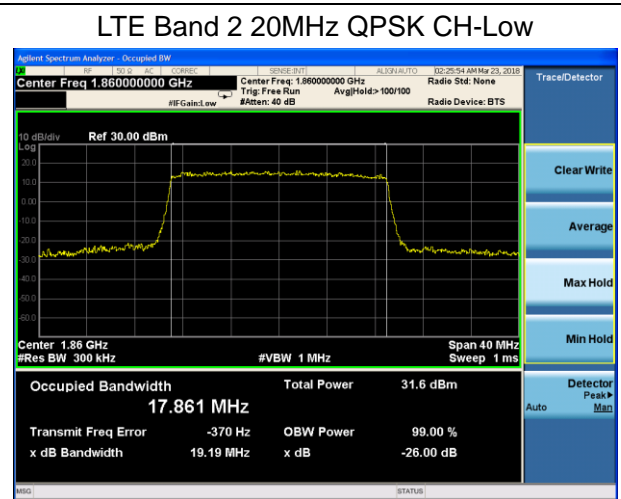
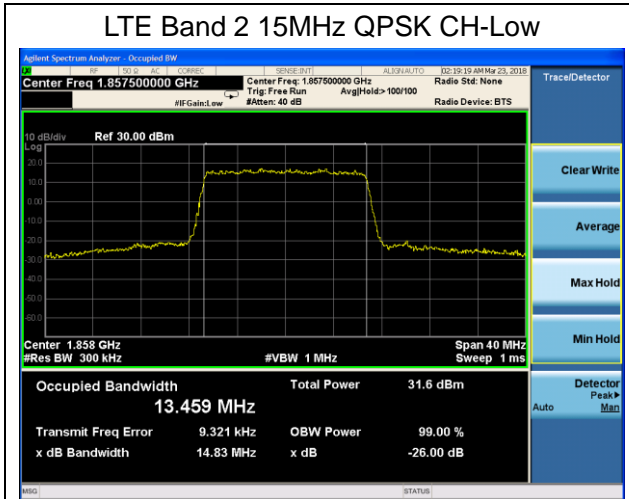

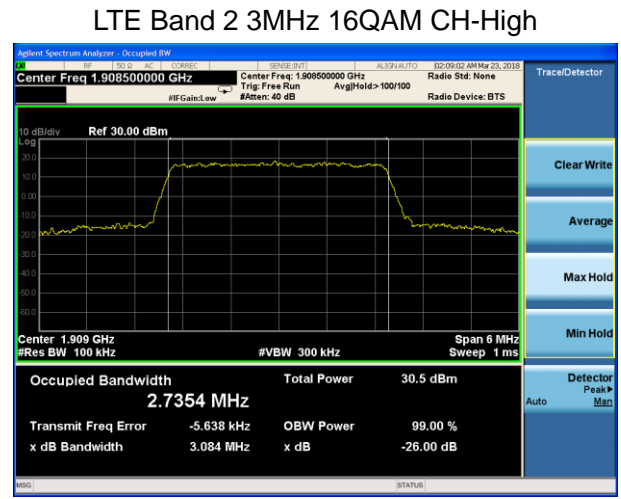
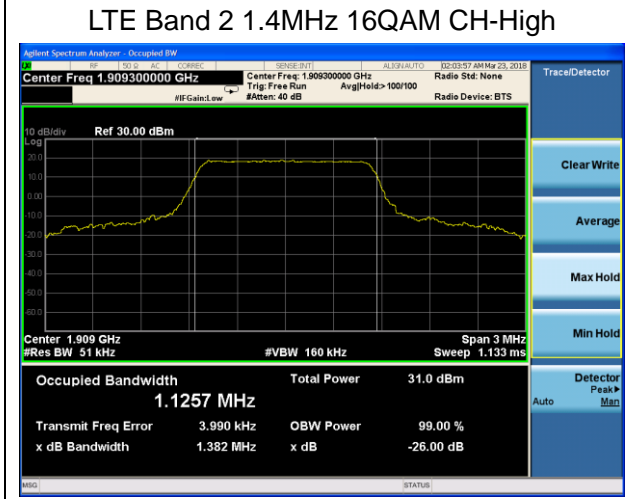
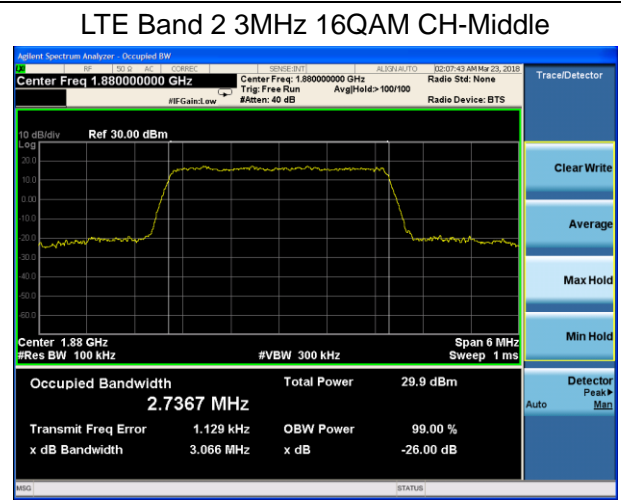
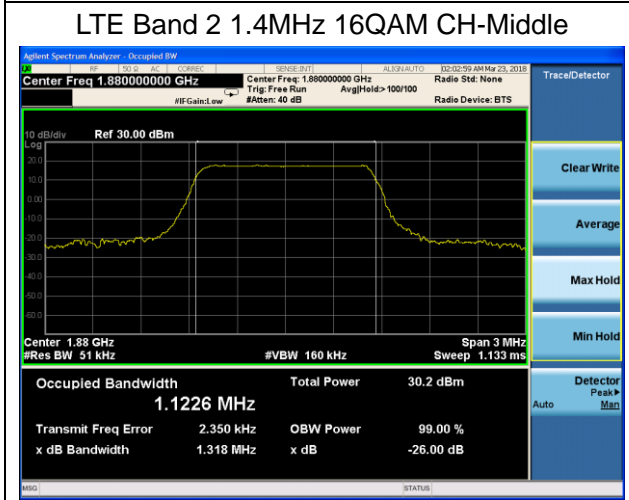
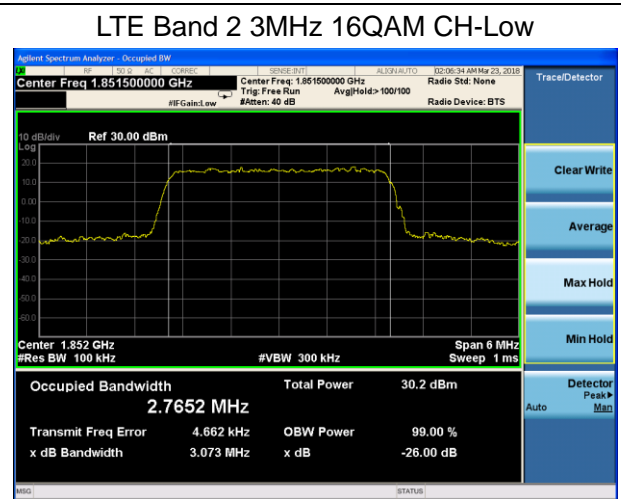
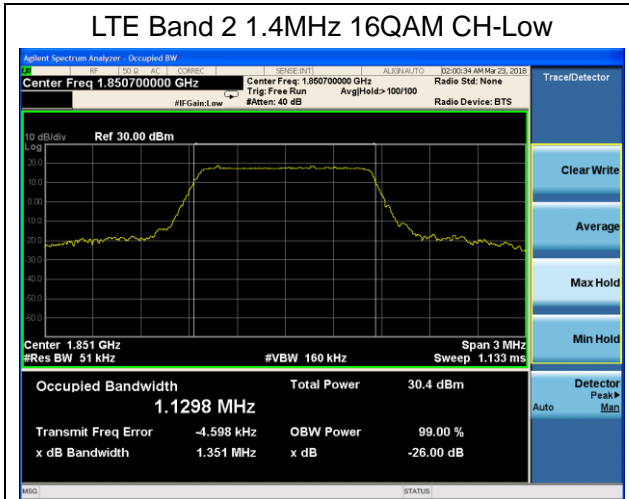

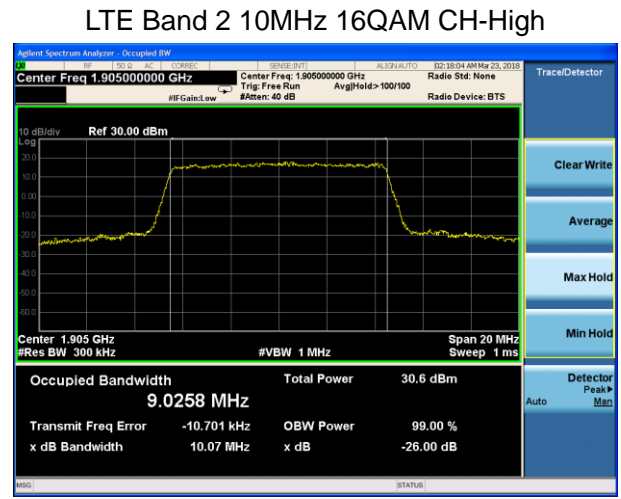
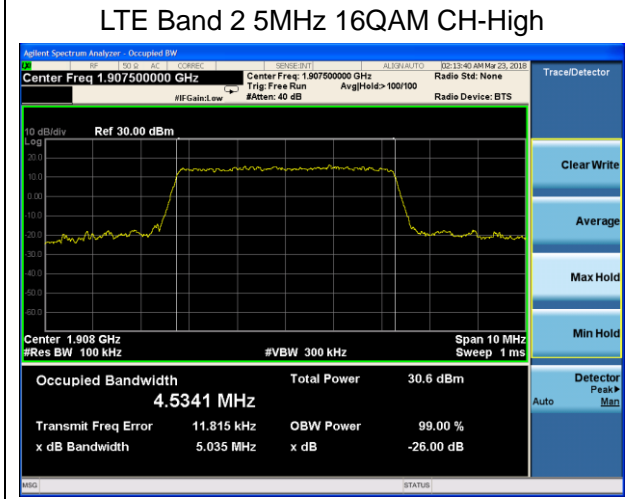
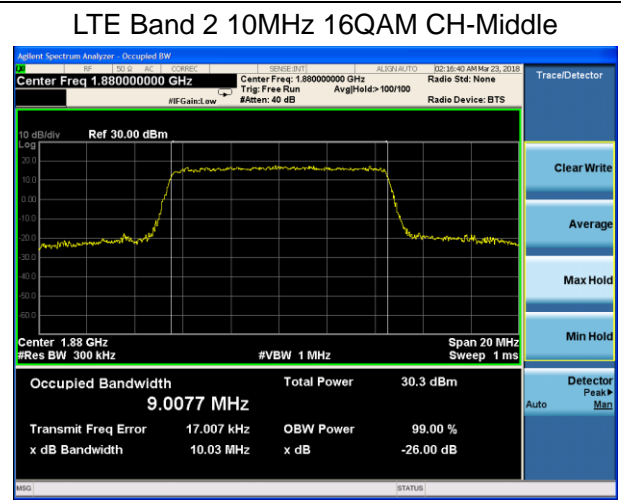
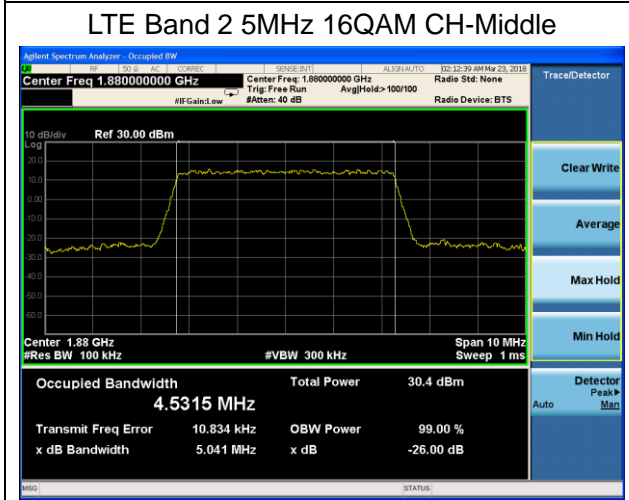
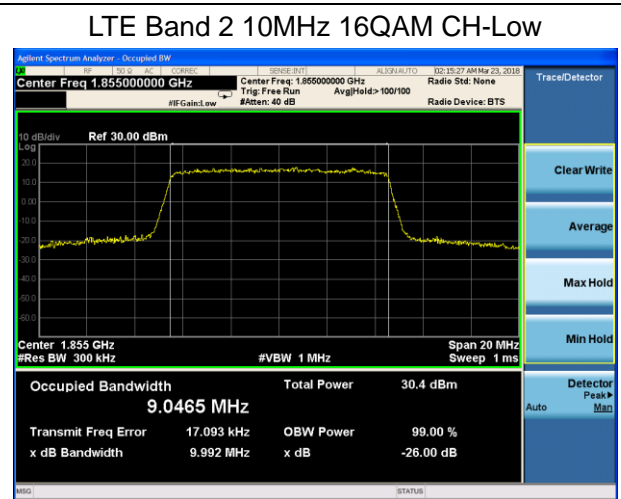
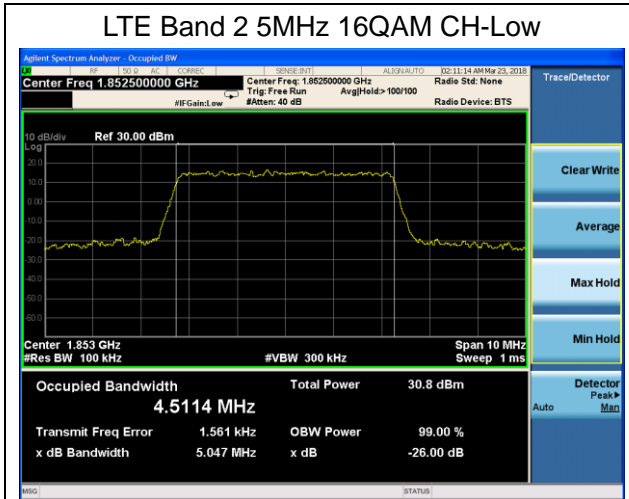

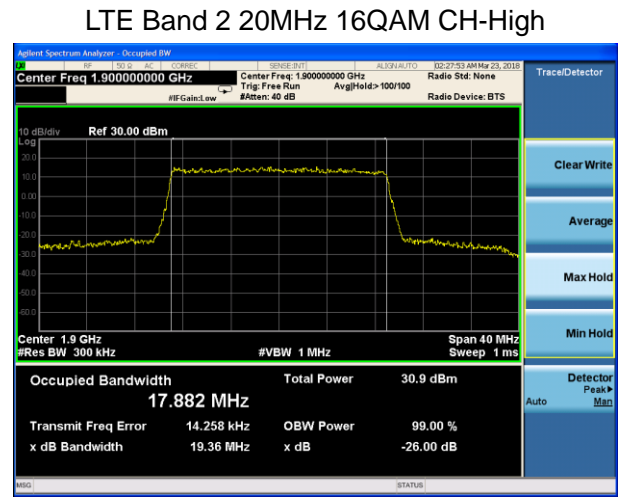
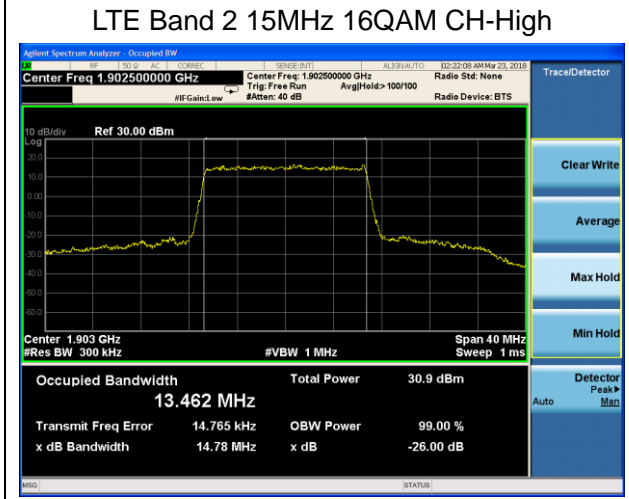
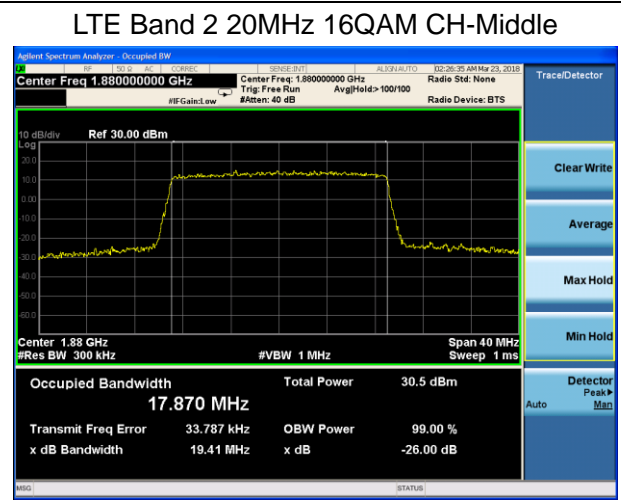
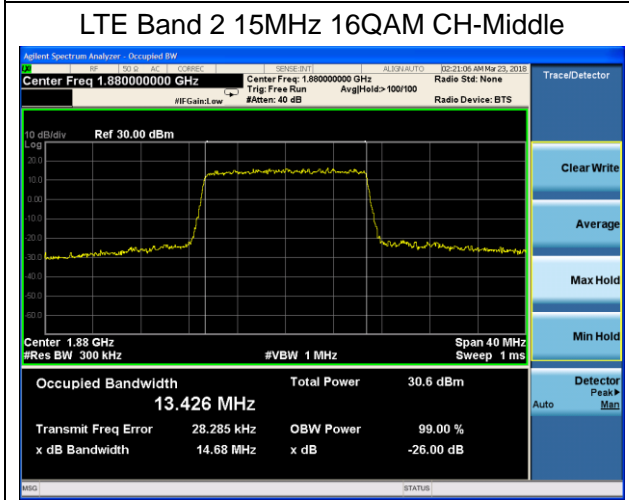
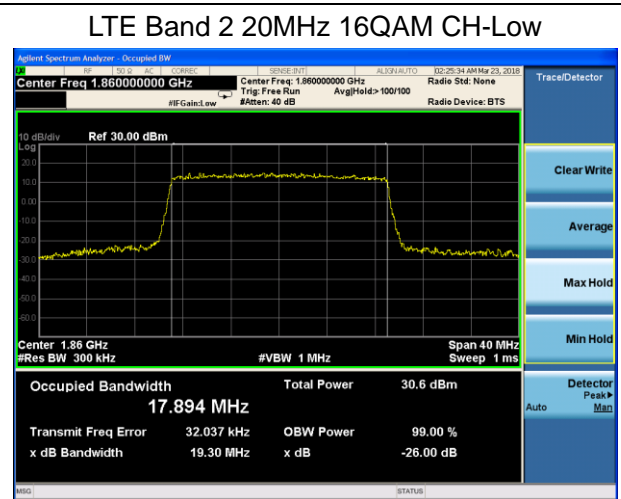
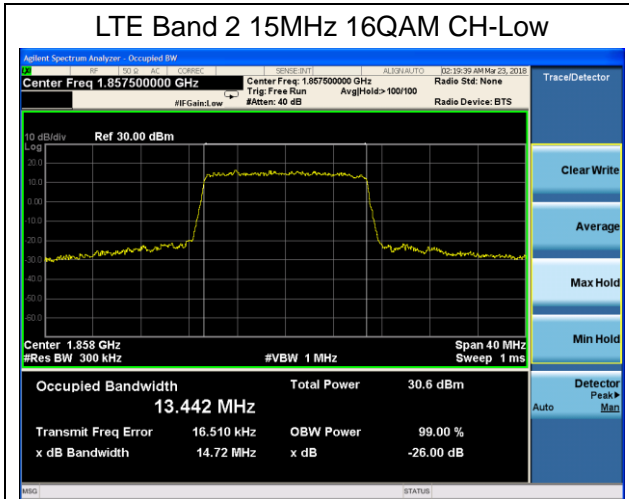

5.3. Band Edge Compliance

Ambient condition

Temperature	Relative humidity	Pressure
23°C ~25°C	45%~50%	101.5kPa

Method of Measurement

The EUT was connected to Spectrum Analyzer and Base Station Simulator via power Splitter. The band edge of the lowest and highest channels were measured. The Average detector is used and RBW is set to 15kHz, VBW is set to 51kHz for LTE Band 2 (1.4MHz), RBW is set to 30kHz, VBW is set to 100kHz for LTE Band 2 (3MHz), RBW is set to 51kHz, VBW is set to 160kHz for LTE Band 2 (5MHz), RBW is set to 100kHz, VBW is set to 300kHz for LTE Band 2 (10MHz), RBW is set to 150kHz, VBW is set to 510kHz for LTE Band 2 (15MHz), RBW is set to 200kHz, VBW is set to 620kHz for LTE Band 2 (20MHz).

Spectrum analyzer plots are included on the following pages.

Test Setup

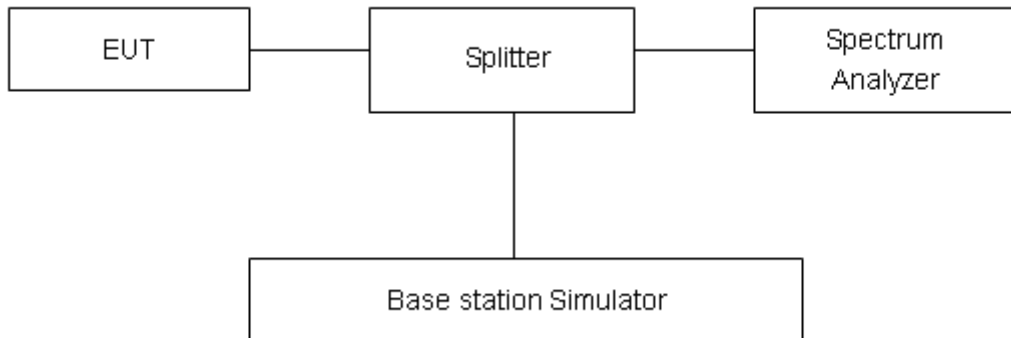

Limits

Rule Part 24.238(a) specifies that “on any frequency outside a licensee's frequency block, the power of any emission shall be attenuated below the transmitter power (P) by at least $43 + 10 \log_{10} (P)$ dB.”

Limit	-13 dBm
-------	---------

Measurement Uncertainty

The assessed measurement uncertainty to ensure 95% confidence level for the normal distribution is with the coverage factor $k = 1.96$, $U=0.684$ dB.



Test Result:

LTE Band 2 1.4MHz QPSK 1RB CH-Low

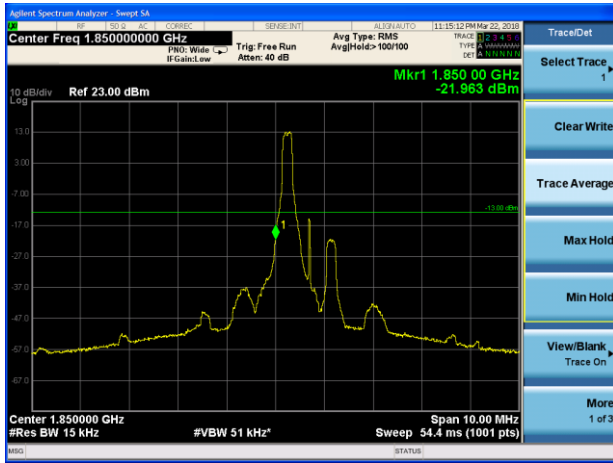

LTE Band 2 1.4MHz QPSK 1RB CH-High

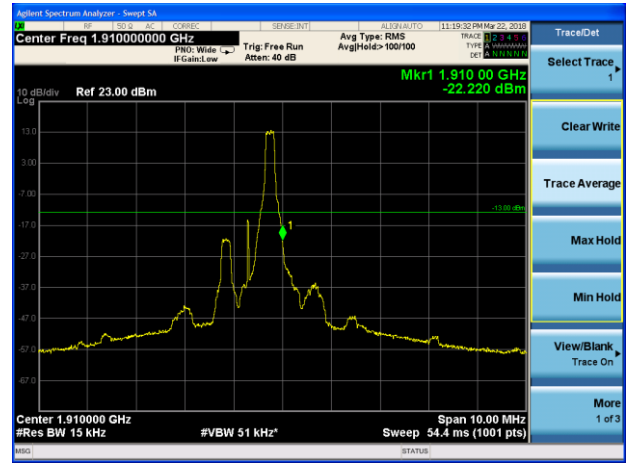

LTE Band 2 1.4MHz QPSK 100%RB CH-Low

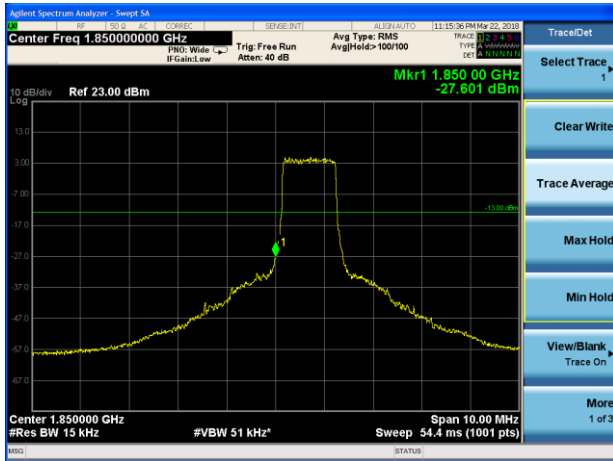

LTE Band 2 1.4MHz QPSK 100%RB CH-High

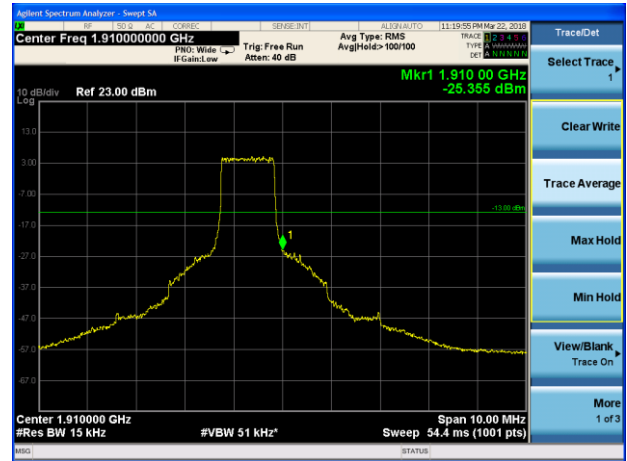

LTE Band 2 3MHz QPSK 1RB CH-Low

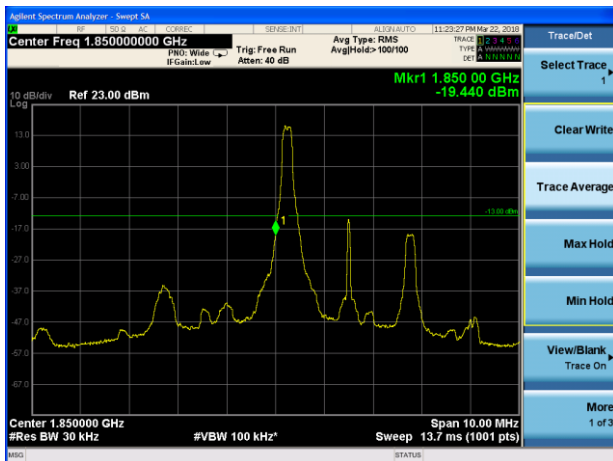

LTE Band 2 3MHz QPSK 1RB CH-High

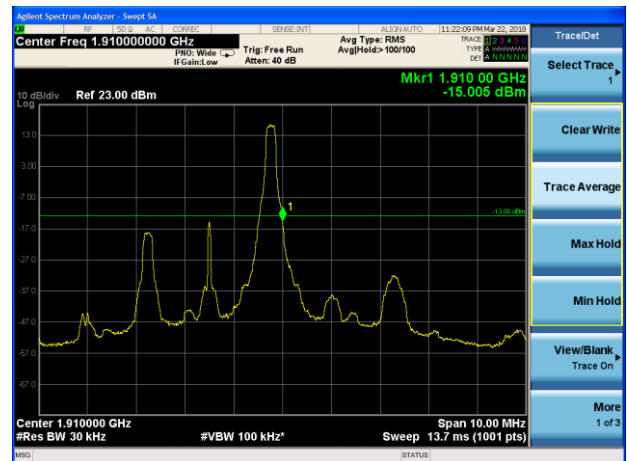



LTE Band 2 3MHz QPSK 100%RB CH-Low

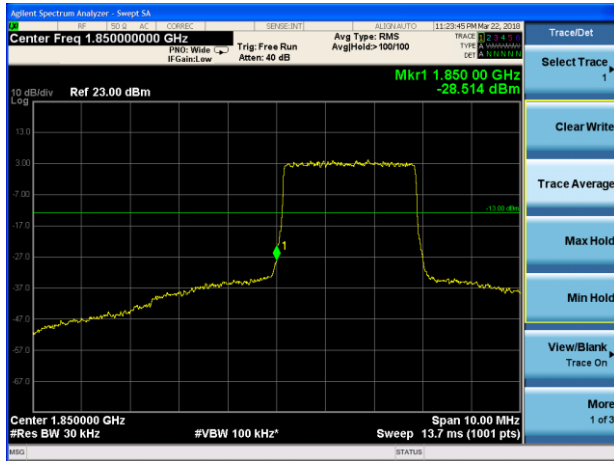

LTE Band 2 3MHz QPSK 100%RB CH-High

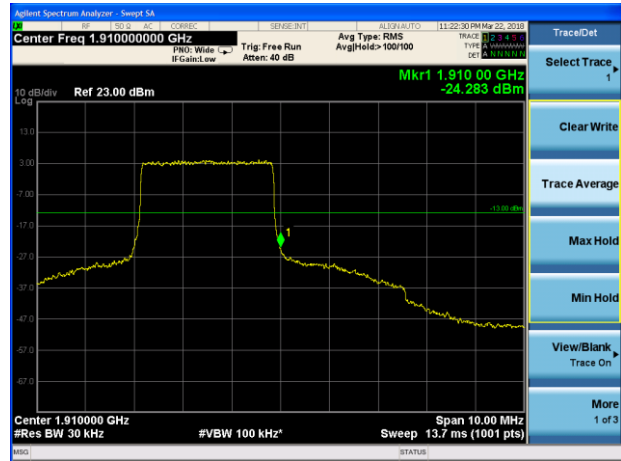

LTE Band 2 5MHz QPSK 1RB CH-Low

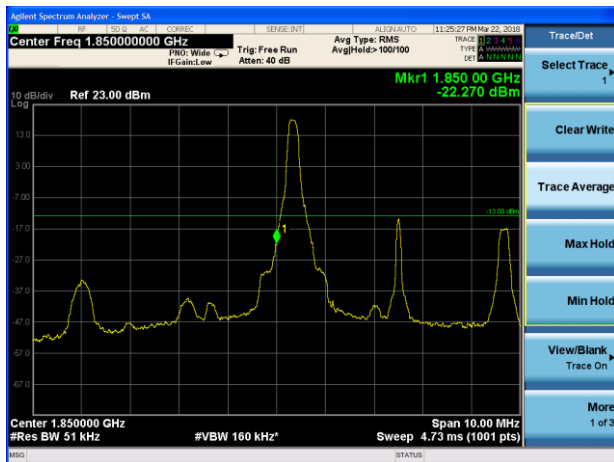

LTE Band 2 5MHz QPSK 1RB CH-High

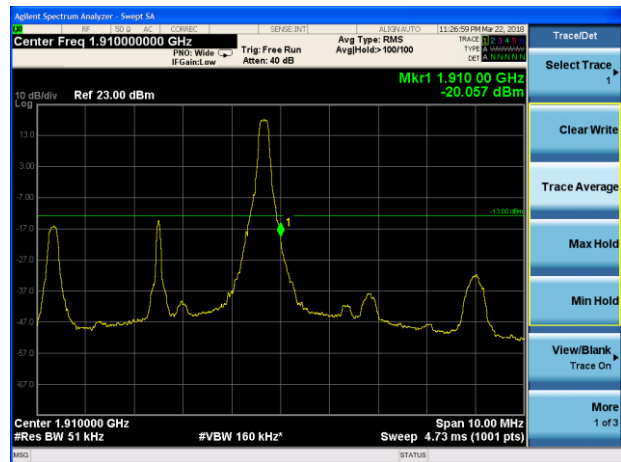

LTE Band 2 5MHz QPSK 100%RB CH-Low

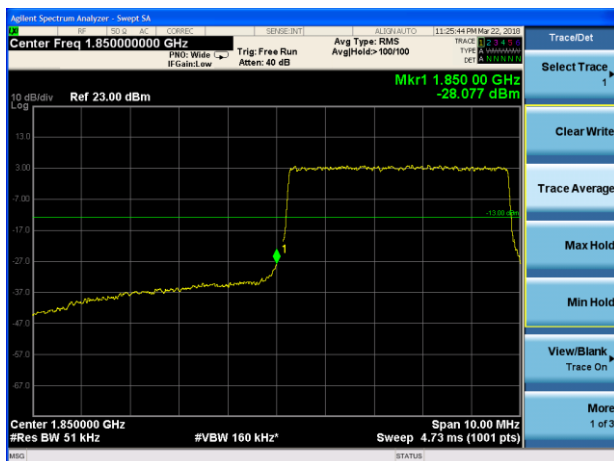

LTE Band 2 5MHz QPSK 100%RB CH-High

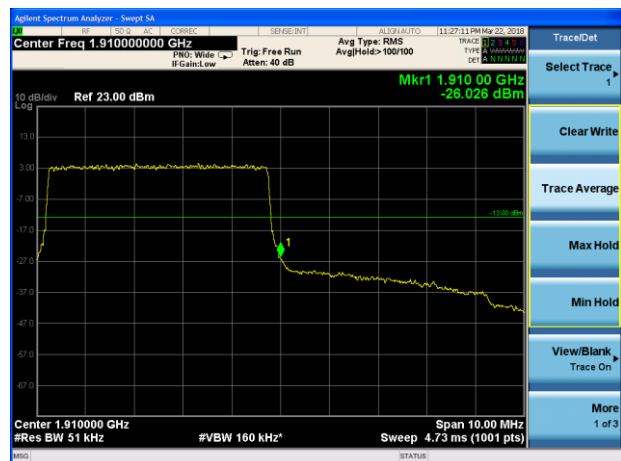



LTE Band 2 10MHz QPSK 1RB CH-Low

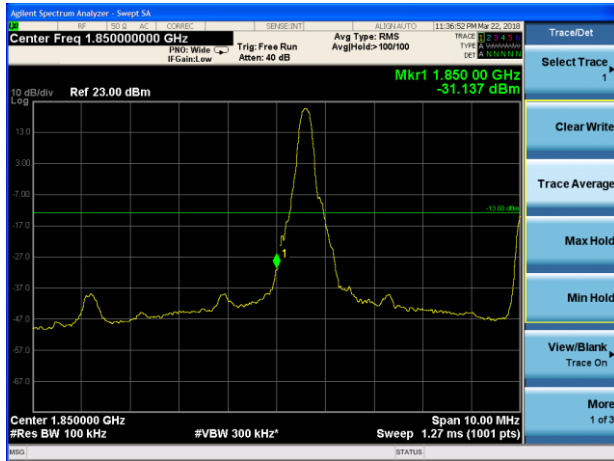

LTE Band 2 10MHz QPSK 1RB CH-High

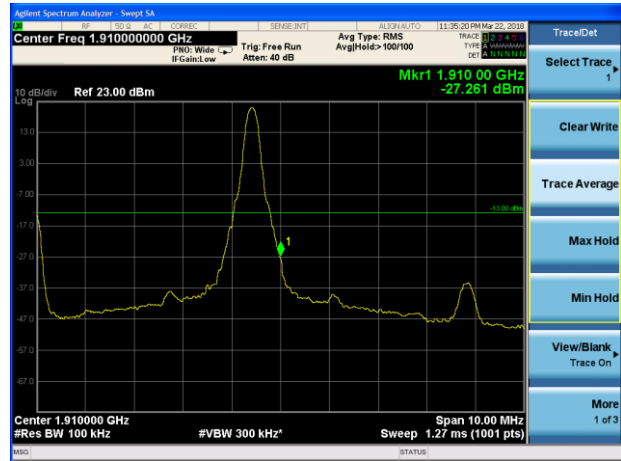

LTE Band 2 10MHz QPSK 100%RB CH-Low

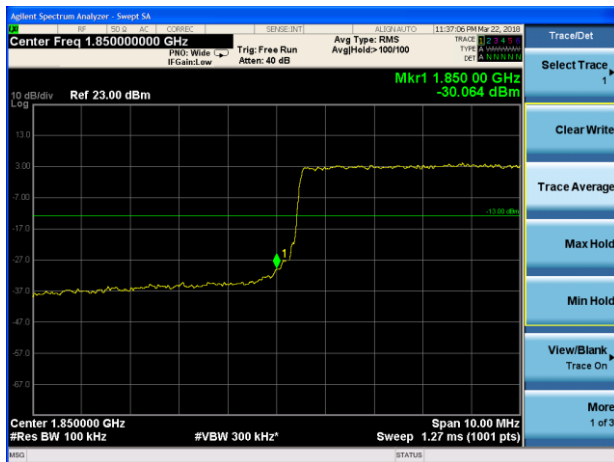

LTE Band 2 10MHz QPSK 100%RB CH-High

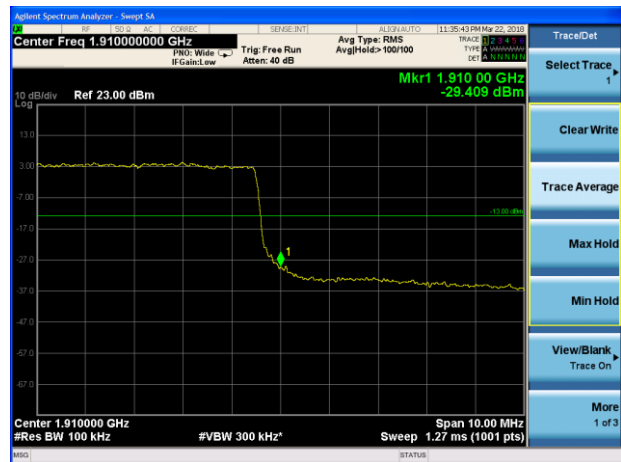

LTE Band 2 15MHz QPSK 1RB CH-Low

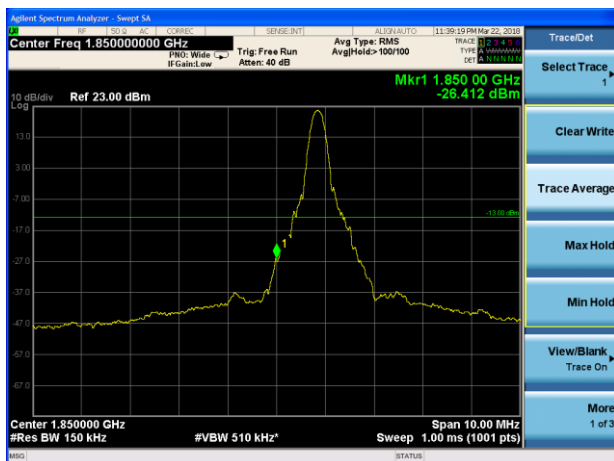

LTE Band 2 15MHz QPSK 1RB CH-High

