



RF TEST REPORT

Applicant ZTE Corporation
FCC ID SRQ-MF289F
Product MF289F
Model MF289F
Report No. R2102A0149-R1V1
Issue Date July 8, 2021

TA Technology (Shanghai) Co., Ltd. tested the above equipment in accordance with the requirements in **FCC CFR47 Part 2 (2020)/ FCC CFR 47 Part 22H (2020)**. The test results show that the equipment tested is capable of demonstrating compliance with the requirements as documented in this report.

Prepared by: Peng Tao

Approved by: Kai Xu

TA Technology (Shanghai) Co., Ltd.

No.145, Jintang Rd, Tangzhen Industry Park, Pudong Shanghai, China

TEL: +86-021-50791141/2/3

FAX: +86-021-50791141/2/3-8000



TABLE OF CONTENT

1. Test Laboratory	5
1.1. Notes of the Test Report	5
1.2. Test facility.....	5
1.3. Testing Location	5
2. General Description of Equipment under Test.....	6
2.1. Applicant and Manufacturer Information	6
2.2. General Information.....	6
3. Applied Standards	7
4. Test Configuration.....	8
5. Test Case Results.....	9
5.1. RF Power Output and Effective Radiated Power	9
5.2. Occupied Bandwidth	11
5.3. Band Edge Compliance.....	15
5.4. Peak-to-Average Power Ratio (PAPR)	17
5.5. Frequency Stability	19
5.6. Spurious Emissions at Antenna Terminals	21
5.7. Radiates Spurious Emission	24
6. Main Test Instruments	28
ANNEX A: The EUT Appearance	29
ANNEX B: Test Setup Photos	30



Version	Revision description	Issue Date
Rev.0	Initial issue of report.	July 7, 2021
Rev.1	Update information in Page28.	July 8, 2021

Note: This revised report (Report No. R2102A0149-R1V1) supersedes and replaces the previously issued report (Report No. R2102A0149-R1). Please discard or destroy the previously issued report and dispose of it accordingly.



Summary of measurement results

No.	Test Case	Clause in FCC rules	Verdict
1	RF Power Output and Effective Radiated Power	2.1046 22.913(a)(5)	PASS
2	Occupied Bandwidth	2.1049	PASS
3	Band Edge Compliance	2.1051 / 22.917(a)	PASS
4	Peak-to-Average Power Ratio	22.913(d)/ KDB 971168 D01(5.7)	PASS
5	Frequency Stability	2.1055 / 22.355	PASS
6	Spurious Emissions at Antenna Terminals	2.1051 / 22.917(a)	PASS
7	Radiates Spurious Emission	2.1053 / 22.917 (a)	PASS

Date of Testing: March 9, 2021 ~ June 30, 2021
Date of Sample Received: February 22, 2021

Note: PASS: The EUT complies with the essential requirements in the standard.
FAIL: The EUT does not comply with the essential requirements in the standard.
All indications of Pass/Fail in this report are opinions expressed by TA Technology (Shanghai) Co., Ltd. based on interpretations and/or observations of test results. Measurement Uncertainties were not taken into account and are published for informational purposes only.



1. Test Laboratory

1.1. Notes of the Test Report

This report shall not be reproduced in full or partial, without the written approval of **TA technology (shanghai) co., Ltd.** The results documented in this report apply only to the tested sample, under the conditions and modes of operation as described herein. Measurement Uncertainties were not taken into account and are published for informational purposes only. This report is written to support regulatory compliance of the applicable standards stated above.

1.2. Test facility

FCC (Designation number: CN1179, Test Firm Registration Number: 446626)

TA Technology (Shanghai) Co., Ltd. has been listed on the US Federal Communications Commission list of test facilities recognized to perform measurements.

A2LA (Certificate Number: 3857.01)

TA Technology (Shanghai) Co., Ltd. has been listed by American Association for Laboratory Accreditation to perform measurement.

1.3. Testing Location

Company: TA Technology (Shanghai) Co., Ltd.
Address: No.145, Jintang Rd, Tangzhen Industry Park, Pudong
City: Shanghai
Post code: 201201
Country: P. R. China
Contact: Xu Kai
Telephone: +86-021-50791141/2/3
Fax: +86-021-50791141/2/3-8000
Website: <http://www.ta-shanghai.com>
E-mail: xukai@ta-shanghai.com

2. General Description of Equipment under Test

2.1. Applicant and Manufacturer Information

Applicant	ZTE Corporation
Applicant address	ZTE Plaza, Keji Road South, Hi-Tech, Industrial Park, Nanshan District, Shenzhen, Guangdong, 518057, P.R.China
Manufacturer	ZTE Corporation
Manufacturer address	ZTE Plaza, Keji Road South, Hi-Tech, Industrial Park, Nanshan District, Shenzhen, Guangdong, 518057, P.R.China

2.2. General Information

EUT Description			
Model	MF289F		
IMEI	864781050000249		
Hardware Version	mb5B		
Software Version	VDF_DE_MF289FV1.0.0B01		
Power Supply	AC adapter		
Antenna Type	Internal Antenna		
Antenna Gain	0.5dBi		
Test Mode(s)	GSM 850;		
Test Modulation	(GSM/GPRS)GMSK, (EGPRS) GMSK/ 8PSK;		
GPRS Multislot Class	10		
EGPRS Multislot Class	12		
Maximum E.R.P.	GSM 850:	31.41dBm	
Rated Power Supply Voltage	12V		
Operating Voltage	Minimum: 10.8V Maximum: 13.2V		
Operating Temperature	Lowest: -20°C Highest: +55°C		
Extreme Temperature	Lowest: -30°C Highest: +50°C		
Operating Frequency Range(s)	Band	Tx (MHz)	Rx (MHz)
	GSM850	824 ~ 849	869 ~ 894
EUT Accessory			
Adapter	Manufacturer: Shenzhen Ruijing Industrial Co Ltd Model: STC-A1215C55-A		
Note: 1. The EUT is sent from the applicant to TA and the information of the EUT is declared by the applicant.			



3. Applied Standards

According to the specifications of the manufacturer, it must comply with the requirements of the following standards:

Test standards:

FCC CFR 47 Part 22H (2020)

ANSI C63.26 (2015)

Reference standard:

FCC CFR47 Part 2 (2020)

KDB 971168 D01 Power Meas License Digital Systems v03r01

4. Test Configuration

Radiated measurements are performed by rotating the EUT in three different orthogonal test planes. EUT stand-up position (Z axis), lie-down position (X, Y axis). Receiver antenna polarization (horizontal and vertical), the worst emission was found in position (X axis, horizontal polarization) and the worst case was recorded.

All mode and data rates and positions and modulations were investigated.

Subsequently, only the worst case emissions are reported.

The following testing in GSM is set based on the maximum RF Output Power.

Test modes are chosen to be reported as the worst case configuration below:

Test items	Modes/Modulation
	GSM 850
RF Power Output and Effective Radiated power	GSM GPRS EGPRS
Occupied Bandwidth	GSM GPRS(1Tx slot) EGPRS(1Tx slot)
Band Edge Compliance	GSM GPRS(1Tx slot) EGPRS(1Tx slot)
Peak-to-Average Power Ratio	GSM GPRS(1Tx slot) EGPRS(1Tx slot)
Frequency Stability	GSM GPRS(1Tx slot) EGPRS(1Tx slot)
Spurious Emissions at Antenna Terminals	GSM
Radiates Spurious Emission	GSM

5. Test Case Results

5.1. RF Power Output and Effective Radiated Power

Ambient condition

Temperature	Relative humidity	Pressure
23°C ~25°C	45%~50%	101.5kPa

Methods of Measurement

During the process of the testing, The EUT was connected to the Base Station Simulator with a known loss. The EUT is controlled by the Base Station Simulator test set to ensure max power transmission with proper modulation.

ERP can then be calculated as follows:

$$\text{EIRP (dBm)} = \text{Output Power (dBm)} - \text{Losses (dB)} + \text{Antenna Gain (dBi)}$$

where:dBd refers to gain relative to an ideal dipole.

$$\text{EIRP (dBm)} = \text{ERP (dBm)} + 2.15 \text{ (dB)}.$$

Test Setup

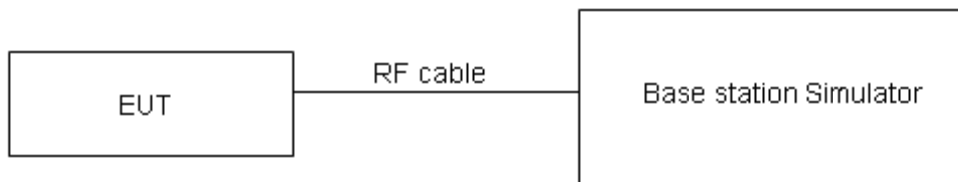

Limits

No specific RF power output requirements in part 2.1046.

Rule Part 22.913(a)(5) specifies that "Mobile/portable stations are limited to 7 watts ERP".

Limit	≤ 7 W (38.45 dBm)
-------	-------------------

Measurement Uncertainty

The assessed measurement uncertainty to ensure 95% confidence level for the normal distribution is with the coverage factor $k = 2$, $U = 0.4$ dB for RF power output, $k = 2$, $U = 1.19$ dB for ERP.



Test Results

GSM 850		Maximum Output Power (dBm)			ERP (dBm)		
		Channel 128	Channel 190	Channel 251	Channel 128	Channel 190	Channel 251
		824.2 (MHz)	836.6 (MHz)	848.8 (MHz)	824.2 (MHz)	836.6 (MHz)	848.8 (MHz)
GSM(GMSK)	Results	32.53	33.06	32.85	30.88	31.41	31.20
GPRS (GMSK)	1TXslot	32.92	32.98	32.49	31.27	31.33	30.84
	2TXslots	32.65	32.74	32.27	31.00	31.09	30.62
EGPRS (8PSK)	1TXslot	26.81	27.41	26.86	25.16	25.76	25.21
	2TXslots	26.61	27.23	26.72	24.96	25.58	25.07
	3TXslots	26.38	26.92	26.51	24.73	25.27	24.86
	4TXslots	26.02	26.64	26.15	24.37	24.99	24.50

5.2. Occupied Bandwidth

Ambient condition

Temperature	Relative humidity	Pressure
23°C ~25°C	45%~50%	101.5kPa

Method of Measurement

The EUT was connected to Spectrum Analyzer and Base Station Simulator via power Splitter. The occupied bandwidth is measured using spectrum analyzer.

RBW is set to 6.2kHz, VBW is set to 20kHz for GSM 850

99% power and -26dBc occupied bandwidths are recorded. Spectrum analyzer plots are included on the following pages.

Test Setup

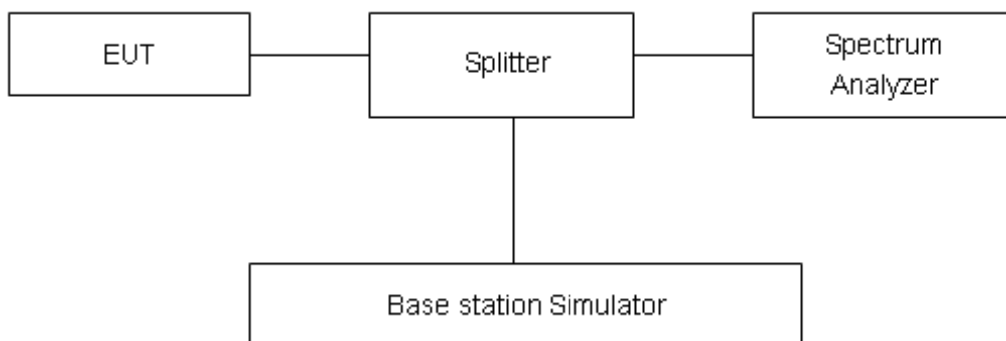

Limits

No specific occupied bandwidth requirements in part 2.1049.

Measurement Uncertainty

The assessed measurement uncertainty to ensure 95% confidence level for the normal distribution is with the coverage factor $k = 2$, $U = 624\text{Hz}$.

**Test Result**

Mode	Channel	Frequency (MHz)	99% Power Bandwidth (MHz)	-26dBc Bandwidth(MHz)
GSM 850 (GMSK)	128	824.2	0.2385	0.2965
	190	836.6	0.2423	0.3007
	251	848.8	0.2395	0.2970
GPRS 850 (GMSK)	128	824.2	0.2392	0.3086
	190	836.6	0.2382	0.3086
	251	848.8	0.2449	0.3030
EGPRS 850 (8PSK)	128	824.2	0.2511	0.3093
	190	836.6	0.2435	0.3109
	251	848.8	0.2470	0.3053



GSM 850 CH-Low



GSM 850 GPRS CH-Low



GSM 850 CH-Middle

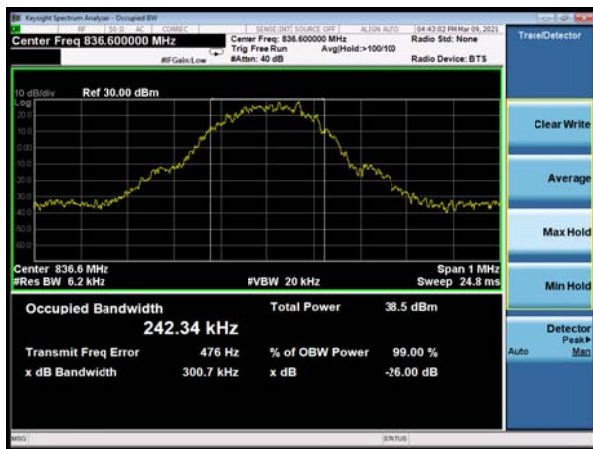

GSM 850 GPRS CH-Middle

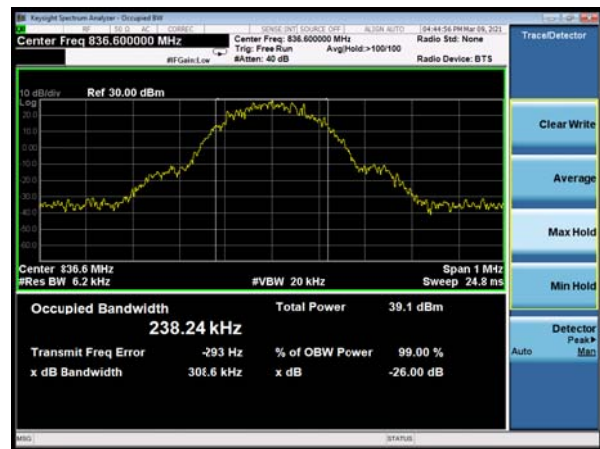

GSM 850 CH-High



GSM 850 GPRS CH-High

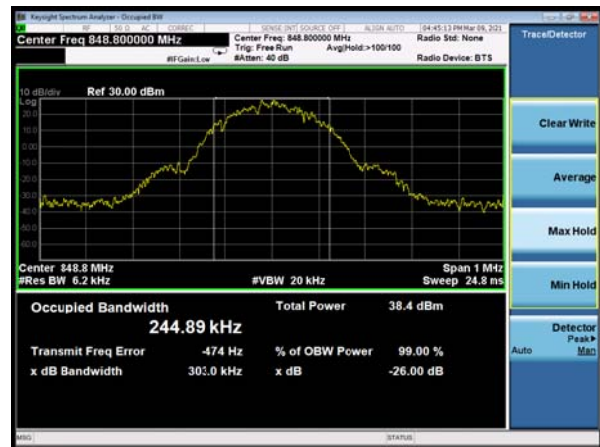

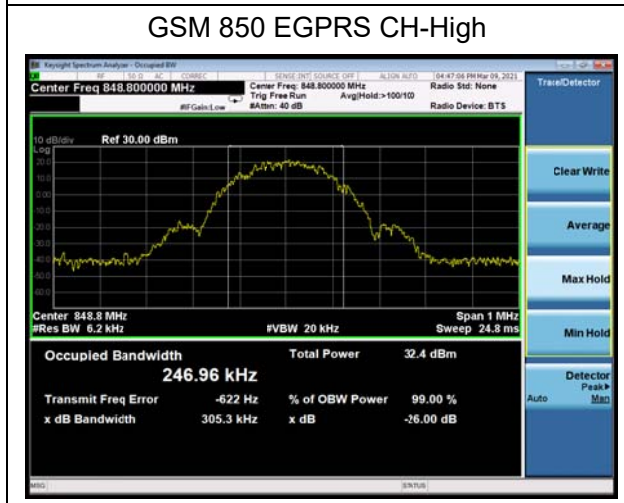
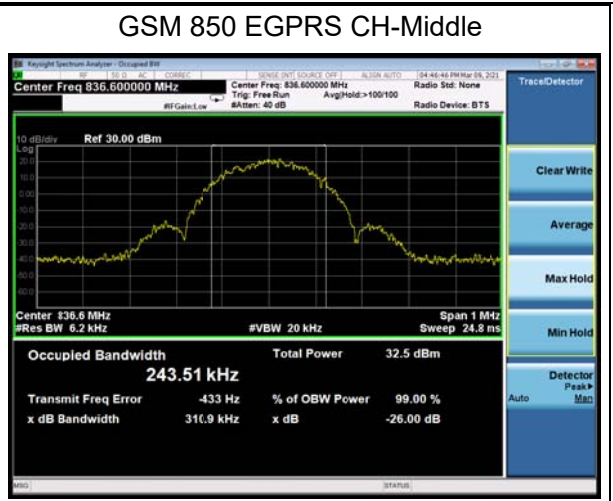
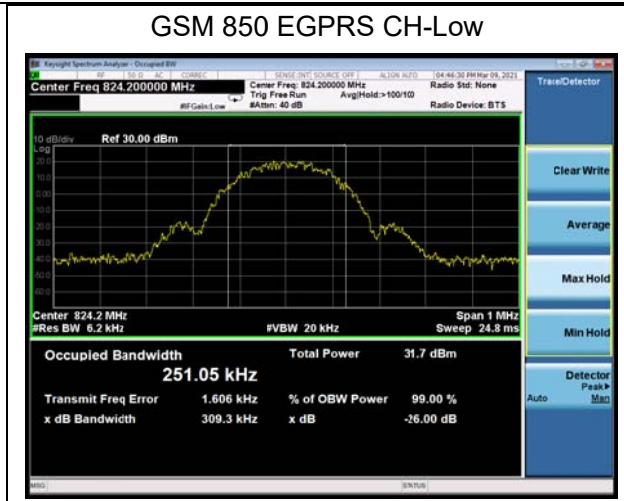

5.3. Band Edge Compliance

Ambient condition

Temperature	Relative humidity	Pressure
23°C ~25°C	45%~50%	101.5kPa

Method of Measurement

The EUT was connected to Spectrum Analyzer and Base Station Simulator via power Splitter. The band edge of the lowest and highest channels were measured. The average detector is used. RBW is set to 6.2kHz,VBW is set to 20kHz for GSM 850

Spectrum analyzer plots are included on the following pages.

Test Setup

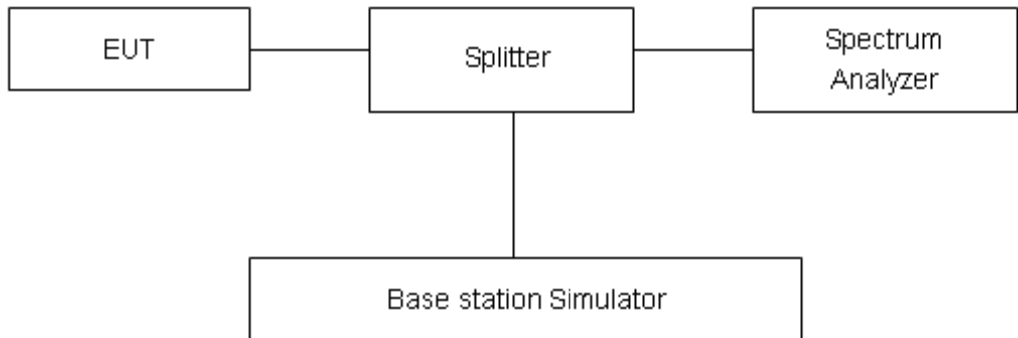

Limits

Rule Part 22.917(a) specifies that “The power of any emission outside of the authorized operating frequency ranges must be attenuated below the transmitting power (P) by a factor of at least 43 + 10 log(P) dB.”

Limit	-13 dBm
-------	---------

Measurement Uncertainty

The assessed measurement uncertainty to ensure 95% confidence level for the normal distribution is with the coverage factor $k = 1.96$, $U=0.684$ dB.



Test Result:

GSM 850 CH-Low

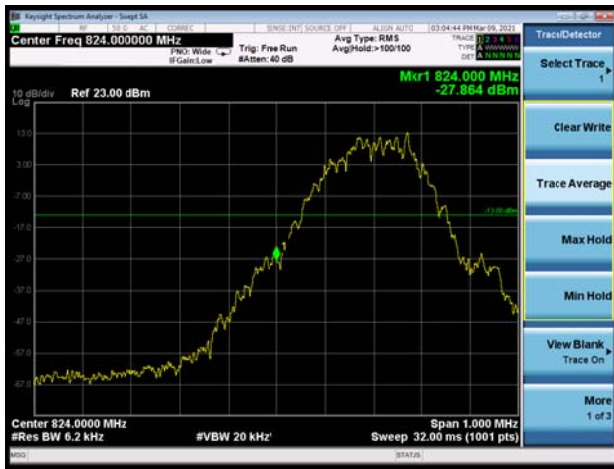

GSM 850 CH-High

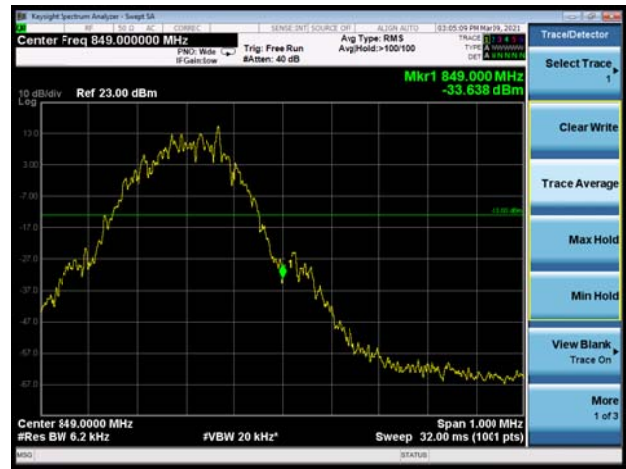

GSM 850 GPRS CH-Low

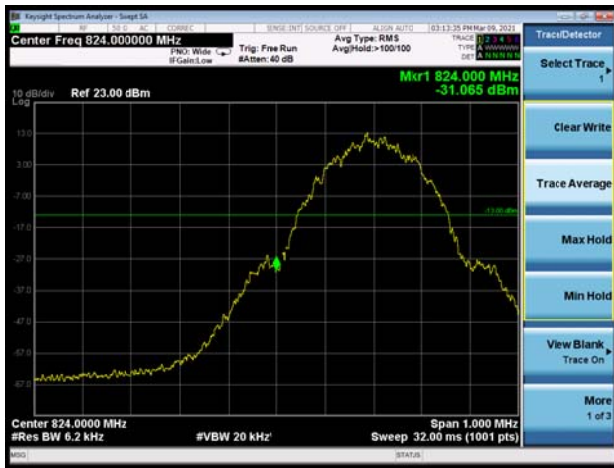

GSM 850 GPRS CH-High

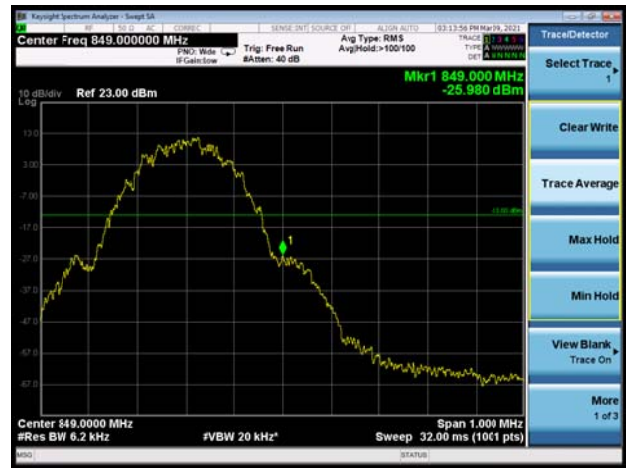

GSM 850 EGPRS CH-Low



GSM 850 EGPRS CH-High

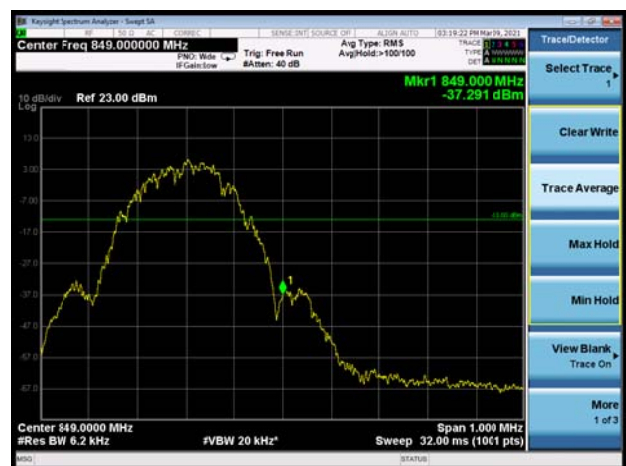

5.4. Peak-to-Average Power Ratio (PAPR)

Ambient condition

Temperature	Relative humidity	Pressure
23°C ~25°C	45%~50%	101.5kPa

Methods of Measurement

Measure the total peak power and record as P_{Pk} . And measure the total average power and record as P_{Avg} . Both the peak and average power levels must be expressed in the same logarithmic units (e.g., dBm). Determine the PAPR from:

$$PAPR (dB) = P_{Pk} (dBm) - P_{Avg} (dBm).$$

Test Setup

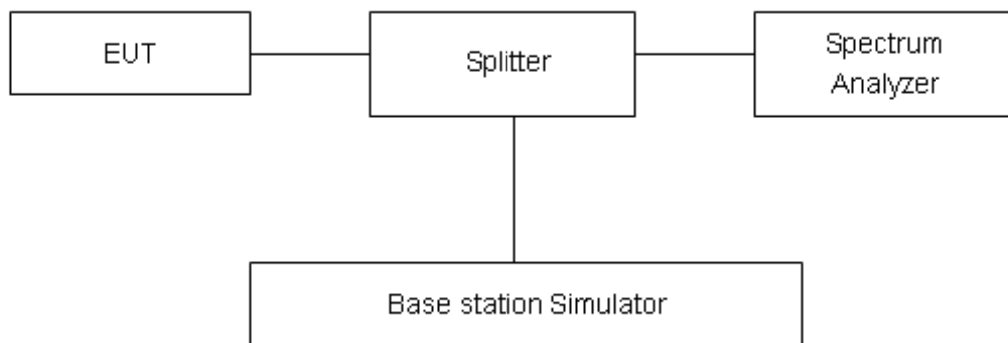

Limits

According to the Sec. 22.913(d), The peak-to-average ratio (PAR) of the transmission must not exceed 13 dB.

Measurement Uncertainty

The assessed measurement uncertainty to ensure 95% confidence level for the normal distribution is with the coverage factor $k = 2$, $U = 0.4$ dB.

**Test Results**

Mode	Channel	Frequency (MHz)	Peak (dBm)	Avg (dBm)	PAPR (dB)	Limit (dB)	Conclusion
GSM 850 (GMSK)	128	824.2	33.95	32.53	1.42	≤13	PASS
	190	836.6	34.51	33.06	1.45	≤13	PASS
	251	848.8	34.26	32.85	1.41	≤13	PASS
GPRS 850 (GMSK)	128	824.2	34.47	32.92	1.55	≤13	PASS
	190	836.6	34.49	32.98	1.51	≤13	PASS
	251	848.8	33.98	32.49	1.49	≤13	PASS
EGPRS 850 (8PSK)	128	824.2	28.42	26.81	1.61	≤13	PASS
	190	836.6	29.09	27.41	1.68	≤13	PASS
	251	848.8	28.46	26.86	1.60	≤13	PASS

5.5. Frequency Stability

Ambient condition

Temperature	Relative humidity	Pressure
23°C ~25°C	45%~50%	101.5kPa

Method of Measurement

Frequency Stability (Temperature Variation)

The temperature inside the climate chamber is varied from -30°C to +50°C in 10°C step size,

(1) With all power removed, the temperature was decreased to 0°C and permitted to stabilize for three hours.

(2) Measure the carrier frequency with the test equipment in a “call mode”. These measurements should be made within 1 minute of powering up the mobile station, to prevent significant self warming.

(3) Repeat the above measurements at 10°C increments from -30°C to +50°C. Allow at least 1.5 hours at each temperature, un-powered, before making measurements.

Frequency Stability (Voltage Variation)

The frequency stability shall be measured with variation of primary supply voltage as follows:

Primary Supply Voltage: The primary supply voltage is varied from 85% to 115% of the nominal value for non hand-carried battery and AC powered equipment. For hand-carried, battery-powered equipment, primary supply voltage is reduced to the battery operating end point which shall be specified by the manufacturer.

This transceiver is specified to operate with an input voltage of between 10.8 V and 13.2 V, with a nominal voltage of 12V.

Test setup

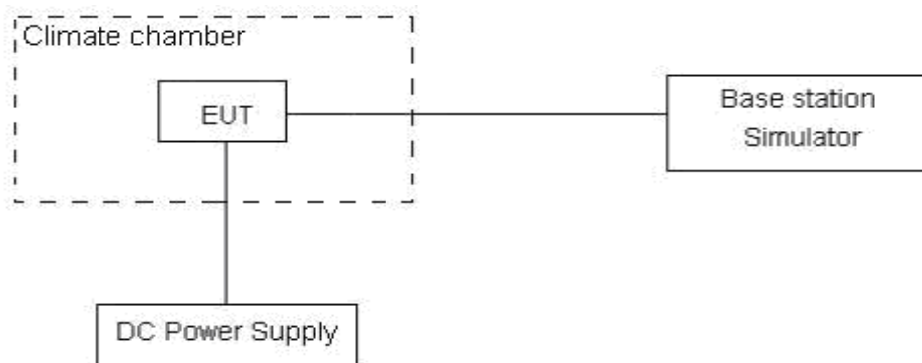

Limits

According to the Sec. 22.355, the frequency stability of the carrier shall be accurate to within 2.5 ppm of the received frequency for mobile stations.

Limits	≤ 2.5 ppm
--------	-----------

Measurement Uncertainty

The assessed measurement uncertainty to ensure 99.75% confidence level for the normal distribution is with the coverage factor $k = 3$, $U = 0.01\text{ppm}$.



Test Result

Condition		Freq.Error (Hz)	Freq.Error (Hz)	Frequency Stability (ppm)	Frequency Stability (ppm)	Verdict
Temperature	Voltage	GMSK	8PSK	GMSK	8PSK	
Normal (25°C)	Normal	14.76	15.00	0.00785	0.00798	PASS
Extreme (50°C)		17.09	14.55	0.00909	0.00774	PASS
Extreme (40°C)		7.83	11.61	0.00416	0.00618	PASS
Extreme (30°C)		4.69	13.37	0.00249	0.00711	PASS
Extreme (20°C)		14.12	2.49	0.00751	0.00132	PASS
Extreme (10°C)		2.71	7.83	0.00144	0.00417	PASS
Extreme (0°C)		6.51	14.09	0.00346	0.00750	PASS
Extreme (-10°C)		17.95	2.01	0.00955	0.00107	PASS
Extreme (-20°C)		5.70	15.90	0.00303	0.00846	PASS
Extreme (-30°C)		8.79	3.19	0.00468	0.00170	PASS
25°C		LV	13.22	7.31	0.00703	0.00389
	HV	2.74	2.50	0.00146	0.00133	PASS

5.6. Spurious Emissions at Antenna Terminals

Ambient condition

Temperature	Relative humidity	Pressure
23°C ~25°C	45%~50%	101.5kPa

Method of Measurement

The EUT was connected to Spectrum Analyzer and Base Station Simulator via power Splitter. The measurement is carried out using a spectrum analyzer. The spectrum analyzer scans from 9kHz to the 10th harmonic of the carrier.

The peak detector is used. RBW are set to 100 kHz and VBW are set to 300 kHz for below 1G, RBW are set to 1MHz and VBW are set to 3MHz for above 1G, Sweep is set to ATUO.

RBW is set to 1 kHz (0.009MHz~ 0.15 MHz),

RBW is set to 10 kHz (0.15 MHz~ 30 MHz)

RBW is set to 100 kHz (30MHz~1000 MHz)

RBW is set to 1000 kHz (above 1000MHz)

The modulation mode and RB allocation refer to section 5.1, using the maximum output power configuration.

Test setup

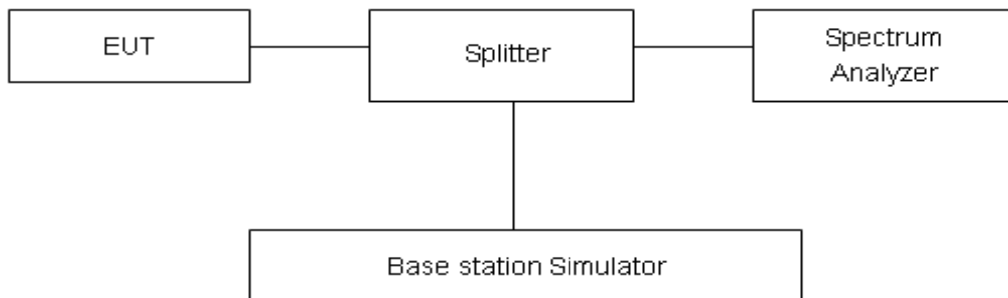

Limits

Rule Part 22.917(a) specifies that “The power of any emission outside of the authorized operating frequency ranges must be attenuated below the transmitting power (P) by a factor of at least 43 + 10 log (P) dB.”

Limit	-13 dBm

Measurement Uncertainty

The assessed measurement uncertainty to ensure 99.75% confidence level for the normal distribution is with the coverage factor $k = 1.96$.

Frequency	Uncertainty
9kHz-1GHz	0.684 dB
1GHz-18GHz	1.407 dB



Test Result

Sweep the whole frequency band through the range from 9kHz to the 10th harmonic of the carrier, the emissions more than 20 dB below the limit are not reported.

The signal beyond the limit is carrier.

GSM 850 CH-Low 9kHz ~ 9GHz



GPRS 850 CH-Low 9kHz ~ 9GHz

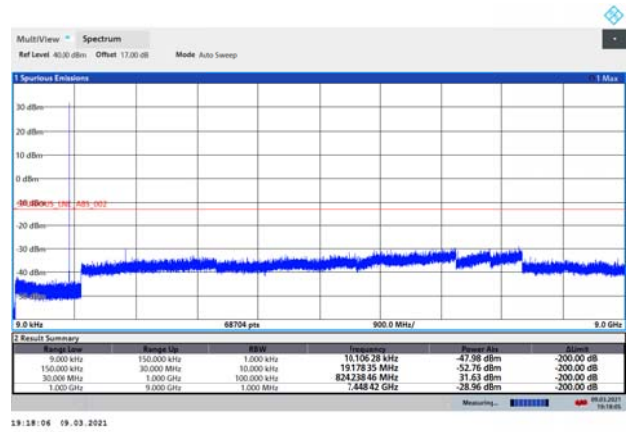

GSM 850 CH-Middle 9kHz ~ 9GHz

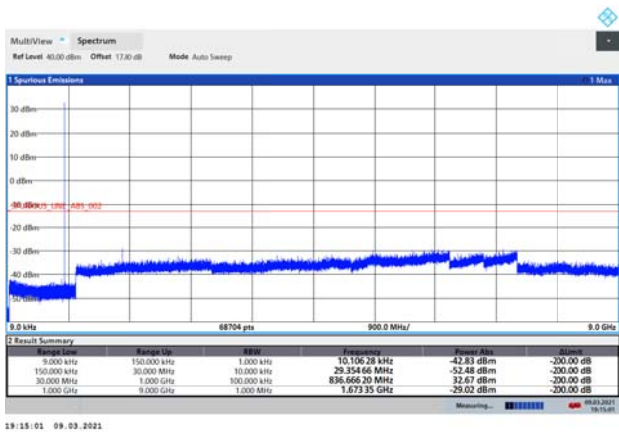

GPRS 850 CH-Middle 9kHz ~ 9GHz

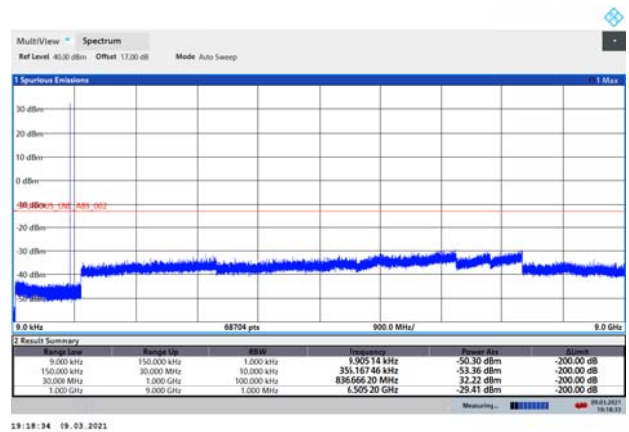

GSM 850 CH-High 9kHz ~ 9GHz



GPRS 850 CH-High 9kHz ~ 9GHz

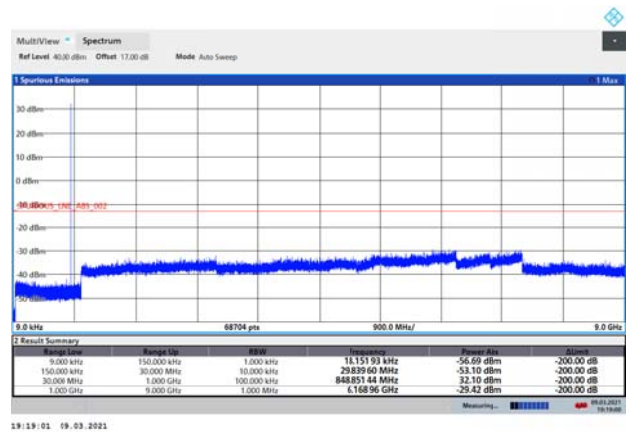



EGPRS 850 CH-Low 9kHz ~ 9GHz

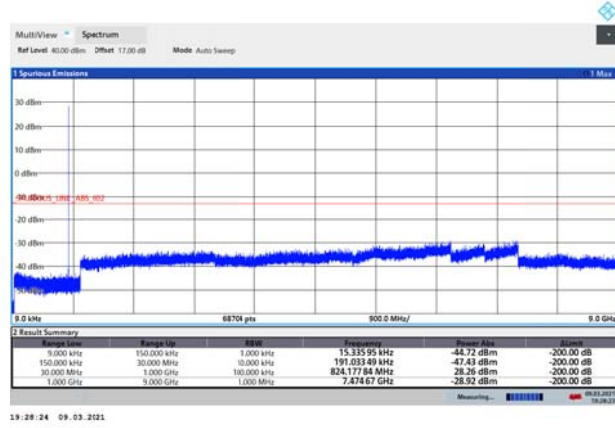

19:28:24 09.03.2021

EGPRS 850 CH-Middle 9kHz ~ 9GHz

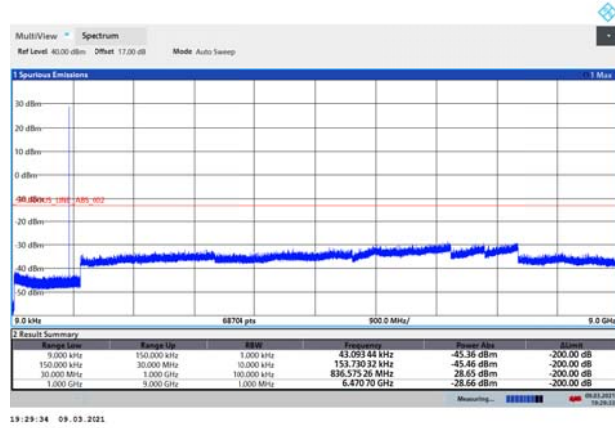

19:29:34 09.03.2021

EGPRS 850 CH-High 9kHz ~ 9GHz

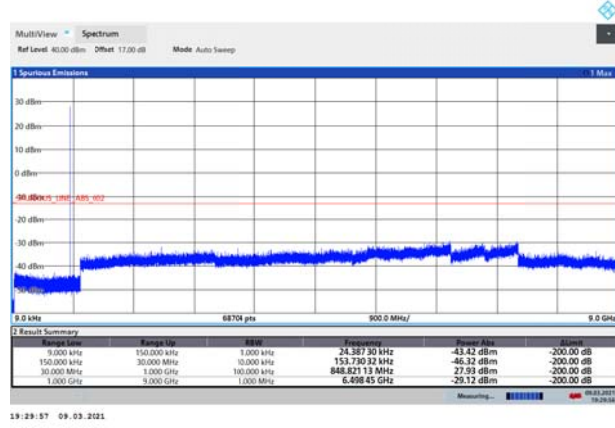

19:29:57 09.03.2021



5.7. Radiates Spurious Emission

Ambient condition

Temperature	Relative humidity	Pressure
23°C ~25°C	45%~50%	101.5kPa

Method of Measurement

1. The testing follows FCC KDB 971168 v03r01 Section 5.8 and ANSI C63.26 (2015).
2. Below 1GHz: The EUT is placed on a turntable 0.8 meters above the ground in the chamber, 3 meter away from the antenna. The maximal emission value is acquired by adjusting the antenna height, polarisation and turntable azimuth. Normally, the height range of antenna is 1 m to 4 m, the azimuth range of turntable is 0° to 360°, and the receive antenna has two polarizations Vertical (V) and Horizontal (H). Above 1GHz: (Note: the FCC's permission to use 1.5m as an alternative per TCBC Conf call of Dec. 2, 2014.) The EUT is placed on a turntable 1.5 meters above the ground in the chamber, 3 meter away from the antenna. The maximal emission value is acquired by adjusting the antenna height, polarisation and turntable azimuth. Normally, the height range of antenna is 1 m to 4 m, the azimuth range of turntable is 0° to 360°, and the receive antenna has two polarizations Vertical (V) and Horizontal (H).
3. A loop antenna, A log-periodic antenna or horn antenna shall be substituted in place of the EUT. The log-periodic antenna will be driven by a signal generator and the level will be adjusted till the same power value on the spectrum analyzer or receiver. The level of the spurious emissions can be calculated through the level of the signal generator, cable loss, the gain of the substitution antenna and the reading of the spectrum analyzer or receiver.
4. The EUT is then put into continuously transmitting mode at its maximum power level during the test. Set Test Receiver or Spectrum RBW=100kHz,VBW=300kHz, and the maximum value of the receiver should be recorded as (Pr).
5. The EUT shall be replaced by a substitution antenna. In the chamber, an substitution antenna for the frequency band of interest is placed at the reference point of the chamber. An RF Signal source for the frequency band of interest is connected to the substitution antenna with a cable that has been constructed to not interfere with the radiation pattern of the antenna. A power (PMea) is applied to the input of the substitution antenna, and adjust the level of the signal generator output until the value of the receiver reach the previously recorded (Pr). The power of signal source (PMea) is recorded. The test should be performed by rotating the test item and adjusting the receiving antenna polarization.
6. A amplifier should be connected to the Signal Source output port. And the cable should be connect between the Amplifier and the Substitution Antenna. The cable loss (Pcl) ,the Substitution Antenna Gain (Ga) and the Amplifier Gain (PAg) should be recorded after test.
7. The measurement results are obtained as described below:

$$\text{Power(EIRP)} = \text{PMea} - \text{PAg} - \text{Pcl} + \text{Ga}$$
 The measurement results are amend as described below:

$$\text{Power(EIRP)} = \text{PMea} - \text{Pcl} + \text{Ga}$$
8. This value is EIRP since the measurement is calibrated using an antenna of known gain (2.15 dBi) and known input power. ERP can be calculated from EIRP by subtracting the gain of the dipole, ERP

= EIRP-2.15dBi.

The modulation mode and RB allocation refer to section 5.1, using the maximum output power configuration.

Test setup

9KHz ~ 30MHz

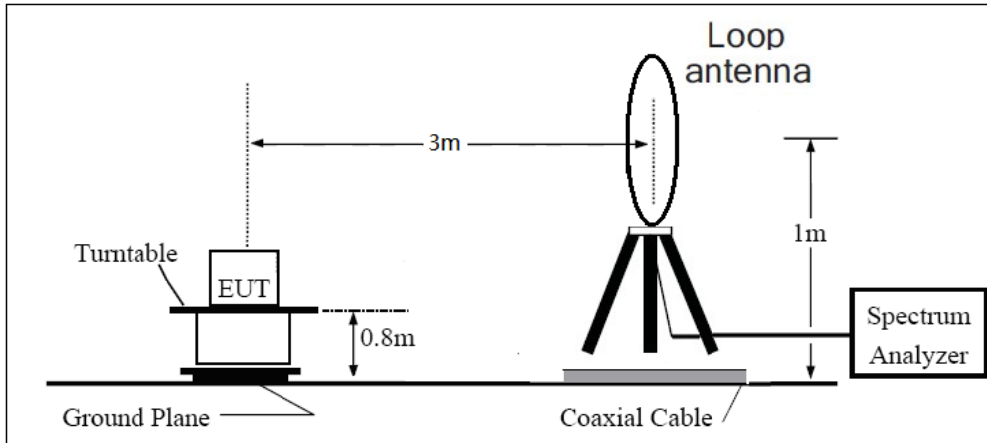

30MHz ~ 1GHz

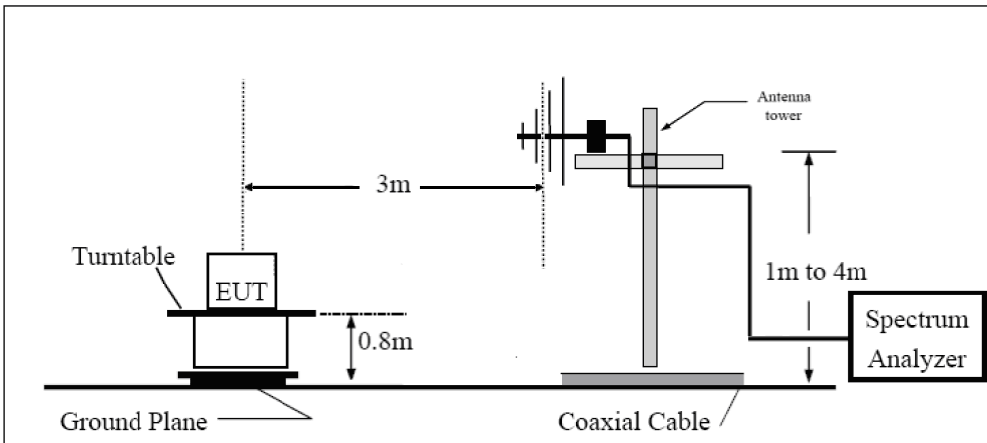

Above 1GHz

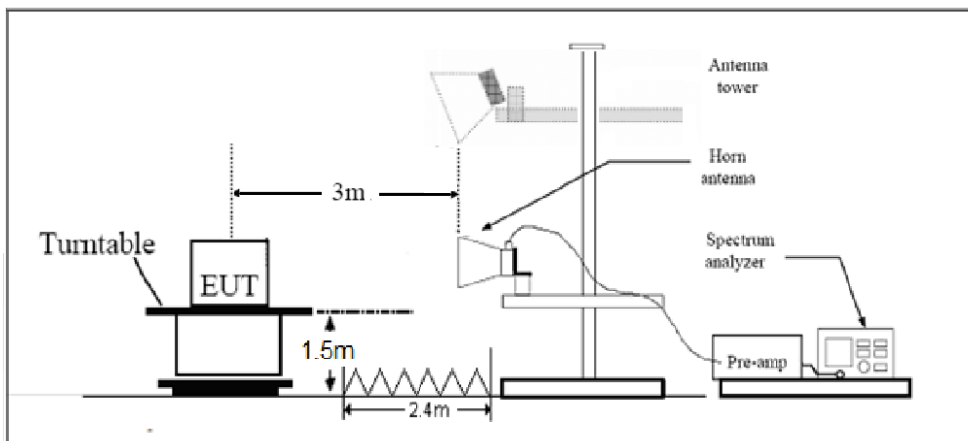

Note: Area side:2.4mX3.6m

**Limits**

Rule Part 22.917(a) specifies that “The power of any emission outside of the authorized operating frequency ranges must be attenuated below the transmitting power (P) by a factor of at least $43 + 10 \log (P)$ dB.”

Limit	-13 dBm
-------	---------

Measurement Uncertainty

The assessed measurement uncertainty to ensure 95% confidence level for the normal distribution is with the coverage factor $k = 1.96$, $U = 3.55$ dB.

**Test Result**

Sweep the whole frequency band through the range from 9kHz to the 10th harmonic of the carrier, the emissions below the noise floor will not be recorded in the report.

GSM 850 CH-Middle

Harmonic	Frequency (MHz)	SG (dBm)	Cable Loss (dB)	Gain (dBi)	Antenna Polarization	ERP Level (dBm)	Limit (dBm)	Margin (dB)	Azimuth (deg)
2	1673.20	-58.30	1.70	8.70	Horizontal	-53.45	-13.00	40.45	90
3	2509.80	-65.74	2.30	12.00	Horizontal	-58.19	-13.00	45.19	180
4	3346.40	-65.43	2.70	12.70	Horizontal	-57.58	-13.00	44.58	90
5	4183.00	-62.57	3.00	12.50	Horizontal	-55.22	-13.00	42.22	180
6	5019.60	-59.04	3.40	12.50	Horizontal	-52.09	-13.00	39.09	90
7	5856.20	-58.10	3.40	12.80	Horizontal	-50.85	-13.00	37.85	135
8	6692.80	-57.17	4.10	11.50	Horizontal	-51.92	-13.00	38.92	90
9	7529.40	-61.31	4.20	12.20	Horizontal	-55.46	-13.00	42.46	180
10	8366.00	-55.04	4.30	12.50	Horizontal	-48.99	-13.00	35.99	135

Note: 1.The other Spurious RF Radiated emissions level is no more than noise floor.

2.The worst emission was found in the antenna is Horizontal position.

6. Main Test Instruments

Name	Manufacturer	Type	Serial Number	Calibration Date	Expiration Date
Power Splitter	Hua Xiang	SHX-GF2-2-13	10120101	/	/
Spectrum Analyzer	Key sight	N9010A	MY50210259	2020-05-18	2021-05-17
Universal Radio Communication Tester	Key sight	E5515C	MY48367192	2021-05-15	2022-05-14
Signal Analyzer	R&S	FSV3030	101411	2020-12-13	2021-12-12
Loop Antenna	SCHWARZBECK	FMZB1519	1519-047	2020-04-02	2023-04-01
TRILOG Broadband Antenna	SCHWARZBECK	VULB 9163	391	2019-12-16	2021-12-15
Horn Antenna	R&S	HF907	102723	2018-08-11	2021-08-10
Horn Antenna	ETS-Lindgren	3160-09	00102643	2021-6-18	2021-12-17
Signal generator	R&S	SMB 100A	180235	2021-05-15	2022-05-14
Climatic Chamber	ESPEC	SU-242	93000506	2020-12-13	2021-12-12
Preamplifier	R&S	SCU18	102327	2021-05-15	2022-05-14
MOB COMMS DC SUPPLY	Keysight	66319D	MY43004105	2021-05-15	2022-05-14
RF Cable	Agilent	SMA 15cm	0001	2021-6-10	2021-12-9
Software	R&S	EMC32	9.26.0	/	/

*****END OF REPORT *****



ANNEX A: The EUT Appearance

The EUT Appearance are submitted separately.



ANNEX B: Test Setup Photos

The Test Setup Photos are submitted separately.