



TEST REPORT

APPLICANT : ZTE Corporation
PRODUCT NAME : WLAN Router
MODEL NAME : MC7010CA
BRAND NAME : ZTE
FCC ID : SRQ-MC7010CA
STANDARD(S) : 47 CFR Part 2
: 47 CFR Part 90, Subpart S
RECEIPT DATE : 2021-01-15
TEST DATE : 2021-01-29 to 2021-02-23
ISSUE DATE : 2021-03-04

Edited by: Zeng Xiaoying
Zeng Xiaoying (Rapporteur)
Approved by: Peng Huarui
Peng Huarui (Supervisor)

NOTE: This document is issued by MORLAB, the test report shall not be reproduced except in full without prior written permission of the company. The test results apply only to the particular sample(s) tested and to the specific tests carried out which is available on request for validation and information confirmed at our website.





DIRECTORY

- 1. Technical Information 3**
- 1.1. Applicant and Manufacturer Information 3**
- 1.2. Equipment Under Test (EUT) Description 3**
- 1.3. Maxium E.R.P./E.I.R.P. and Emission Designator 4**
- 1.4. Test Standards and Results 5**
- 1.5. Environmental Conditions 6**
- 2. 47 CFR Part 2, Part 90S Requirements 7**
- 2.1. Transmitter Conducted Output Power and E.R.P./E.I.R.P. 7**
- 2.2. Occupied Bandwidth 16**
- 2.3. Frequency Stability 23**
- 2.4. Peak to Average Radio 25**
- 2.5. Conducted Spurious Emissions 26**
- 2.6. Band Edge 32**
- 2.7. Radiated Spurious Emissions 35**
- Annex A Test Uncertainty 41**
- Annex B Testing Laboratory Information 42**

Change History		
Version	Date	Reason for change
1.0	2021-03-04	First edition



1. Technical Information

Note: Provide by applicant.

1.1. Applicant and Manufacturer Information

Applicant:	ZTE Corporation
Applicant Address:	ZTE Plaza, Keji Road South, Shenzhen, China.
Manufacturer:	ZTE Corporation
Manufacturer Address:	ZTE Plaza, Keji Road South, Shenzhen, China.

1.2. Equipment Under Test (EUT) Description

Product Name:	WLAN Router	
Serial No.:	(N/A, marked #1 by test site)	
Hardware Version:	MC7010CAHW1.0	
Software Version:	MC7010CAV1.1	
Modulation Type:	QPSK, 16QAM, 64QAM	
Operation Band:	Band 26	
Frequency Range:	LTE Band 26	Tx: 814MHz–824MHz
		Rx: 859MHz–869MHz
Channel Bandwidth	LTE Band 26	1.4MHz, 3MHz, 5MHz, 10MHz
Antenna Type:	Fixed Internal Antenna	
Antenna Gain:	LTE Band 26	1.0dBi
Accessory Information:	AC Adapter 1	
	Brand Name:	ZTE
	Model No.:	POE-A4803
	Serial No.:	(N/A, marked #1 by test site)
	Rated Output:	48V=0.31A
	Rated Input:	100-240V~50/60Hz, 0.5A
	Manufacturer:	ZTE Corporation

Note 1: For a more detailed description, please refer to Specification or User's Manual supplied by the applicant and/or manufacturer.



1.3. Maximum E.R.P./E.I.R.P. and Emission Designator

LTE Band 26	Maximum E.R.P./E.I.R.P. (W)			Emission Designator (99%OBW)		
	BW(MHz)	QPSK	16QAM	64QAM	QPSK	16QAM
10	0.141	0.124	0.092	8M97G7D	8M95W7D	8M98W7D
5	0.144	0.118	0.098	4M51G7D	4M52W7D	4M50W7D
3	0.144	0.118	0.094	2M70G7D	2M70W7D	2M70W7D
1.4	0.149	0.135	0.096	1M09G7D	1M10W7D	1M09W7D



1.4. Test Standards and Results

The objective of the report is to perform testing according to Part 2 and Part 90 for the EUT FCC ID Certification:

No.	Identity	Document Title
1	47 CFR Part 2	Frequency Allocations and Radio Treaty Matters; General Rules and Regulations
2	47 CFR Part 90	Miscellaneous Wireless Communications Services

Test detailed items/section required by FCC rules and results are as below:

Section	Description	Test Date	Test Engineer	Result	Method Determination /Remark
2.1046, 90.635(b)	Transmitter Conducted Output Power and ERP/EIRP	Feb 09, 2021	Ling Key Peng Xuewei	PASS	No deviation
2.1049 90.209	Occupied Bandwidth	Feb 05, 2021	Ling Key	PASS	No deviation
2.1055, 90.213	Frequency Stability	Feb 23, 2021	Ling Key	PASS	No deviation
N/A	Peak -Average Ratio	N/A	N/A	N/A	N/A
2.1051, 90.691	Conducted Spurious Emissions	Feb 06, 2021	Ling Key	PASS	No deviation
2.1051, 90.691	Band Edge	Feb 05, 2021	Ling Key	PASS	No deviation
2.1051, 90.691	Radiated Spurious Emissions	Jan 29, 2021	Peng Xuewei	PASS	No deviation

Note 1: The tests were performed according to the method of measurements prescribed in KDB971168 D01 v03 and ANSI/TIA-603-E-2016.

Note 2: The path loss during the RF test is calibrated to correct the results by the offset setting in the test equipments. The ref offset 23.5dB contains two parts that cable loss 13.5dB and Attenuator 10dB.

Note 3: Additions to, deviation, or exclusions from the method shall be judged in the "method determination" column of add, deviate or exclude from the specific method shall be explained in the "Remark" of the above table.



Note 4: When the test result is a critical value, we will use the measurement uncertainty give the judgment result based on the 95% risk level.

1.5. Environmental Conditions

During the measurement, the environmental conditions were within the listed ranges:

Temperature (°C):	15-35
Relative Humidity (%):	30-60
Atmospheric Pressure (kPa):	86-106

2.47 CFR Part 2, Part 90S Requirements

2.1. Transmitter Conducted Output Power and E.R.P./E.I.R.P.

2.1.1. Requirement

According to FCC section 2.1046(a), for transmitters other than single sideband, independent sideband and controlled carrier radiotelephone, power output shall be measured at the RF output terminals when the transmitter is adjusted in accordance with the tune-up procedure to give the values of current and voltage on the circuit elements specified in FCC section 2.1033(c)(8).

2.1.2. Test Description

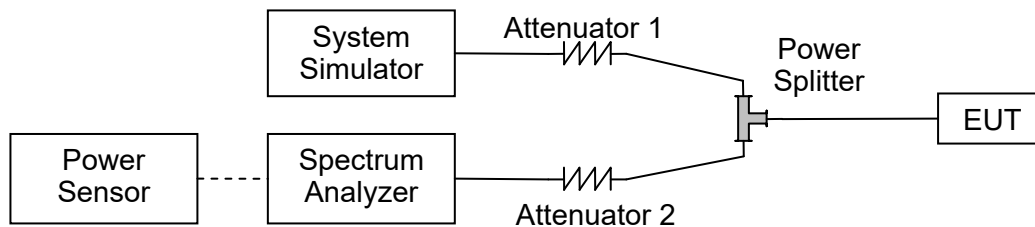

The EUT is coupled to the Spectrum Analyzer (SA) and the System Simulator (SS) with Attenuators through the Power Splitter; the RF load attached to the EUT antenna terminal is 50 Ohm; the path loss as the factor is calibrated to correct the reading. The EUT is commanded by the SS to operate at the maximum output power. A call is established between the EUT and the SS.

2.1.3. Test procedure

KDB 971168 D01v03 Section 5.2 and ANSI/TIA-603-E-2016.

$EIRP \text{ (dBm)} = \text{Conducted Output Power (dBm)} + \text{Antenna Gain (dBi)}$

$ERP \text{ (dBm)} = EIPR \text{ (dBm)} - 2.15$



2.1.4. Result

Conducted Output Power:

LTE Band 26						
BW [MHz]	Modulation	RB Size	RB Offset	Average Power Low Ch. / Freq.	Average Power Middle Ch. / Freq.	Average Power High Ch. / Freq.
Channel				/	26740	/
Frequency (MHz)				/	819.0	/
10	QPSK	1	0	/	22.46	/
10	QPSK	1	25	/	22.63	/
10	QPSK	1	49	/	22.55	/
10	QPSK	25	0	/	22.05	/
10	QPSK	25	12	/	22.22	/
10	QPSK	25	25	/	22.10	/
10	QPSK	50	0	/	22.09	/
10	16QAM	1	0	/	21.66	/
10	16QAM	1	25	/	21.68	/
10	16QAM	1	49	/	21.66	/
10	16QAM	25	0	/	21.40	/
10	16QAM	25	12	/	21.08	/
10	16QAM	25	25	/	21.16	/
10	16QAM	50	0	/	21.30	/
10	64QAM	1	0	/	20.77	/
10	64QAM	1	25	/	20.75	/
10	64QAM	1	49	/	20.64	/
10	64QAM	25	0	/	20.74	/
10	64QAM	25	12	/	20.54	/
10	64QAM	25	25	/	20.49	/
10	64QAM	50	0	/	20.63	/



LTE Band 26						
BW [MHz]	Modulation	RB Size	RB Offset	Average Power Low Ch. / Freq.	Average Power Middle Ch. / Freq.	Average Power High Ch. / Freq.
Channel				26715	26740	26765
Frequency (MHz)				816.5	819.0	821.5
5	QPSK	1	0	22.69	22.73	22.54
5	QPSK	1	12	22.62	22.61	22.50
5	QPSK	1	24	22.65	22.72	22.48
5	QPSK	12	0	22.63	22.49	22.37
5	QPSK	12	7	22.55	22.54	22.48
5	QPSK	12	13	22.63	22.40	22.39
5	QPSK	25	0	22.42	22.46	22.46
5	16QAM	1	0	21.55	21.75	21.55
5	16QAM	1	12	21.62	21.56	21.86
5	16QAM	1	24	21.55	21.72	21.80
5	16QAM	12	0	21.74	21.69	21.49
5	16QAM	12	7	21.66	21.67	21.62
5	16QAM	12	13	21.65	21.52	21.51
5	16QAM	25	0	21.52	21.67	21.46
5	64QAM	1	0	20.72	21.07	20.87
5	64QAM	1	12	20.66	20.82	20.99
5	64QAM	1	24	20.81	20.84	20.94
5	64QAM	12	0	20.64	20.80	20.66
5	64QAM	12	7	20.76	20.72	20.75
5	64QAM	12	13	20.85	20.89	20.94
5	64QAM	25	0	20.93	20.99	20.99



LTE Band 26						
BW [MHz]	Modulation	RB Size	RB Offset	Average Power Low Ch. / Freq.	Average Power Middle Ch. / Freq.	Average Power High Ch. / Freq.
Channel				26705	26740	26775
Frequency (MHz)				815.5	819.0	822.5
3	QPSK	1	0	22.40	22.55	22.39
3	QPSK	1	8	22.45	22.58	22.56
3	QPSK	1	14	22.73	22.48	22.52
3	QPSK	8	0	22.16	21.94	21.92
3	QPSK	8	4	22.00	22.03	22.00
3	QPSK	8	7	22.22	21.88	21.91
3	QPSK	15	0	22.19	21.97	21.96
3	16QAM	1	0	21.55	21.61	21.47
3	16QAM	1	8	21.66	21.66	21.49
3	16QAM	1	14	21.86	21.53	21.56
3	16QAM	8	0	21.25	21.05	21.03
3	16QAM	8	4	21.21	21.16	21.01
3	16QAM	8	7	21.24	20.96	21.21
3	16QAM	15	0	21.26	21.08	21.05
3	64QAM	1	0	20.55	20.87	20.52
3	64QAM	1	8	20.51	20.60	21.12
3	64QAM	1	14	20.62	20.71	20.57
3	64QAM	8	0	20.65	20.84	20.83
3	64QAM	8	4	20.62	20.84	20.76
3	64QAM	8	7	20.66	20.88	20.83
3	64QAM	15	0	20.72	20.84	20.73



LTE Band 26						
BW [MHz]	Modulation	RB Size	RB Offset	Average Power Low Ch. / Freq.	Average Power Middle Ch. / Freq.	Average Power High Ch. / Freq.
Channel				26697	26740	26783
Frequency (MHz)				814.7	819.0	823.3
1.4	QPSK	1	0	22.61	22.85	22.71
1.4	QPSK	1	3	22.61	22.87	22.70
1.4	QPSK	1	5	22.47	22.75	22.74
1.4	QPSK	3	0	22.10	22.27	22.24
1.4	QPSK	3	1	22.17	22.38	22.37
1.4	QPSK	3	3	22.14	22.33	22.34
1.4	QPSK	6	0	22.58	22.46	22.42
1.4	16QAM	1	0	22.22	22.29	21.99
1.4	16QAM	1	3	22.22	22.39	22.45
1.4	16QAM	1	5	22.23	21.97	21.93
1.4	16QAM	3	0	22.37	22.00	22.09
1.4	16QAM	3	1	22.19	22.06	21.93
1.4	16QAM	3	3	22.18	22.04	22.04
1.4	16QAM	6	0	22.18	22.09	22.03
1.4	64QAM	1	0	20.95	20.89	20.97
1.4	64QAM	1	3	20.73	20.81	20.91
1.4	64QAM	1	5	20.60	20.77	20.82
1.4	64QAM	3	0	20.93	20.86	20.84
1.4	64QAM	3	1	20.86	20.90	20.98
1.4	64QAM	3	3	20.74	20.89	20.79
1.4	64QAM	6	0	20.86	20.99	20.83



Effective Radiated Power and Effective Isotropic Radiated Power:

LTE Band 26				Measured E.R.P.			
BW [MHz]	Modulation	RB Size	RB Offset	Low Ch. / Freq.	Middle Ch. / Freq.	High Ch. / Freq.	
Channel				/	26740	/	
Frequency (MHz)				/	819	/	
				/	dBm	W	/
10	QPSK	1	0	/	21.31	0.135	/
10	QPSK	1	25	/	21.48	0.141	/
10	QPSK	1	49	/	21.40	0.138	/
10	QPSK	25	0	/	20.90	0.123	/
10	QPSK	25	12	/	21.07	0.128	/
10	QPSK	25	25	/	20.95	0.124	/
10	QPSK	50	0	/	20.94	0.124	/
10	16QAM	1	0	/	20.51	0.112	/
10	16QAM	1	25	/	20.53	0.113	/
10	16QAM	1	49	/	20.51	0.112	/
10	16QAM	25	0	/	20.25	0.106	/
10	16QAM	25	12	/	19.93	0.098	/
10	16QAM	25	25	/	20.01	0.100	/
10	16QAM	50	0	/	20.15	0.104	/
10	64QAM	1	0	/	19.62	0.092	/
10	64QAM	1	25	/	19.60	0.091	/
10	64QAM	1	49	/	19.49	0.089	/
10	64QAM	25	0	/	19.59	0.091	/
10	64QAM	25	12	/	19.39	0.087	/
10	64QAM	25	25	/	19.34	0.086	/
10	64QAM	50	0	/	19.48	0.089	/



LTE Band 26				Measured E.R.P.					
BW [MHz]	Modulation	RB Size	RB Offset	Low Ch. / Freq.		Middle Ch. / Freq.		High Ch. / Freq.	
Channel				26715		26740		26765	
Frequency (MHz)				816.5		819.0		821.5	
				dBm	W	dBm	W	dBm	W
5	QPSK	1	0	21.54	0.143	21.58	0.144	21.39	0.138
5	QPSK	1	12	21.47	0.140	21.46	0.140	21.35	0.136
5	QPSK	1	24	21.50	0.141	21.57	0.144	21.33	0.136
5	QPSK	12	0	21.48	0.141	21.34	0.136	21.22	0.132
5	QPSK	12	7	21.40	0.138	21.39	0.138	21.33	0.136
5	QPSK	12	13	21.48	0.141	21.25	0.133	21.24	0.133
5	QPSK	25	0	21.27	0.134	21.31	0.135	21.31	0.135
5	16QAM	1	0	20.40	0.110	20.60	0.115	20.40	0.110
5	16QAM	1	12	20.47	0.111	20.41	0.110	20.71	0.118
5	16QAM	1	24	20.40	0.110	20.57	0.114	20.65	0.116
5	16QAM	12	0	20.59	0.115	20.54	0.113	20.34	0.108
5	16QAM	12	7	20.51	0.112	20.52	0.113	20.47	0.111
5	16QAM	12	13	20.50	0.112	20.37	0.109	20.36	0.109
5	16QAM	25	0	20.37	0.109	20.52	0.113	20.31	0.107
5	64QAM	1	0	19.57	0.091	19.92	0.098	19.72	0.094
5	64QAM	1	12	19.51	0.089	19.67	0.093	19.84	0.096
5	64QAM	1	24	19.66	0.092	19.69	0.093	19.79	0.095
5	64QAM	12	0	19.49	0.089	19.65	0.092	19.51	0.089
5	64QAM	12	7	19.61	0.091	19.57	0.091	19.60	0.091
5	64QAM	12	13	19.70	0.093	19.74	0.094	19.79	0.095
5	64QAM	25	0	19.78	0.095	19.84	0.096	19.84	0.096



LTE Band 26				Measured E.R.P.					
BW [MHz]	Modulation	RB Size	RB Offset	Low Ch. / Freq.		Middle Ch. / Freq.		High Ch. / Freq.	
Channel				26705		26740		26775	
Frequency (MHz)				815.5		819.0		822.5	
				dBm	W	dBm	W	dBm	W
3	QPSK	1	0	21.25	0.133	21.40	0.138	21.24	0.133
3	QPSK	1	8	21.30	0.135	21.43	0.139	21.41	0.138
3	QPSK	1	14	21.58	0.144	21.33	0.136	21.37	0.137
3	QPSK	8	0	21.01	0.126	20.79	0.120	20.77	0.119
3	QPSK	8	4	20.85	0.122	20.88	0.122	20.85	0.122
3	QPSK	8	7	21.07	0.128	20.73	0.118	20.76	0.119
3	QPSK	15	0	21.04	0.127	20.82	0.121	20.81	0.121
3	16QAM	1	0	20.40	0.110	20.46	0.111	20.32	0.108
3	16QAM	1	8	20.51	0.112	20.51	0.112	20.34	0.108
3	16QAM	1	14	20.71	0.118	20.38	0.109	20.41	0.110
3	16QAM	8	0	20.10	0.102	19.90	0.098	19.88	0.097
3	16QAM	8	4	20.06	0.101	20.01	0.100	19.86	0.097
3	16QAM	8	7	20.09	0.102	19.81	0.096	20.06	0.101
3	16QAM	15	0	20.11	0.103	19.93	0.098	19.90	0.098
3	64QAM	1	0	19.40	0.087	19.72	0.094	19.37	0.086
3	64QAM	1	8	19.36	0.086	19.45	0.088	19.97	0.099
3	64QAM	1	14	19.47	0.089	19.56	0.090	19.42	0.087
3	64QAM	8	0	19.50	0.089	19.69	0.093	19.68	0.093
3	64QAM	8	4	19.47	0.089	19.69	0.093	19.61	0.091
3	64QAM	8	7	19.51	0.089	19.73	0.094	19.68	0.093
3	64QAM	15	0	19.57	0.091	19.69	0.093	19.58	0.091



LTE Band 26				Measured E.R.P.					
BW [MHz]	Modulation	RB Size	RB Offset	Low Ch. / Freq.		Middle Ch. / Freq.		High Ch. / Freq.	
Channel				26697		26740		26783	
Frequency (MHz)				814.7		819.0		823.3	
				dBm	W	dBm	W	dBm	W
1.4	QPSK	1	0	21.46	0.140	21.70	0.148	21.56	0.143
1.4	QPSK	1	3	21.46	0.140	21.72	0.149	21.55	0.143
1.4	QPSK	1	5	21.32	0.136	21.60	0.145	21.59	0.144
1.4	QPSK	3	0	20.95	0.124	21.12	0.129	21.09	0.129
1.4	QPSK	3	1	21.02	0.126	21.23	0.133	21.22	0.132
1.4	QPSK	3	3	20.99	0.126	21.18	0.131	21.19	0.132
1.4	QPSK	6	0	21.43	0.139	21.31	0.135	21.27	0.134
1.4	16QAM	1	0	21.07	0.128	21.14	0.130	20.84	0.121
1.4	16QAM	1	3	21.07	0.128	21.24	0.133	21.30	0.135
1.4	16QAM	1	5	21.08	0.128	20.82	0.121	20.78	0.120
1.4	16QAM	3	0	21.22	0.132	20.85	0.122	20.94	0.124
1.4	16QAM	3	1	21.04	0.127	20.91	0.123	20.78	0.120
1.4	16QAM	3	3	21.03	0.127	20.89	0.123	20.89	0.123
1.4	16QAM	6	0	21.03	0.127	20.94	0.124	20.88	0.122
1.4	64QAM	1	0	19.80	0.095	19.74	0.094	19.82	0.096
1.4	64QAM	1	3	19.58	0.091	19.66	0.092	19.76	0.095
1.4	64QAM	1	5	19.45	0.088	19.62	0.092	19.67	0.093
1.4	64QAM	3	0	19.78	0.095	19.71	0.094	19.69	0.093
1.4	64QAM	3	1	19.71	0.094	19.75	0.094	19.83	0.096
1.4	64QAM	3	3	19.59	0.091	19.74	0.094	19.64	0.092
1.4	64QAM	6	0	19.71	0.094	19.84	0.096	19.68	0.093

2.2. Occupied Bandwidth

2.2.1. Requirement

According to FCC section 2.1049, the occupied bandwidth is the frequency bandwidth such that, below its lower and above its upper frequency limits, the mean powers radiated are each equal to 0.5 percent of the total mean power radiated by a given emission. Occupied bandwidth is also known as the 99% emission bandwidth.

2.2.2. Test Description

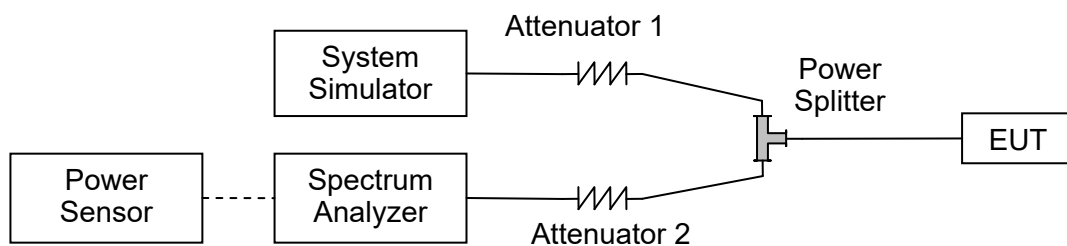

The EUT is coupled to the Spectrum Analyzer (SA) and the System Simulator (SS) with Attenuators through the Power Splitter; the RF load attached to the EUT antenna terminal is 50Ohm; the path loss as the factor is calibrated to correct the reading. The EUT is commanded by the SS to operate at the maximum output power. A call is established between the EUT and the SS.

2.2.3. Test procedure

KDB 971168 D01v03 Section 4.1 and ANSI/TIA-603-E-2016.

2.2.4. Test Result



LTE Band 26				
BW(MHz)	Channel Level	Modulation	99% BW(MHz)	26dB BW(MHz)
1.4	Low	QPSK	1.09	1.24
	Low	16QAM	1.10	1.23
	Low	64QAM	1.09	1.24
	Mid	QPSK	1.09	1.24
	Mid	16QAM	1.09	1.23
	Mid	64QAM	1.09	1.23
	High	QPSK	1.09	1.24
	High	16QAM	1.09	1.23
	High	64QAM	1.09	1.23
3	Low	QPSK	2.70	3.00
	Low	16QAM	2.70	3.02
	Low	64QAM	2.70	3.00
	Mid	QPSK	2.70	2.98
	Mid	16QAM	2.70	3.02
	Mid	64QAM	2.70	2.99
	High	QPSK	2.70	3.01
	High	16QAM	2.70	3.01
	High	64QAM	2.70	3.04
5	Low	QPSK	4.50	4.95
	Low	16QAM	4.52	4.95
	Low	64QAM	4.50	4.96
	Mid	QPSK	4.51	4.98
	Mid	16QAM	4.51	4.97
	Mid	64QAM	4.50	4.93
	High	QPSK	4.51	4.98
	High	16QAM	4.51	4.93
	High	64QAM	4.50	4.93
10	Mid	QPSK	8.97	9.87
	Mid	16QAM	8.95	9.76
	Mid	64QAM	8.98	9.76

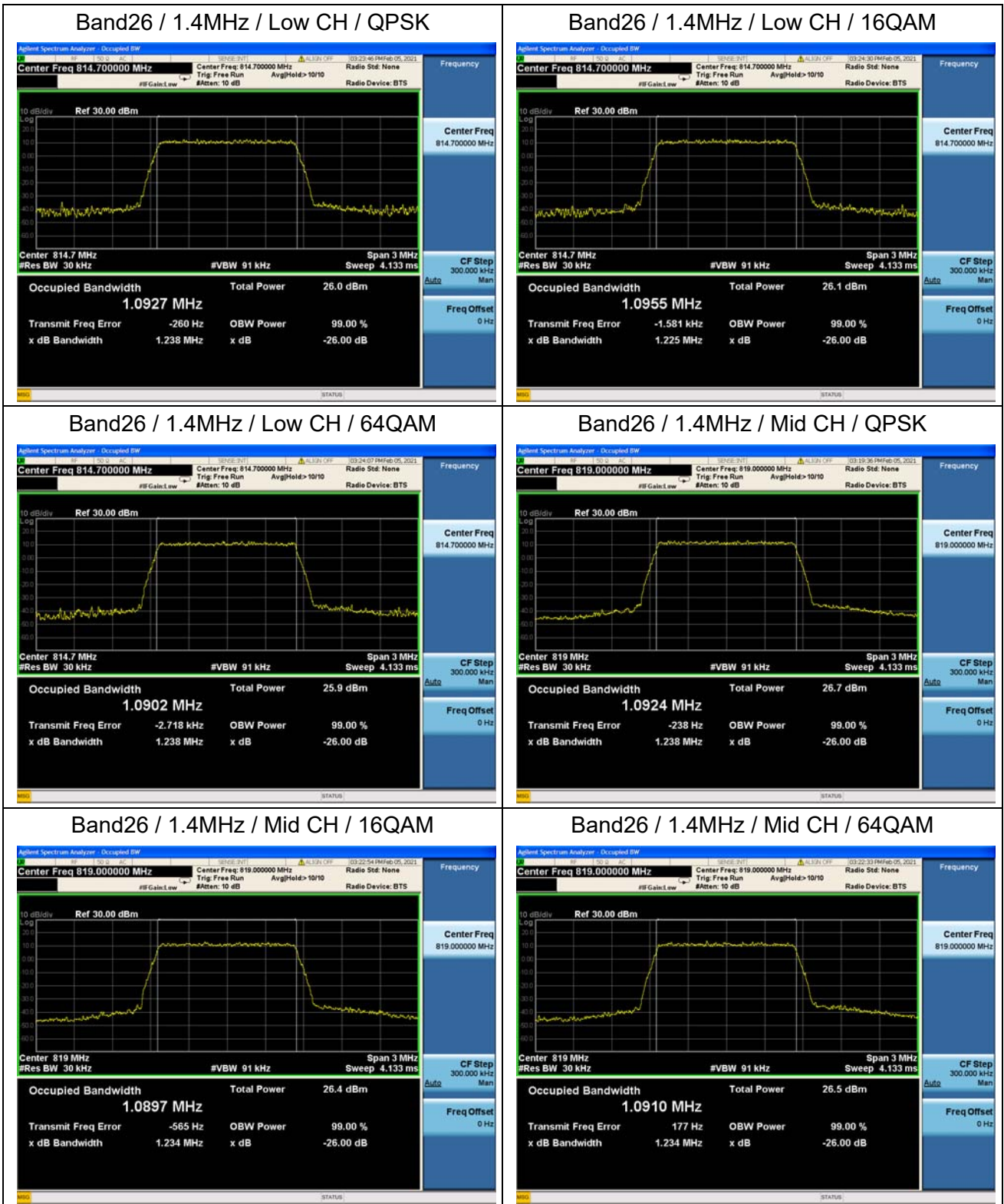

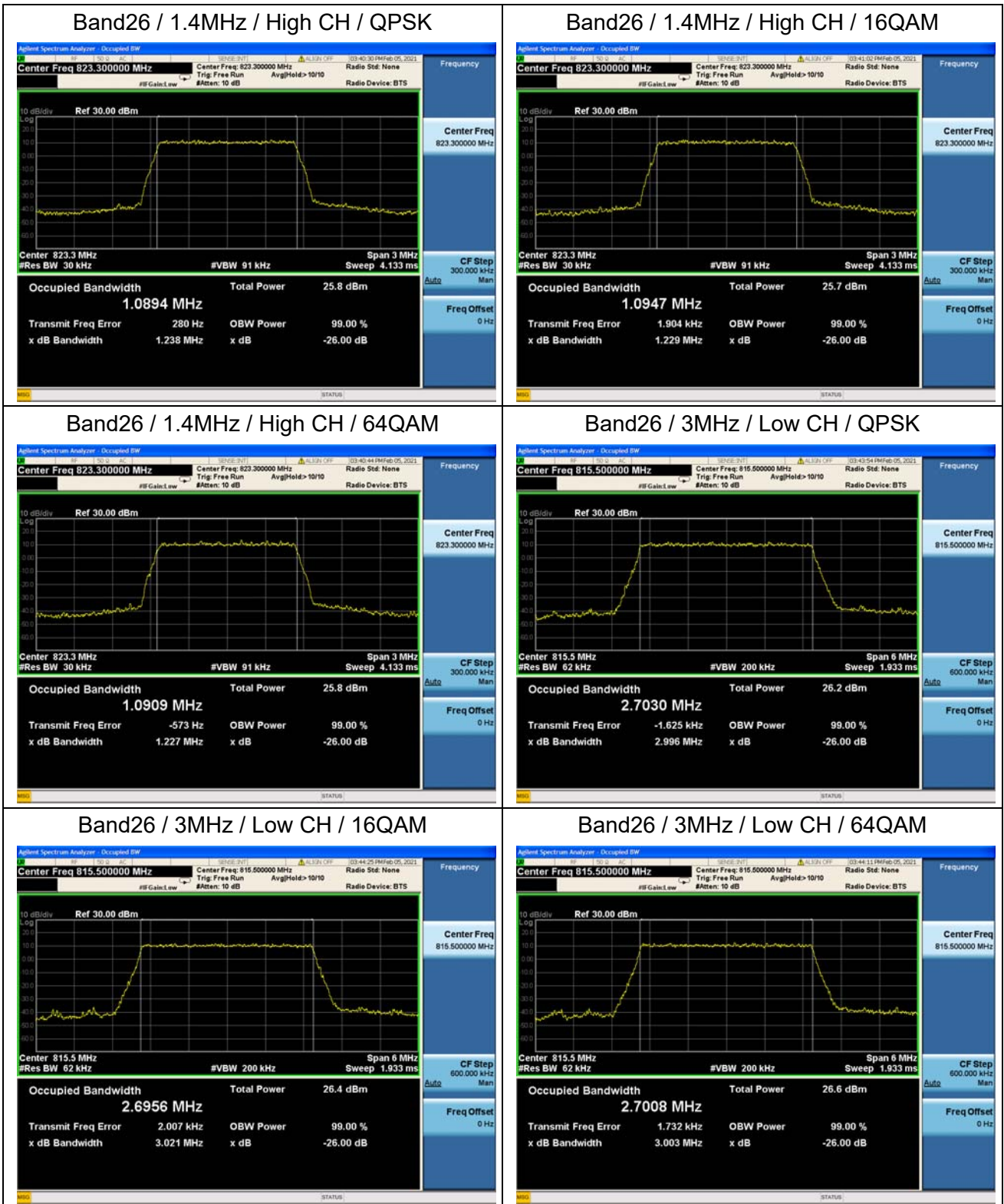

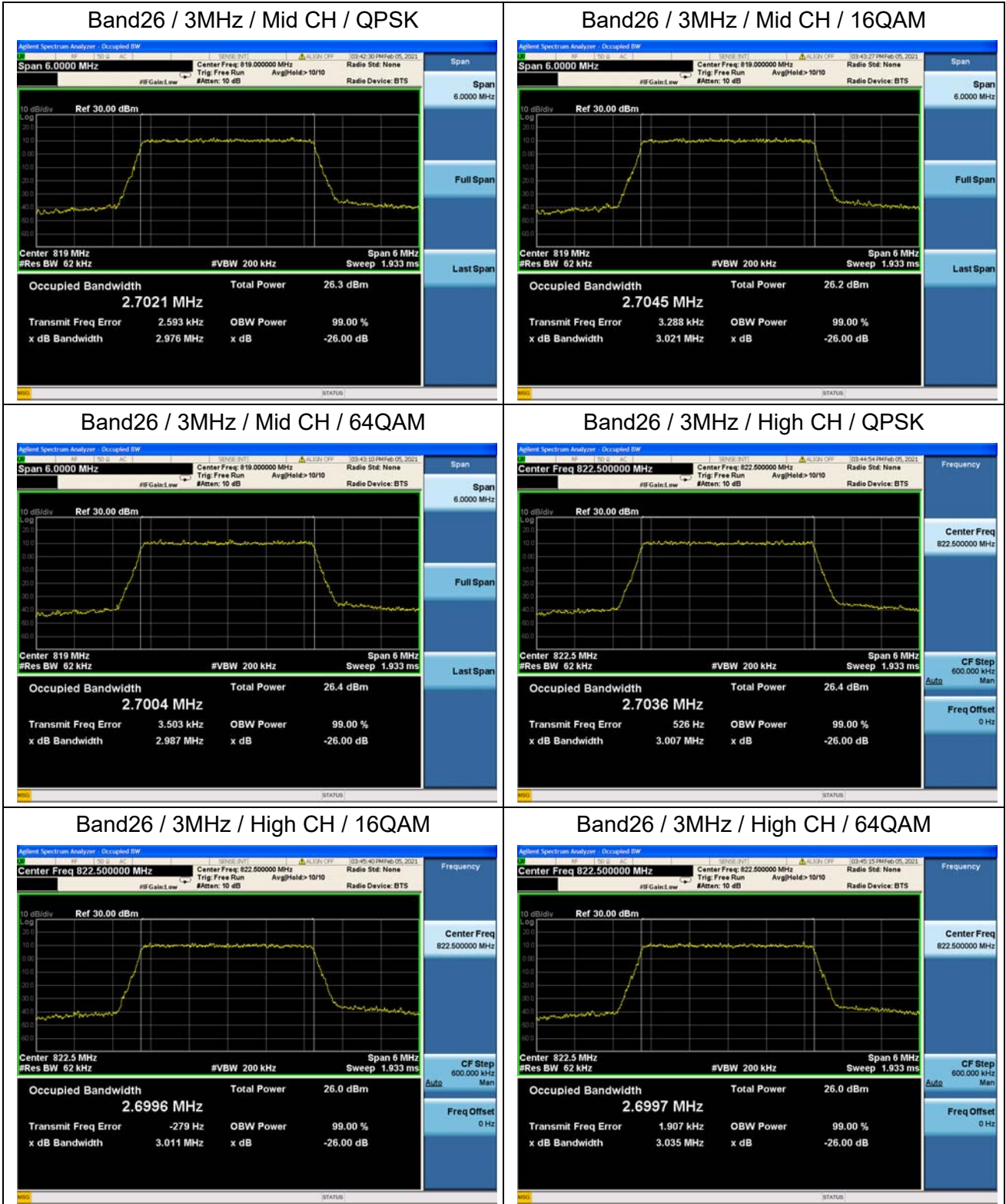

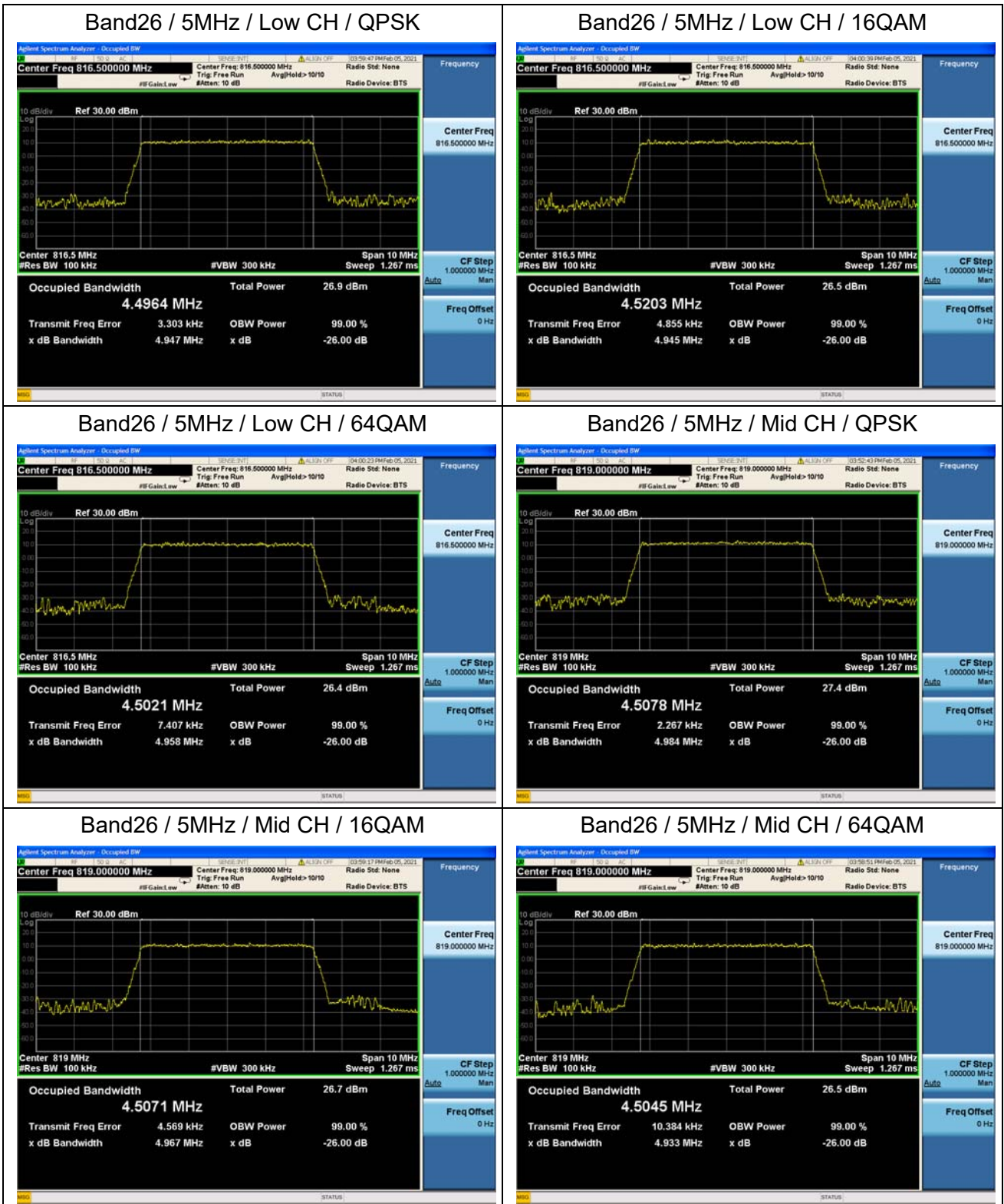

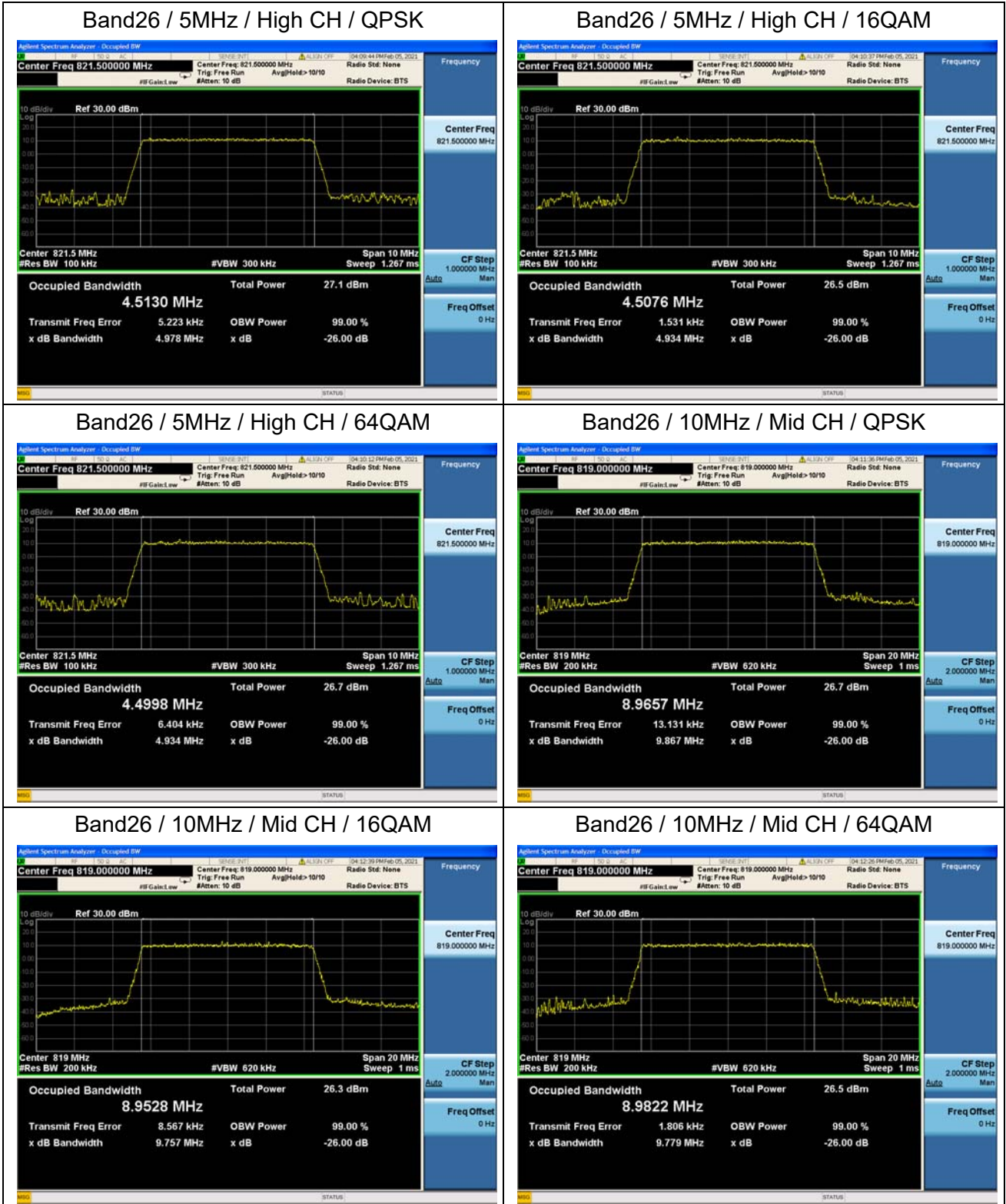

2.3. Frequency Stability

2.3.1. Requirement

According to FCC section 2.1055 & 90.213, the frequency stability shall be sufficient to ensure that the fundamental emission stays within the authorized frequency block. According to FCC section 2.1055, the test conditions are:

- (a) The temperature is varied from -30°C to $+50^{\circ}\text{C}$ at intervals of not more than 10°C .
- (b) For hand carried battery powered equipment, the primary supply voltage is reduced to the battery operating end point which shall be specified by the manufacture. The supply voltage shall be measured at the input to the cable normally provided with the equipment, or at the power supply terminals if cables are not normally provided.

Note: The operating temperature of EUT is from -20°C to 55°C , which are specified by the applicant.

2.3.2. Test Description

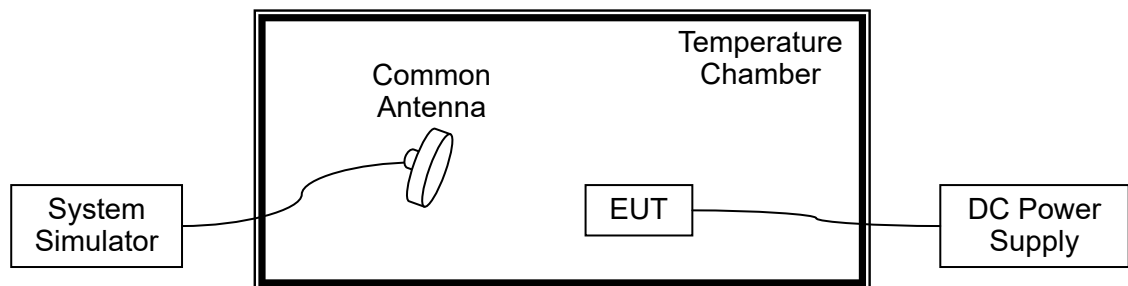

The EUT which is powered by the DC Power Supply directly, is located in the Temperature Chamber. The EUT is commanded by the System Simulator (SS) to operate at the maximum output power. A call is established between the EUT and the SS via a Common Antenna.

2.3.3. Test procedure

KDB 971168 D01v03 Section 9.0 and ANSI/TIA-603-E-2016.



2.3.4. Test Result

The nominal, highest and lowest extreme voltages are separately 48V, 57V and 44V, which are specified by the applicant; the normal temperature here used is 20°C.

LTE Band 26, QPSK, Channel 26740, Frequency 819MHz					
Limit =±2.5ppm					
Voltage (%)	Power (VDC)	Temp(°C)	Fre. Dev.(Hz)	Deviation (ppm)	Result
100	48	+20(Ref)	-25	-0.031	PASS
100		-20	35	0.043	
100		-10	-20	-0.024	
100		0	27	0.033	
100		+10	-14	-0.017	
100		+20	-37	-0.045	
100		+30	48	0.059	
100		+40	42	0.051	
100		+50	38	0.046	
100		+55	31	0.038	
115		57	+20	34	
85	44	+20	27	0.033	

2.4. Peak to Average Ratio

2.4.1. Requirement

2.4.2. Test Description

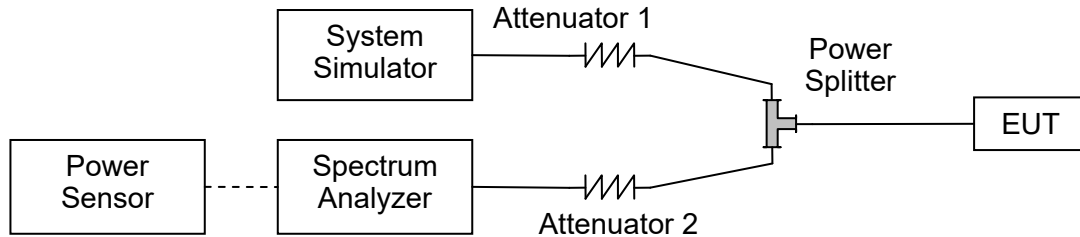

The EUT is coupled to the Spectrum Analyzer (SA) and the System Simulator (SS) with Attenuators through the Power Splitter; the RF load attached to the EUT antenna terminal is 50Ohm; the path loss as the factor is calibrated to correct the reading. The EUT is commanded by the SS to operate at the maximum output power. A call is established between the EUT and the SS.

2.4.3. Test procedure

KDB 971168 D01v03 Section 5.7 and ANSI/TIA-603-E-2016.

2.4.4. Test Result

Note: This test case does not apply this kind of EUT for part 90.

2.5. Conducted Spurious Emissions

2.5.1. Requirement

According to FCC section 2.1051, the power of any emission outside of the authorized operating frequency ranges must be attenuated below the transmitting power (P) by a factor of at least $43+10*\log(P)$ dB. This calculated to be -13dBm.

2.5.2. Test Description

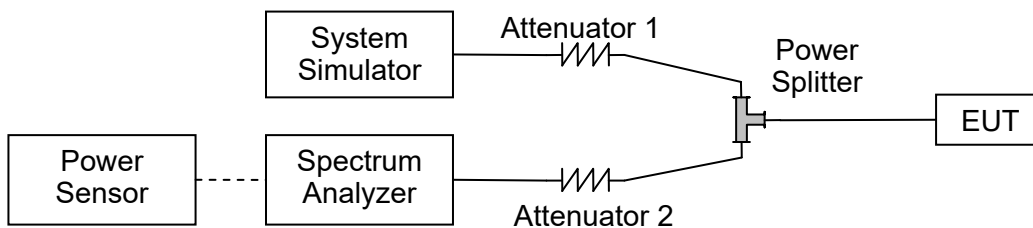

The EUT is coupled to the Spectrum Analyzer (SA) and the System Simulator (SS) with Attenuators through the Power Splitter; the RF load attached to the EUT antenna terminal is 50Ohm; the path loss as the factor is calibrated to correct the reading. The EUT is commanded by the SS to operate at the maximum output power. A call is established between the EUT and the SS.

2.5.3. Test procedure

KDB 971168 D01v03 Section 6.0 and ANSI/TIA-603-E-2016.



2.5.4. Test Result



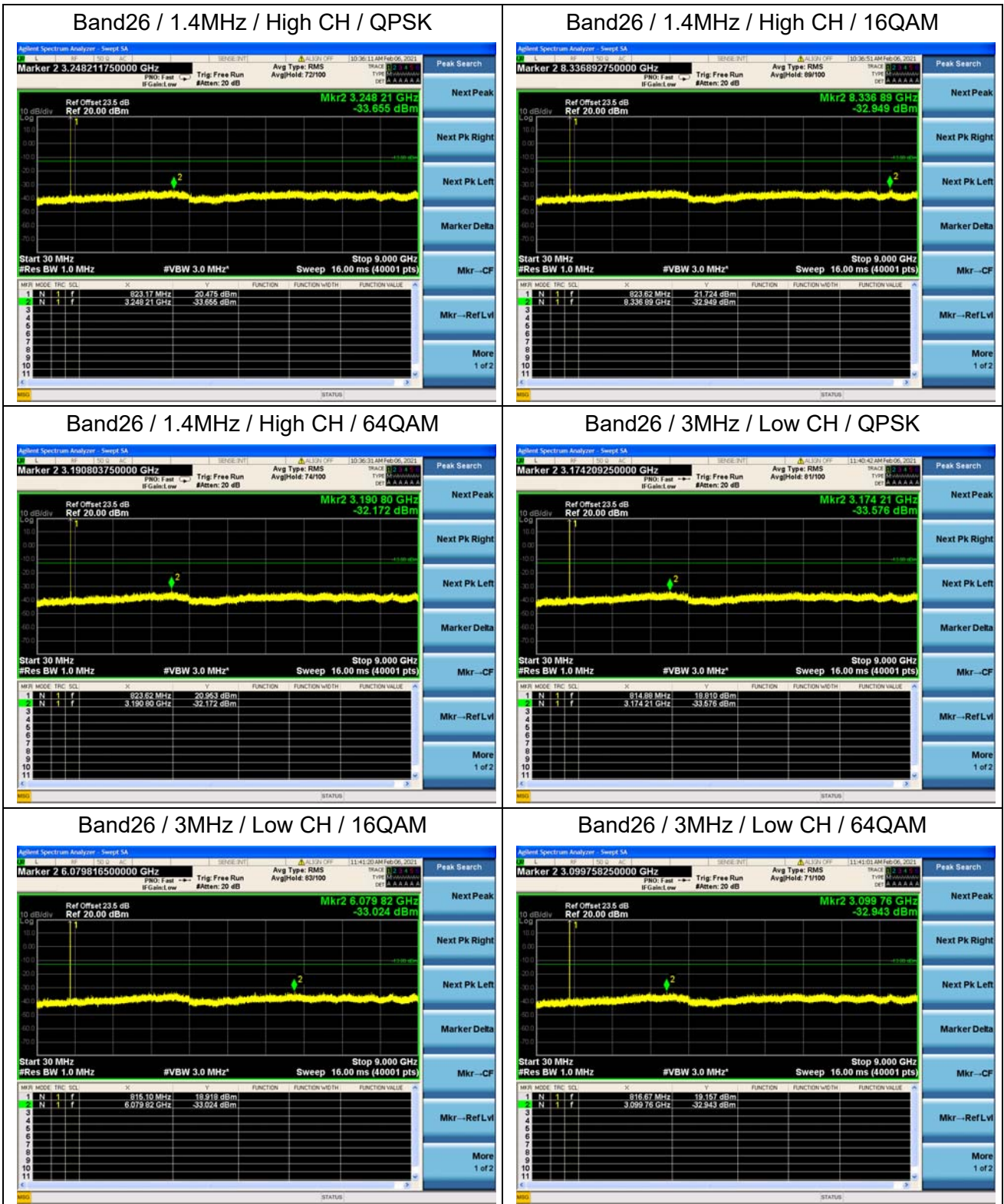

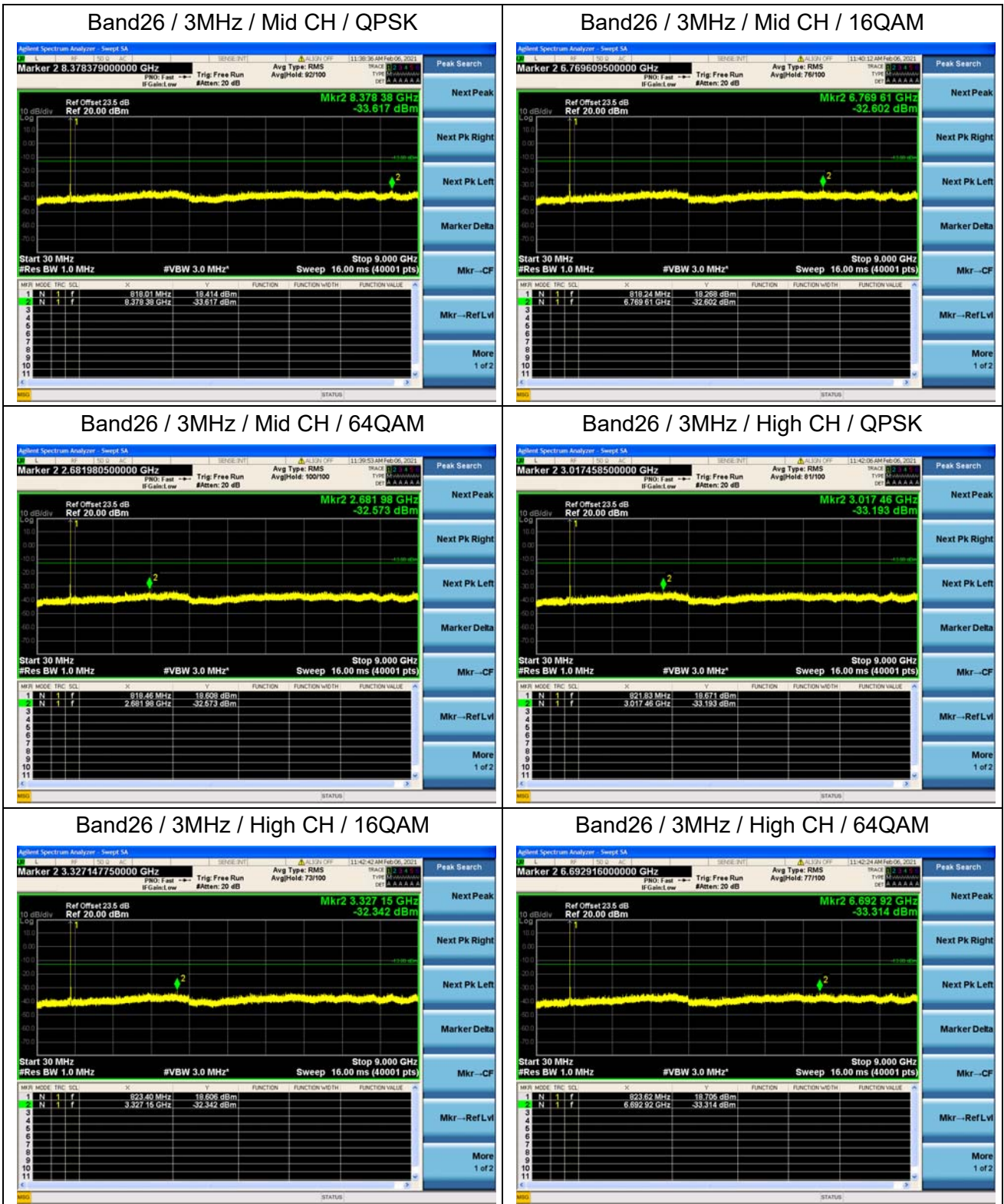

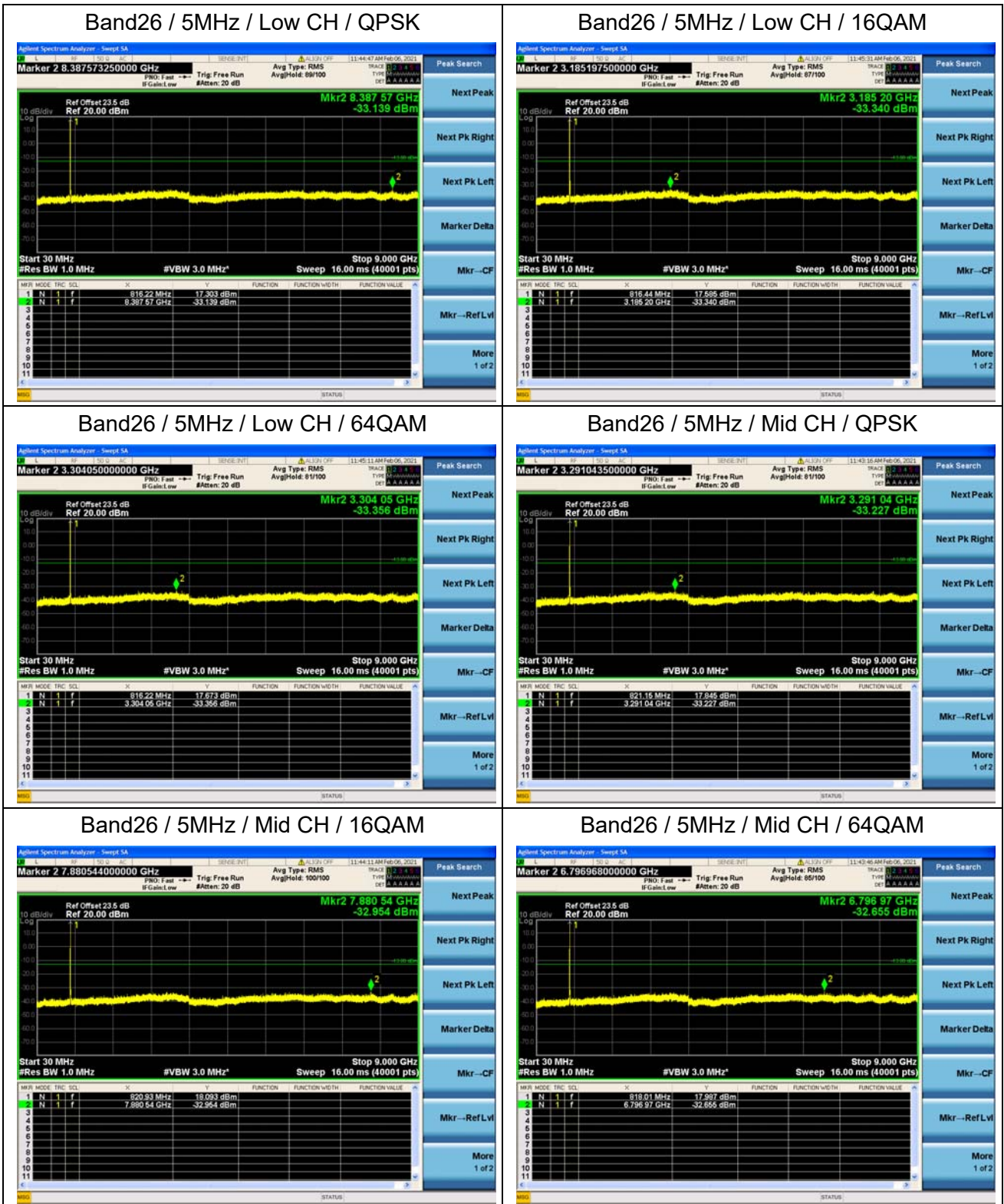

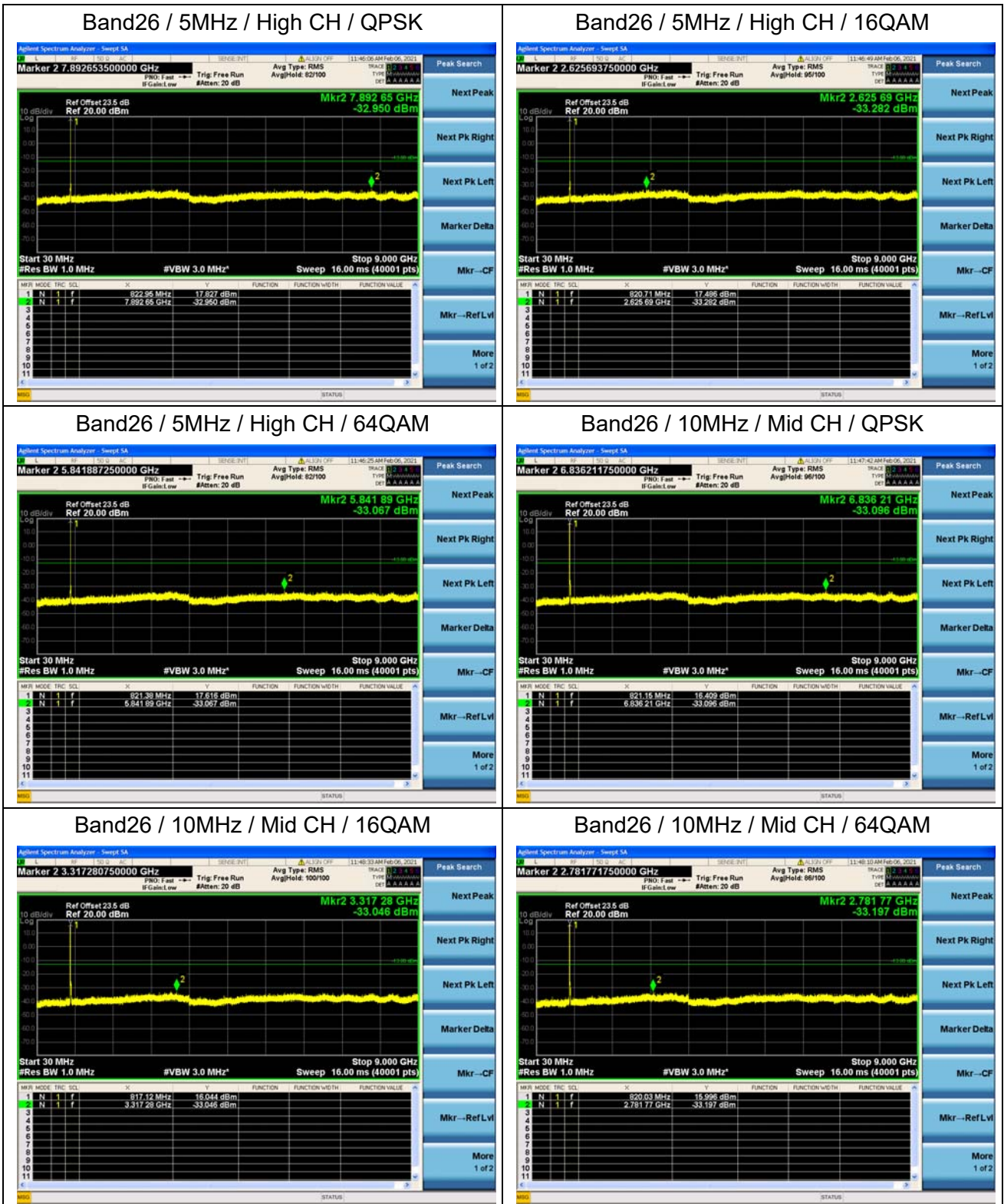

2.6. Band Edge

2.6.1. Requirement

According to FCC section 90.961, The power of any emission outside of the authorized operating frequency ranges must be attenuated below the transmitting power (P) by a factor of at least $43 + 10 \log(P)$ dB.

2.6.2. Test Description

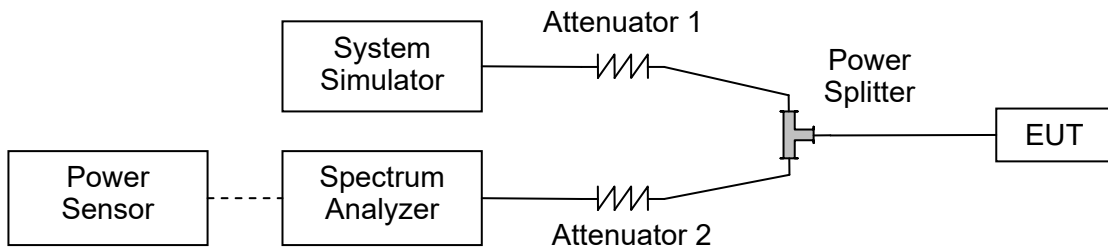

The EUT is coupled to the Spectrum Analyzer (SA) and the System Simulator (SS) with Attenuators through the Power Splitter; the RF load attached to the EUT antenna terminal is 50 Ohm; the path loss as the factor is calibrated to correct the reading. The EUT is commanded by the SS to operate at the maximum output power. A call is established between the EUT and the SS.

2.6.3. Test procedure

KDB 971168 D01v03 Section 6.0 and ANSI/TIA-603-E-2016.



2.6.4. Test Result

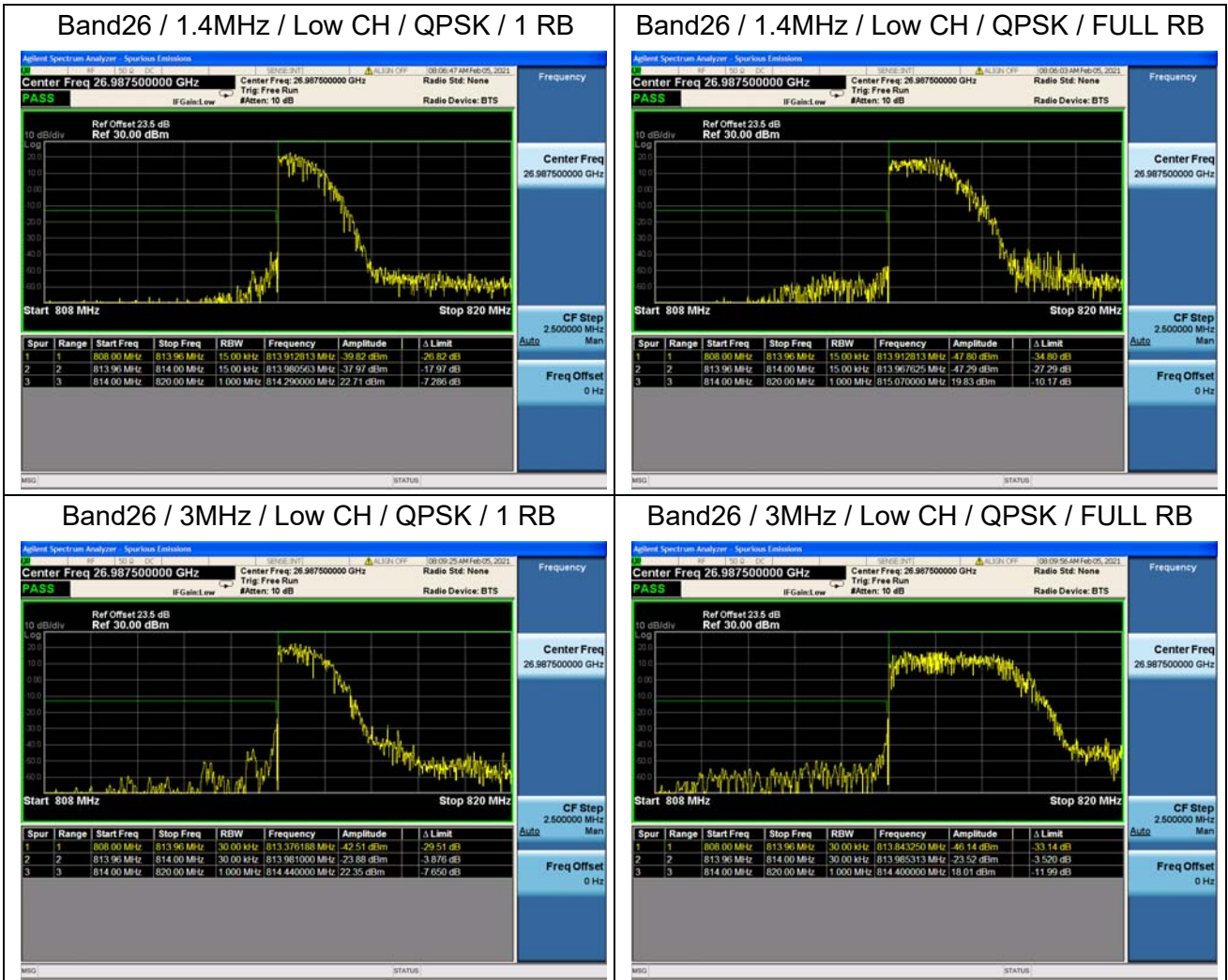

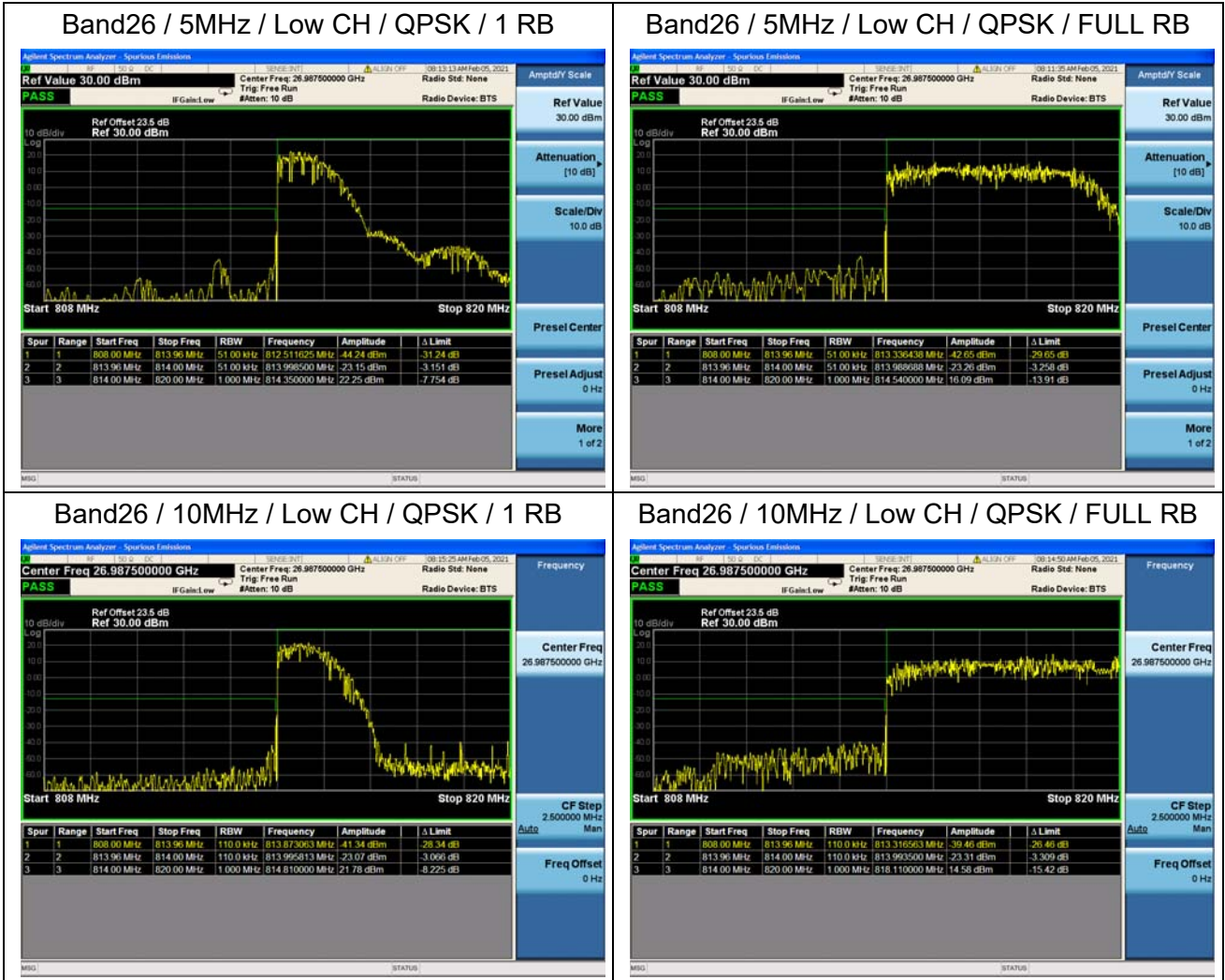

2.7. Radiated Spurious Emissions

2.7.1. Requirement

According to FCC section 2.1051, the power of any emission outside of the authorized operating frequency ranges must be attenuated below the transmitting power (P) by a factor of at least $43+10*\log(P)$ dB. This calculated to be -13dBm.

2.7.2. Test Description

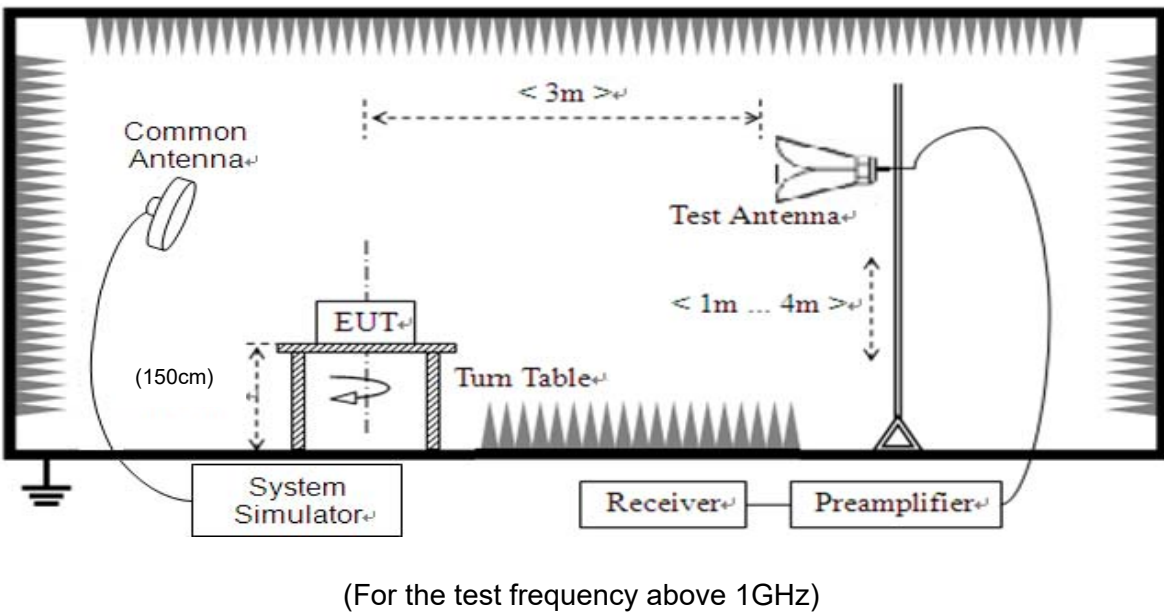
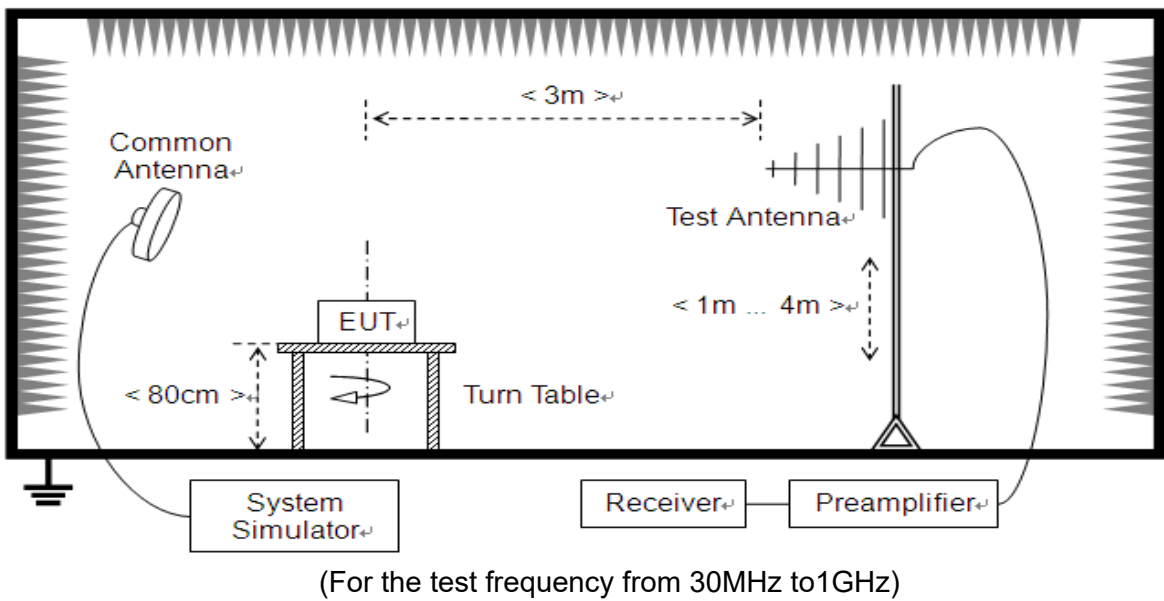



The EUT is located in a 3m Full-Anechoic Chamber, the cable loss, air loss and so on of the site as factors are pre-calibrated using the "Substitution" method, and calculated to correct the reading.

A call is established between the EUT and the SS via a Common Antenna. The EUT is commanded by the SS to operate at the maximum and minimum output power, and only the test result of the maximum output power was recorded.

In the frequency range above 30MHz, Bi-Log Test Antenna (30MHz to 1GHz) and Horn Test Antenna (above 1GHz) are used. Test Antenna is 3m away from the EUT. Test Antenna height is varied from 1m to 4m above the ground and the Turn Table is actuated to turn from 0° to 360° to determine the maximum value of the radiated power. The emission levels at both horizontal and vertical polarizations should be tested. The Filters consists of Notch Filters and High Pass Filter.

Note: when doing measurements above 1GHz, the EUT has been within the 3dB cone width of the horn antenna during horizontal antenna.

2.7.3. Test procedure

KDB 971168 D01v03 Section 5.8 and ANSI/TIA-603-E-2016.

For measurements below 1 GHz the resolution bandwidth is set to 100 kHz for peak detection measurements.

For measurements above 1GHz the resolution bandwidth is set to 1MHz, the video band width is set to 3MHz for peak measurements.



2.7.4. Test Result

The measurement frequency range is from 30MHz to the 10th harmonic of the fundamental frequency. The Turn Table is actuated to turn from 0° to 360°, and both horizontal and vertical polarizations of the Test Antenna are used to find the maximum radiated power. The lowest, middle and highest channels are tested to verify the out of band emissions.

The substitution corrections are obtained as described below:

$$A_{\text{SUBST}} = P_{\text{SUBST_TX}} - P_{\text{SUBST_RX}} - L_{\text{SUBST_CABLES}} + G_{\text{SUBST_TX_ANT}}$$

$$A_{\text{TOT}} = L_{\text{CABLES}} + A_{\text{SUBST}}$$

Where A_{SUBST} is the final substitution correction including receive antenna gain.

$P_{\text{SUBST_TX}}$ is signal generator level,

$P_{\text{SUBST_RX}}$ is receiver level,

$L_{\text{SUBST_CABLES}}$ is cable losses including TX cable,

$G_{\text{SUBST_TX_ANT}}$ is substitution antenna gain.

A_{TOT} is total correction factor including cable loss and substitution correction

During the test, the data of A_{TOT} was added in the test spectrum analyze, so spectrum analyze reading is the final values which contain the data of A_{TOT} .

Note1: The power of the EUT transmitting frequency should be ignored.

Note2: All Spurious Emission tests were performed in X, Y, Z axis direction. And only the worst axis test condition was recorded in this test report.

Note3: All bandwidth and modulation were considered and evaluated respectively by performing full test for each band, only the worst cases (Max Bandwidth and QPSK mode) were recorded in this test report.

Note 4: N/A means the frequency is the basic frequency or the base station frequency, they are no need to verdict.

LTE Band 26, 5MHz BW, Low Channel, QPSK

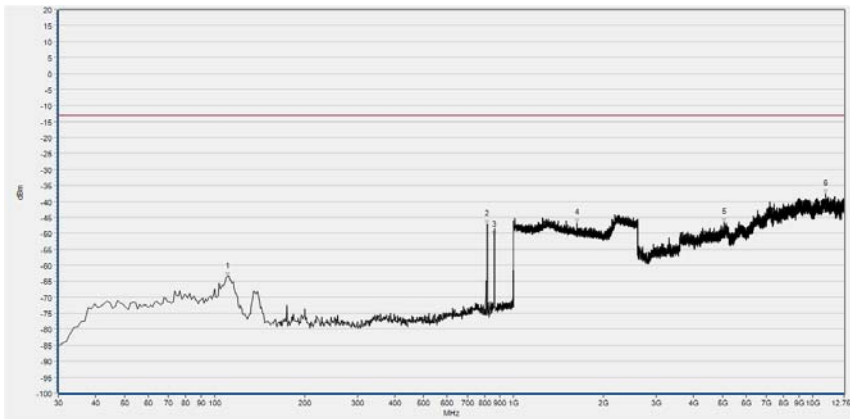

No.	Fre.(MHz)	PK (dBm)	Limit (dBm)	Antenna	Verdict
1	110.510	-63.50	-13.00	Horizontal	PASS
2	815.700	-47.20	-13.00	Horizontal	N/A
3	861.290	-50.58	-13.00	Horizontal	N/A
4	1632.573	-46.74	-13.00	Horizontal	PASS
5	5049.364	-46.64	-13.00	Horizontal	PASS
6	11079.560	-37.59	-13.00	Horizontal	PASS

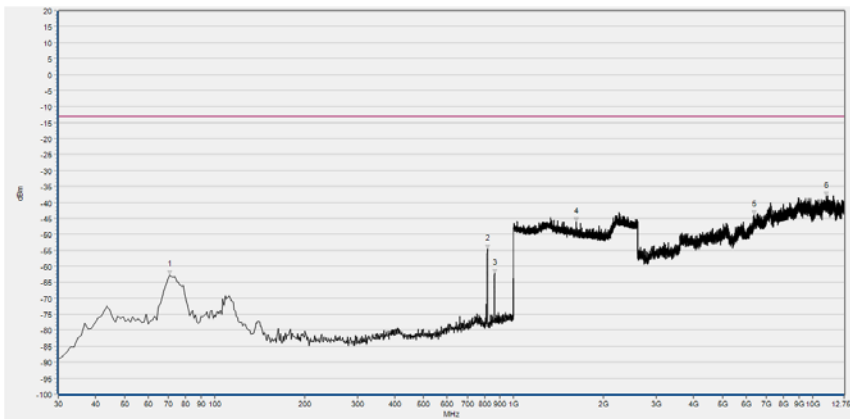

No.	Fre.(MHz)	PK (dBm)	Limit (dBm)	Antenna	Verdict
1	70.740	-62.74	-13.00	Vertical	PASS
2	816.670	-54.71	-13.00	Vertical	N/A
3	863.230	-62.29	-13.00	Vertical	N/A
4	1616.567	-46.06	-13.00	Vertical	PASS
5	6376.487	-43.88	-13.00	Vertical	PASS
6	11138.625	-38.01	-13.00	Vertical	PASS

LTE Band 26, 5MHz BW, Mid Channel, QPSK

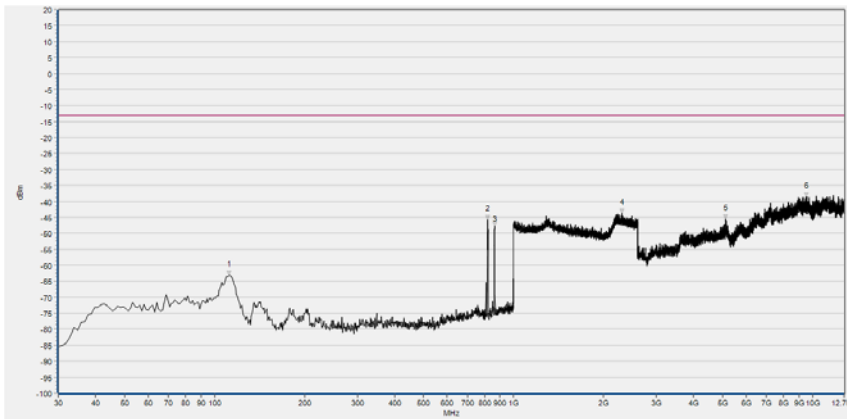

No.	Fre.(MHz)	PK (dBm)	Limit (dBm)	Antenna	Verdict
1	111.480	-63.06	-13.00	Horizontal	PASS
2	816.670	-45.78	-13.00	Horizontal	N/A
3	864.200	-47.81	-13.00	Horizontal	N/A
4	2300.360	-43.76	-13.00	Horizontal	PASS
5	5128.732	-45.53	-13.00	Horizontal	PASS
6	9543.863	-38.48	-13.00	Horizontal	PASS

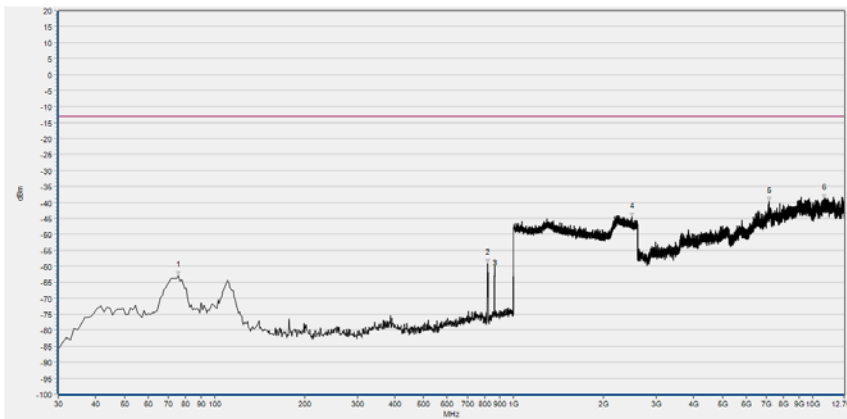

No.	Fre.(MHz)	PK (dBm)	Limit (dBm)	Antenna	Verdict
1	75.590	-63.01	-13.00	Vertical	PASS
2	816.670	-59.06	-13.00	Vertical	N/A
3	864.200	-59.46	-13.00	Vertical	N/A
4	2492.437	-44.60	-13.00	Vertical	PASS
5	7149.873	-39.59	-13.00	Vertical	PASS
6	10955.892	-38.71	-13.00	Vertical	PASS

LTE Band 26, 5MHz BW, High Channel, QPSK

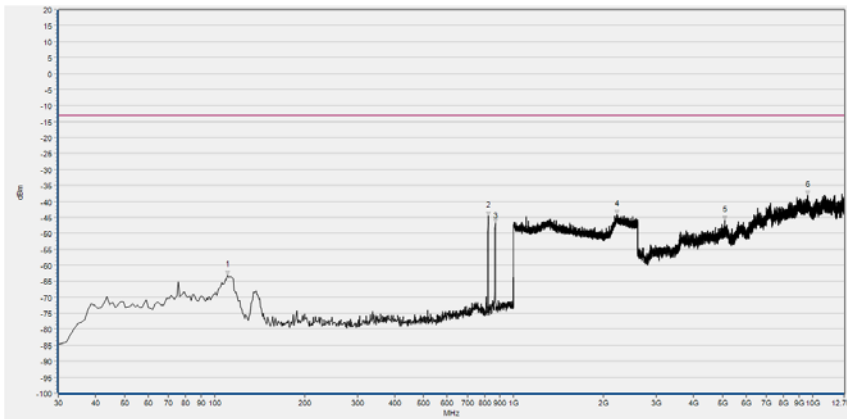

No.	Fre.(MHz)	PK (dBm)	Limit (dBm)	Antenna	Verdict
1	110.510	-63.18	-13.00	Horizontal	PASS
2	822.490	-44.57	-13.00	Horizontal	N/A
3	868.080	-46.81	-13.00	Horizontal	N/A
4	2213.926	-44.21	-13.00	Horizontal	PASS
5	5073.359	-45.93	-13.00	Horizontal	PASS
6	9628.769	-38.05	-13.00	Horizontal	PASS

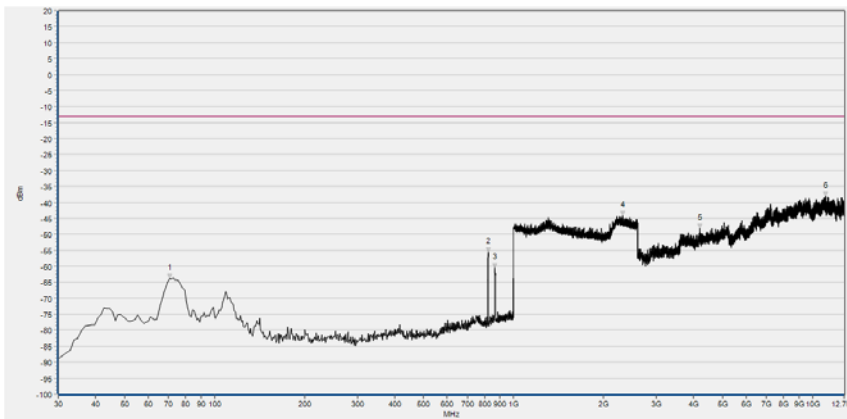

No.	Fre.(MHz)	PK (dBm)	Limit (dBm)	Antenna	Verdict
1	70.740	-63.91	-13.00	Vertical	PASS
2	823.460	-55.51	-13.00	Vertical	N/A
3	866.140	-60.46	-13.00	Vertical	N/A
4	2317.007	-44.22	-13.00	Vertical	PASS
5	4189.225	-48.06	-13.00	Vertical	PASS
6	11053.719	-38.14	-13.00	Vertical	PASS

Annex A Test Uncertainty

Where relevant, the following measurement uncertainty levels have been estimated for test performed on the EUT as specified in CISPR 16-1-2:

Test items	Uncertainty
Output Power	± 2.22 dB
Bandwidth	$\pm 5\%$
Conducted Spurious Emission	± 2.77 dB
Band Edge	± 2.77 dB
Equivalent Isotropic Radiated Power	± 2.22 dB
Radiated Spurious Emissions	± 6 dB

This uncertainty represent an expanded uncertainty expressed at approximately the 95% confidence level using a coverage factor of $k=2$.



Annex B Testing Laboratory Information

1. Identification of the Responsible Testing Laboratory

Laboratory Name:	Shenzhen Morlab Communications Technology Co., Ltd. Morlab Laboratory
Laboratory Address:	FL.3, Building A, FeiYang Science Park, No.8 LongChang Road, Block 67, BaoAn District, ShenZhen, GuangDong Province, P. R. China
Telephone:	+86 755 36698555
Facsimile:	+86 755 36698525

2. Identification of the Responsible Testing Location

Name:	Shenzhen Morlab Communications Technology Co., Ltd. Morlab Laboratory
Address:	FL.3, Building A, FeiYang Science Park, No.8 LongChang Road, Block 67, BaoAn District, ShenZhen, GuangDong Province, P. R. China

3. Facilities and Accreditations

All measurement facilities used to collect the measurement data are located at FL.3, Building A, FeiYang Science Park, Block 67, BaoAn District, Shenzhen, 518101 P. R. China. The test site is constructed in conformance with the requirements of ANSI C63.10-2013 and CISPR Publication 22; the FCC designation number is CN1192, the test firm registration number is 226174.



4. Test Equipments Utilized

4.1 Conducted Test Equipments

Equipment Name	Serial No.	Type	Manufacturer	Cal. Date	Cal. Due
Power Splitter	NW521	1506A	Weinschel	2020.04.15	2021.04.14
Attenuator 1	(N/A.)	10dB	Resnet	N/A	N/A
Attenuator 2	(N/A.)	3dB	Resnet	N/A	N/A
EXA Signal Analyzer	MY51511149	N9020A	Agilent	2020.07.27	2021.07.26
USB Power Sensor	MY54210011	U2021XA	Agilent	2020.04.01	2021.03.31
System Simulator	6200995016	MT8820C	Anritsu	2020.10.28	2021.10.27
System Simulator	6261830572	MT8821C	Anritsu	2020.02.25	2021.02.24
RF cable (30MHz-26GHz)	CB01	RF01	Morlab	N/A	N/A
Coaxial cable	CB02	RF02	Morlab	N/A	N/A
SMA connector	CN01	RF03	HUBER-SUHNER	N/A	N/A
Temperature Chamber	HA06-21216 2-3-3-II	HUT705P	CHONGQING HANBA EXPERIMENTAL EQUIPMENT CO.,LTD	2020.03.25	2021.03.24
Computer	T430i	Think Pad	Lenovo	N/A	N/A

**4.2 Radiated Test Equipments**

Equipment Name	Serial No.	Type	Manufacturer	Cal. Date	Cal. Due
System Simulator	152038	CMW500	R&S	2020.11.19	2021.11.18
System Simulator	6200995016	MT8820C	Anritsu	2020.10.28	2021.10.27
Receiver	MY54130016	N9038A	Agilent	2020.07.21	2021.07.20
Test Antenna - Bi-Log	9163-519	VULB 9163	Schwarzbeck	2019.05.24	2022.05.23
Test Antenna - Horn	9170C-531	BBHA9170	Schwarzbeck	2019.07.26	2022.07.25
Test Antenna - Horn	01774	BBHA 9120D	Schwarzbeck	2019.07.26	2022.07.25
Coaxial cable (N male) (9KHz-30MHz)	CB04	EMC04	Morlab	N/A	N/A
Coaxial cable (N male) (30MHz-26GHz)	CB02	EMC02	Morlab	N/A	N/A
Coaxial cable (N male) (30MHz-26GHz)	CB03	EMC03	Morlab	N/A	N/A
Coaxial cable (N male) (30MHz-40GHz)	CB05	EMC05	Morlab	N/A	N/A
1-18GHz pre-Amplifier	61171/61172	S020180L3203	Tonscend	2020.07.21	2021.07.20
18-26.5GHz pre-Amplifier	46732	S10M100L3802	Tonscend	2020.07.21	2021.07.20
26-40GHz pre-Amplifier	56774	S40M400L4002	Tonscend	2020.07.21	2021.07.20
Notch Filter	N/A	WRCGV-LTE 26	Wainwright	2020.07.21	2021.07.20
Anechoic Chamber	N/A	9m*6m*6m	CRT	2019.07.13	2022.07.12

END OF REPORT