

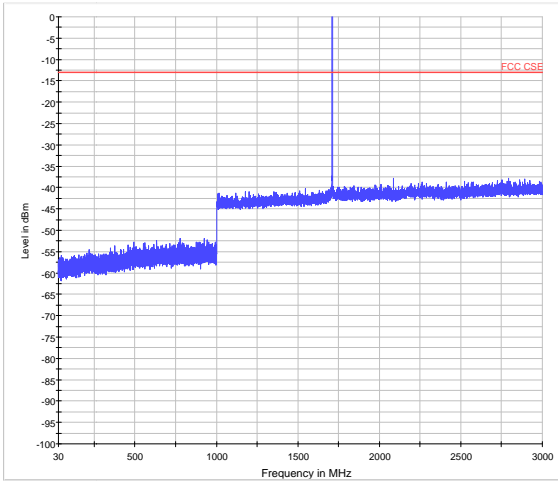

LTE Band 4 1.4MHz CH-Low 30MHz~3GHz

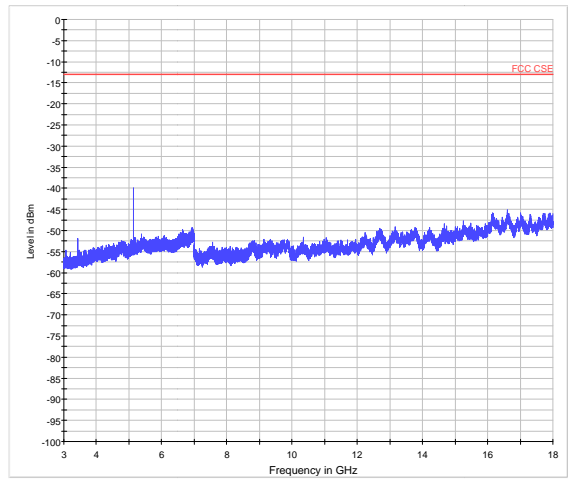

LTE Band 4 1.4MHz CH-Low 3GHz~18GHz



LTE Band 4 1.4MHz CH-Middle 30MHz~3GHz

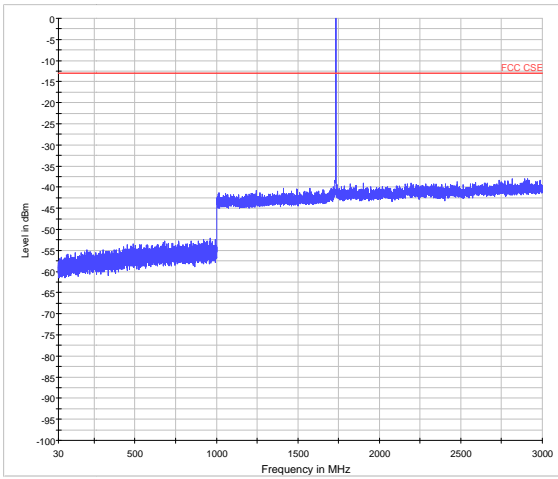

LTE Band 4 1.4MHz CH-Middle 3GHz~18GHz

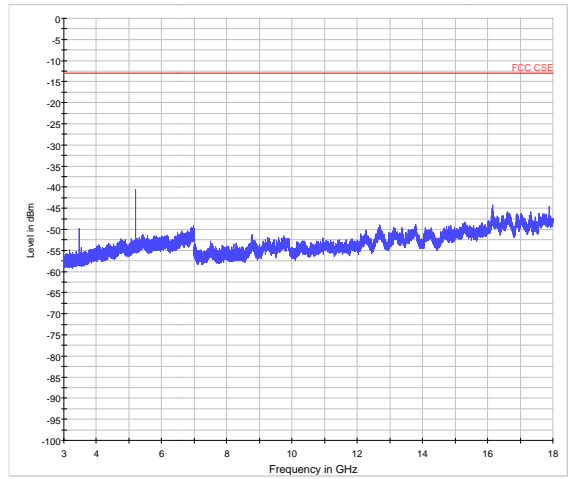

LTE Band 4 1.4MHz CH-High 30MHz~3GHz

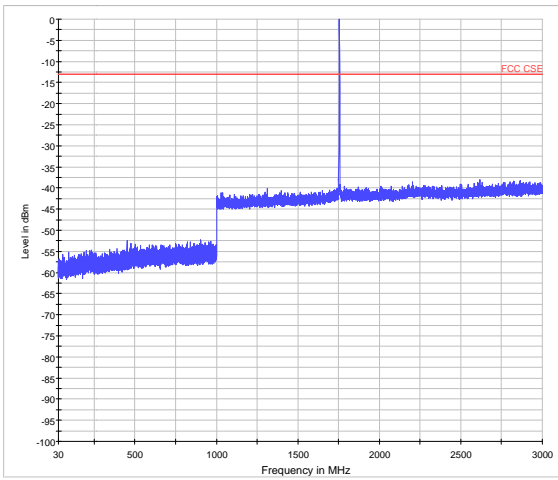

LTE Band 4 1.4MHz CH-High 3GHz~18GHz

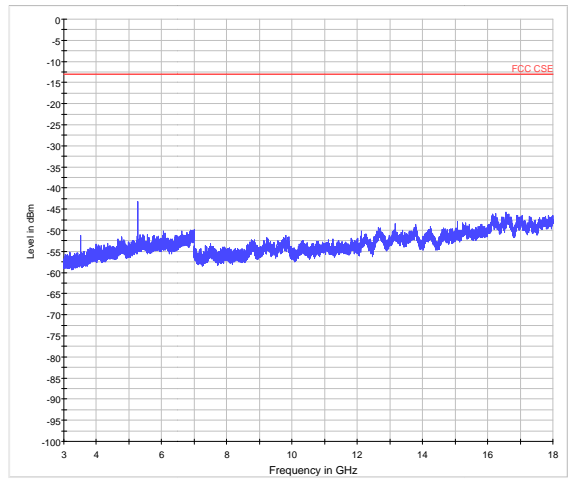



LTE Band 4 3MHz CH-Low 30MHz~3GHz

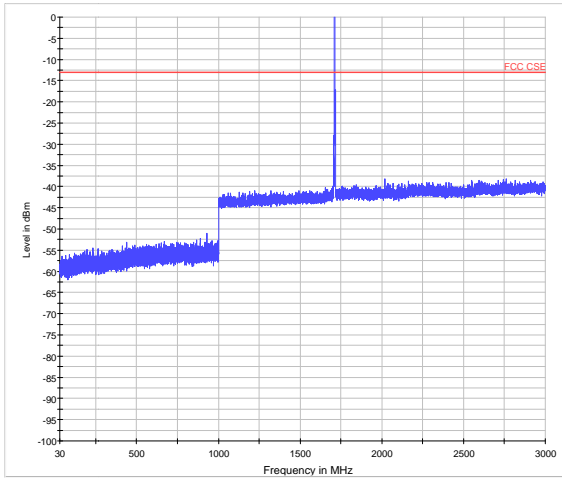

LTE Band 4 3MHz CH-Low 3GHz~18GHz

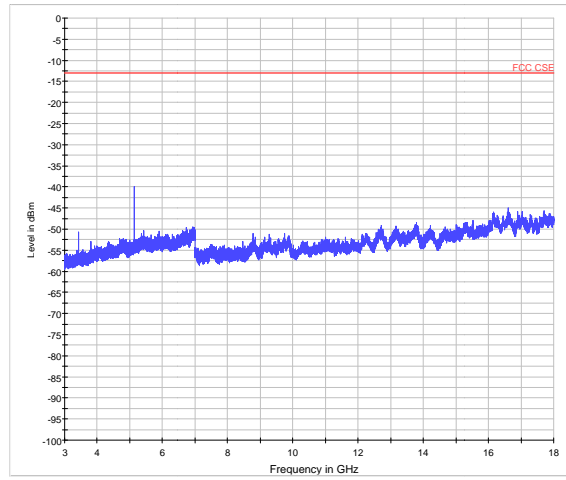

LTE Band 4 3MHz CH-Middle 30MHz~3GHz

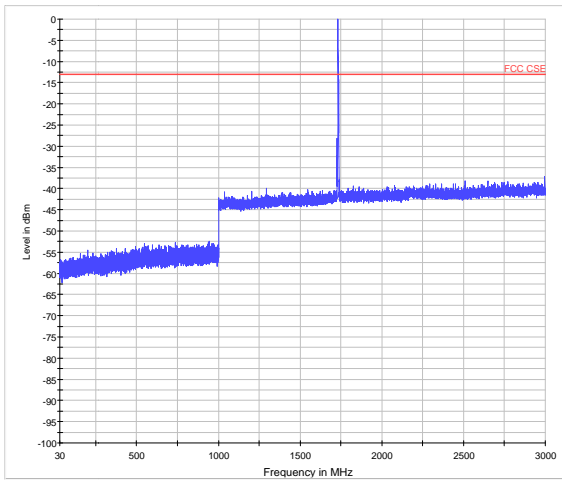

LTE Band 4 3MHz CH-Middle 3GHz~18GHz

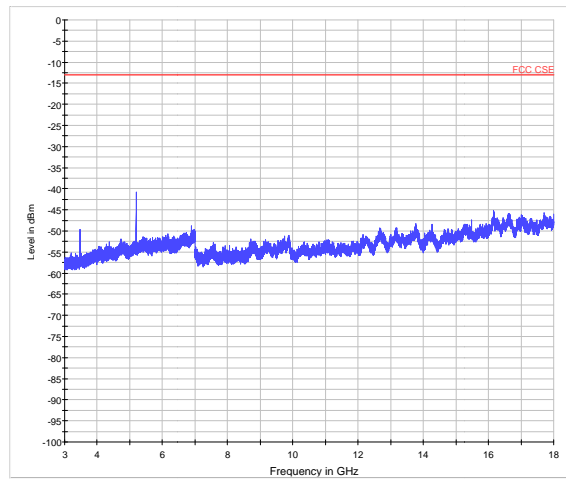

LTE Band 4 3MHz CH-High 30MHz~3GHz

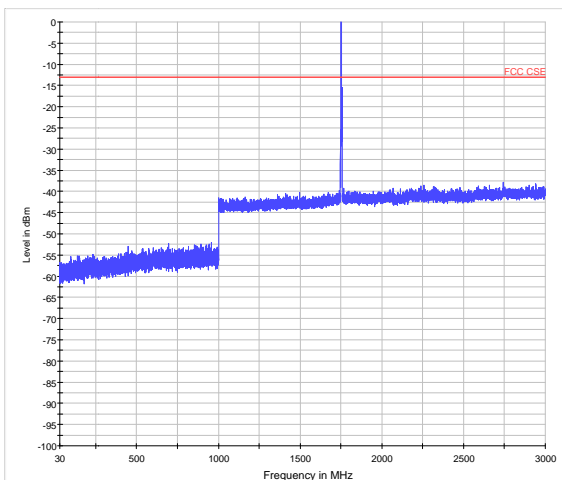

LTE Band 4 3MHz CH-High 3GHz~18GHz

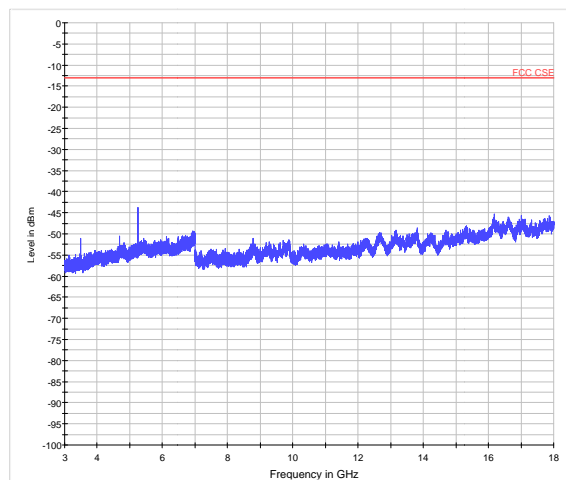



LTE Band 4 5MHz CH-Low 30MHz~3GHz

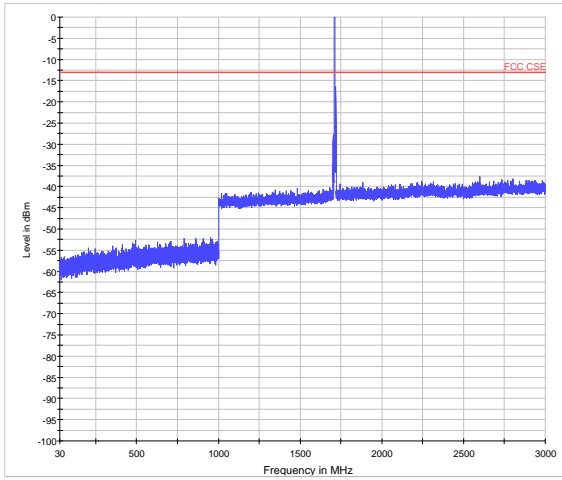

LTE Band 4 5MHz CH-Low 3GHz~18GHz

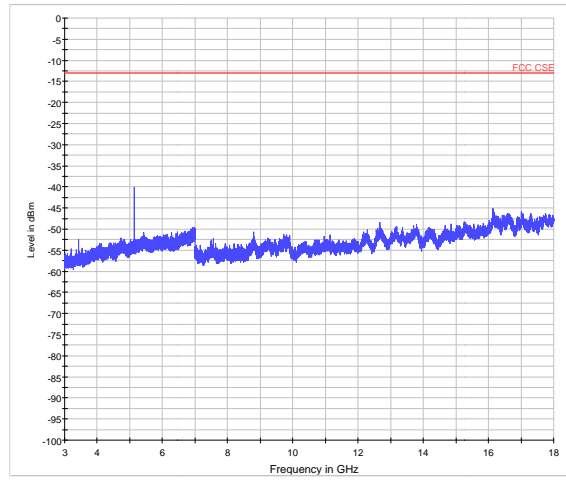

LTE Band 4 5MHz CH-Middle 30MHz~3GHz

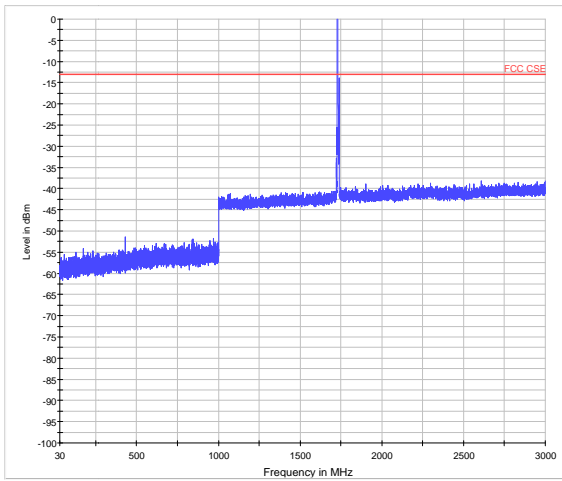

LTE Band 4 5MHz CH-Middle 3GHz~18GHz

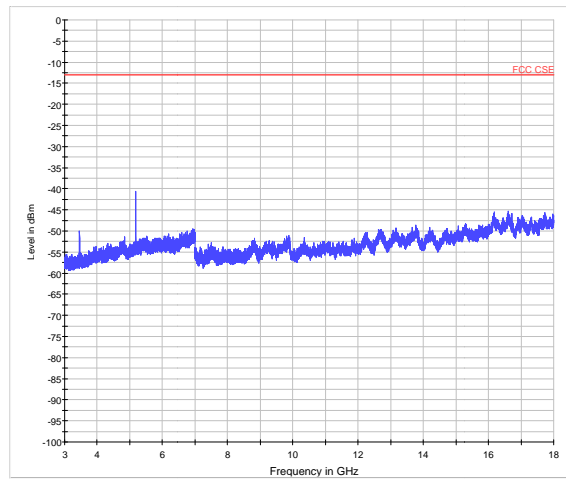

LTE Band 4 5MHz CH-High 30MHz~3GHz

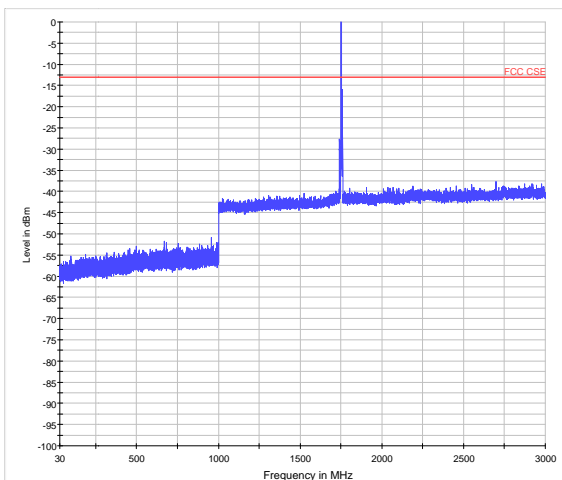

LTE Band 4 5MHz CH-High 3GHz~18GHz

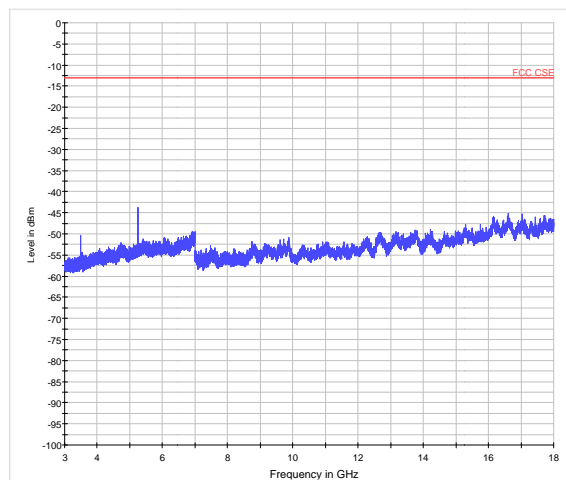



LTE Band 4 10MHz CH-Low 30MHz~3GHz

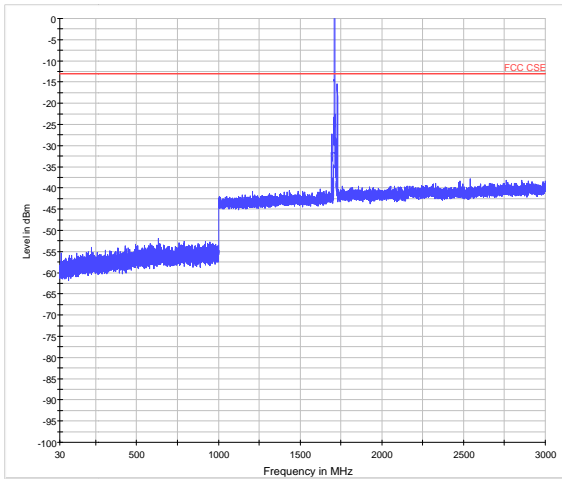

LTE Band 4 10MHz CH-Low 3GHz~18GHz

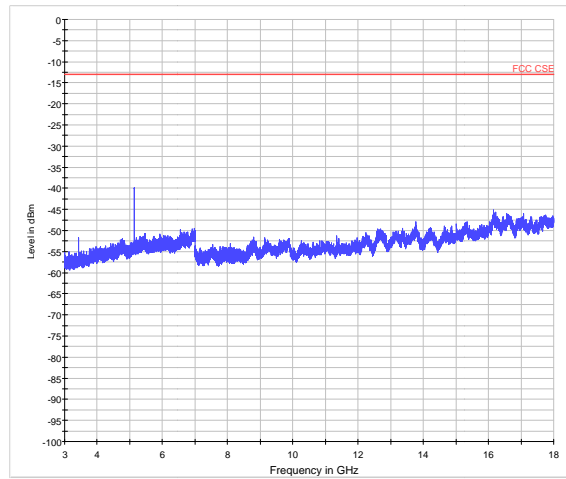

LTE Band 4 10MHz CH-Middle 30MHz~3GHz

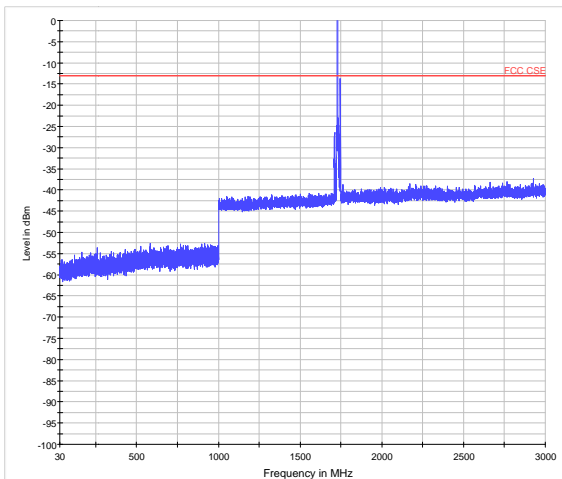

LTE Band 4 10MHz CH-Middle 3GHz~18GHz

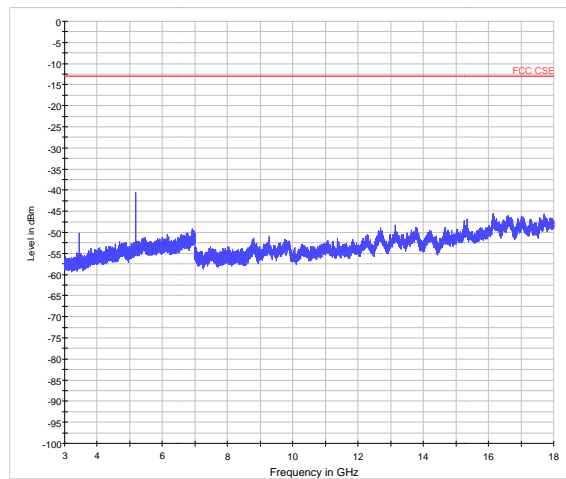

LTE Band 4 10MHz CH-High 30MHz~3GHz

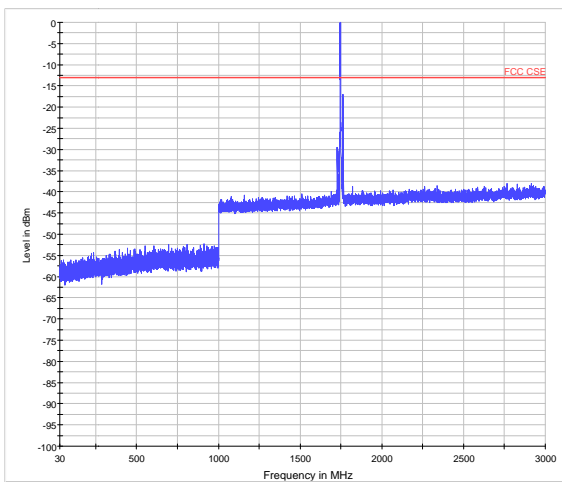

LTE Band 4 10MHz CH-High 3GHz~18GHz

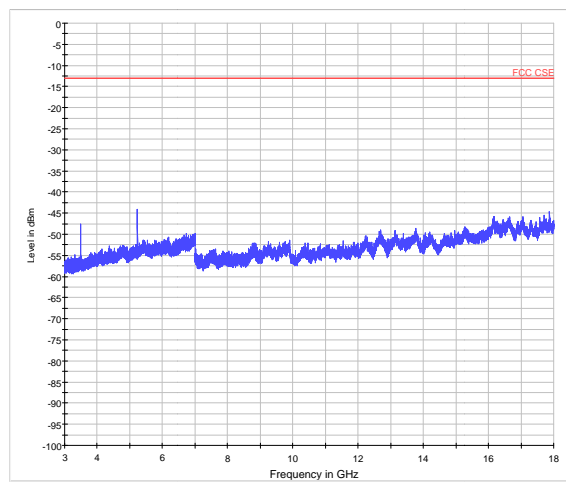



LTE Band 4 15MHz CH-Low 30MHz~3GHz

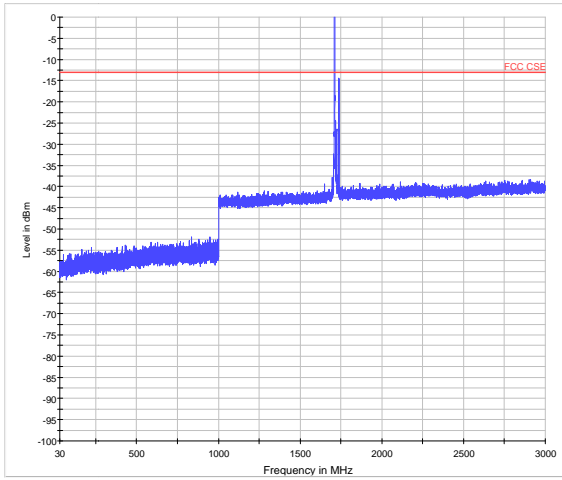

LTE Band 4 15MHz CH-Low 3GHz~18GHz

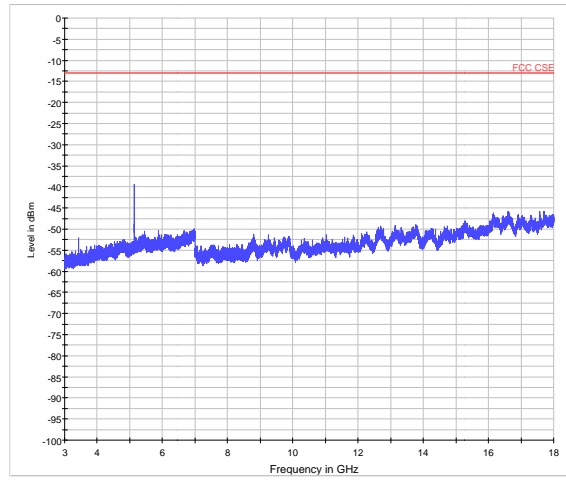

LTE Band 4 15MHz CH-Middle 30MHz~3GHz

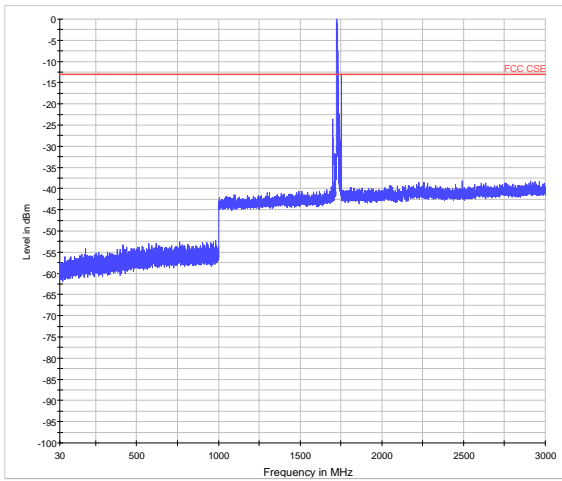

LTE Band 4 15MHz CH-Middle 3GHz~18GHz

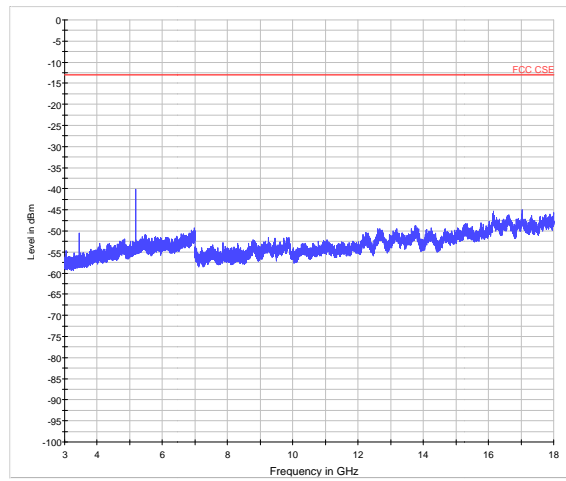

LTE Band 4 15MHz CH-High 30MHz~3GHz

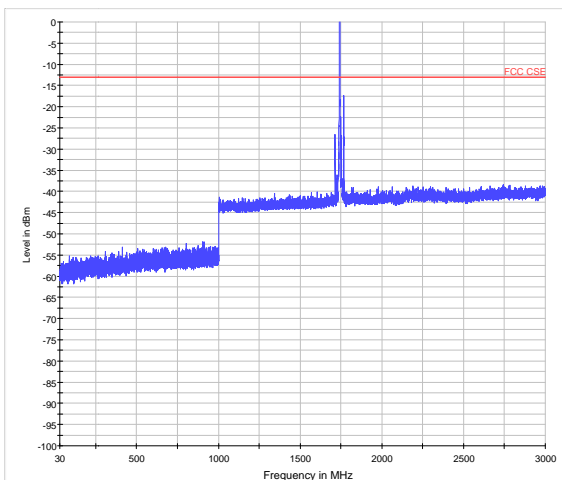

LTE Band 4 15MHz CH-High 3GHz~18GHz

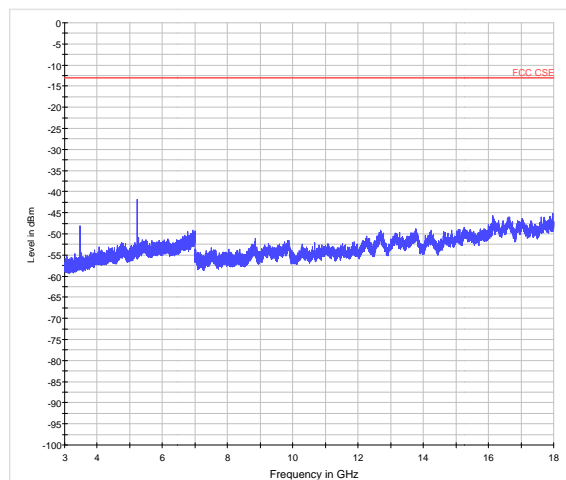



LTE Band 4 20MHz CH-Low 30MHz~3GHz

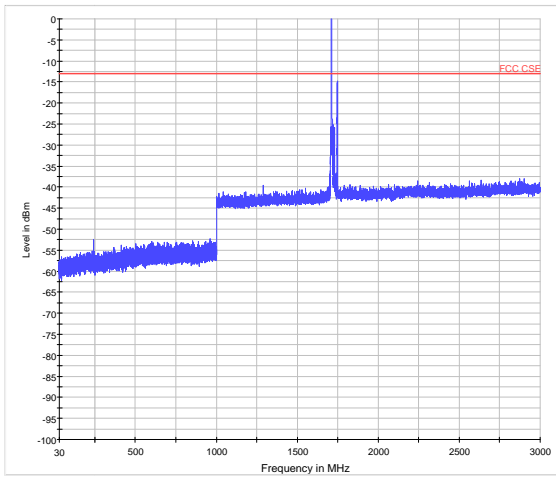

LTE Band 4 20MHz CH-Low 3GHz~18GHz

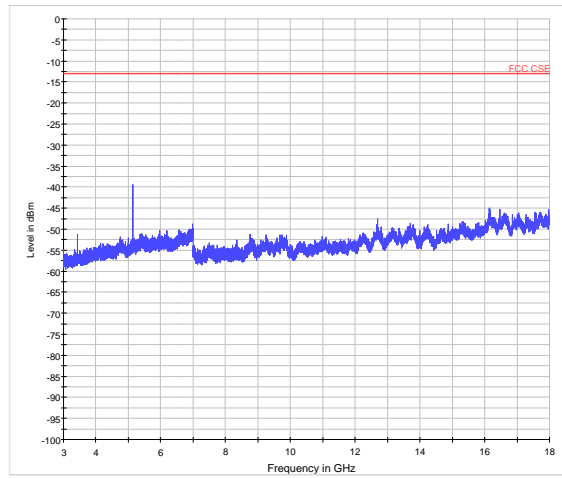

LTE Band 4 20MHz CH-Middle 30MHz~3GHz

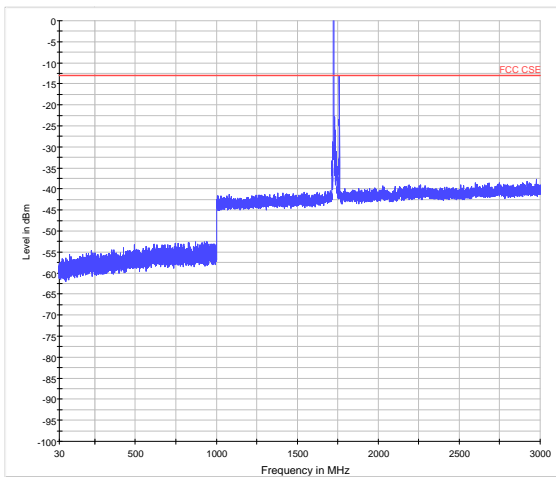

LTE Band 4 20MHz CH-Middle 3GHz~18GHz

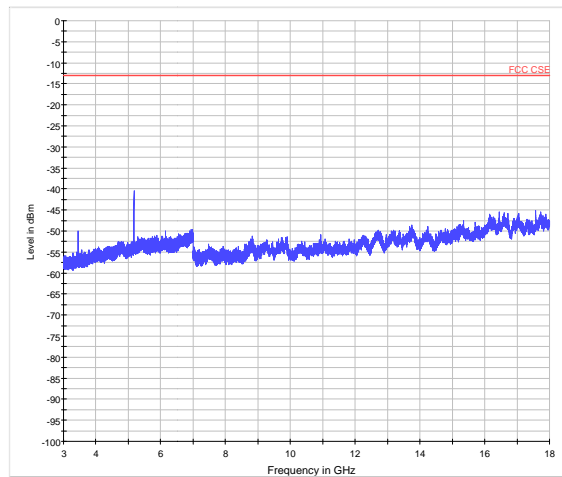

LTE Band 4 20MHz CH-High 30MHz~3GHz

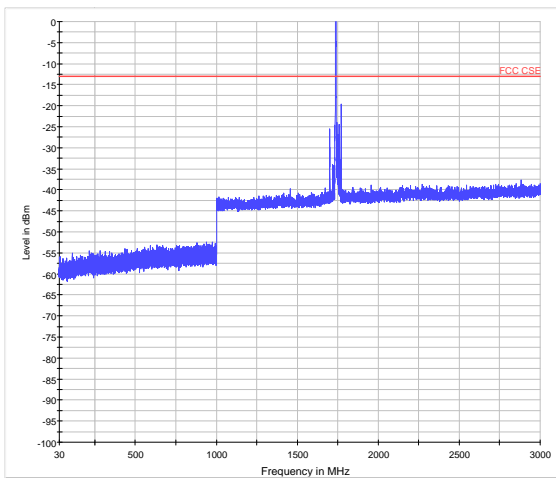

LTE Band 4 20MHz CH-High 3GHz~18GHz

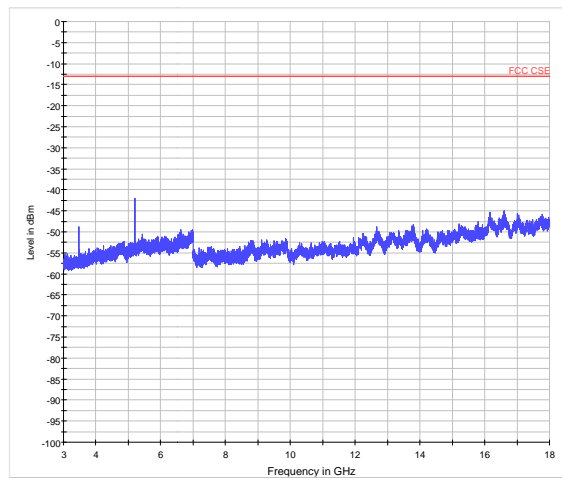



LTE Band 7 5MHz CH-Low 30MHz~3GHz

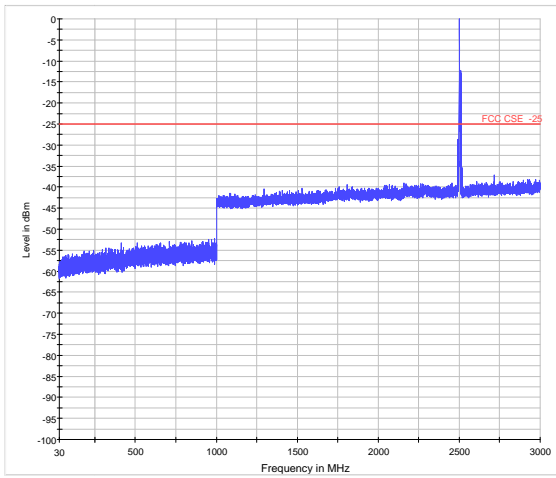

LTE Band 7 5MHz CH-Middle 30MHz~3GHz

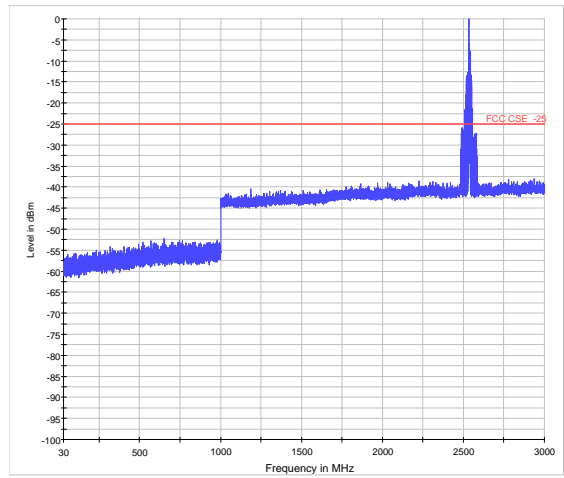

LTE Band 7 5MHz CH-Low 3GHz~18GHz

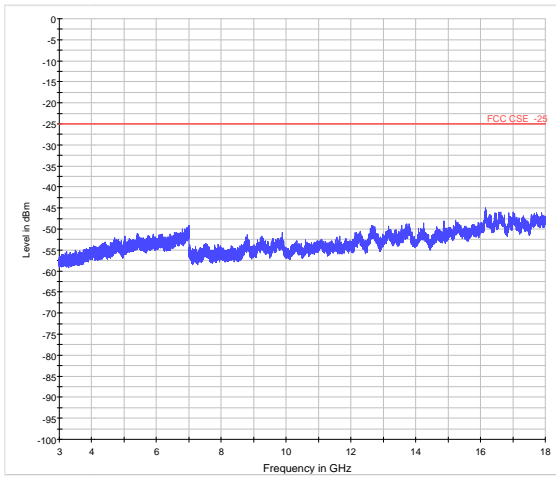

LTE Band 7 5MHz CH-Middle 3GHz~18GHz

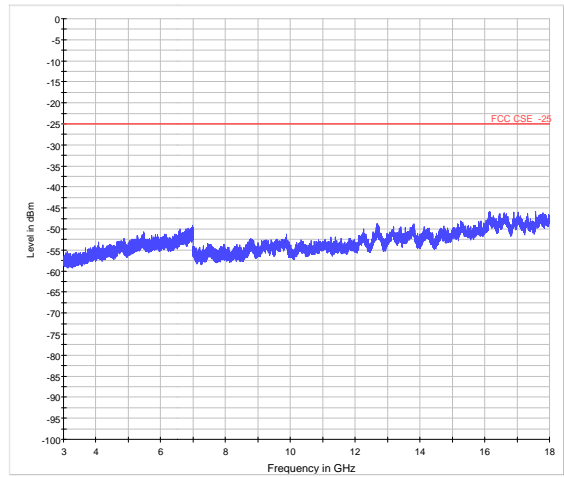

LTE Band 7 5MHz CH-Low 18GHz~26.5GHz

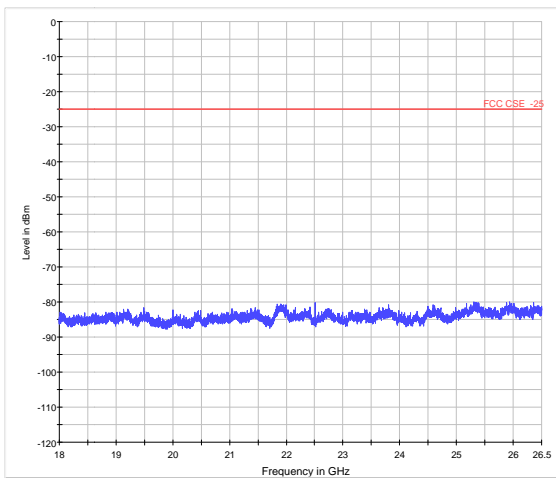

LTE Band 7 5MHz CH-Middle 18GHz~26.5GHz

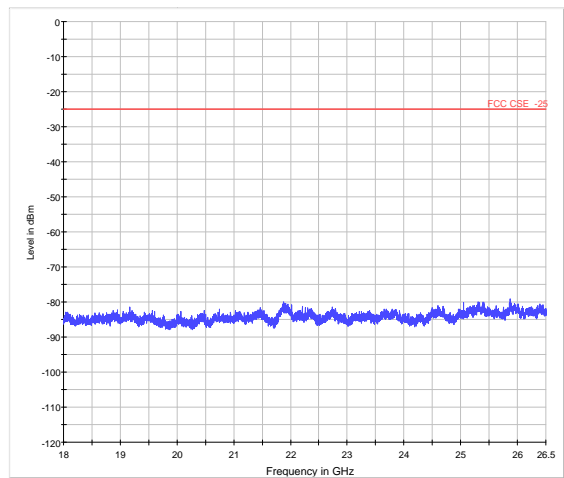



LTE Band 7 5MHz CH-High 30MHz~3GHz

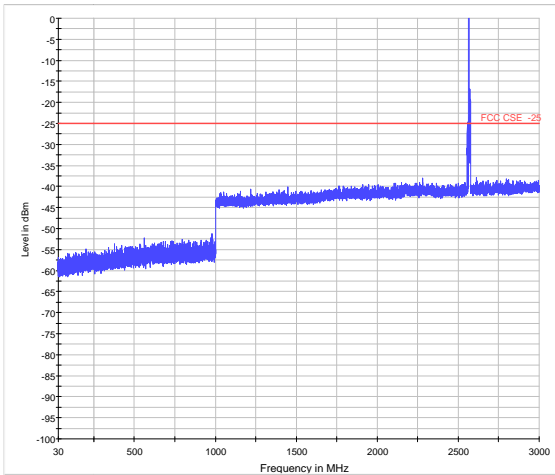

LTE Band 7 10MHz CH-Low 30MHz~3GHz

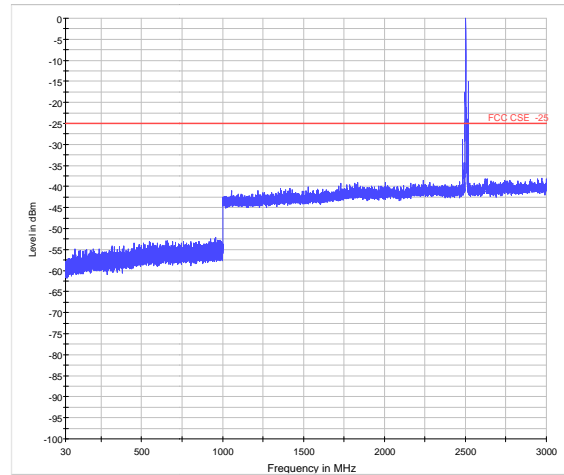

LTE Band 7 5MHz CH-High 3GHz~18GHz

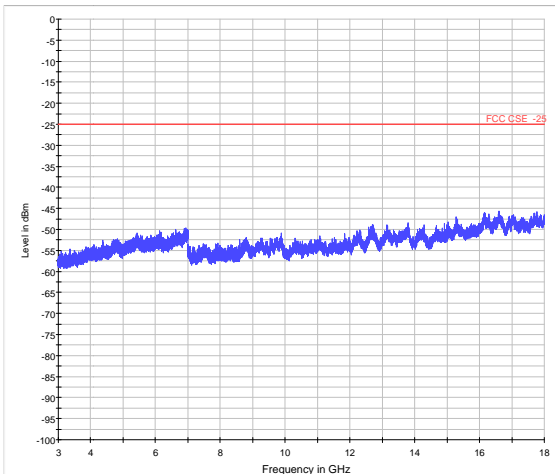

LTE Band 7 10MHz CH-Low 3GHz~18GHz

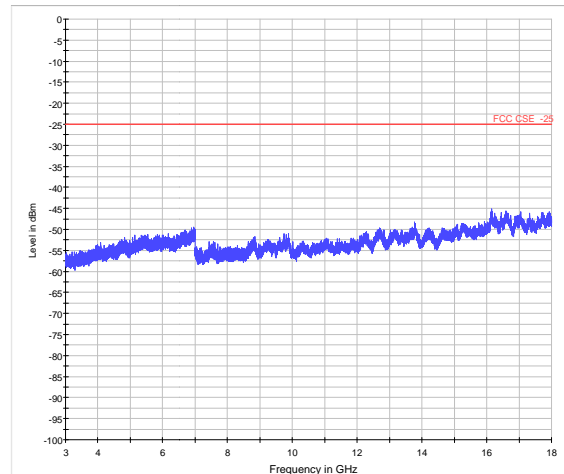

LTE Band 7 5MHz CH-High 18GHz~26.5GHz

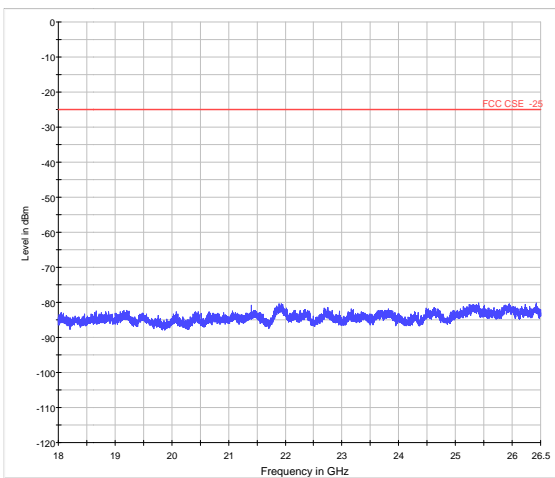

LTE Band 7 10MHz C CH-Low 18GHz~26.5GHz

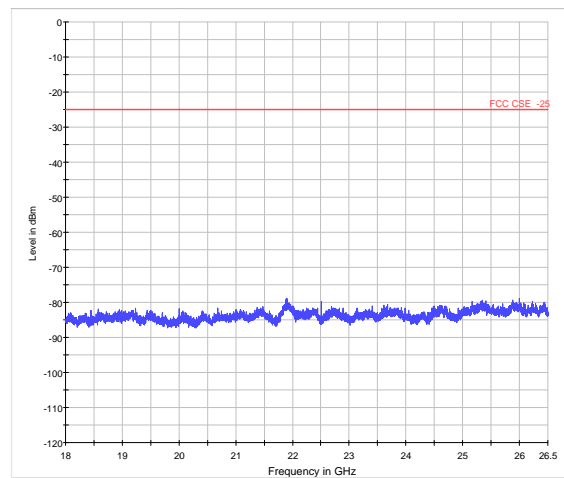





LTE Band 7 10MHz CH-Middle 30MHz~3GHz

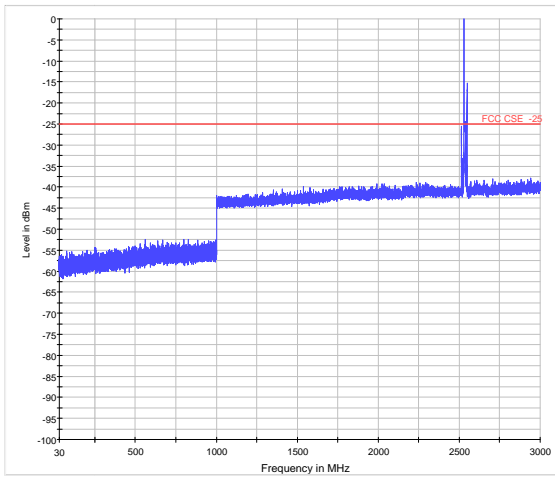

LTE Band 7 10MHz CH-High 30MHz~3GHz

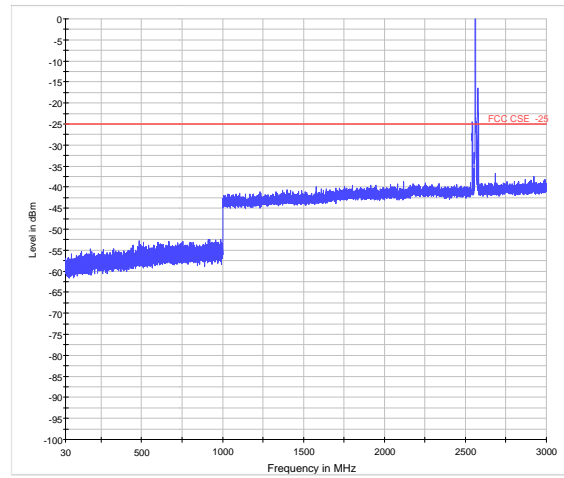

LTE Band 7 10MHz CH-Middle 3GHz~18GHz

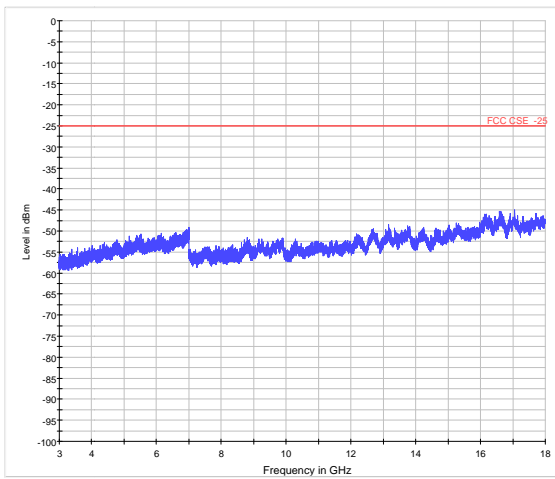

LTE Band 7 10MHz CH-High 3GHz~18GHz

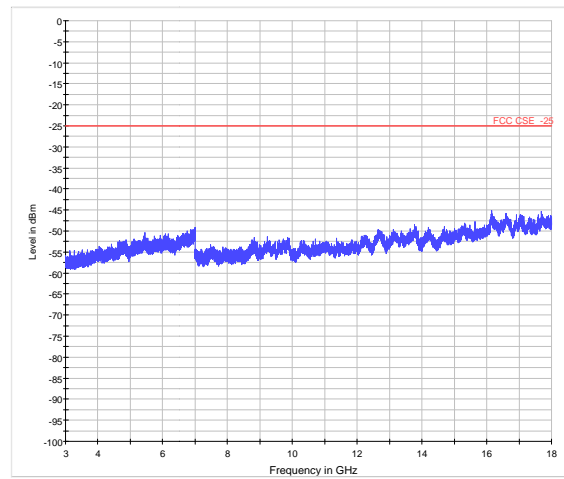

LTE Band 7 10MHz CH-Middle 18GHz~26.5GHz

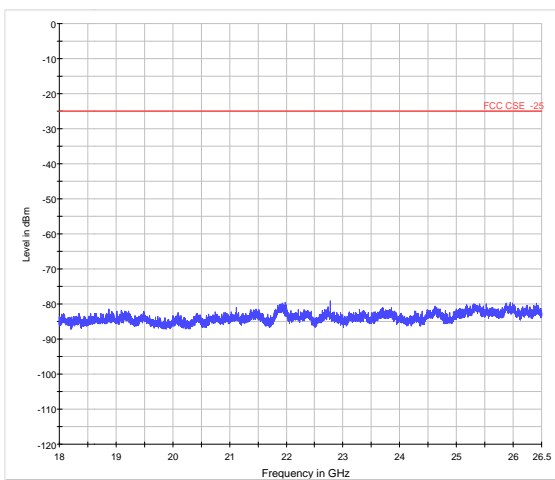

LTE Band 7 10MHz CH-High 18GHz~26.5GHz

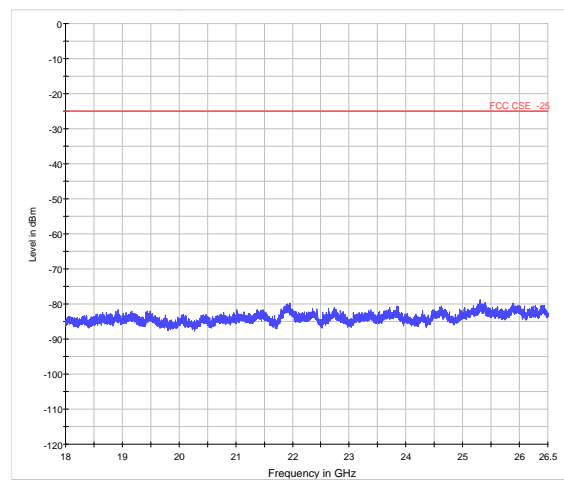



LTE Band 7 15MHz CH-Low 30MHz~3GHz

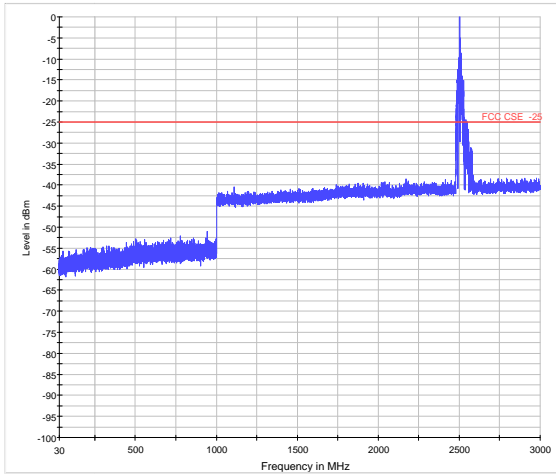

LTE Band 7 15MHz CH-Middle 30MHz~3GHz

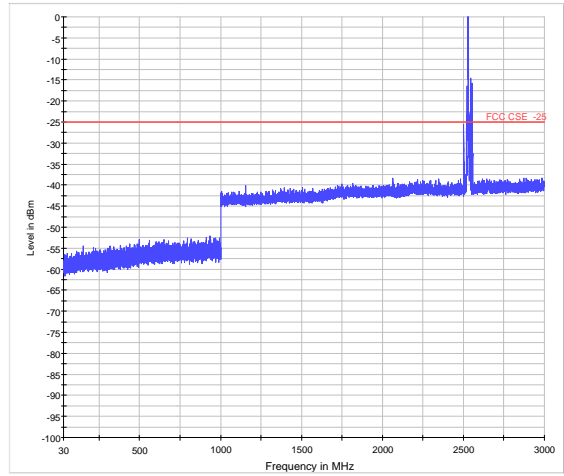

LTE Band 7 15MHz CH-Low 3GHz~18GHz

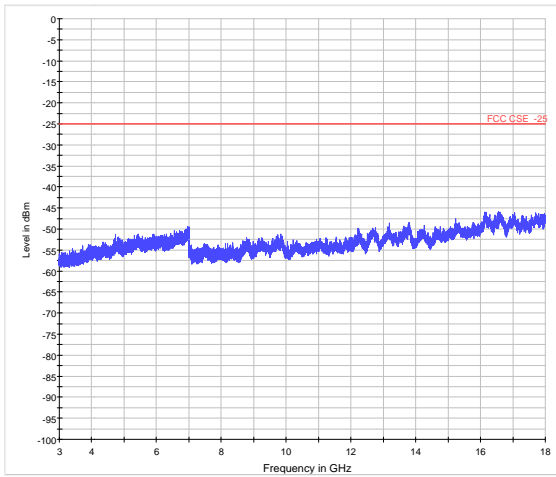

LTE Band 7 15MHz CH-Middle 3GHz~18GHz

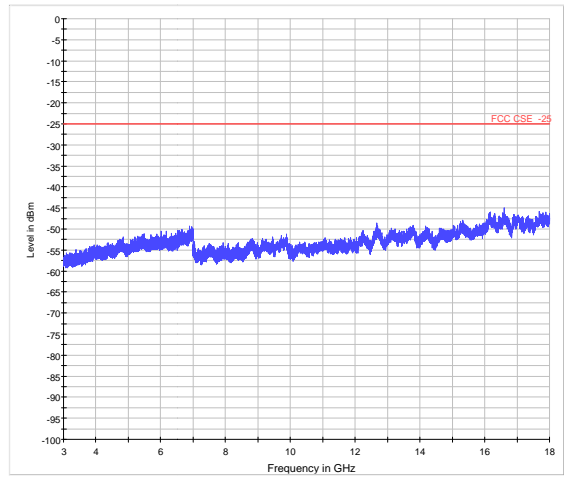

LTE Band 7 15MHz CH-Low 18GHz~26.5GHz

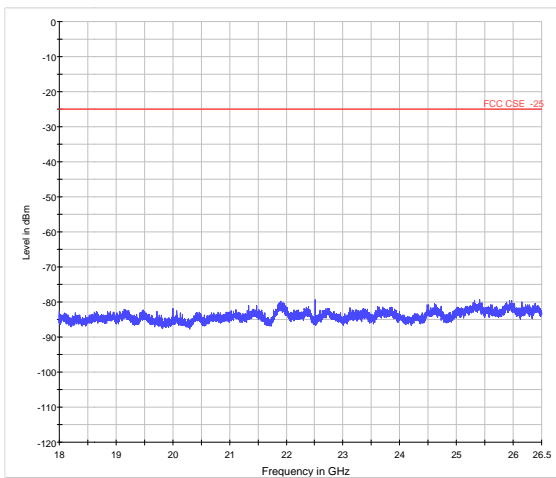

LTE Band 7 15MHz CH-Middle 18GHz~26.5GHz

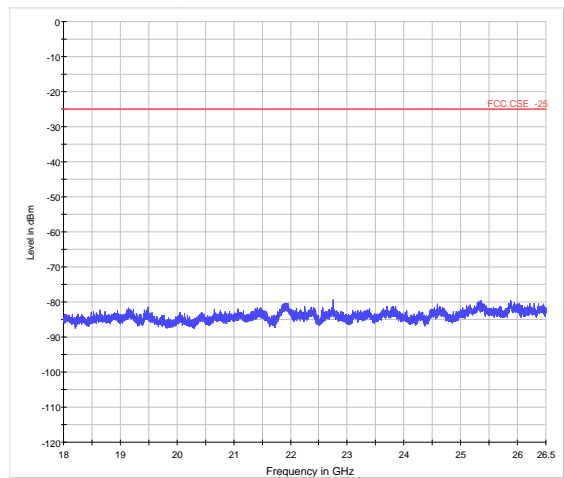



LTE Band 7 15MHz CH-High 30MHz~3GHz

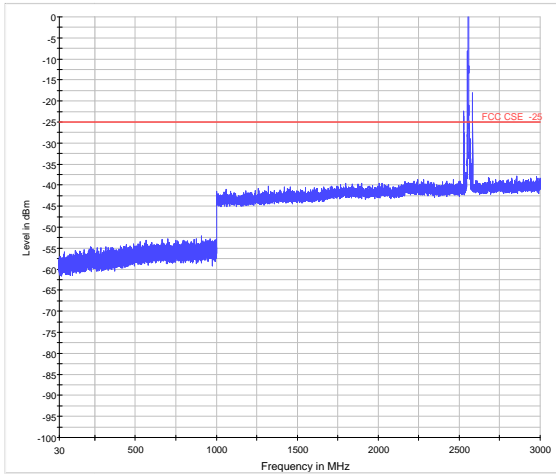

LTE Band 7 20MHz CH-Low 30MHz~3GHz

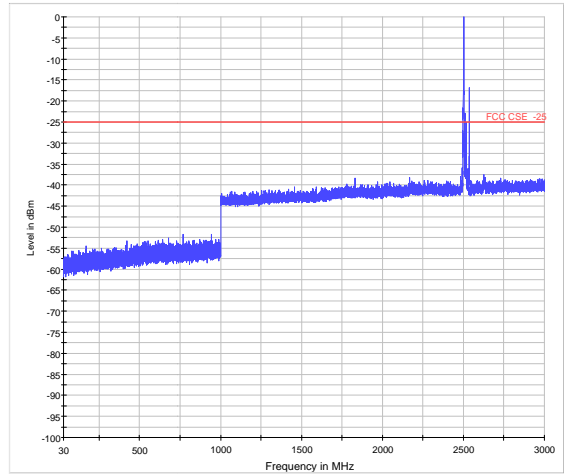

LTE Band 7 15MHz CH-High 3GHz~18GHz

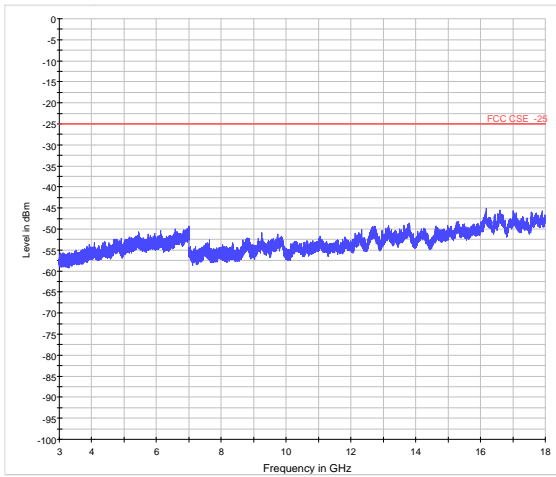

LTE Band 7 20MHz CH-Low 3GHz~18GHz

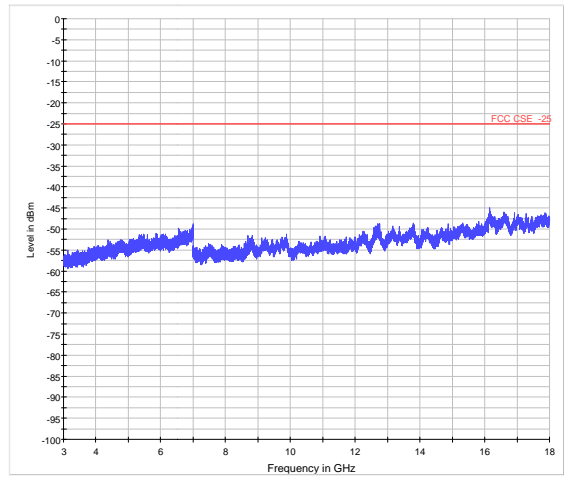

LTE Band 7 15MHz CH-High 18GHz~26.5GHz

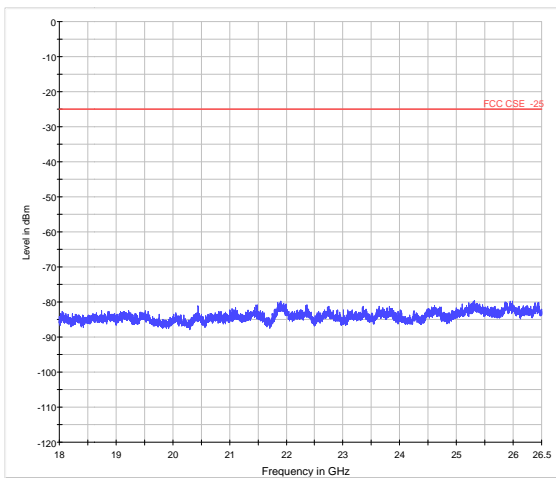

LTE Band 7 20MHz CH-Low 18GHz~26.5GHz

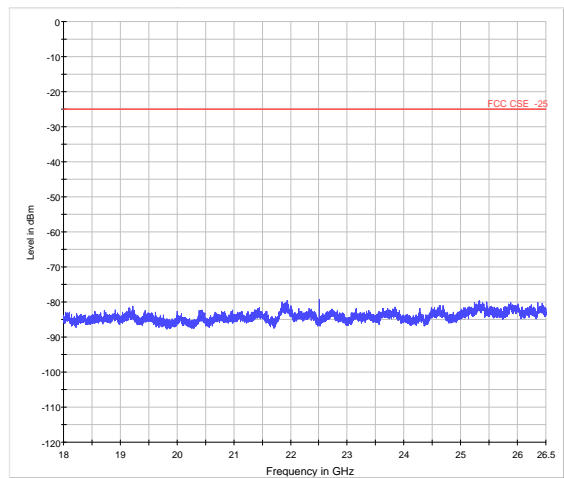



LTE Band 7 20MHz CH-Middle 30MHz~3GHz

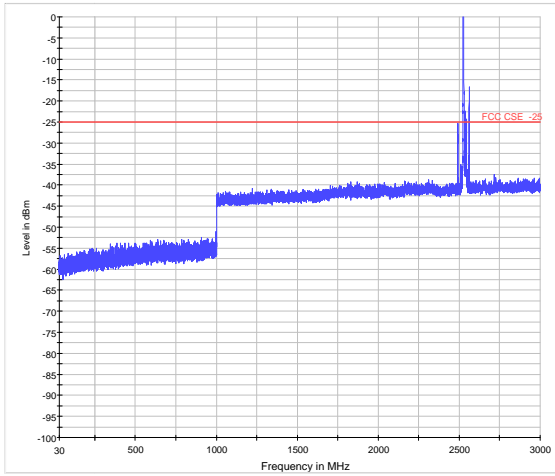

LTE Band 7 20MHz CH-High 30MHz~3GHz

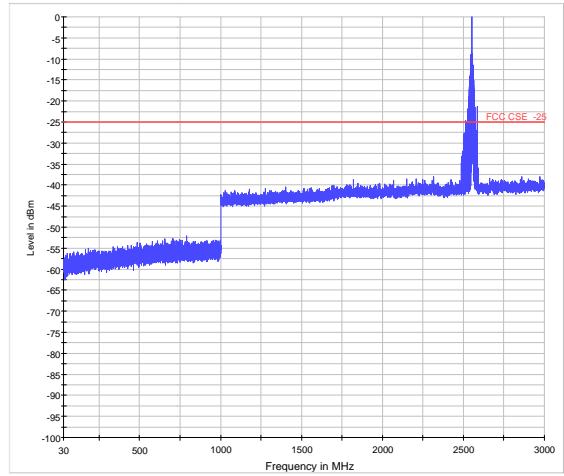

LTE Band 7 20MHz CH-Middle 3GHz~18GHz

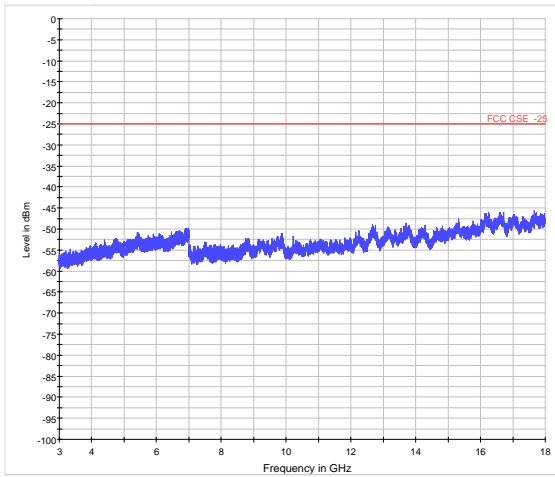

LTE Band 7 20MHz CH-High 3GHz~18GHz

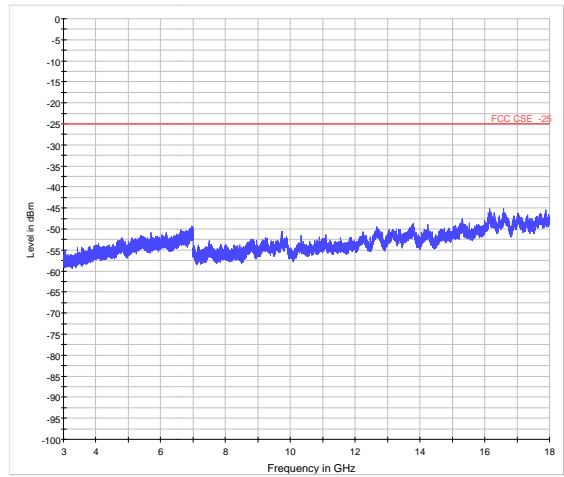

LTE Band 7 20MHz CH-Middle 18GHz~26.5GHz

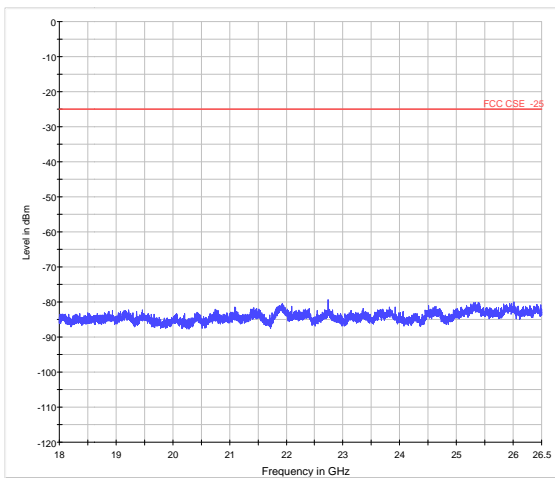

LTE Band 7 20MHz CH-High 18GHz~26.5GHz

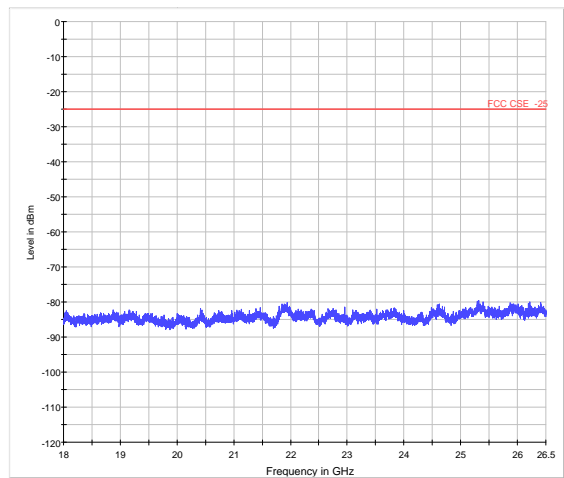

## 5.8 Radiates Spurious Emission

### Ambient condition

Temperature	Relative humidity	Pressure
23°C ~25°C	45%~50%	101.5kPa

### Method of Measurement

1. The testing follows FCC KDB 971168 v02r02 Section 5.8 and ANSI/TIA-603-D-2010.
2. The EUT is placed on a turntable 0.8 meters above the ground in the chamber, 3 meter away from the antenna. The maximal emission value is acquired by adjusting the antenna height, polarisation and turntable azimuth. Normally, the height range of antenna is 1 m to 4 m, the azimuth range of turntable is 0° to 360°, and the receive antenna has two polarizations Vertical (V) and Horizontal (H).
3. A log-periodic antenna or double-ridged waveguide horn antenna shall be substituted in place of the EUT. The log-periodic antenna will be driven by a signal generator and the level will be adjusted till the same power value on the spectrum analyzer or receiver. The level of the spurious emissions can be calculated through the level of the signal generator, cable loss, the gain of the substitution antenna and the reading of the spectrum analyzer or receiver.
4. The EUT is then put into continuously transmitting mode at its maximum power level during the test. Set Test Receiver or Spectrum RBW=1MHz, VBW=3MHz, And the maximum value of the receiver should be recorded as (Pr).
5. The EUT shall be replaced by a substitution antenna. In the chamber, an substitution antenna for the frequency band of interest is placed at the reference point of the chamber. An RF Signal source for the frequency band of interest is connected to the substitution antenna with a cable that has been constructed to not interfere with the radiation pattern of the antenna. A power (PMea) is applied to the input of the substitution antenna, and adjust the level of the signal generator output until the value of the receiver reach the previously recorded (Pr). The power of signal source (PMea) is recorded. The test should be performed by rotating the test item and adjusting the receiving antenna polarization.
6. A amplifier should be connected to the Signal Source output port. And the cable should be connect between the Amplifier and the Substitution Antenna. The cable loss (Pcl) ,the Substitution Antenna Gain (Ga) and the Amplifier Gain (PAg) should be recorded after test.
7. The measurement results are obtained as described below:  

$$\text{Power(EIRP)} = \text{PMea} - \text{PAg} - \text{Pcl} + \text{Ga}$$
 The measurement results are amend as described below:  

$$\text{Power(EIRP)} = \text{PMea} - \text{Pcl} + \text{Ga}$$
8. This value is EIRP since the measurement is calibrated using an antenna of known gain (2.15 dBi) and known input power. ERP can be calculated from EIRP by subtracting the gain of the dipole,  $\text{ERP} = \text{EIRP} - 2.15\text{dBi}$ .

**Test setup**

**30MHz~~~ 1GHz**

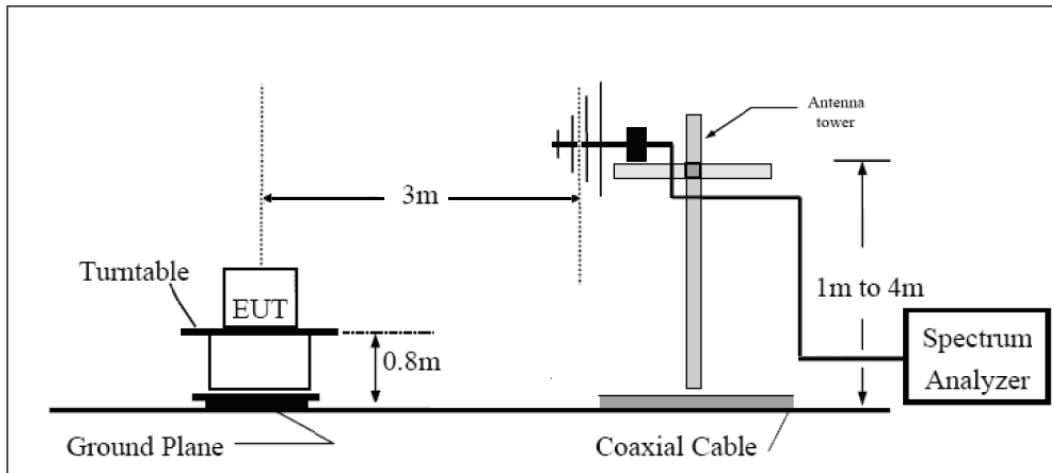

**Above 1GHz**

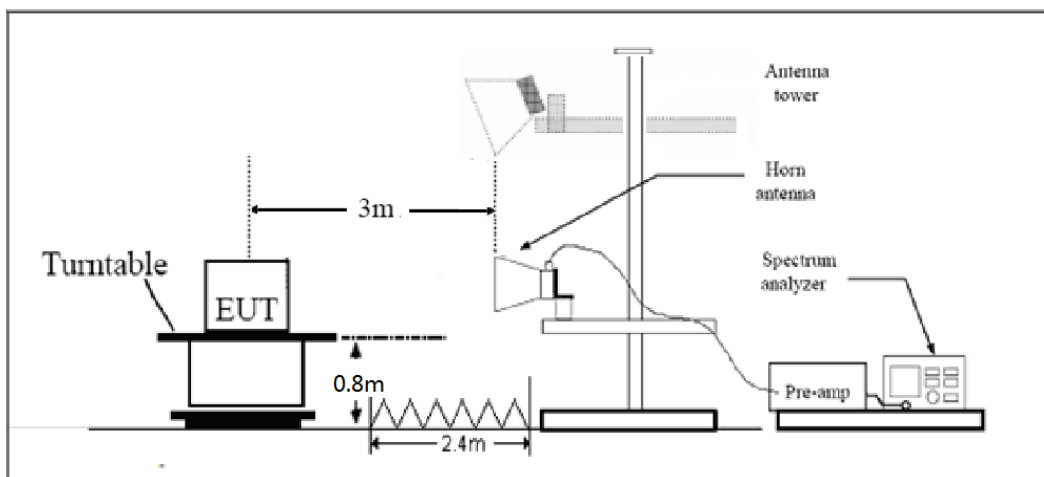

Note: Area side:2.4mX3.6m

The radiated emission was measured in the following position: EUT stand-up position (Z axis), lie-down position (X, Y axis). The worst emission was found in stand-up position (Z axis) and the worst case was recorded.

**Limits**

Rule Part 27.53(h) specifies that “for operations in the 1695-1710 MHz, 1710-1755 MHz, 1755-1780 MHz, 1915-1920 MHz, 1995-2000 MHz, 2000-2020 MHz, 2110-2155 MHz, 2155-2180 MHz, and 2180-2200 bands, the power of any emission outside a licensee's frequency block shall be attenuated below the transmitter power (P) in watts by at least  $43 + 10 \log_{10} (P)$  dB..”

Rule Part 27.53(m)  $55 + 10 \log (P)$  dB on all frequencies more than X megahertz from the channel edge, where X is the greater of 6 megahertz or the actual emission bandwidth as defined in paragraph (m)(4) of this section.



LTE B4 Limit	-13 dBm
LTE B7 Limit	-25 dBm

### Measurement Uncertainty

The assessed measurement uncertainty to ensure 95% confidence level for the normal distribution is with the coverage factor  $k = \pm 1.96$ ,  $U = \pm 3.55$  dB.

**Test Result**
**WCDMA Band IV CH-Low**

Harmonic	Frequency (MHz)	SG (dBm)	Cable Loss (dB)	Gain (dBi)	Antenna Polarization	EIRP Level (dBm)	Limit (dBm)	Margin (dB)	Azimuth (deg)
2	3424.8	-53.65	2.6	10.15	Horizontal	-46.10	-13.00	33.10	135
3	5137.2	-46.05	2.4	11.35	Horizontal	-37.10	-13.00	24.10	45
4	6850.1	-49.75	4.5	10.85	Horizontal	-43.40	-13.00	30.40	270
5	8562.0	-49.19	5.1	11.35	Horizontal	-42.94	-13.00	29.94	315
6	10274.4	-46.95	5.3	11.95	Horizontal	-40.30	-13.00	27.30	45
7	11986.8	-46.75	5.5	13.55	Horizontal	-38.70	-13.00	25.70	90
8	13699.2	-44.05	6.3	13.75	Horizontal	-36.60	-13.00	23.60	180
9	15411.6	-46.85	6.7	13.85	Horizontal	-39.70	-13.00	26.70	135
10	17124.0	-43.93	6.8	14.25	Horizontal	-36.48	-13.00	23.48	180

Note: 1.The other Spurious RF Radiated emissions level is no more than noise floor.  
2. The worst emission was found in the antenna is Horizontal position.

**WCDMA Band IV CH-Middle**

Harmonic	Frequency (MHz)	SG (dBm)	Cable Loss (dB)	Gain (dBi)	Antenna Polarization	EIRP Level (dBm)	Limit (dBm)	Margin (dB)	Azimuth (deg)
2	3462.8	-48.96	2.6	10.75	Horizontal	-40.81	-13.00	27.81	315
3	5201.3	-40.81	2.4	11.05	Horizontal	-32.16	-13.00	19.16	315
4	6925.1	-46.48	4.5	11.15	Horizontal	-39.83	-13.00	26.83	315
5	8663.0	-47.95	5.1	11.35	Horizontal	-41.70	-13.00	28.70	0
6	10395.6	-44.98	5.3	11.95	Horizontal	-38.33	-13.00	25.33	45
7	12128.2	-46.80	5.5	13.55	Horizontal	-38.75	-13.00	25.75	90
8	13860.8	-41.48	6.3	13.75	Horizontal	-34.03	-13.00	21.03	135
9	15593.4	-47.02	6.7	13.85	Horizontal	-39.87	-13.00	26.87	315
10	17326.0	-43.85	6.8	14.25	Horizontal	-36.40	-13.00	23.40	270

Note: 1.The other Spurious RF Radiated emissions level is no more than noise floor.  
2. The worst emission was found in the antenna is Horizontal position.



**WCDMA Band IV CH-High**

Harmonic	Frequency (MHz)	SG (dBm)	Cable Loss (dB)	Gain (dBi)	Antenna Polarization	EIRP Level (dBm)	Limit (dBm)	Margin (dB)	Azimuth (deg)
2	3503.3	-51.15	2.6	10.15	Horizontal	-43.60	-13.00	30.60	315
3	5254.1	-44.45	2.4	11.05	Horizontal	-35.80	-13.00	22.80	315
4	7010.4	-49.40	4.5	11.15	Horizontal	-42.75	-13.00	29.75	0
5	8763.0	-48.85	5.1	11.35	Horizontal	-42.60	-13.00	29.60	45
6	10515.6	-46.47	5.3	11.95	Horizontal	-39.82	-13.00	26.82	315
7	12268.2	-46.32	5.5	13.55	Horizontal	-38.27	-13.00	25.27	0
8	14020.8	-45.18	6.3	13.75	Horizontal	-37.73	-13.00	24.73	135
9	15773.4	-46.70	6.7	13.85	Horizontal	-39.55	-13.00	26.55	45
10	17526.0	-44.07	6.8	14.25	Horizontal	-36.62	-13.00	23.62	315

Note: 1.The other Spurious RF Radiated emissions level is no more than noise floor.  
 2. The worst emission was found in the antenna is Horizontal position.

**LTE Band 4 QPSK 1.4MHz CH-Low, RB 1**

Harmonic	Frequency (MHz)	SG (dBm)	Cable Loss (dB)	Gain (dBi)	Antenna Polarization	EIRP Level (dBm)	Limit (dBm)	Margin (dB)	Azimuth (deg)
2	3421.4	-57.85	2.6	10.15	Horizontal	-50.30	-13.00	37.3	270
3	5131.1	-43.05	2.4	11.35	Horizontal	-34.10	-13.00	21.1	180
4	6842.8	-43.25	4.5	10.85	Horizontal	-36.90	-13.00	23.9	135
5	8553.5	-47.15	5.1	11.35	Horizontal	-40.90	-13.00	27.9	270
6	10264.2	-45.75	5.3	11.95	Horizontal	-39.10	-13.00	26.1	180
7	11974.9	-45.95	5.5	13.55	Horizontal	-37.90	-13.00	24.9	225
8	13685.6	-43.65	6.3	13.75	Horizontal	-36.20	-13.00	23.2	45
9	15396.3	-43.85	6.7	13.85	Horizontal	-36.70	-13.00	23.7	270
10	17107.0	-41.95	6.8	14.25	Horizontal	-34.50	-13.00	21.5	180

Note: 1.The other Spurious RF Radiated emissions level is no more than noise floor.  
 2. The worst emission was found in the antenna is Horizontal position.

**LTE Band 4 QPSK 1.4MHz CH-Middle, RB 1**

Harmonic	Frequency (MHz)	SG (dBm)	Cable Loss (dB)	Gain (dBi)	Antenna Polarization	EIRP Level (dBm)	Limit (dBm)	Margin (dB)	Azimuth (deg)
2	3464.3	-53.05	2.6	10.75	Horizontal	-44.90	-13.00	31.9	135
3	5197.5	-43.15	2.4	11.05	Horizontal	-34.50	-13.00	21.5	270
4	6930.0	-42.25	4.5	11.15	Horizontal	-35.60	-13.00	22.6	180
5	8662.5	-46.45	5.1	11.35	Horizontal	-40.20	-13.00	27.2	225
6	10395.0	-43.95	5.3	11.95	Horizontal	-37.30	-13.00	24.3	270
7	12127.5	-45.75	5.5	13.55	Horizontal	-37.70	-13.00	24.7	180
8	13860.0	-43.15	6.3	13.75	Horizontal	-35.70	-13.00	22.7	135
9	15592.5	-45.05	6.7	13.85	Horizontal	-37.90	-13.00	24.9	270
10	17325.0	-43.25	6.8	14.25	Horizontal	-35.80	-13.00	22.8	180

Note: 1.The other Spurious RF Radiated emissions level is no more than noise floor.  
2. The worst emission was found in the antenna is Horizontal position.

**LTE Band 4 QPSK 1.4MHz CH-High, RB 1**

Harmonic	Frequency (MHz)	SG (dBm)	Cable Loss (dB)	Gain (dBi)	Antenna Polarization	EIRP Level (dBm)	Limit (dBm)	Margin (dB)	Azimuth (deg)
2	3507.8	-52.15	2.6	10.15	Horizontal	-44.60	-13.00	31.6	225
3	5261.6	-49.05	2.4	11.05	Horizontal	-40.40	-13.00	27.4	45
4	7017.2	-46.85	4.5	11.15	Horizontal	-40.20	-13.00	27.2	270
5	8771.5	-43.35	5.1	11.35	Horizontal	-37.10	-13.00	24.1	180
6	10525.8	-43.85	5.3	11.95	Horizontal	-37.20	-13.00	24.2	135
7	12280.1	-42.35	5.5	13.55	Horizontal	-34.30	-13.00	21.3	270
8	14034.4	-43.45	6.3	13.75	Horizontal	-36.00	-13.00	23.0	180
9	15788.7	-43.25	6.7	13.85	Horizontal	-36.10	-13.00	23.1	225
10	17543.0	-41.85	6.8	14.25	Horizontal	-34.40	-13.00	21.4	45

Note: 1.The other Spurious RF Radiated emissions level is no more than noise floor.  
2. The worst emission was found in the antenna is Horizontal position.

**LTE Band 4 QPSK 3MHz CH-Low, RB 1**

Harmonic	Frequency (MHz)	SG (dBm)	Cable Loss (dB)	Gain (dBi)	Antenna Polarization	EIRP Level (dBm)	Limit (dBm)	Margin (dB)	Azimuth (deg)
2	3423.0	-50.25	2.6	10.15	Horizontal	-42.70	-13.00	29.7	90
3	5134.5	-43.35	2.4	11.35	Horizontal	-34.40	-13.00	21.4	270
4	6846.0	-44.05	4.5	10.85	Horizontal	-37.70	-13.00	24.7	180
5	8557.5	-47.35	5.1	11.35	Horizontal	-41.10	-13.00	28.1	135
6	10269.0	-46.95	5.3	11.95	Horizontal	-40.30	-13.00	27.3	270
7	11980.5	-44.35	5.5	13.55	Horizontal	-36.30	-13.00	23.3	180
8	13692.0	-46.05	6.3	13.75	Horizontal	-38.60	-13.00	25.6	225
9	15403.5	-44.25	6.7	13.85	Horizontal	-37.10	-13.00	24.1	45
10	17115.0	-43.55	6.8	14.25	Horizontal	-36.10	-13.00	23.1	90

Note: 1.The other Spurious RF Radiated emissions level is no more than noise floor.  
2. The worst emission was found in the antenna is Horizontal position.

**LTE Band 4 QPSK 3MHz CH-Middle, RB 1**

Harmonic	Frequency (MHz)	SG (dBm)	Cable Loss (dB)	Gain (dBi)	Antenna Polarization	EIRP Level (dBm)	Limit (dBm)	Margin (dB)	Azimuth (deg)
2	3465.0	-54.55	2.6	10.75	Horizontal	-46.40	-13.00	33.40	180
3	5197.5	-51.75	2.4	11.05	Horizontal	-43.10	-13.00	30.10	270
4	6930.0	-46.55	4.5	11.15	Horizontal	-39.90	-13.00	26.90	45
5	8662.5	-46.75	5.1	11.35	Horizontal	-40.50	-13.00	27.50	90
6	10395.0	-45.25	5.3	11.95	Horizontal	-38.60	-13.00	25.60	135
7	12127.5	-45.85	5.5	13.55	Horizontal	-37.80	-13.00	24.80	225
8	13860.0	-42.65	6.3	13.75	Horizontal	-35.20	-13.00	22.20	180
9	15592.5	-44.85	6.7	13.85	Horizontal	-37.70	-13.00	24.70	270
10	17325.0	-43.05	6.8	14.25	Horizontal	-35.60	-13.00	22.60	45

Note: 1.The other Spurious RF Radiated emissions level is no more than noise floor.  
2. The worst emission was found in the antenna is Horizontal position.

**LTE Band 4 QPSK 3MHz CH-High, RB 1**

Harmonic	Frequency (MHz)	SG (dBm)	Cable Loss (dB)	Gain (dBi)	Antenna Polarization	EIRP Level (dBm)	Limit (dBm)	Margin (dB)	Azimuth (deg)
2	3504.8	-53.55	2.6	10.15	Horizontal	-46.00	-13.00	33.00	270
3	5256.8	-48.85	2.4	11.05	Horizontal	-40.20	-13.00	27.20	180
4	7014.0	-47.95	4.5	11.15	Horizontal	-41.30	-13.00	28.30	225
5	8767.5	-47.95	5.1	11.35	Horizontal	-41.70	-13.00	28.70	45
6	10521.0	-45.35	5.3	11.95	Horizontal	-38.70	-13.00	25.70	90
7	12274.5	-45.45	5.5	13.55	Horizontal	-37.40	-13.00	24.40	180
8	14028.0	-44.05	6.3	13.75	Horizontal	-36.60	-13.00	23.60	270
9	15781.5	-41.45	6.7	13.85	Horizontal	-34.30	-13.00	21.30	135
10	17535.0	-43.15	6.8	14.25	Horizontal	-35.70	-13.00	22.70	180

Note: 1.The other Spurious RF Radiated emissions level is no more than noise floor.  
2. The worst emission was found in the antenna is Horizontal position.

**LTE Band 4 QPSK 5MHz CH-Low, RB 1**

Harmonic	Frequency (MHz)	SG (dBm)	Cable Loss (dB)	Gain (dBi)	Antenna Polarization	EIRP Level (dBm)	Limit (dBm)	Margin (dB)	Azimuth (deg)
2	3425.0	-54.25	2.6	10.15	Horizontal	-46.70	-13.00	33.70	225
3	5131.1	-43.65	2.4	11.35	Horizontal	-34.70	-13.00	21.70	45
4	6850.0	-43.95	4.5	10.85	Horizontal	-37.60	-13.00	24.60	90
5	8562.5	-47.35	5.1	11.35	Horizontal	-41.10	-13.00	28.10	180
6	10275.0	-46.95	5.3	11.95	Horizontal	-40.30	-13.00	27.30	270
7	11987.5	-46.35	5.5	13.55	Horizontal	-38.30	-13.00	25.30	180
8	13700.0	-44.65	6.3	13.75	Horizontal	-37.20	-13.00	24.20	225
9	15412.5	-45.45	6.7	13.85	Horizontal	-38.30	-13.00	25.30	45
10	17125.0	-43.35	6.8	14.25	Horizontal	-35.90	-13.00	22.90	90

Note: 1.The other Spurious RF Radiated emissions level is no more than noise floor.  
2. The worst emission was found in the antenna is Horizontal position.

**LTE Band 4 QPSK 5MHz CH-Middle, RB 1**

Harmonic	Frequency (MHz)	SG (dBm)	Cable Loss (dB)	Gain (dBi)	Antenna Polarization	EIRP Level (dBm)	Limit (dBm)	Margin (dB)	Azimuth (deg)
2	3460.5	-50.55	2.6	10.75	Horizontal	-42.40	-13.00	29.40	180
3	5191.5	-39.85	2.4	11.05	Horizontal	-31.20	-13.00	18.20	135
4	6930.0	-43.35	4.5	11.15	Horizontal	-36.70	-13.00	23.70	270
5	8662.5	-48.75	5.1	11.35	Horizontal	-42.50	-13.00	29.50	180
6	10395.0	-46.05	5.3	11.95	Horizontal	-39.40	-13.00	26.40	225
7	12127.5	-44.75	5.5	13.55	Horizontal	-36.70	-13.00	23.70	45
8	13860.0	-44.25	6.3	13.75	Horizontal	-36.80	-13.00	23.80	90
9	15592.5	-43.25	6.7	13.85	Horizontal	-36.10	-13.00	23.10	270
10	17325.0	-42.45	6.8	14.25	Horizontal	-35.00	-13.00	22.00	180

Note: 1.The other Spurious RF Radiated emissions level is no more than noise floor.  
2. The worst emission was found in the antenna is Horizontal position.

**LTE Band 4 QPSK 5MHz CH-High, RB 1**

Harmonic	Frequency (MHz)	SG (dBm)	Cable Loss (dB)	Gain (dBi)	Antenna Polarization	EIRP Level (dBm)	Limit (dBm)	Margin (dB)	Azimuth (deg)
2	3500.6	-50.75	2.6	10.15	Horizontal	-43.20	-13.00	30.20	225
3	5250.8	-47.85	2.4	11.05	Horizontal	-39.20	-13.00	26.20	45
4	7010.0	-48.35	4.5	11.15	Horizontal	-41.70	-13.00	28.70	135
5	8762.5	-47.15	5.1	11.35	Horizontal	-40.90	-13.00	27.90	180
6	10515.0	-45.25	5.3	11.95	Horizontal	-38.60	-13.00	25.60	225
7	12267.5	-44.75	5.5	13.55	Horizontal	-36.70	-13.00	23.70	45
8	14020.0	-45.35	6.3	13.75	Horizontal	-37.90	-13.00	24.90	90
9	15772.5	-43.95	6.7	13.85	Horizontal	-36.80	-13.00	23.80	270
10	17525.0	-46.15	6.8	14.25	Horizontal	-38.70	-13.00	25.70	180

Note: 1.The other Spurious RF Radiated emissions level is no more than noise floor.  
2. The worst emission was found in the antenna is Horizontal position.

**LTE Band 4 QPSK 10MHz CH-Low, RB 1**

Harmonic	Frequency (MHz)	SG (dBm)	Cable Loss (dB)	Gain (dBi)	Antenna Polarization	EIRP Level (dBm)	Limit (dBm)	Margin (dB)	Azimuth (deg)
2	3420.8	-54.75	2.6	10.15	Horizontal	-47.20	-13.00	34.20	225
3	5131.9	-42.45	2.4	11.35	Horizontal	-33.50	-13.00	20.50	45
4	6860.0	-43.75	4.5	10.85	Horizontal	-37.40	-13.00	24.40	90
5	8575.0	-48.15	5.1	11.35	Horizontal	-41.90	-13.00	28.90	180
6	10290.0	-47.15	5.3	11.95	Horizontal	-40.50	-13.00	27.50	270
7	12005.0	-45.95	5.5	13.55	Horizontal	-37.90	-13.00	24.90	135
8	13720.0	-45.85	6.3	13.75	Horizontal	-38.40	-13.00	25.40	180
9	15435.0	-44.35	6.7	13.85	Horizontal	-37.20	-13.00	24.20	225
10	17150.0	-44.25	6.8	14.25	Horizontal	-36.80	-13.00	23.80	45

Note: 1.The other Spurious RF Radiated emissions level is no more than noise floor.  
2. The worst emission was found in the antenna is Horizontal position.

**LTE Band 4 QPSK 10MHz CH-Middle, RB 1**

Harmonic	Frequency (MHz)	SG (dBm)	Cable Loss (dB)	Gain (dBi)	Antenna Polarization	EIRP Level (dBm)	Limit (dBm)	Margin (dB)	Azimuth (deg)
2	3456.0	-53.95	2.6	10.75	Horizontal	-45.80	-13.00	32.80	90
3	5184.4	-43.75	2.4	11.05	Horizontal	-35.10	-13.00	22.10	180
4	6930.0	-43.55	4.5	11.15	Horizontal	-36.90	-13.00	23.90	270
5	8662.5	-48.15	5.1	11.35	Horizontal	-41.90	-13.00	28.90	180
6	10395.0	-46.15	5.3	11.95	Horizontal	-39.50	-13.00	26.50	225
7	12127.5	-46.15	5.5	13.55	Horizontal	-38.10	-13.00	25.10	45
8	13860.0	-40.55	6.3	13.75	Horizontal	-33.10	-13.00	20.10	90
9	15592.5	-45.55	6.7	13.85	Horizontal	-38.40	-13.00	25.40	180
10	17325.0	-43.15	6.8	14.25	Horizontal	-35.70	-13.00	22.70	135

Note: 1.The other Spurious RF Radiated emissions level is no more than noise floor.  
2. The worst emission was found in the antenna is Horizontal position.

**LTE Band 4 QPSK 10MHz CH-High, RB 1**

Harmonic	Frequency (MHz)	SG (dBm)	Cable Loss (dB)	Gain (dBi)	Antenna Polarization	EIRP Level (dBm)	Limit (dBm)	Margin (dB)	Azimuth (deg)
2	3490.9	-50.85	2.6	10.15	Horizontal	-43.30	-13.00	30.30	270
3	5236.9	-44.65	2.4	11.05	Horizontal	-36.00	-13.00	23.00	180
4	7000.0	-45.75	4.5	11.15	Horizontal	-39.10	-13.00	26.10	225
5	8750.0	-47.55	5.1	11.35	Horizontal	-41.30	-13.00	28.30	45
6	10500.0	-44.85	5.3	11.95	Horizontal	-38.20	-13.00	25.20	90
7	12250.0	-45.95	5.5	13.55	Horizontal	-37.90	-13.00	24.90	180
8	14000.0	-44.65	6.3	13.75	Horizontal	-37.20	-13.00	24.20	270
9	15750.0	-45.45	6.7	13.85	Horizontal	-38.30	-13.00	25.30	45
10	17500.0	-43.85	6.8	14.25	Horizontal	-36.40	-13.00	23.40	135

Note: 1.The other Spurious RF Radiated emissions level is no more than noise floor.  
2. The worst emission was found in the antenna is Horizontal position.

**LTE Band 4 QPSK 15MHz CH Low, RB 1**

Harmonic	Frequency (MHz)	SG (dBm)	Cable Loss (dB)	Gain (dBi)	Antenna Polarization	EIRP Level (dBm)	Limit (dBm)	Margin (dB)	Azimuth (deg)
2	3448.1	-55.45	2.6	10.15	Horizontal	-47.90	-13.00	34.90	45
3	5132.6	-46.85	2.4	11.35	Horizontal	-37.90	-13.00	24.90	90
4	6870.0	-42.15	4.5	10.85	Horizontal	-35.80	-13.00	22.80	90
5	8587.5	-49.35	5.1	11.35	Horizontal	-43.10	-13.00	30.10	45
6	10305.0	-46.65	5.3	11.95	Horizontal	-40.00	-13.00	27.00	135
7	12022.5	-45.95	5.5	13.55	Horizontal	-37.90	-13.00	24.90	225
8	13740.0	-44.95	6.3	13.75	Horizontal	-37.50	-13.00	24.50	45
9	15457.5	-45.85	6.7	13.85	Horizontal	-38.70	-13.00	25.70	90
10	17175.0	-44.15	6.8	14.25	Horizontal	-36.70	-13.00	23.70	135

Note: 1.The other Spurious RF Radiated emissions level is no more than noise floor.  
2. The worst emission was found in the antenna is Horizontal position.

**LTE Band 4 QPSK 15MHz CH-Middle, RB 1**

Harmonic	Frequency (MHz)	SG (dBm)	Cable Loss (dB)	Gain (dBi)	Antenna Polarization	EIRP Level (dBm)	Limit (dBm)	Margin (dB)	Azimuth (deg)
2	3478.1	-52.85	2.6	10.75	Horizontal	-44.70	-13.00	31.70	135
3	5217.8	-43.45	2.4	11.05	Horizontal	-34.80	-13.00	21.80	45
4	6930.0	-43.15	4.5	11.15	Horizontal	-36.50	-13.00	23.50	90
5	8662.5	-45.85	5.1	11.35	Horizontal	-39.60	-13.00	26.60	180
6	10395.0	-47.05	5.3	11.95	Horizontal	-40.40	-13.00	27.40	270
7	12127.5	-46.55	5.5	13.55	Horizontal	-38.50	-13.00	25.50	225
8	13860.0	-44.65	6.3	13.75	Horizontal	-37.20	-13.00	24.20	135
9	15592.5	-45.85	6.7	13.85	Horizontal	-38.70	-13.00	25.70	225
10	17325.0	-44.55	6.8	14.25	Horizontal	-37.10	-13.00	24.10	45

Note: 1.The other Spurious RF Radiated emissions level is no more than noise floor.

2. The worst emission was found in the antenna is Horizontal position.

**LTE Band 4 QPSK 15MHz CH-High, RB 1**

Harmonic	Frequency (MHz)	SG (dBm)	Cable Loss (dB)	Gain (dBi)	Antenna Polarization	EIRP Level (dBm)	Limit (dBm)	Margin (dB)	Azimuth (deg)
2	3508.1	-54.75	2.6	10.15	Horizontal	-47.20	-13.00	34.20	90
3	5262.8	-49.15	2.4	11.05	Horizontal	-40.50	-13.00	27.50	135
4	6990.0	-50.25	4.5	11.15	Horizontal	-43.60	-13.00	30.60	225
5	8737.5	-47.25	5.1	11.35	Horizontal	-41.00	-13.00	28.00	45
6	10485.0	-44.35	5.3	11.95	Horizontal	-37.70	-13.00	24.70	90
7	12232.5	-44.85	5.5	13.55	Horizontal	-36.80	-13.00	23.80	135
8	13980.0	-43.85	6.3	13.75	Horizontal	-36.40	-13.00	23.40	135
9	15727.5	-43.25	6.7	13.85	Horizontal	-36.10	-13.00	23.10	90
10	17475.0	-43.15	6.8	14.25	Horizontal	-35.70	-13.00	22.70	225

Note: 1.The other Spurious RF Radiated emissions level is no more than noise floor.

2. The worst emission was found in the antenna is Horizontal position.



**LTE Band 4 QPSK 20MHz CH-Low, RB 1**

Harmonic	Frequency (MHz)	SG (dBm)	Cable Loss (dB)	Gain (dBi)	Antenna Polarization	EIRP Level (dBm)	Limit (dBm)	Margin (dB)	Azimuth (deg)
2	3421.9	-54.25	2.6	10.15	Horizontal	-46.70	-13.00	33.70	135
3	5133.0	-44.25	2.4	11.35	Horizontal	-35.30	-13.00	22.30	90
4	6880.0	-43.05	4.5	10.85	Horizontal	-36.70	-13.00	23.70	45
5	8600.0	-47.85	5.1	11.35	Horizontal	-41.60	-13.00	28.60	90
6	10320.0	-45.05	5.3	11.95	Horizontal	-38.40	-13.00	25.40	90
7	12040.0	-44.15	5.5	13.55	Horizontal	-36.10	-13.00	23.10	135
8	13760.0	-45.65	6.3	13.75	Horizontal	-38.20	-13.00	25.20	225
9	15480.0	-44.55	6.7	13.85	Horizontal	-37.40	-13.00	24.40	135
10	17200.0	-44.05	6.8	14.25	Horizontal	-36.60	-13.00	23.60	90

Note: 1.The other Spurious RF Radiated emissions level is no more than noise floor.  
2. The worst emission was found in the antenna is Horizontal position.

**LTE Band 4 QPSK 20MHz CH-Middle, RB 1**

Harmonic	Frequency (MHz)	SG (dBm)	Cable Loss (dB)	Gain (dBi)	Antenna Polarization	EIRP Level (dBm)	Limit (dBm)	Margin (dB)	Azimuth (deg)
2	3447.0	-56.25	2.6	10.75	Horizontal	-48.10	-13.00	35.10	90
3	5170.5	-46.45	2.4	11.05	Horizontal	-37.80	-13.00	24.80	45
4	6930.0	-46.45	4.5	11.15	Horizontal	-39.80	-13.00	26.80	45
5	8662.5	-46.85	5.1	11.35	Horizontal	-40.60	-13.00	27.60	180
6	10395.0	-44.95	5.3	11.95	Horizontal	-38.30	-13.00	25.30	270
7	12127.5	-44.45	5.5	13.55	Horizontal	-36.40	-13.00	23.40	225
8	13860.0	-42.95	6.3	13.75	Horizontal	-35.50	-13.00	22.50	135
9	15592.5	-44.05	6.7	13.85	Horizontal	-36.90	-13.00	23.90	180
10	17325.0	-43.85	6.8	14.25	Horizontal	-36.40	-13.00	23.40	225

Note: 1.The other Spurious RF Radiated emissions level is no more than noise floor.  
2. The worst emission was found in the antenna is Horizontal position.

**LTE Band 4 QPSK 20MHz CH-High, RB 1**

Harmonic	Frequency (MHz)	SG (dBm)	Cable Loss (dB)	Gain (dBi)	Antenna Polarization	EIRP Level (dBm)	Limit (dBm)	Margin (dB)	Azimuth (deg)
2	3472.1	-50.85	2.6	10.15	Horizontal	-43.30	-13.00	30.30	45
3	5208.4	-42.55	2.4	11.05	Horizontal	-33.90	-13.00	20.90	225
4	6980.0	-43.15	4.5	11.15	Horizontal	-36.50	-13.00	23.50	135
5	8725.0	-48.35	5.1	11.35	Horizontal	-42.10	-13.00	29.10	90
6	10470.0	-46.05	5.3	11.95	Horizontal	-39.40	-13.00	26.40	45
7	12215.0	-44.95	5.5	13.55	Horizontal	-36.90	-13.00	23.90	90
8	13960.0	-44.95	6.3	13.75	Horizontal	-37.50	-13.00	24.50	45
9	15705.0	-45.25	6.7	13.85	Horizontal	-38.10	-13.00	25.10	135
10	17450.0	-43.45	6.8	14.25	Horizontal	-36.00	-13.00	23.00	90

Note: 1.The other Spurious RF Radiated emissions level is no more than noise floor.

2. The worst emission was found in the antenna is Horizontal position.

**LTE Band 7 QPSK 5MHz CH-Low, RB 1**

Harmonic	Frequency (MHz)	SG (dBm)	Cable Loss (dB)	Gain (dBi)	Antenna Polarization	EIRP Level (dBm)	Limit (dBm)	Margin (dB)	Azimuth (deg)
2	5005.0	-52.05	2.00	9.15	Horizontal	-44.90	-25.00	19.90	180
3	7507.5	-50.15	2.50	11.35	Horizontal	-41.30	-25.00	16.30	225
4	10010.0	-47.25	4.20	12.05	Horizontal	-39.40	-25.00	14.40	45
5	12512.5	-46.05	5.20	12.85	Horizontal	-38.40	-25.00	13.40	180
6	15015.0	-46.23	5.50	14.23	Horizontal	-37.50	-25.00	12.50	270
7	17517.5	-43.65	5.70	14.15	Horizontal	-35.20	-25.00	10.20	135
8	20020.0	-42.16	6.30	13.76	Horizontal	-34.70	-25.00	9.70	180
9	22522.5	-40.95	6.80	14.05	Horizontal	-33.70	-25.00	8.70	225
10	25025.0	-40.74	6.90	14.84	Horizontal	-32.80	-25.00	7.80	90

Note: 1.The other Spurious RF Radiated emissions level is no more than noise floor.

2. The worst emission was found in the antenna is Horizontal position.

**LTE Band 7 QPSK 5MHz CH-Middle, RB 1**

Harmonic	Frequency (MHz)	SG (dBm)	Cable Loss (dB)	Gain (dBi)	Antenna Polarization	EIRP Level (dBm)	Limit (dBm)	Margin (dB)	Azimuth (deg)
2	5070.0	-51.25	2.00	9.15	Horizontal	-44.10	-25.00	19.10	135
3	7605.0	-50.55	2.50	11.35	Horizontal	-41.70	-25.00	16.70	180
4	10140.0	-45.91	4.20	12.05	Horizontal	-38.06	-25.00	13.06	90
5	12675.0	-44.45	5.20	12.85	Horizontal	-36.80	-25.00	11.80	45
6	15210.0	-47.13	5.50	14.23	Horizontal	-38.40	-25.00	13.40	180
7	17745.0	-43.95	5.70	14.15	Horizontal	-35.50	-25.00	10.50	270
8	20280.0	-42.26	6.30	13.76	Horizontal	-34.80	-25.00	9.80	45
9	22815.0	-41.35	6.80	14.05	Horizontal	34.10	-25.00	-59.10	180
10	25350.0	-41.64	6.90	14.84	Horizontal	-33.70	-25.00	8.70	225

Note: 1.The other Spurious RF Radiated emissions level is no more than noise floor.

2. The worst emission was found in the antenna is Horizontal position.

**LTE Band 7 QPSK 5MHz CH-High, RB 1**

Harmonic	Frequency (MHz)	SG (dBm)	Cable Loss (dB)	Gain (dBi)	Antenna Polarization	EIRP Level (dBm)	Limit (dBm)	Margin (dB)	Azimuth (deg)
2	5135.0	-52.35	2.00	9.15	Horizontal	-45.20	-25.00	20.20	225
3	7702.5	-50.95	2.50	11.35	Horizontal	-42.10	-25.00	17.10	45
4	10270.0	-47.15	4.20	12.05	Horizontal	-39.30	-25.00	14.30	90
5	12837.5	-44.05	5.20	12.85	Horizontal	-36.40	-25.00	11.40	180
6	15405.0	-46.13	5.50	14.23	Horizontal	-37.40	-25.00	12.40	180
7	17972.5	-44.25	5.70	14.15	Horizontal	-35.80	-25.00	10.80	270
8	20540.0	-42.16	6.30	13.76	Horizontal	-34.70	-25.00	9.70	135
9	23107.5	-40.45	6.80	14.05	Horizontal	-33.20	-25.00	8.20	180
10	25675.0	-40.34	6.90	14.84	Horizontal	-32.40	-25.00	7.40	225

Note: 1.The other Spurious RF Radiated emissions level is no more than noise floor.

2. The worst emission was found in the antenna is Horizontal position.

**LTE Band 7 QPSK 10MHz CH-Low, RB 1**

Harmonic	Frequency (MHz)	SG (dBm)	Cable Loss (dB)	Gain (dBi)	Antenna Polarization	EIRP Level (dBm)	Limit (dBm)	Margin (dB)	Azimuth (deg)
2	5010.0	-52.85	2.00	9.15	Horizontal	-45.70	-25.00	20.70	225
3	7515.0	-50.85	2.50	11.35	Horizontal	-42.00	-25.00	17.00	45
4	10020.0	-46.45	4.20	12.05	Horizontal	-38.60	-25.00	13.60	180
5	12525.0	-45.05	5.20	12.85	Horizontal	-37.40	-25.00	12.40	270
6	15030.0	-45.23	5.50	14.23	Horizontal	-36.50	-25.00	11.50	135
7	17535.0	-44.15	5.70	14.15	Horizontal	-35.70	-25.00	10.70	180
8	20040.0	-43.26	6.30	13.76	Horizontal	-35.80	-25.00	10.80	225
9	22545.0	-41.45	6.80	14.05	Horizontal	-34.20	-25.00	9.20	90
10	25050.0	-41.24	6.90	14.84	Horizontal	-33.30	-25.00	8.30	135

Note: 1.The other Spurious RF Radiated emissions level is no more than noise floor.

2. The worst emission was found in the antenna is Horizontal position.

**LTE Band 7 QPSK 10MHz CH-Middle, RB 1**

Harmonic	Frequency (MHz)	SG (dBm)	Cable Loss (dB)	Gain (dBi)	Antenna Polarization	EIRP Level (dBm)	Limit (dBm)	Margin (dB)	Azimuth (deg)
2	5070.0	-51.95	2.00	9.15	Horizontal	-44.80	-25.00	19.80	45
3	7605.0	-50.55	2.50	11.35	Horizontal	-41.70	-25.00	16.70	180
4	10140.0	-46.35	4.20	12.05	Horizontal	-38.50	-25.00	13.50	270
5	12675.0	-44.05	5.20	12.85	Horizontal	-36.40	-25.00	11.40	135
6	15210.0	-44.63	5.50	14.23	Horizontal	-35.90	-25.00	10.90	180
7	17745.0	-43.55	5.70	14.15	Horizontal	-35.10	-25.00	10.10	225
8	20280.0	-41.96	6.30	13.76	Horizontal	-34.50	-25.00	9.50	45
9	22815.0	-41.05	6.80	14.05	Horizontal	-33.80	-25.00	8.80	90
10	25350.0	-40.34	6.90	14.84	Horizontal	-32.40	-25.00	7.40	180

Note: 1.The other Spurious RF Radiated emissions level is no more than noise floor.

2. The worst emission was found in the antenna is Horizontal position.

**LTE Band 7 QPSK 10MHz CH-High, RB 1**

Harmonic	Frequency (MHz)	SG (dBm)	Cable Loss (dB)	Gain (dBi)	Antenna Polarization	EIRP Level (dBm)	Limit (dBm)	Margin (dB)	Azimuth (deg)
2	5130.0	-53.25	2.00	10.15	Horizontal	-45.10	-25.00	20.10	45
3	7695.0	-50.15	2.50	11.35	Horizontal	-41.30	-25.00	16.30	180
4	10260.0	-47.05	4.20	12.05	Horizontal	-39.20	-25.00	14.20	225
5	12825.0	-47.45	5.20	14.85	Horizontal	-37.80	-25.00	12.80	45
6	15390.0	-44.13	5.50	13.23	Horizontal	-36.40	-25.00	11.40	90
7	17955.0	-41.65	5.70	12.15	Horizontal	-35.20	-25.00	10.20	180
8	20520.0	-42.26	6.30	13.76	Horizontal	-34.80	-25.00	9.80	270
9	23085.0	-41.15	6.80	14.05	Horizontal	-33.90	-25.00	8.90	180
10	25650.0	-41.34	6.90	14.84	Horizontal	-33.40	-25.00	8.40	270

Note: 1.The other Spurious RF Radiated emissions level is no more than noise floor.

2. The worst emission was found in the antenna is Horizontal position.

**LTE Band 7 QPSK 15MHz CH-Low, RB 1**

Harmonic	Frequency (MHz)	SG (dBm)	Cable Loss (dB)	Gain (dBi)	Antenna Polarization	EIRP Level (dBm)	Limit (dBm)	Margin (dB)	Azimuth (deg)
2	5015.0	-53.95	2.00	10.15	Horizontal	-45.80	-25.00	20.80	270
3	7522.5	-49.75	2.50	11.35	Horizontal	-40.90	-25.00	15.90	135
4	10030.0	-45.85	4.20	12.05	Horizontal	-38.00	-25.00	13.00	180
5	12537.5	-45.45	5.20	14.85	Horizontal	-35.80	-25.00	10.80	225
6	15045.0	-43.33	5.50	13.23	Horizontal	-35.60	-25.00	10.60	45
7	17552.5	-41.15	5.70	12.15	Horizontal	-34.70	-25.00	9.70	90
8	20060.0	-41.96	6.30	13.76	Horizontal	-34.50	-25.00	9.50	180
9	22567.5	-40.65	6.80	14.05	Horizontal	-33.40	-25.00	8.40	270
10	25075.0	-40.24	6.90	14.84	Horizontal	-32.30	-25.00	7.30	135

Note: 1.The other Spurious RF Radiated emissions level is no more than noise floor.

2. The worst emission was found in the antenna is Horizontal position.

**LTE Band 7 QPSK 15MHz CH-Middle, RB 1**

Harmonic	Frequency (MHz)	SG (dBm)	Cable Loss (dB)	Gain (dBi)	Antenna Polarization	EIRP Level (dBm)	Limit (dBm)	Margin (dB)	Azimuth (deg)
2	5070.0	-53.25	2.00	10.15	Horizontal	-45.10	-25.00	20.10	180
3	7605.0	-50.35	2.50	11.35	Horizontal	-41.50	-25.00	16.50	270
4	10140.0	-46.85	4.20	12.05	Horizontal	-39.00	-25.00	14.00	135
5	12675.0	-47.45	5.20	14.85	Horizontal	-37.80	-25.00	12.80	180
6	15210.0	-44.13	5.50	13.23	Horizontal	-36.40	-25.00	11.40	225
7	17745.0	-42.25	5.70	12.15	Horizontal	-35.80	-25.00	10.80	45
8	20280.0	-43.06	6.30	13.76	Horizontal	-35.60	-25.00	10.60	180
9	22815.0	-42.05	6.80	14.05	Horizontal	-34.80	-25.00	9.80	270
10	25350.0	-41.34	6.90	14.84	Horizontal	-33.40	-25.00	8.40	135

Note: 1.The other Spurious RF Radiated emissions level is no more than noise floor.

2. The worst emission was found in the antenna is Horizontal position.

**LTE Band 7 QPSK 15MHz CH-High, RB 1**

Harmonic	Frequency (MHz)	SG (dBm)	Cable Loss (dB)	Gain (dBi)	Antenna Polarization	EIRP Level (dBm)	Limit (dBm)	Margin (dB)	Azimuth (deg)
2	5125.0	-52.65	2.00	10.15	Horizontal	-44.50	-25.00	19.50	270
3	7687.5	-48.65	2.50	11.35	Horizontal	-39.80	-25.00	14.80	135
4	10250.0	-46.25	4.20	12.05	Horizontal	-38.40	-25.00	13.40	45
5	12812.5	-46.05	5.20	14.85	Horizontal	-36.40	-25.00	11.40	270
6	15375.0	-43.63	5.50	13.23	Horizontal	-35.90	-25.00	10.90	180
7	17937.5	-42.15	5.70	12.15	Horizontal	-35.70	-25.00	10.70	270
8	20500.0	-41.56	6.30	13.76	Horizontal	-34.10	-25.00	9.10	135
9	23062.5	-40.95	6.80	14.05	Horizontal	-33.70	-25.00	8.70	180
10	25625.0	-40.44	6.90	14.84	Horizontal	-32.50	-25.00	7.50	270

Note: 1.The other Spurious RF Radiated emissions level is no more than noise floor.

2. The worst emission was found in the antenna is Horizontal position.

**LTE Band 7 QPSK 20MHz CH-Low, RB 1**

Harmonic	Frequency (MHz)	SG (dBm)	Cable Loss (dB)	Gain (dBi)	Antenna Polarization	EIRP Level (dBm)	Limit (dBm)	Margin (dB)	Azimuth (deg)
2	5020.0	-53.95	2.00	10.15	Horizontal	-45.80	-25.00	20.80	270
3	7530.0	-43.05	2.50	11.35	Horizontal	-34.20	-25.00	9.20	180
4	10040.0	-46.55	4.20	12.05	Horizontal	-38.70	-25.00	13.70	270
5	12550.0	-45.85	5.20	14.85	Horizontal	-36.20	-25.00	11.20	135
6	15060.0	-42.93	5.50	13.23	Horizontal	-35.20	-25.00	10.20	180
7	17570.0	-40.85	5.70	12.15	Horizontal	-34.40	-25.00	9.40	270
8	20080.0	-41.26	6.30	13.76	Horizontal	-33.80	-25.00	8.80	135
9	22590.0	-40.45	6.80	14.05	Horizontal	-33.20	-25.00	8.20	45
10	25100.0	-40.24	6.90	14.84	Horizontal	-32.30	-25.00	7.30	270

Note: 1.The other Spurious RF Radiated emissions level is no more than noise floor.

2. The worst emission was found in the antenna is Horizontal position.

**LTE Band 7 QPSK 20MHz CH-Middle, RB 1**

Harmonic	Frequency (MHz)	SG (dBm)	Cable Loss (dB)	Gain (dBi)	Antenna Polarization	EIRP Level (dBm)	Limit (dBm)	Margin (dB)	Azimuth (deg)
2	5070.0	-53.65	2.00	10.15	Horizontal	-45.50	-25.00	20.50	270
3	7605.0	-50.15	2.50	11.35	Horizontal	-41.30	-25.00	16.30	135
4	10140.0	-46.05	4.20	12.05	Horizontal	-38.20	-25.00	13.20	45
5	12675.0	-47.45	5.20	14.85	Horizontal	-37.80	-25.00	12.80	270
6	15210.0	-45.13	5.50	13.23	Horizontal	-37.40	-25.00	12.40	180
7	17745.0	-42.65	5.70	12.15	Horizontal	-36.20	-25.00	11.20	270
8	20280.0	-43.46	6.30	13.76	Horizontal	-36.00	-25.00	11.00	135
9	22815.0	-42.65	6.80	14.05	Horizontal	-35.40	-25.00	10.40	45
10	25350.0	-42.64	6.90	14.84	Horizontal	-34.70	-25.00	9.70	180

Note: 1.The other Spurious RF Radiated emissions level is no more than noise floor.

2. The worst emission was found in the antenna is Horizontal position.



## LTE Band 7 QPSK 20MHz CH-High, RB 1

Harmonic	Frequency (MHz)	SG (dBm)	Cable Loss (dB)	Gain (dBi)	Antenna Polarization	EIRP Level (dBm)	Limit (dBm)	Margin (dB)	Azimuth (deg)
2	5120.0	-54.85	2.00	10.15	Horizontal	-46.70	-25.00	21.70	45
3	7680.0	-50.05	2.50	11.35	Horizontal	-41.20	-25.00	16.20	180
4	10240.0	-46.15	4.20	12.05	Horizontal	-38.30	-25.00	13.30	270
5	12800.0	-46.35	5.20	14.85	Horizontal	-36.70	-25.00	11.70	135
6	15360.0	-43.53	5.50	13.23	Horizontal	-35.80	-25.00	10.80	45
7	17920.0	-41.15	5.70	12.15	Horizontal	-34.70	-25.00	9.70	270
8	20480.0	-41.66	6.30	13.76	Horizontal	-34.20	-25.00	9.20	180
9	23040.0	-40.55	6.80	14.05	Horizontal	-33.30	-25.00	8.30	270
10	25600.0	-40.44	6.90	14.84	Horizontal	-32.50	-25.00	7.50	135

Note: 1.The other Spurious RF Radiated emissions level is no more than noise floor.

2. The worst emission was found in the antenna is Horizontal position.



## 6 Main Test Instruments

Name	Manufacturer	Type	Serial Number	Calibration Date	Expiration Date
Base Station Simulator	R&S	CMW500	113645	2017-05-14	2018-05-13
Power Splitter	Hua Xiang	SHX-GF2-2-13	10120101	2017-05-14	2018-05-13
Universal Radio Communication Tester	Agilent	E5515C	MY48367192	2017-05-14	2018-05-13
Spectrum Analyzer	Agilent	N9010A	MY47191109	2017-05-14	2018-05-13
Signal Analyzer	R&S	FSV30	100815	2016-12-16	2017-12-15
Signal generator	R&S	SMB 100A	102594	2017-05-14	2018-05-13
EMI Test Receiver	R&S	ESCI	100948	2017-05-20	2018-05-19
Trilog Antenna	SCHWARZBECK	VUBL 9163	9163-201	2014-12-06	2017-12-05
Horn Antenna	R&S	HF907	100126	2014-12-06	2017-12-05
Horn Antenna	ETS-Lindgren	3160-09	00102643	2015-01-30	2018-01-29
Climatic Chamber	Re Ce	PT-30B	20101891	2015-07-18	2018-07-17
RF Cable	Agilent	SMA 15cm	0001	2017-08-04	2018-02-03
Preamplifier	R&S	SCU18	102327	2017-06-18	2018-06-17

## ANNEX A: EUT Appearance and Test Setup

### A.1 EUT Appearance



Front Side

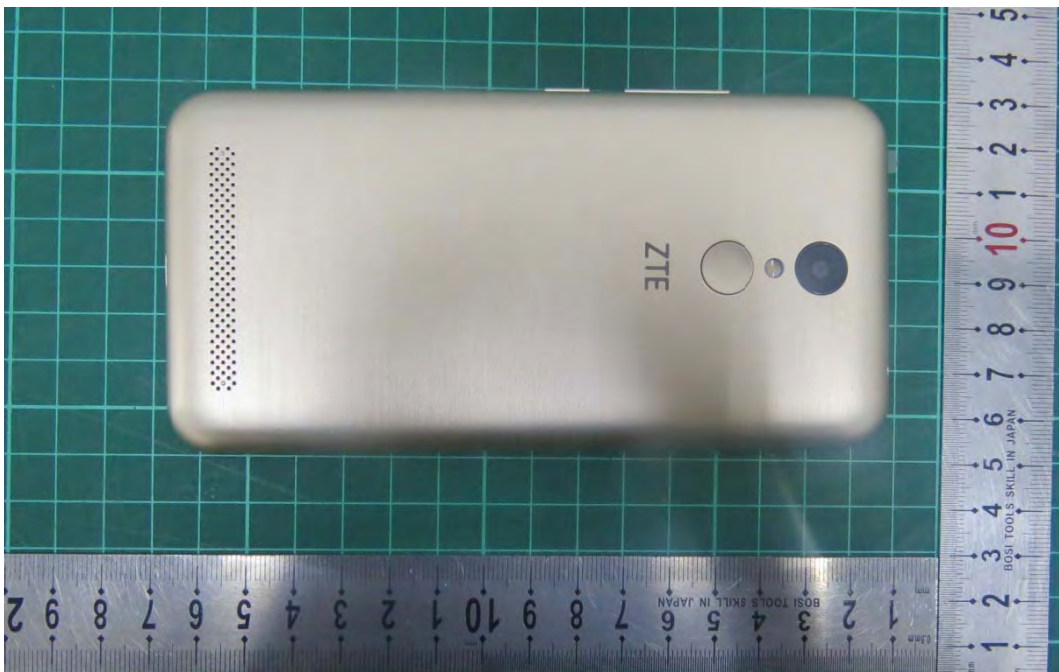

Back Side

a: EUT



b: Adapter



c : Earphone



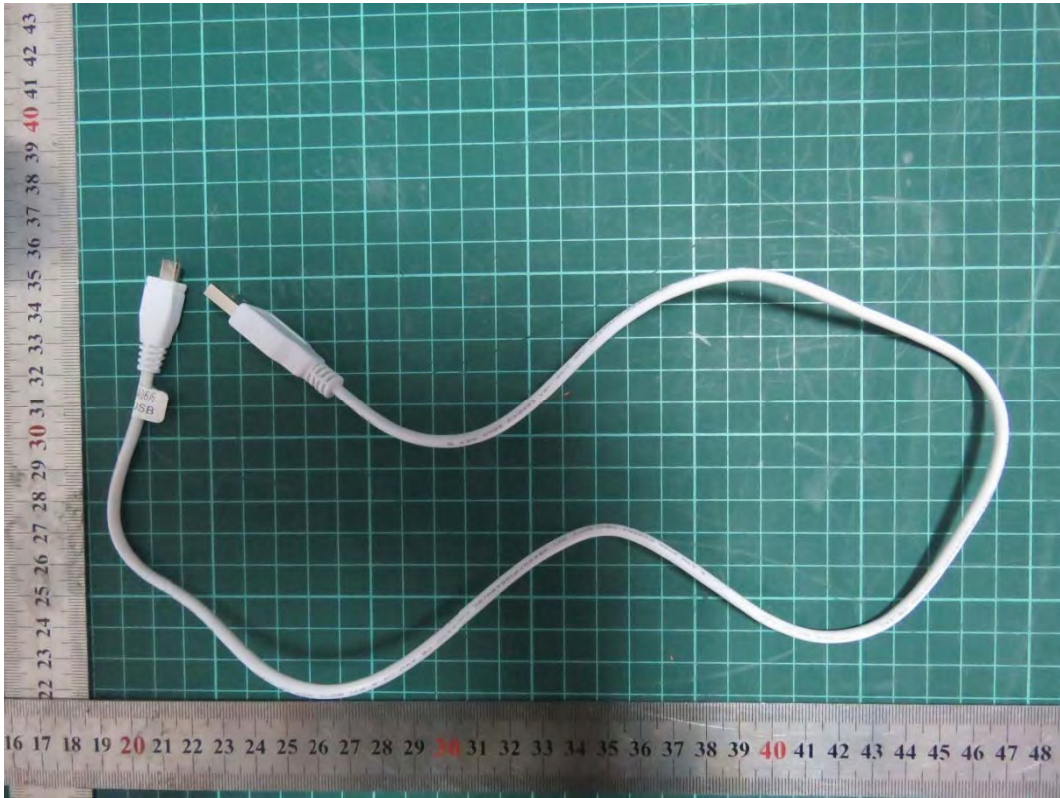

d : USB Cable

Picture 1 EUT and Accessory

## A.2 Test Setup

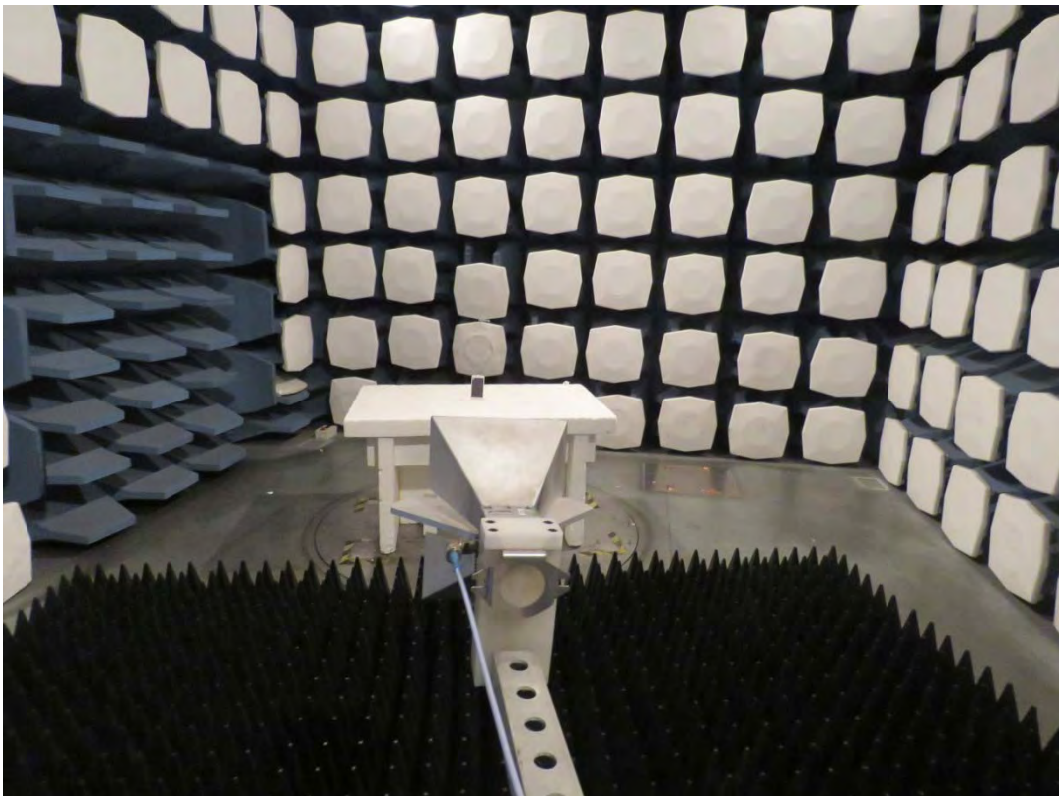
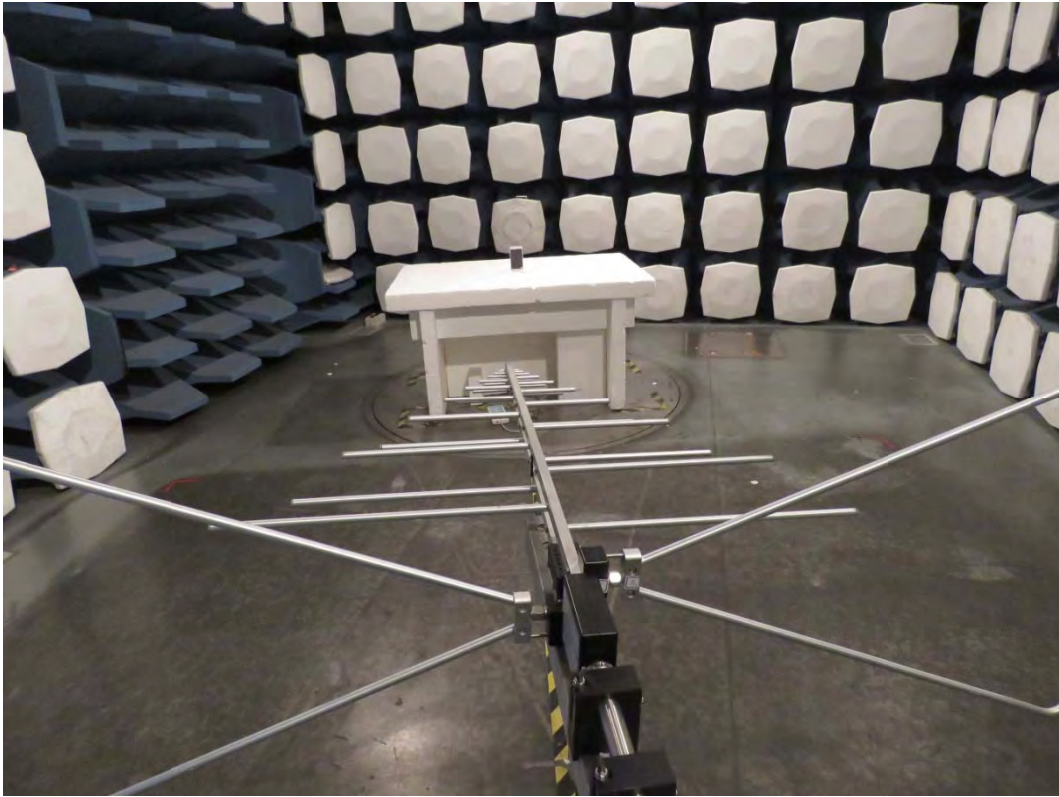

Picture 2: Radiated Spurious Emissions Test setup