



RF TEST REPORT

Applicant ZTE Corporation
FCC ID SRQ-DL2PLUS
Product LTE/WCDMA/GSM (GPRS)
Multi-Mode Digital Mobile Phone
Model ZTE BLADE A602/ZTE Blade A602/
BLADE A602/Blade A602/DL2 PLUS
Report No. RXA1707-0254RF02
Issue Date August 16, 2017

TA Technology (Shanghai) Co., Ltd. tested the above equipment in accordance with the requirements in **FCC CFR47 Part 2 (2017)/ FCC CFR 47 Part 24E (2017)**. The test results show that the equipment tested is capable of demonstrating compliance with the requirements as documented in this report.

Jiang peng Lan

Performed by: Jiangpeng Lan

Kai Xu

Approved by: Kai Xu

TA Technology (Shanghai) Co., Ltd.

No.145, Jintang Rd, Tangzhen Industry Park, Pudong Shanghai, China

TEL: +86-021-50791141/2/3

FAX: +86-021-50791141/2/3-8000



TABLE OF CONTENT

1. Test Laboratory	4
1.1. Notes of the test report.....	4
1.2. Test facility.....	4
1.3. Testing Location	5
2. General Description of Equipment under Test.....	6
3. Applied Standards.....	8
4. Test Configuration.....	9
5. Test Case Results.....	11
5.1. RF Power Output.....	11
5.2. Effective Isotropic Radiated Power	16
5.3. Occupied Bandwidth	21
5.4. Band Edge Compliance.....	32
5.5. Peak-to-Average Power Ratio (PAPR)	43
5.6. Frequency Stability	46
5.7. Spurious Emissions at Antenna Terminals	50
5.8. Radiates Spurious Emission	60
6. Main Test Instruments	74
ANNEX A: EUT Appearance and Test Setup.....	75
A.1 EUT Appearance	75
A.2 Test Setup.....	78

Summary of measurement results

No.	Test Case	Clause in FCC rules	Verdict
1	RF power output	2.1046	PASS
2	Effective Isotropic Radiated power	24.232(c)	PASS
3	Occupied Bandwidth	2.1049	PASS
4	Band Edge Compliance	2.1051 /24.238(a)	PASS
5	Peak-to-Average Power Ratio	24.232/KDB 971168 D01(5.7)	PASS
6	Frequency Stability	2.1055 / 24.235	PASS
7	Spurious Emissions at Antenna Terminals	2.1051 / 24.238(a)	PASS
8	Radiates Spurious Emission	2.1053 / 24.238(a)	PASS
Date of Testing: August 4, 2017~ August 13, 2017			
Note: PASS: The EUT complies with the essential requirements in the standard. FAIL: The EUT does not comply with the essential requirements in the standard.			



1. Test Laboratory

1.1. Notes of the test report

This report shall not be reproduced in full or partial, without the written approval of **TA technology (shanghai) co., Ltd.** The results documented in this report apply only to the tested sample, under the conditions and modes of operation as described herein. Measurement Uncertainties were not taken into account and are published for informational purposes only. This report is written to support regulatory compliance of the applicable standards stated above. This report must not be used by the client to claim product certification, approval, or endorsement by any government agencies.

1.2. Test facility

CNAS (accreditation number: L2264)

TA Technology (Shanghai) Co., Ltd. has obtained the accreditation of China National Accreditation Service for Conformity Assessment (CNAS).

FCC (recognition number is 428261)

TA Technology (Shanghai) Co., Ltd. has been listed on the US Federal Communications Commission list of test facilities recognized to perform electromagnetic emissions measurements.

IC (recognition number is 8510A)

TA Technology (Shanghai) Co., Ltd. has been listed by industry Canada to perform electromagnetic emission measurement.

VCCI (recognition number is C-4595, T-2154, R-4113, G-10766)

TA Technology (Shanghai) Co., Ltd. has been listed by industry Japan to perform electromagnetic emission measurement.

A2LA (Certificate Number: 3857.01)

TA Technology (Shanghai) Co., Ltd. has been listed by American Association for Laboratory Accreditation to perform electromagnetic emission measurement.



1.3. Testing Location

Company: TA Technology (Shanghai) Co., Ltd.
Address: No.145, Jintang Rd, Tangzhen Industry Park, Pudong
City: Shanghai
Post code: 201201
Country: P. R. China
Contact: Xu Kai
Telephone: +86-021-50791141/2/3
Fax: +86-021-50791141/2/3-8000
Website: <http://www.ta-shanghai.com>
E-mail: xukai@ta-shanghai.com



2. General Description of Equipment under Test

Client Information

Applicant	ZTE Corporation
Applicant address	ZTE Plaza, Keji Road South, Hi-Tech, Industrial Park, Nanshan District, Shenzhen, Guangdong, 518057, P.R.China
Manufacturer	ZTE Corporation
Manufacturer address	ZTE Plaza, Keji Road South, Hi-Tech, Industrial Park, Nanshan District, Shenzhen, Guangdong, 518057, P.R.China

**General information**

EUT Description			
Model	ZTE BLADE A602/ZTE Blade A602/BLADE A602/ Blade A602/DL2 PLUS		
IMEI	866112030001545		
Hardware Version	MB V1.0		
Software Version	DIG_JM_DL2PLUS_V1.0		
Power Supply	Battery/AC adapter		
Antenna Type	Internal Antenna		
Test Mode(s)	GSM1900; WCDMA Band II; LTE Band 2;		
Test Modulation	(GSM)GMSK,8PSK; (WCDMA)QPSK; (LTE)QPSK,16QAM		
GPRS Multislot Class	12		
EGPRS Multislot Class	12		
HSDPA UE Category	24		
HSUPA UE Category	7		
Maximum E.I.R.P	GSM 1900:	26.05dBm	
	WCDMA Band II:	18.57dBm	
	LTE Band 2:	17.48dBm	
Rated Power Supply Voltage	3.8V		
Extreme Voltage	Minimum: 3.4V Maximum: 4.35V		
Extreme Temperature	Lowest: -10°C Highest: +55°C		
Operating Frequency Range(s)	Band	Tx (MHz)	Rx (MHz)
	GSM1900	1850 ~ 1910	1930 ~ 1990
	WCDMA Band II	1850 ~ 1910	1930 ~ 1990
	LTE Band 2	1850 ~ 1910	1930 ~ 1990
EUT Accessory			
Adapter	Manufacturer: DOKOCOM Model: LPL-A008050150Z Input: 100-240V ac 50/60Hz 250mA MAX Output: 5V dc 1500mA		
Battery	Manufacturer: BAK Model: Li3830T43P6h856337		
Earphone	Manufacturer:FDC Model: DEM-93		
USB Extend Cable	70cm Cable, Shielded		
Note: The information of the EUT is declared by the manufacturer.			



3. Applied Standards

According to the specifications of the manufacturer, it must comply with the requirements of the following standards:

FCC CFR47 Part 2 (2017)

FCC CFR 47 Part 24E (2017)

ANSI C63.26 (2015)

KDB 971168 D01 Power Meas License Digital Systems v02r02

4. Test Configuration

Radiated measurements are performed by rotating the EUT in three different orthogonal test planes. EUT stand-up position (Z axis), lie-down position (X, Y axis). Receiver antenna polarization (horizontal and vertical), the worst emission was found in position (Z axis, vertical polarization) and the worst case was recorded.

All mode and data rates and positions and RB size and modulations were investigated.

Subsequently, only the worst case emissions are reported.

The following testing in GSM/WCDMA/LTE is set based on the maximum RF Output Power.

Test modes are chosen to be reported as the worst case configuration below:

	Test items	Modes/Modulation	
		GSM 1900	WCDMA Band II
Conducted Test cases	RF power output	GSM GPRS(1Tx slot) EGPRS(1Tx slot)	RMC HSDPA/HSUPA DC-HSDPA/HSPA+
	Occupied Bandwidth	GSM GPRS(1Tx slot) EGPRS(1Tx slot)	RMC
	Band Edge Compliance	GSM GPRS(1Tx slot) EGPRS(1Tx slot)	RMC
	Peak-to-Average Power Ratio	GSM GPRS(1Tx slot) EGPRS(1Tx slot)	RMC
	Frequency Stability	GSM GPRS(1Tx slot) EGPRS(1Tx slot)	RMC
	Spurious Emissions at Antenna Terminals	GSM	RMC
Radiated Test cases	Effective Isotropic Radiated power	GSM GPRS(1Tx slot) EGPRS(1Tx slot)	RMC
	Radiates Spurious Emission	GSM	RMC

Test modes are chosen to be reported as the worst case configuration below for LTE Band 2:

Test items	Bandwidth (MHz)						Modulation		RB			Test Channel		
	1.4	3	5	10	15	20	QPSK	16QAM	1	50%	100%	L	M	H
RF power output	O	O	O	O	O	O	O	O	O	O	O	O	O	O
Effective Isotropic Radiated power	O	O	O	O	O	O	O	O	-	-	O	O	O	O
Occupied Bandwidth	O	O	O	O	O	O	O	O	-	-	O	O	O	O
Band Edge Compliance	O	O	O	O	O	O	O	O	O	-	O	O	-	O
Peak-to-Average Power Ratio	O	O	O	O	O	O	O	O	-	-	O	O	O	O
Frequency Stability	O	O	O	O	O	O	O	O	-	-	O	-	O	-
Conducted Spurious Emissions	O	O	O	O	O	O	O	-	O	-	-	O	O	O
Radiates Spurious Emission	O	O	O	O	O	O	O	-	O	-	-	O	O	O
Note	1. The mark "O" means that this configuration is chosen for testing. 2. The mark "-" means that this configuration is not testing.													

5. Test Case Results

5.1.RF Power Output

Ambient condition

Temperature	Relative humidity	Pressure
23°C ~25°C	45%~50%	101.5kPa

Methods of Measurement

During the process of the testing, The EUT is controlled by the Base Station Simulator to ensure max power transmission and proper modulation.

Test Setup

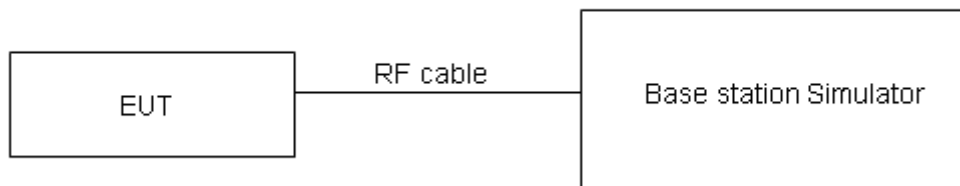

The loss between RF output port of the EUT and the input port of the tester has been taken into consideration.

Limits

No specific RF power output requirements in part 2.1046.

Measurement Uncertainty

The assessed measurement uncertainty to ensure 95% confidence level for the normal distribution is with the coverage factor $k = 2$, $U = 0.4$ dB.



Test Results

GSM 1900		Conducted Power(dBm)		
		Channel 512	Channel 661	Channel 810
		1850.2(MHz)	1880(MHz)	1909.8(MHz)
GSM	Results	29.73	29.65	29.42
GPRS (GMSK)	1TXslot	29.70	29.54	29.40
	2TXslots	28.75	28.65	28.63
	3TXslots	26.84	26.69	26.70
	4TXslots	25.78	25.65	25.66
EGPRS (GMSK)	1TXslot	29.69	29.51	29.38
	2TXslots	28.71	28.65	28.62
	3TXslots	26.82	26.67	26.68
	4TXslots	25.77	25.64	25.63
EGPRS (8PSK)	1TXslot	26.52	26.33	26.34
	2TXslots	25.67	25.58	25.46
	3TXslots	23.78	23.63	23.58
	4TXslots	22.65	22.59	22.56

WCDMA Band II		Conducted Power(dBm)		
		Channel 9262	Channel 9400	Channel 9538
		1852.4(MHz)	1880(MHz)	1907.6(MHz)
RMC		22.15	22.10	22.25
HSDPA	Sub - Test 1	21.98	21.93	22.08
	Sub - Test 2	22.06	22.01	22.16
	Sub - Test 3	21.55	21.50	21.65
	Sub - Test 4	21.54	21.49	21.64
HSUPA	Sub - Test 1	22.03	21.98	22.13
	Sub - Test 2	20.22	20.17	20.32
	Sub - Test 3	20.95	20.90	21.21
	Sub - Test 4	20.17	20.12	20.30
	Sub - Test 5	22.09	22.04	22.19
DC-HSDPA	Sub - Test 1	22.08	21.99	22.14
	Sub - Test 2	22.07	21.98	22.13
	Sub - Test 3	21.56	21.47	21.62
	Sub - Test 4	21.55	21.56	21.60
HSPA+	16QAM	21.81	21.75	21.90



LTE Band 2				Conducted Power(dBm)		
Bandwidth	Modulation	RB size	RB offset	Channel/Frequency (MHz)		
				18607/1850.7	18900/1880	19193/1909.3
1.4MHz	QPSK	1	0	21.98	21.96	21.88
		1	2	21.80	21.74	21.96
		1	5	21.85	21.79	21.90
		3	0	21.86	21.71	21.80
		3	2	21.78	21.71	21.85
		3	3	21.73	21.72	21.89
		6	0	20.86	20.80	20.95
	16QAM	1	0	20.96	21.04	21.09
		1	2	21.09	20.92	20.95
		1	5	20.95	20.94	21.11
		3	0	21.04	20.92	21.01
		3	2	21.04	20.90	21.07
		3	3	20.95	20.91	21.07
		6	0	20.00	20.00	20.11
Bandwidth	Modulation	RB size	RB offset	Channel/Frequency (MHz)		
				18615/1851.5	18900/1880	19185/1908.5
3MHz	QPSK	1	0	22.00	22.00	21.91
		1	7	21.83	21.79	22.00
		1	14	21.88	21.84	21.94
		8	0	20.96	20.83	20.93
		8	4	20.90	20.81	20.97
		8	7	20.83	20.83	20.99
		15	0	20.89	20.84	20.98
	16QAM	1	0	20.99	21.06	21.12
		1	7	21.12	20.97	20.99
		1	14	20.97	20.98	21.14
		8	0	20.15	20.05	20.13
		8	4	20.15	20.03	20.19
		8	7	20.05	20.03	20.20
		15	0	20.03	20.04	20.14
Bandwidth	Modulation	RB size	RB offset	Channel/Frequency (MHz)		
				18625/1852.5	18900/1880	19175/1907.5
5MHz	QPSK	1	0	21.97	21.98	21.87
		1	13	21.81	21.75	21.97
		1	24	21.85	21.79	21.90
		12	0	20.93	20.78	20.89



	16QAM	12	6	20.88	20.77	20.92
		12	13	20.81	20.81	20.95
		25	0	20.87	20.83	20.96
		1	0	20.96	21.02	21.09
		1	13	21.09	20.95	20.96
		1	24	20.94	20.96	21.10
		12	0	20.13	20.01	20.10
		12	6	20.12	19.98	20.15
		12	13	20.02	19.98	20.16
		25	0	20.01	20.00	20.09
Bandwidth	Modulation	RB size	RB offset	Channel/Frequency (MHz)		
				18650/1855	18900/1880	19150/1905
10MHz	QPSK	1	0	21.99	21.99	21.90
		1	25	21.84	21.80	22.01
		1	49	21.87	21.83	21.93
		25	0	20.96	20.83	20.93
		25	13	20.91	20.82	20.96
		25	25	20.83	20.85	21.00
		50	0	20.95	20.85	21.00
	16QAM	1	0	20.98	21.05	21.11
		1	25	21.12	20.99	20.99
		1	49	20.97	20.98	21.13
		25	0	20.16	20.06	20.14
		25	13	20.14	20.02	20.18
		25	25	20.05	20.03	20.20
		50	0	20.04	20.05	20.13
Bandwidth	Modulation	RB size	RB offset	Channel/Frequency (MHz)		
				18675/1857.5	18900/1880	19125/1902.5
15MHz	QPSK	1	0	21.98	21.95	21.88
		1	38	21.82	21.79	21.98
		1	74	21.84	21.78	21.89
		36	0	20.94	20.79	20.90
		36	18	20.88	20.77	20.92
		36	39	20.80	20.82	20.96
		75	0	20.93	20.81	20.95
	16QAM	1	0	20.93	21.03	21.09
		1	38	21.10	20.96	20.97
		1	74	20.94	20.94	21.10
		36	0	20.13	20.04	20.11
		36	18	20.11	19.97	20.14



		36	39	20.03	19.99	20.17
		75	0	20.01	20.00	20.09
Bandwidth	Modulation	RB size	RB offset	Channel/Frequency (MHz)		
				18700/1860	18900/1880	19100/1900
20MHz	QPSK	1	0	21.95	21.91	21.85
		1	50	21.81	21.75	21.96
		1	99	21.82	21.77	21.86
		50	0	20.91	20.74	20.86
		50	25	20.86	20.73	20.89
		50	50	20.77	20.77	20.92
		100	0	20.90	20.76	20.91
	16QAM	1	0	20.91	20.99	21.04
		1	50	21.06	20.94	20.93
		1	99	20.92	20.91	21.08
		50	0	20.10	20.00	20.08
		50	25	20.08	19.95	20.11
		50	50	20.00	19.94	20.13
		100	0	19.99	19.96	20.06

5.2. Effective Isotropic Radiated Power

Ambient condition

Temperature	Relative humidity	Pressure
23°C ~25°C	45%~50%	101.5kPa

Methods of Measurement

1. The testing follows ANSI C63.26 (2015) Section 5.5.2.3.
2. EUT was placed on a 0.8 meter high non-conductive stand at a 3 meter test distance from the receive antenna. A receiving antenna was placed on the antenna mast 3 meters from the EUT for emission measurements. The height of receiving antenna between 1.0m and 4.0m. Detected emissions were maximized at each frequency by rotating the EUT through 360° and adjusting the receiving antenna polarization. The radiated emission measurements of all transmit frequencies in three channels (High, Middle, Low) were measured with peak detector.
3. A log-periodic antenna or double-ridged waveguide horn antenna shall be substituted in place of the EUT. The log-periodic antenna will be driven by a signal generator and the level will be adjusted till the same power value on the spectrum analyzer or receiver. The level of the spurious emissions can be calculated through the level of the signal generator, cable loss, the gain of the substitution antenna and the reading of the spectrum analyzer or receiver.
4. The EUT is then put into continuously transmitting mode at its maximum power level during the test. Set Test Receiver or Spectrum RBW=1MHz, VBW=3MHz for above 1GHz and RBW=100kHz, VBW=300kHz for 30MHz to 1GHz., And the maximum value of the receiver should be recorded as (Pr).
5. The EUT shall be replaced by a substitution antenna. In the chamber, a substitution antenna for the frequency band of interest is placed at the reference point of the chamber. An RF Signal source for the frequency band of interest is connected to the substitution antenna with a cable that has been constructed to not interfere with the radiation pattern of the antenna. A power (PMea) is applied to the input of the substitution antenna, and adjust the level of the signal generator output until the value of the receiver reach the previously recorded (Pr). The power of signal source (PMea) is recorded. The test should be performed by rotating the test item and adjusting the receiving antenna polarization.
6. A amplifier should be connected to the Signal Source output port. And the cable should be connect between the Amplifier and the Substitution Antenna. The cable loss (Pcl) ,the Substitution Antenna Gain (Ga) and the Amplifier Gain (PAg) should be recorded after test.
7. The measurement results are obtained as described below:
Power(EIRP)=PMea- PAg - Pcl + Ga
The measurement results are amend as described below:
Power(EIRP)=PMea- Pcl + Ga
8. This value is EIRP since the measurement is calibrated using an antenna of known gain (2.15 dBi) and known input power. ERP can be calculated from EIRP by subtracting the gain of the dipole, ERP = EIRP-2.15dBi.

Test configuration

Below 1GHz:

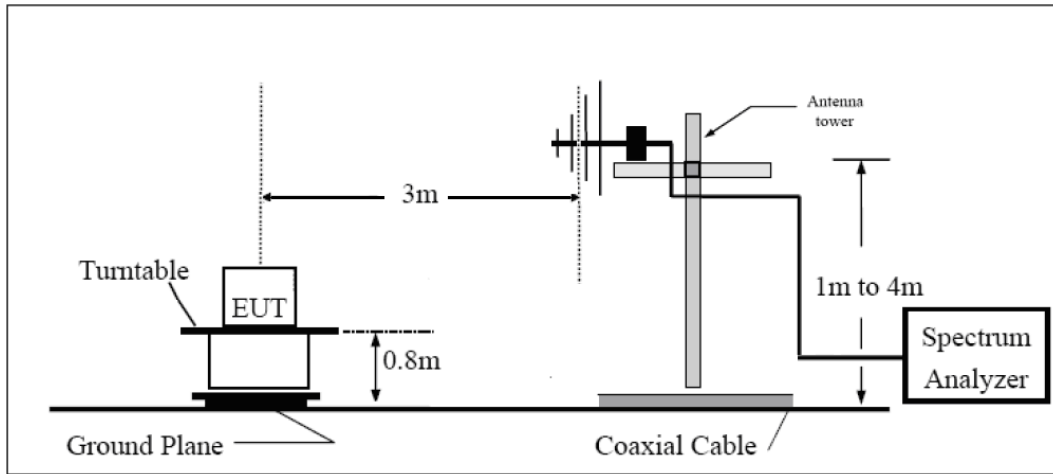

Above 1GHz:

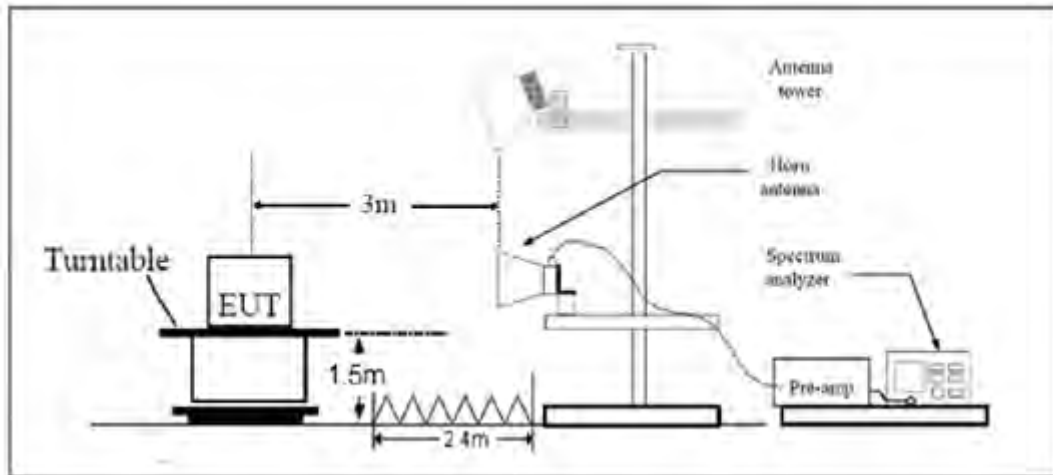

Limits

Rule Part 24.232(c) Mobile and portable stations are limited to 2 watts EIRP.

Rule Part 24.232(e) Peak transmit power must be measured over any interval of continuous transmission using instrumentation calibrated in terms of an rms-equivalent voltage.

Limit (EIRP)	$\leq 2\text{ W}$ (33 dBm)
--------------	----------------------------

Measurement Uncertainty

The assessed measurement uncertainty to ensure 95% confidence level for the normal distribution is with the coverage factor $k = 2$, $U = 1.19\text{ dB}$



Test Results:

Mode	Polarization	Frequency (MHz)	Rt (dBm)	Rs (dBm)	Ps (dBm)	Gs (dBi)	EIRP (dBm)	Limit (dBm)	Conclusion
GSM 1900	H	1850.2	-29.77	-53.21	0.00	1.92	25.36	33	Pass
	H	1880	-29.86	-53.42	0.00	1.94	25.50	33	Pass
	H	1909.8	-29.96	-53.67	0.00	1.90	25.61	33	Pass
	V	1850.2	-30.78	-53.70	0.00	1.92	24.84	33	Pass
	V	1880	-31.30	-53.91	0.00	1.94	24.55	33	Pass
	V	1909.8	-30.40	-54.55	0.00	1.90	26.05	33	Pass
GPRS 1900	H	1850.2	-30.42	-53.21	0.00	1.92	24.71	33	Pass
	H	1880	-30.60	-53.42	0.00	1.94	24.76	33	Pass
	H	1909.8	-30.83	-53.67	0.00	1.90	24.74	33	Pass
	V	1850.2	-30.46	-53.70	0.00	1.92	25.16	33	Pass
	V	1880	-31.69	-53.91	0.00	1.94	24.16	33	Pass
	V	1909.8	-30.48	-54.55	0.00	1.90	25.97	33	Pass
EGPRS 1900	H	1850.2	-30.94	-53.21	0.00	1.92	24.19	33	Pass
	H	1880	-31.12	-53.42	0.00	1.94	24.24	33	Pass
	H	1909.8	-31.35	-53.67	0.00	1.90	24.22	33	Pass
	V	1850.2	-30.98	-53.70	0.00	1.92	24.64	33	Pass
	V	1880	-32.21	-53.91	0.00	1.94	23.64	33	Pass
	V	1909.8	-31.01	-54.55	0.00	1.90	25.45	33	Pass
WCDMA Band II	H	1852.4	-38.25	-53.19	0.00	1.92	16.86	33	Pass
	H	1880	-37.96	-53.42	0.00	1.94	17.40	33	Pass
	H	1907.6	-38.01	-53.66	0.00	1.92	17.57	33	Pass
	V	1852.4	-37.77	-53.69	0.00	1.92	17.84	33	Pass
	V	1880	-38.18	-53.91	0.00	1.94	17.67	33	Pass
	V	1907.6	-37.89	-54.54	0.00	1.92	18.57	33	Pass



LTE Band 2									
bandwidth	Polarization	Frequency (MHz)	Rt (dBm)	Rs (dBm)	Ps (dBm)	Gs (dBi)	EIRP (dBm)	Limit (dBm)	Conclusion
1.4 MHz (QPSK)	H	1850.7	-56.75	-54.89	0.00	1.90	15.88	33	Pass
	H	1880	-58.54	-56.66	0.00	1.92	16.23	33	Pass
	H	1909.3	-59.96	-58.09	0.00	1.91	16.14	33	Pass
	V	1850.7	-56.91	-55.05	0.00	1.90	16.29	33	Pass
	V	1880	-58.29	-56.41	0.00	1.92	16.14	33	Pass
	V	1909.3	-59.72	-57.85	0.00	1.91	16.12	33	Pass
3 MHz (QPSK)	H	1851.5	-56.80	-54.93	0.00	1.91	15.25	33	Pass
	H	1880	-58.56	-56.66	0.00	1.94	16.55	33	Pass
	H	1908.5	-59.94	-58.08	0.00	1.91	16.95	33	Pass
	V	1851.5	-56.93	-55.04	0.00	1.91	13.96	33	Pass
	V	1880	-58.31	-56.41	0.00	1.94	16.50	33	Pass
	V	1908.5	-59.73	-57.86	0.00	1.91	16.15	33	Pass
5 MHz (QPSK)	H	1852.5	-56.88	-54.98	0.00	1.92	13.03	33	Pass
	H	1880	-58.58	-56.66	0.00	1.94	14.09	33	Pass
	H	1907.5	-59.93	-58.05	0.00	1.90	14.41	33	Pass
	V	1852.5	-57.04	-55.14	0.00	1.92	13.92	33	Pass
	V	1880	-58.32	-56.41	0.00	1.94	14.23	33	Pass
	V	1907.5	-59.83	-57.97	0.00	1.90	16.13	33	Pass
10 MHz (QPSK)	H	1855	-56.96	-55.09	0.00	1.91	15.28	33	Pass
	H	1880	-58.56	-56.66	0.00	1.94	16.18	33	Pass
	H	1905	-59.89	-58.01	0.00	1.92	16.87	33	Pass
	V	1855	-56.94	-55.08	0.00	1.91	16.83	33	Pass
	V	1880	-58.30	-56.41	0.00	1.94	16.99	33	Pass
	V	1905	-59.67	-57.81	0.00	1.92	17.48	33	Pass
15 MHz (QPSK)	H	1857.5	-57.14	-55.23	0.00	1.93	13.54	33	Pass
	H	1880	-58.57	-56.66	0.00	1.94	15.01	33	Pass
	H	1902.5	-59.83	-57.95	0.00	1.92	15.80	33	Pass
	V	1857.5	-57.14	-55.24	0.00	1.93	15.14	33	Pass
	V	1880	-58.32	-56.41	0.00	1.94	15.20	33	Pass
	V	1902.5	-59.57	-57.69	0.00	1.92	15.90	33	Pass
20 MHz (QPSK)	H	1860	-57.26	-55.35	0.00	1.93	12.68	33	Pass
	H	1880	-58.58	-56.66	0.00	1.94	13.97	33	Pass
	H	1900	-59.76	-57.86	0.00	1.92	14.13	33	Pass
	V	1860	-57.22	-55.31	0.00	1.93	13.68	33	Pass
	V	1880	-58.32	-56.41	0.00	1.94	14.32	33	Pass
	V	1900	-59.55	-57.66	0.00	1.92	14.50	33	Pass
1.4 MHz (16QAM)	H	1850.7	-56.75	-54.89	0.00	1.90	15.65	33	Pass
	H	1880	-58.54	-56.66	0.00	1.92	16.00	33	Pass
	H	1909.3	-59.96	-58.09	0.00	1.91	15.91	33	Pass



LTE Band 2									
bandwidth	Polarization	Frequency (MHz)	Rt (dBm)	Rs (dBm)	Ps (dBm)	Gs (dBi)	EIRP (dBm)	Limit (dBm)	Conclusion
	V	1850.7	-56.91	-55.05	0.00	1.90	16.06	33	Pass
	V	1880	-58.29	-56.41	0.00	1.92	15.91	33	Pass
	V	1909.3	-59.72	-57.85	0.00	1.91	15.89	33	Pass
3 MHz (16QAM)	H	1851.5	-56.80	-54.93	0.00	1.91	15.04	33	Pass
	H	1880	-58.56	-56.66	0.00	1.94	16.34	33	Pass
	H	1908.5	-59.94	-58.08	0.00	1.91	16.74	33	Pass
	V	1851.5	-56.93	-55.04	0.00	1.91	13.75	33	Pass
	V	1880	-58.31	-56.41	0.00	1.94	16.29	33	Pass
	V	1908.5	-59.73	-57.86	0.00	1.91	15.94	33	Pass
5 MHz (16QAM)	H	1852.5	-56.88	-54.98	0.00	1.92	12.82	33	Pass
	H	1880	-58.58	-56.66	0.00	1.94	13.88	33	Pass
	H	1907.5	-59.93	-58.05	0.00	1.90	14.20	33	Pass
	V	1852.5	-57.04	-55.14	0.00	1.92	13.71	33	Pass
	V	1880	-58.32	-56.41	0.00	1.94	14.02	33	Pass
	V	1907.5	-59.83	-57.97	0.00	1.90	15.92	33	Pass
10 MHz (16QAM)	H	1855	-56.96	-55.09	0.00	1.91	15.16	33	Pass
	H	1880	-58.56	-56.66	0.00	1.94	16.06	33	Pass
	H	1905	-59.89	-58.01	0.00	1.92	16.75	33	Pass
	V	1855	-56.94	-55.08	0.00	1.91	16.71	33	Pass
	V	1880	-58.30	-56.41	0.00	1.94	16.87	33	Pass
	V	1905	-59.68	-57.81	0.00	1.92	17.36	33	Pass
15 MHz (16QAM)	H	1857.5	-57.14	-55.23	0.00	1.93	13.33	33	Pass
	H	1880	-58.57	-56.66	0.00	1.94	14.80	33	Pass
	H	1902.5	-59.84	-57.95	0.00	1.92	15.59	33	Pass
	V	1857.5	-57.14	-55.24	0.00	1.93	14.93	33	Pass
	V	1880	-58.32	-56.41	0.00	1.94	14.99	33	Pass
	V	1902.5	-59.57	-57.69	0.00	1.92	15.69	33	Pass
20 MHz (16QAM)	H	1860	-57.26	-55.35	0.00	1.93	12.62	33	Pass
	H	1880	-58.58	-56.66	0.00	1.94	13.91	33	Pass
	H	1900	-59.76	-57.86	0.00	1.92	14.07	33	Pass
	V	1860	-57.22	-55.31	0.00	1.93	13.62	33	Pass
	V	1880	-58.32	-56.41	0.00	1.94	14.26	33	Pass
	V	1900	-59.55	-57.66	0.00	1.92	14.44	33	Pass

5.3.Occupied Bandwidth

Ambient condition

Temperature	Relative humidity	Pressure
23°C ~25°C	45%~50%	101.5kPa

Method of Measurement

The EUT was connected to Spectrum Analyzer and Base Station Simulator via power Splitter. The occupied bandwidth is measured using spectrum analyzer.

RBW is set to 3kHz, VBW is set to 10kHz for GSM 1900,

RBW is set to 51kHz, VBW is set to 160kHz for WCDMA Band II,

RBW is set to 51kHz, VBW is set to 160kHz for LTE Band 2 (1.4MHz),

RBW is set to 100kHz,VBW is set to 300kHz for LTE Band 2 (3MHz/5MHz),

RBW is set to 300kHz,VBW is set to 1MHz for LTE Band 2 (10MHz/15MHz/20MHz).

99% power and -26dBc occupied bandwidths are recorded. Spectrum analyzer plots are included on the following pages.

Test Setup

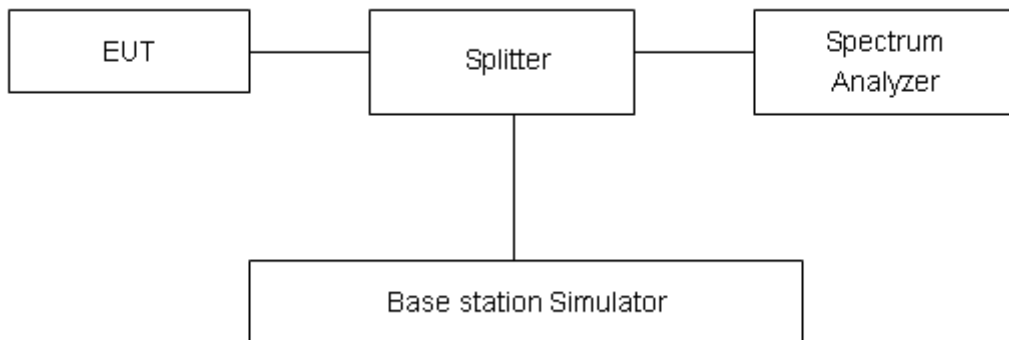

Limits

No specific occupied bandwidth requirements in part 2.1049.

Measurement Uncertainty

The assessed measurement uncertainty to ensure 95% confidence level for the normal distribution is with the coverage factor $k = 2$, $U = 624\text{Hz}$.



Test Result

Mode	Channel	Frequency (MHz)	99% Power Bandwidth (MHz)	-26dBc Bandwidth(MHz)
GSM 1900 (GSM)	512	1850.2	0.24432	0.313
	661	1880.0	0.24602	0.307
	810	1909.8	0.24811	0.3094
GPRS 1900 (GMSK)	512	1850.2	0.24527	0.3134
	661	1880.0	0.24595	0.321
	810	1909.8	0.24424	0.3158
EGPRS 1900 (8-PSK)	512	1850.2	0.24746	0.3115
	661	1880.0	0.24444	0.3117
	810	1909.8	0.24571	0.3086
WCDMA Band II (RMC)	9662	1932.4	4.2114	4.852
	9800	1960.0	4.2068	4.857
	9938	1987.6	4.2104	4.862

LTE Band 2					
Modulation	Bandwidth (MHz)	Channel	Frequency (MHz)	99% Power Bandwidth(MHz)	-26dBc Bandwidth(MHz)
QPSK	1.4	18607	1850.7	1.1273	1.324
		18900	1880	1.1216	1.309
		19193	1909.3	1.1338	1.310
	3	18615	1851.5	2.7376	3.035
		18900	1880	2.7374	3.045
		19185	1908.5	2.7369	3.043
	5	18625	1852.5	4.5278	5.100
		18900	1880	4.5448	5.202
		19175	1907.5	4.5199	5.045
	10	18650	1855	9.0350	10.09
		18900	1880	9.0693	10.17
		19150	1905	9.052	10.19
	15	18675	1857.5	13.488	14.89



		18900	1880	13.514	15.02
		19125	1902.5	13.475	14.96
	20	18700	1860	17.938	19.46
	20	18900	1880	17.944	19.33
	20	19100	1900	17.916	19.26
16QAM	1.4	18607	1850.7	1.1167	1.298
		18900	1880	1.1257	1.315
		19193	1909.3	1.1182	1.313
	3	18615	1851.5	2.7309	3.046
		18900	1880	2.7464	3.059
		19185	1908.5	2.7305	3.045
	5	18625	1852.5	4.5433	5.019
		18900	1880	4.5237	5.068
		19175	1907.5	4.5319	5.084
	10	18650	1855	9.0477	10.11
		18900	1880	9.0704	10.04
		19150	1905	9.0402	10.12
	15	18675	1857.5	13.525	14.95
		18900	1880	13.511	14.79
		19125	1902.5	13.502	14.92
	20	18700	1860	17.962	19.58
		18900	1880	17.985	19.40
		19100	1900	17.959	19.40

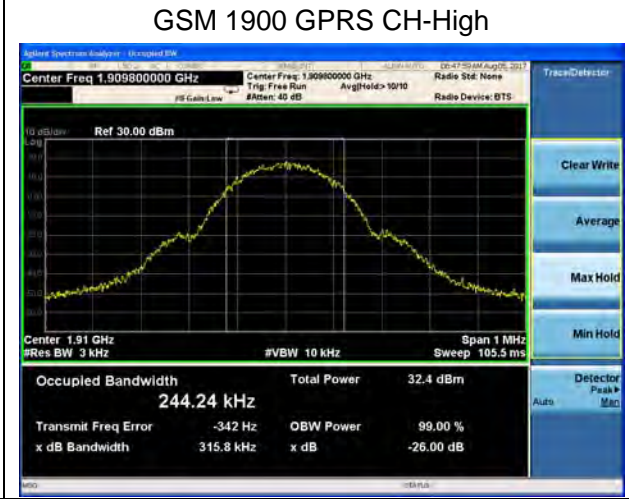
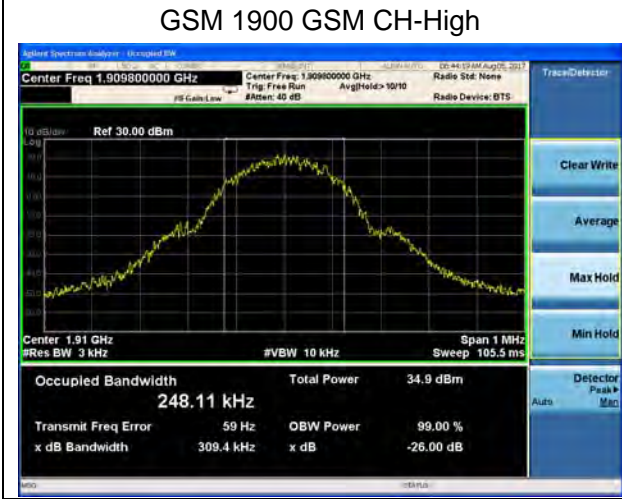
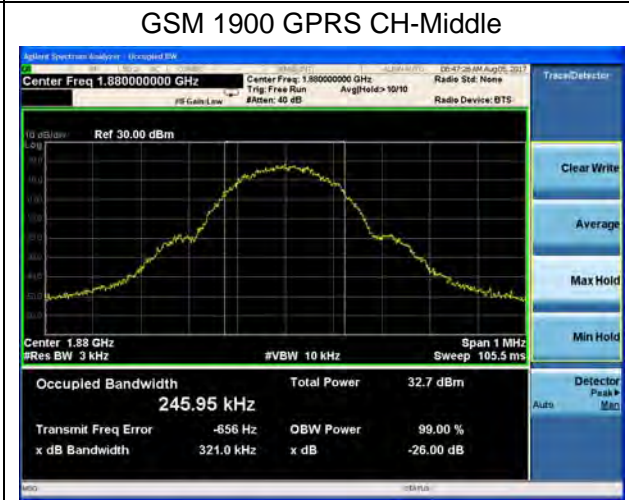
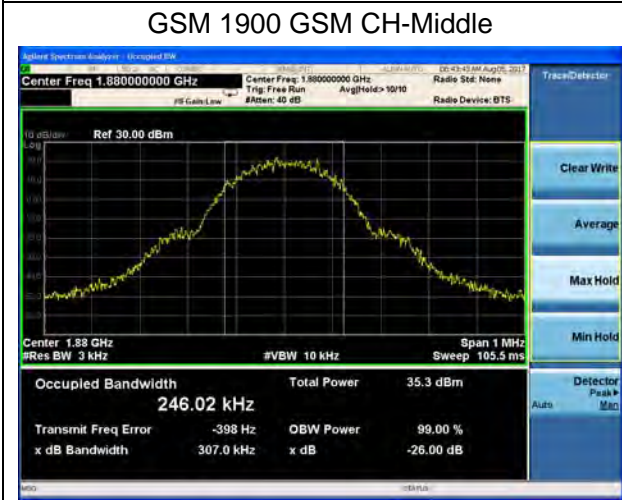
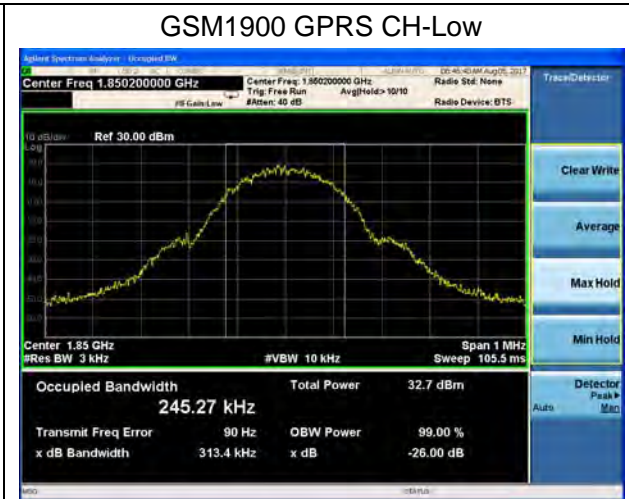
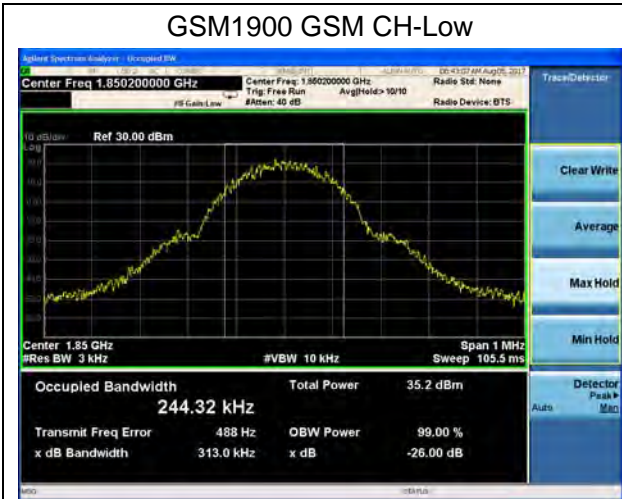

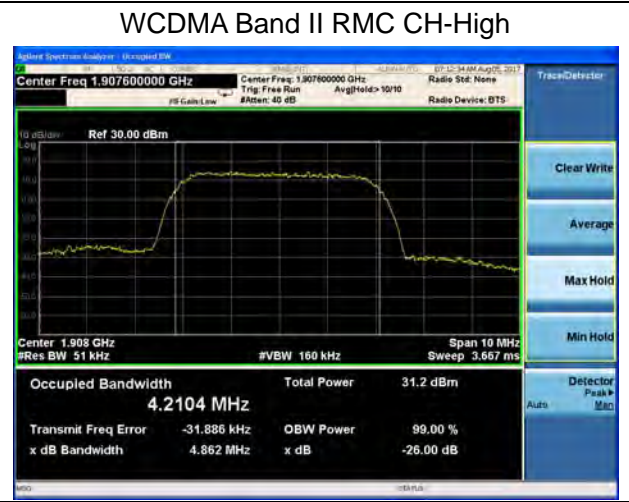
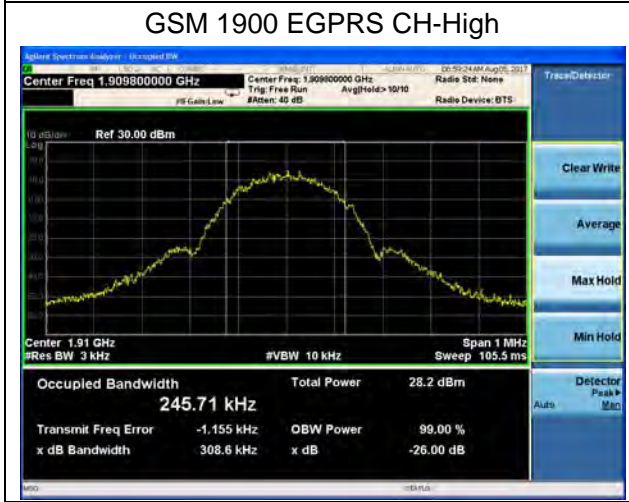
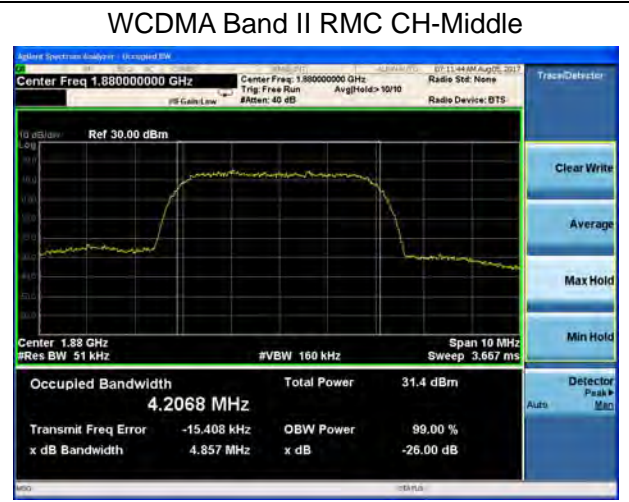
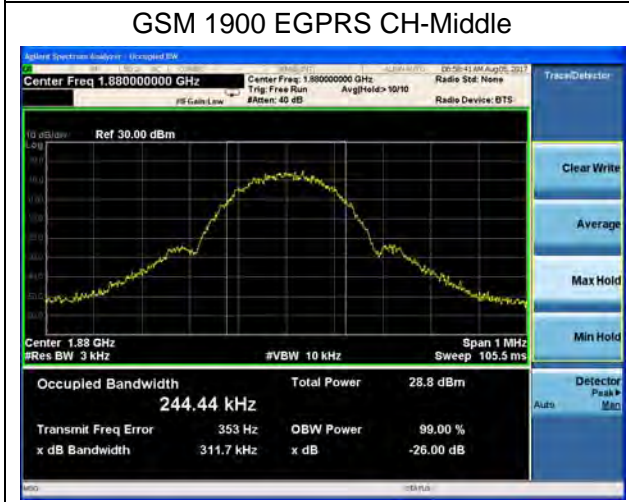
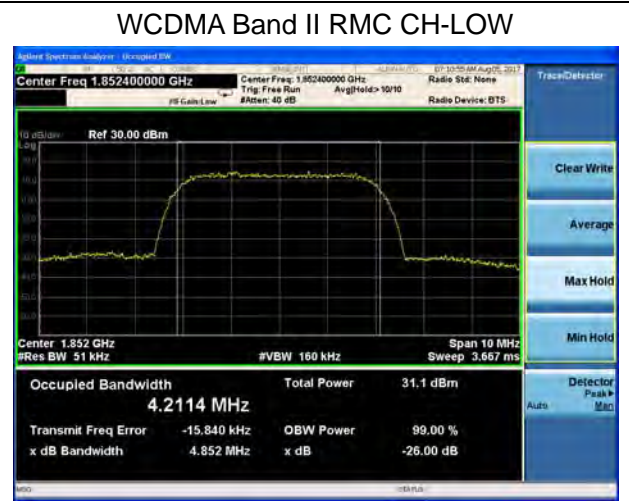
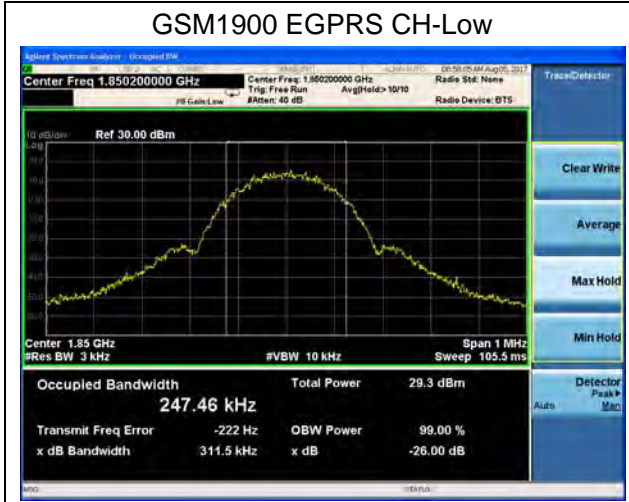

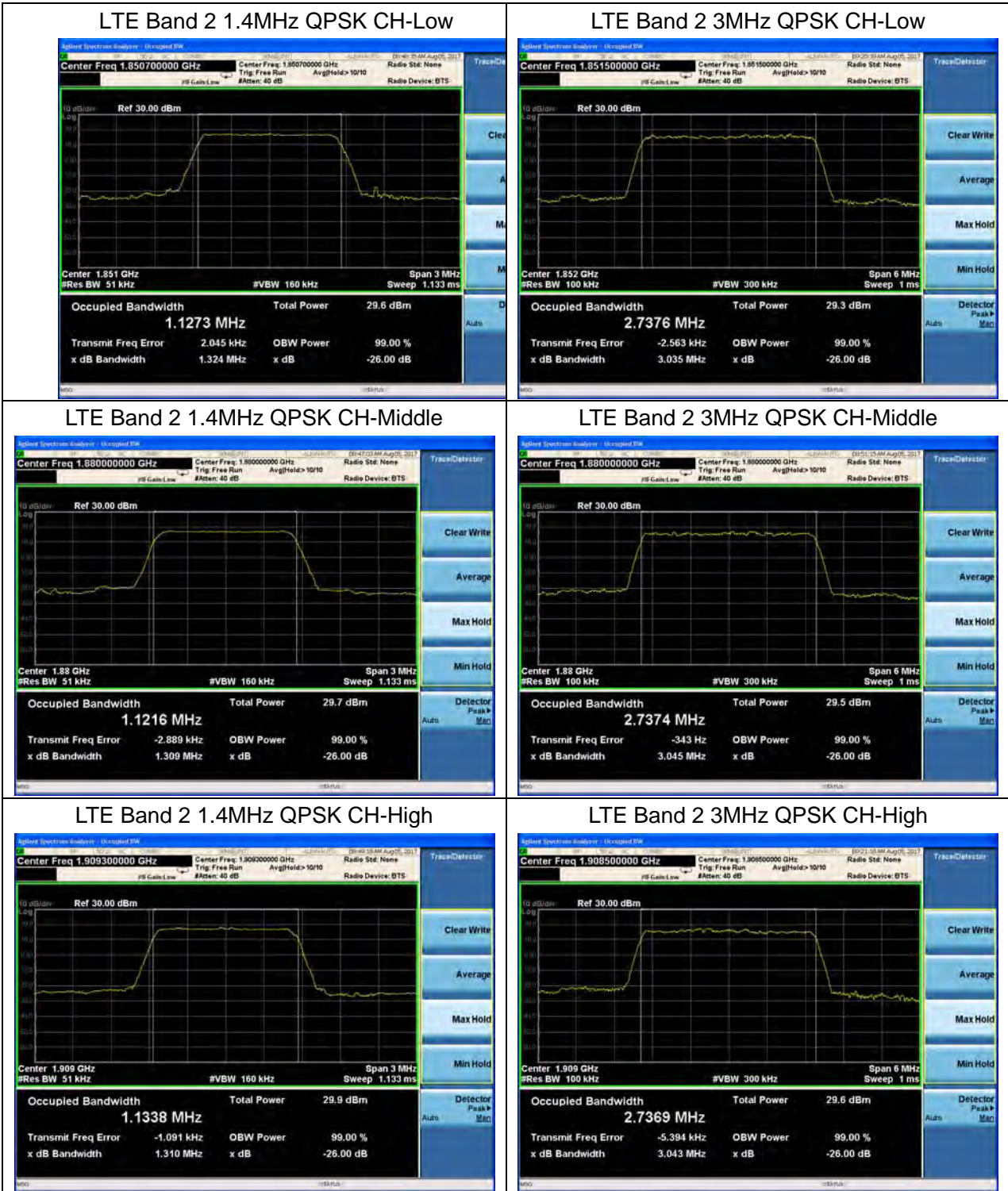

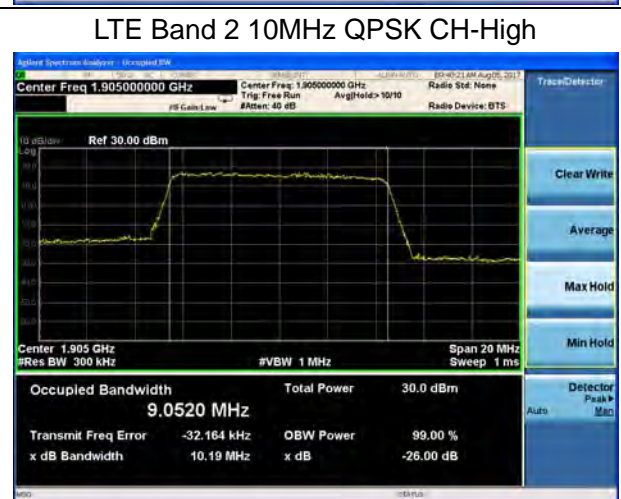
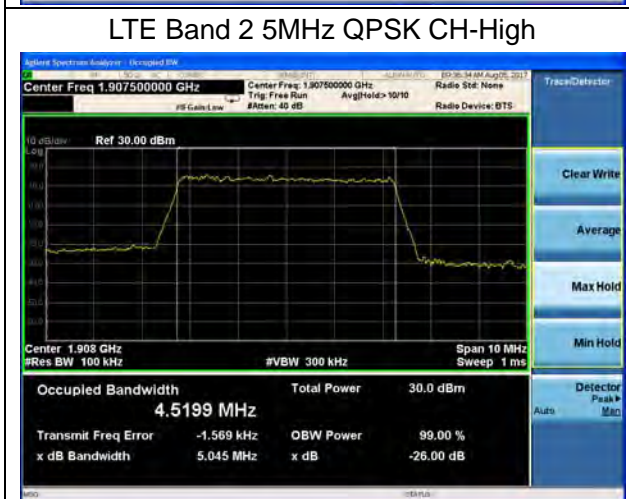
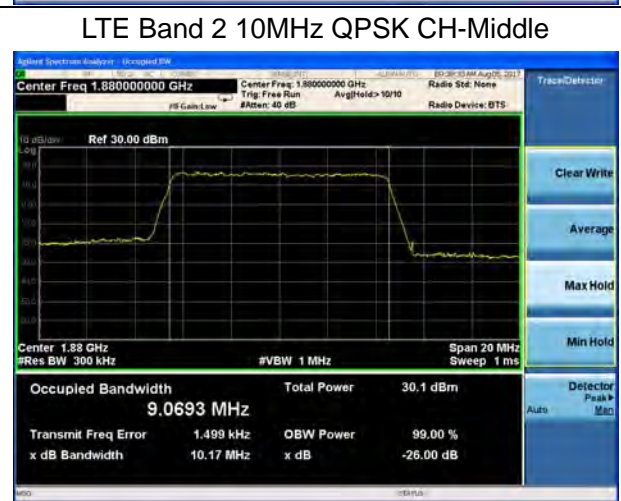
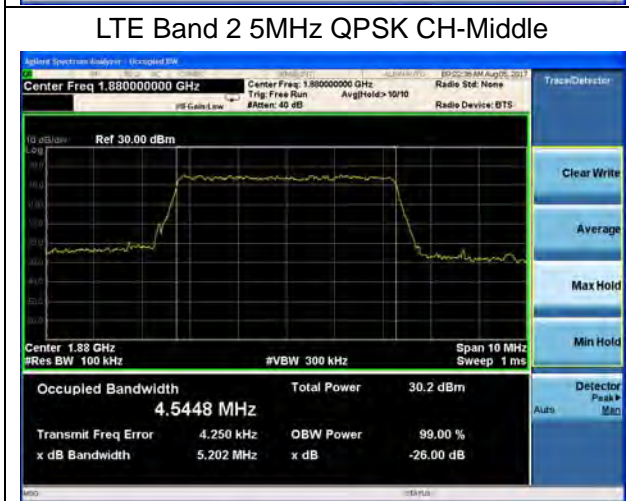
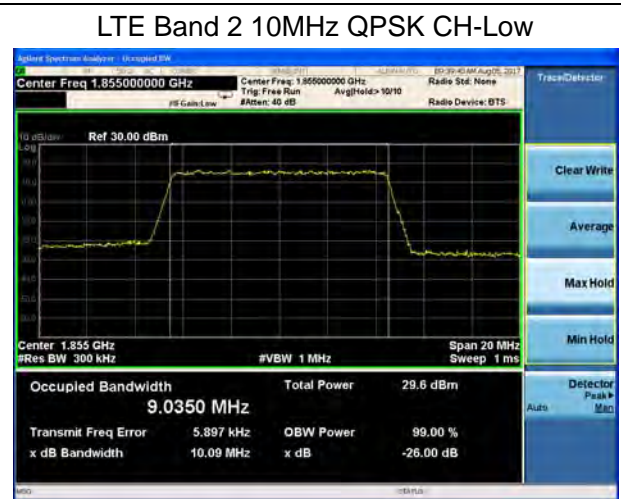
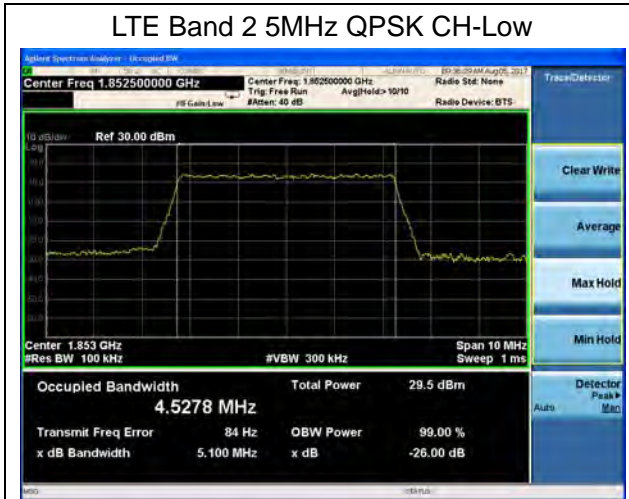

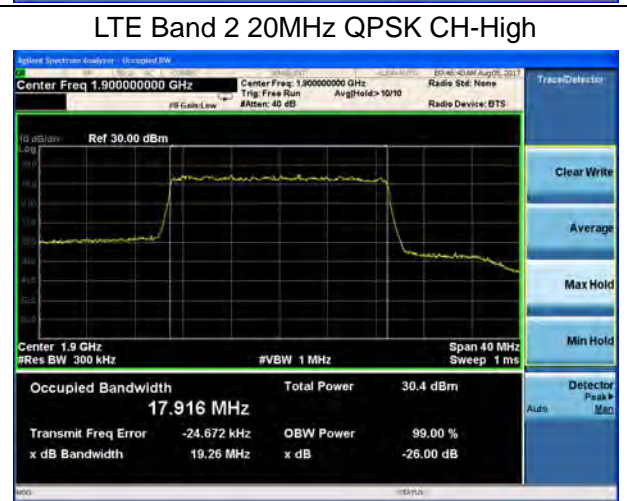
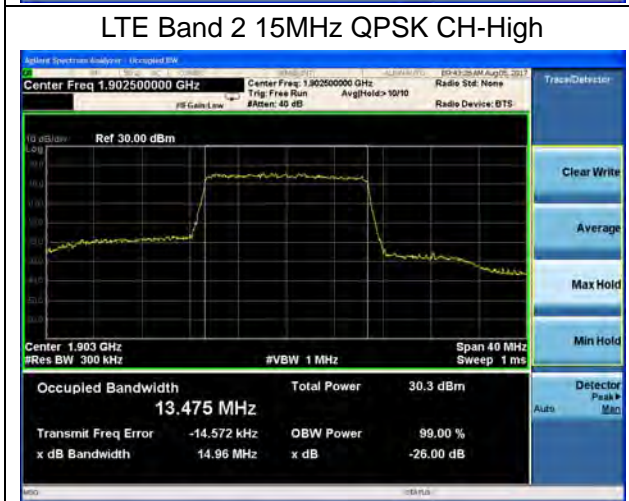
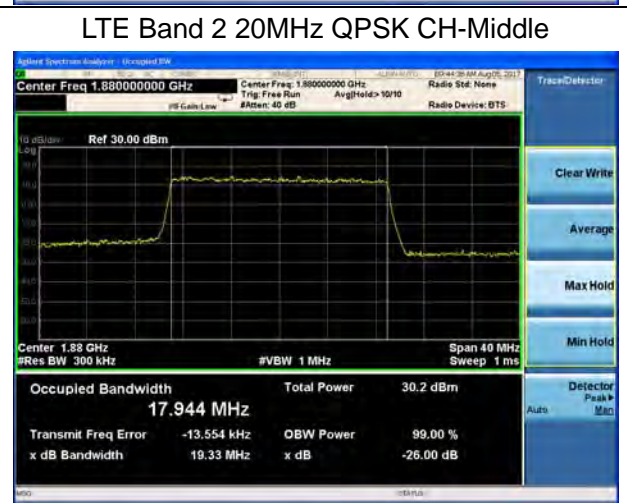
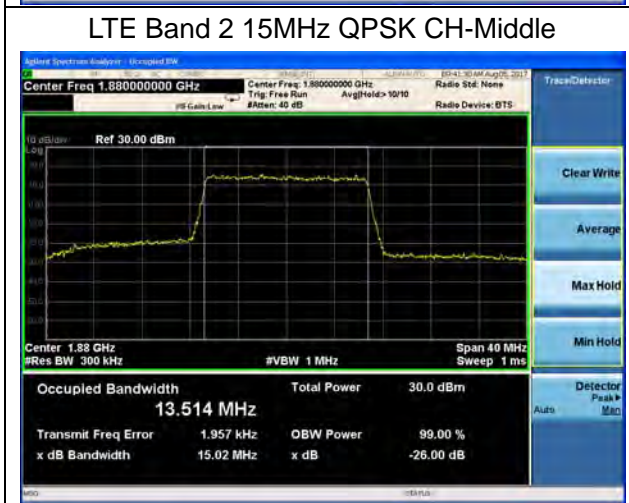
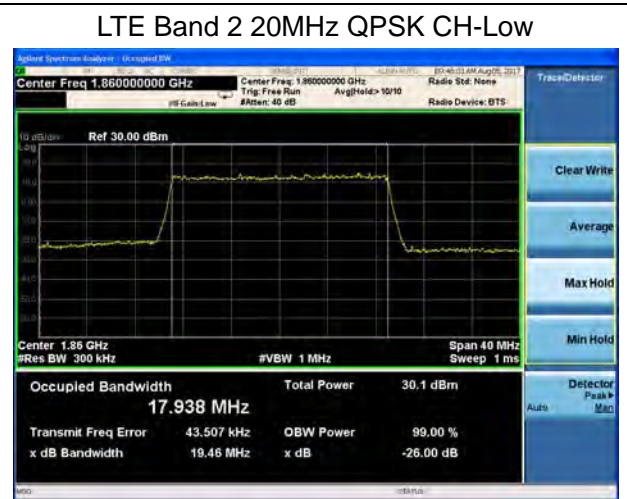
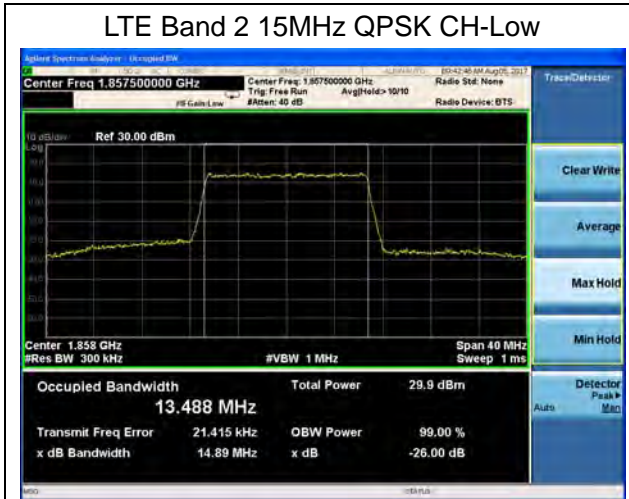

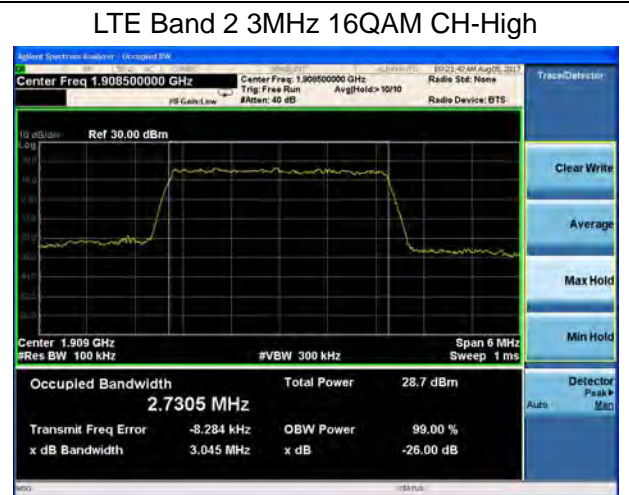
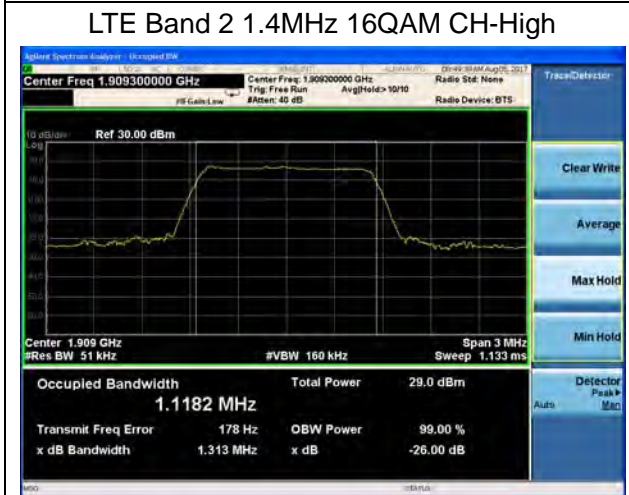
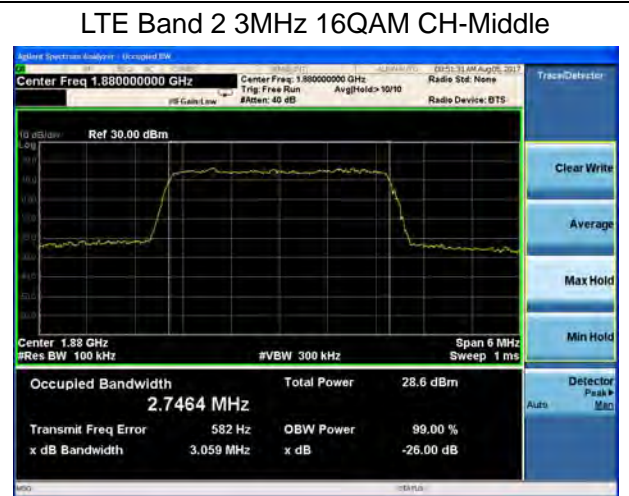
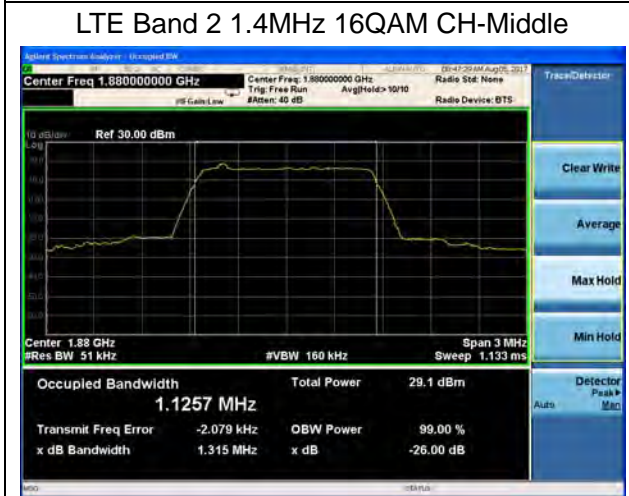
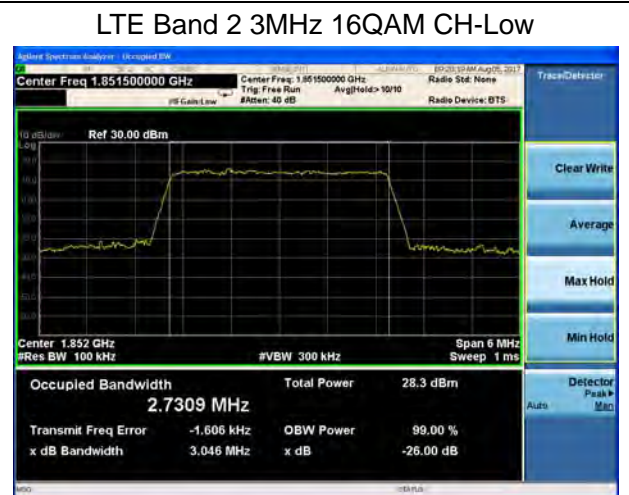
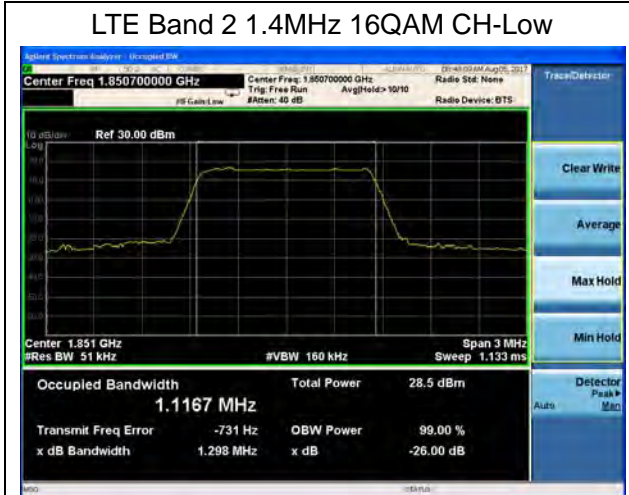

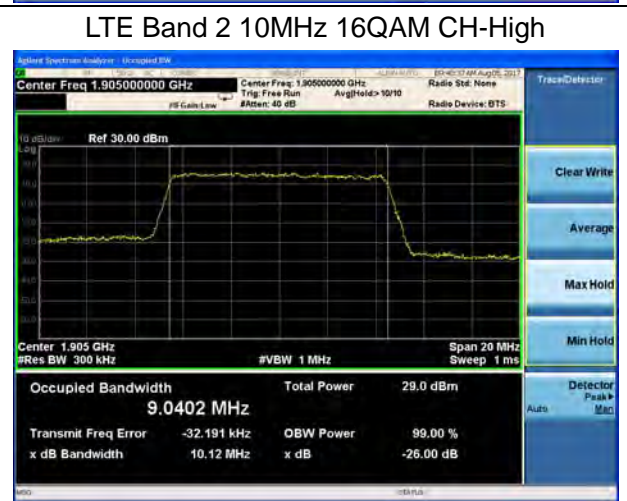
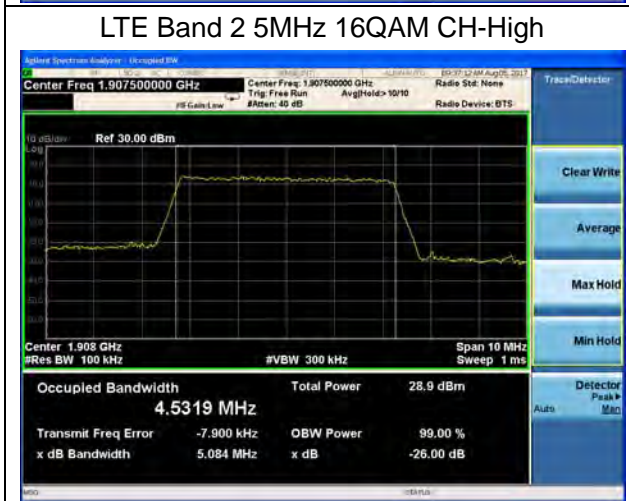
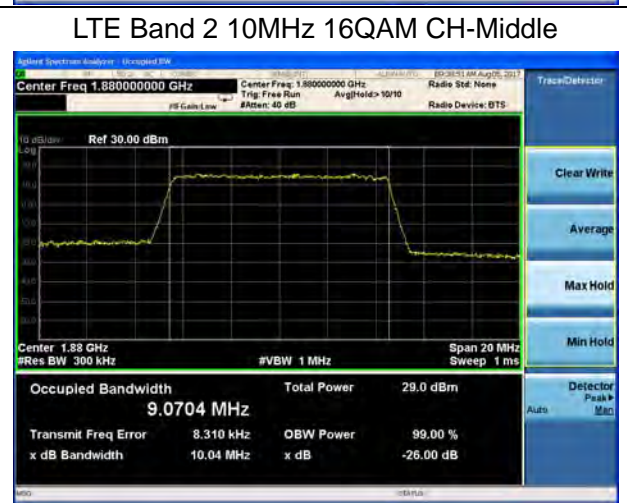
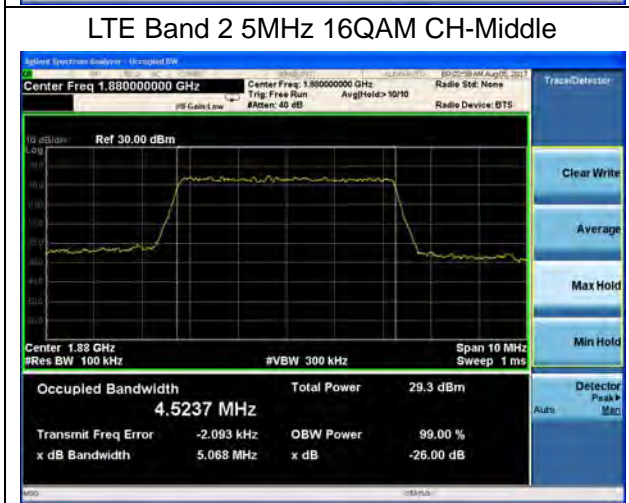
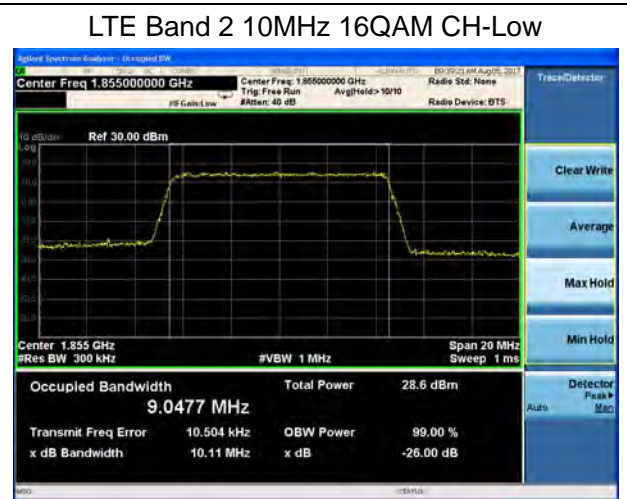
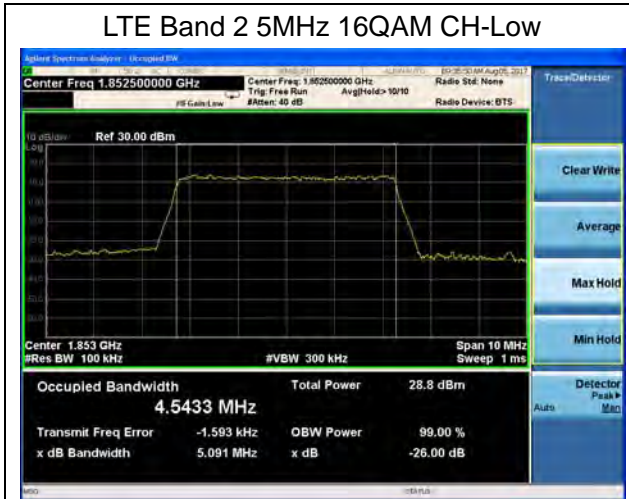

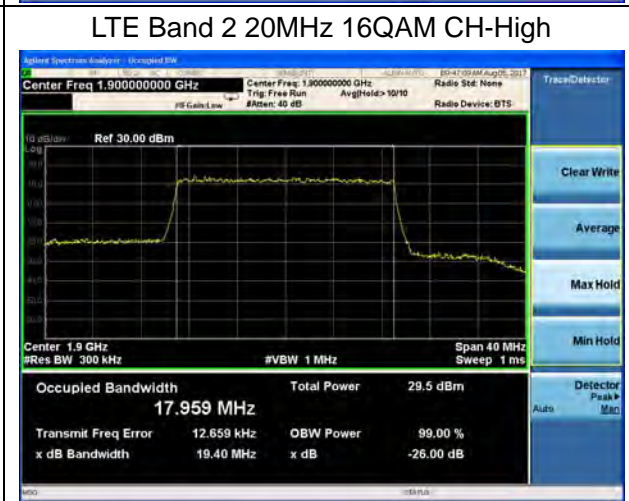
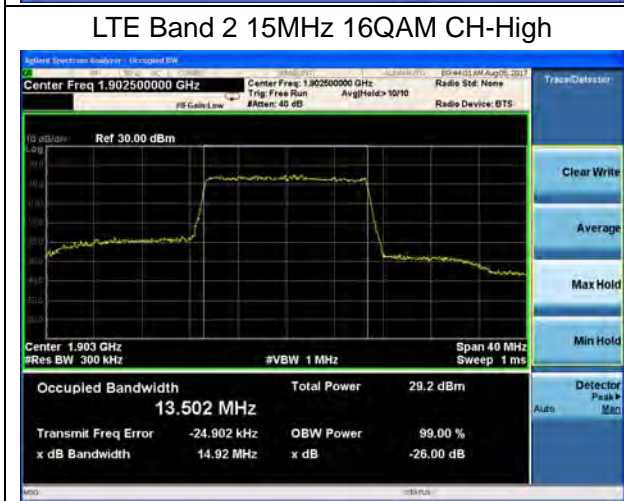
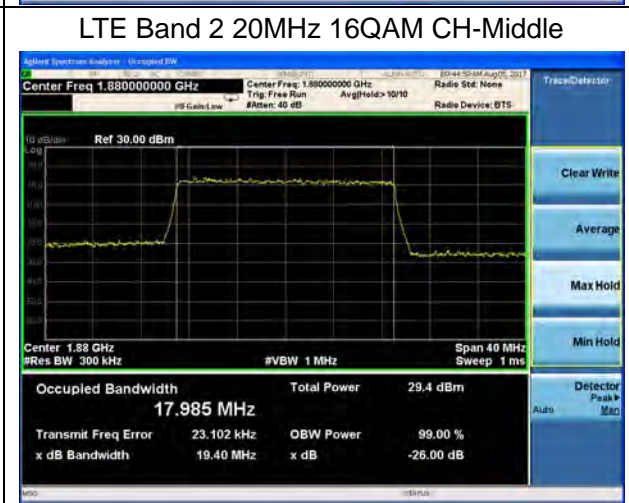
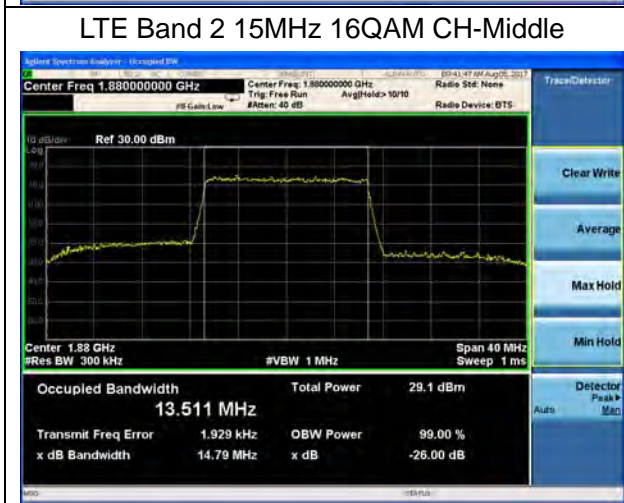
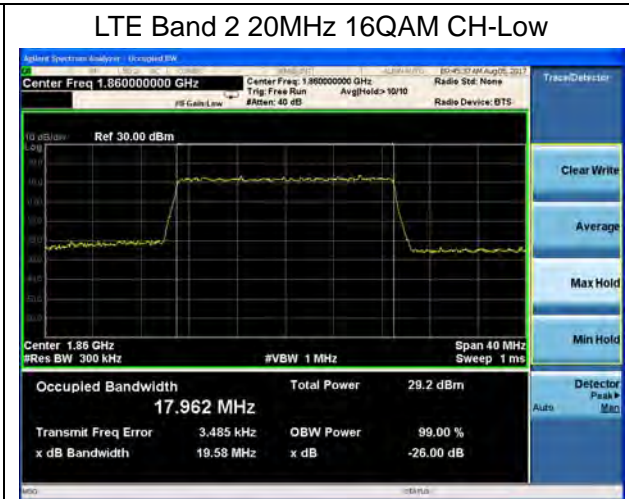
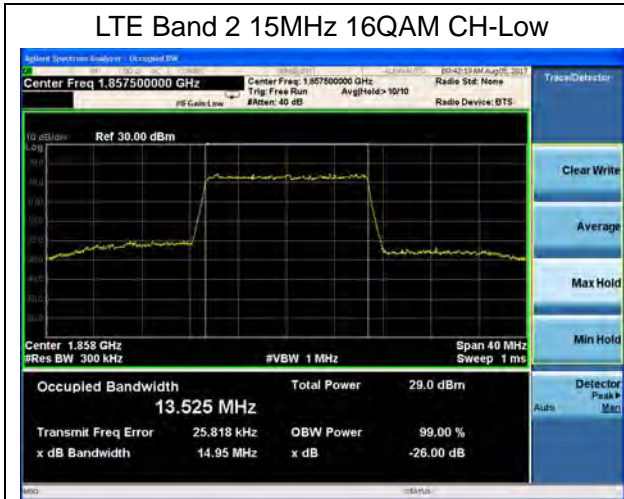

5.4. Band Edge Compliance

Ambient condition

Temperature	Relative humidity	Pressure
23°C ~25°C	45%~50%	101.5kPa

Method of Measurement

The EUT was connected to Spectrum Analyzer and Base Station Simulator via power Splitter. The band edge of the lowest and highest channels were measured. The Average detector is used and RBW is set to 3kHz, VBW is set to 10kHz for GSM 1900, RBW is set to 51kHz, VBW is set to 160kHz for WCDMA Band II, RBW is set to 15kHz, VBW is set to 51kHz for LTE Band 2 (1.4MHz), RBW is set to 30kHz, VBW is set to 100kHz for LTE Band 2 (3MHz), RBW is set to 51kHz, VBW is set to 160kHz for LTE Band 2 (5MHz), RBW is set to 100kHz, VBW is set to 300kHz for LTE Band 2 (10MHz), RBW is set to 150kHz, VBW is set to 510kHz for LTE Band 2 (15MHz), RBW is set to 200kHz, VBW is set to 620kHz for LTE Band 2 (20MHz). Spectrum analyzer plots are included on the following pages.

Test Setup

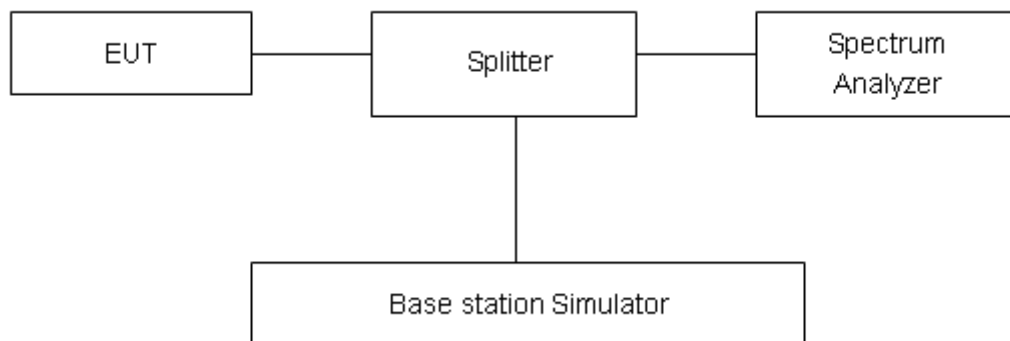

Limits

Rule Part 24.238(a) specifies that “on any frequency outside a licensee's frequency block, the power of any emission shall be attenuated below the transmitter power (P) by at least 43 + 10 log₁₀ (P) dB.”

Limit	-13 dBm
-------	---------

Measurement Uncertainty

The assessed measurement uncertainty to ensure 95% confidence level for the normal distribution is with the coverage factor $k = 1.96$, $U=0.684$ dB.



Test Result:

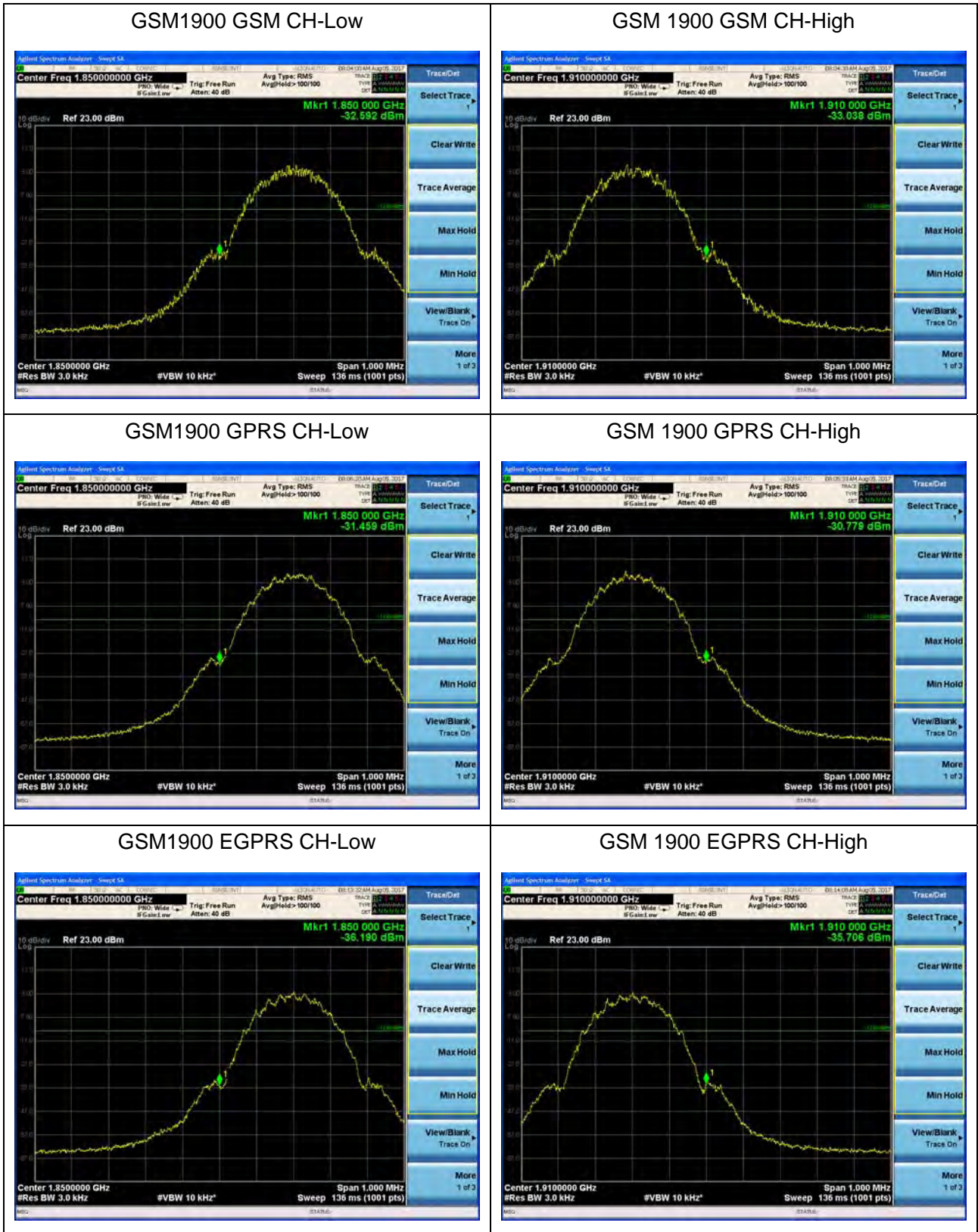

WCDMA Band II RMC CH-Low



WCDMA Band II RMC CH-High



LTE Band 2 1.4MHz QPSK 1RB CH-Low



LTE Band 2 1.4MHz QPSK 1RB CH-High

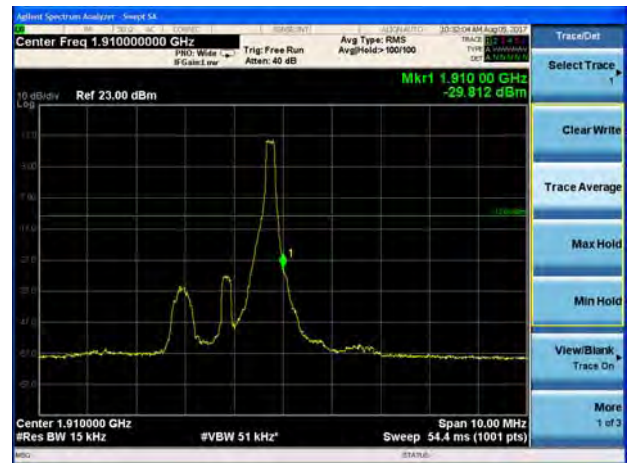

LTE Band 2 1.4MHz QPSK 100%RB CH-Low



LTE Band 2 1.4MHz QPSK 100%RB CH-High





LTE Band 2 3MHz QPSK 1RB CH-Low



LTE Band 2 3MHz QPSK 1RB CH-High



LTE Band 2 3MHz QPSK 100%RB CH-Low



LTE Band 2 3MHz QPSK 100%RB CH-High



LTE Band 2 5MHz QPSK 1RB CH-Low



LTE Band 2 5MHz QPSK 1RB CH-High





LTE Band 2 5MHz QPSK 100%RB CH-Low



LTE Band 2 5MHz QPSK 100%RB CH-High



LTE Band 2 10MHz QPSK 1RB CH-Low

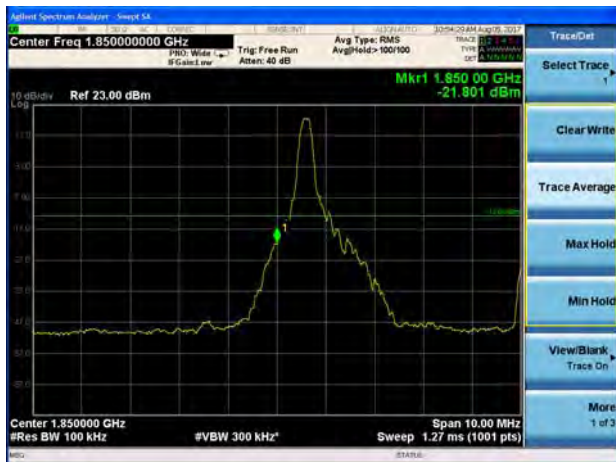

LTE Band 2 10MHz QPSK 1RB CH-High



LTE Band 2 10MHz QPSK 100%RB CH-Low



LTE Band 2 10MHz QPSK 100%RB CH-High





LTE Band 2 15MHz QPSK 1RB CH-Low



LTE Band 2 15MHz QPSK 1RB CH-High



LTE Band 2 15MHz QPSK 100%RB CH-Low



LTE Band 2 15MHz QPSK 100%RB CH-High



LTE Band 2 20MHz QPSK 1RB CH-Low

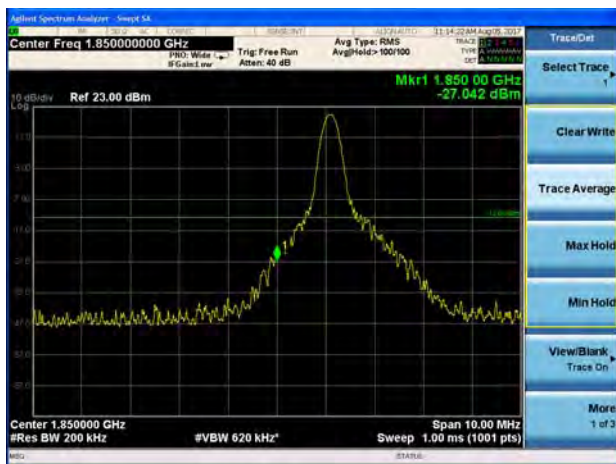

LTE Band 2 20MHz QPSK 1RB CH-High

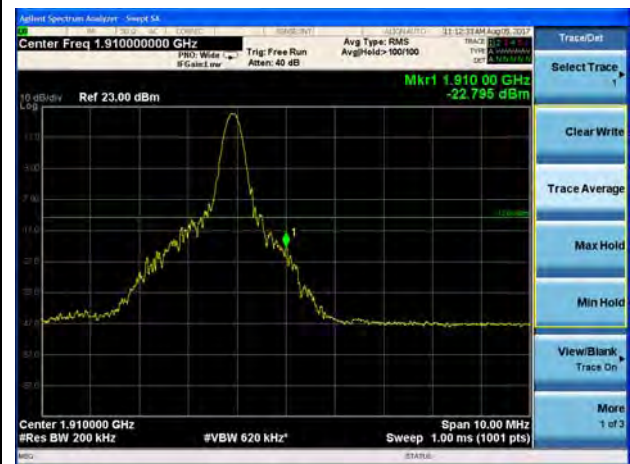



LTE Band 2 20MHz QPSK 100%RB CH-Low

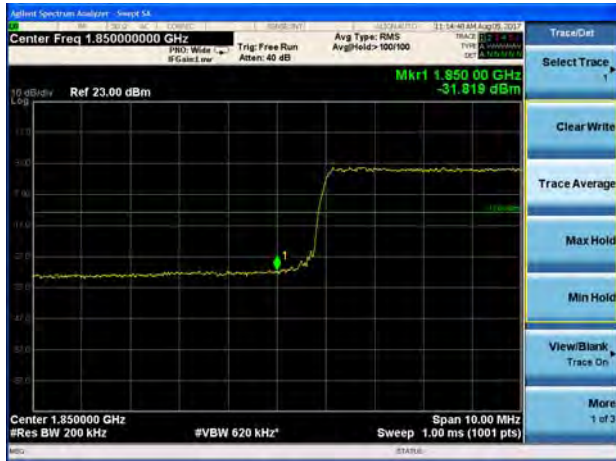

LTE Band 2 20MHz QPSK 100%RB CH-High



LTE Band 2 1.4MHz 16QAM 1RB CH-Low



LTE Band 2 1.4MHz 16QAM 1RB CH-High



LTE Band 2 1.4MHz 16QAM 100%RB CH-Low

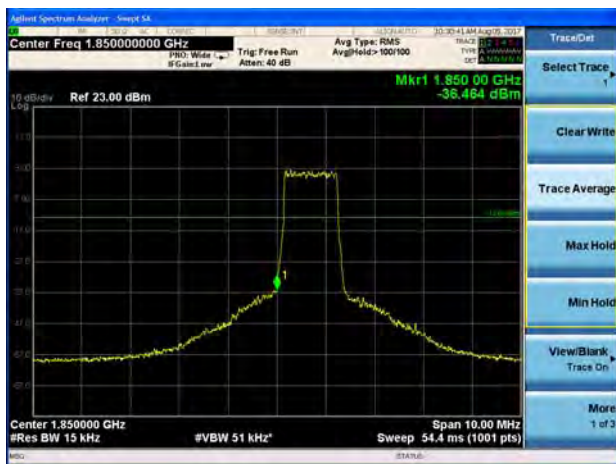

LTE Band 2 1.4MHz 16QAM 100%RB CH-High

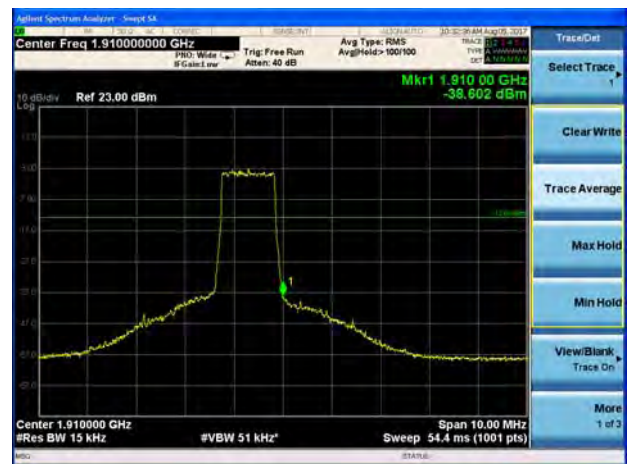



LTE Band 2 3MHz 16QAM 1RB CH-Low



LTE Band 2 3MHz 16QAM 1RB CH-High

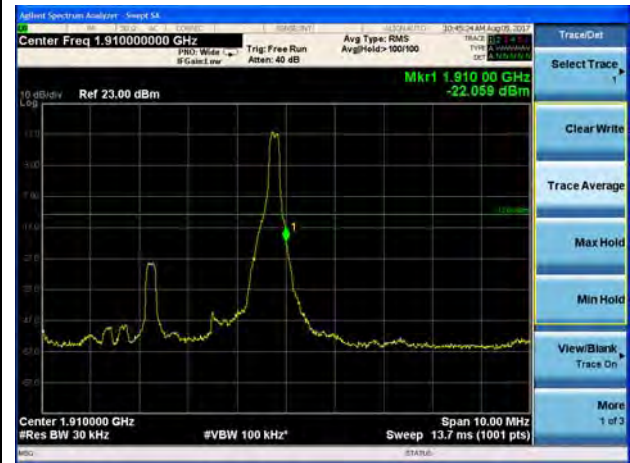

LTE Band 2 3MHz 16QAM 100%RB CH-Low

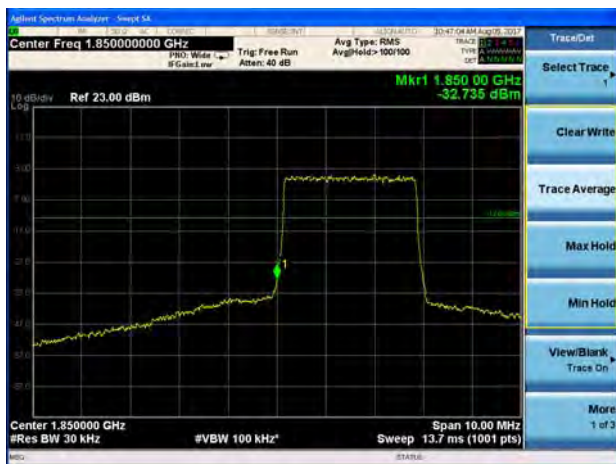

LTE Band 2 3MHz 16QAM 100%RB CH-High



LTE Band 2 5MHz 16QAM 1RB CH-Low



LTE Band 2 5MHz 16QAM 1RB CH-High

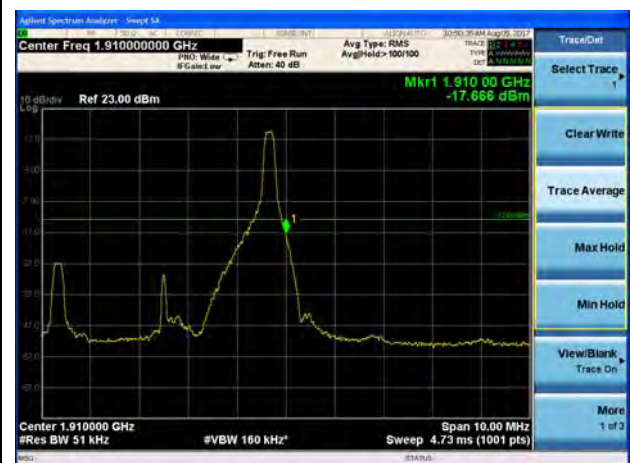



LTE Band 2 5MHz 16QAM 100%RB CH-Low



LTE Band 2 5MHz 16QAM 100%RB CH-High



LTE Band 2 10MHz 16QAM 1RB CH-Low

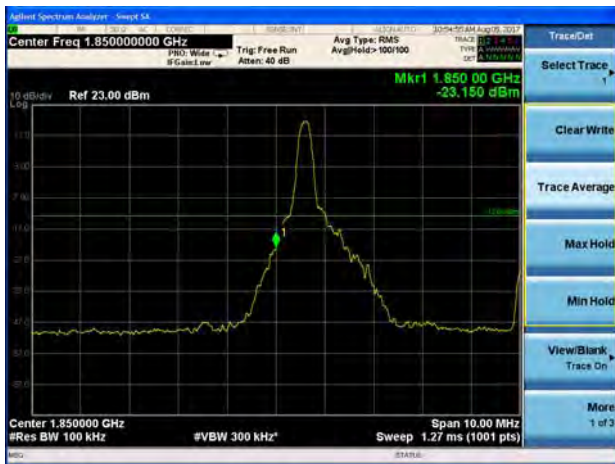

LTE Band 2 10MHz 16QAM 1RB CH-High



LTE Band 2 10MHz 16QAM 100%RB CH-Low

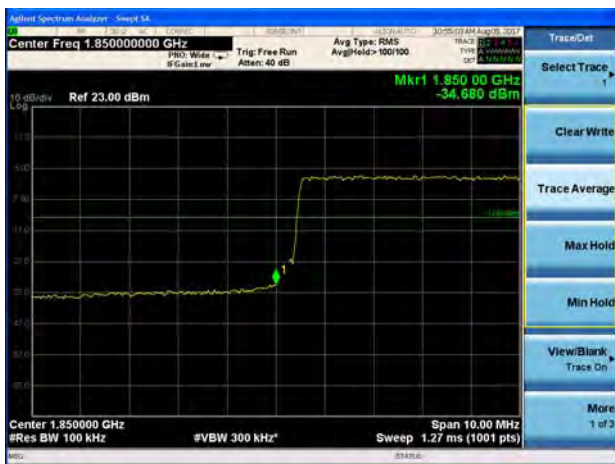

LTE Band 2 10MHz 16QAM 100%RB CH-High





LTE Band 2 15MHz 16QAM 1RB CH-Low



LTE Band 2 15MHz 16QAM 1RB CH-High



LTE Band 2 15MHz 16QAM 100%RB CH-Low



LTE Band 2 15MHz 16QAM 100%RB CH-High



LTE Band 2 20MHz 16QAM 1RB CH-Low



LTE Band 2 20MHz 16QAM 1RB CH-High

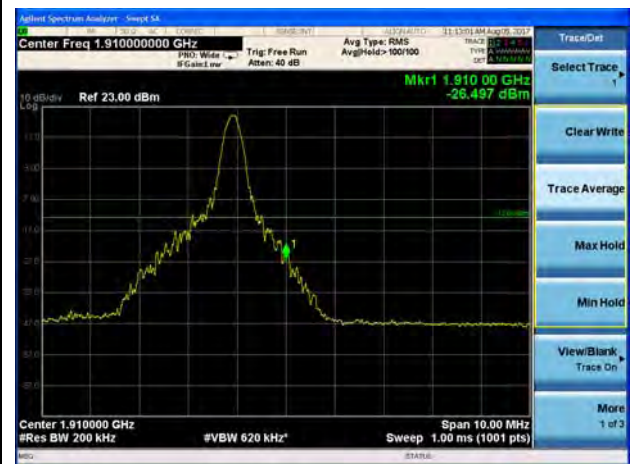



LTE Band 2 20MHz 16QAM 100%RB CH-Low



LTE Band 2 20MHz 16QAM 100%RB CH-High



5.5. Peak-to-Average Power Ratio (PAPR)

Ambient condition

Temperature	Relative humidity	Pressure
23°C ~25°C	45%~50%	101.5kPa

Methods of Measurement

Measure the total peak power and record as PPk. And measure the total average power and record as PAvg. Both the peak and average power levels must be expressed in the same logarithmic units (e.g., dBm). Determine the PAPR from:

$$PAPR (dB) = PPk (dBm) - PAvg (dBm).$$

Test Setup

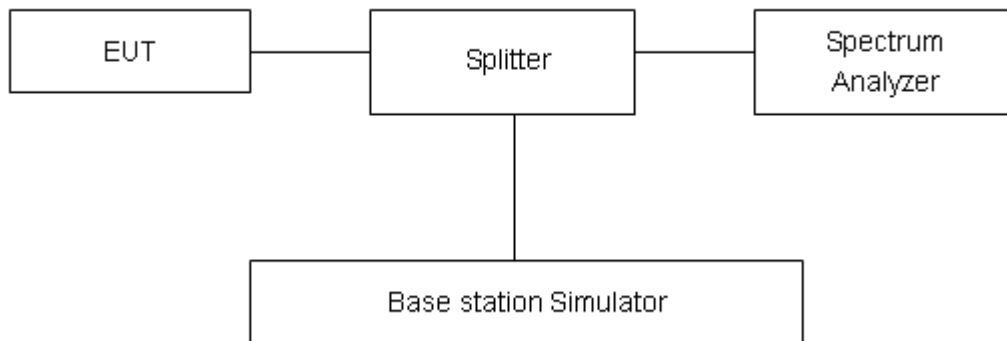

Limits

In measuring transmissions in this band using an average power technique, the peak-to-average ratio (PAR) of the transmission may not exceed 13 dB in 24.232(d).

Measurement Uncertainty

The assessed measurement uncertainty to ensure 95% confidence level for the normal distribution is with the coverage factor $k = 2$, $U = 0.4$ dB.

**Test Results**

Mode	Channel	Frequency (MHz)	Peak(dBm)	Avg(dBm)	PAPR(dB)	Limit(dB)	Conclusion
GSM 1900 (GSM)	512	1850.2	31.60	29.73	1.87	≤13	PASS
	661	1880	31.00	29.65	1.35	≤13	PASS
	810	1909.8	30.74	29.42	1.32	≤13	PASS
GPRS 1900 (GMSK)	512	1850.2	27.62	25.78	1.84	≤13	PASS
	661	1880	27.44	25.65	1.79	≤13	PASS
	810	1909.8	27.46	25.66	1.80	≤13	PASS
EGPRS 1900 (8-PSK)	512	1850.2	24.42	22.65	1.77	≤13	PASS
	661	1880	24.34	22.59	1.75	≤13	PASS
	810	1909.8	24.30	22.56	1.74	≤13	PASS
WCDMA Band II (RMC)	9662	1932.4	24.96	22.15	2.81	≤13	PASS
	9800	1960.0	25.06	22.10	2.96	≤13	PASS
	9938	1987.6	25.17	22.25	2.92	≤13	PASS



LTE Band 2		Channel	Frequency (MHz)	Peak (dBm)	Avg (dBm)	PAPR (dB)	Limit(dB)	Conclusion
Modulation	Bandwidth							
QPSK	1.4MHz	18607	1850.7	26.52	20.86	5.66	≤13	PASS
		18900	1880.0	26.65	20.80	5.85	≤13	PASS
		19193	1909.3	26.73	20.95	5.78	≤13	PASS
	3MHz	18615	1851.5	26.62	20.89	5.73	≤13	PASS
		18900	1880	26.72	20.84	5.88	≤13	PASS
		19185	1908.5	26.75	20.98	5.77	≤13	PASS
	5MHz	18625	1852.5	26.78	20.87	5.91	≤13	PASS
		18900	1880	26.78	20.83	5.95	≤13	PASS
		19175	1907.5	26.77	20.96	5.81	≤13	PASS
	10MHz	18650	1855	26.79	20.95	5.84	≤13	PASS
		18900	1880	26.71	20.85	5.86	≤13	PASS
		19150	1905	26.69	21.00	5.69	≤13	PASS
	15MHz	18675	1857.5	27.25	20.93	6.32	≤13	PASS
		18900	1880	27.13	20.81	6.32	≤13	PASS
		19125	1902.5	27.10	20.95	6.15	≤13	PASS
20MHz	18700	1860	26.88	20.90	5.98	≤13	PASS	
	18900	1880	26.72	20.76	5.96	≤13	PASS	
	19100	1900	26.84	20.91	5.93	≤13	PASS	
16QAM	1.4MHz	18607	1850.7	26.42	20.00	6.42	≤13	PASS
		18900	1880.0	26.45	20.00	6.45	≤13	PASS
		19193	1909.3	26.53	20.11	6.42	≤13	PASS
	3MHz	18615	1851.5	26.49	20.03	6.46	≤13	PASS
		18900	1880	26.61	20.04	6.57	≤13	PASS
		19185	1908.5	26.66	20.14	6.52	≤13	PASS
	5MHz	18625	1852.5	26.51	20.01	6.50	≤13	PASS
		18900	1880	26.51	20.00	6.51	≤13	PASS
		19175	1907.5	26.58	20.09	6.49	≤13	PASS
	10MHz	18650	1855	26.62	20.04	6.58	≤13	PASS
		18900	1880	26.55	20.05	6.50	≤13	PASS
		19150	1905	26.58	20.13	6.45	≤13	PASS
	15MHz	18675	1857.5	26.74	20.01	6.73	≤13	PASS
		18900	1880	26.69	20.00	6.69	≤13	PASS
		19125	1902.5	26.70	20.09	6.61	≤13	PASS
20MHz	18700	1860	26.68	19.99	6.69	≤13	PASS	
	18900	1880	26.60	19.96	6.64	≤13	PASS	
	19100	1900	26.69	20.06	6.63	≤13	PASS	

5.6. Frequency Stability

Ambient condition

Temperature	Relative humidity	Pressure
23°C ~25°C	45%~50%	101.5kPa

Method of Measurement

1. Frequency Stability (Temperature Variation)

The temperature inside the climate chamber is varied from -30°C to +50°C in 10°C step size,

(1) With all power removed, the temperature was decreased to 0°C and permitted to stabilize for three hours.

(2) Measure the carrier frequency with the test equipment in a “call mode”. These measurements should be made within 1 minute of powering up the mobile station, to prevent significant self warming.

(3) Repeat the above measurements at 10°C increments from -30°C to +50°C. Allow at least 1.5 hours at each temperature, un-powered, before making measurements.

2. Frequency Stability (Voltage Variation)

The frequency stability shall be measured with variation of primary supply voltage as follows:

(1) Vary primary supply voltage from 85 to 115 percent of the nominal value for other than hand carried battery equipment.

(2) For hand carried, battery powered equipment, reduce primary supply voltage to the battery-operating end point which shall be specified by the manufacturer.

This transceiver is specified to operate with an input voltage of between 3.4 V and 4.35 V, with a nominal voltage of 3.8V.

Test setup

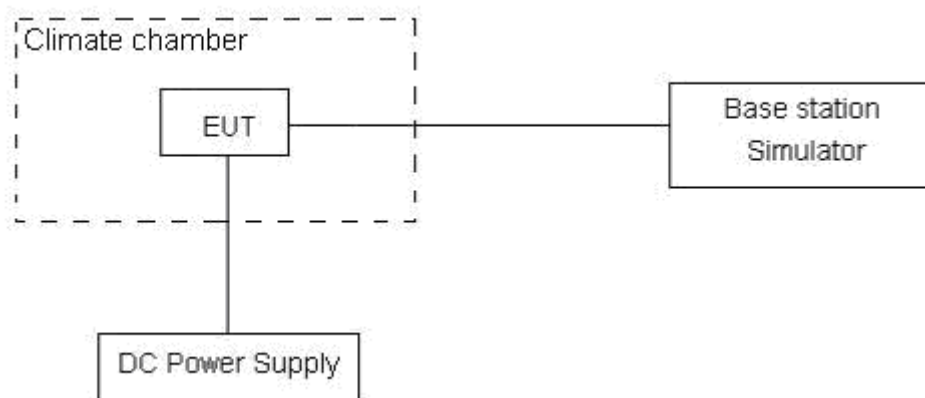

Limits

No specific frequency stability requirements in part 24.235

Measurement Uncertainty

The assessed measurement uncertainty to ensure 99.75% confidence level for the normal distribution is with the coverage factor $k = 3$, $U = 0.01\text{ppm}$.



Test Result

Mode	Test status	Test Results (ppm)		
		GSM(GMSK)	GPRS(GMSK)	EGPRS(8PSK)
GSM 1900 Middle Channel	-30°C/Normal Voltage	0.00056	0.00063	-0.00979
	-20°C/Normal Voltage	0.00383	-0.00960	-0.00531
	-10°C/Normal Voltage	0.00066	0.00083	0.00063
	0°C/Normal Voltage	-0.00297	0.00014	0.00595
	10°C/Normal Voltage	0.00084	-0.00468	0.00276
	20°C/Normal Voltage	0.00076	-0.00787	-0.00268
	30°C/Normal Voltage	-0.00914	0.00035	0.00595
	40°C/Normal Voltage	-0.00346	0.00049	0.00172
	50°C/Normal Voltage	0.00036	-0.00142	0.00321
	20°C/Min Voltage	0.00212	0.00053	0.00235
	20°C/Max Voltage	0.00161	0.00183	-0.00723
/	/	RMC		
WCDMA Band II Middle Channel	-30°C/Normal Voltage	0.000325		
	-20°C/Normal Voltage	-0.000284		
	-10°C/Normal Voltage	-0.000180		
	0°C/Normal Voltage	-0.000290		
	10°C/Normal Voltage	0.000062		
	20°C/Normal Voltage	0.000024		
	30°C/Normal Voltage	0.000117		
	40°C/Normal Voltage	0.000472		
	50°C/Normal Voltage	0.000227		
	20°C/Min Voltage	-0.000170		
	20°C/Max Voltage	0.000152		

Bandwidth	Test status	LTE Band 2 Middle Channel Test Results (ppm)	
		QPSK	16QAM
1.4MHz	-30°C/Normal Voltage	-0.00203	-0.00020
	-20°C/Normal Voltage	0.00120	-0.00311
	-10°C/Normal Voltage	-0.00242	-0.00264
	0°C/Normal Voltage	-0.00231	-0.00279
	10°C/Normal Voltage	0.00025	-0.00012
	20°C/Normal Voltage	-0.00155	-0.00228
	30°C/Normal Voltage	-0.00214	-0.00062
	40°C/Normal Voltage	0.00107	-0.00128



	50°C/Normal Voltage	-0.00115	0.00055	
	20°C/Min Voltage	0.00127	-0.00402	
	20°C/Max Voltage	0.00096	-0.00170	
3MHz	-30°C/Normal Voltage	-0.00115	-0.00135	
	-20°C/Normal Voltage	-0.00259	-0.00306	
	-10°C/Normal Voltage	0.00078	-0.00202	
	0°C/Normal Voltage	-0.00189	-0.00266	
	10°C/Normal Voltage	-0.00256	-0.00307	
	20°C/Normal Voltage	-0.00209	-0.00193	
	30°C/Normal Voltage	-0.00172	0.00035	
	40°C/Normal Voltage	-0.00090	-0.00149	
	50°C/Normal Voltage	0.00077	-0.00357	
	20°C/Min Voltage	0.00001	0.00076	
	20°C/Max Voltage	-0.00113	0.00022	
	5MHz	-30°C/Normal Voltage	0.00105	0.00136
		-20°C/Normal Voltage	-0.00070	0.00106
-10°C/Normal Voltage		-0.00006	0.00145	
0°C/Normal Voltage		-0.00016	0.00031	
10°C/Normal Voltage		-0.00027	0.00105	
20°C/Normal Voltage		-0.00032	-0.00405	
30°C/Normal Voltage		-0.00096	-0.00289	
40°C/Normal Voltage		0.00196	0.00060	
50°C/Normal Voltage		-0.00088	-0.00081	
20°C/Min Voltage		-0.00212	-0.00115	
20°C/Max Voltage		-0.00084	-0.00088	
10MHz	-30°C/Normal Voltage	-0.00015	0.00016	
	-20°C/Normal Voltage	0.00111	0.00118	
	-10°C/Normal Voltage	-0.00065	0.00163	
	0°C/Normal Voltage	0.00128	-0.00024	
	10°C/Normal Voltage	0.00137	-0.00055	
	20°C/Normal Voltage	0.00222	-0.00139	
	30°C/Normal Voltage	0.00339	0.00003	
	40°C/Normal Voltage	0.00016	0.00162	
	50°C/Normal Voltage	0.00064	-0.00107	
	20°C/Min Voltage	0.00067	-0.00157	
	20°C/Max Voltage	-0.00009	0.00122	
15MHz	-30°C/Normal Voltage	-0.00157	-0.00015	
	-20°C/Normal Voltage	-0.00099	0.00209	
	-10°C/Normal Voltage	-0.00052	-0.00039	
	0°C/Normal Voltage	-0.00170	-0.00117	



	10°C/Normal Voltage	-0.00106	0.00138
	20°C/Normal Voltage	-0.00186	0.00005
	30°C/Normal Voltage	-0.00081	-0.00181
	40°C/Normal Voltage	-0.00047	0.00121
	50°C/Normal Voltage	-0.00101	0.00030
	20°C/Min Voltage	-0.00102	0.00213
	20°C/Max Voltage	-0.00078	0.00144
20MHz	-30°C/Normal Voltage	0.00212	-0.00052
	-20°C/Normal Voltage	-0.00018	0.00320
	-10°C/Normal Voltage	-0.00066	-0.00002
	0°C/Normal Voltage	-0.00007	0.00104
	10°C/Normal Voltage	0.00071	0.00035
	20°C/Normal Voltage	-0.00014	0.00118
	30°C/Normal Voltage	-0.00077	-0.00049
	40°C/Normal Voltage	0.00240	0.00185
	50°C/Normal Voltage	0.00231	0.00006
	20°C/Min Voltage	-0.00110	-0.00015
	20°C/Max Voltage	0.00270	-0.00018

5.7. Spurious Emissions at Antenna Terminals

Ambient condition

Temperature	Relative humidity	Pressure
23°C ~25°C	45%~50%	101.5kPa

Method of Measurement

The EUT was connected to Spectrum Analyzer and Base Station Simulator via power Splitter. The measurement is carried out using a spectrum analyzer. The spectrum analyzer scans from 9kHz to the 10th harmonic of the carrier. The peak detector is used.set RBW 1MHz and VBW is 3MHz, Sweep is set to ATUO.

Test setup

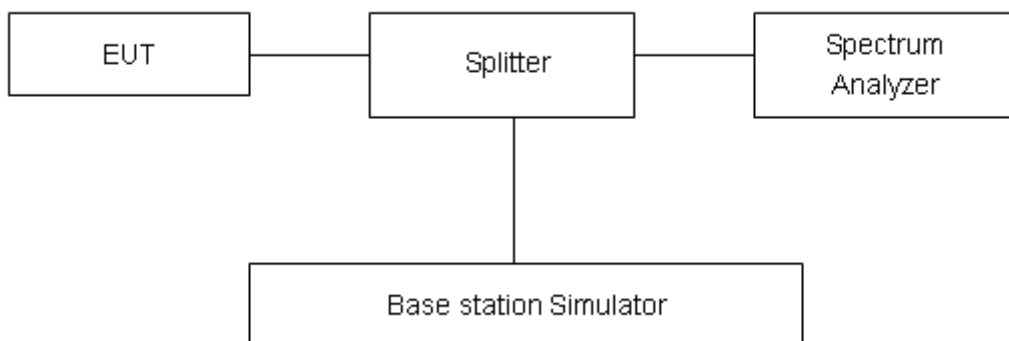

Limits

Rule Part 24.238(a) specifies that “on any frequency outside a licensee’s frequency block, the power of any emission shall be attenuated below the transmitter power (P) by at least 43 + 10 log₁₀ (P) dB.”

Limit	-13 dBm
-------	---------

Measurement Uncertainty

The assessed measurement uncertainty to ensure 99.75% confidence level for the normal distribution is with the coverage factor $k = 1.96$.

Frequency	Uncertainty
100kHz-2GHz	0.684 dB
2GHz-18GHz	1.407 dB



Test Result

Sweep from 9 kHz to 30MHz, and the emissions more than 20 dB below the permissible value are not reported.

If disturbances were found more than 20dB below limit line, the mark is not required for the EUT. The signal beyond the limit is carrier.

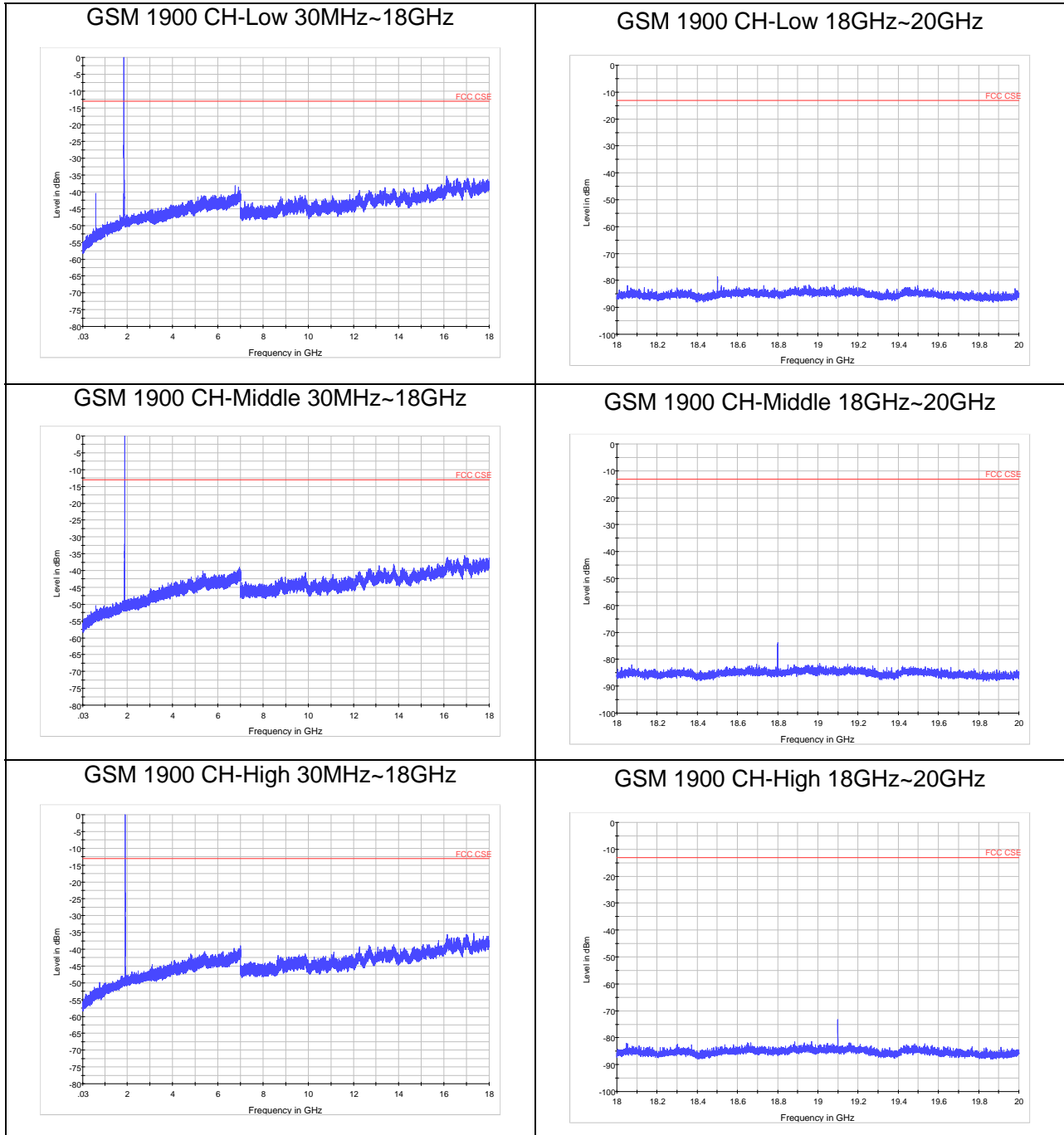



WCDMA Band II CH-Low 30MHz~18GHz

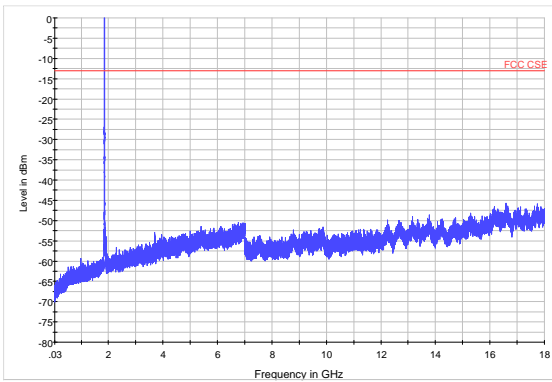

WCDMA Band II CH-Low 18GHz~20GHz

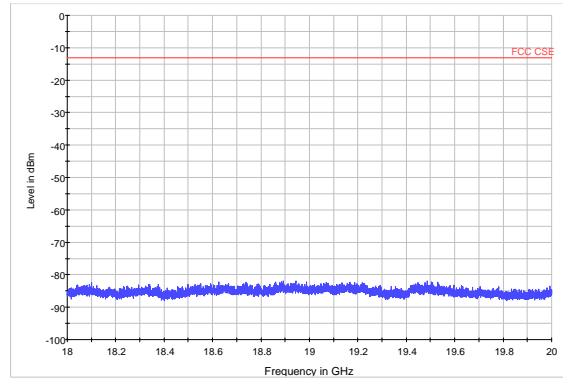

WCDMA Band II CH-Middle 30MHz~18GHz

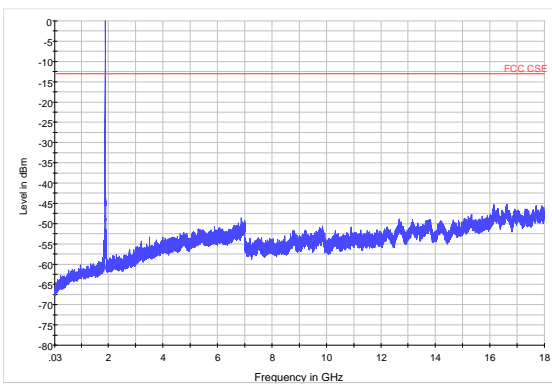

WCDMA Band II CH-Middle 18GHz~20GHz

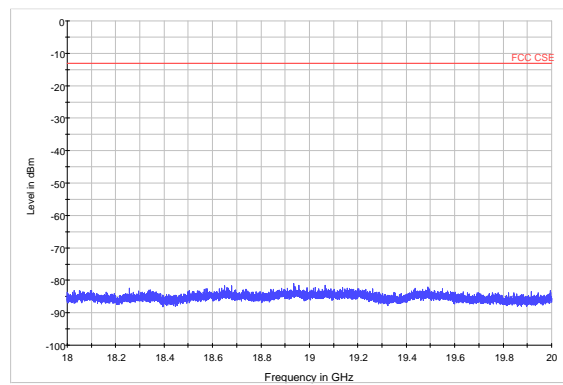

WCDMA Band II CH-High 30MHz~18GHz

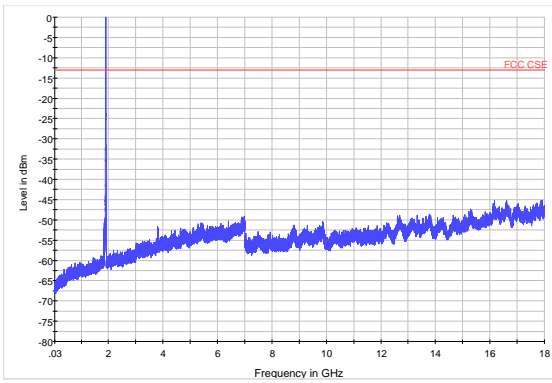

WCDMA Band II CH-High 18GHz~20GHz

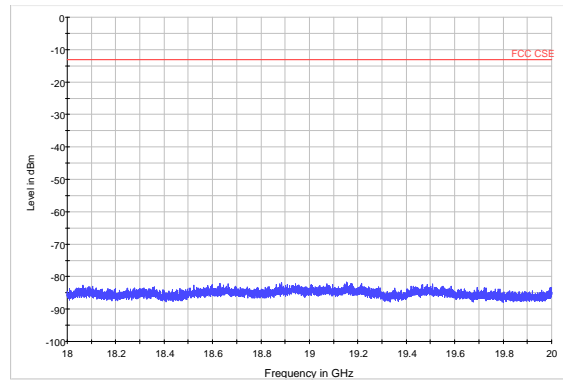

LTE Band 2 1.4MHz CH-Low 30MHz~3GHz

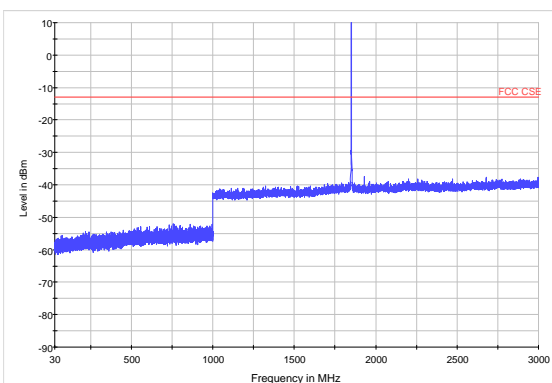

LTE Band 2 1.4MHz CH-Middle 30MHz~3GHz

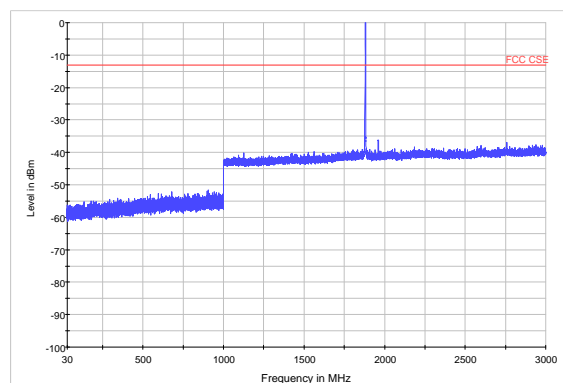



LTE Band 2 1.4MHz CH-Low 3GHz~18GHz

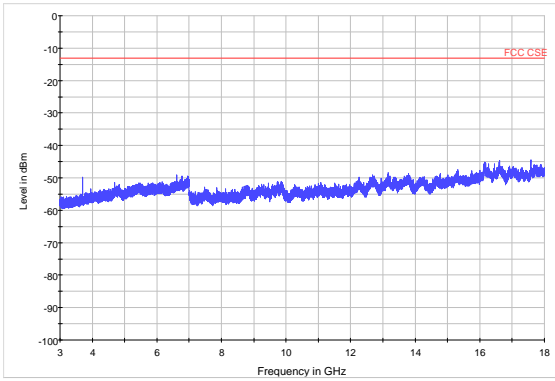

LTE Band 2 1.4MHz CH-Middle 3GHz~18GHz

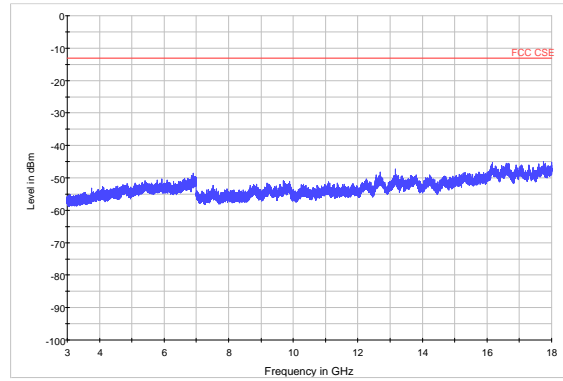

LTE Band 2 1.4MHz CH-Low 18GHz~20GHz

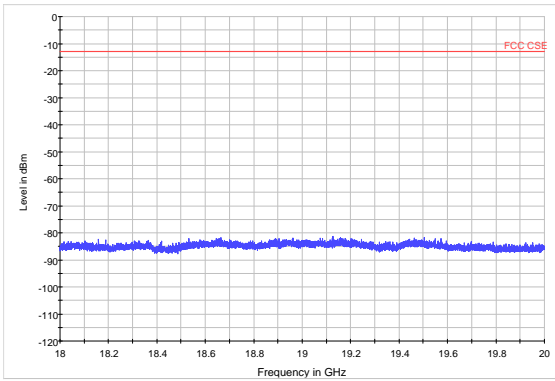

LTE Band 2 1.4MHz CH-Middle 18GHz~20GHz

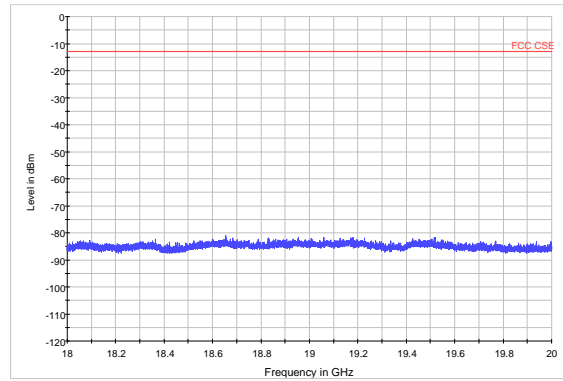

LTE Band 2 1.4MHz CH-High 30MHz~3GHz

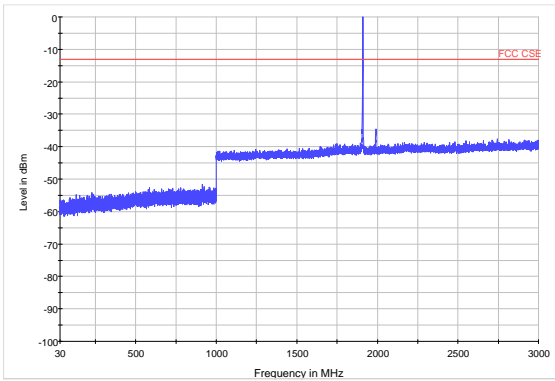

LTE Band 2 3MHz CH-Low 30MHz~3GHz

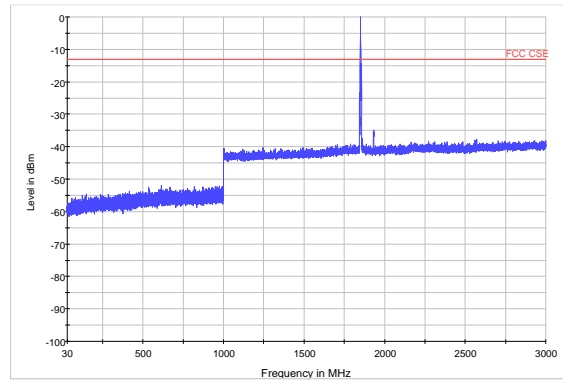

LTE Band 2 1.4MHz CH-High 3GHz~18GHz

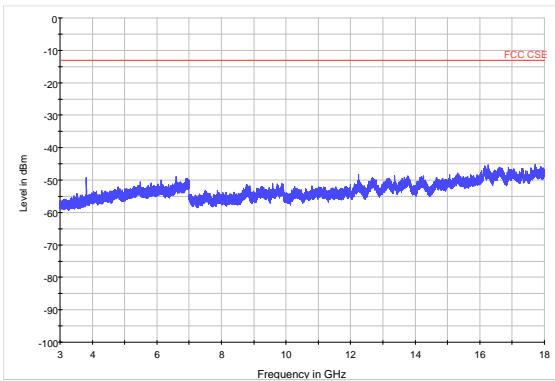

LTE Band 2 3MHz CH-Low 3GHz~18GHz

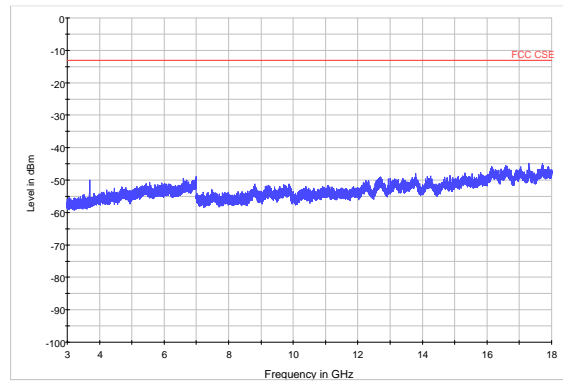



LTE Band 2 1.4MHz CH-High 18GHz~20GHz

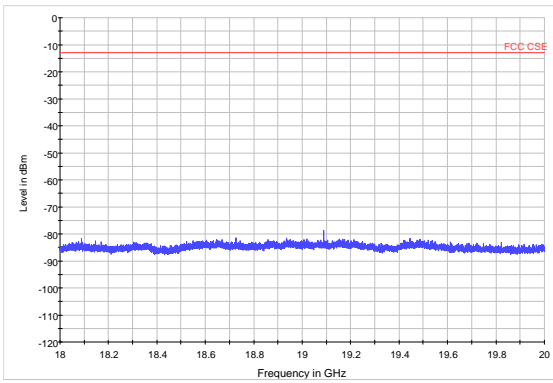

LTE Band 2 3MHz CH-Low 18GHz~20GHz

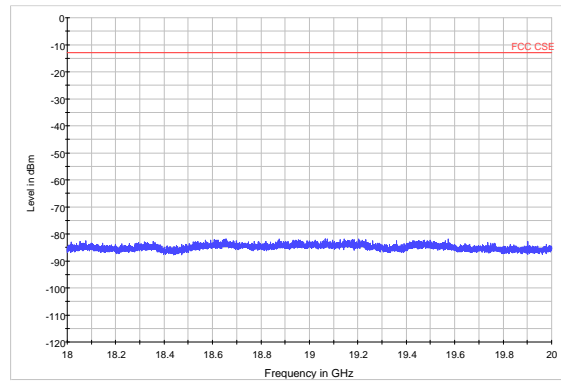

LTE Band 2 3MHz CH-Middle 30MHz~3GHz

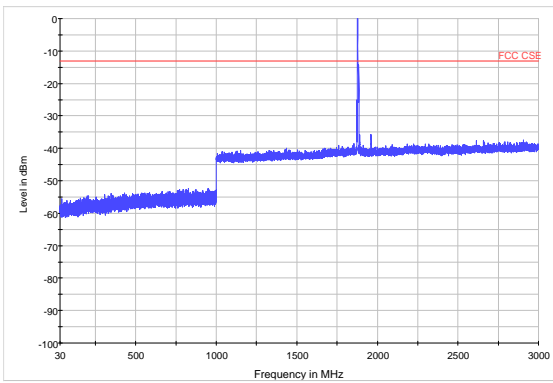

LTE Band 2 3MHz CH-High 30MHz~3GHz

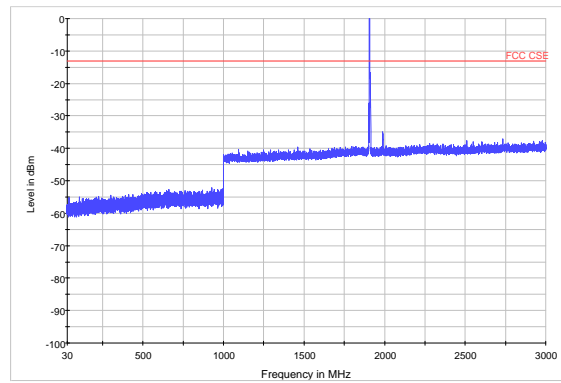

LTE Band 2 3MHz CH-Middle 3GHz~18GHz

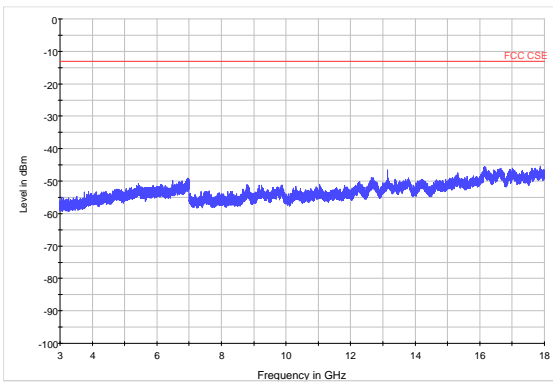

LTE Band 2 3MHz CH-High 3GHz~18GHz

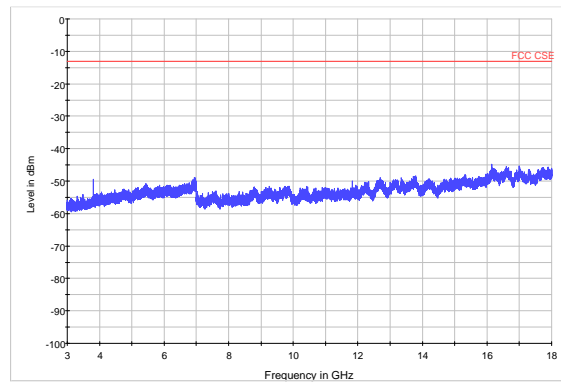

LTE Band 2 3MHz CH-Middle 18GHz~20GHz

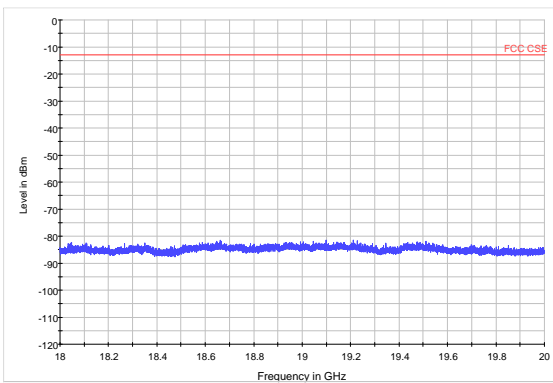

LTE Band 2 3MHz CH-High 18GHz~20GHz

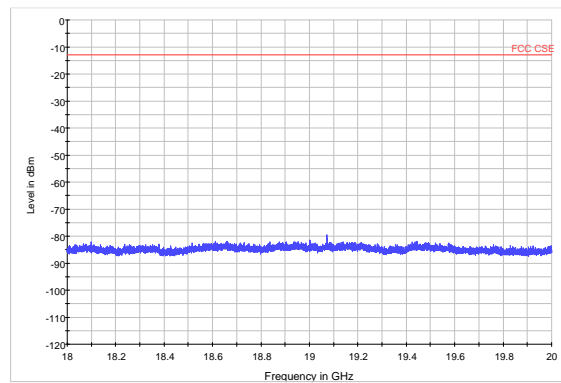



LTE Band 2 5MHz CH-Low 30MHz~3GHz

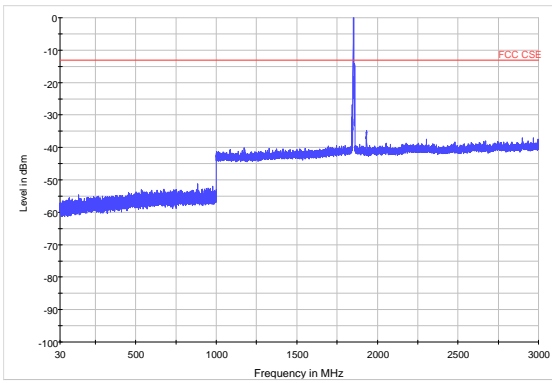

LTE Band 2 5MHz CH-Middle 30MHz~3GHz

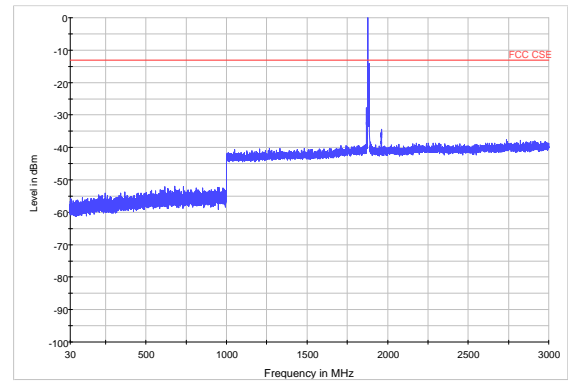

LTE Band 2 5MHz CH-Low 3GHz~18GHz

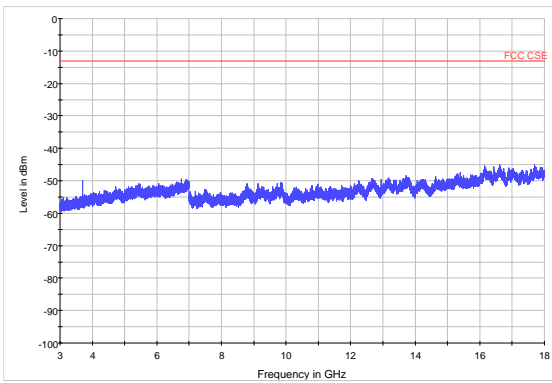

LTE Band 2 5MHz CH-Middle 3GHz~18GHz

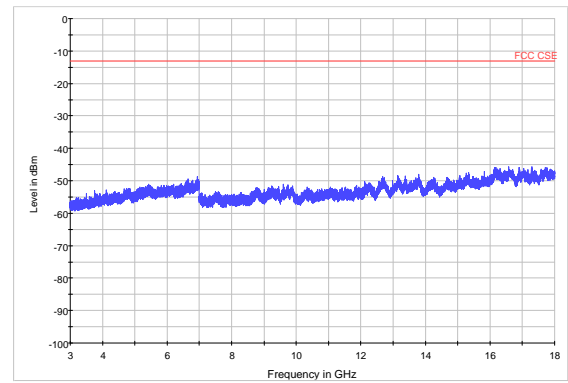

LTE Band 2 5MHz CH-Low 18GHz~20GHz

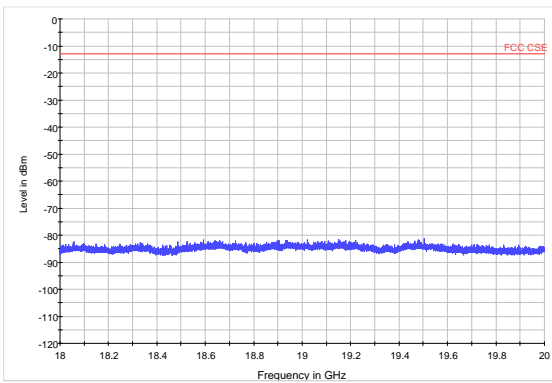

LTE Band 2 5MHz CH-Middle 18GHz~20GHz

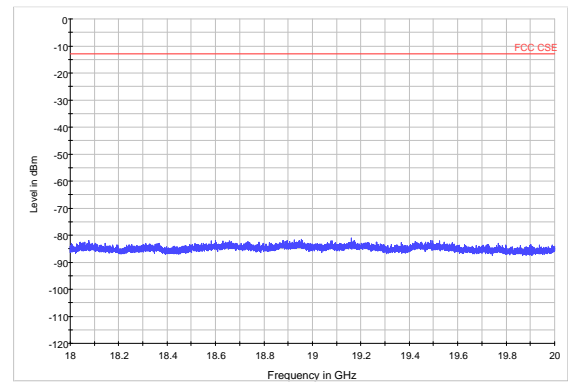

LTE Band 2 5MHz CH-High 30MHz~3GHz

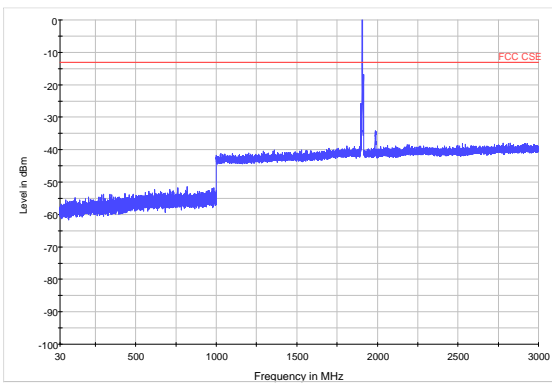

LTE Band 2 10MHz CH-Low 30MHz~3GHz

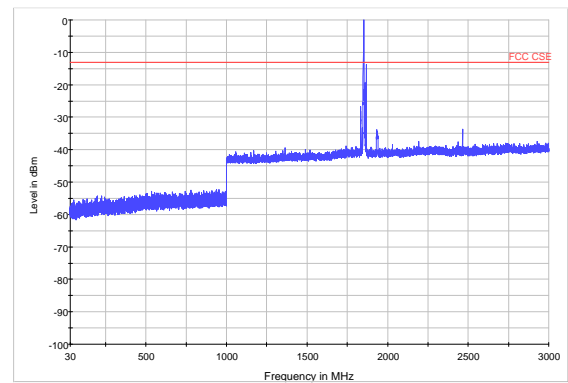



LTE Band 2 5MHz CH-High 3GHz~18GHz

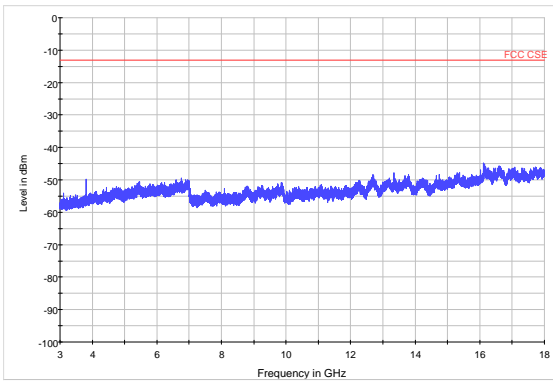

LTE Band 2 10MHz CH-Low 3GHz~18GHz

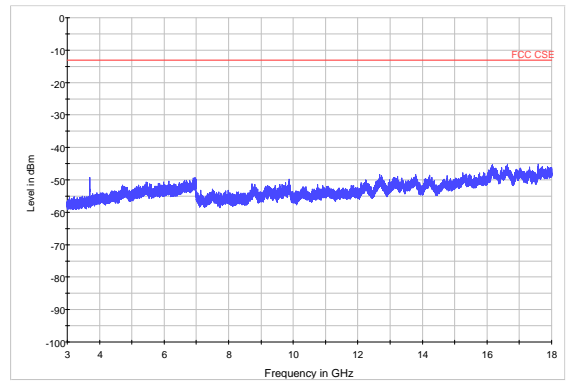

LTE Band 2 5MHz CH-High 18GHz~20GHz

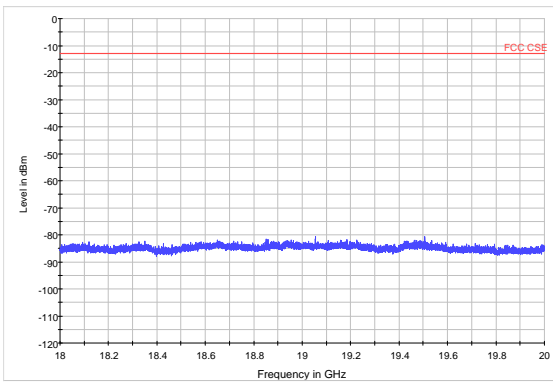

LTE Band 2 10MHz CH-Low 18GHz~20GHz

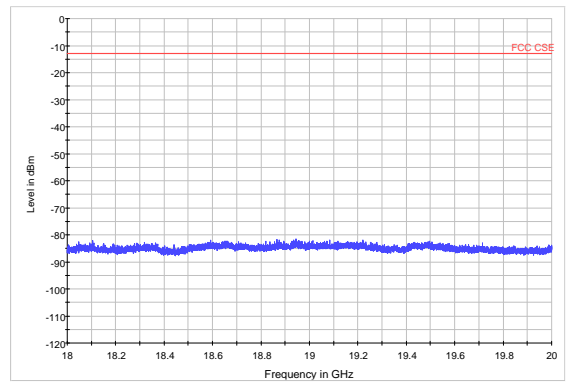

LTE Band 2 10MHz CH-Middle 30MHz~3GHz

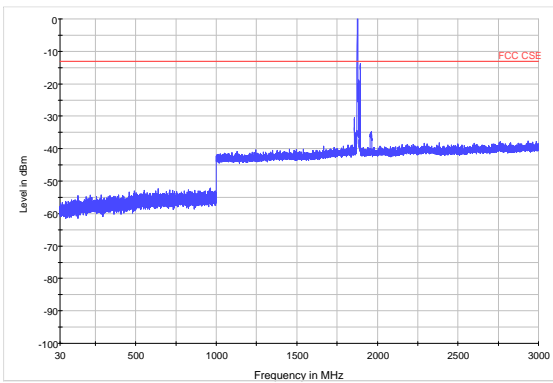

LTE Band 2 10MHz CH-High 30MHz~3GHz

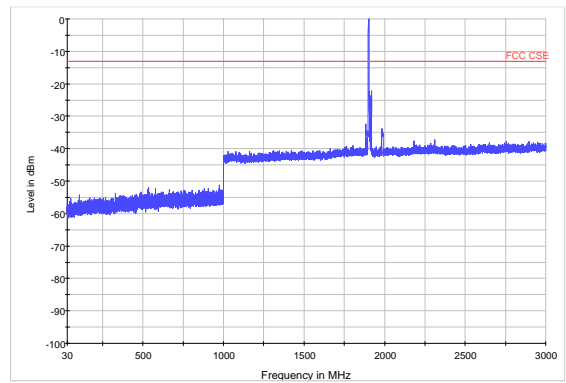

LTE Band 2 10MHz CH-Middle 3GHz~18GHz

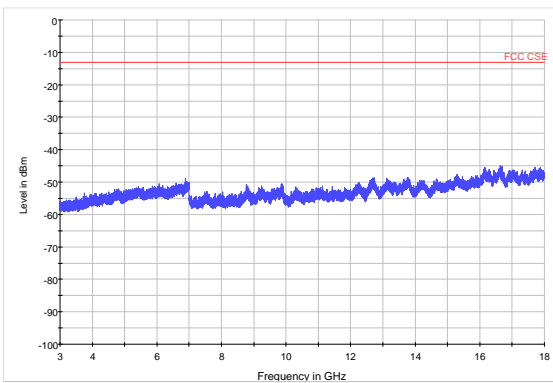

LTE Band 2 10MHz CH-High 3GHz~18GHz

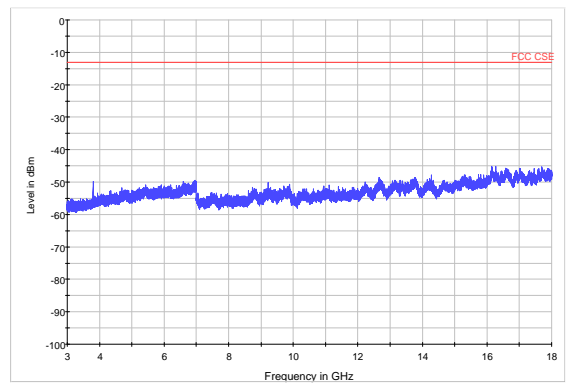



LTE Band 2 10MHz CH-Middle 18GHz~20GHz

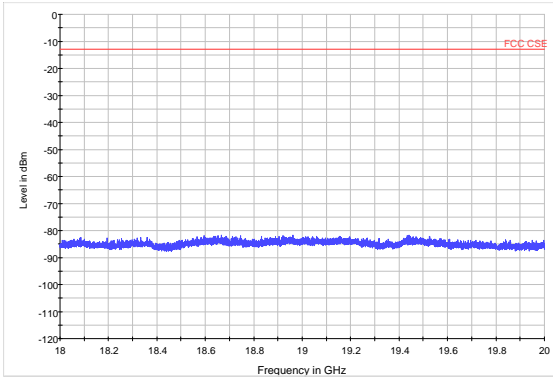

LTE Band 2 10MHz CH-High 18GHz~20GHz

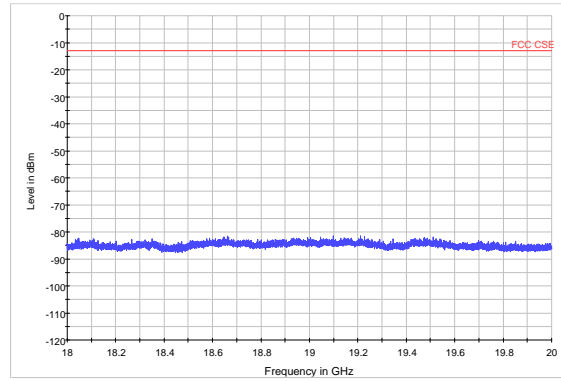

LTE Band 2 15MHz CH-Low 30MHz~3GHz

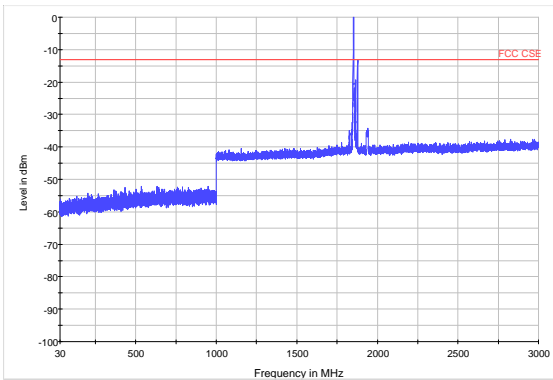

LTE Band 2 15MHz CH-Middle 30MHz~3GHz

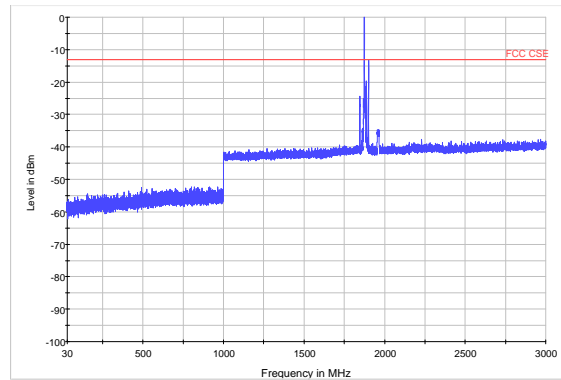

LTE Band 2 15MHz CH-Low 3GHz~18GHz

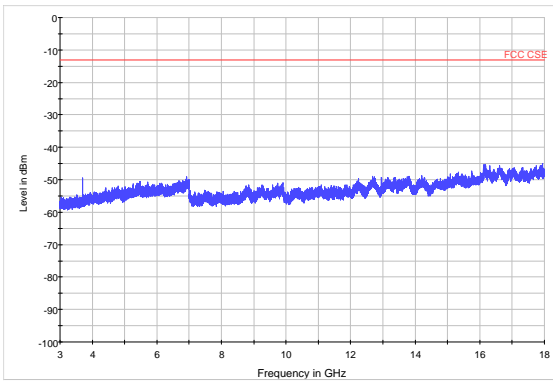

LTE Band 2 15MHz CH-Middle 3GHz~18GHz

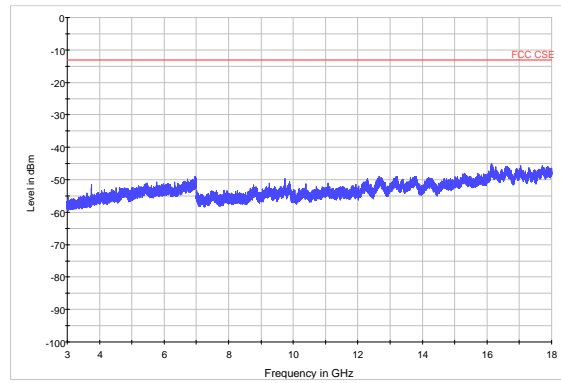

LTE Band 2 15MHz CH-Low 18GHz~20GHz

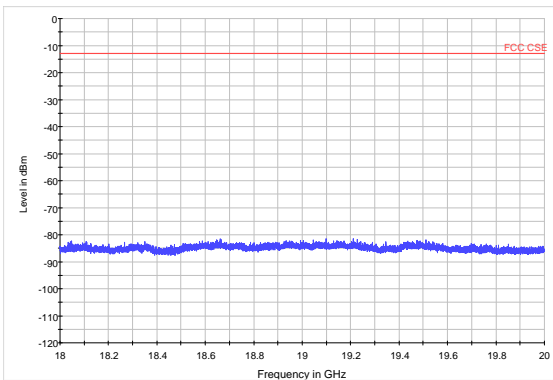

LTE Band 2 15MHz CH-Middle 18GHz~20GHz

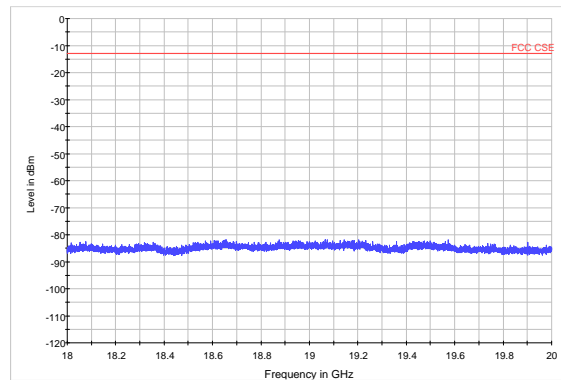



LTE Band 2 15MHz CH-High 30MHz~3GHz

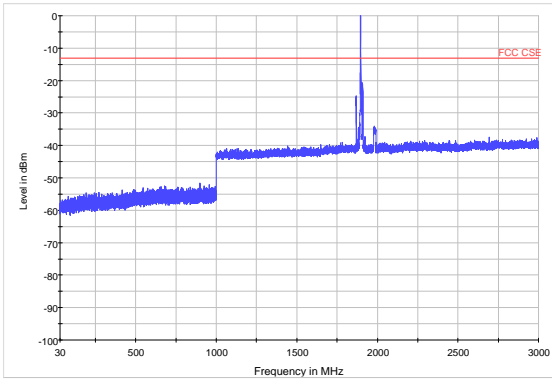

LTE Band 2 20MHz CH-Low 30MHz~3GHz

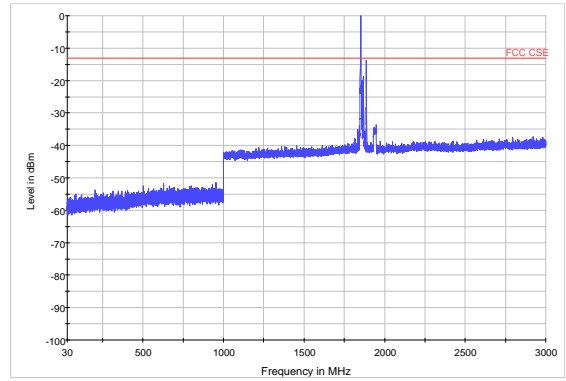

LTE Band 2 15MHz CH-High 3GHz~18GHz

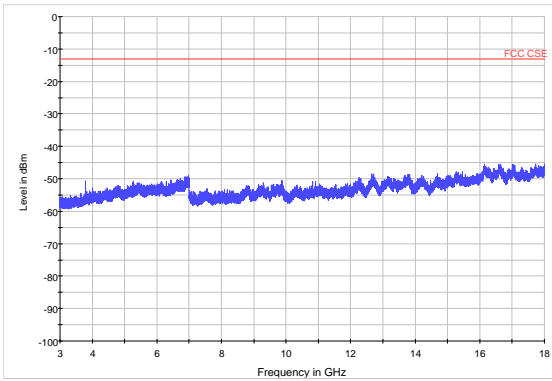

LTE Band 2 20MHz CH-Low 3GHz~18GHz

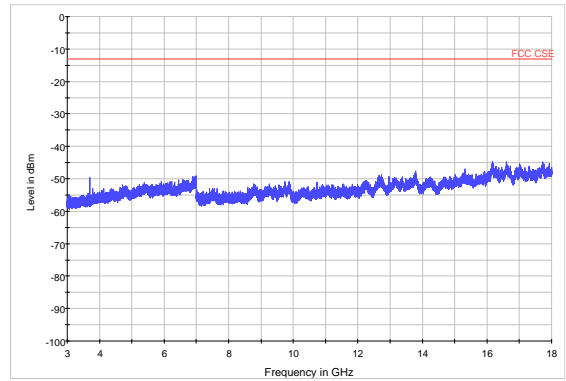

LTE Band 2 15MHz CH-High 18GHz~20GHz

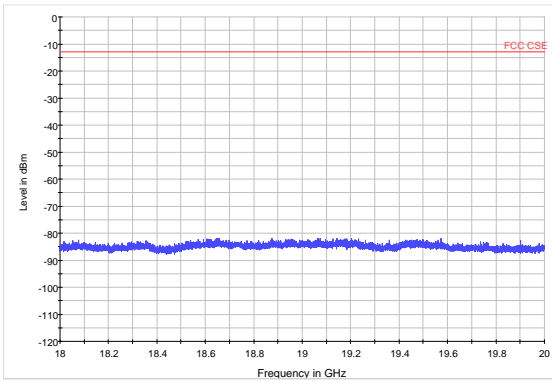

LTE Band 2 20MHz CH-Low 18GHz~20GHz

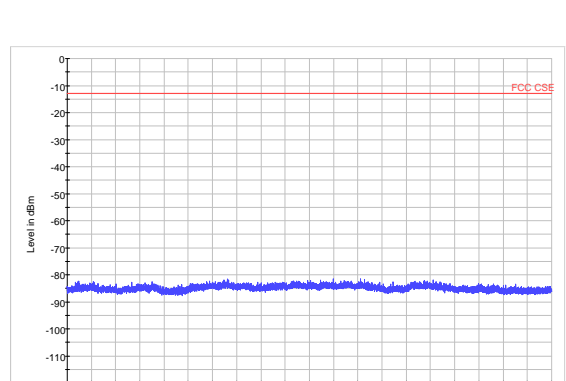

LTE Band 2 20MHz CH-Middle 30MHz~3GHz

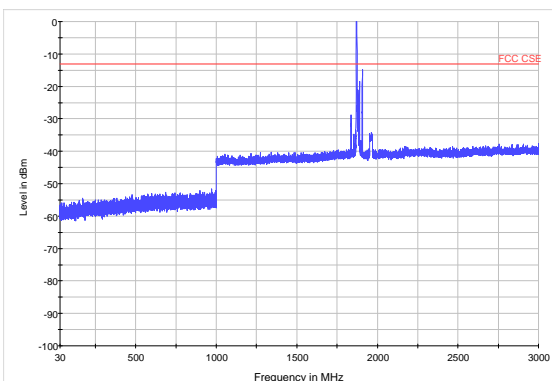

LTE Band 2 20MHz CH-High 30MHz~3GHz

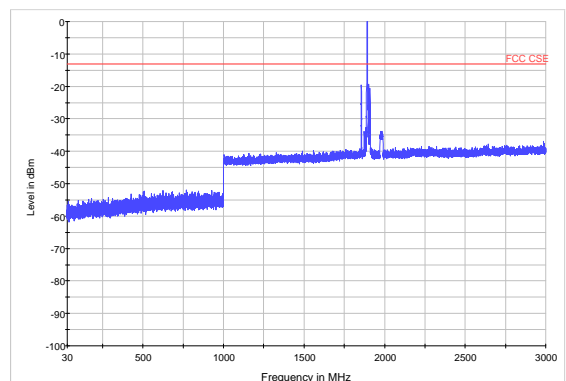



LTE Band 2 20MHz CH-Middle 3GHz~18GHz

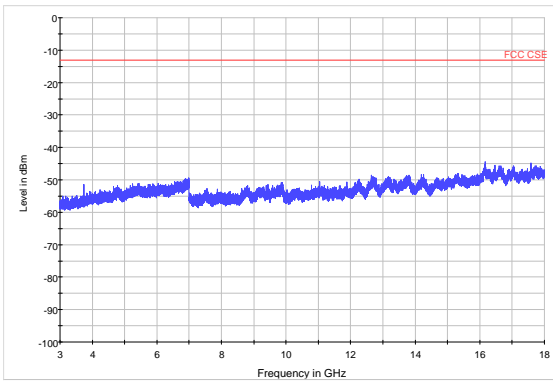

LTE Band 2 20MHz CH-High 3GHz~18GHz

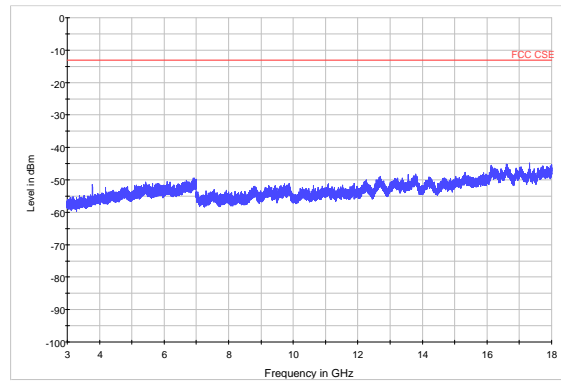

LTE Band 2 20MHz CH-Middle 18GHz~20GHz

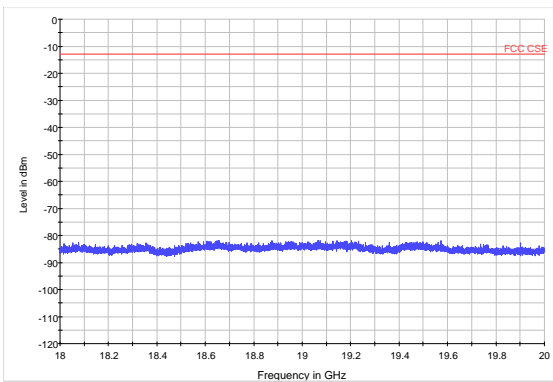

LTE Band 2 20MHz CH-High 18GHz~20GHz

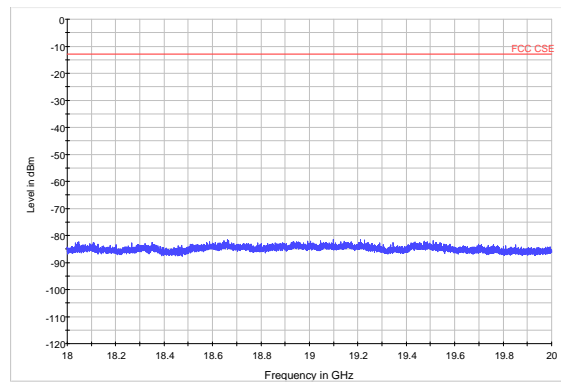

5.8.Radiates Spurious Emission

Ambient condition

Temperature	Relative humidity	Pressure
23°C ~25°C	45%~50%	101.5kPa

Method of Measurement

1. The testing follows ANSI C63.26 (2015) Section 5.5.2.3.
2. Above 30MHz: The EUT is placed on a turntable 0.8 meters above the ground in the chamber, 3 meter away from the antenna. The maximal emission value is acquired by adjusting the antenna height, polarisation and turntable azimuth. Normally, the height range of antenna is 1 m to 4 m, the azimuth range of turntable is 0° to 360°, and the receive antenna has two polarizations Vertical (V) and Horizontal (H). Above 1GHz: (Note: the FCC's permission to use 1.5m as an alternative per TCBC Conf call of Dec. 2, 2014.) The EUT is placed on a turntable 1.5 meters above the ground in the chamber, 3 meter away from the antenna. The maximal emission value is acquired by adjusting the antenna height, polarisation and turntable azimuth. Normally, the height range of antenna is 1 m to 4 m, the azimuth range of turntable is 0° to 360°, and the receive antenna has two polarizations Vertical (V) and Horizontal (H).
3. A log-periodic antenna or double-ridged waveguide horn antenna shall be substituted in place of the EUT. The log-periodic antenna will be driven by a signal generator and the level will be adjusted till the same power value on the spectrum analyzer or receiver. The level of the spurious emissions can be calculated through the level of the signal generator, cable loss, the gain of the substitution antenna and the reading of the spectrum analyzer or receiver.
4. The EUT is then put into continuously transmitting mode at its maximum power level during the test. Set Test Receiver or Spectrum RBW=1MHz, VBW=3MHz, And the maximum value of the receiver should be recorded as (Pr).
5. The EUT shall be replaced by a substitution antenna. In the chamber, an substitution antenna for the frequency band of interest is placed at the reference point of the chamber. An RF Signal source for the frequency band of interest is connected to the substitution antenna with a cable that has been constructed to not interfere with the radiation pattern of the antenna. A power (PMea) is applied to the input of the substitution antenna, and adjust the level of the signal generator output until the value of the receiver reach the previously recorded (Pr). The power of signal source (PMea) is recorded. The test should be performed by rotating the test item and adjusting the receiving antenna polarization.
6. A amplifier should be connected to the Signal Source output port. And the cable should be connect between the Amplifier and the Substitution Antenna. The cable loss (Pcl) ,the Substitution Antenna Gain (Ga) and the Amplifier Gain (PAg) should be recorded after test.
7. The measurement results are obtained as described below:
Power(EIRP)=PMea- PAg - Pcl + Ga
The measurement results are amend as described below:
Power(EIRP)=PMea- Pcl + Ga
8. This value is EIRP since the measurement is calibrated using an antenna of known gain (2.15 dBi) and known input power. ERP can be calculated from EIRP by subtracting the gain of the dipole, ERP

= EIRP-2.15dBi.

Test setup

30MHz~~~ 1GHz

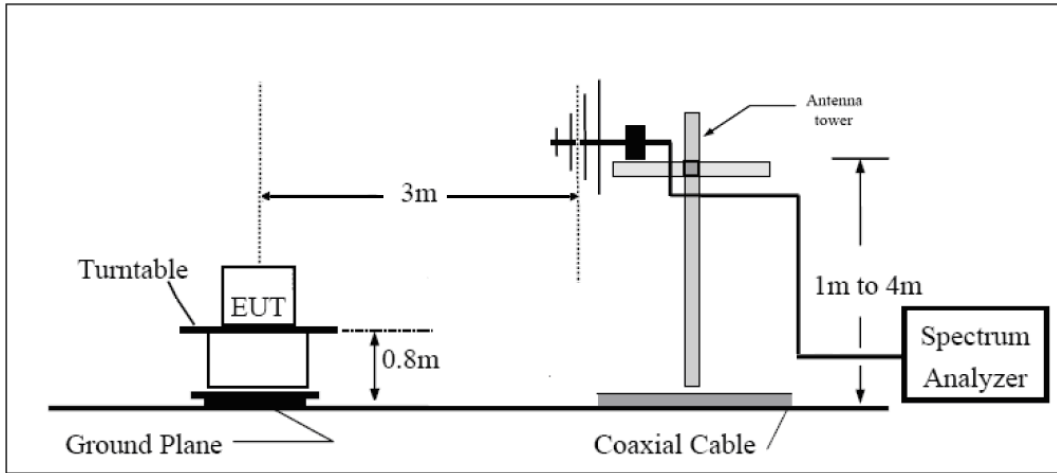

Above 1GHz

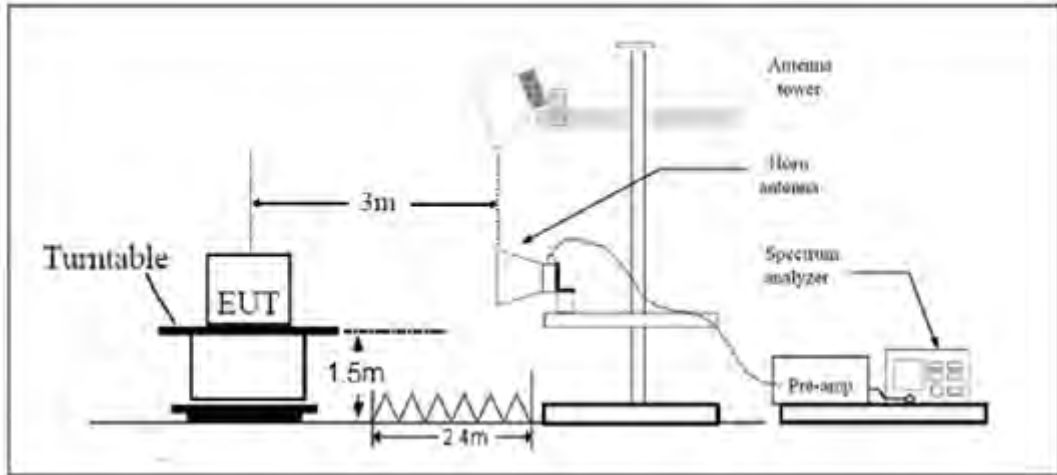

Note: Area side: 2.4mX3.6m

The radiated emission was measured in the following position: EUT stand-up position (Z axis), lie-down position (X, Y axis). The worst emission was found in stand-up position (Z axis) and the worst case was recorded.

Limits

Rule Part 24.238(a) specifies that “on any frequency outside a licensee's frequency block, the power of any emission shall be attenuated below the transmitter power (P) by at least 43 + 10 log₁₀ (P) dB.”

Limit	-13 dBm
-------	---------

Measurement Uncertainty

The assessed measurement uncertainty to ensure 95% confidence level for the normal distribution is with the coverage factor $k = 1.96$, $U = 3.55$ dB.

**Test Result**

GSM 1900 CH-Low

Harmonic	Frequency (MHz)	SG (dBm)	Cable Loss (dB)	Gain (dBi)	Antenna Polarization	EIRP Level (dBm)	Limit (dBm)	Margin (dB)	Azimuth (deg)
2	3700.4	-57.05	5.1	11.05	vertical	-51.1	-13.0	38.1	270
3	5550.6	-51.43	5.42	12.65	vertical	-44.2	-13.0	31.2	225
4	7400.8	-57.35	6.7	13.85	vertical	-50.2	-13.0	37.2	45
5	9251.0	-55.84	7.01	14.75	vertical	-48.1	-13.0	35.1	225
6	11101.2	-56.97	7.48	15.95	vertical	-48.5	-13.0	35.5	45
7	12951.4	-52.94	7.51	16.55	vertical	-43.9	-13.0	30.9	225
8	14801.6	-52.31	8.24	15.35	vertical	-45.2	-13.0	32.2	270
9	16651.8	-48.74	8.41	14.95	vertical	-42.2	-13.0	29.2	225
10	18502.0	-47.32	8.54	15.45	vertical	-40.4	-13.0	27.4	180

Note: 1.The other Spurious RF Radiated emissions level is no more than noise floor.
2.The worst emission was found in the antenna is vertical position.

GSM 1900 CH-Middle

Harmonic	Frequency (MHz)	SG (dBm)	Cable Loss (dB)	Gain (dBi)	Antenna Polarization	EIRP Level (dBm)	Limit (dBm)	Margin (dB)	Azimuth (deg)
2	3760.1	-54.95	5.1	11.05	vertical	-49.0	-13.0	36.0	225
3	5640.0	-51.43	5.42	12.65	vertical	-44.2	-13.0	31.2	225
4	7520.0	-57.35	6.7	13.85	vertical	-50.2	-13.0	37.2	45
5	9400.0	-55.84	7.01	14.75	vertical	-48.1	-13.0	35.1	225
6	11280.0	-56.97	7.48	15.95	vertical	-48.5	-13.0	35.5	45
7	13160.0	-52.94	7.51	16.55	vertical	-43.9	-13.0	30.9	225
8	15040.0	-52.31	8.24	15.35	vertical	-45.2	-13.0	32.2	270
9	16920.0	-48.74	8.41	14.95	vertical	-42.2	-13.0	29.2	225
10	18800.0	-48.22	8.54	15.45	vertical	-41.3	-13.0	28.3	90

Note: 1.The other Spurious RF Radiated emissions level is no more than noise floor.
2. The worst emission was found in the antenna is vertical position.



GSM 1900 CH-High

Harmonic	Frequency (MHz)	SG (dBm)	Cable Loss (dB)	Gain (dBi)	Antenna Polarization	EIRP Level (dBm)	Limit (dBm)	Margin (dB)	Azimuth (deg)
2	3819.6	-57.65	5.1	11.05	vertical	-51.7	-13.0	38.7	225
3	5729.4	-51.23	5.42	12.65	vertical	-44.0	-13.0	31.0	225
4	7639.2	-57.95	6.7	13.85	vertical	-50.8	-13.0	37.8	45
5	9549.0	-55.84	7.01	14.75	vertical	-48.1	-13.0	35.1	225
6	11458.8	-56.67	7.48	15.95	vertical	-48.2	-13.0	35.2	45
7	13368.6	-52.94	7.51	16.55	vertical	-43.9	-13.0	30.9	225
8	15278.4	-52.11	8.24	15.35	vertical	-45.0	-13.0	32.0	270
9	17188.2	-49.34	8.41	14.95	vertical	-42.8	-13.0	29.8	225
10	19098	-47.86	8.54	15.45	vertical	-40.9	-13.0	27.9	45

- Note: 1.The other Spurious RF Radiated emissions level is no more than noise floor.
2. The worst emission was found in the antenna is vertical position.

WCDMA Band II CH-Low

Harmonic	Frequency (MHz)	SG (dBm)	Cable Loss (dB)	Gain (dBi)	Antenna Polarization	EIRP Level (dBm)	Limit (dBm)	Margin (dB)	Azimuth (deg)
2	3702.0	-51.15	5.1	11.05	vertical	-45.2	-13.0	32.2	225
3	5560.9	-49.43	5.42	12.65	vertical	-42.2	-13.0	29.2	45
4	7406.3	-56.15	6.7	13.85	vertical	-49.0	-13.0	36.0	225
5	7409.6	-51.94	7.01	14.75	vertical	-44.2	-13.0	31.2	45
6	9262.0	-58.67	7.48	15.95	vertical	-50.2	-13.0	37.2	225
7	11114.4	-57.14	7.51	16.55	vertical	-48.1	-13.0	35.1	270
8	12966.8	-55.61	8.24	15.35	vertical	-48.5	-13.0	35.5	225
9	14819.2	-50.44	8.41	14.95	vertical	-43.9	-13.0	30.9	45
10	16671.6	-52.11	8.54	15.45	vertical	-45.2	-13.0	32.2	225

- Note: 1.The other Spurious RF Radiated emissions level is no more than noise floor.
2.The worst emission was found in the antenna is vertical position.



WCDMA Band II CH-Middle

Harmonic	Frequency (MHz)	SG (dBm)	Cable Loss (dB)	Gain (dBi)	Antenna Polarization	EIRP Level (dBm)	Limit (dBm)	Margin (dB)	Azimuth (deg)
2	3757.5	-48.15	5.1	11.05	vertical	-42.2	-13.0	29.2	225
3	5637.4	-56.23	5.42	12.65	vertical	-49.0	-13.0	36.0	45
4	5640.0	-51.35	6.7	13.85	vertical	-44.2	-13.0	31.2	225
5	7520.0	-57.94	7.01	14.75	vertical	-50.2	-13.0	37.2	270
6	9400.0	-56.57	7.48	15.95	vertical	-48.1	-13.0	35.1	225
7	11280.0	-57.54	7.51	16.55	vertical	-48.5	-13.0	35.5	45
8	13160.0	-51.01	8.24	15.35	vertical	-43.9	-13.0	30.9	315
9	15040.0	-51.74	8.41	14.95	vertical	-45.2	-13.0	32.2	225
10	16920.0	-49.11	8.54	15.45	vertical	-42.2	-13.0	29.2	180

Note: 1.The other Spurious RF Radiated emissions level is no more than noise floor.

2.The worst emission was found in the antenna is vertical position.

WCDMA Band II CH-High

Harmonic	Frequency (MHz)	SG (dBm)	Cable Loss (dB)	Gain (dBi)	Antenna Polarization	EIRP Level (dBm)	Limit (dBm)	Margin (dB)	Azimuth (deg)
2	3813.8	-55.05	5.1	11.05	vertical	-49.1	-13.0	36.1	315
3	5722.8	-56.43	5.42	12.65	vertical	-49.2	-13.0	36.2	225
4	7630.4	-53.45	6.7	13.85	vertical	-46.3	-13.0	33.3	180
5	9538.0	-57.94	7.01	14.75	vertical	-50.2	-13.0	37.2	90
6	11445.6	-56.57	7.48	15.95	vertical	-48.1	-13.0	35.1	270
7	13353.2	-57.54	7.51	16.55	vertical	-48.5	-13.0	35.5	45
8	15260.8	-51.01	8.24	15.35	vertical	-43.9	-13.0	30.9	225
9	17168.4	-51.74	8.41	14.95	vertical	-45.2	-13.0	32.2	45
10	19076.0	-49.11	8.54	15.45	vertical	-42.2	-13.0	29.2	315

Note: 1.The other Spurious RF Radiated emissions level is no more than noise floor.

2.The worst emission was found in the antenna is vertical position.



LTE Band 2 1.4MHz CH-Low

Harmonic	Frequency (MHz)	SG (dBm)	Cable Loss (dB)	Gain (dBi)	Antenna Polarization	EIRP Level (dBm)	Limit (dBm)	Margin (dB)	Azimuth (deg)
2	3701.4	-49.05	5.1	11.05	vertical	-43.1	-13.0	30.1	45
3	5550.8	-54.63	5.42	12.65	vertical	-47.4	-13.0	34.4	225
4	7401.0	-45.35	6.7	13.85	vertical	-38.2	-13.0	25.2	270
5	9253.5	-55.34	7.01	14.75	vertical	-47.6	-13.0	34.6	90
6	11104.2	-56.67	7.48	15.95	vertical	-48.2	-13.0	35.2	45
7	12954.9	-57.84	7.51	16.55	vertical	-48.8	-13.0	35.8	45
8	14805.6	-53.71	8.24	15.35	vertical	-46.6	-13.0	33.6	225
9	16656.3	-52.14	8.41	14.95	vertical	-45.6	-13.0	32.6	270
10	18507.0	-59.10	8.54	15.45	vertical	-52.2	-13.0	39.2	180

Note: 1.The other Spurious RF Radiated emissions level is no more than noise floor.
2.The worst emission was found in the antenna is vertical position.

LTE Band 2 1.4MHz CH-Middle

Harmonic	Frequency (MHz)	SG (dBm)	Cable Loss (dB)	Gain (dBi)	Antenna Polarization	EIRP Level (dBm)	Limit (dBm)	Margin (dB)	Azimuth (deg)
2	3755.6	-49.15	5.10	11.05	vertical	-43.2	-13.0	30.2	225
3	5634.0	-48.93	5.42	12.65	vertical	-41.7	-13.0	28.7	270
4	7511.6	-49.55	6.70	13.85	vertical	-42.4	-13.0	29.4	90
5	9400.0	-54.64	7.01	14.75	vertical	-46.9	-13.0	33.9	225
6	11280.0	-55.67	7.48	15.95	vertical	-47.2	-13.0	34.2	270
7	13160.0	-55.54	7.51	16.55	vertical	-46.5	-13.0	33.5	90
8	15040.0	-53.31	8.24	15.35	vertical	-46.2	-13.0	33.2	45
9	16920.0	-52.04	8.41	14.95	vertical	-45.5	-13.0	32.5	90
10	18800.0	-62.11	8.54	15.45	vertical	-55.2	-13.0	42.2	225

Note: 1.The other Spurious RF Radiated emissions level is no more than noise floor.
2.The worst emission was found in the antenna is vertical position.



LTE Band 2 1.4MHz CH-High

Harmonic	Frequency (MHz)	SG (dBm)	Cable Loss (dB)	Gain (dBi)	Antenna Polarization	EIRP Level (dBm)	Limit (dBm)	Margin (dB)	Azimuth (deg)
2	3817.5	-49.15	5.10	11.05	vertical	-43.2	-13.0	30.2	270
3	5726.6	-48.93	5.42	12.65	vertical	-41.7	-13.0	28.7	90
4	7635.8	-49.55	6.70	13.85	vertical	-42.4	-13.0	29.4	45
5	9546.5	-54.64	7.01	14.75	vertical	-46.9	-13.0	33.9	45
6	11455.8	-55.67	7.48	15.95	vertical	-47.2	-13.0	34.2	225
7	13365.1	-55.54	7.51	16.55	vertical	-46.5	-13.0	33.5	270
8	15274.4	-53.31	8.24	15.35	vertical	-46.2	-13.0	33.2	90
9	17183.7	-52.04	8.41	14.95	vertical	-45.5	-13.0	32.5	45
10	19093.0	-59.29	8.54	15.45	vertical	-52.4	-13.0	39.4	180

Note: 1.The other Spurious RF Radiated emissions level is no more than noise floor.
2.The worst emission was found in the antenna is vertical position.

LTE Band 2 3MHz CH-Low

Harmonic	Frequency (MHz)	SG (dBm)	Cable Loss (dB)	Gain (dBi)	Antenna Polarization	EIRP Level (dBm)	Limit (dBm)	Margin (dB)	Azimuth (deg)
2	3700.5	-47.55	5.10	11.05	vertical	-41.6	-13.0	28.6	45
3	5551.1	-54.43	5.42	12.65	vertical	-47.2	-13.0	34.2	225
4	7401.0	-44.85	6.70	13.85	vertical	-37.7	-13.0	24.7	270
5	9257.5	-54.54	7.01	14.75	vertical	-46.8	-13.0	33.8	90
6	11109.0	-56.57	7.48	15.95	vertical	-48.1	-13.0	35.1	45
7	12960.5	-54.74	7.51	16.55	vertical	-45.7	-13.0	32.7	45
8	14812.0	-53.41	8.24	15.35	vertical	-46.3	-13.0	33.3	90
9	16663.5	-52.04	8.41	14.95	vertical	-45.5	-13.0	32.5	45
10	18515.0	-60.89	8.54	15.45	vertical	-54.0	-13.0	41.0	0

Note: 1.The other Spurious RF Radiated emissions level is no more than noise floor.
2.The worst emission was found in the antenna is vertical position.



LTE Band 2 3MHz CH-Middle

Harmonic	Frequency (MHz)	SG (dBm)	Cable Loss (dB)	Gain (dBi)	Antenna Polarization	EIRP Level (dBm)	Limit (dBm)	Margin (dB)	Azimuth (deg)
2	3757.5	-53.25	5.10	11.05	vertical	-47.3	-13.0	34.3	270
3	5636.3	-56.83	5.42	12.65	vertical	-49.6	-13.0	36.6	90
4	7515.4	-53.85	6.70	13.85	vertical	-46.7	-13.0	33.7	45
5	9400.0	-54.04	7.01	14.75	vertical	-46.3	-13.0	33.3	45
6	11280.0	-55.97	7.48	15.95	vertical	-47.5	-13.0	34.5	225
7	13160.0	-55.74	7.51	16.55	vertical	-46.7	-13.0	33.7	270
8	15040.0	-52.31	8.24	15.35	vertical	-45.2	-13.0	32.2	90
9	16920.0	-50.64	8.41	14.95	vertical	-44.1	-13.0	31.1	225
10	18800.0	-59.42	8.54	15.45	vertical	-52.5	-13.0	39.5	270

Note: 1.The other Spurious RF Radiated emissions level is no more than noise floor.
2.The worst emission was found in the antenna is vertical position.

LTE Band 2 3MHz CH-High

Harmonic	Frequency (MHz)	SG (dBm)	Cable Loss (dB)	Gain (dBi)	Antenna Polarization	EIRP Level (dBm)	Limit (dBm)	Margin (dB)	Azimuth (deg)
2	3814.1	-50.65	5.10	11.05	vertical	-44.7	-13.0	31.7	45
3	5721.8	-49.63	5.42	12.65	vertical	-42.4	-13.0	29.4	225
4	7629.4	-52.35	6.70	13.85	vertical	-45.2	-13.0	32.2	270
5	9542.5	-55.24	7.01	14.75	vertical	-47.5	-13.0	34.5	90
6	11451.0	-56.77	7.48	15.95	vertical	-48.3	-13.0	35.3	45
7	13359.5	-56.54	7.51	16.55	vertical	-47.5	-13.0	34.5	45
8	15268.0	-53.71	8.24	15.35	vertical	-46.6	-13.0	33.6	225
9	17176.5	-51.44	8.41	14.95	vertical	-44.9	-13.0	31.9	270
10	19085.0	-60.11	8.54	15.45	vertical	-53.2	-13.0	40.2	90

Note: 1.The other Spurious RF Radiated emissions level is no more than noise floor.
2.The worst emission was found in the antenna is vertical position.

LTE Band 2 5MHz CH-Low

Harmonic	Frequency (MHz)	SG (dBm)	Cable Loss (dB)	Gain (dBi)	Antenna Polarization	EIRP Level (dBm)	Limit (dBm)	Margin (dB)	Azimuth (deg)
2	3700.5	-47.95	5.10	11.05	vertical	-42.0	-13.0	29.0	45
3	5551.5	-55.53	5.42	12.65	vertical	-48.3	-13.0	35.3	135
4	7401.4	-45.15	6.70	13.85	vertical	-38.0	-13.0	25.0	45
5	9262.5	-54.94	7.01	14.75	vertical	-47.2	-13.0	34.2	225
6	11115.0	-55.87	7.48	15.95	vertical	-47.4	-13.0	34.4	270
7	12967.5	-57.74	7.51	16.55	vertical	-48.7	-13.0	35.7	90
8	14820.0	-53.31	8.24	15.35	vertical	-46.2	-13.0	33.2	45
9	16672.5	-50.34	8.41	14.95	vertical	-43.8	-13.0	30.8	45
10	18525.0	-59.74	8.54	15.45	vertical	-52.8	-13.0	39.8	180

Note: 1.The other Spurious RF Radiated emissions level is no more than noise floor.
 2.The worst emission was found in the antenna is vertical position.

LTE Band 2 5MHz CH-Middle

Harmonic	Frequency (MHz)	SG (dBm)	Cable Loss (dB)	Gain (dBi)	Antenna Polarization	EIRP Level (dBm)	Limit (dBm)	Margin (dB)	Azimuth (deg)
2	3755.6	-53.05	5.10	11.05	vertical	-47.1	-13.0	34.1	270
3	5634.0	-48.33	5.42	12.65	vertical	-41.1	-13.0	28.1	225
4	7511.6	-49.45	6.70	13.85	vertical	-42.3	-13.0	29.3	45
5	9400.0	-55.44	7.01	14.75	vertical	-47.7	-13.0	34.7	135
6	11280.0	-57.17	7.48	15.95	vertical	-48.7	-13.0	35.7	45
7	13160.0	-56.64	7.51	16.55	vertical	-47.6	-13.0	34.6	225
8	15040.0	-53.81	8.24	15.35	vertical	-46.7	-13.0	33.7	270
9	16920.0	-51.24	8.41	14.95	vertical	-44.7	-13.0	31.7	90
10	18800.0	-62.19	8.54	15.45	vertical	-55.3	-13.0	42.3	180

Note: 1.The other Spurious RF Radiated emissions level is no more than noise floor.
 2.The worst emission was found in the antenna is vertical position.



LTE Band 2 5MHz CH-High

Harmonic	Frequency (MHz)	SG (dBm)	Cable Loss (dB)	Gain (dBi)	Antenna Polarization	EIRP Level (dBm)	Limit (dBm)	Margin (dB)	Azimuth (deg)
2	3810.4	-53.65	5.10	11.05	vertical	-47.7	-13.0	34.7	225
3	5716.1	-48.33	5.42	12.65	vertical	-41.1	-13.0	28.1	270
4	7621.1	-49.95	6.70	13.85	vertical	-42.8	-13.0	29.8	90
5	9537.5	-55.44	7.01	14.75	vertical	-47.7	-13.0	34.7	45
6	11445.0	-56.77	7.48	15.95	vertical	-48.3	-13.0	35.3	0
7	13352.5	-56.64	7.51	16.55	vertical	-47.6	-13.0	34.6	90
8	15260.0	-53.81	8.24	15.35	vertical	-46.7	-13.0	33.7	135
9	17167.5	-51.34	8.41	14.95	vertical	-44.8	-13.0	31.8	270
10	19075.0	-64.78	8.54	15.45	vertical	-57.9	-13.0	44.9	270

Note: 1.The other Spurious RF Radiated emissions level is no more than noise floor.
2.The worst emission was found in the antenna is vertical position.

LTE Band 2 10MHz CH-Low

Harmonic	Frequency (MHz)	SG (dBm)	Cable Loss (dB)	Gain (dBi)	Antenna Polarization	EIRP Level (dBm)	Limit (dBm)	Margin (dB)	Azimuth (deg)
2	3701.3	-59.65	5.10	11.05	vertical	-44.1	-13.0	31.1	270
3	5551.5	-55.62	5.42	12.65	vertical	-48.1	-13.0	35.1	90
4	7402.1	-63.62	6.70	13.85	vertical	-42.4	-13.0	29.4	225
5	9275.0	-59.73	7.01	14.75	vertical	-45.0	-13.0	32.0	270
6	11130.0	-71.03	7.48	15.95	vertical	-48.3	-13.0	35.3	90
7	12985.0	-67.90	7.51	16.55	vertical	-47.8	-13.0	34.8	225
8	14840.0	-64.28	8.24	15.35	vertical	-47.4	-13.0	34.4	270
9	16695.0	-60.86	8.41	14.95	vertical	-46.9	-13.0	33.9	90
10	18550.0	-62.77	8.54	15.45	vertical	-55.9	-13.0	42.9	135

Note: 1.The other Spurious RF Radiated emissions level is no more than noise floor.
2.The worst emission was found in the antenna is vertical position.



LTE Band 2 10MHz CH-Middle

Harmonic	Frequency (MHz)	SG (dBm)	Cable Loss (dB)	Gain (dBi)	Antenna Polarization	EIRP Level (dBm)	Limit (dBm)	Margin (dB)	Azimuth (deg)
2	3751.1	-50.25	5.10	11.05	vertical	-44.3	-13.0	31.3	270
3	5626.9	-49.73	5.42	12.65	vertical	-42.5	-13.0	29.5	90
4	7503.0	-52.05	6.70	13.85	vertical	-44.9	-13.0	31.9	45
5	9400.0	-56.04	7.01	14.75	vertical	-48.3	-13.0	35.3	45
6	11280.0	-56.27	7.48	15.95	vertical	-47.8	-13.0	34.8	225
7	13160.0	-56.44	7.51	16.55	vertical	-47.4	-13.0	34.4	270
8	15040.0	-53.91	8.24	15.35	vertical	-46.8	-13.0	33.8	90
9	16920.0	-51.84	8.41	14.95	vertical	-45.3	-13.0	32.3	225
10	18800.0	-61.16	8.54	15.45	vertical	-54.3	-13.0	41.3	135

Note: 1.The other Spurious RF Radiated emissions level is no more than noise floor.
2.The worst emission was found in the antenna is vertical position.

LTE Band 2 10MHz CH-High

Harmonic	Frequency (MHz)	SG (dBm)	Cable Loss (dB)	Gain (dBi)	Antenna Polarization	EIRP Level (dBm)	Limit (dBm)	Margin (dB)	Azimuth (deg)
2	3801.0	-50.85	5.10	11.05	vertical	-44.9	-13.0	31.9	270
3	5701.9	-50.23	5.42	12.65	vertical	-43.0	-13.0	30.0	225
4	7602.4	-49.55	6.70	13.85	vertical	-42.4	-13.0	29.4	45
5	9525.0	-55.44	7.01	14.75	vertical	-47.7	-13.0	34.7	135
6	11430.0	-57.17	7.48	15.95	vertical	-48.7	-13.0	35.7	45
7	13335.0	-56.84	7.51	16.55	vertical	-47.8	-13.0	34.8	225
8	15240.0	-54.31	8.24	15.35	vertical	-47.2	-13.0	34.2	270
9	17145.0	-50.84	8.41	14.95	vertical	-44.3	-13.0	31.3	90
10	19050.0	-65.14	8.54	15.45	vertical	-58.2	-13.0	45.2	45

Note: 1.The other Spurious RF Radiated emissions level is no more than noise floor.
2.The worst emission was found in the antenna is vertical position.



LTE Band 2 15MHz CH-Low

Harmonic	Frequency (MHz)	SG (dBm)	Cable Loss (dB)	Gain (dBi)	Antenna Polarization	EIRP Level (dBm)	Limit (dBm)	Margin (dB)	Azimuth (deg)
2	3701.6	-50.25	5.10	11.05	vertical	-44.3	-13.0	31.3	90
3	5552.6	-54.33	5.42	12.65	vertical	-47.1	-13.0	34.1	45
4	7403.3	-44.95	6.70	13.85	vertical	-37.8	-13.0	24.8	0
5	9287.5	-55.44	7.01	14.75	vertical	-47.7	-13.0	34.7	90
6	11145.0	-57.17	7.48	15.95	vertical	-48.7	-13.0	35.7	135
7	13002.5	-56.64	7.51	16.55	vertical	-47.6	-13.0	34.6	270
8	14860.0	-54.31	8.24	15.35	vertical	-47.2	-13.0	34.2	225
9	16717.5	-50.84	8.41	14.95	vertical	-44.3	-13.0	31.3	45
10	18575.0	-63.20	8.54	15.45	vertical	-56.3	-13.0	43.3	180

Note: 1.The other Spurious RF Radiated emissions level is no more than noise floor.
2.The worst emission was found in the antenna is vertical position.

LTE Band 2 15MHz CH-Middle

Harmonic	Frequency (MHz)	SG (dBm)	Cable Loss (dB)	Gain (dBi)	Antenna Polarization	EIRP Level (dBm)	Limit (dBm)	Margin (dB)	Azimuth (deg)
2	3746.6	-50.85	5.10	11.05	vertical	-44.9	-13.0	31.9	225
3	5620.1	-50.23	5.42	12.65	vertical	-43.0	-13.0	30.0	270
4	7493.3	-49.55	6.70	13.85	vertical	-42.4	-13.0	29.4	90
5	9400.0	-55.44	7.01	14.75	vertical	-47.7	-13.0	34.7	225
6	11280.0	-57.17	7.48	15.95	vertical	-48.7	-13.0	35.7	270
7	13160.0	-56.84	7.51	16.55	vertical	-47.8	-13.0	34.8	90
8	15040.0	-54.31	8.24	15.35	vertical	-47.2	-13.0	34.2	45
9	16920.0	-50.84	8.41	14.95	vertical	-44.3	-13.0	31.3	0
10	18800.0	-61.53	8.54	15.45	vertical	-54.6	-13.0	41.6	270

Note: 1.The other Spurious RF Radiated emissions level is no more than noise floor.
2.The worst emission was found in the antenna is vertical position.



LTE Band 2 15MHz CH-High

Harmonic	Frequency (MHz)	SG (dBm)	Cable Loss (dB)	Gain (dBi)	Antenna Polarization	EIRP Level (dBm)	Limit (dBm)	Margin (dB)	Azimuth (deg)
2	3791.6	-50.85	5.10	11.05	vertical	-44.9	-13.0	31.9	45
3	5687.6	-50.23	5.42	12.65	vertical	-43.0	-13.0	30.0	45
4	7582.9	-49.55	6.70	13.85	vertical	-42.4	-13.0	29.4	225
5	9512.5	-55.44	7.01	14.75	vertical	-47.7	-13.0	34.7	270
6	11415.0	-57.17	7.48	15.95	vertical	-48.7	-13.0	35.7	90
7	13317.5	-56.84	7.51	16.55	vertical	-47.8	-13.0	34.8	225
8	15220.0	-54.31	8.24	15.35	vertical	-47.2	-13.0	34.2	270
9	17122.5	-50.84	8.41	14.95	vertical	-44.3	-13.0	31.3	90
10	19025.0	-65.15	8.54	15.45	vertical	-58.2	-13.0	45.2	90

Note: 1.The other Spurious RF Radiated emissions level is no more than noise floor.
2.The worst emission was found in the antenna is vertical position.

LTE Band 2 20MHz CH-Low

Harmonic	Frequency (MHz)	SG (dBm)	Cable Loss (dB)	Gain (dBi)	Antenna Polarization	EIRP Level (dBm)	Limit (dBm)	Margin (dB)	Azimuth (deg)
2	3702.0	-50.85	5.10	11.05	vertical	-44.9	-13.0	31.9	135
3	5553.4	-55.23	5.42	12.65	vertical	-48.0	-13.0	35.0	45
4	7404.4	-54.55	6.70	13.85	vertical	-47.4	-13.0	34.4	225
5	9300.0	-55.44	7.01	14.75	vertical	-47.7	-13.0	34.7	270
6	11160.0	-57.17	7.48	15.95	vertical	-48.7	-13.0	35.7	90
7	13020.0	-56.64	7.51	16.55	vertical	-47.6	-13.0	34.6	45
8	14880.0	-54.31	8.24	15.35	vertical	-47.2	-13.0	34.2	45
9	16740.0	-50.84	8.41	14.95	vertical	-44.3	-13.0	31.3	225
10	18600.0	-60.17	8.54	15.45	vertical	-53.3	-13.0	40.3	90

Note: 1.The other Spurious RF Radiated emissions level is no more than noise floor.
2.The worst emission was found in the antenna is vertical position.



LTE Band 2 20MHz CH-Middle

Harmonic	Frequency (MHz)	SG (dBm)	Cable Loss (dB)	Gain (dBi)	Antenna Polarization	EIRP Level (dBm)	Limit (dBm)	Margin (dB)	Azimuth (deg)
2	3742.1	-50.85	5.10	11.05	vertical	-44.9	-13.0	31.9	270
3	5613.4	-55.23	5.42	12.65	vertical	-48.0	-13.0	35.0	90
4	7483.9	-54.55	6.70	13.85	vertical	-47.4	-13.0	34.4	225
5	9400.0	-55.44	7.01	14.75	vertical	-47.7	-13.0	34.7	270
6	11280.0	-57.17	7.48	15.95	vertical	-48.7	-13.0	35.7	90
7	13160.0	-56.64	7.51	16.55	vertical	-47.6	-13.0	34.6	45
8	15040.0	-54.31	8.24	15.35	vertical	-47.2	-13.0	34.2	0
9	16920.0	-50.84	8.41	14.95	vertical	-44.3	-13.0	31.3	90
10	18800.0	-62.60	8.54	15.45	vertical	-55.7	-13.0	42.7	0

Note: 1.The other Spurious RF Radiated emissions level is no more than noise floor.
2.The worst emission was found in the antenna is vertical position.

LTE Band 2 20MHz CH-High

Harmonic	Frequency (MHz)	SG (dBm)	Cable Loss (dB)	Gain (dBi)	Antenna Polarization	EIRP Level (dBm)	Limit (dBm)	Margin (dB)	Azimuth (deg)
2	3782.3	-50.85	5.10	11.05	vertical	-44.9	-13.0	31.9	45
3	5673.4	-55.23	5.42	12.65	vertical	-48.0	-13.0	35.0	225
4	7564.5	-54.55	6.70	13.85	vertical	-47.4	-13.0	34.4	270
5	9500.0	-55.44	7.01	14.75	vertical	-47.7	-13.0	34.7	90
6	11400.0	-57.17	7.48	15.95	vertical	-48.7	-13.0	35.7	225
7	13300.0	-56.64	7.51	16.55	vertical	-47.6	-13.0	34.6	270
8	15200.0	-54.31	8.24	15.35	vertical	-47.2	-13.0	34.2	90
9	17100.0	-50.84	8.41	14.95	vertical	-44.3	-13.0	31.3	225
10	19000.0	-60.54	8.54	15.45	vertical	-53.6	-13.0	40.6	180

Note: 1.The other Spurious RF Radiated emissions level is no more than noise floor.
2.The worst emission was found in the antenna is vertical position.

6. Main Test Instruments

Name	Manufacturer	Type	Serial Number	Calibration Date	Expiration Time
Base Station Simulator	R&S	CMW500	113645	2017-05-14	2018-05-13
Power Splitter	Hua Xiang	SHX-GF2-2-13	10120101	2017-05-14	2018-05-13
Spectrum Analyzer	Agilent	N9010A	MY47191109	2017-05-20	2018-05-19
Universal Radio Communication Tester	Agilent	E5515C	MY48367192	2017-05-20	2018-05-19
Signal Analyzer	R&S	FSV30	100815	2016-12-16	2017-12-15
EMI Test Receiver	R&S	ESCI	100948	2017-05-20	2018-05-19
Signal generator	R&S	SMB 100A	102594	2017-05-14	2018-05-13
Signal generator	R&S	SMR27	100365	2017-05-14	2018-05-13
Trilog Antenna	SCHWARZBECK	VUBL 9163	9163-201	2014-12-06	2017-12-05
Horn Antenna	R&S	HF907	100126	2014-12-06	2017-12-05
Climatic Chamber	Re Ce	PT-30B	20101891	2015-07-18	2018-07-17
Horn Antenna	ETS-Lindgren	3160-09	00102644	2015-01-30	2018-01-29
RF Cable	Agilent	SMA 15cm	0001	2017-08-04	2018-02-03
Preampflier	R&S	SCU18	102327	2017-06-18	2018-06-17

*****END OF REPORT *****

ANNEX A: EUT Appearance and Test Setup

A.1 EUT Appearance



a: EUT



b: Adapter



c: Earphone

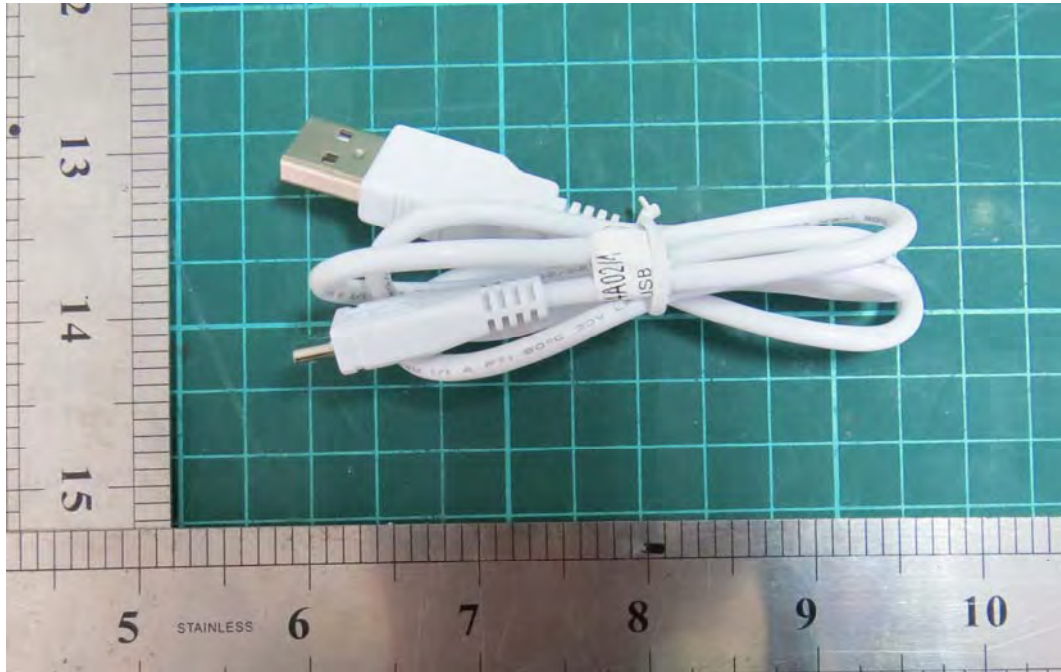

d: USB Cable

Picture 1 EUT and Accessory

A.2 Test Setup

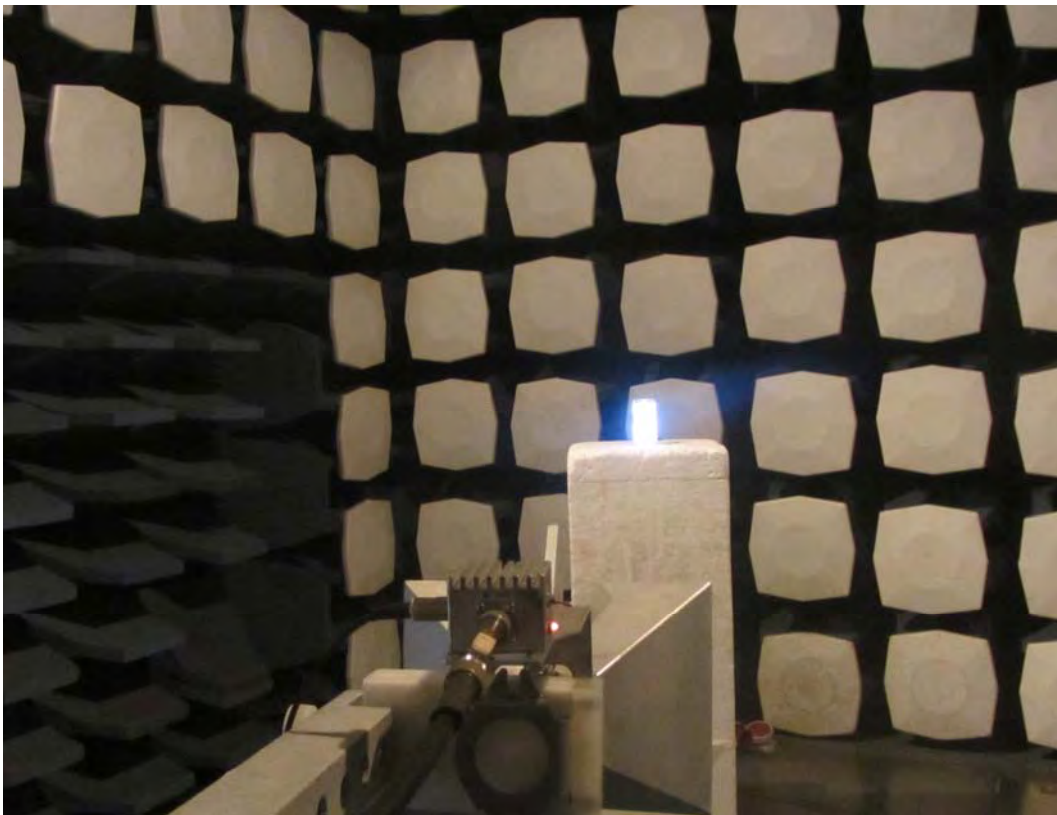
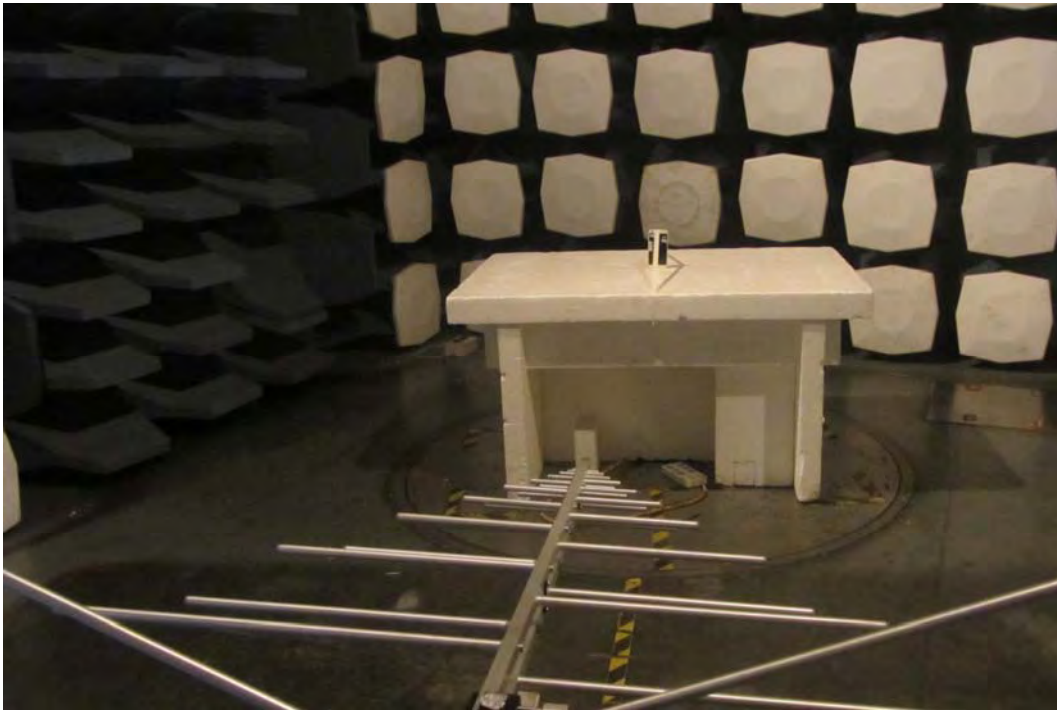

Picture 2: Radiated Spurious Emissions Test setup