



RF TEST REPORT

Applicant ZTE Corporation
FCC ID SRQ-BLADEV9
Product LTE/WCDMA/GSM (GPRS)
Multi-Mode Digital Mobile Phone
Model ZTE BLADE V9/ZTE BLADE V0901
Report No. R1803A0088-R2
Issue Date April 13, 2018

TA Technology (Shanghai) Co., Ltd. tested the above equipment in accordance with the requirements in **FCC CFR47 Part 2 (2017)/ FCC CFR 47 Part 24E (2017)**. The test results show that the equipment tested is capable of demonstrating compliance with the requirements as documented in this report.

Jiang peng Lan

Performed by: Jiangpeng Lan

Kai Xu

Approved by: Kai Xu

TA Technology (Shanghai) Co., Ltd.

No.145, Jintang Rd, Tangzhen Industry Park, Pudong Shanghai, China

TEL: +86-021-50791141/2/3

FAX: +86-021-50791141/2/3-8000



TABLE OF CONTENT

1. Test Laboratory	4
1.1. Notes of the test report.....	4
1.2. Test facility.....	4
1.3. Testing Location	5
2. General Description of Equipment under Test.....	6
3. Applied Standards.....	8
4. Test Configuration.....	9
5. Test Case Results.....	11
5.1. RF Power Output.....	11
5.2. Effective Isotropic Radiated Power	16
5.3. Occupied Bandwidth	20
5.4. Band Edge Compliance.....	31
5.5. Peak-to-Average Power Ratio (PAPR)	42
5.6. Frequency Stability	45
5.7. Spurious Emissions at Antenna Terminals	50
5.8. Radiates Spurious Emission	62
6. Main Test Instruments	76

Summary of measurement results

No.	Test Case	Clause in FCC rules	Verdict
1	RF power output	2.1046	PASS
2	Effective Isotropic Radiated power	24.232(c)	PASS
3	Occupied Bandwidth	2.1049	PASS
4	Band Edge Compliance	2.1051 /24.238(a)	PASS
5	Peak-to-Average Power Ratio	24.232/KDB 971168 D01(5.7)	PASS
6	Frequency Stability	2.1055 / 24.235	PASS
7	Spurious Emissions at Antenna Terminals	2.1051 / 24.238(a)	PASS
8	Radiates Spurious Emission	2.1053 / 24.238(a)	PASS
Date of Testing: December 11, 2017 ~ January 2, 2018			
Note: PASS: The EUT complies with the essential requirements in the standard. FAIL: The EUT does not comply with the essential requirements in the standard.			

1. Test Laboratory

1.1. Notes of the test report

This report shall not be reproduced in full or partial, without the written approval of **TA technology (shanghai) co., Ltd.** The results documented in this report apply only to the tested sample, under the conditions and modes of operation as described herein. Measurement Uncertainties were not taken into account and are published for informational purposes only. This report is written to support regulatory compliance of the applicable standards stated above.

1.2. Test facility

CNAS (accreditation number: L2264)

TA Technology (Shanghai) Co., Ltd. has obtained the accreditation of China National Accreditation Service for Conformity Assessment (CNAS).

FCC (Designation number: CN1179, Test Firm Registration Number: 446626)

TA Technology (Shanghai) Co., Ltd. has been listed on the US Federal Communications Commission list of test facilities recognized to perform electromagnetic emissions measurements.

IC (recognition number is 8510A)

TA Technology (Shanghai) Co., Ltd. has been listed by industry Canada to perform electromagnetic emission measurement.

VCCI (recognition number is C-4595, T-2154, R-4113, G-10766)

TA Technology (Shanghai) Co., Ltd. has been listed by industry Japan to perform electromagnetic emission measurement.

A2LA (Certificate Number: 3857.01)

TA Technology (Shanghai) Co., Ltd. has been listed by American Association for Laboratory Accreditation to perform electromagnetic emission measurement.



1.3. Testing Location

Company: TA Technology (Shanghai) Co., Ltd.
Address: No.145, Jintang Rd, Tangzhen Industry Park, Pudong
City: Shanghai
Post code: 201201
Country: P. R. China
Contact: Xu Kai
Telephone: +86-021-50791141/2/3
Fax: +86-021-50791141/2/3-8000
Website: <http://www.ta-shanghai.com>
E-mail: xukai@ta-shanghai.com

2. General Description of Equipment under Test

Client Information

Applicant	ZTE Corporation
Applicant address	ZTE Plaza, Keji Road South, Hi-Tech, Industrial Park, Nanshan District, Shenzhen, Guangdong, 518057, P.R.China
Manufacturer	ZTE Corporation
Manufacturer address	ZTE Plaza, Keji Road South, Hi-Tech, Industrial Park, Nanshan District, Shenzhen, Guangdong, 518057, P.R.China

General information

EUT Description			
Model	ZTE BLADE V9/ZTE BLADE V0901		
IMEI	867098030002394		
Hardware Version	udxC		
Software Version	MVS_CL_V9_V1.1		
Flash	3+32		
Power Supply	Battery/AC adapter		
Antenna Type	Internal Antenna		
Test Mode(s)	GSM1900; WCDMA Band II; LTE Band 2;		
Test Modulation	(GSM)GMSK,8PSK; (WCDMA)QPSK; (LTE)QPSK,16QAM		
GPRS Multislot Class	33		
EGPRS Multislot Class	33		
HSDPA UE Category	24		
HSUPA UE Category	8		
LTE Category	6		
Maximum E.I.R.P	GSM 1900:	30.60dBm	
	WCDMA Band II:	21.86dBm	
	LTE Band 2:	19.51dBm	
Rated Power Supply Voltage	3.85V		
Extreme Voltage	Minimum: 3.4V Maximum: 4.4V		
Extreme Temperature	Lowest: -30°C Highest: +55°C		
Operating Frequency Range(s)	Band	Tx (MHz)	Rx (MHz)
	GSM1900	1850 ~ 1910	1930 ~ 1990
	WCDMA Band II	1850 ~ 1910	1930 ~ 1990
	LTE Band 2	1850 ~ 1910	1930 ~ 1990
EUT Accessory			
Adapter 1	Manufacturer: Salcomp (Shenzhen) Co., Ltd. Model: STC-A521A-Z		



Adapter 2	Manufacture: SHENZHEN RUIJING INDUSTRIAL CO LTD Model : STC-A521A-Z
Battery	Manufacturer: Zhongshan Tianmao Battery Co., Ltd Model: Li3931T44P8h806139
Earphone	Manufacturer: GoerTek Inc Model: HA3-6
USB Extend Cable 1	Manufacturer: LUXSHARE-ICT 100cm Cable, Shielded
USB Extend Cable 2	Manufacturer: kingpower-tech 100cm Cable, Shielded
Note: The information of the EUT is declared by the manufacturer.	



3. Applied Standards

According to the specifications of the manufacturer, it must comply with the requirements of the following standards:

FCC CFR47 Part 2 (2017)

FCC CFR 47 Part 24E (2017)

ANSI/TIA-603-E (2016)

KDB 971168 D01 Power Meas License Digital Systems v03

4. Test Configuration

Radiated measurements are performed by rotating the EUT in three different orthogonal test planes. EUT stand-up position (Z axis), lie-down position (X, Y axis). Receiver antenna polarization (horizontal and vertical), the worst emission was found in position (X axis, horizontal polarization) and the worst case was recorded.

All mode and data rates and positions and RB size and modulations were investigated.

Subsequently, only the worst case emissions are reported.

The following testing in GSM/WCDMA/LTE is set based on the maximum RF Output Power.

Test modes are chosen to be reported as the worst case configuration below:

	Test items	Modes/Modulation	
		GSM 1900	WCDMA Band II
Conducted Test cases	RF power output	GSM GPRS EGPRS	RMC HSDPA/HSUPA DC-HSDPA/HSPA+
	Occupied Bandwidth	GSM GPRS(1Tx slot) EGPRS(1Tx slot)	RMC
	Band Edge Compliance	GSM GPRS(1Tx slot) EGPRS(1Tx slot)	RMC
	Peak-to-Average Power Ratio	GSM GPRS(1Tx slot) EGPRS(1Tx slot)	RMC
	Frequency Stability	GSM GPRS(1Tx slot) EGPRS(1Tx slot)	RMC
	Spurious Emissions at Antenna Terminals	GSM	RMC
Radiated Test cases	Effective Isotropic Radiated power	GSM GPRS(1Tx slot) EGPRS(1Tx slot)	RMC
	Radiates Spurious Emission	GSM	RMC



Test modes are chosen to be reported as the worst case configuration below for LTE Band 2:

Test items	Bandwidth (MHz)						Modulation		RB			Test Channel		
	1.4	3	5	10	15	20	QPSK	16QAM	1	50%	100%	L	M	H
RF power output	O	O	O	O	O	O	O	O	O	O	O	O	O	O
Effective Isotropic Radiated power	O	O	O	O	O	O	O	O	-	-	O	O	O	O
Occupied Bandwidth	O	O	O	O	O	O	O	O	-	-	O	O	O	O
Band Edge Compliance	O	O	O	O	O	O	O	O	O	-	O	O	-	O
Peak-to-Average Power Ratio	O	O	O	O	O	O	O	O	-	-	O	O	O	O
Frequency Stability	O	O	O	O	O	O	O	O	-	-	O	-	O	-
Conducted Spurious Emissions	O	O	O	O	O	O	O	-	O	-	-	O	O	O
Radiates Spurious Emission	O	O	O	O	O	O	O	-	O	-	-	O	O	O
Note	1. The mark "O" means that this configuration is chosen for testing. 2. The mark "-" means that this configuration is not testing.													

5. Test Case Results

5.1. RF Power Output

Ambient condition

Temperature	Relative humidity	Pressure
23°C ~25°C	45%~50%	101.5kPa

Methods of Measurement

During the process of the testing, The EUT is controlled by the Base Station Simulator to ensure max power transmission and proper modulation.

Test Setup

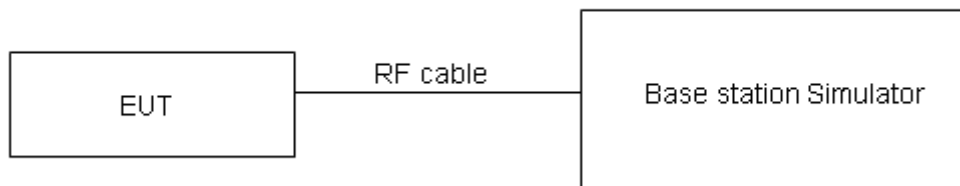

The loss between RF output port of the EUT and the input port of the tester has been taken into consideration.

Limits

No specific RF power output requirements in part 2.1046.

Measurement Uncertainty

The assessed measurement uncertainty to ensure 95% confidence level for the normal distribution is with the coverage factor $k = 2$, $U = 0.4$ dB.

Test Results

GSM 1900		Conducted Power(dBm)		
		Channel 512	Channel 661	Channel 810
		1850.2(MHz)	1880(MHz)	1909.8(MHz)
GSM	Results	30.13	29.76	30.03
GPRS (GMSK)	1TXslot	30.15	29.83	30.08
	2TXslots	27.69	27.63	27.71
	3TXslots	25.85	25.91	25.79
	4TXslots	23.88	23.72	23.82
EGPRS (GMSK)	1TXslot	30.13	29.80	30.06
	2TXslots	27.66	27.41	27.65
	3TXslots	25.80	25.84	25.67
	4TXslots	23.84	23.69	23.78
EGPRS (8PSK)	1TXslot	25.44	25.10	25.39
	2TXslots	24.08	23.61	23.91
	3TXslots	21.89	21.66	21.62
	4TXslots	19.74	19.36	19.47

WCDMA Band II		Conducted Power(dBm)		
		Channel 9262	Channel 9400	Channel 9538
		1852.4(MHz)	1880(MHz)	1907.6(MHz)
RMC		22.87	23.09	23.01
HSDPA	Sub - Test 1	21.96	21.98	22.22
	Sub - Test 2	21.97	21.96	22.17
	Sub - Test 3	21.48	21.44	21.36
	Sub - Test 4	21.50	21.43	21.44
HSUPA	Sub - Test 1	21.98	21.89	22.18
	Sub - Test 2	21.47	21.47	21.53
	Sub - Test 3	22.04	21.95	22.22
	Sub - Test 4	22.00	21.94	22.24
	Sub - Test 5	21.97	21.93	22.21
DC-HSDPA	Sub - Test 1	21.90	21.93	22.18
	Sub - Test 2	21.92	21.92	22.14
	Sub - Test 3	21.46	21.40	21.35
	Sub - Test 4	21.47	21.37	21.42
HSPA+	16QAM	20.76	21.04	20.85

LTE Band 2				Conducted Power(dBm)		
Bandwidth	Modulation	RB size	RB offset	Channel/Frequency (MHz)		
				18607/1850.7	18900/1880	19193/1909.3
1.4MHz	QPSK	1	0	22.99	23.17	23.12
		1	2	22.88	23.08	23.11
		1	5	22.66	22.80	22.77
		3	0	22.89	22.95	23.11
		3	2	22.88	23.02	23.14
		3	3	22.85	22.90	22.94
		6	0	21.98	22.14	22.11
	16QAM	1	0	22.10	22.23	22.09
		1	2	22.11	22.13	22.12
		1	5	21.82	21.97	21.84
		3	0	21.90	21.81	22.07
		3	2	21.88	21.99	22.11
		3	3	21.79	21.90	21.84
		6	0	20.86	21.02	21.22
Bandwidth	Modulation	RB size	RB offset	Channel/Frequency (MHz)		
				18615/1851.5	18900/1880	19185/1908.5
3MHz	QPSK	1	0	23.01	23.21	23.15
		1	7	22.91	23.13	23.15
		1	14	22.69	22.85	22.81
		8	0	21.99	22.07	22.24
		8	4	22.00	22.12	22.26
		8	7	21.95	22.01	22.04
		15	0	22.01	22.18	22.14
	16QAM	1	0	22.13	22.25	22.12
		1	7	22.14	22.18	22.16
		1	14	21.84	22.01	21.87
		8	0	21.01	20.94	21.19
		8	4	20.99	21.12	21.23
		8	7	20.89	21.02	20.97
		15	0	20.89	21.06	21.25
Bandwidth	Modulation	RB size	RB offset	Channel/Frequency (MHz)		
				18625/1852.5	18900/1880	19175/1907.5
5MHz	QPSK	1	0	22.98	23.19	23.11
		1	13	22.89	23.09	23.12
		1	24	22.66	22.80	22.77
		12	0	21.96	22.02	22.20



	16QAM	12	6	21.98	22.08	22.21
		12	13	21.93	21.99	22.00
		25	0	21.99	22.17	22.12
		1	0	22.10	22.21	22.09
		1	13	22.11	22.16	22.13
		1	24	21.81	21.99	21.83
		12	0	20.99	20.90	21.16
		12	6	20.96	21.07	21.19
		12	13	20.86	20.97	20.93
		25	0	20.87	21.02	21.20
Bandwidth	Modulation	RB size	RB offset	Channel/Frequency (MHz)		
				18650/1855	18900/1880	19150/1905
10MHz	QPSK	1	0	23.00	23.20	23.14
		1	25	22.92	23.14	23.16
		1	49	22.68	22.84	22.80
		25	0	21.99	22.07	22.24
		25	13	22.01	22.13	22.25
		25	25	21.95	22.03	22.05
		50	0	22.07	22.19	22.16
	16QAM	1	0	22.12	22.24	22.11
		1	25	22.14	22.20	22.16
		1	49	21.84	22.01	21.86
		25	0	21.02	20.95	21.20
		25	13	20.98	21.11	21.22
		25	25	20.89	21.02	20.97
		50	0	20.90	21.07	21.24
Bandwidth	Modulation	RB size	RB offset	Channel/Frequency (MHz)		
				18675/1857.5	18900/1880	19125/1902.5
15MHz	QPSK	1	0	22.99	23.16	23.12
		1	38	22.90	23.13	23.13
		1	74	22.65	22.79	22.76
		36	0	21.97	22.03	22.21
		36	18	21.98	22.08	22.21
		36	39	21.92	22.00	22.01
		75	0	22.05	22.15	22.11
	16QAM	1	0	22.07	22.22	22.09
		1	38	22.12	22.17	22.14
		1	74	21.81	21.97	21.83
		36	0	20.99	20.93	21.17
		36	18	20.95	21.06	21.18



Bandwidth	Modulation	RB size	RB offset	Channel/Frequency (MHz)		
				18700/1860	18900/1880	19100/1900
		36	39	20.87	20.98	20.94
		75	0	20.87	21.02	21.20
20MHz	QPSK	1	0	22.96	23.12	23.09
		1	50	22.89	23.09	23.11
		1	99	22.63	22.78	22.73
		50	0	21.94	21.98	22.17
		50	25	21.96	22.04	22.18
		50	50	21.89	21.95	21.97
		100	0	22.02	22.10	22.07
	16QAM	1	0	22.05	22.18	22.04
		1	50	22.08	22.15	22.10
		1	99	21.79	21.94	21.81
		50	0	20.96	20.89	21.14
		50	25	20.92	21.04	21.15
		50	50	20.84	20.93	20.90
		100	0	20.85	20.98	21.17

5.2. Effective Isotropic Radiated Power

Ambient condition

Temperature	Relative humidity	Pressure
23°C ~25°C	45%~50%	101.5kPa

Methods of Measurement

The testing follows FCC KDB 971168 v03 Section 5.8 and ANSI/TIA-603-E (2016).

- a) Connect the equipment as illustrated. Mount the equipment with the manufacturer specified antenna in a vertical orientation on a manufacturer specified mounting surface located on a non-conducting rotating platform of a RF anechoic chamber (preferred) or a standard radiation site.
- b) Key the transmitter, then rotate the EUT 360° azimuthally and record spectrum analyzer power level (LVL) measurements at angular increments that are sufficiently small to permit resolution of all peaks. If a standard radiation test site is used, raise and lower the test antenna to obtain a maximum reading at each angular increment. (Note: several batteries may be needed to offset the effect of battery voltage droop, which should not exceed 5% of the manufactured specified battery voltage during transmission).
- c) Replace the transmitter under test with a vertically polarized half-wave dipole (or an antenna whose gain is known relative to an ideal half-wave dipole). The center of the antenna should be at the same location as the center of the antenna under test.
- d) Connect the antenna to a signal generator with a known output power and record the path loss (in dB) as LOSS. If a standard radiation test site is used, raise and lower the test antenna to obtain a maximum reading. $LOSS = \text{Generator Output Power (dBm)} - \text{Analyzer reading (dBm)}$
- e) Determine the effective radiated output power at each angular position from the readings in steps b) and d) using the following equation: $ERP \text{ (dBm)} = \text{LVL (dBm)} + \text{LOSS (dB)}$
- f) The maximum ERP is the maximum value determined in the preceding step.
- g) When calculating ERP, in addition to knowing the antenna radiation and matching characteristics, it is necessary to know the loss values of all elements (e.g. transmission line attenuation, mismatches, filters, combiners) interposed between the point where transmitter output power is measured, and the point where power is applied to the antenna. ERP can then be calculated as follows:
 $ERP \text{ (dBm)} = \text{Output Power (dBm)} - \text{Losses (dB)} + \text{Antenna Gain (dBd)}$
where: dBd refers to gain relative to an ideal dipole.
 $EIRP \text{ (dBm)} = ERP \text{ (dBm)} + 2.15 \text{ (dB)}$

Test setup

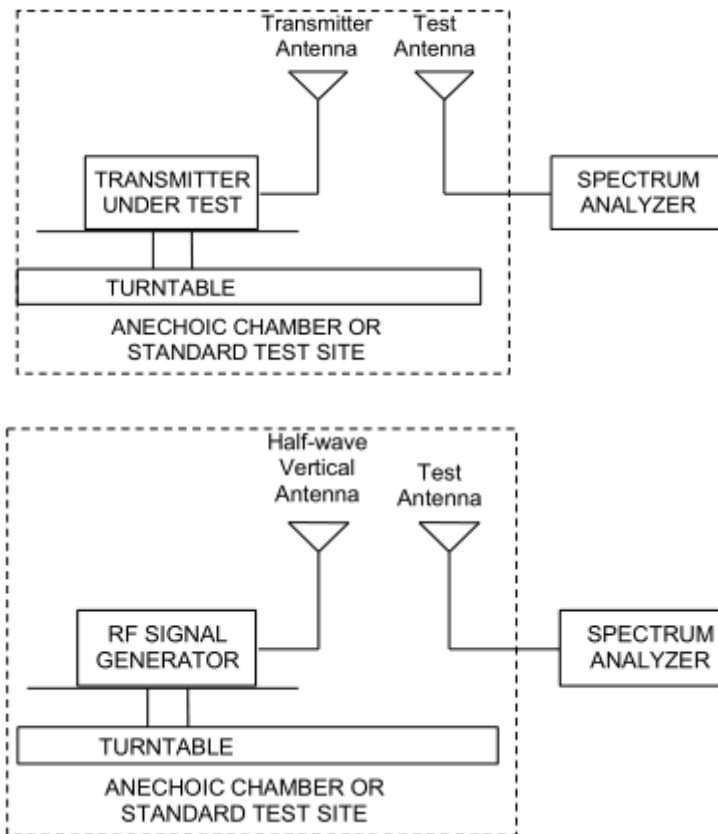

Limits

Rule Part 24.232(c) Mobile and portable stations are limited to 2 watts EIRP.

Rule Part 24.232(e) Peak transmit power must be measured over any interval of continuous transmission using instrumentation calibrated in terms of an rms-equivalent voltage.

Limit (EIRP)	$\leq 2\text{ W}$ (33 dBm)
--------------	----------------------------

Measurement Uncertainty

The assessed measurement uncertainty to ensure 95% confidence level for the normal distribution is with the coverage factor $k = 2$, $U = 1.19\text{ dB}$

**Test Results:**

The measurement is performed for both of horizontal and vertical antenna Polarization, and only the data of worst mode is recorded in this report.

Mode	Channel	Frequency (MHz)	Polarization	Output Power (dBm)	Losses (dB)	Antenna Gain (dBd)	EIRP (dBm)	Limit (dBm)	Conclusion
GSM 1900	Low	1850.2	Horizontal	-28.03	-53.21	1.92	27.10	33	Pass
	Mid	1880	Horizontal	-27.10	-53.42	1.94	28.26	33	Pass
	High	1909.8	Horizontal	-27.16	-53.67	1.90	28.41	33	Pass
GPRS 1900	Low	1850.2	Horizontal	-24.53	-53.21	1.92	30.60	33	Pass
	Mid	1880	Horizontal	-25.29	-53.42	1.94	30.07	33	Pass
	High	1909.8	Horizontal	-25.24	-53.67	1.90	30.33	33	Pass
EGPRS 1900	Low	1850.2	Horizontal	-24.66	-53.21	1.92	30.47	33	Pass
	Mid	1880	Horizontal	-25.41	-53.42	1.94	29.94	33	Pass
	High	1909.8	Horizontal	-25.36	-53.67	1.90	30.20	33	Pass
WCDMA Band II	Low	1852.4	Horizontal	-33.25	-53.19	1.92	21.86	33	Pass
	Mid	1880	Horizontal	-34.02	-53.42	1.94	21.34	33	Pass
	High	1907.6	Horizontal	-33.81	-53.66	1.92	21.77	33	Pass



LTE Band 2									
bandwidth	Channel	Frequency (MHz)	Polarization	Output Power (dBm)	Losses (dB)	Antenna Gain (dBd)	EIRP (dBm)	Limit (dBm)	Conclusion
1.4 MHz (QPSK)	Low	1850.7	Horizontal	-38.02	-54.89	1.90	18.76	33	Pass
	Mid	1880	Horizontal	-39.17	-56.66	1.92	19.41	33	Pass
	High	1909.3	Horizontal	-41.02	-58.09	1.91	18.98	33	Pass
3 MHz (QPSK)	Low	1851.5	Horizontal	-38.07	-54.93	1.91	18.76	33	Pass
	Mid	1880	Horizontal	-39.10	-56.66	1.94	19.51	33	Pass
	High	1908.5	Horizontal	-40.92	-58.08	1.91	19.08	33	Pass
5 MHz (QPSK)	Low	1852.5	Horizontal	-38.20	-55.14	1.92	18.86	33	Pass
	Mid	1880	Horizontal	-38.84	-56.41	1.94	19.51	33	Pass
	High	1907.5	Horizontal	-40.79	-57.97	1.90	19.08	33	Pass
10 MHz (QPSK)	Low	1855	Horizontal	-38.45	-55.09	1.91	18.55	33	Pass
	Mid	1880	Horizontal	-39.41	-56.66	1.94	19.19	33	Pass
	High	1905	Horizontal	-41.17	-58.01	1.92	18.76	33	Pass
15 MHz (QPSK)	Low	1857.5	Horizontal	-38.50	-55.24	1.93	18.67	33	Pass
	Mid	1880	Horizontal	-39.03	-56.41	1.94	19.32	33	Pass
	High	1902.5	Horizontal	-40.72	-57.69	1.92	18.89	33	Pass
20 MHz (QPSK)	Low	1860	Horizontal	-38.52	-55.35	1.93	18.76	33	Pass
	Mid	1880	Horizontal	-39.19	-56.66	1.94	19.41	33	Pass
	High	1900	Horizontal	-40.81	-57.86	1.92	18.98	33	Pass
1.4 MHz (16QAM)	Low	1850.7	Horizontal	-38.15	-54.89	1.90	18.64	33	Pass
	Mid	1880	Horizontal	-39.30	-56.66	1.92	19.29	33	Pass
	High	1909.3	Horizontal	-41.14	-58.09	1.91	18.85	33	Pass
3 MHz (16QAM)	Low	1851.5	Horizontal	-38.20	-54.93	1.91	18.64	33	Pass
	Mid	1880	Horizontal	-39.22	-56.66	1.94	19.38	33	Pass
	High	1908.5	Horizontal	-41.04	-58.08	1.91	18.95	33	Pass
5 MHz (16QAM)	Low	1852.5	Horizontal	-38.32	-55.14	1.92	18.74	33	Pass
	Mid	1880	Horizontal	-38.97	-56.41	1.94	19.38	33	Pass
	High	1907.5	Horizontal	-40.92	-57.97	1.90	18.95	33	Pass
10 MHz (16QAM)	Low	1855	Horizontal	-38.57	-55.09	1.91	18.42	33	Pass
	Mid	1880	Horizontal	-39.53	-56.66	1.94	19.07	33	Pass
	High	1905	Horizontal	-41.30	-58.01	1.92	18.64	33	Pass
15 MHz (16QAM)	Low	1857.5	Horizontal	-38.62	-55.24	1.93	18.55	33	Pass
	Mid	1880	Horizontal	-39.15	-56.41	1.94	19.20	33	Pass
	High	1902.5	Horizontal	-40.85	-57.69	1.92	18.76	33	Pass
20 MHz (16QAM)	Low	1860	Horizontal	-38.64	-55.35	1.93	18.64	33	Pass
	Mid	1880	Horizontal	-39.32	-56.66	1.94	19.28	33	Pass
	High	1900	Horizontal	-40.93	-57.86	1.92	18.85	33	Pass

5.3.Occupied Bandwidth

Ambient condition

Temperature	Relative humidity	Pressure
23°C ~25°C	45%~50%	101.5kPa

Method of Measurement

The EUT was connected to Spectrum Analyzer and Base Station Simulator via power Splitter. The occupied bandwidth is measured using spectrum analyzer.

RBW is set to 3kHz, VBW is set to 10kHz for GSM 1900,

RBW is set to 51kHz, VBW is set to 160kHz for WCDMA Band II,

RBW is set to 51kHz, VBW is set to 160kHz for LTE Band 2 (1.4MHz),

RBW is set to 100kHz,VBW is set to 300kHz for LTE Band 2 (3MHz/5MHz),

RBW is set to 300kHz,VBW is set to 1MHz for LTE Band 2 (10MHz/15MHz/20MHz).

99% power and -26dBc occupied bandwidths are recorded. Spectrum analyzer plots are included on the following pages.

Test Setup

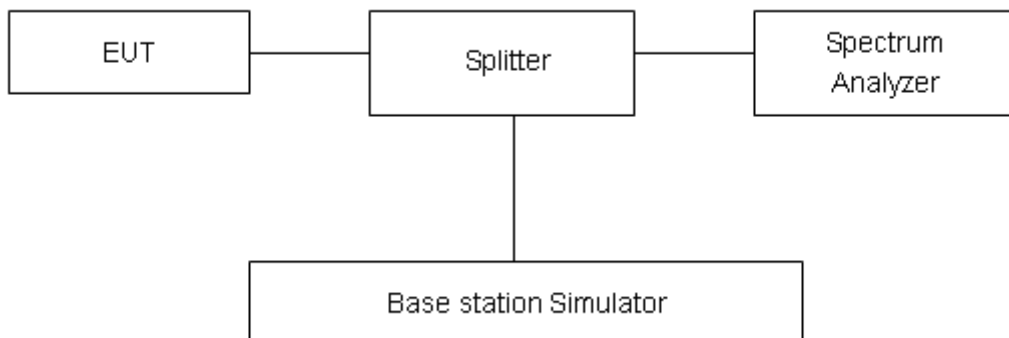

Limits

No specific occupied bandwidth requirements in part 2.1049.

Measurement Uncertainty

The assessed measurement uncertainty to ensure 95% confidence level for the normal distribution is with the coverage factor $k = 2$, $U = 624\text{Hz}$.



Test Result

Mode	Channel	Frequency (MHz)	99% Power Bandwidth (MHz)	-26dBc Bandwidth(MHz)
GSM 1900 (GSM)	512	1850.2	0.24402	0.3190
	661	1880.0	0.24853	0.3058
	810	1909.8	0.24409	0.3076
GPRS 1900 (GMSK)	512	1850.2	0.24663	0.3081
	661	1880.0	0.24647	0.3001
	810	1909.8	0.24600	0.3132
EGPRS 1900 (8-PSK)	512	1850.2	0.24288	0.3120
	661	1880.0	0.24281	0.3087
	810	1909.8	0.23974	0.3012
WCDMA Band II (RMC)	9262	1852.4	4.1502	4.711
	9400	1880	4.1447	4.703
	9538	1907.6	4.1576	4.752

LTE Band 2					
Modulation	Bandwidth (MHz)	Channel	Frequency (MHz)	99% Power Bandwidth(MHz)	-26dBc Bandwidth(MHz)
QPSK	1.4	18607	1850.7	1.1338	1.357
		18900	1880.0	1.1269	1.360
		19193	1909.3	1.1285	1.335
	3	18615	1851.5	2.7577	3.074
		18900	1880	2.7466	3.080
		19185	1908.5	2.7450	3.074
	5	18625	1852.5	4.5180	5.006
		18900	1880	4.5366	5.043
		19175	1907.5	4.5140	5.036
	10	18650	1855	9.0230	10.080
		18900	1880	9.0666	10.100
		19150	1905	9.0522	10.130
	15	18675	1857.5	13.4300	14.670
		18900	1880	13.5320	14.870



		19125	1902.5	13.4360	14.580
	20	18700	1860	17.8460	19.170
		18900	1880	17.9580	19.350
		19100	1900	17.8290	19.350
16QAM	1.4	18607	1850.7	1.1279	1.343
		18900	1880.0	1.1333	1.341
		19193	1909.3	1.1265	1.357
	3	18615	1851.5	2.7447	3.086
		18900	1880	2.7611	3.088
		19185	1908.5	2.7432	3.077
	5	18625	1852.5	4.5260	5.056
		18900	1880	4.5104	5.019
		19175	1907.5	4.5423	5.056
	10	18650	1855	9.0306	9.985
		18900	1880	9.0687	10.080
		19150	1905	9.0459	10.090
	15	18675	1857.5	13.4620	14.780
		18900	1880	13.5430	14.720
		19125	1902.5	13.4570	14.700
	20	18700	1860	17.8700	19.350
		18900	1880	17.9990	19.240
		19100	1900	17.7970	19.200

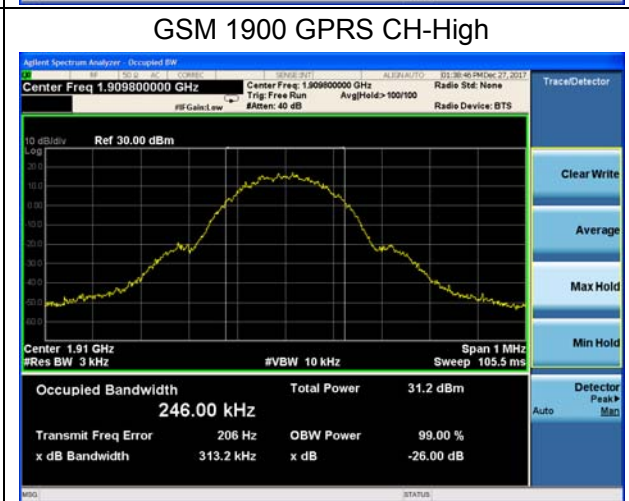
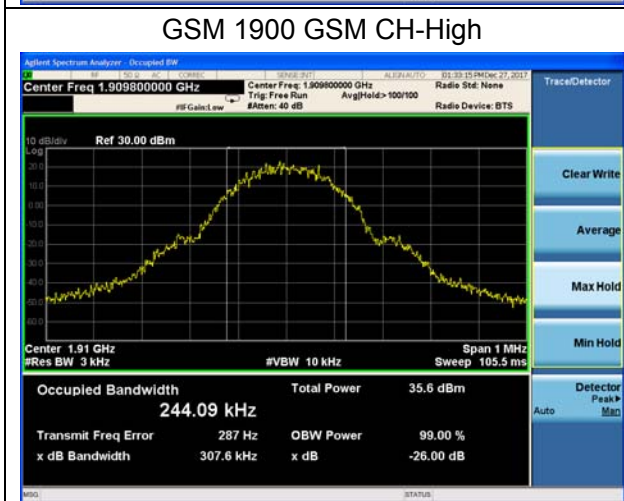
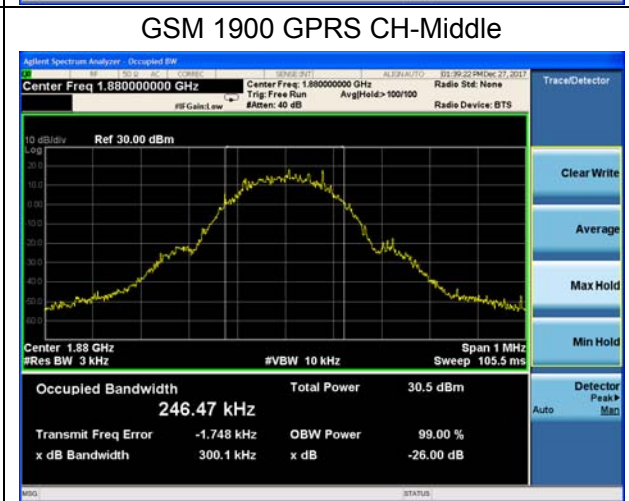
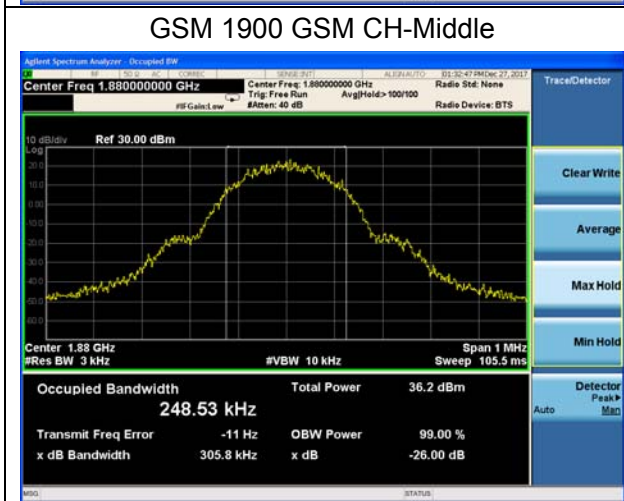
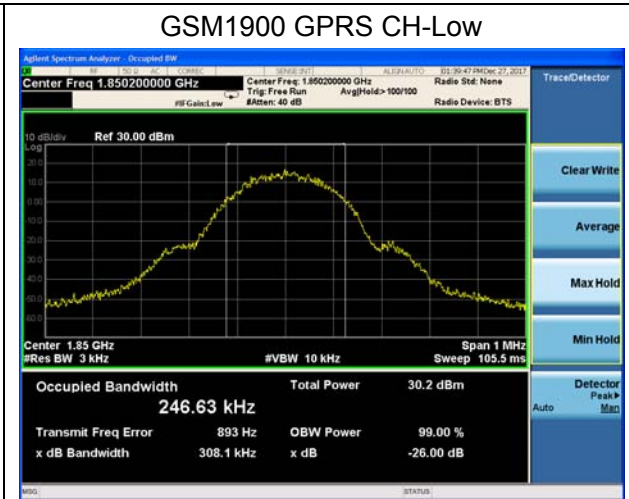

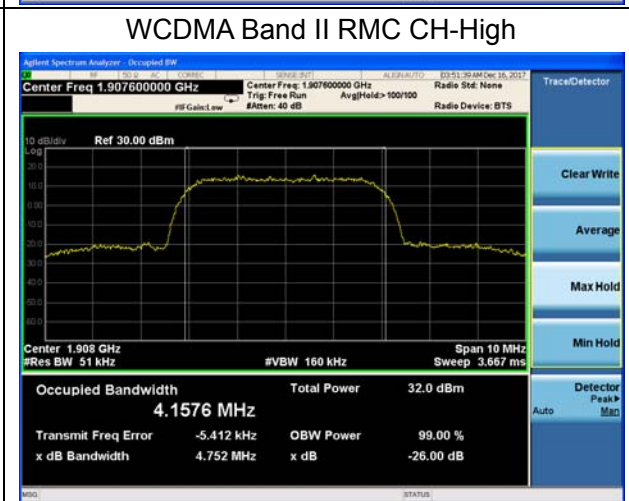
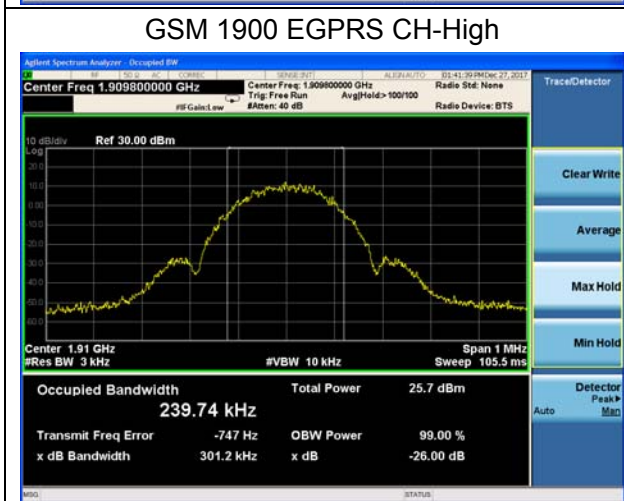
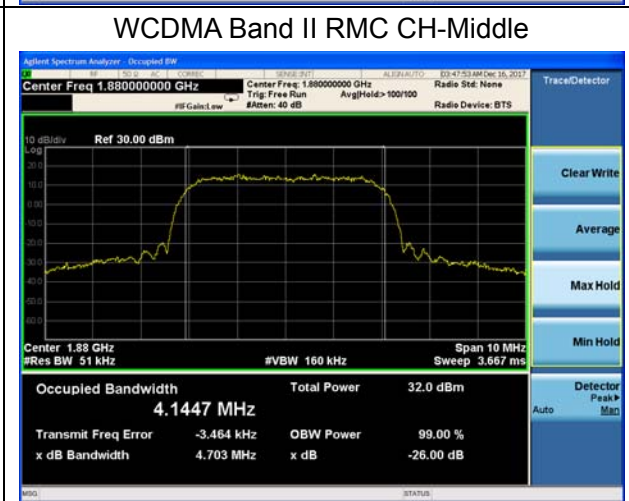
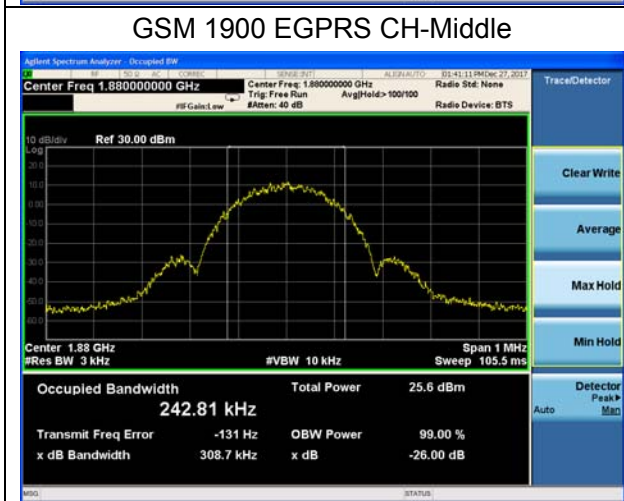
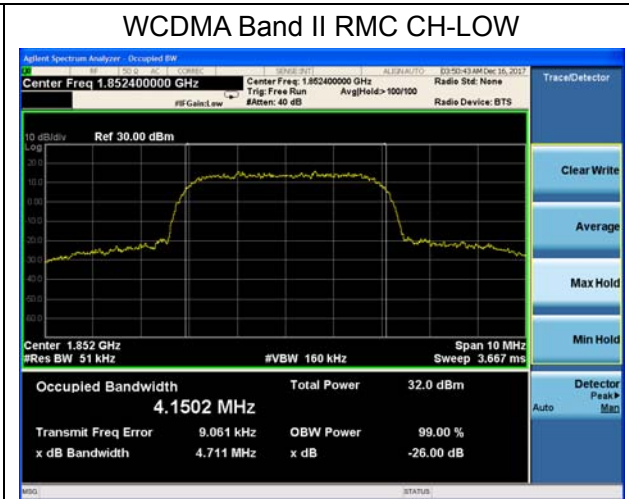
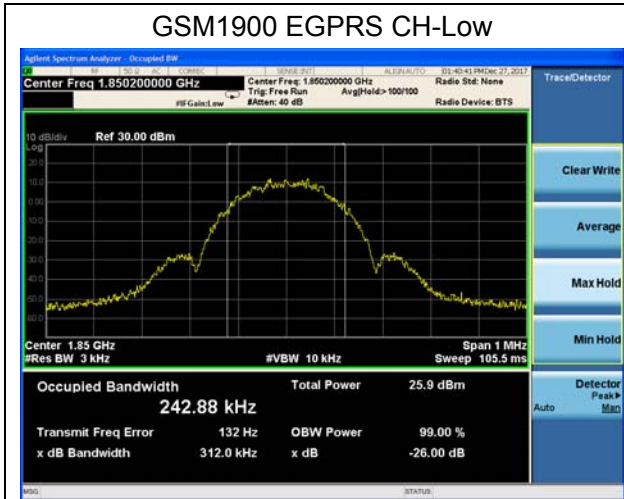

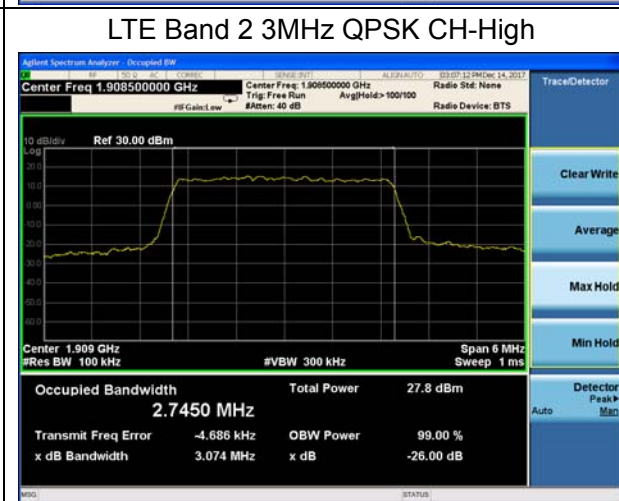
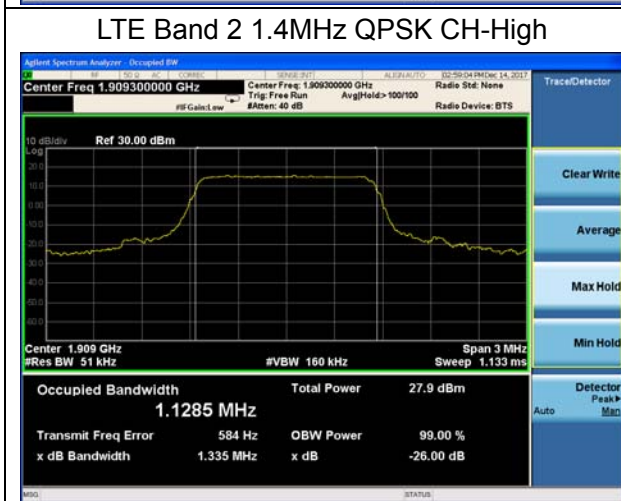
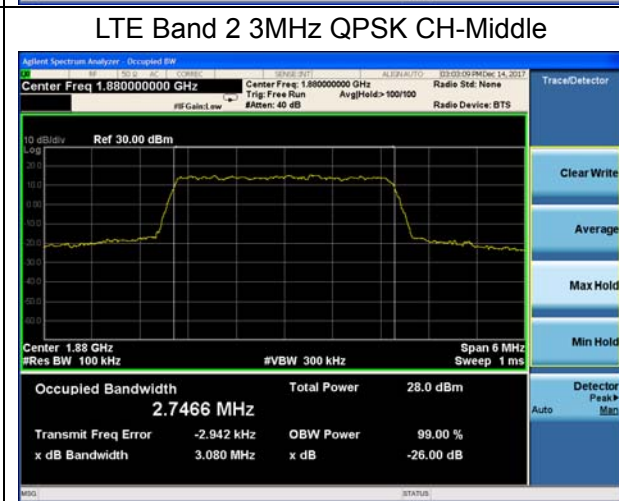
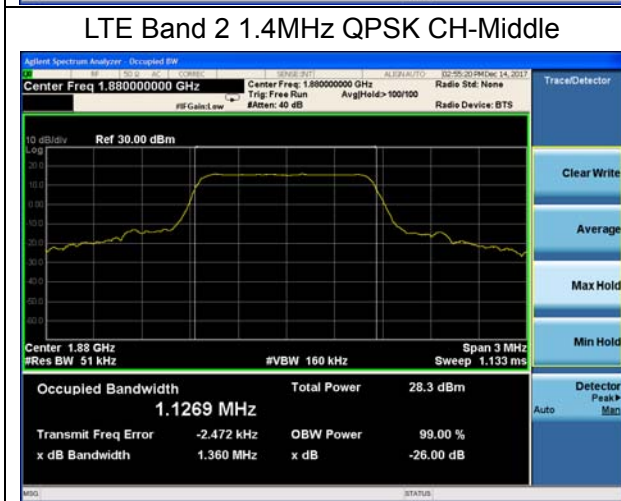
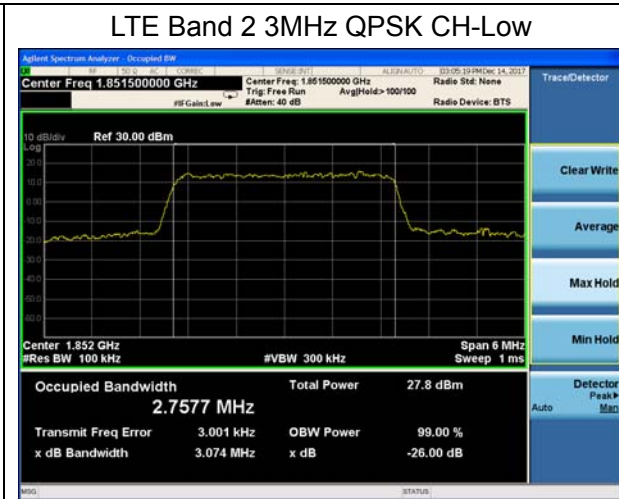
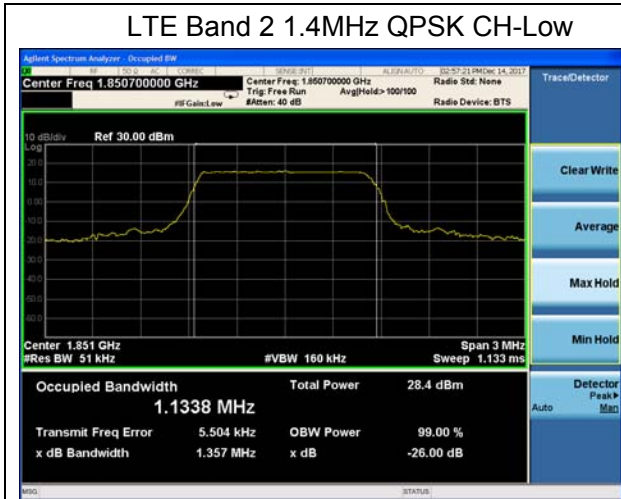

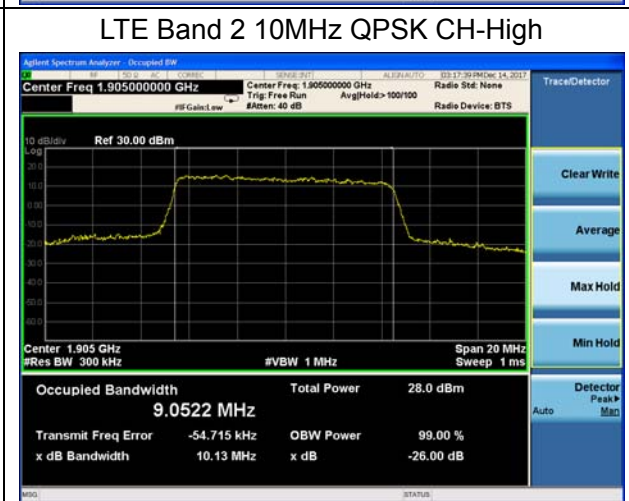
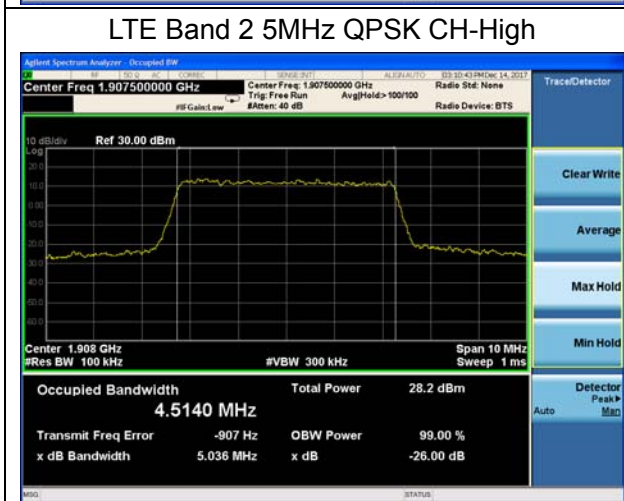
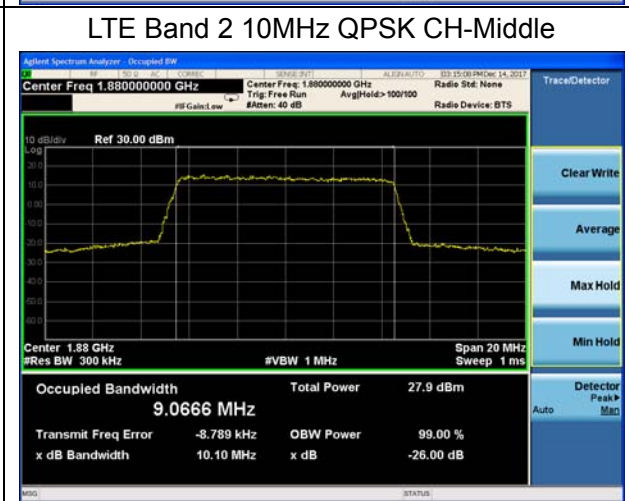
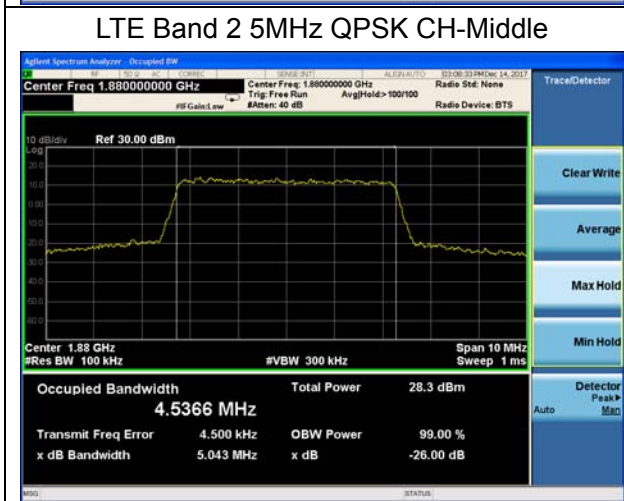
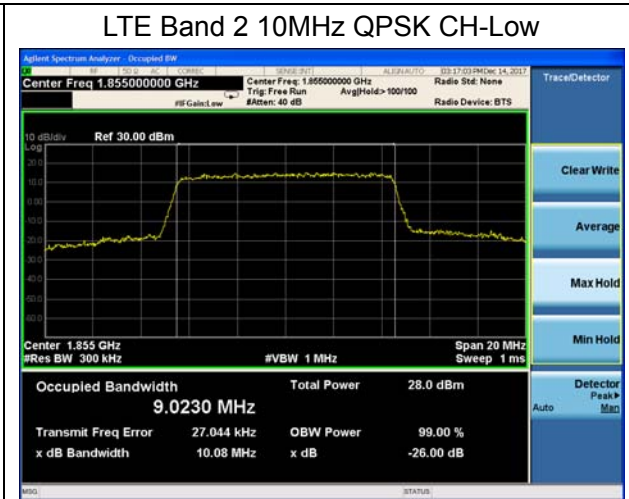
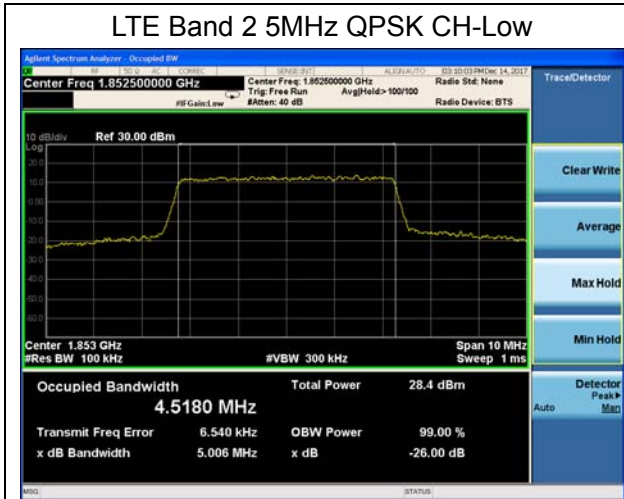

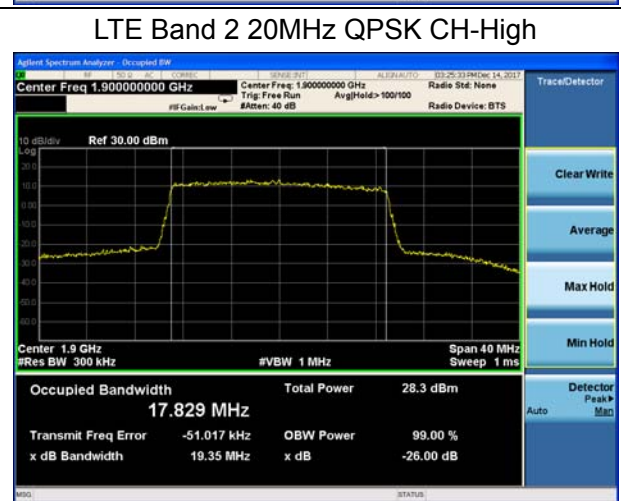
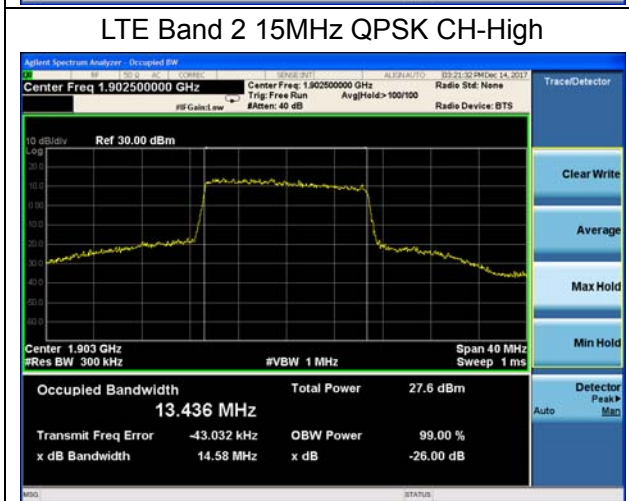
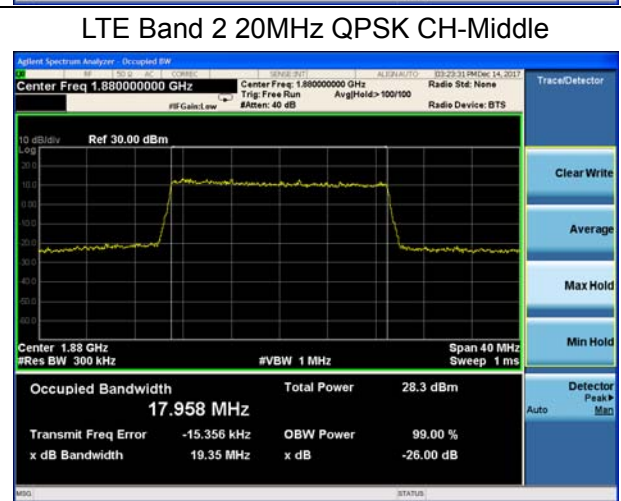
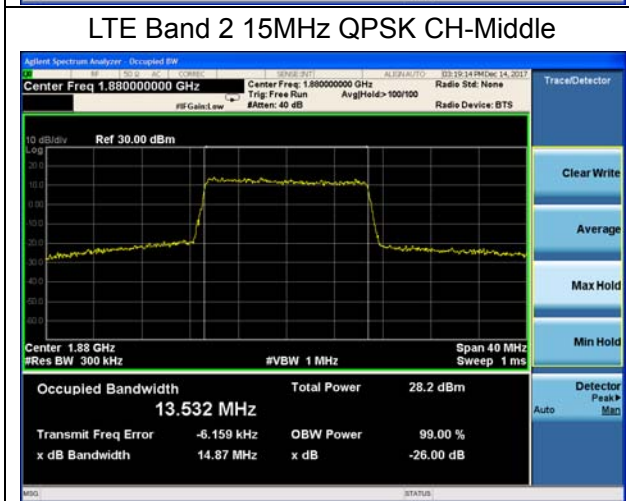
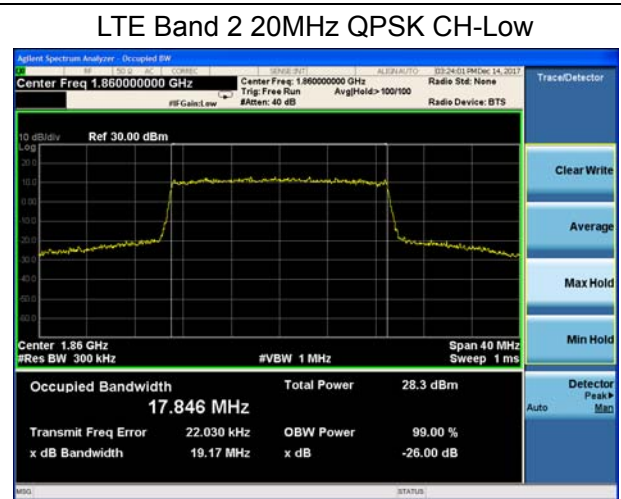
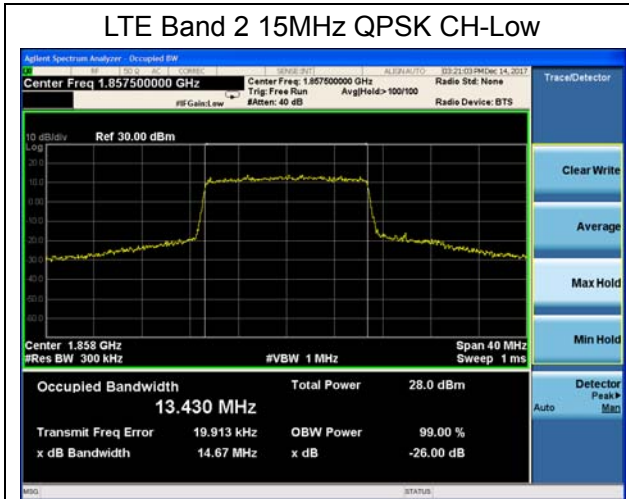

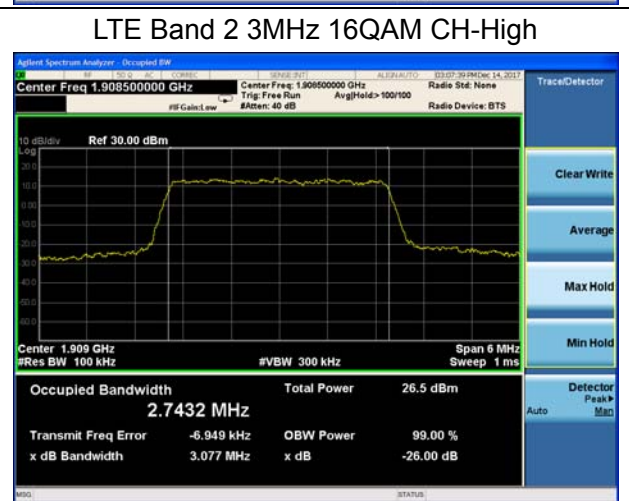
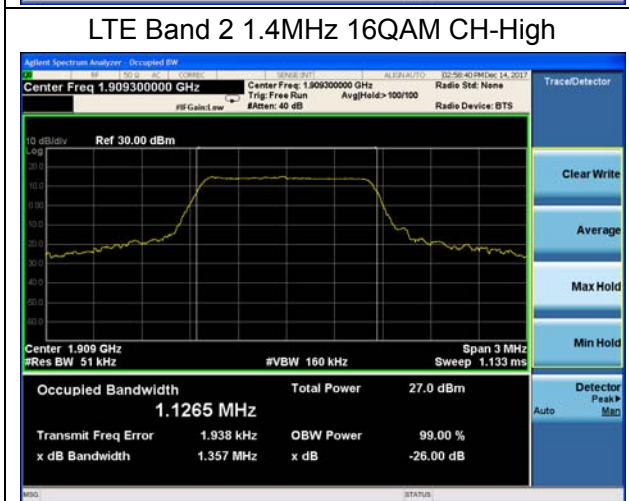
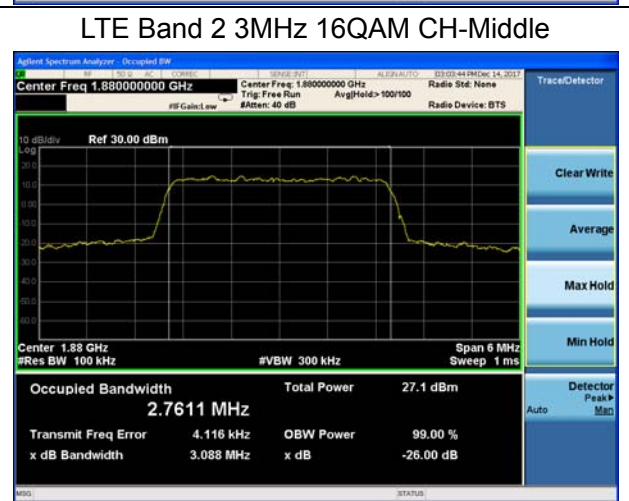
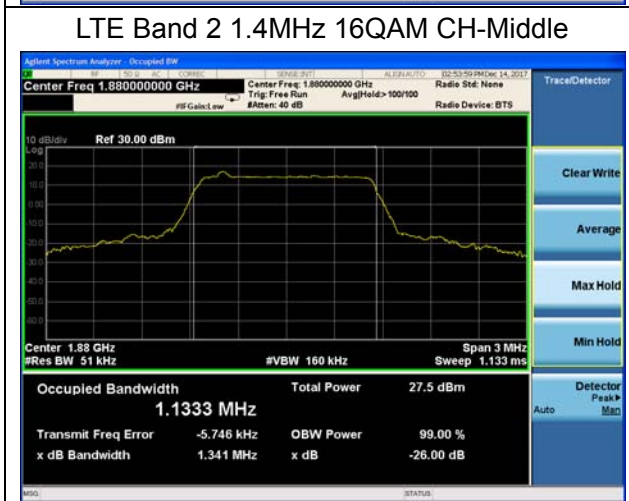
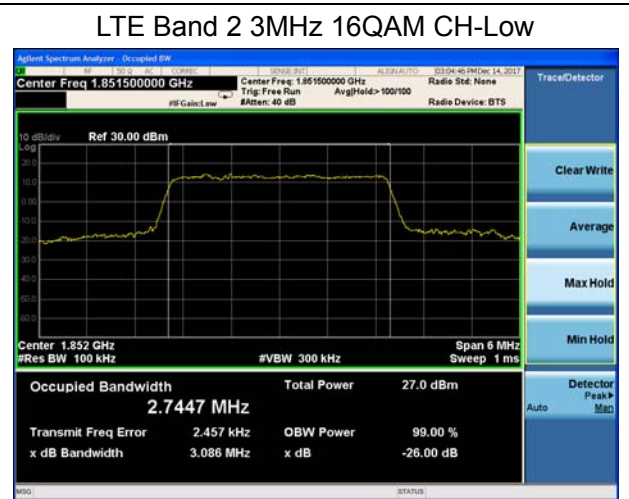
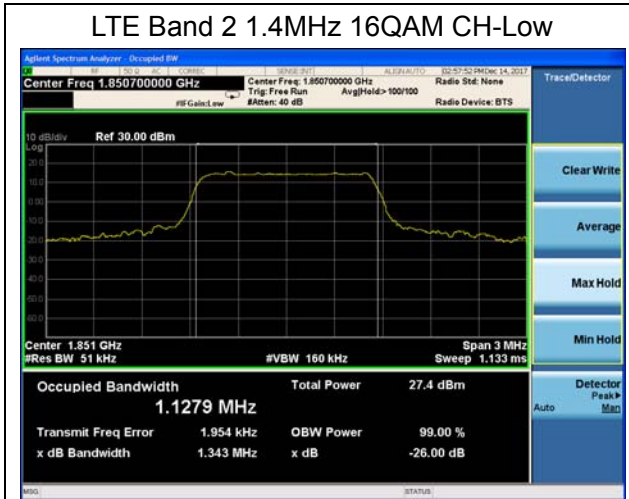

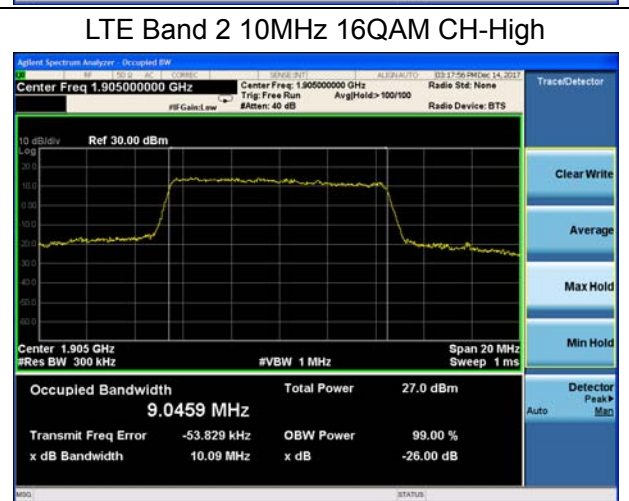
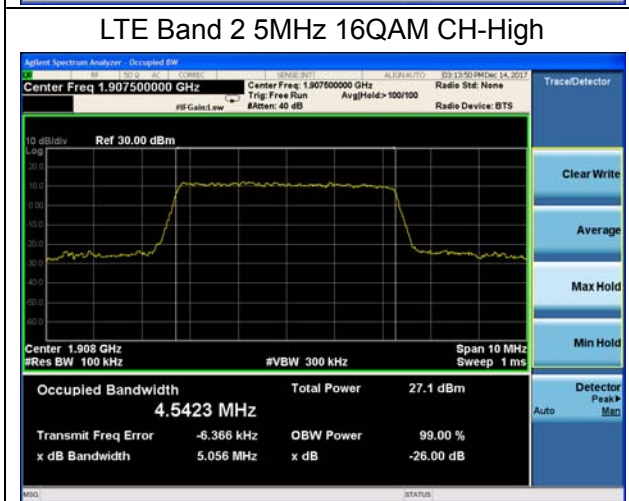
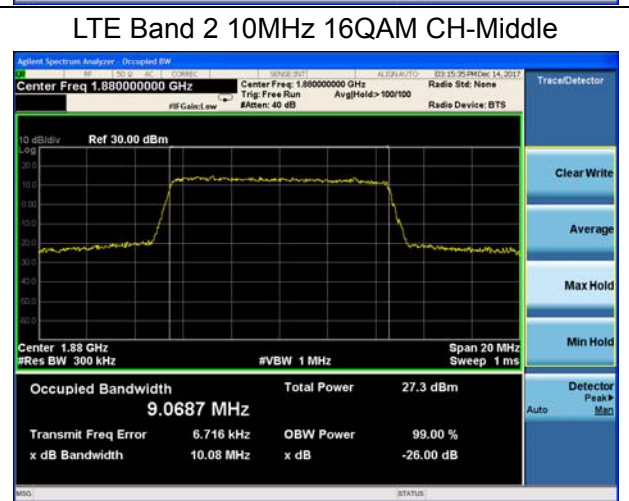
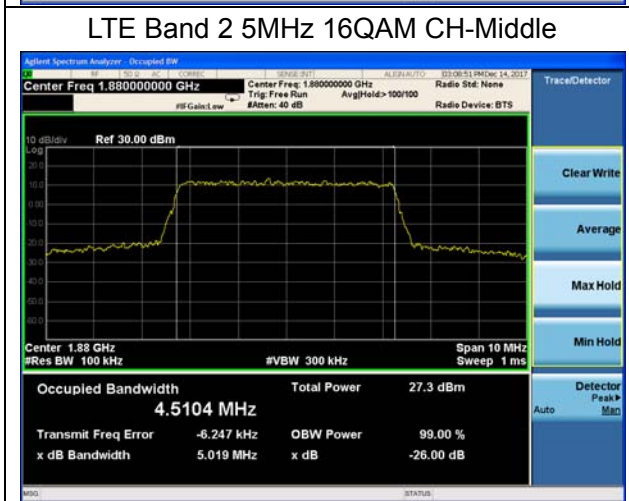
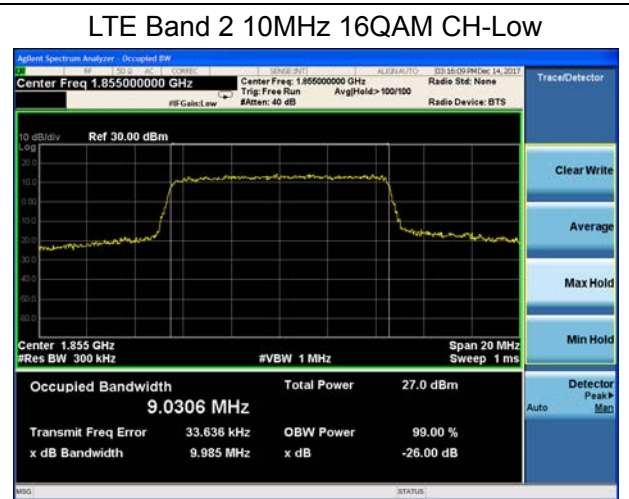
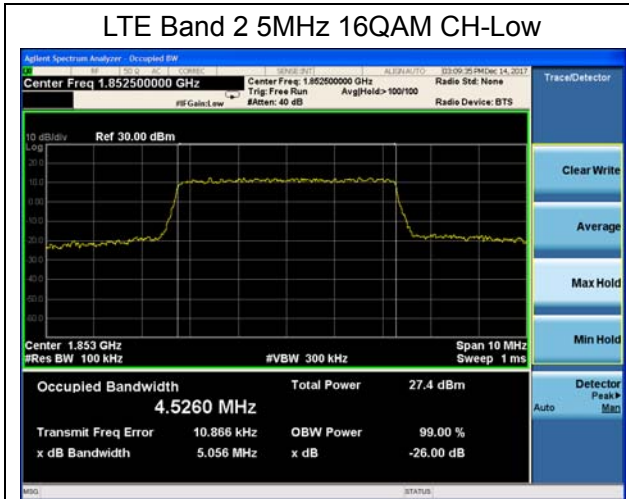

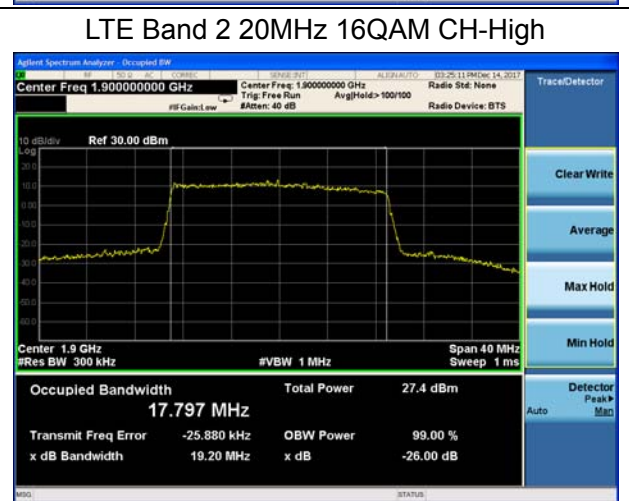
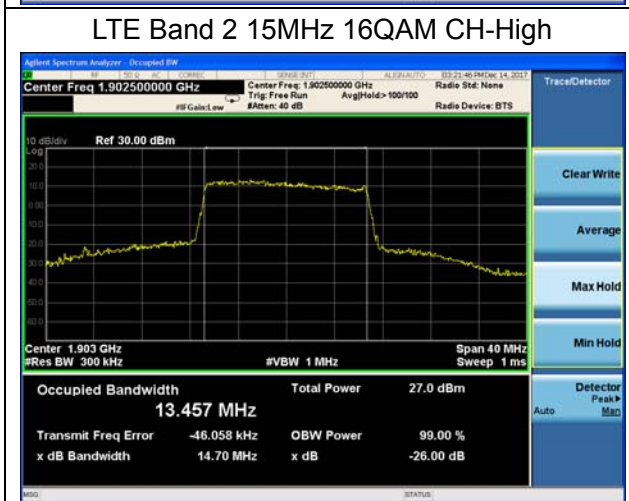
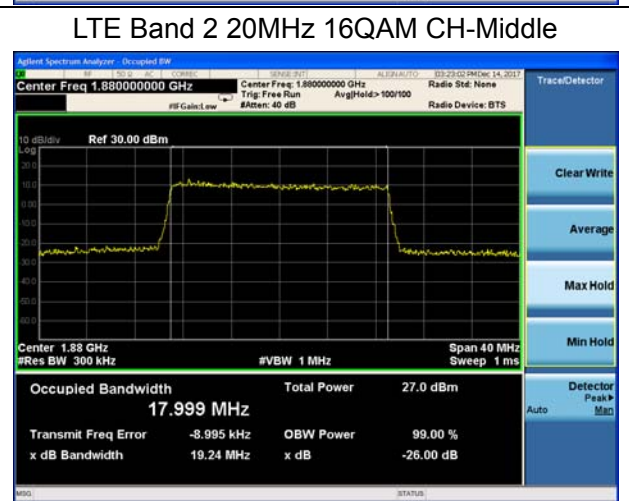
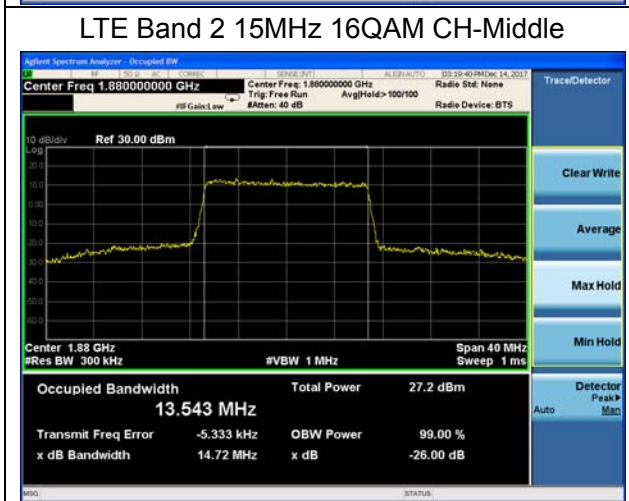
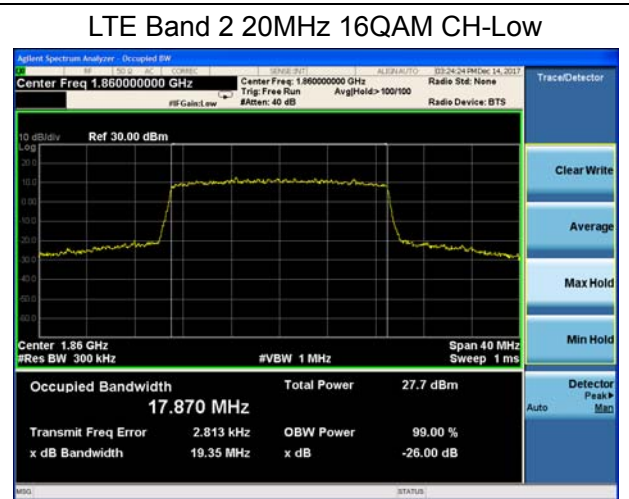
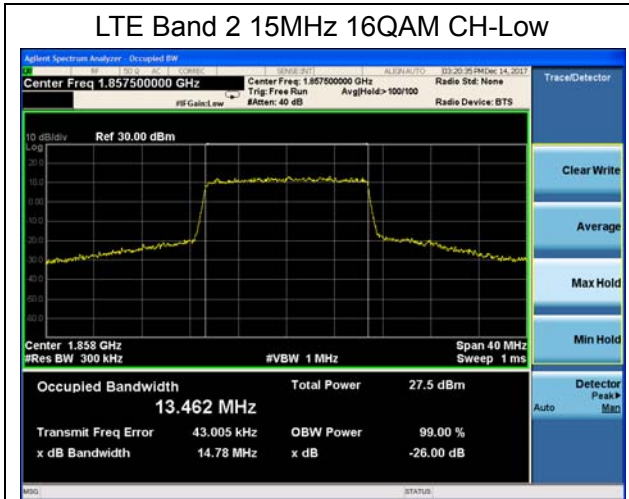

5.4. Band Edge Compliance

Ambient condition

Temperature	Relative humidity	Pressure
23°C ~25°C	45%~50%	101.5kPa

Method of Measurement

The EUT was connected to Spectrum Analyzer and Base Station Simulator via power Splitter. The band edge of the lowest and highest channels were measured. The Average detector is used and RBW is set to 3kHz, VBW is set to 10kHz for GSM 1900, RBW is set to 51kHz, VBW is set to 160kHz for WCDMA Band II, RBW is set to 15kHz, VBW is set to 51kHz for LTE Band 2 (1.4MHz), RBW is set to 30kHz, VBW is set to 100kHz for LTE Band 2 (3MHz), RBW is set to 51kHz, VBW is set to 160kHz for LTE Band 2 (5MHz), RBW is set to 100kHz, VBW is set to 300kHz for LTE Band 2 (10MHz), RBW is set to 150kHz, VBW is set to 510kHz for LTE Band 2 (15MHz), RBW is set to 200kHz, VBW is set to 620kHz for LTE Band 2 (20MHz). Spectrum analyzer plots are included on the following pages.

Test Setup

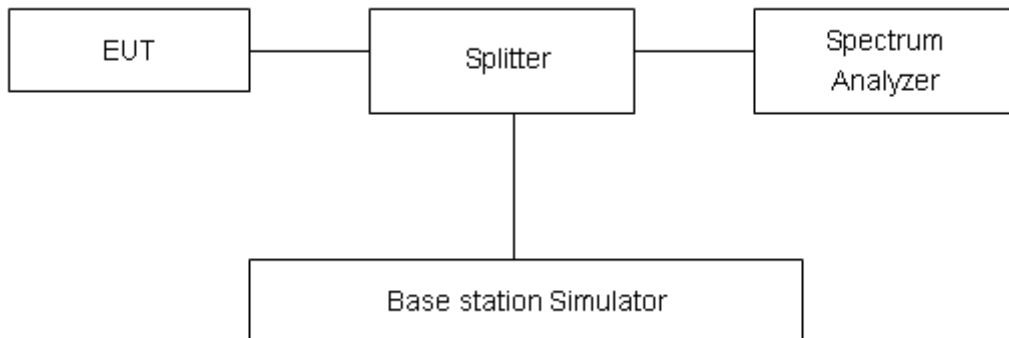

Limits

Rule Part 24.238(a) specifies that “on any frequency outside a licensee’s frequency block, the power of any emission shall be attenuated below the transmitter power (P) by at least 43 + 10 log10 (P) dB.”

Limit	-13 dBm
-------	---------

Measurement Uncertainty

The assessed measurement uncertainty to ensure 95% confidence level for the normal distribution is with the coverage factor $k = 1.96$, $U=0.684\text{dB}$.



Test Result:

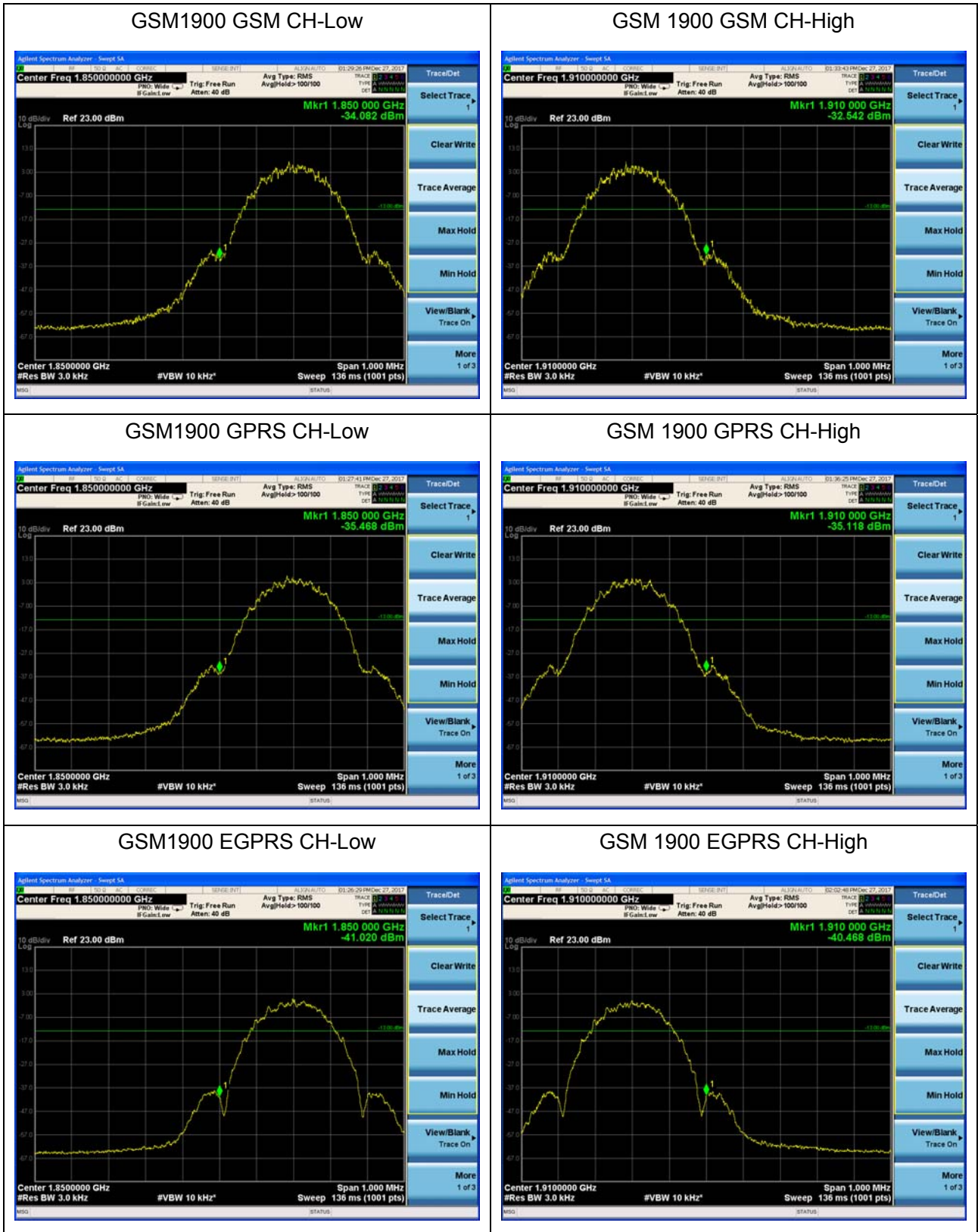



LTE Band 2 3MHz QPSK 1RB CH-Low

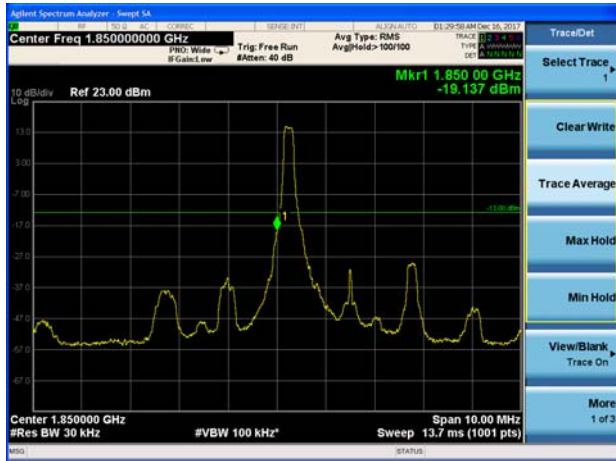

LTE Band 2 3MHz QPSK 1RB CH-High

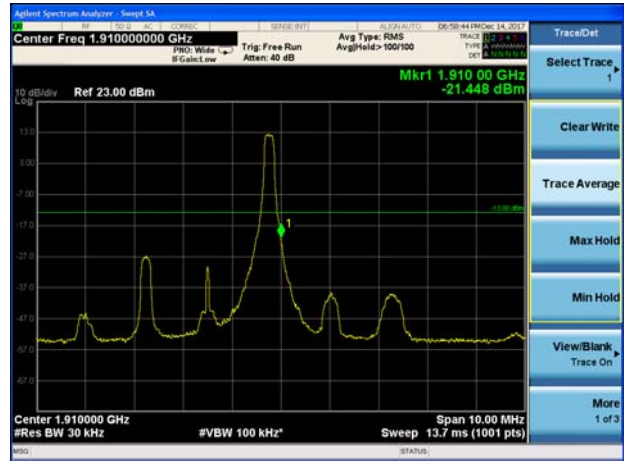

LTE Band 2 3MHz QPSK 100%RB CH-Low



LTE Band 2 3MHz QPSK 100%RB CH-High



LTE Band 2 5MHz QPSK 1RB CH-Low

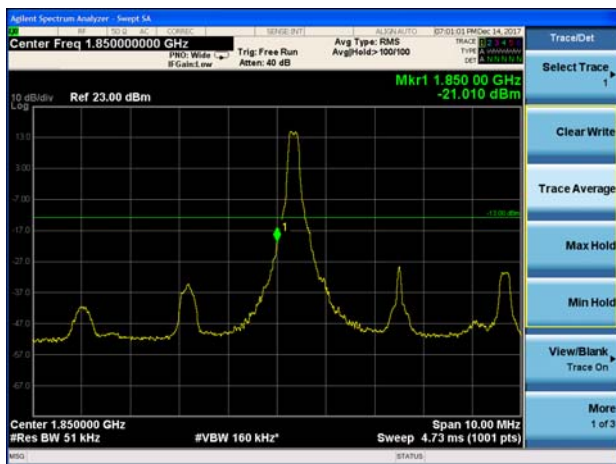

LTE Band 2 5MHz QPSK 1RB CH-High

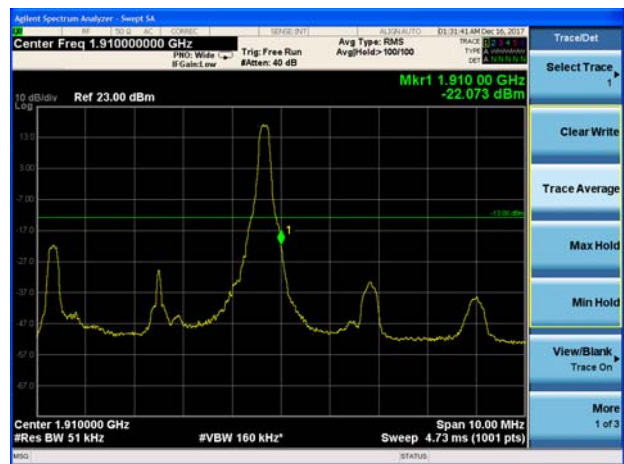



LTE Band 2 5MHz QPSK 100%RB CH-Low



LTE Band 2 5MHz QPSK 100%RB CH-High



LTE Band 2 10MHz QPSK 1RB CH-Low

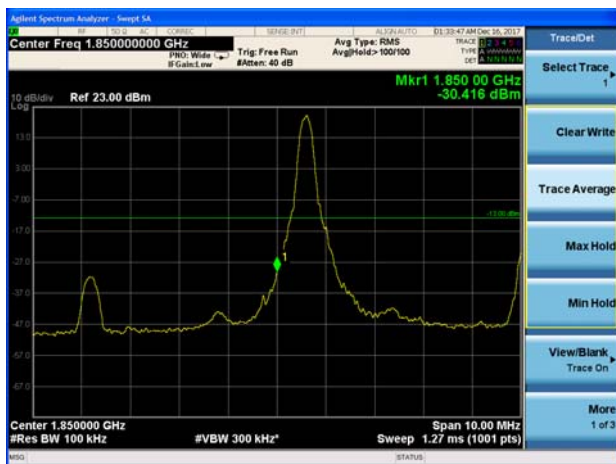

LTE Band 2 10MHz QPSK 1RB CH-High

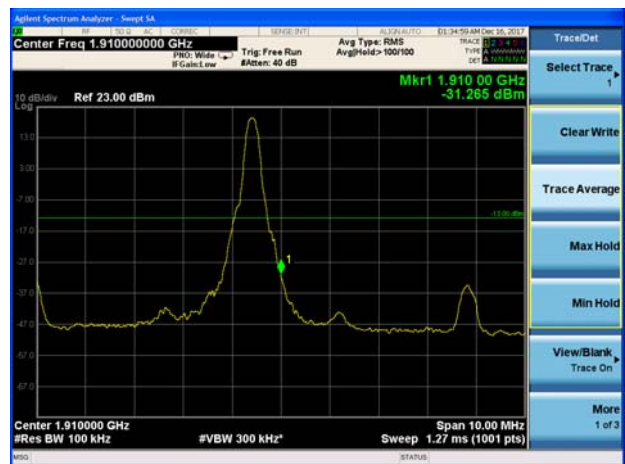

LTE Band 2 10MHz QPSK 100%RB CH-Low

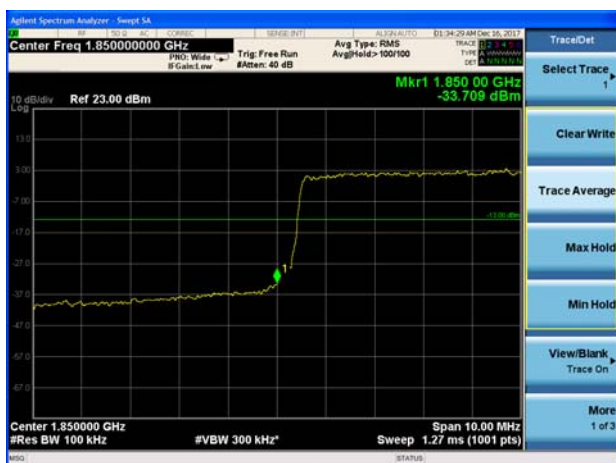

LTE Band 2 10MHz QPSK 100%RB CH-High

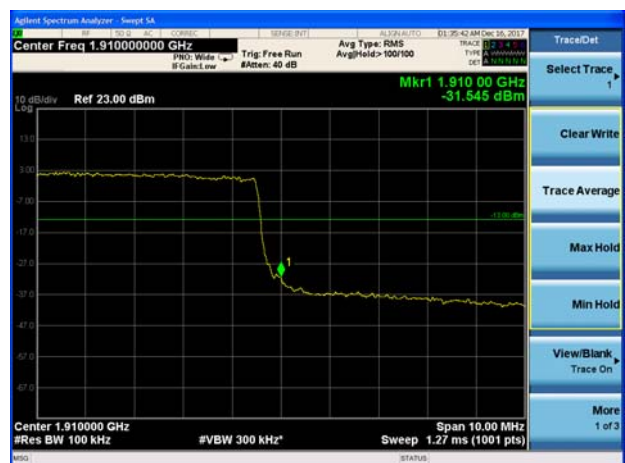



LTE Band 2 15MHz QPSK 1RB CH-Low

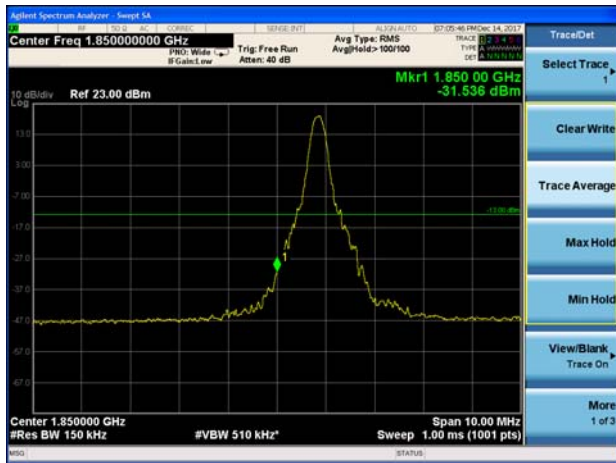

LTE Band 2 15MHz QPSK 1RB CH-High

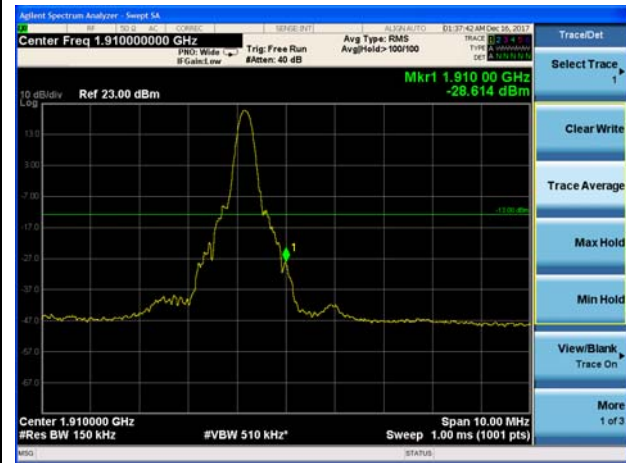

LTE Band 2 15MHz QPSK 100%RB CH-Low



LTE Band 2 15MHz QPSK 100%RB CH-High



LTE Band 2 20MHz QPSK 1RB CH-Low

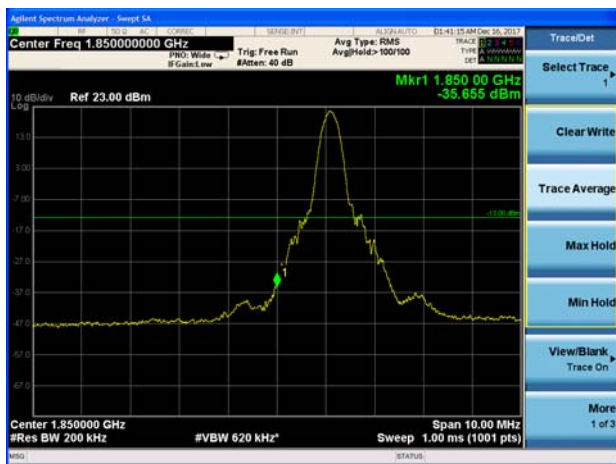

LTE Band 2 20MHz QPSK 1RB CH-High

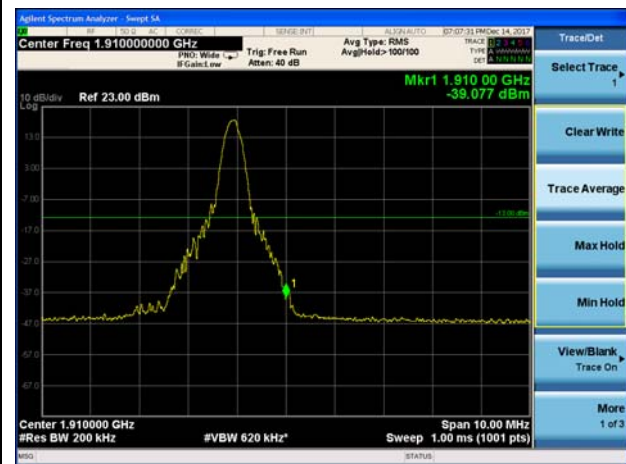



LTE Band 2 20MHz QPSK 100%RB CH-Low



LTE Band 2 20MHz QPSK 100%RB CH-High



LTE Band 2 1.4MHz 16QAM 1RB CH-Low

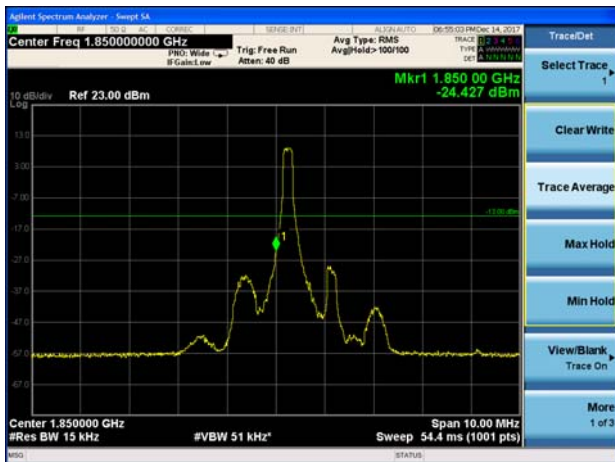

LTE Band 2 1.4MHz 16QAM 1RB CH-High

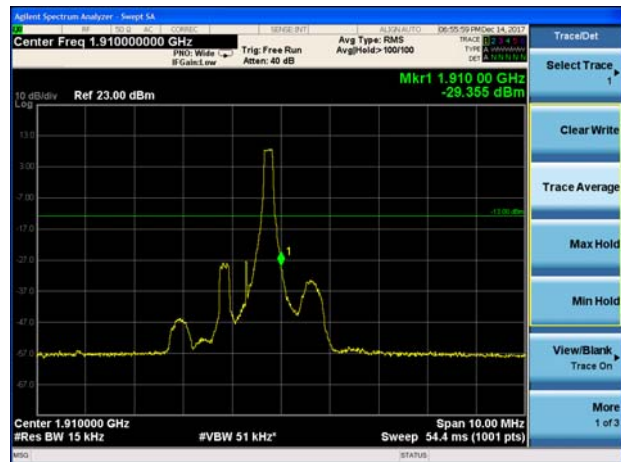

LTE Band 2 1.4MHz 16QAM 100%RB CH-Low

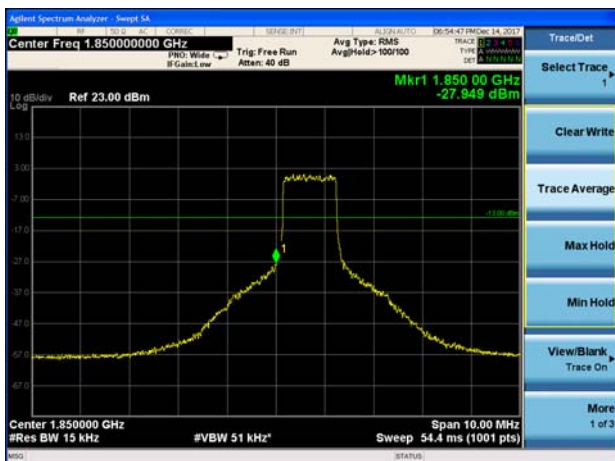

LTE Band 2 1.4MHz 16QAM 100%RB CH-High

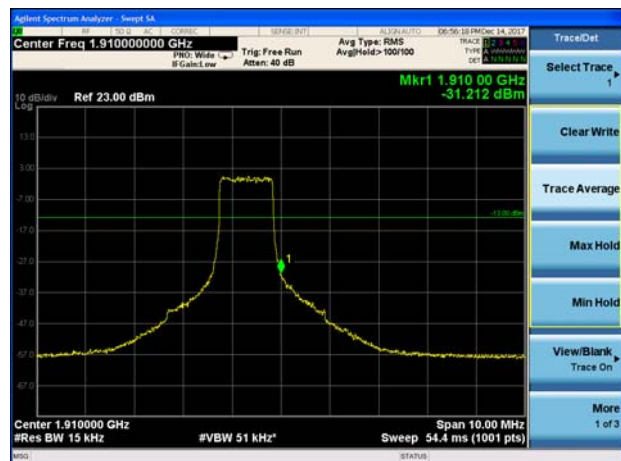

LTE Band 2 3MHz 16QAM 1RB CH-Low

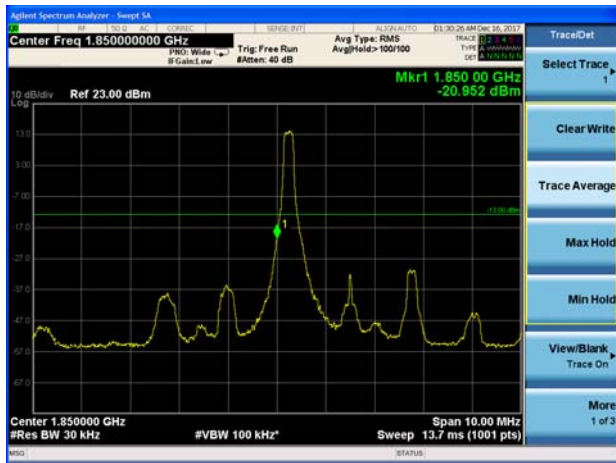

LTE Band 2 3MHz 16QAM 1RB CH-High

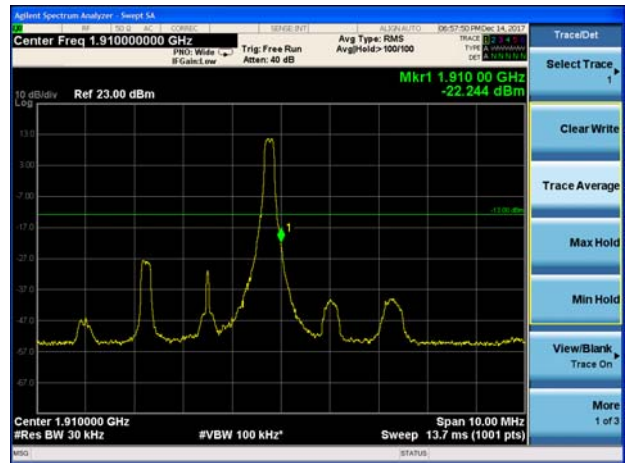

LTE Band 2 3MHz 16QAM 100%RB CH-Low



LTE Band 2 3MHz 16QAM 100%RB CH-High



LTE Band 2 5MHz 16QAM 1RB CH-Low

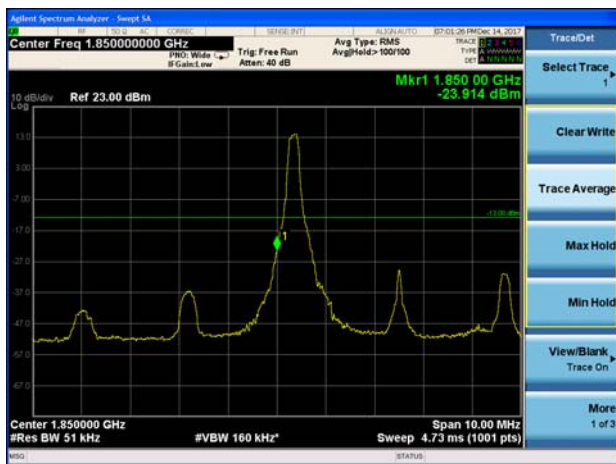

LTE Band 2 5MHz 16QAM 1RB CH-High

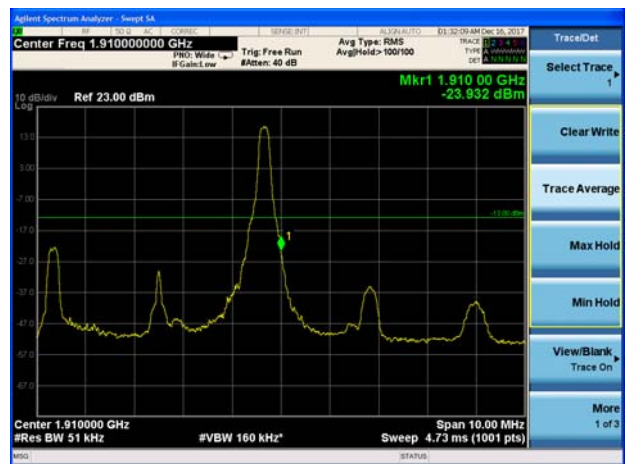



LTE Band 2 5MHz 16QAM 100%RB CH-Low

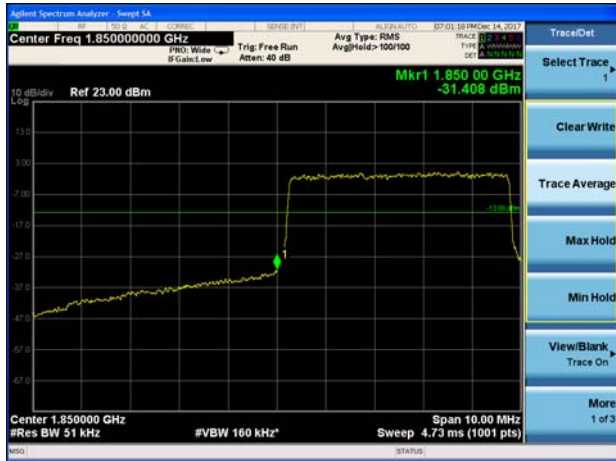

LTE Band 2 5MHz 16QAM 100%RB CH-High



LTE Band 2 10MHz 16QAM 1RB CH-Low

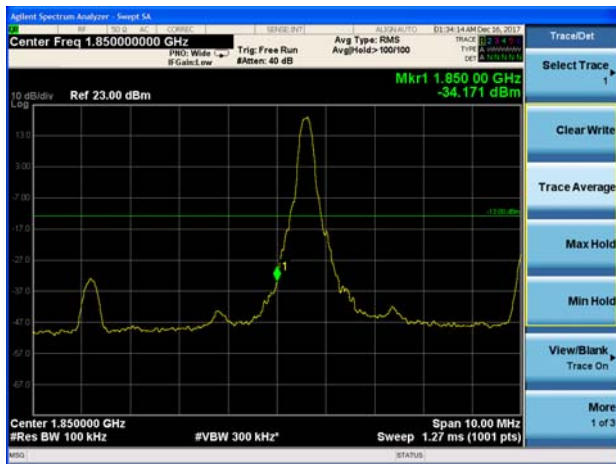

LTE Band 2 10MHz 16QAM 1RB CH-High



LTE Band 2 10MHz 16QAM 100%RB CH-Low

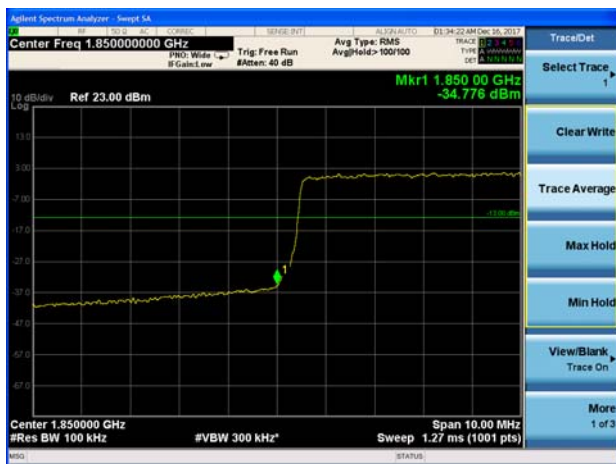

LTE Band 2 10MHz 16QAM 100%RB CH-High

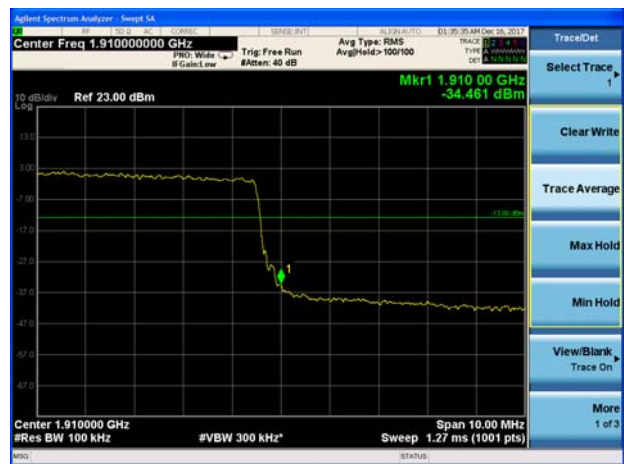

LTE Band 2 15MHz 16QAM 1RB CH-Low

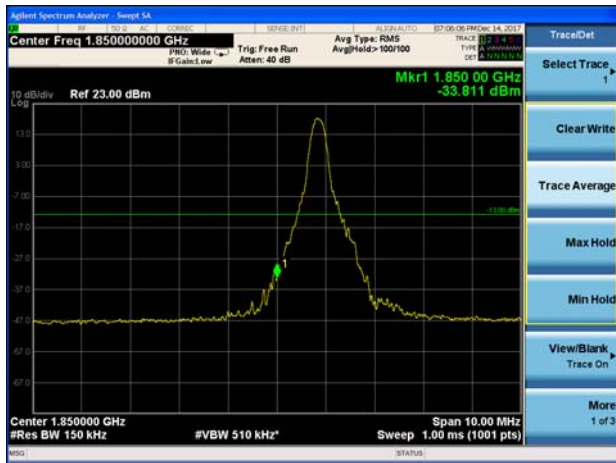

LTE Band 2 15MHz 16QAM 1RB CH-High



LTE Band 2 15MHz 16QAM 100%RB CH-Low



LTE Band 2 15MHz 16QAM 100%RB CH-High



LTE Band 2 20MHz 16QAM 1RB CH-Low



LTE Band 2 20MHz 16QAM 1RB CH-High





LTE Band 2 20MHz 16QAM 100%RB CH-Low



LTE Band 2 20MHz 16QAM 100%RB CH-High



5.5. Peak-to-Average Power Ratio (PAPR)

Ambient condition

Temperature	Relative humidity	Pressure
23°C ~25°C	45%~50%	101.5kPa

Methods of Measurement

Measure the total peak power and record as PPk. And measure the total average power and record as PAvg. Both the peak and average power levels must be expressed in the same logarithmic units (e.g., dBm). Determine the PAPR from:

$$PAPR (dB) = PPk (dBm) - PAvg (dBm).$$

Test Setup

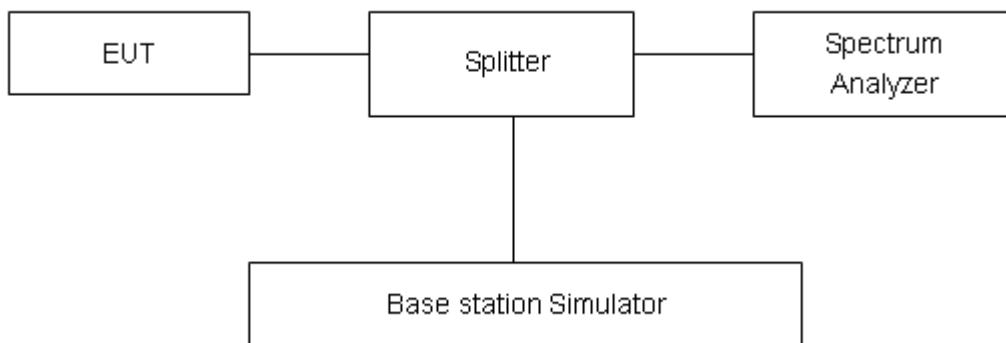

Limits

In measuring transmissions in this band using an average power technique, the peak-to-average ratio (PAR) of the transmission may not exceed 13 dB in 24.232(d).

Measurement Uncertainty

The assessed measurement uncertainty to ensure 95% confidence level for the normal distribution is with the coverage factor $k = 2$, $U = 0.4$ dB.

**Test Results**

Mode	Channel	Frequency (MHz)	Peak(dBm)	Avg(dBm)	PAPR(dB)	Limit(dB)	Conclusion
GSM 1900 (GSM)	512	1850.2	31.74	30.13	1.61	≤13	PASS
	661	1880	31.41	29.76	1.65	≤13	PASS
	810	1909.8	31.62	30.03	1.59	≤13	PASS
GPRS 1900 (GMSK)	512	1850.2	25.63	23.88	1.75	≤13	PASS
	661	1880	25.51	23.72	1.79	≤13	PASS
	810	1909.8	25.59	23.82	1.77	≤13	PASS
EGPRS 1900 (8-PSK)	512	1850.2	21.48	19.74	1.74	≤13	PASS
	661	1880	21.12	19.36	1.76	≤13	PASS
	810	1909.8	21.18	19.47	1.71	≤13	PASS
WCDMA Band II (RMC)	9262	1852.4	25.69	22.87	2.82	≤13	PASS
	9400	1880	26.09	23.09	3.00	≤13	PASS
	9538	1907.6	25.62	23.01	2.61	≤13	PASS



LTE Band 2		Channel	Frequency (MHz)	Peak (dBm)	Avg (dBm)	PAPR (dB)	Limit(dB)	Conclusion
Modulation	Bandwidth							
QPSK	1.4MHz	18607	1850.7	26.89	21.98	4.91	≤13	PASS
		18900	1880.0	26.98	22.14	4.84	≤13	PASS
		19193	1909.3	26.77	22.11	4.66	≤13	PASS
	3MHz	18615	1851.5	27.68	22.01	5.67	≤13	PASS
		18900	1880	27.69	22.18	5.51	≤13	PASS
		19185	1908.5	27.79	22.14	5.65	≤13	PASS
	5MHz	18625	1852.5	27.62	21.99	5.63	≤13	PASS
		18900	1880	27.71	22.17	5.54	≤13	PASS
		19175	1907.5	27.78	22.12	5.66	≤13	PASS
	10MHz	18650	1855	26.76	22.07	4.69	≤13	PASS
		18900	1880	27.37	22.19	5.18	≤13	PASS
		19150	1905	27.18	22.16	5.02	≤13	PASS
	15MHz	18675	1857.5	27.76	22.05	5.71	≤13	PASS
		18900	1880	28.19	22.15	6.04	≤13	PASS
		19125	1902.5	27.89	22.11	5.78	≤13	PASS
20MHz	18700	1860	27.75	22.02	5.73	≤13	PASS	
	18900	1880	27.92	22.10	5.82	≤13	PASS	
	19100	1900	27.10	22.07	5.03	≤13	PASS	
16QAM	1.4MHz	18607	1850.7	26.63	20.86	5.77	≤13	PASS
		18900	1880.0	26.68	21.02	5.66	≤13	PASS
		19193	1909.3	26.66	21.22	5.44	≤13	PASS
	3MHz	18615	1851.5	25.74	20.89	4.85	≤13	PASS
		18900	1880	25.81	21.06	4.75	≤13	PASS
		19185	1908.5	26.02	21.25	4.77	≤13	PASS
	5MHz	18625	1852.5	25.62	20.87	4.75	≤13	PASS
		18900	1880	25.73	21.02	4.71	≤13	PASS
		19175	1907.5	26.09	21.20	4.89	≤13	PASS
	10MHz	18650	1855	26.45	20.90	5.55	≤13	PASS
		18900	1880	27.12	21.07	6.05	≤13	PASS
		19150	1905	27.07	21.24	5.83	≤13	PASS
	15MHz	18675	1857.5	25.79	20.87	4.92	≤13	PASS
		18900	1880	26.19	21.02	5.17	≤13	PASS
		19125	1902.5	26.23	21.20	5.03	≤13	PASS
20MHz	18700	1860	25.75	20.85	4.90	≤13	PASS	
	18900	1880	25.97	20.98	4.99	≤13	PASS	
	19100	1900	26.96	21.17	5.79	≤13	PASS	

5.6. Frequency Stability

Ambient condition

Temperature	Relative humidity	Pressure
23°C ~25°C	45%~50%	101.5kPa

Method of Measurement

1. Frequency Stability (Temperature Variation)

The temperature inside the climate chamber is varied from -30°C to +55°C in 10°C step size,

(1) With all power removed, the temperature was decreased to 0°C and permitted to stabilize for three hours.

(2) Measure the carrier frequency with the test equipment in a “call mode”. These measurements should be made within 1 minute of powering up the mobile station, to prevent significant self warming.

(3) Repeat the above measurements at 10°C increments from -30°C to +55°C. Allow at least 1.5 hours at each temperature, un-powered, before making measurements.

2. Frequency Stability (Voltage Variation)

The frequency stability shall be measured with variation of primary supply voltage as follows:

(1) Vary primary supply voltage from 85 to 115 percent of the nominal value for other than hand carried battery equipment.

(2) For hand carried, battery powered equipment, reduce primary supply voltage to the battery-operating end point which shall be specified by the manufacturer.

This transceiver is specified to operate with an input voltage of between 3.4 V and 4.4 V, with a nominal voltage of 3.85V.

Test setup

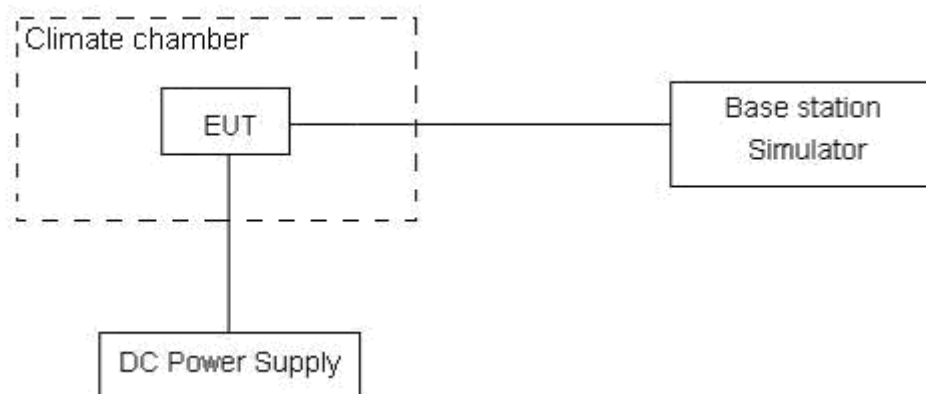



Limits

No specific frequency stability requirements in part 24.235

Measurement Uncertainty

The assessed measurement uncertainty to ensure 99.75% confidence level for the normal distribution is with the coverage factor $k = 3$, $U = 0.01\text{ppm}$.



Test Result

Mode	Test status	Test Results (ppm)		
		GSM(GMSK)	GPRS(GMSK)	EGPRS(8PSK)
GSM 1900 Middle Channel	-30°C/Normal Voltage	0.00528	0.00952	0.01280
	-20°C/Normal Voltage	0.01113	-0.00388	0.01079
	-10°C/Normal Voltage	0.00937	-0.00376	0.01193
	0°C/Normal Voltage	0.01171	0.02221	0.01246
	10°C/Normal Voltage	0.01095	-0.00257	0.01229
	20°C/Normal Voltage	0.01118	0.01919	0.01015
	30°C/Normal Voltage	0.00898	-0.01524	0.00837
	40°C/Normal Voltage	0.01025	-0.00593	0.00801
	50°C/Normal Voltage	0.00669	-0.01781	0.00927
	55°C/Normal Voltage	0.00650	-0.01255	0.01565
	20°C/Min Voltage	0.00465	0.02169	0.00912
	20°C/Max Voltage	0.00989	-0.01248	0.00939
/	/	RMC		
WCDMA Band II Middle Channel	-30°C/Normal Voltage		-0.00136	
	-20°C/Normal Voltage		-0.00144	
	-10°C/Normal Voltage		-0.00186	
	0°C/Normal Voltage		-0.00111	
	10°C/Normal Voltage		-0.00132	
	20°C/Normal Voltage		-0.00229	
	30°C/Normal Voltage		-0.00227	
	40°C/Normal Voltage		-0.00129	
	50°C/Normal Voltage		-0.00166	
	55°C/Normal Voltage		0.00148	
	20°C/Min Voltage		-0.00226	
	20°C/Max Voltage		-0.00089	

Bandwidth	Test status	LTE Band 2 Middle Channel Test Results (ppm)	
		QPSK	16QAM
1.4MHz	-30°C/Normal Voltage	0.00113	0.00078
	-20°C/Normal Voltage	0.00127	-0.00263
	-10°C/Normal Voltage	-0.00035	-0.00039
	0°C/Normal Voltage	-0.00078	0.00251
	10°C/Normal Voltage	-0.00065	-0.00055
	20°C/Normal Voltage	0.00071	0.00016
	30°C/Normal Voltage	-0.00019	0.00109
	40°C/Normal Voltage	0.00002	0.00119
	50°C/Normal Voltage	-0.00061	0.00114
	55°C/Normal Voltage	0.00015	-0.00014
	20°C/Min Voltage	0.00138	-0.00138
	20°C/Max Voltage	-0.00011	-0.00028
3MHz	-30°C/Normal Voltage	-0.00047	0.00189
	-20°C/Normal Voltage	-0.00045	-0.00030
	-10°C/Normal Voltage	-0.00049	0.00234
	0°C/Normal Voltage	0.00147	-0.00162
	10°C/Normal Voltage	-0.00107	0.00024
	20°C/Normal Voltage	0.00161	-0.00062
	30°C/Normal Voltage	-0.00158	0.00016
	40°C/Normal Voltage	0.00134	-0.00023
	50°C/Normal Voltage	-0.00085	0.00138
	55°C/Normal Voltage	0.00211	-0.00048
	20°C/Min Voltage	-0.00022	-0.00110
	20°C/Max Voltage	-0.00055	-0.00014
5MHz	-30°C/Normal Voltage	0.00088	0.00032
	-20°C/Normal Voltage	0.00090	0.00159
	-10°C/Normal Voltage	-0.00047	0.00241
	0°C/Normal Voltage	0.00161	-0.00021
	10°C/Normal Voltage	-0.00053	0.00026
	20°C/Normal Voltage	0.00087	-0.00086
	30°C/Normal Voltage	0.00108	-0.00060
	40°C/Normal Voltage	0.00036	0.00132
	50°C/Normal Voltage	0.00002	-0.00027
	55°C/Normal Voltage	0.00104	0.00129
	20°C/Min Voltage	0.00061	0.00065
	20°C/Max Voltage	-0.00042	0.00099



10MHz	-30°C/Normal Voltage	-0.00094	-0.00108
	-20°C/Normal Voltage	0.00067	0.00004
	-10°C/Normal Voltage	0.00028	0.00065
	0°C/Normal Voltage	0.00093	-0.00233
	10°C/Normal Voltage	0.00069	-0.00019
	20°C/Normal Voltage	-0.00025	-0.00120
	30°C/Normal Voltage	0.00141	0.00016
	40°C/Normal Voltage	-0.00101	0.00066
	50°C/Normal Voltage	-0.00113	0.00124
	55°C/Normal Voltage	0.00045	-0.00066
	20°C/Min Voltage	0.00014	0.00033
	20°C/Max Voltage	-0.00175	-0.00040
	15MHz	-30°C/Normal Voltage	0.00094
-20°C/Normal Voltage		0.00046	0.00214
-10°C/Normal Voltage		-0.00044	0.00197
0°C/Normal Voltage		0.00066	-0.00085
10°C/Normal Voltage		0.00126	0.00109
20°C/Normal Voltage		0.00074	-0.00087
30°C/Normal Voltage		-0.00097	-0.00021
40°C/Normal Voltage		-0.00002	0.00131
50°C/Normal Voltage		-0.00170	0.00014
55°C/Normal Voltage		-0.00054	-0.00077
20°C/Min Voltage		0.00035	-0.00043
20°C/Max Voltage		0.00154	-0.00118
20MHz		-30°C/Normal Voltage	0.00041
	-20°C/Normal Voltage	0.00088	-0.00078
	-10°C/Normal Voltage	0.00072	0.00152
	0°C/Normal Voltage	0.00023	0.00161
	10°C/Normal Voltage	-0.00011	0.00159
	20°C/Normal Voltage	-0.00065	0.00023
	30°C/Normal Voltage	0.00088	-0.00066
	40°C/Normal Voltage	0.00180	0.00104
	50°C/Normal Voltage	-0.00062	-0.00091
	55°C/Normal Voltage	0.00081	-0.00101
	20°C/Min Voltage	0.00062	0.00005
	20°C/Max Voltage	0.00035	0.00152

5.7. Spurious Emissions at Antenna Terminals

Ambient condition

Temperature	Relative humidity	Pressure
23°C ~25°C	45%~50%	101.5kPa

Method of Measurement

The EUT was connected to Spectrum Analyzer and Base Station Simulator via power Splitter. The measurement is carried out using a spectrum analyzer. The spectrum analyzer scans from 9kHz to the 10th harmonic of the carrier. The peak detector is used.set RBW 1MHz and VBW is 3MHz, Sweep is set to ATUO.

Test setup

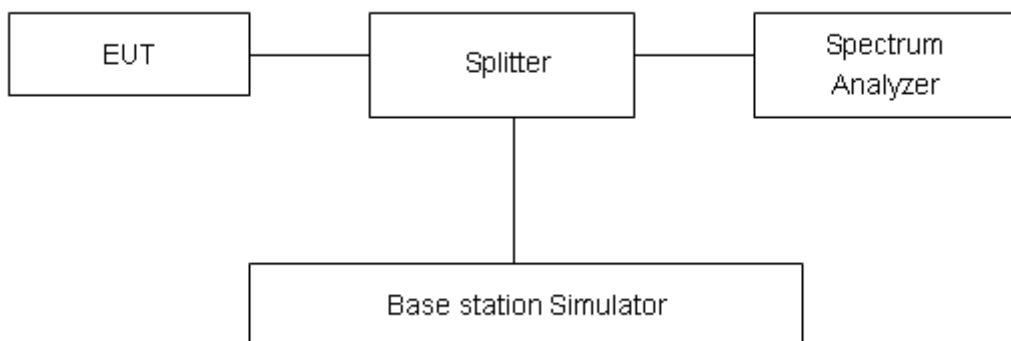

Limits

Rule Part 24.238(a) specifies that “on any frequency outside a licensee’s frequency block, the power of any emission shall be attenuated below the transmitter power (P) by at least 43 + 10 log₁₀ (P) dB.”

Limit	-13 dBm
-------	---------

Measurement Uncertainty

The assessed measurement uncertainty to ensure 99.75% confidence level for the normal distribution is with the coverage factor $k = 1.96$.

Frequency	Uncertainty
9kHz-1GHz	0.684 dB
1GHz-20GHz	1.407 dB

Test Result

Sweep from 9 kHz to 30MHz, and the emissions more than 20 dB below the permissible value are not reported.

If disturbances were found more than 20dB below limit line, the mark is not required for the EUT.

The signal beyond the limit is carrier.

GSM 1900 CH-Low 30MHz~18GHz

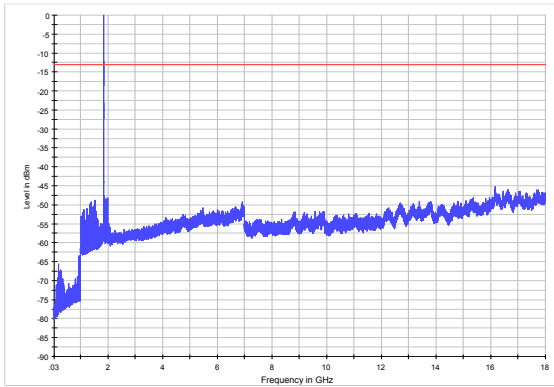

GSM 1900 CH-Low 18GHz~20GHz

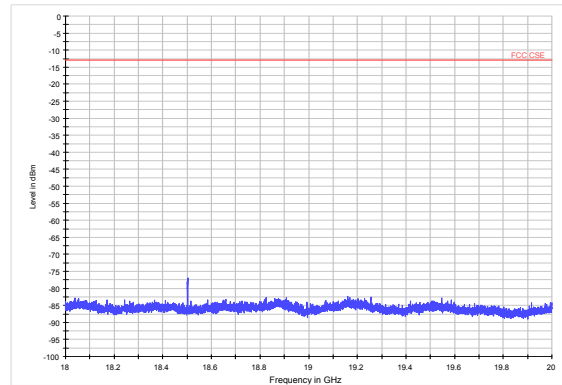

GSM 1900 CH-Middle 30MHz~18GHz

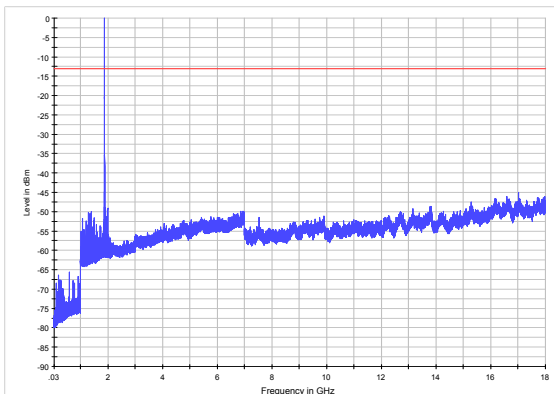

GSM 1900 CH-Middle 18GHz~20GHz

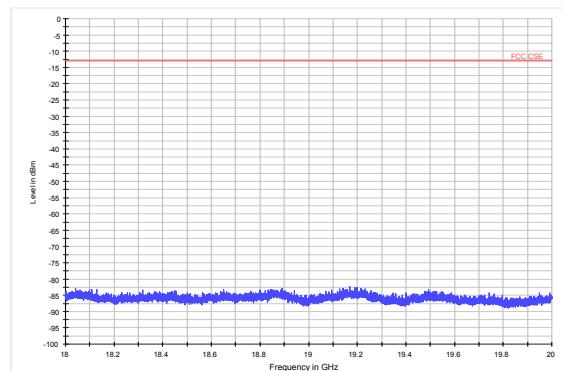

GSM 1900 CH-High 30MHz~18GHz

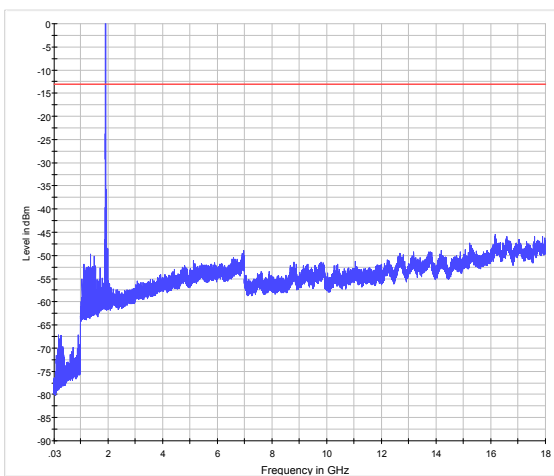

GSM 1900 CH-High 18GHz~20GHz

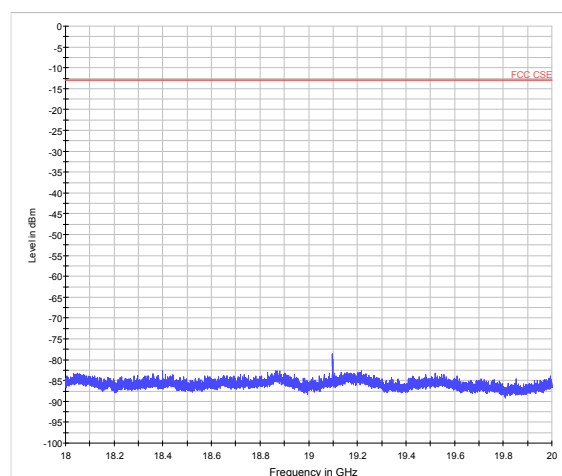



WCDMA Band II CH-Low 30MHz~18GHz

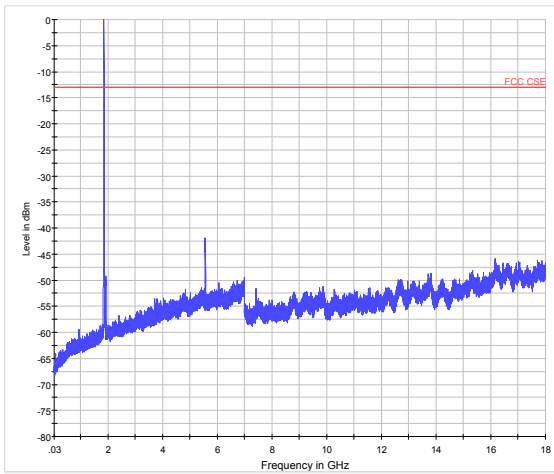

WCDMA Band II CH-Low 18GHz~20GHz

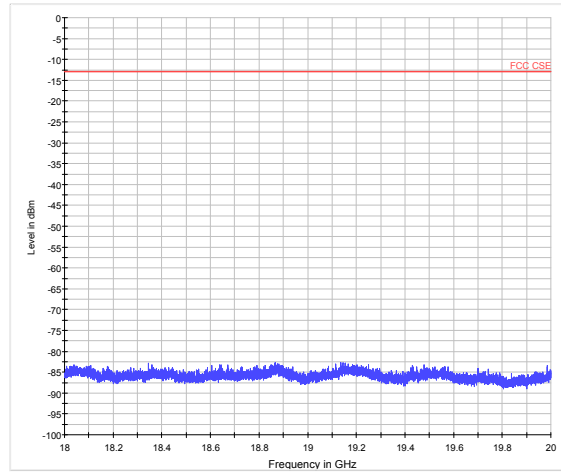

WCDMA Band II CH-Middle 30MHz~18GHz

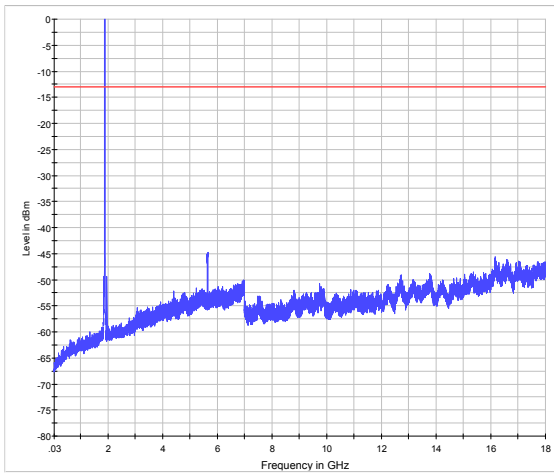

WCDMA Band II CH-Middle 18GHz~20GHz

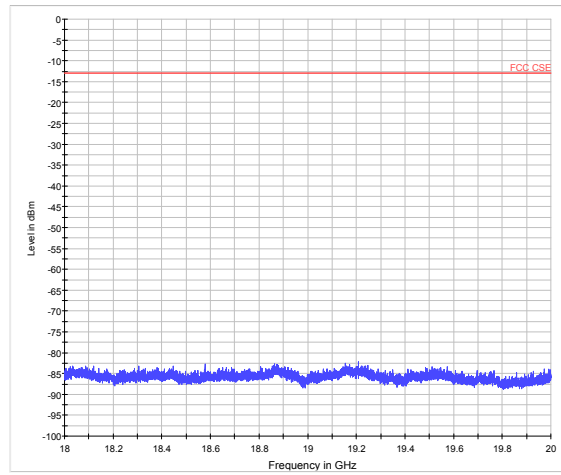

WCDMA Band II CH-High 30MHz~18GHz

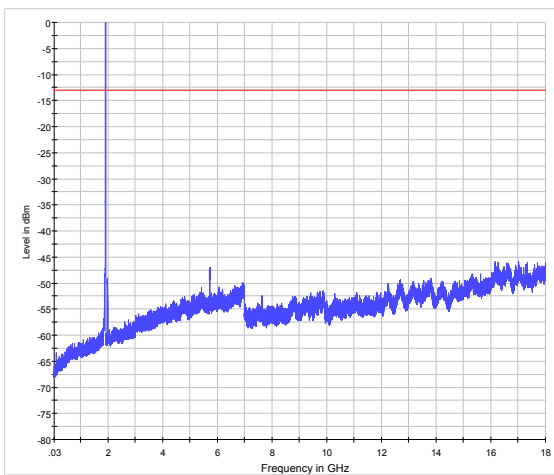

WCDMA Band II CH-High 18GHz~20GHz

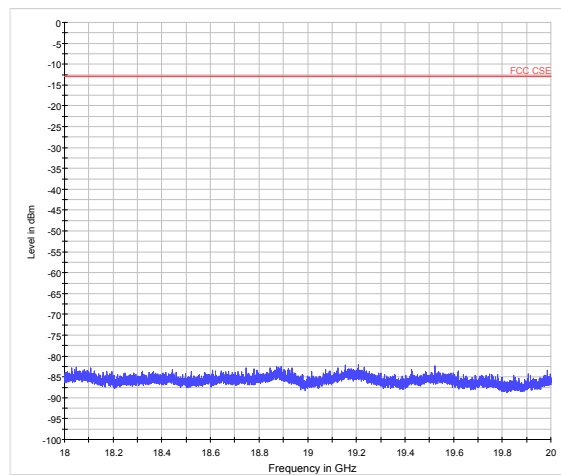

LTE Band 2 1.4MHz CH-Low 30MHz~3GHz

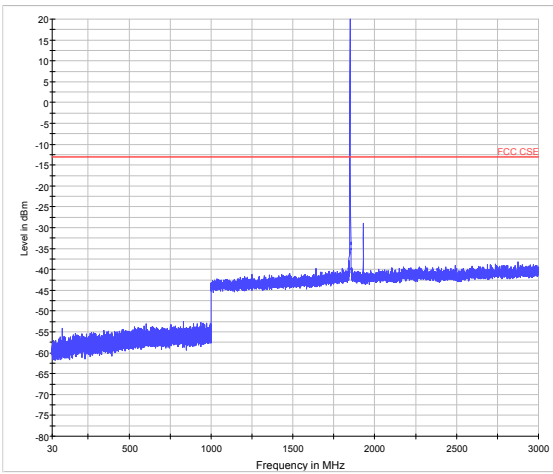

LTE Band 2 1.4MHz CH-Middle 30MHz~3GHz

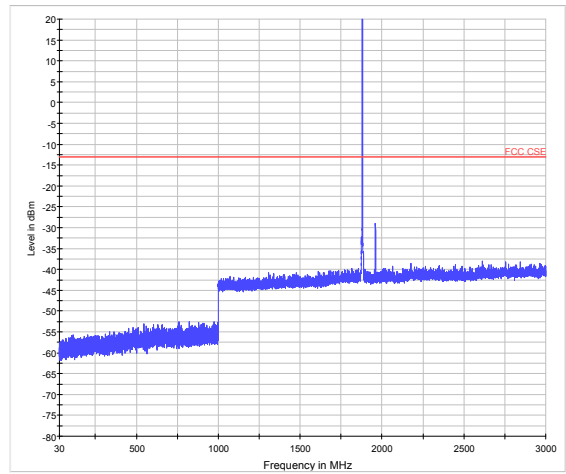

LTE Band 2 1.4MHz CH-Low 3GHz~18GHz

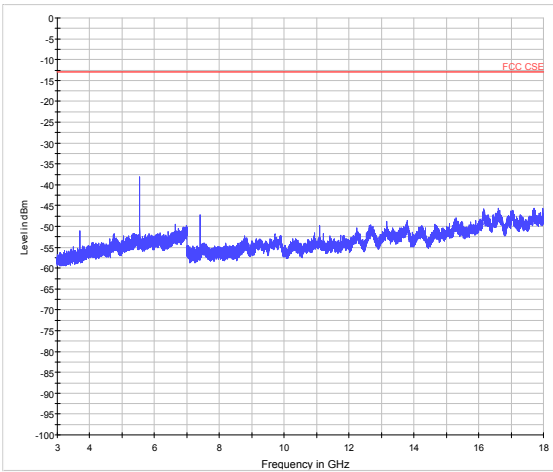

LTE Band 2 1.4MHz CH-Middle 3GHz~18GHz

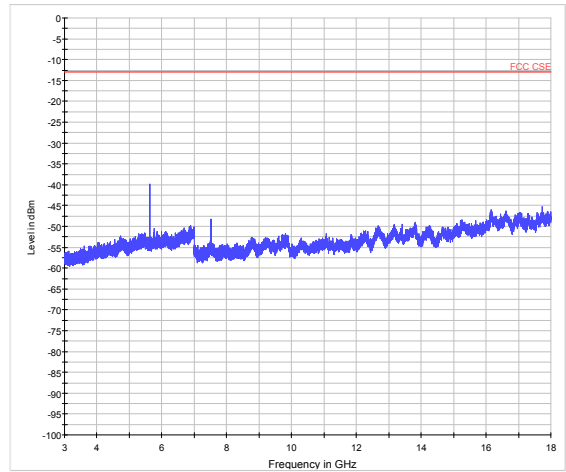

LTE Band 2 1.4MHz CH-Low 18GHz~20GHz

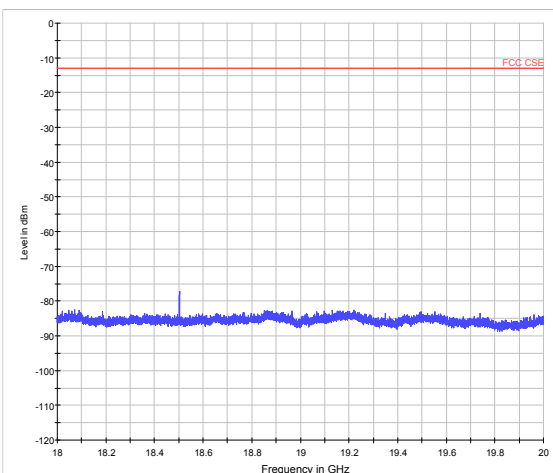

LTE Band 2 1.4MHz CH-Middle 18GHz~20GHz

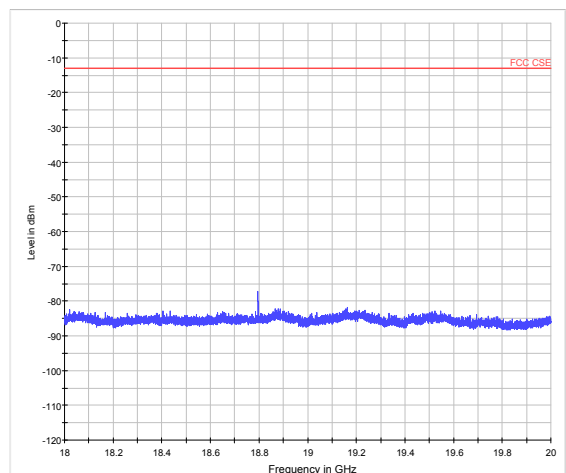



LTE Band 2 1.4MHz CH-High 30MHz~3GHz

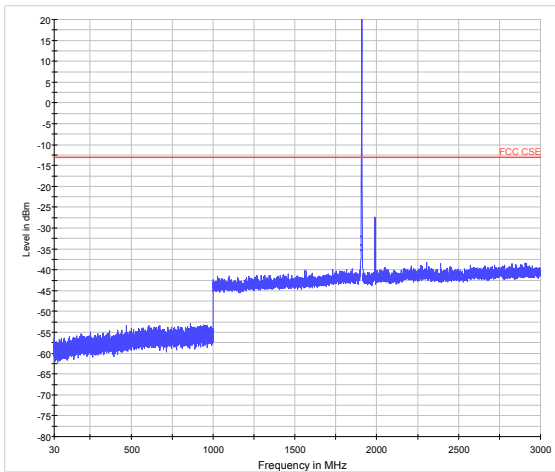

LTE Band 2 3MHz CH-Low 30MHz~3GHz

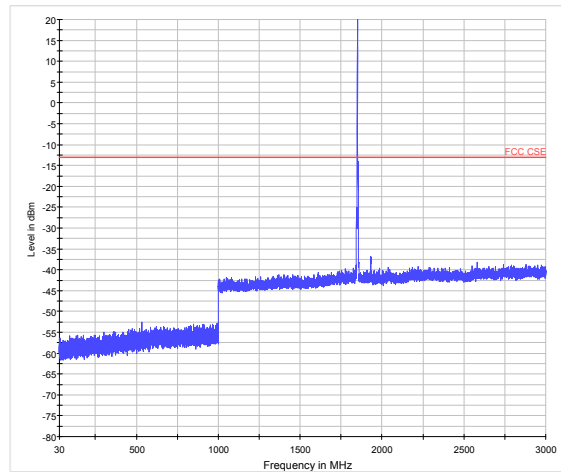

LTE Band 2 1.4MHz CH-High 3GHz~18GHz

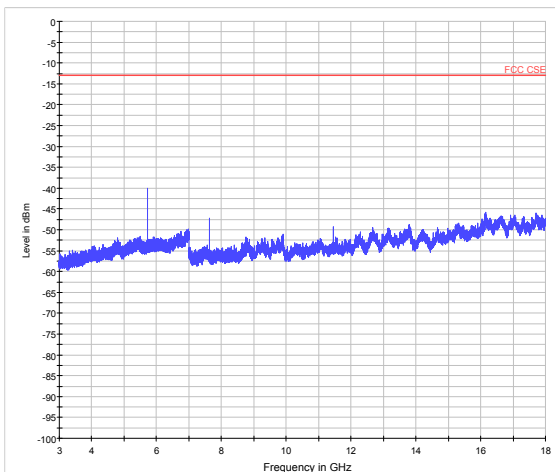

LTE Band 2 3MHz CH-Low 3GHz~18GHz

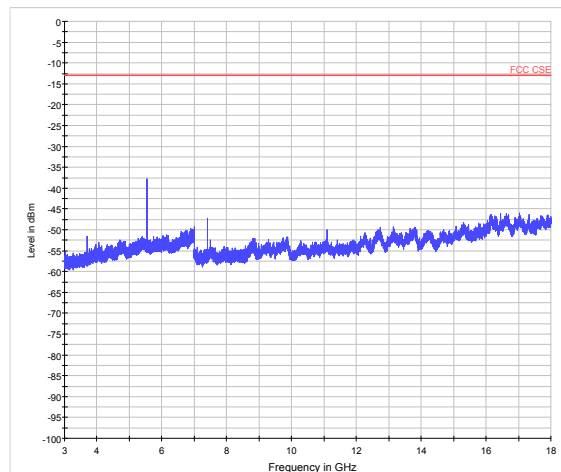

LTE Band 2 1.4MHz CH-High 18GHz~20GHz

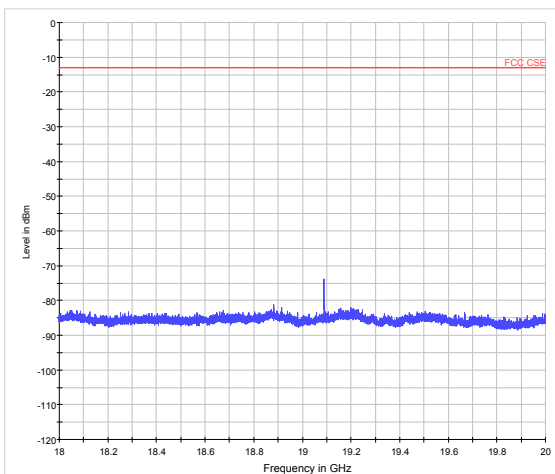

LTE Band 2 3MHz CH-Low 18GHz~20GHz

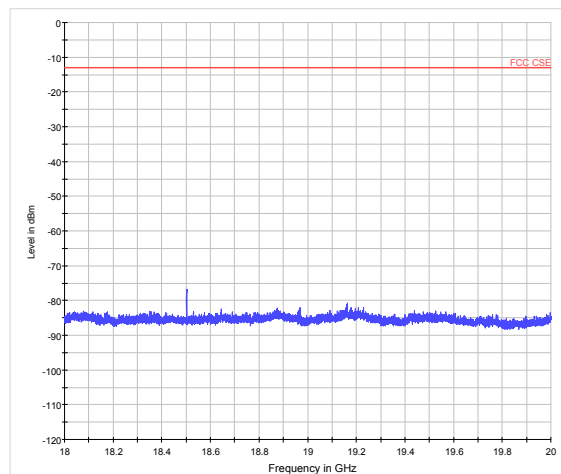

LTE Band 2 3MHz CH-Middle 30MHz~3GHz

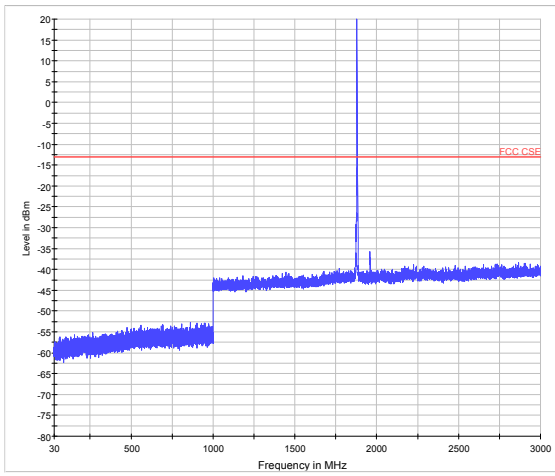

LTE Band 2 3MHz CH-High 30MHz~3GHz

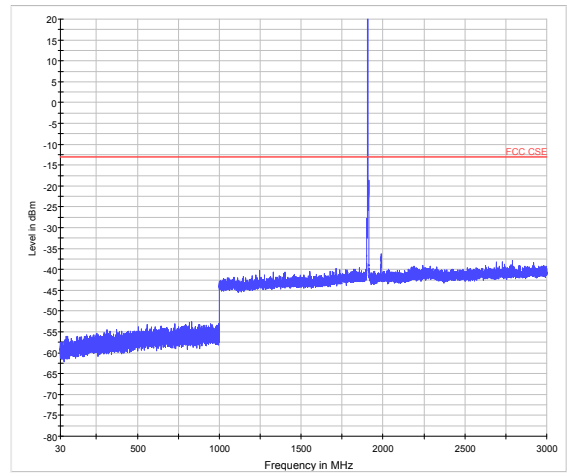

LTE Band 2 3MHz CH-Middle 3GHz~18GHz

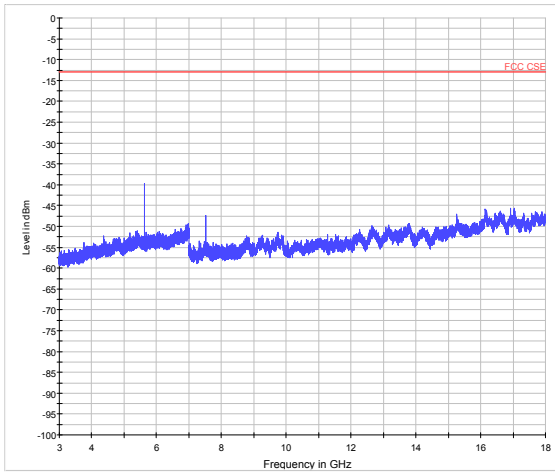

LTE Band 2 3MHz CH-High 3GHz~18GHz

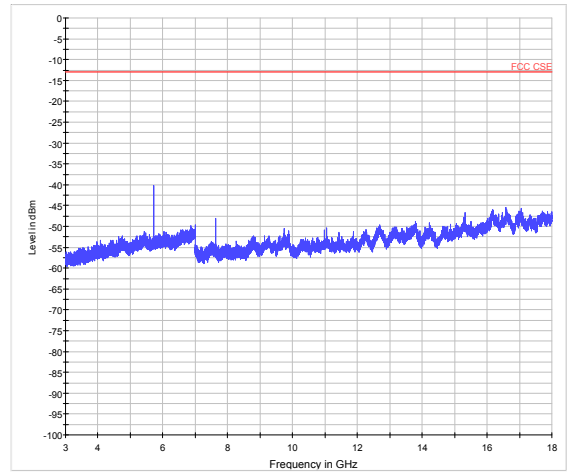

LTE Band 2 3MHz CH-Middle 18GHz~20GHz

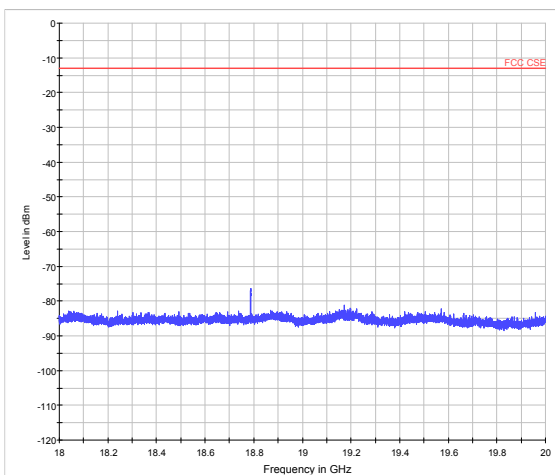

LTE Band 2 3MHz CH-High 18GHz~20GHz

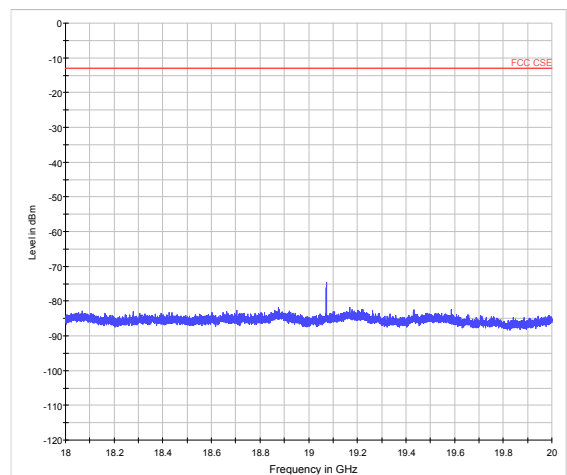



LTE Band 2 5MHz CH-Low 30MHz~3GHz

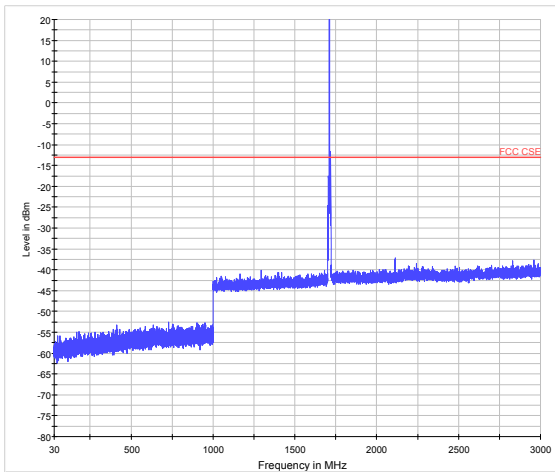

LTE Band 2 5MHz CH-Middle 30MHz~3GHz

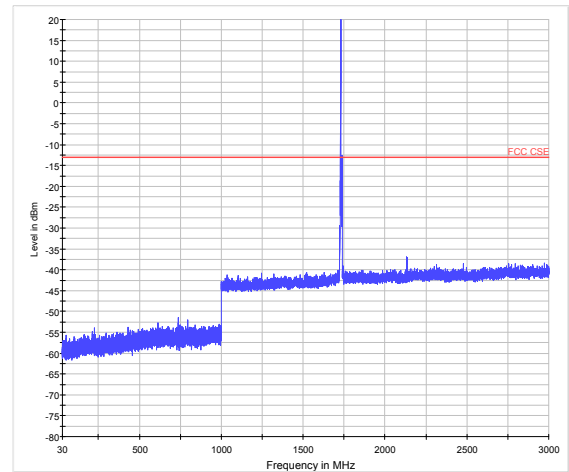

LTE Band 2 5MHz CH-Low 3GHz~18GHz

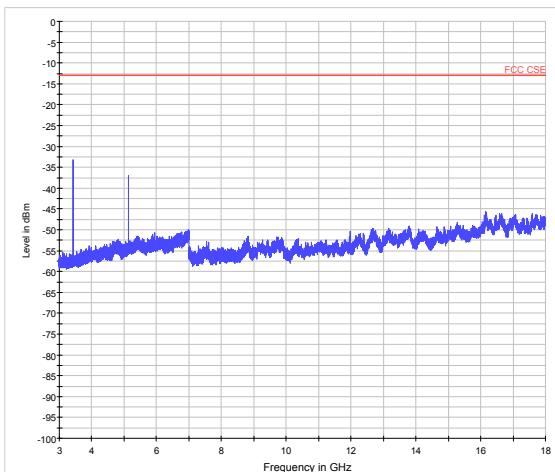

LTE Band 2 5MHz CH-Middle 3GHz~18GHz

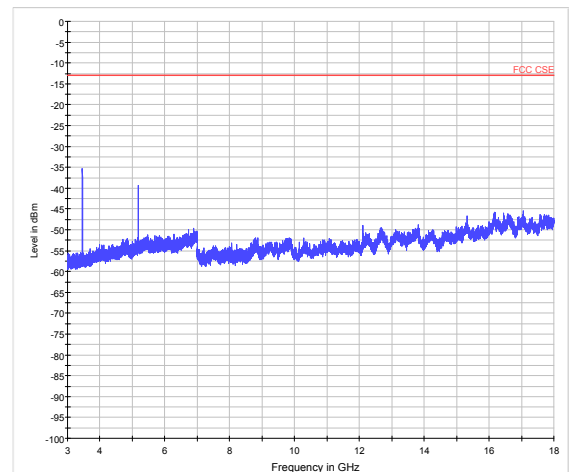

LTE Band 2 5MHz CH-Low 18GHz~20GHz

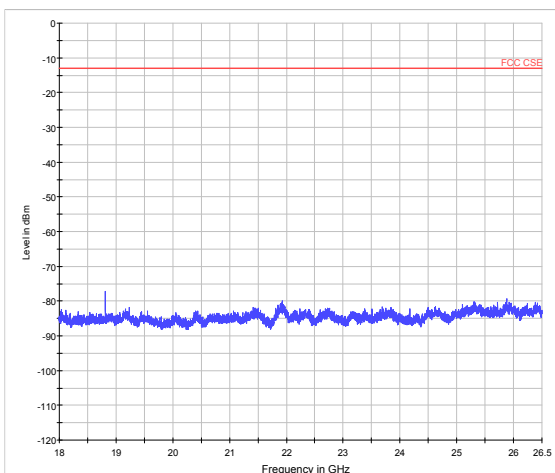

LTE Band 2 5MHz CH-Middle 18GHz~20GHz

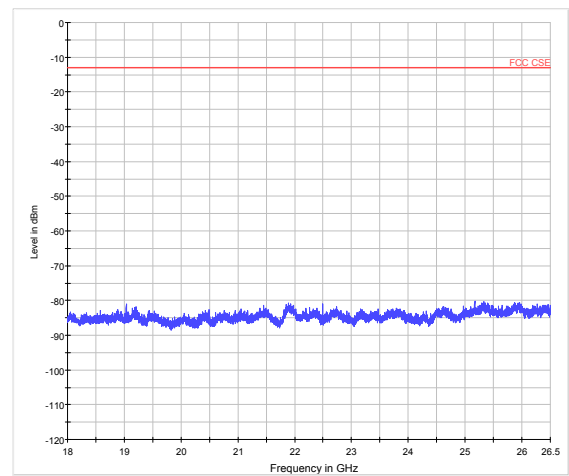



LTE Band 2 5MHz CH-High 30MHz~3GHz

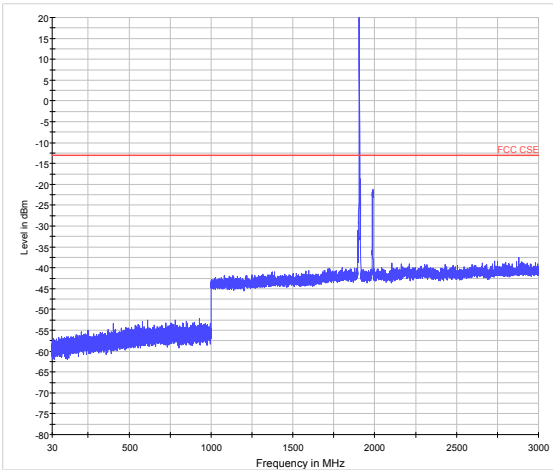

LTE Band 2 10MHz CH-Low 30MHz~3GHz

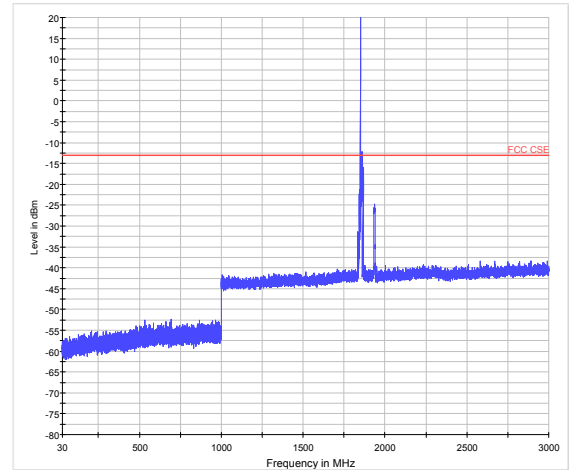

LTE Band 2 5MHz CH-High 3GHz~18GHz

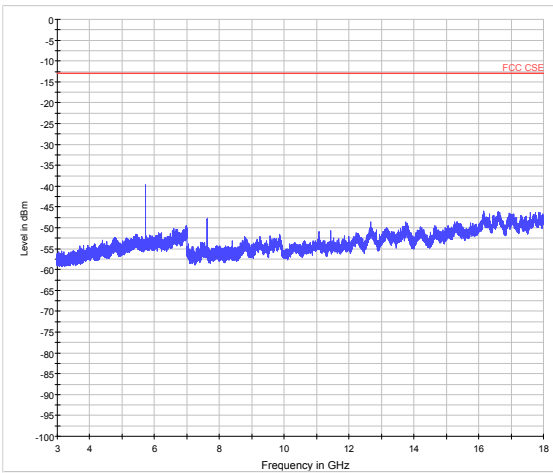

LTE Band 2 10MHz CH-Low 3GHz~18GHz

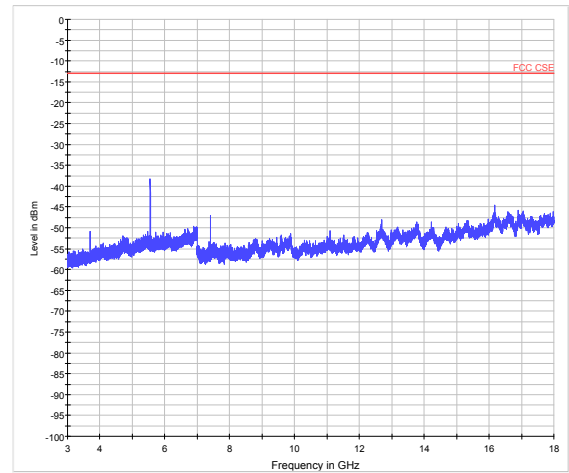

LTE Band 2 5MHz CH-High 18GHz~20GHz

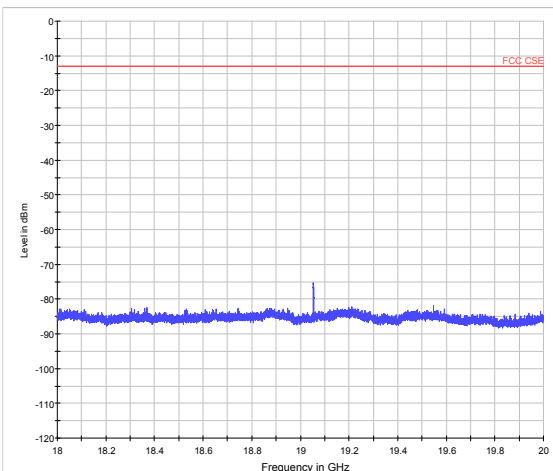

LTE Band 2 10MHz CH-Low 18GHz~20GHz

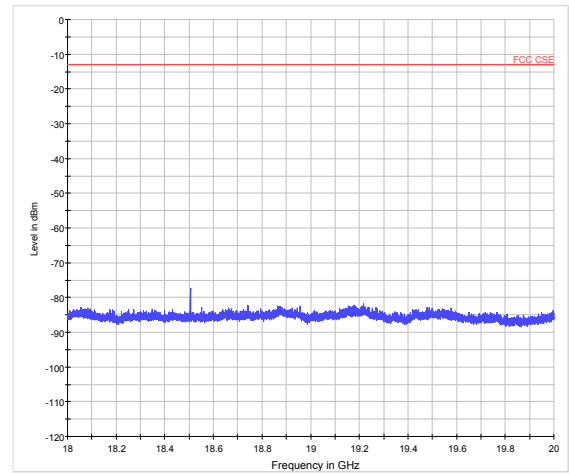



LTE Band 2 10MHz CH-Middle 30MHz~3GHz

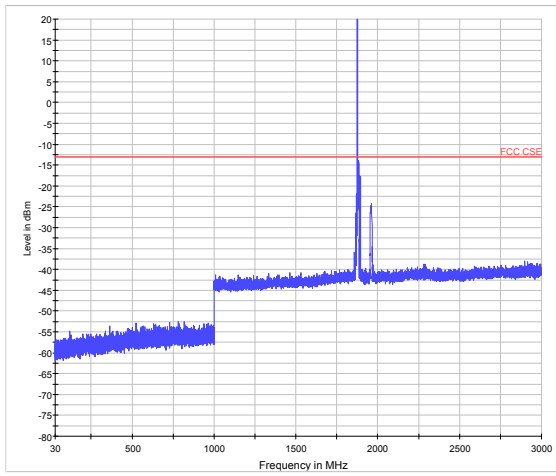

LTE Band 2 10MHz CH-High 30MHz~3GHz

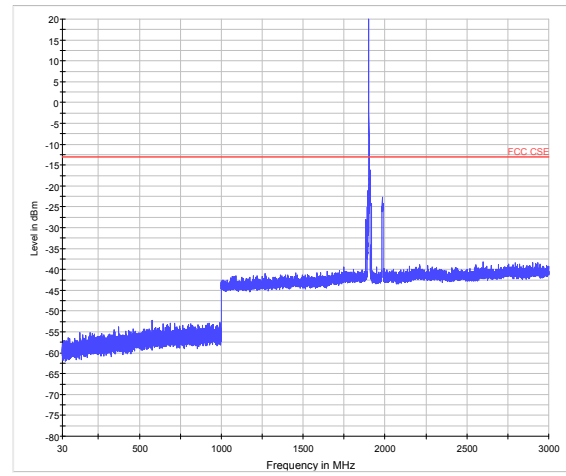

LTE Band 2 10MHz CH-Middle 3GHz~18GHz

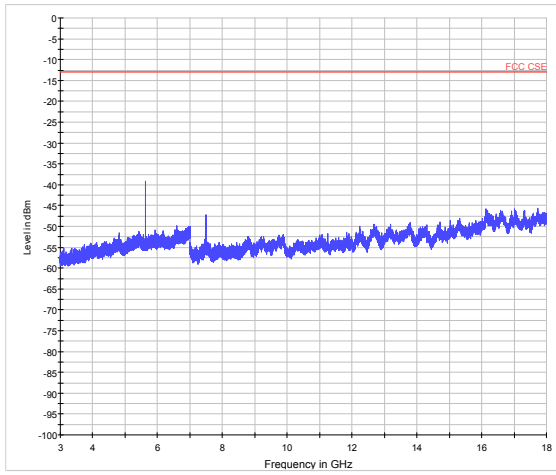

LTE Band 2 10MHz CH-High 3GHz~18GHz

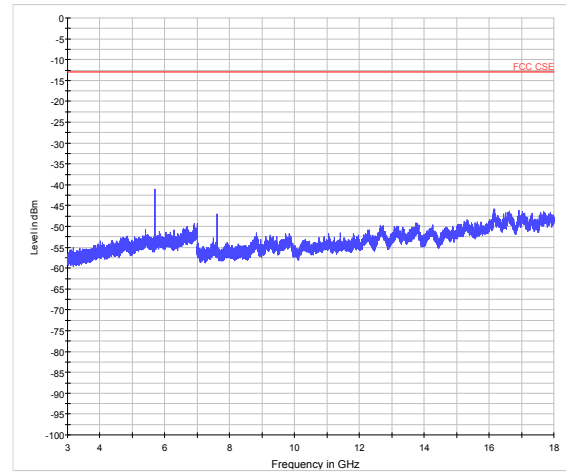

LTE Band 2 10MHz CH-Middle 18GHz~20GHz

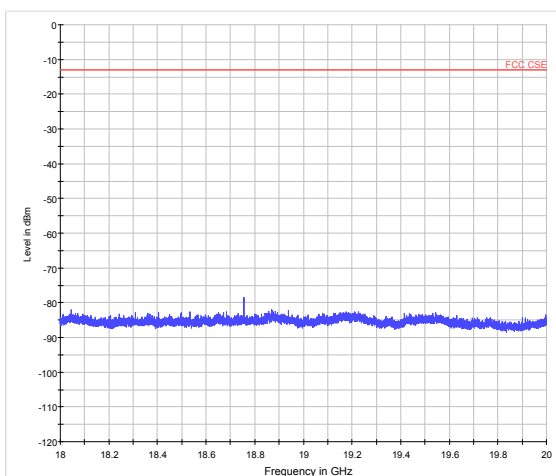

LTE Band 2 10MHz CH-High 18GHz~20GHz

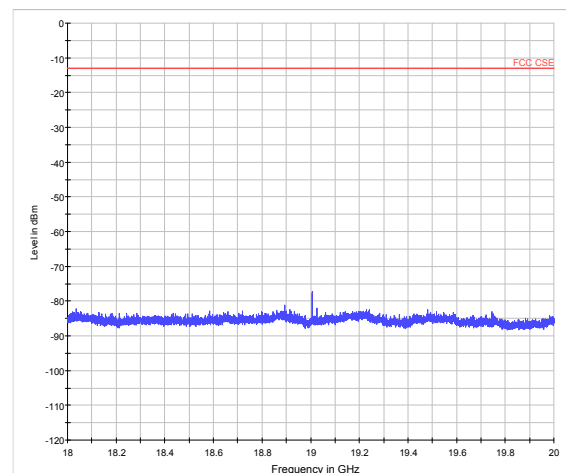



LTE Band 2 15MHz CH-Low 30MHz~3GHz

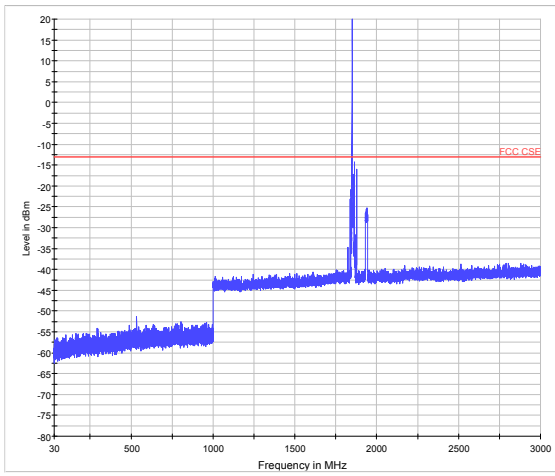

LTE Band 2 15MHz CH-Middle 30MHz~3GHz

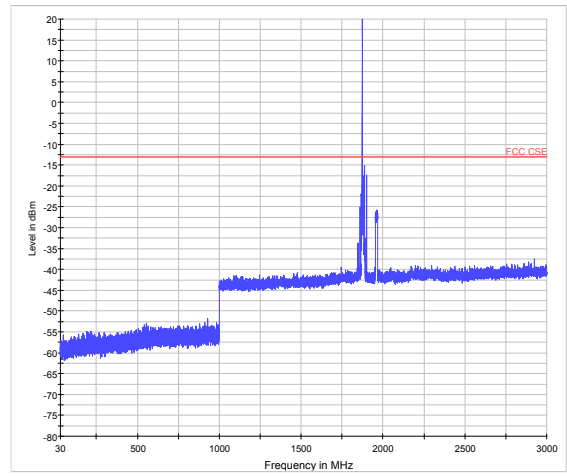

LTE Band 2 15MHz CH-Low 3GHz~18GHz

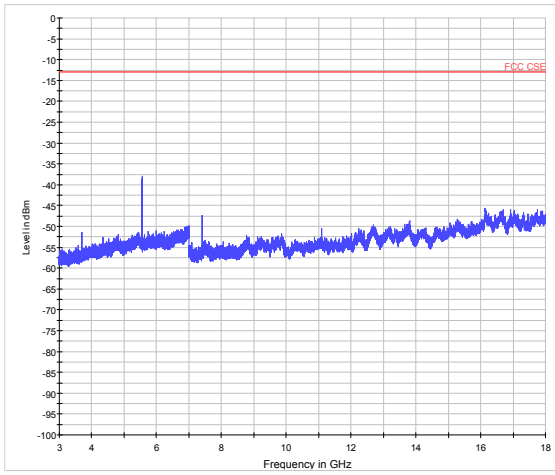

LTE Band 2 15MHz CH-Middle 3GHz~18GHz

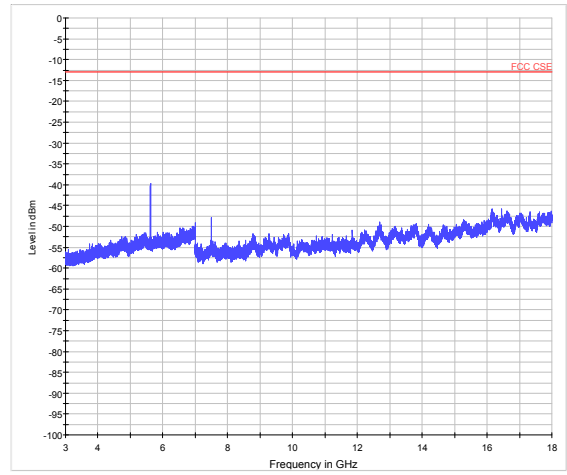

LTE Band 2 15MHz CH-Low 18GHz~20GHz

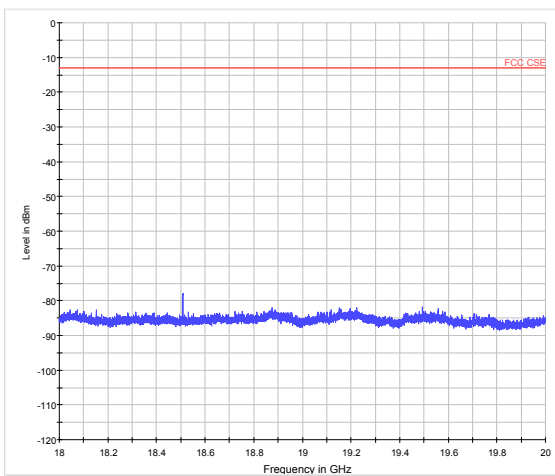

LTE Band 2 15MHz CH-Middle 18GHz~20GHz

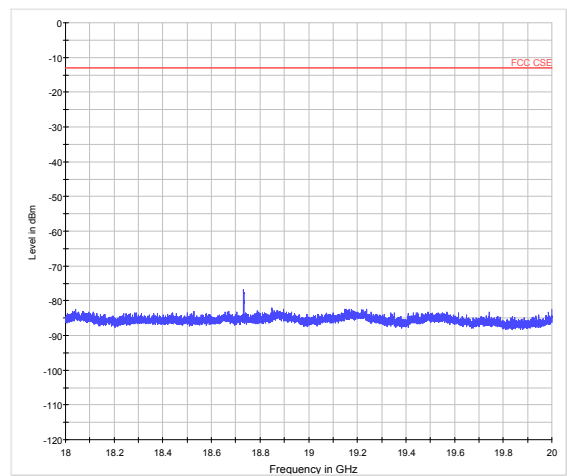



LTE Band 2 15MHz CH-High 30MHz~3GHz

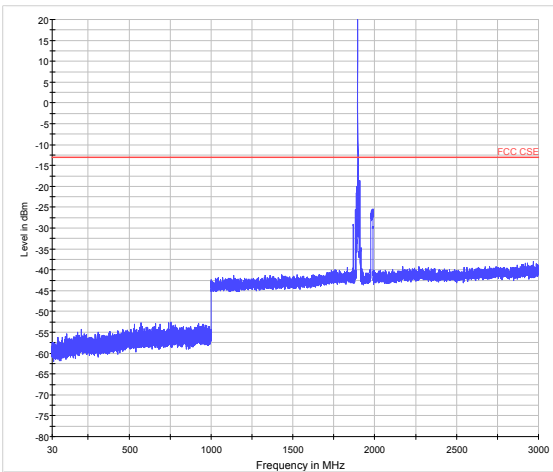

LTE Band 2 20MHz CH-Low 30MHz~3GHz

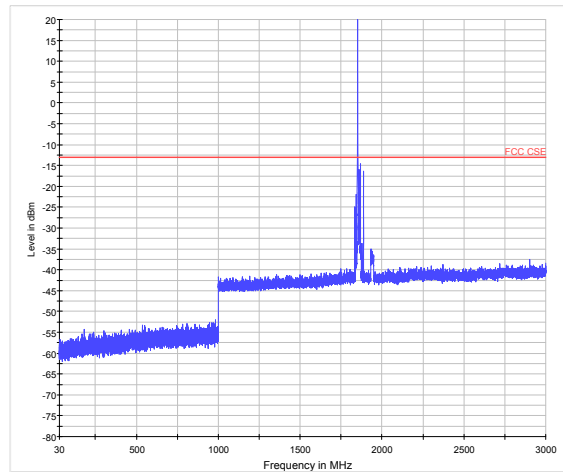

LTE Band 2 15MHz CH-High 3GHz~18GHz

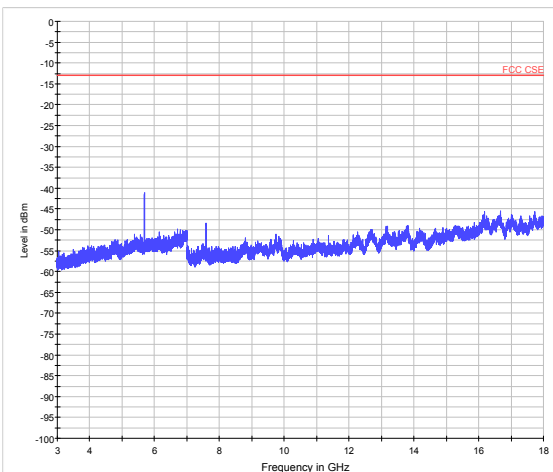

LTE Band 2 20MHz CH-Low 3GHz~18GHz

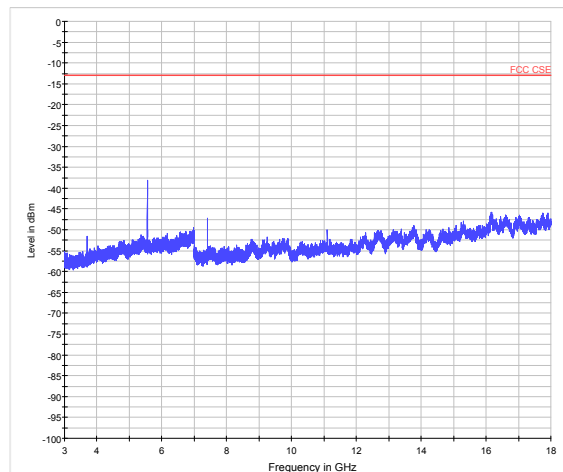

LTE Band 2 15MHz CH-High 18GHz~20GHz

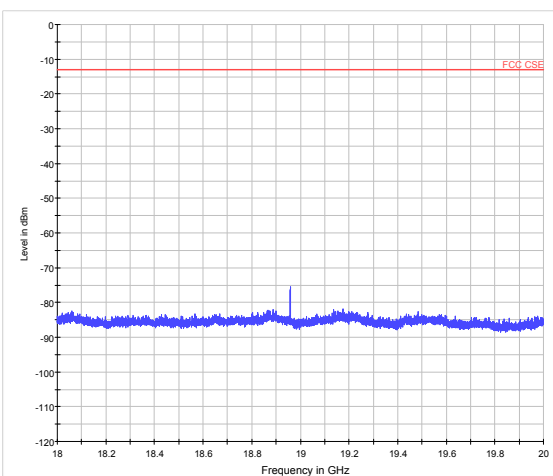

LTE Band 2 20MHz CH-Low 18GHz~20GHz

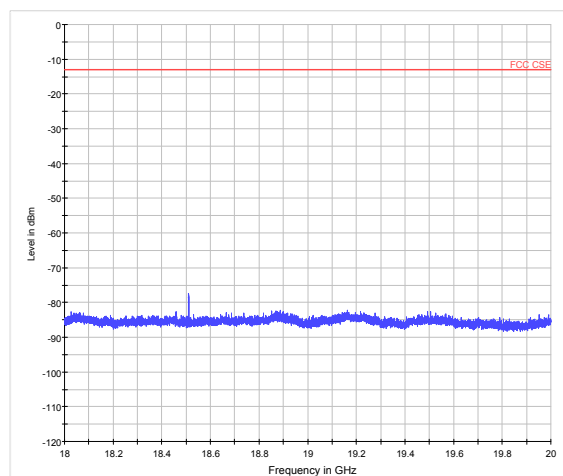



LTE Band 2 20MHz CH-Middle 30MHz~3GHz

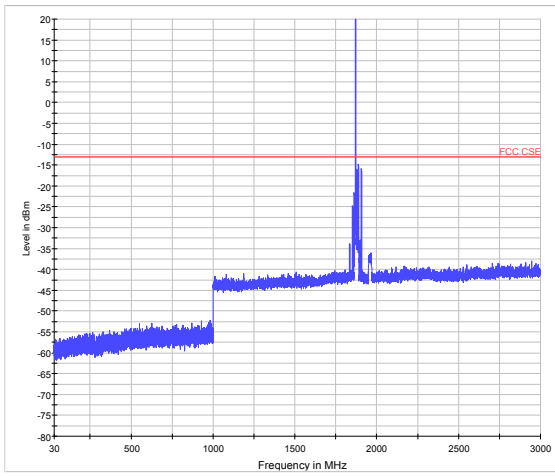

LTE Band 2 20MHz CH-High 30MHz~3GHz

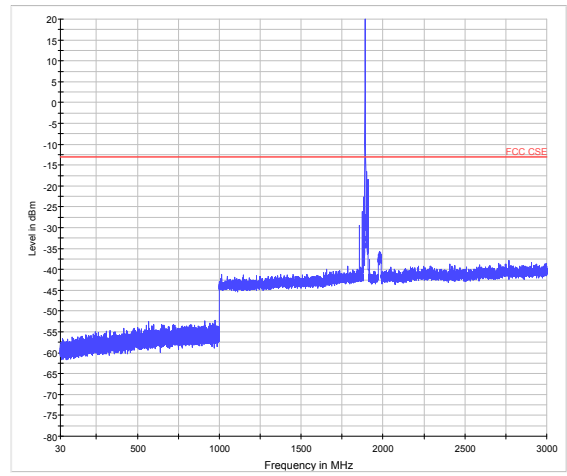

LTE Band 2 20MHz CH-Middle 3GHz~18GHz

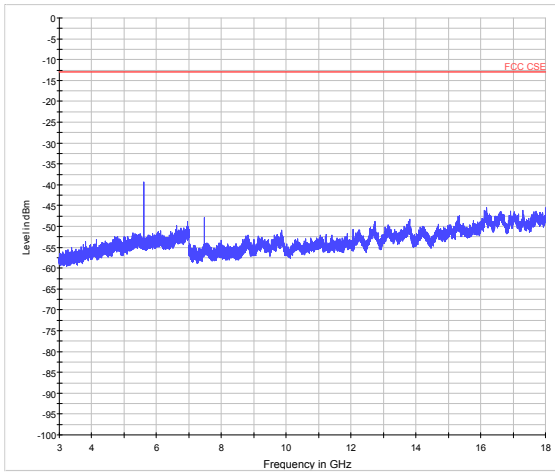

LTE Band 2 20MHz CH-High 3GHz~18GHz

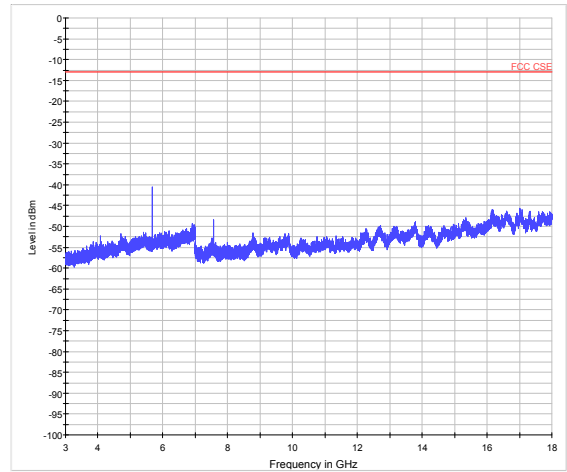

LTE Band 2 20MHz CH-Middle 18GHz~20GHz

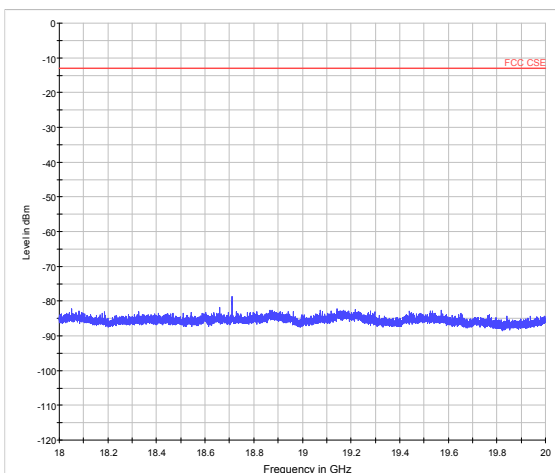

LTE Band 2 20MHz CH-High 18GHz~20GHz

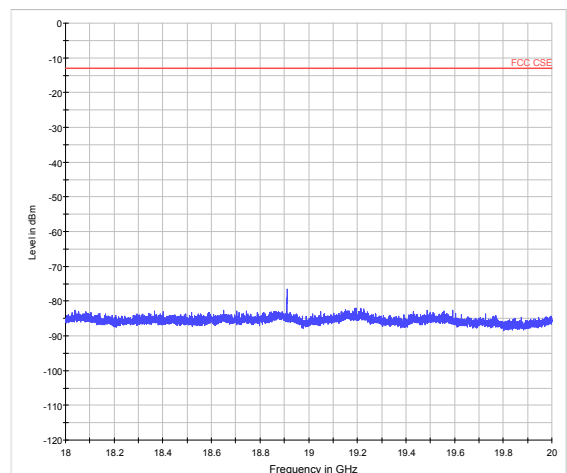

5.8. Radiates Spurious Emission

Ambient condition

Temperature	Relative humidity	Pressure
23°C ~25°C	45%~50%	101.5kPa

Method of Measurement

1. The testing follows FCC KDB 971168 v03 Section 5.8 and ANSI/TIA-603-E (2016).
2. The EUT is placed on a turntable 0.8 meters above the ground in the chamber, 3 meter away from the antenna. The maximal emission value is acquired by adjusting the antenna height, polarisation and turntable azimuth. Normally, the height range of antenna is 1 m to 4 m, the azimuth range of turntable is 0° to 360°, and the receive antenna has two polarizations Vertical (V) and Horizontal (H).
3. A log-periodic antenna or double-ridged waveguide horn antenna shall be substituted in place of the EUT. The log-periodic antenna will be driven by a signal generator and the level will be adjusted till the same power value on the spectrum analyzer or receiver. The level of the spurious emissions can be calculated through the level of the signal generator, cable loss, the gain of the substitution antenna and the reading of the spectrum analyzer or receiver.
4. The EUT is then put into continuously transmitting mode at its maximum power level during the test. Set Test Receiver or Spectrum RBW=1MHz, VBW=3MHz, And the maximum value of the receiver should be recorded as (Pr).
5. The EUT shall be replaced by a substitution antenna. In the chamber, an substitution antenna for the frequency band of interest is placed at the reference point of the chamber. An RF Signal source for the frequency band of interest is connected to the substitution antenna with a cable that has been constructed to not interfere with the radiation pattern of the antenna. A power (PMea) is applied to the input of the substitution antenna, and adjust the level of the signal generator output until the value of the receiver reach the previously recorded (Pr). The power of signal source (PMea) is recorded. The test should be performed by rotating the test item and adjusting the receiving antenna polarization.
6. A amplifier should be connected to the Signal Source output port. And the cable should be connect between the Amplifier and the Substitution Antenna. The cable loss (Pcl), the Substitution Antenna Gain (Ga) and the Amplifier Gain (PAg) should be recorded after test.
7. The measurement results are obtained as described below:
$$\text{Power(EIRP)} = \text{PMea} - \text{PAg} - \text{Pcl} + \text{Ga}$$

The measurement results are amend as described below:
$$\text{Power(EIRP)} = \text{PMea} - \text{Pcl} + \text{Ga}$$
8. This value is EIRP since the measurement is calibrated using an antenna of known gain (2.15 dBi) and known input power. ERP can be calculated from EIRP by subtracting the gain of the dipole, $\text{ERP} = \text{EIRP} - 2.15\text{dBi}$.

Test setup

30MHz~~~ 1GHz

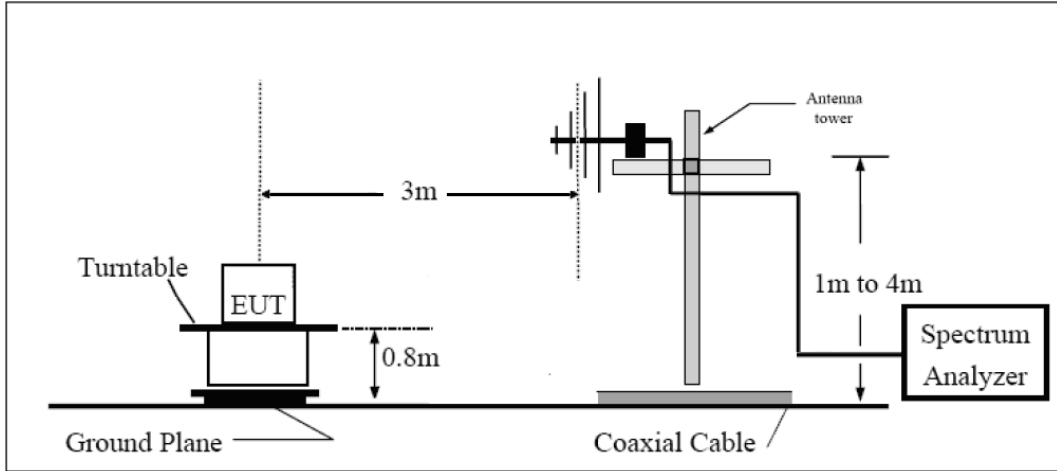

Above 1GHz

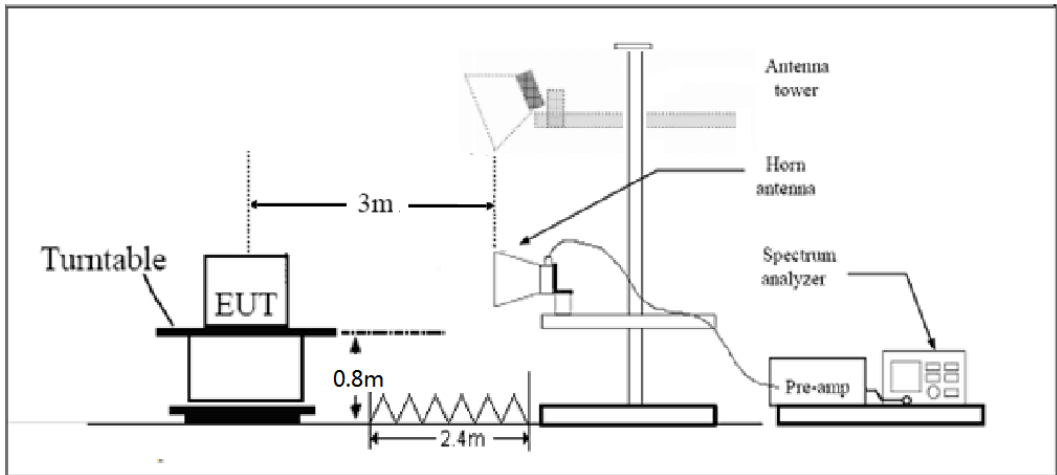

Note: Area side: 2.4mX3.6m

The radiated emission was measured in the following position: EUT stand-up position (Z axis), lie-down position (X, Y axis). The worst emission was found in lie-down position (X axis) and the worst case was recorded.

Limits

Rule Part 24.238(a) specifies that “on any frequency outside a licensee's frequency block, the power of any emission shall be attenuated below the transmitter power (P) by at least 43 + 10 log10 (P) dB.”

Limit	-13 dBm
-------	---------

Measurement Uncertainty

The assessed measurement uncertainty to ensure 95% confidence level for the normal distribution is with the coverage factor $k = 1.96$, $U = 3.55$ dB.

**Test Result**

GSM 1900 CH-Low

Harmonic	Frequency (MHz)	SG (dBm)	Cable Loss (dB)	Gain (dBi)	Antenna Polarization	EIRP Level (dBm)	Limit (dBm)	Margin (dB)	Azimuth (deg)
2	3700.4	-55.75	5.1	11.05	Horizontal	-49.80	-13.00	36.80	225
3	5550.6	-56.33	5.42	12.65	Horizontal	-49.10	-13.00	36.10	0
4	7400.8	-49.55	6.7	13.85	Horizontal	-42.40	-13.00	29.40	90
5	9251.0	-48.44	7.01	14.75	Horizontal	-40.70	-13.00	27.70	0
6	11101.2	-46.87	7.48	15.95	Horizontal	-38.40	-13.00	25.40	90
7	12951.4	-45.34	7.51	16.55	Horizontal	-36.30	-13.00	23.30	135
8	14801.6	-41.91	8.24	15.35	Horizontal	-34.80	-13.00	21.80	270
9	16651.8	-44.44	8.41	14.95	Horizontal	-37.90	-13.00	24.90	225
10	18502.0	-43.01	8.54	15.45	Horizontal	-36.10	-13.00	23.10	135

Note: 1.The other Spurious RF Radiated emissions level is no more than noise floor.
2.The worst emission was found in the antenna is Horizontal position.

GSM 1900 CH-Middle

Harmonic	Frequency (MHz)	SG (dBm)	Cable Loss (dB)	Gain (dBi)	Antenna Polarization	EIRP Level (dBm)	Limit (dBm)	Margin (dB)	Azimuth (deg)
2	3760.0	-56.45	5.1	11.05	Horizontal	-50.50	-13.00	37.50	270
3	5640.0	-55.13	5.42	12.65	Horizontal	-47.90	-13.00	34.90	135
4	7520.0	-49.45	6.7	13.85	Horizontal	-42.30	-13.00	29.30	90
5	9400.0	-48.64	7.01	14.75	Horizontal	-40.90	-13.00	27.90	225
6	11280.0	-46.07	7.48	15.95	Horizontal	-37.60	-13.00	24.60	180
7	13160.0	-48.94	7.51	16.55	Horizontal	-39.90	-13.00	26.90	45
8	15040.0	-45.31	8.24	15.35	Horizontal	-38.20	-13.00	25.20	225
9	16920.0	-43.64	8.41	14.95	Horizontal	-37.10	-13.00	24.10	180
10	18800.0	-43.41	8.54	15.45	Horizontal	-36.50	-13.00	23.50	45

Note: 1.The other Spurious RF Radiated emissions level is no more than noise floor.
2. The worst emission was found in the antenna is Horizontal position.



GSM 1900 CH-High

Harmonic	Frequency (MHz)	SG (dBm)	Cable Loss (dB)	Gain (dBi)	Antenna Polarization	EIRP Level (dBm)	Limit (dBm)	Margin (dB)	Azimuth (deg)
2	3819.6	-56.55	5.1	11.05	Horizontal	-50.60	-13.00	37.60	315
3	5729.4	-55.33	5.42	12.65	Horizontal	-48.10	-13.00	35.10	270
4	7639.2	-50.25	6.7	13.85	Horizontal	-43.10	-13.00	30.10	135
5	9549.0	-49.24	7.01	14.75	Horizontal	-41.50	-13.00	28.50	90
6	11458.8	-47.27	7.48	15.95	Horizontal	-38.80	-13.00	25.80	225
7	13368.6	-46.34	7.51	16.55	Horizontal	-37.30	-13.00	24.30	180
8	15278.4	-46.41	8.24	15.35	Horizontal	-39.30	-13.00	26.30	45
9	17188.2	-43.64	8.41	14.95	Horizontal	-37.10	-13.00	24.10	225
10	19098.0	-42.91	8.54	15.45	Horizontal	-36.00	-13.00	23.00	180

Note: 1. The other Spurious RF Radiated emissions level is no more than noise floor.
2. The worst emission was found in the antenna is Horizontal position.

WCDMA Band II CH-Low

Harmonic	Frequency (MHz)	SG (dBm)	Cable Loss (dB)	Gain (dBi)	Antenna Polarization	EIRP Level (dBm)	Limit (dBm)	Margin (dB)	Azimuth (deg)
2	3704.8	-56.55	5.1	11.05	Horizontal	-50.60	-13.00	37.60	180
3	5557.2	-53.63	5.42	12.65	Horizontal	-46.40	-13.00	33.40	270
4	7409.6	-50.55	6.7	13.85	Horizontal	-43.40	-13.00	30.40	135
5	9262.0	-48.54	7.01	14.75	Horizontal	-40.80	-13.00	27.80	45
6	11114.4	-43.37	7.48	15.95	Horizontal	-34.90	-13.00	21.90	270
7	12966.8	-46.64	7.51	16.55	Horizontal	-37.60	-13.00	24.60	180
8	14819.2	-44.11	8.24	15.35	Horizontal	-37.00	-13.00	24.00	270
9	16671.6	-43.44	8.41	14.95	Horizontal	-36.90	-13.00	23.90	135
10	18524.0	-42.21	8.54	15.45	Horizontal	-35.30	-13.00	22.30	180

Note: 1. The other Spurious RF Radiated emissions level is no more than noise floor.
2. The worst emission was found in the antenna is Horizontal position.



WCDMA Band II CH-Middle

Harmonic	Frequency (MHz)	SG (dBm)	Cable Loss (dB)	Gain (dBi)	Antenna Polarization	EIRP Level (dBm)	Limit (dBm)	Margin (dB)	Azimuth (deg)
2	3760.0	-56.05	5.1	11.05	Horizontal	-50.10	-13.00	37.10	270
3	5640.0	-52.83	5.42	12.65	Horizontal	-45.60	-13.00	32.60	135
4	7520.0	-50.15	6.7	13.85	Horizontal	-43.00	-13.00	30.00	45
5	9400.0	-48.94	7.01	14.75	Horizontal	-41.20	-13.00	28.20	270
6	11280.0	-43.57	7.48	15.95	Horizontal	-35.10	-13.00	22.10	180
7	13160.0	-46.54	7.51	16.55	Horizontal	-37.50	-13.00	24.50	270
8	15040.0	-43.21	8.24	15.35	Horizontal	-36.10	-13.00	23.10	135
9	16920.0	-43.74	8.41	14.95	Horizontal	-37.20	-13.00	24.20	180
10	18800.0	-42.11	8.54	15.45	Horizontal	-35.20	-13.00	22.20	270

Note: 1. The other Spurious RF Radiated emissions level is no more than noise floor.

2. The worst emission was found in the antenna is Horizontal position.

WCDMA Band II CH-High

Harmonic	Frequency (MHz)	SG (dBm)	Cable Loss (dB)	Gain (dBi)	Antenna Polarization	EIRP Level (dBm)	Limit (dBm)	Margin (dB)	Azimuth (deg)
2	3813.8	-56.25	5.1	11.05	Horizontal	-50.30	-13.00	37.30	135
3	5722.8	-53.43	5.42	12.65	Horizontal	-46.20	-13.00	33.20	45
4	7630.4	-50.05	6.7	13.85	Horizontal	-42.90	-13.00	29.90	270
5	9538.0	-49.04	7.01	14.75	Horizontal	-41.30	-13.00	28.30	180
6	11445.6	-44.07	7.48	15.95	Horizontal	-35.60	-13.00	22.60	270
7	13353.2	-46.74	7.51	16.55	Horizontal	-37.70	-13.00	24.70	135
8	15260.8	-44.11	8.24	15.35	Horizontal	-37.00	-13.00	24.00	225
9	17168.4	-43.84	8.41	14.95	Horizontal	-37.30	-13.00	24.30	90
10	19076.0	-42.51	8.54	15.45	Horizontal	-35.60	-13.00	22.60	315

Note: 1. The other Spurious RF Radiated emissions level is no more than noise floor.

2. The worst emission was found in the antenna is Horizontal position.

LTE Band 2 1.4MHz CH-Low

Harmonic	Frequency (MHz)	SG (dBm)	Cable Loss (dB)	Gain (dBi)	Antenna Polarization	EIRP Level (dBm)	Limit (dBm)	Margin (dB)	Azimuth (deg)
2	3701.4	-52.39	5.1	11.05	Horizontal	-46.44	-13.00	33.44	270
3	5552.1	-55.04	5.42	12.65	Horizontal	-47.81	-13.00	34.81	180
4	7402.8	-49.51	6.7	13.85	Horizontal	-42.36	-13.00	29.36	135
5	9253.5	-47.76	7.01	14.75	Horizontal	-40.02	-13.00	27.02	270
6	11104.2	-47.33	7.48	15.95	Horizontal	-38.86	-13.00	25.86	180
7	12954.9	-46.93	7.51	16.55	Horizontal	-37.89	-13.00	24.89	225
8	14805.6	-42.70	8.24	15.35	Horizontal	-35.59	-13.00	22.59	45
9	16656.3	-42.91	8.41	14.95	Horizontal	-36.37	-13.00	23.37	270
10	18507.0	-42.03	8.54	15.45	Horizontal	-35.12	-13.00	22.12	180

Note: 1.The other Spurious RF Radiated emissions level is no more than noise floor.
2. The worst emission was found in the antenna is Horizontal position.

LTE Band 2 1.4MHz CH-Middle

Harmonic	Frequency (MHz)	SG (dBm)	Cable Loss (dB)	Gain (dBi)	Antenna Polarization	EIRP Level (dBm)	Limit (dBm)	Margin (dB)	Azimuth (deg)
2	3760.0	-53.68	5.10	11.05	Horizontal	-47.73	-13.00	34.73	135
3	5640.0	-54.20	5.42	12.65	Horizontal	-46.97	-13.00	33.97	270
4	7520.0	-49.63	6.70	13.85	Horizontal	-42.48	-13.00	29.48	180
5	9400.0	-50.37	7.01	14.75	Horizontal	-42.63	-13.00	29.63	225
6	11280.0	-46.16	7.48	15.95	Horizontal	-37.69	-13.00	24.69	270
7	13160.0	-46.44	7.51	16.55	Horizontal	-37.40	-13.00	24.40	180
8	15040.0	-44.79	8.24	15.35	Horizontal	-37.68	-13.00	24.68	135
9	16920.0	-44.21	8.41	14.95	Horizontal	-37.67	-13.00	24.67	270
10	18800.0	-42.45	8.54	15.45	Horizontal	-35.54	-13.00	22.54	180

Note: 1.The other Spurious RF Radiated emissions level is no more than noise floor.
2. The worst emission was found in the antenna is Horizontal position.

LTE Band 2 1.4MHz CH-High

Harmonic	Frequency (MHz)	SG (dBm)	Cable Loss (dB)	Gain (dBi)	Antenna Polarization	EIRP Level (dBm)	Limit (dBm)	Margin (dB)	Azimuth (deg)
2	3818.6	-53.11	5.10	11.05	Horizontal	-47.16	-13.00	34.16	225
3	5727.9	-53.43	5.42	12.65	Horizontal	-46.20	-13.00	33.20	45
4	7637.2	-49.58	6.70	13.85	Horizontal	-42.43	-13.00	29.43	270
5	9546.5	-50.00	7.01	14.75	Horizontal	-42.26	-13.00	29.26	180
6	11455.8	-46.16	7.48	15.95	Horizontal	-37.69	-13.00	24.69	135
7	13365.1	-46.23	7.51	16.55	Horizontal	-37.19	-13.00	24.19	270
8	15274.4	-44.79	8.24	15.35	Horizontal	-37.68	-13.00	24.68	180
9	17183.7	-44.18	8.41	14.95	Horizontal	-37.64	-13.00	24.64	225
10	19093.0	-42.56	8.54	15.45	Horizontal	-35.65	-13.00	22.65	45

Note: 1.The other Spurious RF Radiated emissions level is no more than noise floor.
2. The worst emission was found in the antenna is Horizontal position.

LTE Band 2 3MHz CH-Low

Harmonic	Frequency (MHz)	SG (dBm)	Cable Loss (dB)	Gain (dBi)	Antenna Polarization	EIRP Level (dBm)	Limit (dBm)	Margin (dB)	Azimuth (deg)
2	3703.0	-53.65	5.10	11.05	Horizontal	-47.70	-13.00	34.70	90
3	5554.5	-54.33	5.42	12.65	Horizontal	-47.10	-13.00	34.10	270
4	7406.0	-49.85	6.70	13.85	Horizontal	-42.70	-13.00	29.70	180
5	9257.5	-48.24	7.01	14.75	Horizontal	-40.50	-13.00	27.50	135
6	11109.0	-47.17	7.48	15.95	Horizontal	-38.70	-13.00	25.70	270
7	12960.5	-46.34	7.51	16.55	Horizontal	-37.30	-13.00	24.30	180
8	14812.0	-42.61	8.24	15.35	Horizontal	-35.50	-13.00	22.50	225
9	16663.5	-43.14	8.41	14.95	Horizontal	-36.60	-13.00	23.60	45
10	18515.0	-41.71	8.54	15.45	Horizontal	-34.80	-13.00	21.80	90

Note: 1.The other Spurious RF Radiated emissions level is no more than noise floor.
2. The worst emission was found in the antenna is Horizontal position.



LTE Band 2 3MHz CH-Middle

Harmonic	Frequency (MHz)	SG (dBm)	Cable Loss (dB)	Gain (dBi)	Antenna Polarization	EIRP Level (dBm)	Limit (dBm)	Margin (dB)	Azimuth (deg)
2	3760.0	-52.66	5.10	11.05	Horizontal	-46.71	-13.00	33.71	180
3	5640.0	-55.15	5.42	12.65	Horizontal	-47.92	-13.00	34.92	270
4	7520.0	-49.85	6.70	13.85	Horizontal	-42.70	-13.00	29.70	45
5	9400.0	-48.04	7.01	14.75	Horizontal	-40.30	-13.00	27.30	90
6	11280.0	-47.67	7.48	15.95	Horizontal	-39.20	-13.00	26.20	135
7	13160.0	-47.94	7.51	16.55	Horizontal	-38.90	-13.00	25.90	225
8	15040.0	-44.91	8.24	15.35	Horizontal	-37.80	-13.00	24.80	180
9	16920.0	-43.04	8.41	14.95	Horizontal	-36.50	-13.00	23.50	270
10	18800.0	-42.21	8.54	15.45	Horizontal	-35.30	-13.00	22.30	45

Note: 1.The other Spurious RF Radiated emissions level is no more than noise floor.

2. The worst emission was found in the antenna is Horizontal position.

LTE Band 2 3MHz CH-High

Harmonic	Frequency (MHz)	SG (dBm)	Cable Loss (dB)	Gain (dBi)	Antenna Polarization	EIRP Level (dBm)	Limit (dBm)	Margin (dB)	Azimuth (deg)
2	3817.0	-52.59	5.10	11.05	Horizontal	-46.64	-13.00	33.64	270
3	5725.5	-54.83	5.42	12.65	Horizontal	-47.60	-13.00	34.60	180
4	7634.0	-50.75	6.70	13.85	Horizontal	-43.60	-13.00	30.60	225
5	9542.5	-50.14	7.01	14.75	Horizontal	-42.40	-13.00	29.40	45
6	11451.0	-46.27	7.48	15.95	Horizontal	-37.80	-13.00	24.80	90
7	13359.5	-46.34	7.51	16.55	Horizontal	-37.30	-13.00	24.30	180
8	15268.0	-44.21	8.24	15.35	Horizontal	-37.10	-13.00	24.10	270
9	17176.5	-43.54	8.41	14.95	Horizontal	-37.00	-13.00	24.00	135
10	19085.0	-42.81	8.54	15.45	Horizontal	-35.90	-13.00	22.90	180

Note: 1.The other Spurious RF Radiated emissions level is no more than noise floor.

2. The worst emission was found in the antenna is Horizontal position.

LTE Band 2 5MHz CH-Low

Harmonic	Frequency (MHz)	SG (dBm)	Cable Loss (dB)	Gain (dBi)	Antenna Polarization	EIRP Level (dBm)	Limit (dBm)	Margin (dB)	Azimuth (deg)
2	3705.0	-53.63	5.10	11.05	Horizontal	-47.68	-13.00	34.68	225
3	5557.5	-55.83	5.42	12.65	Horizontal	-48.60	-13.00	35.60	45
4	7410.0	-49.25	6.70	13.85	Horizontal	-42.10	-13.00	29.10	90
5	9262.5	-48.14	7.01	14.75	Horizontal	-40.40	-13.00	27.40	180
6	11115.0	-47.67	7.48	15.95	Horizontal	-39.20	-13.00	26.20	270
7	12967.5	-46.84	7.51	16.55	Horizontal	-37.80	-13.00	24.80	180
8	14820.0	-42.21	8.24	15.35	Horizontal	-35.10	-13.00	22.10	225
9	16672.5	-43.24	8.41	14.95	Horizontal	-36.70	-13.00	23.70	45
10	18525.0	-41.66	8.54	15.45	Horizontal	-34.75	-13.00	21.75	90

Note: 1.The other Spurious RF Radiated emissions level is no more than noise floor.
2. The worst emission was found in the antenna is Horizontal position.

LTE Band 2 5MHz CH-Middle

Harmonic	Frequency (MHz)	SG (dBm)	Cable Loss (dB)	Gain (dBi)	Antenna Polarization	EIRP Level (dBm)	Limit (dBm)	Margin (dB)	Azimuth (deg)
2	3760.0	-53.93	5.10	11.05	Horizontal	-47.98	-13.00	34.98	180
3	5640.0	-55.33	5.42	12.65	Horizontal	-48.10	-13.00	35.10	135
4	7520.0	-49.45	6.70	13.85	Horizontal	-42.30	-13.00	29.30	270
5	9400.0	-48.04	7.01	14.75	Horizontal	-40.30	-13.00	27.30	180
6	11280.0	-46.67	7.48	15.95	Horizontal	-38.20	-13.00	25.20	225
7	13160.0	-48.24	7.51	16.55	Horizontal	-39.20	-13.00	26.20	45
8	15040.0	-44.61	8.24	15.35	Horizontal	-37.50	-13.00	24.50	90
9	16920.0	-42.64	8.41	14.95	Horizontal	-36.10	-13.00	23.10	270
10	18800.0	-41.91	8.54	15.45	Horizontal	-35.00	-13.00	22.00	180

Note: 1.The other Spurious RF Radiated emissions level is no more than noise floor.
2. The worst emission was found in the antenna is Horizontal position.

LTE Band 2 5MHz CH-High

Harmonic	Frequency (MHz)	SG (dBm)	Cable Loss (dB)	Gain (dBi)	Antenna Polarization	EIRP Level (dBm)	Limit (dBm)	Margin (dB)	Azimuth (deg)
2	3815.0	-52.55	5.10	11.05	Horizontal	-46.60	-13.00	33.60	225
3	5722.5	-54.63	5.42	12.65	Horizontal	-47.40	-13.00	34.40	45
4	7630.0	-50.65	6.70	13.85	Horizontal	-43.50	-13.00	30.50	135
5	9537.5	-49.34	7.01	14.75	Horizontal	-41.60	-13.00	28.60	180
6	11445.0	-44.87	7.48	15.95	Horizontal	-36.40	-13.00	23.40	225
7	13352.5	-46.44	7.51	16.55	Horizontal	-37.40	-13.00	24.40	45
8	15260.0	-44.91	8.24	15.35	Horizontal	-37.80	-13.00	24.80	90
9	17167.5	-44.44	8.41	14.95	Horizontal	-37.90	-13.00	24.90	270
10	19075.0	-42.61	8.54	15.45	Horizontal	-35.70	-13.00	22.70	180

Note: 1.The other Spurious RF Radiated emissions level is no more than noise floor.
2. The worst emission was found in the antenna is Horizontal position.

LTE Band 2 10MHz CH-Low

Harmonic	Frequency (MHz)	SG (dBm)	Cable Loss (dB)	Gain (dBi)	Antenna Polarization	EIRP Level (dBm)	Limit (dBm)	Margin (dB)	Azimuth (deg)
2	3710.0	-54.72	5.10	11.05	Horizontal	-48.77	-13.00	35.77	225
3	5565.0	-54.63	5.42	12.65	Horizontal	-47.40	-13.00	34.40	45
4	7420.0	-49.25	6.70	13.85	Horizontal	-42.10	-13.00	29.10	90
5	9275.0	-48.44	7.01	14.75	Horizontal	-40.70	-13.00	27.70	180
6	11130.0	-47.47	7.48	15.95	Horizontal	-39.00	-13.00	26.00	270
7	12985.0	-47.54	7.51	16.55	Horizontal	-38.50	-13.00	25.50	135
8	14840.0	-42.51	8.24	15.35	Horizontal	-35.40	-13.00	22.40	180
9	16695.0	-43.04	8.41	14.95	Horizontal	-36.50	-13.00	23.50	225
10	18550.0	-42.51	8.54	15.45	Horizontal	-35.60	-13.00	22.60	45

Note: 1.The other Spurious RF Radiated emissions level is no more than noise floor.
2. The worst emission was found in the antenna is Horizontal position.

LTE Band 2 10MHz CH-Middle

Harmonic	Frequency (MHz)	SG (dBm)	Cable Loss (dB)	Gain (dBi)	Antenna Polarization	EIRP Level (dBm)	Limit (dBm)	Margin (dB)	Azimuth (deg)
2	3760.0	-53.22	5.10	11.05	Horizontal	-47.27	-13.00	34.27	90
3	5640.0	-55.03	5.42	12.65	Horizontal	-47.80	-13.00	34.80	180
4	7520.0	-48.45	6.70	13.85	Horizontal	-41.30	-13.00	28.30	270
5	9400.0	-47.74	7.01	14.75	Horizontal	-40.00	-13.00	27.00	180
6	11280.0	-46.67	7.48	15.95	Horizontal	-38.20	-13.00	25.20	225
7	13160.0	-47.84	7.51	16.55	Horizontal	-38.80	-13.00	25.80	45
8	15040.0	-46.11	8.24	15.35	Horizontal	-39.00	-13.00	26.00	90
9	16920.0	-44.04	8.41	14.95	Horizontal	-37.50	-13.00	24.50	180
10	18800.0	-43.01	8.54	15.45	Horizontal	-36.10	-13.00	23.10	135

Note: 1.The other Spurious RF Radiated emissions level is no more than noise floor.
2. The worst emission was found in the antenna is Horizontal position.

LTE Band 2 10MHz CH-High

Harmonic	Frequency (MHz)	SG (dBm)	Cable Loss (dB)	Gain (dBi)	Antenna Polarization	EIRP Level (dBm)	Limit (dBm)	Margin (dB)	Azimuth (deg)
2	3810.0	-51.48	5.10	11.05	Horizontal	-45.53	-13.00	32.53	270
3	5715.0	-53.83	5.42	12.65	Horizontal	-46.60	-13.00	33.60	180
4	7620.0	-50.35	6.70	13.85	Horizontal	-43.20	-13.00	30.20	225
5	9525.0	-49.74	7.01	14.75	Horizontal	-42.00	-13.00	29.00	45
6	11430.0	-45.87	7.48	15.95	Horizontal	-37.40	-13.00	24.40	90
7	13335.0	-46.44	7.51	16.55	Horizontal	-37.40	-13.00	24.40	180
8	15240.0	-44.91	8.24	15.35	Horizontal	-37.80	-13.00	24.80	270
9	17145.0	-43.24	8.41	14.95	Horizontal	-36.70	-13.00	23.70	45
10	19050.0	-42.11	8.54	15.45	Horizontal	-35.20	-13.00	22.20	135

Note: 1.The other Spurious RF Radiated emissions level is no more than noise floor.
2. The worst emission was found in the antenna is Horizontal position.



LTE Band 2 15MHz CH-Low

Harmonic	Frequency (MHz)	SG (dBm)	Cable Loss (dB)	Gain (dBi)	Antenna Polarization	EIRP Level (dBm)	Limit (dBm)	Margin (dB)	Azimuth (deg)
2	3715.0	-53.40	5.10	11.05	Horizontal	-47.45	-13.00	34.45	45
3	5572.5	-55.13	5.42	12.65	Horizontal	-47.90	-13.00	34.90	90
4	7430.0	-49.55	6.70	13.85	Horizontal	-42.40	-13.00	29.40	90
5	9287.5	-47.34	7.01	14.75	Horizontal	-39.60	-13.00	26.60	45
6	11145.0	-46.47	7.48	15.95	Horizontal	-38.00	-13.00	25.00	135
7	13002.5	-46.74	7.51	16.55	Horizontal	-37.70	-13.00	24.70	225
8	14860.0	-42.81	8.24	15.35	Horizontal	-35.70	-13.00	22.70	45
9	16717.5	-44.24	8.41	14.95	Horizontal	-37.70	-13.00	24.70	90
10	18575.0	-42.31	8.54	15.45	Horizontal	-35.40	-13.00	22.40	135

Note: 1. The other Spurious RF Radiated emissions level is no more than noise floor.

2. The worst emission was found in the antenna is Horizontal position.

LTE Band 2 15MHz CH-Middle

Harmonic	Frequency (MHz)	SG (dBm)	Cable Loss (dB)	Gain (dBi)	Antenna Polarization	EIRP Level (dBm)	Limit (dBm)	Margin (dB)	Azimuth (deg)
2	3760.0	-54.55	5.10	11.05	Horizontal	-48.60	-13.00	35.60	135
3	5640.0	-55.23	5.42	12.65	Horizontal	-48.00	-13.00	35.00	45
4	7520.0	-49.85	6.70	13.85	Horizontal	-42.70	-13.00	29.70	90
5	9400.0	-48.54	7.01	14.75	Horizontal	-40.80	-13.00	27.80	180
6	11280.0	-45.97	7.48	15.95	Horizontal	-37.50	-13.00	24.50	270
7	13160.0	-47.84	7.51	16.55	Horizontal	-38.80	-13.00	25.80	225
8	15040.0	-45.71	8.24	15.35	Horizontal	-38.60	-13.00	25.60	135
9	16920.0	-43.24	8.41	14.95	Horizontal	-36.70	-13.00	23.70	225
10	18800.0	-41.81	8.54	15.45	Horizontal	-34.90	-13.00	21.90	45

Note: 1. The other Spurious RF Radiated emissions level is no more than noise floor.

2. The worst emission was found in the antenna is Horizontal position.

LTE Band 2 15MHz CH-High

Harmonic	Frequency (MHz)	SG (dBm)	Cable Loss (dB)	Gain (dBi)	Antenna Polarization	EIRP Level (dBm)	Limit (dBm)	Margin (dB)	Azimuth (deg)
2	3805.0	-55.85	5.10	11.05	Horizontal	-49.90	-13.00	36.90	90
3	5707.5	-53.83	5.42	12.65	Horizontal	-46.60	-13.00	33.60	135
4	7610.0	-50.95	6.70	13.85	Horizontal	-43.80	-13.00	30.80	225
5	9512.5	-49.24	7.01	14.75	Horizontal	-41.50	-13.00	28.50	45
6	11415.0	-44.17	7.48	15.95	Horizontal	-35.70	-13.00	22.70	90
7	13317.5	-46.84	7.51	16.55	Horizontal	-37.80	-13.00	24.80	135
8	15220.0	-44.11	8.24	15.35	Horizontal	-37.00	-13.00	24.00	135
9	17122.5	-43.94	8.41	14.95	Horizontal	-37.40	-13.00	24.40	90
10	19025.0	-42.81	8.54	15.45	Horizontal	-35.90	-13.00	22.90	225

Note: 1.The other Spurious RF Radiated emissions level is no more than noise floor.
2. The worst emission was found in the antenna is Horizontal position.

LTE Band 2 20MHz CH-Low

Harmonic	Frequency (MHz)	SG (dBm)	Cable Loss (dB)	Gain (dBi)	Antenna Polarization	EIRP Level (dBm)	Limit (dBm)	Margin (dB)	Azimuth (deg)
2	3720.0	-55.25	5.10	11.05	Horizontal	-49.30	-13.00	36.30	135
3	5580.0	-54.23	5.42	12.65	Horizontal	-47.00	-13.00	34.00	90
4	7440.0	-49.35	6.70	13.85	Horizontal	-42.20	-13.00	29.20	45
5	9300.0	-47.74	7.01	14.75	Horizontal	-40.00	-13.00	27.00	90
6	11160.0	-46.57	7.48	15.95	Horizontal	-38.10	-13.00	25.10	90
7	13020.0	-47.64	7.51	16.55	Horizontal	-38.60	-13.00	25.60	135
8	14880.0	-43.41	8.24	15.35	Horizontal	-36.30	-13.00	23.30	225
9	16740.0	-43.64	8.41	14.95	Horizontal	-37.10	-13.00	24.10	135
10	18600.0	-42.81	8.54	15.45	Horizontal	-35.90	-13.00	22.90	90

Note: 1.The other Spurious RF Radiated emissions level is no more than noise floor.
2. The worst emission was found in the antenna is Horizontal position.

LTE Band 2 20MHz CH-Middle

Harmonic	Frequency (MHz)	SG (dBm)	Cable Loss (dB)	Gain (dBi)	Antenna Polarization	EIRP Level (dBm)	Limit (dBm)	Margin (dB)	Azimuth (deg)
2	3760.0	-55.75	5.10	11.05	Horizontal	-49.80	-13.00	36.80	90
3	5640.0	-55.43	5.42	12.65	Horizontal	-48.20	-13.00	35.20	45
4	7520.0	-49.45	6.70	13.85	Horizontal	-42.30	-13.00	29.30	45
5	9400.0	-47.14	7.01	14.75	Horizontal	-39.40	-13.00	26.40	180
6	11280.0	-46.47	7.48	15.95	Horizontal	-38.00	-13.00	25.00	270
7	13160.0	-49.04	7.51	16.55	Horizontal	-40.00	-13.00	27.00	225
8	15040.0	-46.41	8.24	15.35	Horizontal	-39.30	-13.00	26.30	135
9	16920.0	-42.24	8.41	14.95	Horizontal	-35.70	-13.00	22.70	180
10	18800.0	-41.31	8.54	15.45	Horizontal	-34.40	-13.00	21.40	225

Note: 1.The other Spurious RF Radiated emissions level is no more than noise floor.
2. The worst emission was found in the antenna is Horizontal position.

LTE Band 2 20MHz CH-High

Harmonic	Frequency (MHz)	SG (dBm)	Cable Loss (dB)	Gain (dBi)	Antenna Polarization	EIRP Level (dBm)	Limit (dBm)	Margin (dB)	Azimuth (deg)
2	3800.0	-55.48	5.10	11.05	Horizontal	-49.53	-13.00	36.53	45
3	5700.0	-54.53	5.42	12.65	Horizontal	-47.30	-13.00	34.30	225
4	7600.0	-49.65	6.70	13.85	Horizontal	-42.50	-13.00	29.50	135
5	9500.0	-49.54	7.01	14.75	Horizontal	-41.80	-13.00	28.80	90
6	11400.0	-44.97	7.48	15.95	Horizontal	-36.50	-13.00	23.50	45
7	13300.0	-45.54	7.51	16.55	Horizontal	-36.50	-13.00	23.50	90
8	15200.0	-44.71	8.24	15.35	Horizontal	-37.60	-13.00	24.60	45
9	17100.0	-41.94	8.41	14.95	Horizontal	-35.40	-13.00	22.40	135
10	19000.0	-41.01	8.54	15.45	Horizontal	-34.10	-13.00	21.10	90

Note: 1.The other Spurious RF Radiated emissions level is no more than noise floor.
2. The worst emission was found in the antenna is Horizontal position.



6. Main Test Instruments

Name	Manufacturer	Type	Serial Number	Calibration Date	Expiration Date
Base Station Simulator	R&S	CMU200	118133	2017-05-14	2018-05-13
Base Station Simulator	R&S	CMW500	113645	2017-05-14	2018-05-13
Power Splitter	Hua Xiang	SHX-GF2-2-13	10120101	2017-05-14	2018-05-13
Spectrum Analyzer	Agilent	N9010A	MY47191109	2017-05-20	2018-05-19
Universal Radio Communication Tester	Agilent	E5515C	MY48367192	2017-05-20	2018-05-19
Signal Analyzer	R&S	FSV30	100815	2016-12-18	2017-12-17
Signal Analyzer	R&S	FSV30	100815	2017-12-17	2018-12-16
EMI Test Receiver	R&S	ESCI	100948	2017-05-20	2018-05-19
Signal generator	R&S	SMB 100A	102594	2017-05-14	2018-05-13
Signal generator	R&S	SMR27	100365	2017-05-14	2018-05-13
Trilog Antenna	SCHWARZBECK	VUBL 9163	9163-201	2017-11-18	2020-11-17
Horn Antenna	R&S	HF907	100126	2014-12-06	2019-12-05
Climatic Chamber	Re Ce	PT-30B	20101891	2015-07-18	2018-07-17
Horn Antenna	ETS-Lindgren	3160-09	00102644	2015-01-30	2018-01-29
RF Cable	Agilent	SMA 15cm	0001	2017-08-04	2018-02-03
Preamplifier	R&S	SCU18	102327	2017-06-18	2018-06-17
Software	R&S	EMC32	V 8.52.0	NA	NA

*****END OF REPORT *****