

WCDMA1700MHz Channel = 1414, 30MHz to 1GHz

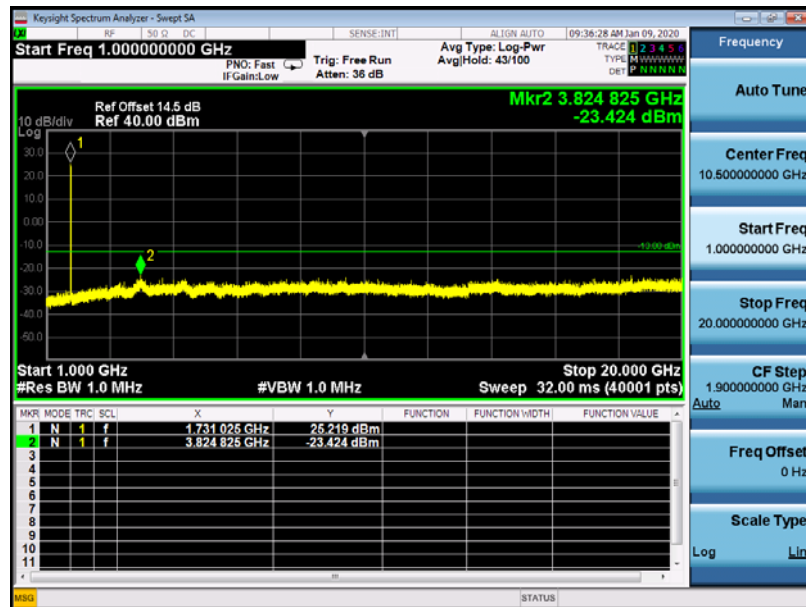

WCDMA1700MHz Channel = 1412, 1GHz to 18GHz

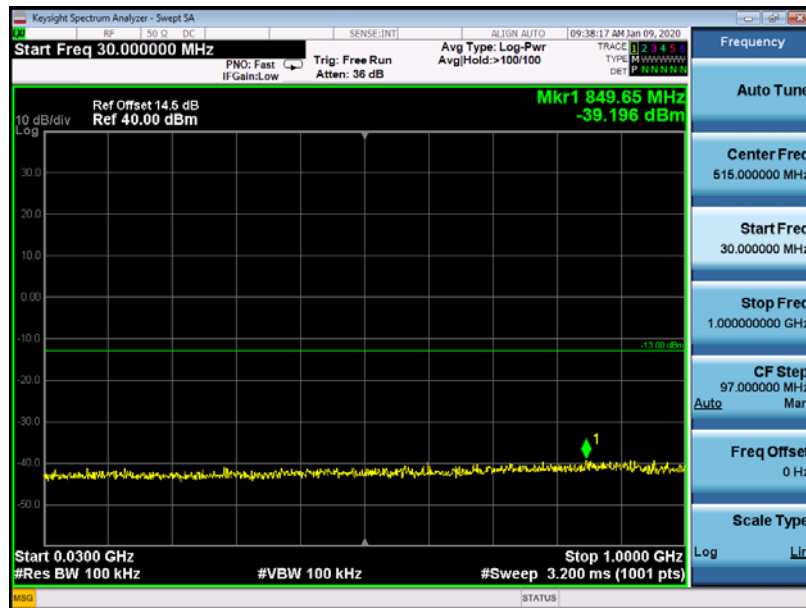

WCDMA1700MHz Channel = 1513, 30MHz to 1GHz

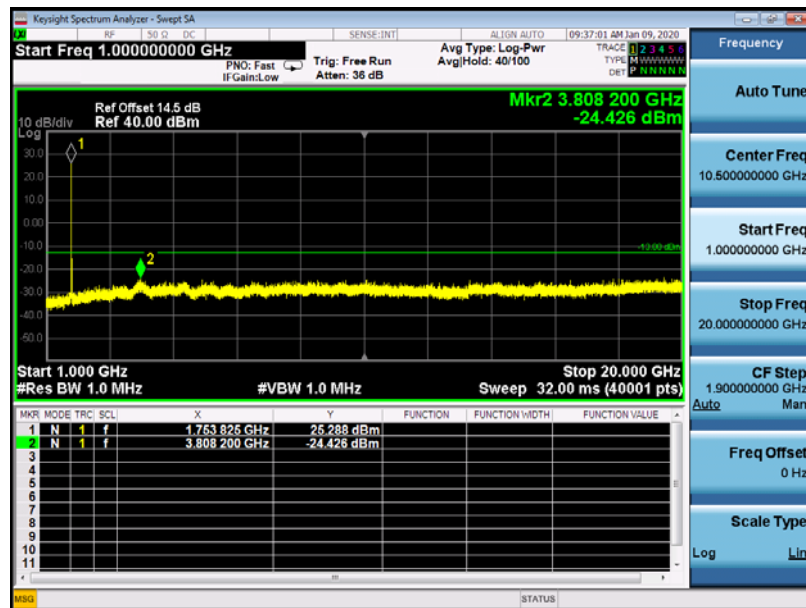

WCDMA1700MHz Channel = 1513, 1GHz to 18GHz

2.6 Bandedge

2.6.1 Requirement

The power of any emission outside of the authorized operating frequency ranges must be lower than the transmitter power (P) by a factor of at least $43 + 10 \log (P)$ dB.

2.6.2 Measuring Instruments

The measuring equipment is listed in the section 3 of this test report.

2.6.3 Test Procedures

1. The testing follows FCC KDB 971168 D01 v03r01 Section 6.0.
2. The EUT was connected to the spectrum analyzer and system simulator via a power divider.
3. The RF output of EUT was connected to the spectrum analyzer by an RF cable and attenuator. The path loss was compensated to the results for each measurement.
4. The band GPRSs of low and high channels for the highest RF powers were measured.
5. The RF fundamental frequency should be excluded against the limit line in the operating frequency band.
6. The limit line is derived from $43 + 10\log(P)$ dB below the transmitter power P(Watts)
 $= P(W) - [43 + 10\log(P)]$ (dB)
 $= [30 + 10\log(P)]$ (dBm) - $[43 + 10\log(P)]$ (dB)
 $= -13\text{dBm}$.

2.6.4 Test Setup

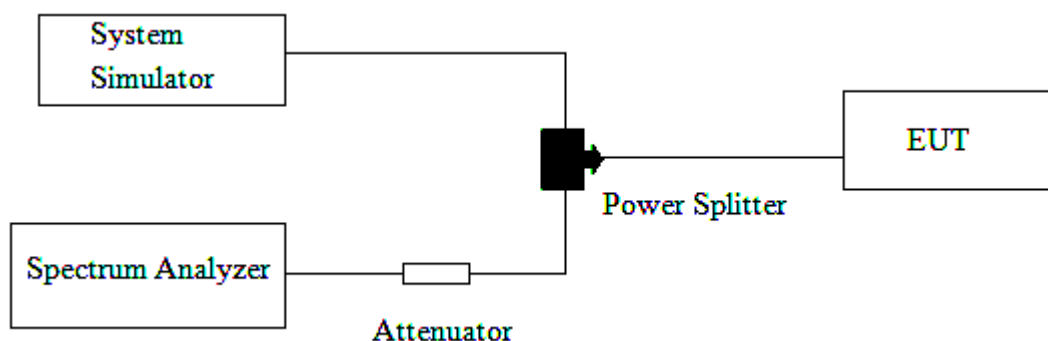

2.6.5 Test Result of Conducted Bandedge



(Plot A: GSM 850 Channel = 128)

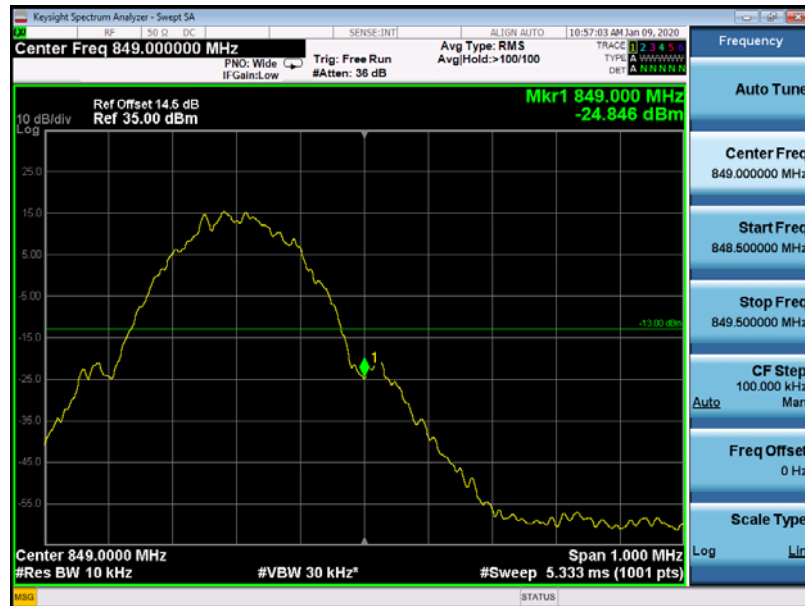

(Plot B: GSM 850 Channel = 251)

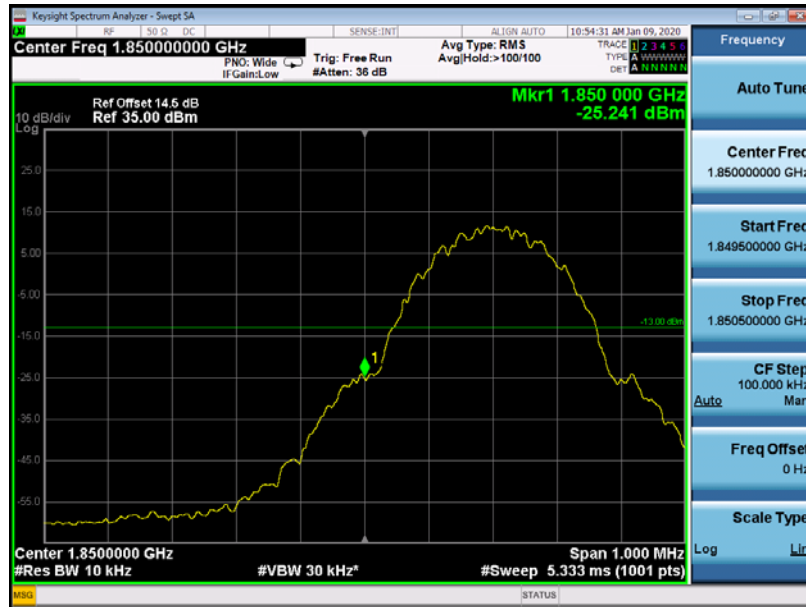

(Plot C:GSM 1900 Channel = 512)

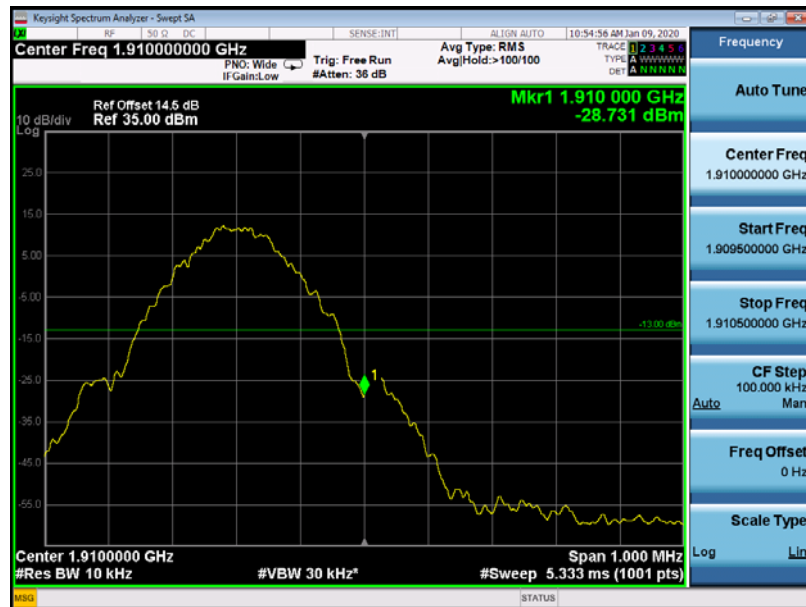

(Plot D: GSM 1900 Channel = 810)



(Plot E: EDGE 850 Channel = 128)



(Plot F: EDGE 850 Channel = 251)

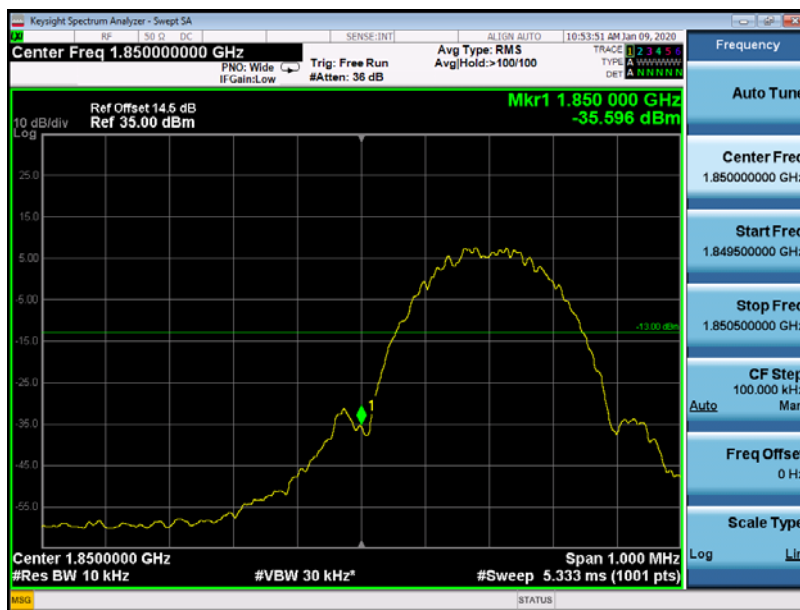

(Plot G: EDGE 1900 Channel = 512)

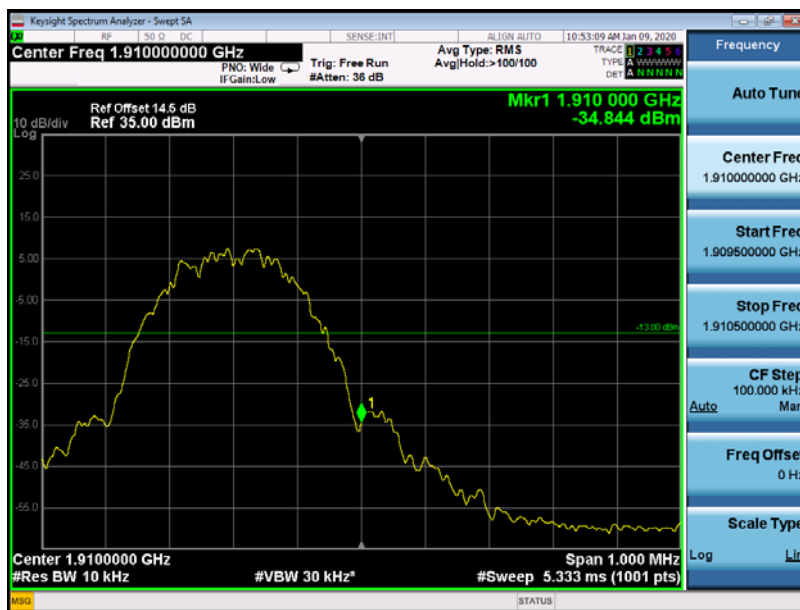

(Plot H: EDGE 1900 Channel = 810)

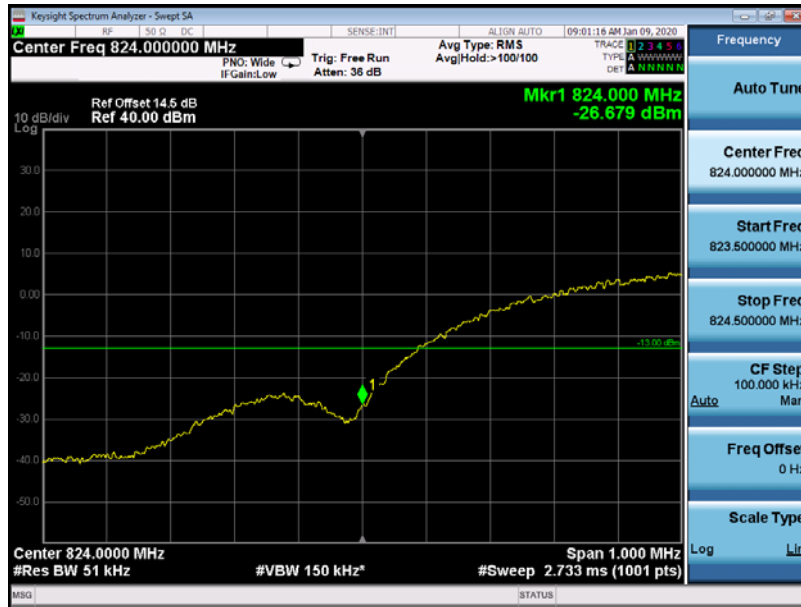

(Plot I: WCDMA 850 Channel = 4132)



(Plot J: WCDMA 850 Channel = 4233)



(Plot K: WCDMA 1900 Channel = 9262)



(Plot L: WCDMA 1900 Channel = 9538)



(Plot M: WCDMA 1700 Channel = 1312)



(Plot N: WCDMA 1700 Channel = 1513)

2.7 Transmitter Radiated Power (EIRP/ERP)

2.7.1 Requirement

The substitution method, in ANSI C63.26:2015, was used for ERP/EIRP measurement, and the spectrum analyzer configuration follows KDB 971168 D01 Power Meas. License Digital Systems v03r01. The ERP of mobile transmitters must not exceed 7 Watts (Cellular Band) and the EIRP of mobile transmitters are limited to 2 Watts (PCS Band) and 1 Watts (AWS Band).

2.7.2 Measuring Instruments

The measuring equipment is listed in the section 3 of this test report.

2.7.3 Test Procedures

1. The testing follows FCC KDB 971168 D01 v03r01 Section 5.2.1. (for CDMA/WCDMA), Section 5.2.2.2 (for GSM/GSM/GPRS) and ANSI / TIA-603-D-2010 Section 2.2.17.
2. The EUT was placed on a turntable 1.5 meters high in a fully anechoic chamber.
3. The EUT was placed 3 meters from the receiving antenna, which was mounted on the antenna tower.
4. GSM operating modes: Set RBW= 1MHz, VBW= 3MHz, RMS detector over burst;
UMTS operating modes: Set RBW= 100 kHz, VBW= 300 kHz, RMS detector over frame, and use channel power option with bandwidth=5MHz, per KDB 971168 D01 v03r01.
5. The table was rotated 360 degrees to determine the position of the highest radiated power.
6. The height of the receiving antenna is adjusted to look for the maximum ERP/EIRP.
7. Taking the record of maximum ERP/EIRP.
8. A dipole antenna was substituted in place of the EUT and was driven by a signal generator.
9. The conducted power at the terminal of the dipole antenna is measured.

10. Repeat step 3 to step 5 to get the maximum ERP/EIRP of the substitution antenna.

$$11. \text{ERP/EIRP} = P_s + E_t - E_s + G_s = P_s + R_t - R_s + G_s$$

P_s (dBm): Input power to substitution antenna.

G_s (dBi or dBd): Substitution antenna Gain.

$$E_t = R_t + \text{AF} \quad E_s = R_s + \text{AF}$$

AF (dB/m): Receive antenna factor

R_t : The highest received signal in spectrum analyzer for EUT.

R_s : The highest received signal in spectrum analyzer for substitution antenna.

2.7.4 Test Setup

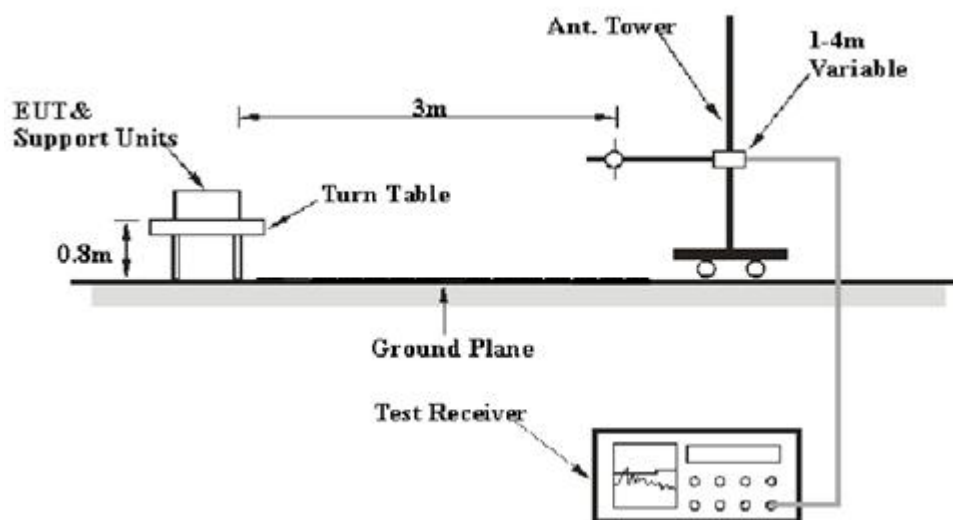



2.7.5 Test Result of Transmitter Radiated Power

Test Notes:

1. This device employs GMSK technology with GSM capabilities. All configurations were investigated and the worst case emissions were found in GSM mode.
2. This device employs UMTS technology with WCDMA (AMR/RMC), HSDPA, HSUPA capabilities. All configurations were investigated and the worst case UMTS emissions were found in RMC WCDMA mode at 12.2Kbps.
3. This unit was tested with its standard battery.
4. The worst case test configuration was found in the vertical positioning where the EUT is laying on its side. The data reported in the tables below were measured in this test setup.

Band	Channel	Frequency (MHz)	PCL	Antenna Pol (H/V)	Measured ERP dBm	Limit dBm	Verdict
GSM 850MHz	128	824.20	5	H	31.25	38.5	PASS
				V	32.18		
	190	836.60	5	H	31.23		PASS
				V	32.08		
	251	848.80	5	H	31.67		PASS
				V	32.33		

Band	Channel	Frequency (MHz)	PCL	Antenna Pol (H/V)	Measured EIRP dBm	Limit dBm	Verdict
GSM 1900MHz	512	1850.2	0	H	27.35	33	PASS
				V	29.84		
	661	1880.0	0	H	27.47		PASS
				V	29.62		
	810	1909.8	0	H	27.28		PASS
				V	29.25		



Band	Channel	Frequency (MHz)	PCL	Antenna Pol (H/V)	Measured ERP dBm	Limit dBm	Verdict
EDGE 850MHz	128	824.20	5	H	24.33	38.5	PASS
				V	25.61		
	190	836.60	5	H	24.78		PASS
				V	25.26		
	251	848.80	5	H	24.49		PASS
				V	25.64		

Band	Channel	Frequency (MHz)	PCL	Antenna Pol (H/V)	Measured EIRP dBm	Limit dBm	Verdict
EDGE 1900MHz	512	1850.2	0	H	25.32	33	PASS
				V	25.74		
	661	1880.0	0	H	25.12		PASS
				V	25.68		
	810	1909.8	0	H	25.33		PASS
				V	25.85		

Band	Channel	Frequency (MHz)	Antenna Pol (H/V)	Measured ERP dBm	Limit dBm	Verdict
WCDMA 850MHz	4132	826.4	H	22.32	38.5	PASS
			V	22.41		
	4175	835	H	22.18		PASS
			V	22.52		
	4233	846.6	H	22.32		PASS
			V	22.47		

Band	Channel	Frequency (MHz)	Antenna Pol (H/V)	Measured EIRP dBm	Limit dBm	Verdict
WCDMA 1900MHz	9262	1852.4	H	22.79	33	PASS
			V	23.01		
	9400	1880	H	22.54		PASS
			V	23.24		
	9538	1907.6	H	22.88		PASS
			V	23.14		



Band	Channel	Frequency (MHz)	Antenna Pol (H/V)	Measured EIRP dBm	Limit dBm	Verdict
WCDMA 1700MHz	1312	1712.4	V	22.01	30	PASS
			H	22.57		
	1413	1732.4	V	22.12		PASS
			H	22.61		
	1513	1752.6	V	22.08		PASS
			H	22.62		

2.8 Radiated Spurious Emissions

2.8.1 Requirement

The power of any emission outside of the authorized operating frequency ranges must be attenuated below the transmitter power (P) by a factor of at least $43 + 10 \log (P)$ dB. The spectrum is scanned from 30 MHz up to a frequency including its 10th harmonic.

2.8.2 Measuring Instruments

The measuring equipment is listed in the section 3 of this test report.

2.8.3 Test Setup

For radiated emissions from 9 kHz to 30MHz

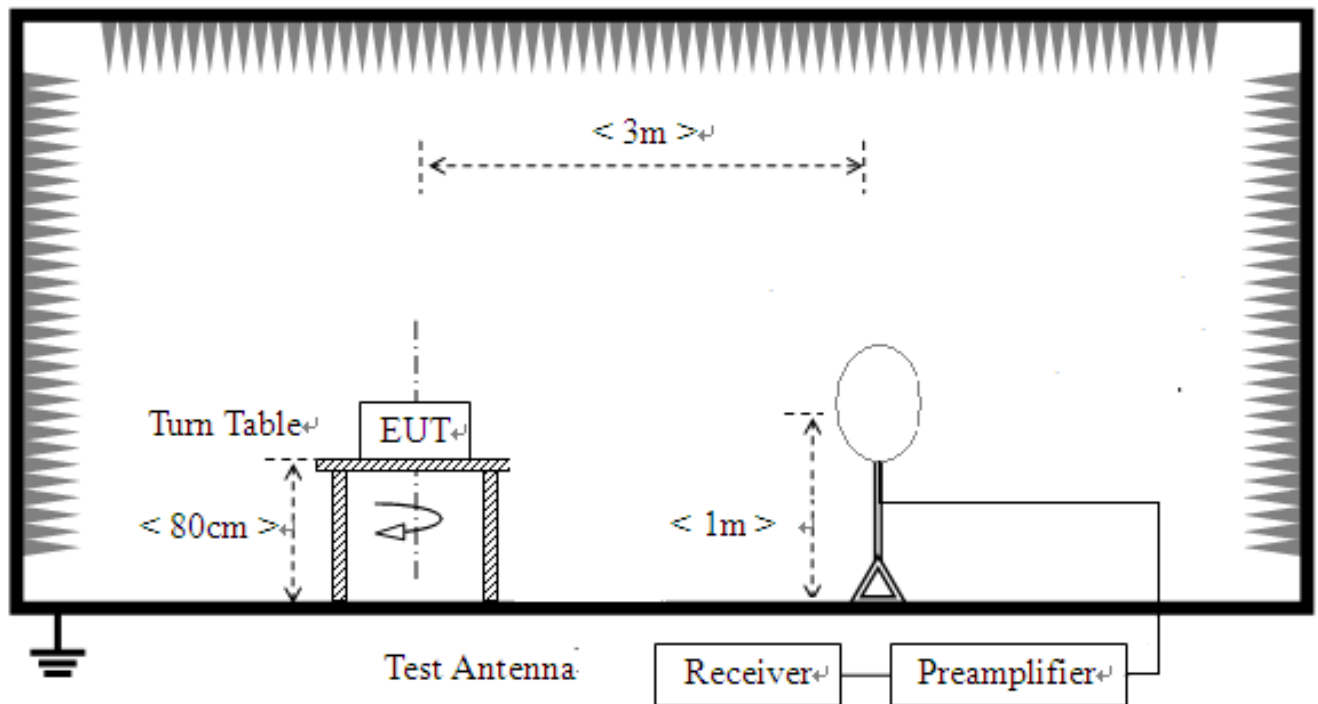

For radiated emissions from 30MHz to 1GHz

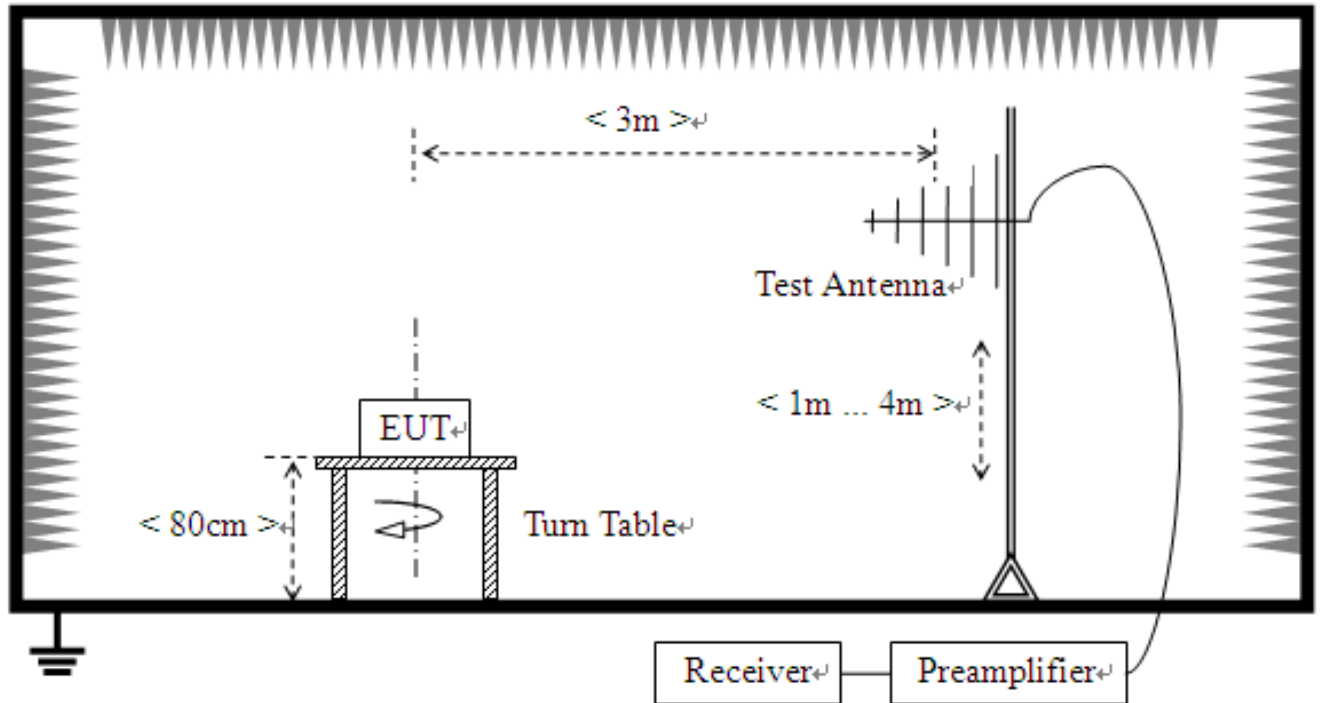

For radiated emissions above 1GHz

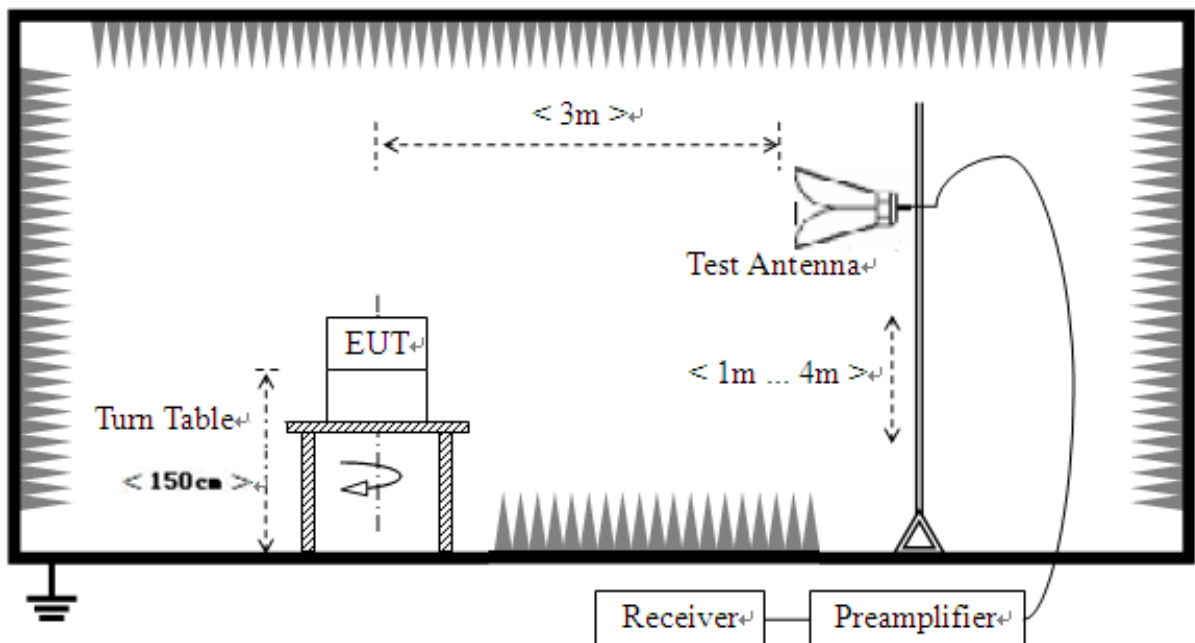

2.8.4 Test Procedures

1. The testing follows FCC KDB 971168 D01 v03r01 Section 5.8.
2. The EUT was placed on a rotatable wooden table 0.8/1.5 meters above the ground.
3. The EUT was set 3 meters from the receiving antenna, which was mounted on the antenna tower.
4. The table was rotated 360 degrees to determine the position of the highest spurious emission.
5. The height of the receiving antenna is varied between one meter and four meters to search for the maximum spurious emission for both horizontal and vertical polarizations.
6. Make the measurement with the spectrum analyzer's RBW = 1MHz, VBW = 3MHz, taking record of maximum spurious emission.
7. A horn antenna was substituted in place of the EUT and was driven by a signal generator.
8. Tune the output power of signal generator to the same emission level with EUT maximum spurious emission.
9. Taking the record of output power at antenna port.
10. Repeat step 7 to step 8 for another polarization.
11. The RF fundamental frequency should be excluded against the limit line in the operating frequency band.
12. The limit line is derived from $43 + 10\log(P)$ dB below the transmitter power P(Watts)
 $= P(W) - [43 + 10\log(P)]$ (dB)
 $= [30 + 10\log(P)]$ (dBm) - $[43 + 10\log(P)]$ (dB)
 $= -13\text{dBm}$.
13. This device employs GMSK technology with GSM and GSM capabilities. All configurations were investigated and the worst case emissions were found in GSM mode.
14. This device employs UMTS technology with WCDMA (AMR/RMC), HSDPA, HSUPA capabilities. All configurations were investigated and the worst case UMTS emissions were found in RMC WCDMA mode at 12.2Kbps.
15. This unit was tested with its standard battery.
16. All Spurious Emission tests were performed in X, Y, Z axis direction and low, middle, high channel. And only the worst axis test condition was recorded in this test report.
17. The spectrum is measured from 9 KHz to the 10th harmonic of the fundamental frequency



of the transmitter using CISPR quasi peak detector below 1GHz. The worst case emissions are reported however emissions whose levels were not within 20dB of the respective limits were not reported.

18. For 9KHz to 30MHz: the amplitude of spurious emissions are attenuated by more than 20dB below the permissible value has no need to be reported.



2.8.5 Test Results of Radiated Spurious Emissions

Note: 1. (Absolute)Level=Reading Level + Factor

Worst-Case test data provide as below:

GSM850 Middle Channel

30MHz~10GHz:

Suspected List							
NO.	Freq. [MHz]	Reading [dBm]	Level [dBm]	Limit [dBm]	Margin [dB]	Factor [dB]	Polarity
1	30.3234	-91.89	-65.40	-13.00	52.40	26.49	Horizontal
2	1672.33	-49.86	-51.24	-13.00	38.24	-1.38	Horizontal
3	2880.94	-57.72	-50.14	-13.00	37.14	7.58	Horizontal
4	3861.43	-58.10	-48.82	-13.00	35.82	9.28	Horizontal
5	5354.17	-58.51	-46.46	-13.00	33.46	12.05	Horizontal
6	7275.13	-59.56	-42.39	-13.00	29.39	17.17	Horizontal
Suspected List							
NO.	Freq. [MHz]	Reading [dBm]	Level [dBm]	Limit [dBm]	Margin [dB]	Factor [dB]	Polarity
1	61.0504	-93.25	-70.63	-13.00	57.63	22.62	Vertical
2	80.7803	-93.19	-68.49	-13.00	55.49	24.70	Vertical
3	1760.38	-54.09	-53.95	-13.00	40.95	0.14	Vertical
4	3913.45	-59.48	-49.48	-13.00	36.48	10.00	Vertical
5	5098.04	-59.08	-44.81	-13.00	31.81	14.27	Vertical
6	6314.65	-58.62	-43.16	-13.00	30.16	15.46	Vertical



Worst-Case test data provide as below:

GSM1900 Middle Channel

30MHz~20GHz:

Suspected List							
NO.	Freq. [MHz]	Reading [dBm]	Level [dBm]	Limit [dBm]	Margin [dB]	Factor [dB]	Polarity
1	31.9410	-90.00	-67.18	-13.00	54.18	22.82	Horizontal
2	2697.23	-57.48	-48.99	-13.00	35.99	8.49	Horizontal
3	3795.39	-58.20	-49.37	-13.00	36.37	8.83	Horizontal
4	5101.05	-59.57	-47.40	-13.00	34.40	12.17	Horizontal
5	7517.25	-57.09	-40.44	-13.00	27.44	16.65	Horizontal
6	10023.5	-60.69	-36.95	-13.00	23.95	23.74	Horizontal
Suspected List							
NO.	Freq. [MHz]	Reading [dBm]	Level [dBm]	Limit [dBm]	Margin [dB]	Factor [dB]	Polarity
1	31.9410	-90.96	-70.40	-13.00	57.40	20.56	Vertical
2	62.5113	-92.19	-72.78	-13.00	59.78	19.41	Vertical
3	626.363	-99.32	-69.16	-13.00	56.16	30.16	Vertical
4	2696.56	-57.70	-48.66	-13.00	35.66	9.04	Vertical
5	5093.54	-59.83	-45.61	-13.00	32.61	14.22	Vertical
6	9123.06	-60.47	-39.79	-13.00	26.79	20.68	Vertical



Worst-Case test data provide as below:

WCDMA 850 Middle Channel

30MHz~10GHz:

Suspected List							
NO.	Freq. [MHz]	Reading [dBm]	Level [dBm]	Limit [dBm]	Margin [dB]	Factor [dB]	Polarity
1	31.9419	-91.26	-65.16	-13.00	52.16	26.10	Horizontal
2	61.0711	-94.24	-72.47	-13.00	59.47	21.77	Horizontal
3	1763.38	-52.70	-51.87	-13.00	38.87	0.83	Horizontal
4	2853.92	-57.80	-50.74	-13.00	37.74	7.06	Horizontal
5	7937.46	-60.05	-42.30	-13.00	29.30	17.75	Horizontal
6	10608.8	-62.56	-37.79	-13.00	24.79	24.77	Horizontal
Suspected List							
NO.	Freq. [MHz]	Reading [dBm]	Level [dBm]	Limit [dBm]	Margin [dB]	Factor [dB]	Polarity
1	62.0420	-92.30	-69.58	-13.00	56.58	22.72	Vertical
2	1764.38	-54.25	-54.02	-13.00	41.02	0.23	Vertical
3	2975.98	-57.66	-50.71	-13.00	37.71	6.95	Vertical
4	5011.00	-59.54	-46.10	-13.00	33.10	13.44	Vertical
5	7172.08	-59.44	-42.88	-13.00	29.88	16.56	Vertical
6	10361.1	-61.40	-37.15	-13.00	24.15	24.25	Vertical



Worst-Case test data provide as below:

WCDMA 1900 Middle Channel

30MHz~20GHz:

Suspected List							
NO.	Freq. [MHz]	Reading [dBm]	Level [dBm]	Limit [dBm]	Margin [dB]	Factor [dB]	Polarity
1	31.9419	-90.53	-67.72	-13.00	54.72	22.81	Horizontal
2	830.080	-100.36	-66.57	-13.00	53.57	33.79	Horizontal
3	1138.06	-56.78	-60.31	-13.00	47.31	-3.53	Horizontal
4	3202.60	-58.99	-49.82	-13.00	36.82	9.17	Horizontal
5	7209.60	-60.12	-43.14	-13.00	30.14	16.98	Horizontal
6	10008.5	-61.27	-37.52	-13.00	24.52	23.75	Horizontal
Suspected List							
NO.	Freq. [MHz]	Reading [dBm]	Level [dBm]	Limit [dBm]	Margin [dB]	Factor [dB]	Polarity
1	31.9419	-91.52	-70.97	-13.00	57.97	20.55	Vertical
2	62.0420	-90.83	-71.47	-13.00	58.47	19.36	Vertical
3	3240.12	-59.11	-50.46	-13.00	37.46	8.65	Vertical
4	5101.05	-59.90	-45.65	-13.00	32.65	14.25	Vertical
5	7142.07	-59.65	-43.18	-13.00	30.18	16.47	Vertical
6	10376.1	-62.27	-37.88	-13.00	24.88	24.39	Vertical



Worst-Case test data provide as below:

WCDMA 1700 Middle Channel

30MHz~20GHz:

Suspected List							
NO.	Freq. [MHz]	Reading [dBm]	Level [dBm]	Limit [dBm]	Margin [dB]	Factor [dB]	Polarity
1	65.9259	-93.53	-74.94	-13.00	61.94	18.59	Horizontal
2	191.181	-97.41	-75.43	-13.00	62.43	21.98	Horizontal
3	3214.60	-54.90	-46.14	-13.00	33.14	8.76	Horizontal
4	4037.01	-54.65	-45.90	-13.00	32.90	8.75	Horizontal
5	6120.06	-55.27	-41.17	-13.00	28.17	14.10	Horizontal
6	14626.3	-59.04	-35.56	-13.00	22.56	23.48	Horizontal
Suspected List							
NO.	Freq. [MHz]	Reading [dBm]	Level [dBm]	Limit [dBm]	Margin [dB]	Factor [dB]	Polarity
1	65.9259	-92.66	-72.67	-13.00	59.67	19.99	Vertical
2	103.793	-99.51	-76.26	-13.00	63.26	23.25	Vertical
3	190.210	-98.67	-79.71	-13.00	66.71	18.96	Vertical
4	3223.61	-54.99	-46.39	-13.00	33.39	8.60	Vertical
5	3787.89	-53.99	-45.38	-13.00	32.38	8.61	Vertical
6	6576.28	-55.63	-41.59	-13.00	28.59	14.04	Vertical



3. LIST OF MEASURING EQUIPMENT

Description	Manufacturer	Model	Serial No.	Cal. Date	Due Date	Remark
EMI Test Receiver	R&S	ESIB26	A0304218	2019.05.20	2020.05.19	Radiation
Loop Antenna	Schwarz beck	HFH2-Z2	100047	2019.04.26	2022.04.25	Radiation
Broadband antenna (30MHz~1GHz)	R&S	HL562	101341	2017.07.14	2020.07.13	Radiation
Broadband antenna (30MHz~1GHz)	R&S	HL562	101339	2017.07.14	2020.07.13	Radiation
Double ridge horn antenna (1GHz~18GHz)	R&S	HF906	100150	2019.04.27	2022.04.26	Radiation
Double ridge horn antenna (1GHz~18GHz)	R&S	HF906	100149	2019.04.17	2022.04.16	Radiation
Horn antenna (18GHz~26.5GHz)	AR	AT4002A	305753	2017.07.12	2020.07.11	Radiation
Horn antenna (18GHz~26.5GHz)	AR	AT4003A	0329293	2018.09.17	2020.09.16	Radiation
Amplifier 1GHz-18GHz	AR	25S1G4AM1	22018	2018.09.17	2020.09.16	Radiation
Amplifier 20M~3GHz	MILMEGA	80RF1000-250	1064573	2017.10.09	2020.10.08	Radiation
Spectrum Analyzer	KEYSIGHT	N9030A	A160702554	2019.06.05	2020.06.04	Conducted
LISN	ROHDE&SC HWARZ	ESH2-Z5	A0304221	2019.04.30	2020.04.29	Conducted
Test Receiver	R&S	ESCS30	A0304260	2019.05.25	2020.05.24	Conducted
Temperature chamber	Dongguan gaoda instrument CO.LTD	GD-7005-100	130130101	2019.04.22	2020.04.21	Conducted
Wideband Radio Communication tester	R&S	CMW500	149332	2019.04.01	2020.03.31	Conducted
Power Supply	R&S	NGMO1	101037	2019.08.03	2020.08.02	Conducted



4. UNCERTAINTY OF EVALUATION

Uncertainty of Conducted Emission Measurement (150KHz~30MHz)

Measuring Uncertainty for a level of confidence of 95%(U=2Uc(y))	2.6dB
--	-------

Uncertainty of Radiated Emission Measurement (30MHz~1GHz)

Measuring Uncertainty for a level of confidence of 95%(U=2Uc(y))	2.4dB
--	-------

Uncertainty of Radiated Emission Measurement (1GHz~40GHz)

Measuring Uncertainty for a level of confidence of 95%(U=2Uc(y))	2.8dB
--	-------

** END OF REPORT **