



# RF TEST REPORT

**Applicant** ZTE Corporation  
**FCC ID** SRQ-A31PLUS3  
**Product** LTE/WCDMA/GSM(GPRS)  
Multi-Mode Digital Mobile Phone  
**Model** ZTE Blade A31 Plus  
**Report No.** R2205A0440-R9  
**Issue Date** June 14, 2022

TA Technology (Shanghai) Co., Ltd. tested the above equipment in accordance with the requirements in **FCC CFR47 Part 2 (2021)/ FCC CFR 47 Part 90S (2021)**. The test results show that the equipment tested is capable of demonstrating compliance with the requirements as documented in this report.

Prepared by: Peng Tao

Approved by: Kai Xu

---

**TA Technology (Shanghai) Co., Ltd.**

No.145, Jintang Rd, Tangzhen Industry Park, Pudong Shanghai, China

TEL: +86-021-50791141/2/3

FAX: +86-021-50791141/2/3-8000



## TABLE OF CONTENT

1. Test Laboratory .....	4
1.1. Notes of the Test Report .....	4
1.2. Test facility .....	4
1.3. Testing Location .....	4
2. General Description of Equipment under Test.....	5
2.3. Applicant and Manufacturer Information .....	5
2.4. General Information.....	5
3. Applied Standards.....	7
4. Test Configuration.....	8
5. Test Case.....	9
5.1. RF Power Output and Effective Radiated Power .....	9
5.2. Occupied Bandwidth .....	10
5.3. Emission Mask .....	11
5.4. Peak-to-Average Power Ratio (PAPR) .....	12
5.5. Frequency Stability.....	13
5.6. Spurious Emissions at Antenna Terminals .....	15
5.7. Radiates Spurious Emission .....	16
6. Test Results .....	19
6.1. RF Power Output and Effective Radiated Power .....	19
6.2. Occupied Bandwidth .....	25
6.3. Emission Mask .....	31
6.4. Peak-to-Average Power Ratio (PAPR) .....	39
6.5. Frequency Stability.....	40
6.6. Spurious Emissions at Antenna Terminals .....	42
6.7. Radiates Spurious Emission .....	44
7. Main Test Instruments .....	46
ANNEX A: The EUT Appearance.....	47
ANNEX B: Test Setup Photos .....	48



## Summary of measurement results

No.	Test Case	Clause in FCC rules	Verdict
1	RF Power Output and Effective Radiated Power	2.1046/90.635(b)	PASS
2	Occupied Bandwidth	2.1049/ 90.209	PASS
3	Emission Masks	2.1051 / 90.691	PASS
4	Peak-to-Average Power Ratio	KDB 971168 D01(5.7)	PASS
5	Frequency Stability	2.1055 / 90.213	PASS
6	Spurious Emissions at Antenna Terminals	2.1051 / 90.691	PASS
7	Radiates Spurious Emission	2.1053 /90.691	PASS
Date of Testing: May 30, 2022 ~ June 7, 2022			
Date of Sample Received: May 24, 2022			
Note: PASS: The EUT complies with the essential requirements in the standard. FAIL: The EUT does not comply with the essential requirements in the standard. All indications of Pass/Fail in this report are opinions expressed by TA Technology (Shanghai) Co., Ltd. based on interpretations and/or observations of test results. Measurement Uncertainties were not taken into account and are published for informational purposes only.			



## 1. Test Laboratory

### 1.1. Notes of the Test Report

This report shall not be reproduced in full or partial, without the written approval of **TA technology (shanghai) co., Ltd.** The results documented in this report apply only to the tested sample, under the conditions and modes of operation as described herein .Measurement Uncertainties were not taken into account and are published for informational purposes only. This report is written to support regulatory compliance of the applicable standards stated above.

### 1.2. Test facility

#### **FCC (Designation number: CN1179, Test Firm Registration Number: 446626)**

TA Technology (Shanghai) Co., Ltd. has been listed on the US Federal Communications Commission list of test facilities recognized to perform electromagnetic emissions measurements.

#### **A2LA (Certificate Number: 3857.01)**

TA Technology (Shanghai) Co., Ltd. has been listed by American Association for Laboratory Accreditation to perform electromagnetic emission measurement.

### 1.3. Testing Location

Company: TA Technology (Shanghai) Co., Ltd.  
Address: No.145, Jintang Rd, Tangzhen Industry Park, Pudong  
City: Shanghai  
Post code: 201201  
Country: P. R. China  
Contact: Xu Kai  
Telephone: +86-021-50791141/2/3  
Fax: +86-021-50791141/2/3-8000  
Website: <http://www.ta-shanghai.com>  
E-mail: [xukai@ta-shanghai.com](mailto:xukai@ta-shanghai.com)

## 2. General Description of Equipment under Test

### 2.1. Applicant and Manufacturer Information

Applicant	ZTE Corporation
Applicant address	ZTE Plaza, #55 Keji Road South, Hi-Tech Industrial Park, Nanshan District, Shenzhen, China
Manufacturer	ZTE Corporation
Manufacturer address	ZTE Plaza, #55 Keji Road South, Hi-Tech Industrial Park, Nanshan District, Shenzhen, China

### 2.2. General Information

EUT Description			
Model	ZTE Blade A31 Plus		
IMEI	865588060001219		
Hardware Version	z1kA		
Software Version	4.0.0_A31Plus_TEL		
Power Supply	Battery / AC adapter		
Antenna Type	Internal Antenna		
Antenna Gain	-4.2dBi		
Test Mode(s)	LTE Band 26;		
Test Modulation	QPSK, 16QAM, 64QAM;		
LTE Category	5		
Maximum E.R.P.	15.71dBm		
Rated Power Supply Voltage	3.8V		
Operating Voltage	Minimum: 3.04V    Maximum: 4.35V		
Operating Temperature	Lowest: -10°C    Highest: +55°C		
Testing Temperature	Lowest: -30°C    Highest: +50°C		
Operating Frequency Range(s)	Band	Tx (MHz)	Rx (MHz)
	LTE Band 26	814 ~ 824	859 ~ 869
EUT Accessory			
Adapter 1	Manufacturer: Shenzhen Ruijing Industrial Co.,Ltd Model: STC-A51D-Z		
Adapter 2	Manufacturer: HUIZHOU PUAN ELECTRONICS CO.,LTD Model: STC-A51D-Z		
Battery	Manufacturer: Guangdong Fenghua New Energy Co.,Ltd. Model: Li3830T43P8h486375		
Earphone 1	Manufacturer: Shenzhen FDC Electronics Co. ,Ltd. Model: DEM-8A		
Earphone 2	Manufacturer: JUWEI ELECTRONICS CO., LTD		



	Model: JWEP1091-Z01
USB Cable 1	Manufacturer: Dongguan Guojun Plastic Electronic Co.,Ltd Model: USB-MU5-B-70-M-L
USB Cable 2	Manufacturer: Shenzhen Yihuaxing Electronic Co., Ltd. Model: USB-MU5-B-70-M-L
<p>Note: 1. The EUT is sent from the applicant to TA and the information of the EUT is declared by the applicant.</p> <p>2. There are more than one Adapter, Earphone and USB Cable, each one should be applied throughout the compliance test respectively, however, only the worst case (Adapter 1, Earphone 2 and USB Cable 1) will be recorded in this report.</p>	



### 3. Applied Standards

According to the specifications of the manufacturer, it must comply with the requirements of the following standards:

**Test standards:**

**FCC CFR 47 Part 90S (2021)**

**ANSI C63.26 (2015)**

**Reference standard:**

**FCC CFR47 Part 2-2021**

**KDB 971168 D01 Power Meas License Digital Systems v03r01**

### 4. Test Configuration

There is more than one SIM card slot, each one should be applied throughout the compliance test respectively, and however, only the worst case (SIM 1) will be recorded in this report.

Radiated measurements are performed by rotating the EUT in three different orthogonal test planes. EUT stand-up position (Z axis), lie-down position (X, Y axis). Receiver antenna polarization (horizontal and vertical), the worst emission was found in position (Z axis, horizontal polarization) and the worst case was recorded.

All mode and data rates and positions were investigated.

The following testing in LTE is set based on the maximum RF Output Power.

Test modes are chosen as the worst case configuration below for LTE Band 26

Test items	Bandwidth (MHz)				Modulation		RB			Test Channel		
	1.4	3	5	10	QPSK	16QAM/64QAM	1	50%	100%	L	M	H
RF Power Output and Effective Radiated Power	O	O	O	O	O	O	O	O	O	O	O	O
Occupied Bandwidth	O	O	O	O	O	O	-	-	O	O	O	O
Emission Mask	O	O	O	O	O	O	O	-	O	O	-	O
Peak-to-Average Power Ratio	O	O	O	O	O	O	-	-	O	O	O	O
Frequency Stability	O	O	O	O	O	O	O	-	-	-	O	-
Spurious Emissions at Antenna Terminals	O	O	O	O	O	-	O	-	-	O	O	O
Radiates Spurious Emission	O	-	O	-	O	-	O	-	-	-	O	-
Note	1. The mark "O" means that this configuration is chosen for testing. 2. The mark "-" means that this configuration is not testing.											



## 5. Test Case

### 5.1. RF Power Output and Effective Radiated Power

#### Ambient condition

Temperature	Relative humidity
21°C ~25°C	40%~60%

#### Methods of Measurement

During the process of the testing, The EUT was connected to the Base Station Simulator with a known loss. The EUT is controlled by the Base Station Simulator test set to ensure max power transmission with proper modulation.

ERP can then be calculated as follows:

$$\text{EIRP (dBm)} = \text{Output Power (dBm)} - \text{Losses (dB)} + \text{Antenna Gain (dBi)}$$

where:dBd refers to gain relative to an ideal dipole.

$$\text{EIRP (dBm)} = \text{ERP (dBm)} + 2.15 \text{ (dB.)}$$

#### Test Setup

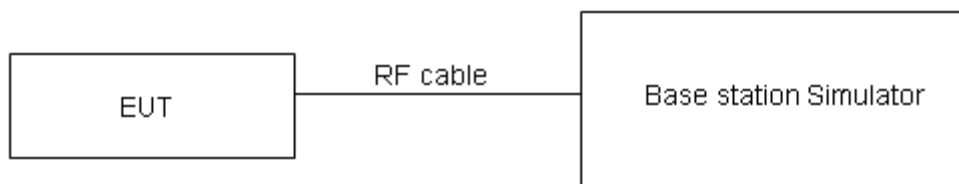

#### Limits

Part 90.635 (b) the maximum output power of the transmitter for mobile stations is 100 watts.

Rule Part 90.635(b) specifies that “The maximum output power of the transmitter for mobile stations is 100 watts”.

Limit	≤ 100 W (50 dBm)
-------	------------------

#### Measurement Uncertainty

The assessed measurement uncertainty to ensure 95% confidence level for the normal distribution is with the coverage factor k = 2, U= 0.4 dB for RF power output, k = 2, U= 1.19 dB for ERP.

#### Test Results

Refer to the section 6.1 of this report for test data.

## 5.2. Occupied Bandwidth

### Ambient condition

Temperature	Relative humidity
21°C ~25°C	40%~60%

### Method of Measurement

The EUT was connected to Spectrum Analyzer and Base Station Simulator via power Splitter. The occupied bandwidth is measured using spectrum analyzer.

RBW is set to 30 kHz, VBW is set to 91 kHz for LTE Band 26 (1.4MHz),

RBW is set to 62 kHz, VBW is set to 180 kHz for LTE Band 26 (3MHz).

RBW is set to 100 kHz, VBW is set to 300 kHz for LTE Band 26 (5MHz).

RBW is set to 200 kHz, VBW is set to 620kHz for LTE Band 26 (10MHz). .

99% power and -26dBc occupied bandwidths are recorded. Spectrum analyzer plots are included on the following pages.

### Test Setup

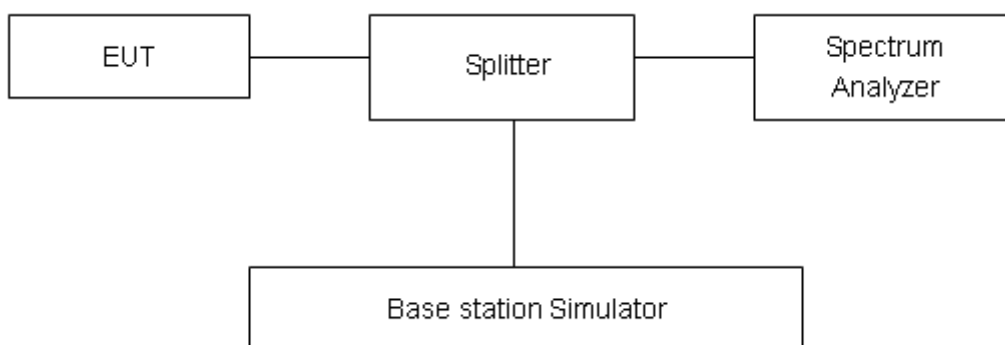

### Limits

No specific occupied bandwidth requirements in part 2.1049.

Part 90.209 (a) Each authorization issued to a station licensed under this part will show an emission designator representing the class of emission authorized. The designator will be prefixed by a specified necessary bandwidth. This number does not necessarily indicate the bandwidth occupied by the emission at any instant. In those cases where part 2.202 of this chapter does not provide a formula for the computation of necessary bandwidth, the occupied bandwidth, as defined in part 2 of this chapter, may be used in lieu of the necessary bandwidth.

### Measurement Uncertainty

The assessed measurement uncertainty to ensure 95% confidence level for the normal distribution is with the coverage factor  $k = 2$ ,  $U = 624\text{Hz}$ .

### Test Results

Refer to the section 6.2 of this report for test data.

### 5.3. Emission Mask

#### Ambient condition

Temperature	Relative humidity
21°C ~25°C	40%~60%

#### Method of Measurement

The EUT was connected to Spectrum Analyzer and Base Station Simulator via power Splitter. The band edge of the lowest and highest channels were measured. The average detector is used. For Section 90.691(a) compliance testing, use RBW = 300 Hz for offsets less than 37.5 kHz from a channel edge; RBW = 100 kHz for offsets greater than 37.5 kHz is allowed.

Spectrum analyzer plots are included on the following pages.

#### Test Setup

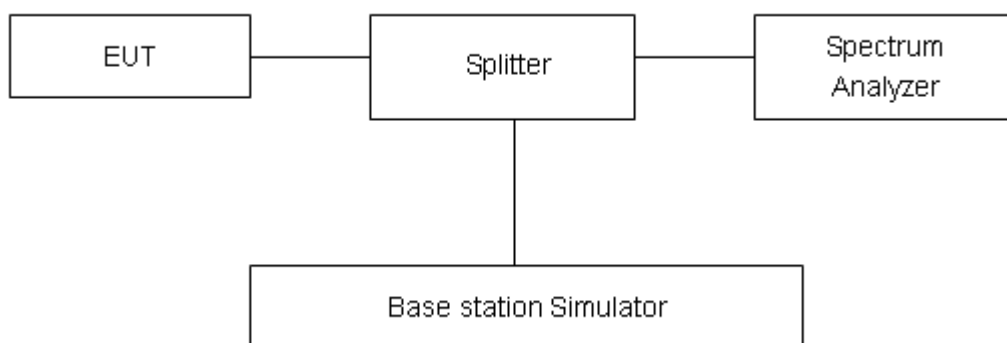

#### Limits

Rule Part 90.691(a) specifies that “ For any frequency removed from the EA licensee's frequency block by up to and including 37.5 kHz, the power of any emission shall be attenuated below the transmitter power (P) in watts by at least  $116 \text{ Log}_{10}(f/6.1)$  decibels or  $50 + 10 \text{ Log}_{10}(P)$  decibels or 80 decibels, whichever is the lesser attenuation, where f is the frequency removed from the center of the outer channel in the block in kilohertz and where f is greater than 12.5 kHz.”

#### Measurement Uncertainty

The assessed measurement uncertainty to ensure 95% confidence level for the normal distribution is with the coverage factor  $k = 1.96$ ,  $U=0.684\text{dB}$ .

#### Test Results

Refer to the section 6.3 of this report for test data.

### 5.4. Peak-to-Average Power Ratio (PAPR)

#### Ambient condition

Temperature	Relative humidity
21°C ~25°C	40%~60%

#### Methods of Measurement

Measure the total peak power and record as PPK. And measure the total average power and record as PAvg. Both the peak and average power levels must be expressed in the same logarithmic units (e.g., dBm). Determine the PAPR from:

$$PAPR (dB) = PPK (dBm) - PAvg (dBm).$$

#### Test Setup

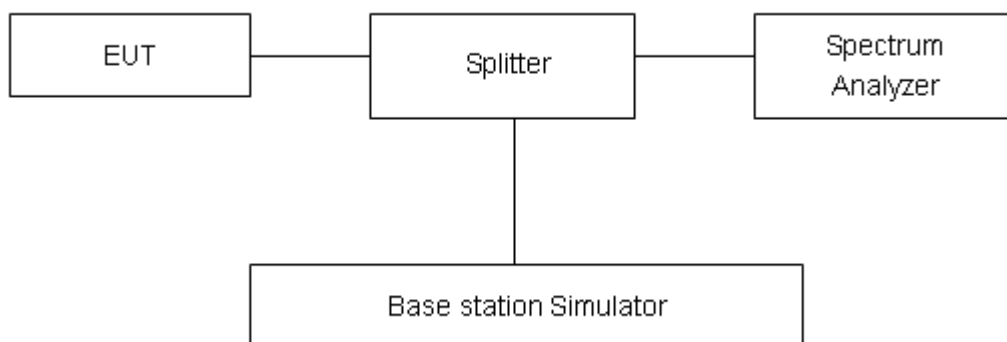

#### Limits

In measuring transmissions in this band using an average power technique, the peak-to-average ratio (PAR) of the transmission may not exceed 13 dB in 24.232(d).

#### Measurement Uncertainty

The assessed measurement uncertainty to ensure 95% confidence level for the normal distribution is with the coverage factor  $k = 2$ ,  $U = 0.4$  dB.

#### Test Results

Refer to the section 6.4 of this report for test data.

## 5.5. Frequency Stability

### Ambient condition

Temperature	Relative humidity
21°C ~25°C	40%~60%

### Method of Measurement

#### 1. Frequency Stability (Temperature Variation)

The temperature inside the climate chamber is varied from -30°C to +50°C in 10°C step size,

(1) With all power removed, the temperature was decreased to 0°C and permitted to stabilize for three hours.

(2) Measure the carrier frequency with the test equipment in a “call mode”. These measurements should be made within 1 minute of powering up the mobile station, to prevent significant self warming.

(3) Repeat the above measurements at 10°C increments from -30°C to +50°C. Allow at least 1.5 hours at each temperature, un-powered, before making measurements.

#### 2. Frequency Stability (Voltage Variation)

The frequency stability shall be measured with variation of primary supply voltage as follows:

**Primary Supply Voltage:** The primary supply voltage is varied from 85% to 115% of the nominal value for non hand-carried battery and AC powered equipment. For hand-carried, battery-powered equipment, primary supply voltage is reduced to the battery operating end point which shall be specified by the manufacturer.

This transceiver is specified to operate with an input voltage of between 3.4 V and 4.35 V, with a nominal voltage of 3.8V.

### Test setup

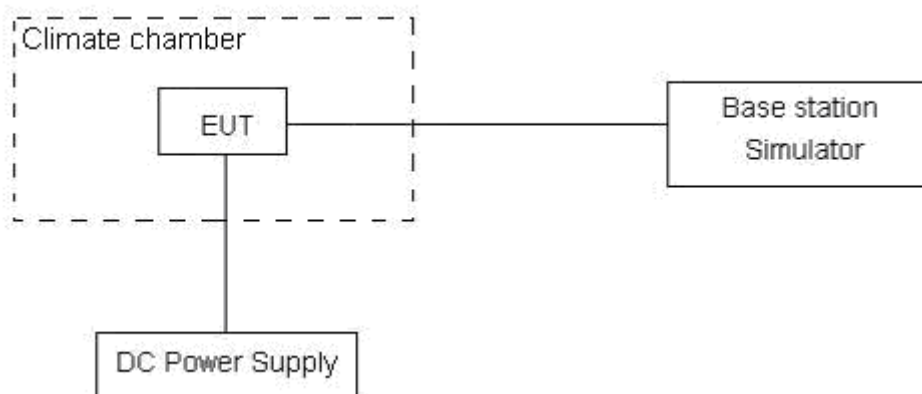

## Limits

According to the Sec. 90.213.(a) Unless noted elsewhere, transmitters used in the services governed by this part must have a minimum frequency stability as specified in the following table.

Minimum Frequency Stability

[Parts per million (ppm)]

Frequency range (MHz)	Fixed and base stations	Mobile stations	
		Over 2 watts output power	2 watts or less output power
814 ~ 824	1.5	2.5	2.5

## Measurement Uncertainty

The assessed measurement uncertainty to ensure 99.75% confidence level for the normal distribution is with the coverage factor  $k = 3$ ,  $U = 0.01$  ppm.

## Test Results

Refer to the section 6.5 of this report for test data.

### 5.6. Spurious Emissions at Antenna Terminals

#### Ambient condition

Temperature	Relative humidity
21°C ~25°C	40%~60%

#### Method of Measurement

The EUT was connected to Spectrum Analyzer and Base Station Simulator via power Splitter. The measurement is carried out using a spectrum analyzer. The spectrum analyzer scans from 30MHz to the 10th harmonic of the carrier. The peak detector is used. RBW and VBW are set to 100 kHz, RBW is set to 1 kHz (0.009MHz~ 0.15 MHz), RBW is set to 10 kHz (0.15 MHz~ 30 MHz) RBW is set to 100 kHz (30MHz~1000 MHz) RBW is set to 1000 kHz (above 1000MHz) Sweep is set to ATUO.

#### Test setup

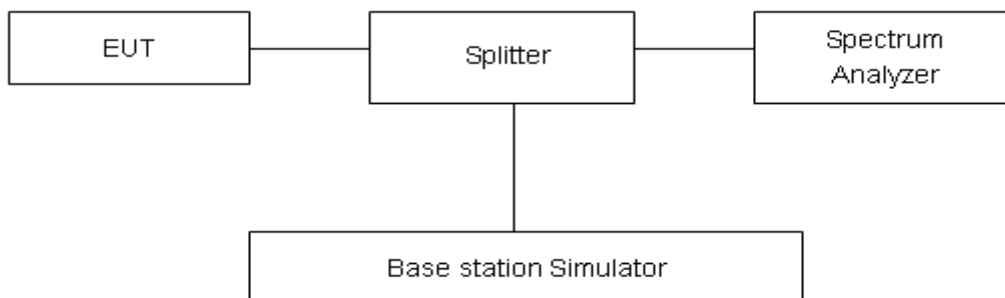

#### Limits

Rule Part 90.691 specifies that “The power of any emission outside of the authorized operating frequency ranges must be attenuated below the transmitting power (P) by a factor of at least 43 + 10 log (P) dB.”

Limit	-13 dBm
-------	---------

#### Measurement Uncertainty

The assessed measurement uncertainty to ensure 99.75% confidence level for the normal distribution is with the coverage factor  $k = 1.96$ .

Frequency	Uncertainty
9kHz-1GHz	0.684 dB
1GHz-20GHz	1.407 dB

#### Test Results

Refer to the section 6.6 of this report for test data.

## 5.7. Radiates Spurious Emission

### Ambient condition

Temperature	Relative humidity
21°C ~25°C	40%~60%

### Method of Measurement

1. The testing follows FCC KDB 971168 v03r01 Section 5.8 and ANSI C63.26 (2015).
2. Below 1GHz: The EUT is placed on a turntable 0.8 meters above the ground in the chamber, 3 meter away from the antenna. The maximal emission value is acquired by adjusting the antenna height, polarisation and turntable azimuth. Normally, the height range of antenna is 1 m to 4 m, the azimuth range of turntable is 0° to 360°, and the receive antenna has two polarizations Vertical (V) and Horizontal (H). Above 1GHz: (Note: the FCC's permission to use 1.5m as an alternative per TCBC Conf call of Dec. 2, 2014.) The EUT is placed on a turntable 1.5 meters above the ground in the chamber, 3 meter away from the antenna. The maximal emission value is acquired by adjusting the antenna height, polarisation and turntable azimuth. Normally, the height range of antenna is 1 m to 4 m, the azimuth range of turntable is 0° to 360°, and the receive antenna has two polarizations Vertical (V) and Horizontal (H).
3. A loop antenna, A log-periodic antenna or horn antenna shall be substituted in place of the EUT. The log-periodic antenna will be driven by a signal generator and the level will be adjusted till the same power value on the spectrum analyzer or receiver. The level of the spurious emissions can be calculated through the level of the signal generator, cable loss, the gain of the substitution antenna and the reading of the spectrum analyzer or receiver.
4. The EUT is then put into continuously transmitting mode at its maximum power level during the test. Set Test Receiver or Spectrum RBW=100kHz,VBW=300kHz, and the maximum value of the receiver should be recorded as (Pr).
5. The EUT shall be replaced by a substitution antenna. In the chamber, an substitution antenna for the frequency band of interest is placed at the reference point of the chamber. An RF Signal source for the frequency band of interest is connected to the substitution antenna with a cable that has been constructed to not interfere with the radiation pattern of the antenna. A power (PMea) is applied to the input of the substitution antenna, and adjust the level of the signal generator output until the value of the receiver reach the previously recorded (Pr). The power of signal source (PMea) is recorded. The test should be performed by rotating the test item and adjusting the receiving antenna polarization.
6. A amplifier should be connected to the Signal Source output port. And the cable should be connect between the Amplifier and the Substitution Antenna. The cable loss (Pcl) ,the Substitution Antenna Gain (Ga) and the Amplifier Gain (PAg) should be recorded after test.
7. The measurement results are obtained as described below:  
$$\text{Power(EIRP)} = \text{PMea} - \text{PAg} - \text{Pcl} + \text{Ga}$$
  
The measurement results are amend as described below:  
$$\text{Power(EIRP)} = \text{PMea} - \text{Pcl} + \text{Ga}$$
8. This value is EIRP since the measurement is calibrated using an antenna of known gain (2.15 dBi) and known input power. ERP can be calculated from EIRP by subtracting the gain of the dipole, ERP



= EIRP-2.15dBi.

The modulation mode and RB allocation refer to section 5.1, using the maximum output power configuration.

**Test setup**

**9KHz ~ 30MHz**

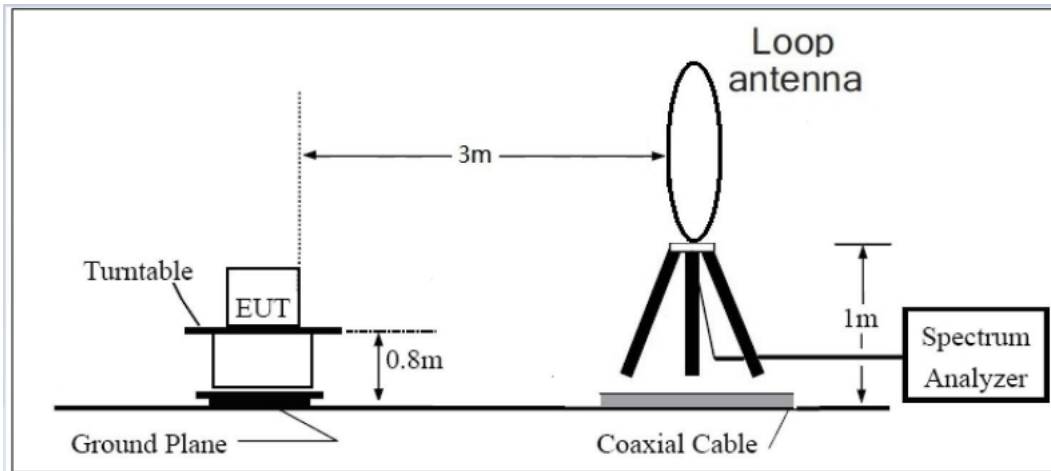

**30MHz ~ 1GHz**

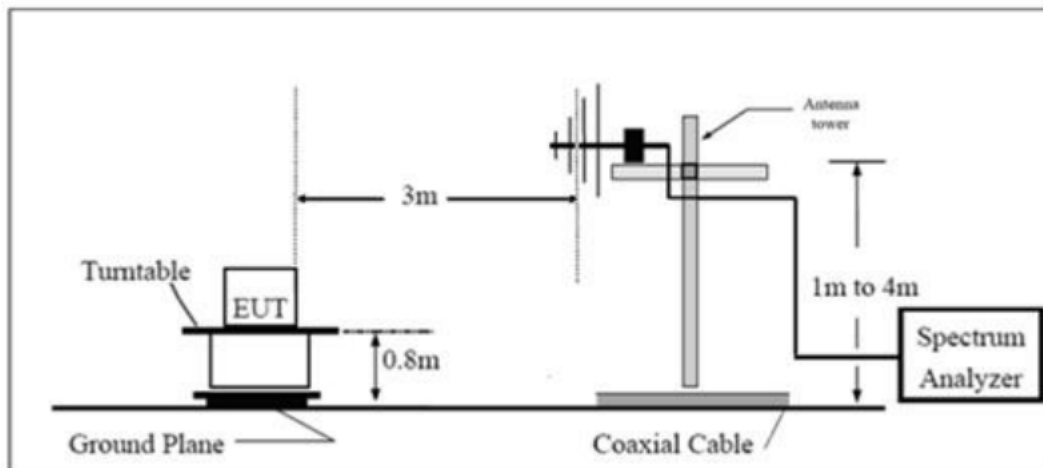

**Above 1GHz**

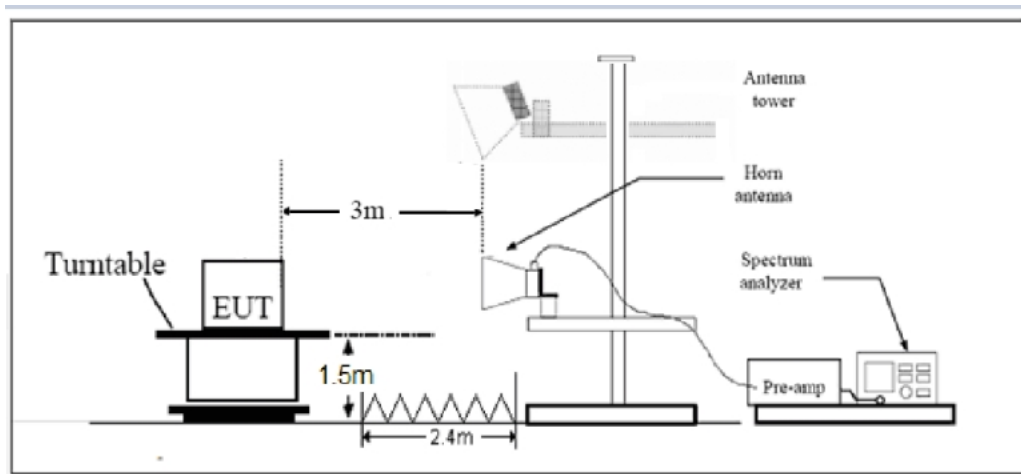



## Limits

Rule Part 90.691 specifies that “The power of any emission outside of the authorized operating frequency ranges must be attenuated below the transmitting power (P) by a factor of at least  $43 + 10 \log(P)$  dB.”

Limit	-13 dBm
-------	---------

## Measurement Uncertainty

The assessed measurement uncertainty to ensure 95% confidence level for the normal distribution is with the coverage factor  $k = 1.96$ ,  $U = 3.55$  dB.

## Test Results

Refer to the section 6.7 of this report for test data.



## 6. Test Results

### 6.1. RF Power Output and Effective Radiated Power

Band	Bandwidth (MHz)	UL Channel	RB Size	RB Position	Modulation	Power (dBm)	ERP (dBm)
LTE Band 26	1.4	26697	1	#0	QPSK	18.84	15.34
LTE Band 26	1.4	26697	1	#Mid	QPSK	19.08	15.32
LTE Band 26	1.4	26697	1	#Max	QPSK	18.90	15.30
LTE Band 26	1.4	26697	3	#0	QPSK	18.88	14.86
LTE Band 26	1.4	26697	3	#Mid	QPSK	18.88	14.86
LTE Band 26	1.4	26697	3	#Max	QPSK	18.92	14.94
LTE Band 26	1.4	26697	6	#0	QPSK	17.93	14.51
LTE Band 26	1.4	26697	1	#0	QAM16	17.82	15.59
LTE Band 26	1.4	26697	1	#Mid	QAM16	18.09	15.65
LTE Band 26	1.4	26697	1	#Max	QAM16	17.90	15.57
LTE Band 26	1.4	26697	3	#0	QAM16	18.04	14.84
LTE Band 26	1.4	26697	3	#Mid	QAM16	18.04	14.76
LTE Band 26	1.4	26697	3	#Max	QAM16	18.10	14.80
LTE Band 26	1.4	26697	6	#0	QAM16	18.93	13.99
LTE Band 26	1.4	26740	1	#0	QPSK	20.68	14.42
LTE Band 26	1.4	26740	1	#Mid	QPSK	20.74	14.44
LTE Band 26	1.4	26740	1	#Max	QPSK	20.62	14.39
LTE Band 26	1.4	26740	3	#0	QPSK	20.64	15.03
LTE Band 26	1.4	26740	3	#Mid	QPSK	20.64	15.03
LTE Band 26	1.4	26740	3	#Max	QPSK	20.60	15.01
LTE Band 26	1.4	26740	6	#0	QPSK	19.68	14.10
LTE Band 26	1.4	26740	1	#0	QAM16	20.32	14.83
LTE Band 26	1.4	26740	1	#Mid	QAM16	20.32	14.87
LTE Band 26	1.4	26740	1	#Max	QAM16	20.31	14.77
LTE Band 26	1.4	26740	3	#0	QAM16	19.57	14.61
LTE Band 26	1.4	26740	3	#Mid	QAM16	19.49	14.58
LTE Band 26	1.4	26740	3	#Max	QAM16	19.44	14.59
LTE Band 26	1.4	26740	6	#0	QAM16	18.52	14.37
LTE Band 26	1.4	26783	1	#0	QPSK	20.59	15.66
LTE Band 26	1.4	26783	1	#Mid	QPSK	20.66	15.61
LTE Band 26	1.4	26783	1	#Max	QPSK	20.65	15.71
LTE Band 26	1.4	26783	3	#0	QPSK	20.67	14.09
LTE Band 26	1.4	26783	3	#Mid	QPSK	20.60	14.10
LTE Band 26	1.4	26783	3	#Max	QPSK	20.57	14.07
LTE Band 26	1.4	26783	6	#0	QPSK	19.51	14.01
LTE Band 26	1.4	26783	1	#0	QAM16	18.93	14.44



LTE Band 26	1.4	26783	1	#Mid	QAM16	18.95	14.43
LTE Band 26	1.4	26783	1	#Max	QAM16	18.90	14.43
LTE Band 26	1.4	26783	3	#0	QAM16	19.54	14.43
LTE Band 26	1.4	26783	3	#Mid	QAM16	21.62	14.43
LTE Band 26	1.4	26783	3	#Max	QAM16	21.65	14.10
LTE Band 26	1.4	26783	6	#0	QAM16	20.72	13.99
LTE Band 26	3	26705	1	#0	QPSK	22.65	14.63
LTE Band 26	3	26705	1	#Mid	QPSK	22.86	14.56
LTE Band 26	3	26705	1	#Max	QPSK	22.71	14.52
LTE Band 26	3	26705	8	#0	QPSK	21.64	14.33
LTE Band 26	3	26705	8	#Mid	QPSK	21.65	14.33
LTE Band 26	3	26705	8	#Max	QPSK	21.56	14.21
LTE Band 26	3	26705	15	#0	QPSK	21.55	14.44
LTE Band 26	3	26705	1	#0	QAM16	21.11	14.99
LTE Band 26	3	26705	1	#Mid	QAM16	21.05	14.93
LTE Band 26	3	26705	1	#Max	QAM16	21.08	14.98
LTE Band 26	3	26705	8	#0	QAM16	21.16	14.33
LTE Band 26	3	26705	8	#Mid	QAM16	21.15	14.33
LTE Band 26	3	26705	8	#Max	QAM16	21.18	14.36
LTE Band 26	3	26705	15	#0	QAM16	20.97	14.03
LTE Band 26	3	26740	1	#0	QPSK	22.62	14.83
LTE Band 26	3	26740	1	#Mid	QPSK	22.58	14.91
LTE Band 26	3	26740	1	#Max	QPSK	22.61	14.84
LTE Band 26	3	26740	8	#0	QPSK	21.54	14.44
LTE Band 26	3	26740	8	#Mid	QPSK	21.53	14.46
LTE Band 26	3	26740	8	#Max	QPSK	21.51	13.98
LTE Band 26	3	26740	15	#0	QPSK	21.53	14.16
LTE Band 26	3	26740	1	#0	QAM16	21.43	14.82
LTE Band 26	3	26740	1	#Mid	QAM16	21.38	14.71
LTE Band 26	3	26740	1	#Max	QAM16	21.55	14.68
LTE Band 26	3	26740	8	#0	QAM16	20.74	14.40
LTE Band 26	3	26740	8	#Mid	QAM16	20.86	14.36
LTE Band 26	3	26740	8	#Max	QAM16	20.82	14.35
LTE Band 26	3	26740	15	#0	QAM16	20.57	14.00
LTE Band 26	3	26775	1	#0	QPSK	22.49	15.34
LTE Band 26	3	26775	1	#Mid	QPSK	22.54	15.32
LTE Band 26	3	26775	1	#Max	QPSK	22.49	15.30
LTE Band 26	3	26775	8	#0	QPSK	21.58	14.86
LTE Band 26	3	26775	8	#Mid	QPSK	21.51	14.86
LTE Band 26	3	26775	8	#Max	QPSK	21.68	14.94
LTE Band 26	3	26775	15	#0	QPSK	21.57	14.51
LTE Band 26	3	26775	1	#0	QAM16	22.25	15.59
LTE Band 26	3	26775	1	#Mid	QAM16	22.26	15.65



LTE Band 26	3	26775	1	#Max	QAM16	22.24	15.57
LTE Band 26	3	26775	8	#0	QAM16	21.04	14.84
LTE Band 26	3	26775	8	#Mid	QAM16	21.05	14.76
LTE Band 26	3	26775	8	#Max	QAM16	20.65	14.80
LTE Band 26	3	26775	15	#0	QAM16	20.71	13.99
LTE Band 26	5	26715	1	#0	QPSK	22.57	14.42
LTE Band 26	5	26715	1	#Mid	QPSK	22.58	14.44
LTE Band 26	5	26715	1	#Max	QPSK	22.54	14.39
LTE Band 26	5	26715	12	#0	QPSK	21.58	15.03
LTE Band 26	5	26715	12	#Mid	QPSK	21.58	15.03
LTE Band 26	5	26715	12	#Max	QPSK	21.60	15.01
LTE Band 26	5	26715	25	#0	QPSK	21.62	14.10
LTE Band 26	5	26715	1	#0	QAM16	21.28	14.83
LTE Band 26	5	26715	1	#Mid	QAM16	21.13	14.87
LTE Band 26	5	26715	1	#Max	QAM16	21.19	14.77
LTE Band 26	5	26715	12	#0	QAM16	18.80	14.61
LTE Band 26	5	26715	12	#Mid	QAM16	18.84	14.58
LTE Band 26	5	26715	12	#Max	QAM16	18.88	14.59
LTE Band 26	5	26715	25	#0	QAM16	18.95	14.37
LTE Band 26	5	26740	1	#0	QPSK	20.98	15.66
LTE Band 26	5	26740	1	#Mid	QPSK	20.62	15.61
LTE Band 26	5	26740	1	#Max	QPSK	20.97	15.71
LTE Band 26	5	26740	12	#0	QPSK	20.02	14.09
LTE Band 26	5	26740	12	#Mid	QPSK	20.00	14.10
LTE Band 26	5	26740	12	#Max	QPSK	20.05	14.07
LTE Band 26	5	26740	25	#0	QPSK	19.58	14.01
LTE Band 26	5	26740	1	#0	QAM16	19.79	14.44
LTE Band 26	5	26740	1	#Mid	QAM16	19.32	14.43
LTE Band 26	5	26740	1	#Max	QAM16	19.80	14.43
LTE Band 26	5	26740	12	#0	QAM16	18.46	14.43
LTE Band 26	5	26740	12	#Mid	QAM16	18.49	14.43
LTE Band 26	5	26740	12	#Max	QAM16	18.47	14.10
LTE Band 26	5	26740	25	#0	QAM16	18.53	13.99
LTE Band 26	5	26765	1	#0	QPSK	20.50	14.63
LTE Band 26	5	26765	1	#Mid	QPSK	20.83	14.56
LTE Band 26	5	26765	1	#Max	QPSK	20.43	14.52
LTE Band 26	5	26765	12	#0	QPSK	21.68	14.33
LTE Band 26	5	26765	12	#Mid	QPSK	21.57	14.33
LTE Band 26	5	26765	12	#Max	QPSK	21.52	14.21
LTE Band 26	5	26765	25	#0	QPSK	21.67	14.44
LTE Band 26	5	26765	1	#0	QAM16	21.64	14.99
LTE Band 26	5	26765	1	#Mid	QAM16	21.68	14.93
LTE Band 26	5	26765	1	#Max	QAM16	21.62	14.98



LTE Band 26	5	26765	12	#0	QAM16	21.09	14.33
LTE Band 26	5	26765	12	#Mid	QAM16	21.12	14.33
LTE Band 26	5	26765	12	#Max	QAM16	20.67	14.36
LTE Band 26	5	26765	25	#0	QAM16	21.00	14.03
LTE Band 26	10	26740	1	#0	QPSK	22.63	14.83
LTE Band 26	10	26740	1	#Mid	QPSK	22.42	14.91
LTE Band 26	10	26740	1	#Max	QPSK	22.46	14.84
LTE Band 26	10	26740	25	#0	QPSK	21.58	14.44
LTE Band 26	10	26740	25	#Mid	QPSK	21.61	14.46
LTE Band 26	10	26740	25	#Max	QPSK	21.65	13.98
LTE Band 26	10	26740	50	#0	QPSK	21.63	14.16
LTE Band 26	10	26740	1	#0	QAM16	21.38	14.82
LTE Band 26	10	26740	1	#Mid	QAM16	21.28	14.71
LTE Band 26	10	26740	1	#Max	QAM16	21.22	14.68
LTE Band 26	10	26740	25	#0	QAM16	21.07	14.40
LTE Band 26	10	26740	25	#Mid	QAM16	21.07	14.36
LTE Band 26	10	26740	25	#Max	QAM16	20.93	14.35
LTE Band 26	10	26740	50	#0	QAM16	20.68	14.00
LTE Band 26	1.4	26697	1	#0	QAM64	21.69	15.34
LTE Band 26	1.4	26697	1	#Mid	QAM64	21.67	15.32
LTE Band 26	1.4	26697	1	#Max	QAM64	21.65	15.30
LTE Band 26	1.4	26697	3	#0	QAM64	21.21	14.86
LTE Band 26	1.4	26697	3	#Mid	QAM64	21.21	14.86
LTE Band 26	1.4	26697	3	#Max	QAM64	21.29	14.94
LTE Band 26	1.4	26697	6	#0	QAM64	20.86	14.51
LTE Band 26	1.4	26740	1	#0	QAM64	21.94	15.59
LTE Band 26	1.4	26740	1	#Mid	QAM64	22.00	15.65
LTE Band 26	1.4	26740	1	#Max	QAM64	21.92	15.57
LTE Band 26	1.4	26740	3	#0	QAM64	21.19	14.84
LTE Band 26	1.4	26740	3	#Mid	QAM64	21.11	14.76
LTE Band 26	1.4	26740	3	#Max	QAM64	21.15	14.80
LTE Band 26	1.4	26740	6	#0	QAM64	20.34	13.99
LTE Band 26	1.4	26783	1	#0	QAM64	20.77	14.42
LTE Band 26	1.4	26783	1	#Mid	QAM64	20.79	14.44
LTE Band 26	1.4	26783	1	#Max	QAM64	20.74	14.39
LTE Band 26	1.4	26783	3	#0	QAM64	21.38	15.03
LTE Band 26	1.4	26783	3	#Mid	QAM64	21.38	15.03
LTE Band 26	1.4	26783	3	#Max	QAM64	21.36	15.01
LTE Band 26	1.4	26783	6	#0	QAM64	20.45	14.10
LTE Band 26	3	26705	1	#0	QAM64	21.18	14.83
LTE Band 26	3	26705	1	#Mid	QAM64	21.22	14.87
LTE Band 26	3	26705	1	#Max	QAM64	21.12	14.77
LTE Band 26	3	26705	8	#0	QAM64	20.96	14.61



LTE Band 26	3	26705	8	#Mid	QAM64	20.93	14.58
LTE Band 26	3	26705	8	#Max	QAM64	20.94	14.59
LTE Band 26	3	26705	15	#0	QAM64	20.72	14.37
LTE Band 26	3	26740	1	#0	QAM64	22.01	15.66
LTE Band 26	3	26740	1	#Mid	QAM64	21.96	15.61
LTE Band 26	3	26740	1	#Max	QAM64	22.06	15.71
LTE Band 26	3	26740	8	#0	QAM64	20.44	14.09
LTE Band 26	3	26740	8	#Mid	QAM64	20.45	14.10
LTE Band 26	3	26740	8	#Max	QAM64	20.42	14.07
LTE Band 26	3	26740	15	#0	QAM64	20.36	14.01
LTE Band 26	3	26775	1	#0	QAM64	20.79	14.44
LTE Band 26	3	26775	1	#Mid	QAM64	20.78	14.43
LTE Band 26	3	26775	1	#Max	QAM64	20.78	14.43
LTE Band 26	3	26775	8	#0	QAM64	20.78	14.43
LTE Band 26	3	26775	8	#Mid	QAM64	20.78	14.43
LTE Band 26	3	26775	8	#Max	QAM64	20.45	14.10
LTE Band 26	3	26775	15	#0	QAM64	20.34	13.99
LTE Band 26	5	26715	1	#0	QAM64	20.98	14.63
LTE Band 26	5	26715	1	#Mid	QAM64	20.91	14.56
LTE Band 26	5	26715	1	#Max	QAM64	20.87	14.52
LTE Band 26	5	26715	12	#0	QAM64	20.68	14.33
LTE Band 26	5	26715	12	#Mid	QAM64	20.68	14.33
LTE Band 26	5	26715	12	#Max	QAM64	20.56	14.21
LTE Band 26	5	26715	25	#0	QAM64	20.79	14.44
LTE Band 26	5	26740	1	#0	QAM64	21.34	14.99
LTE Band 26	5	26740	1	#Mid	QAM64	21.28	14.93
LTE Band 26	5	26740	1	#Max	QAM64	21.33	14.98
LTE Band 26	5	26740	12	#0	QAM64	20.68	14.33
LTE Band 26	5	26740	12	#Mid	QAM64	20.68	14.33
LTE Band 26	5	26740	12	#Max	QAM64	20.71	14.36
LTE Band 26	5	26740	25	#0	QAM64	20.38	14.03
LTE Band 26	5	26765	1	#0	QAM64	21.18	14.83
LTE Band 26	5	26765	1	#Mid	QAM64	21.26	14.91
LTE Band 26	5	26765	1	#Max	QAM64	21.19	14.84
LTE Band 26	5	26765	12	#0	QAM64	20.79	14.44
LTE Band 26	5	26765	12	#Mid	QAM64	20.81	14.46
LTE Band 26	5	26765	12	#Max	QAM64	20.33	13.98
LTE Band 26	5	26765	25	#0	QAM64	20.51	14.16
LTE Band 26	10	26740	1	#0	QAM64	21.17	14.82
LTE Band 26	10	26740	1	#Mid	QAM64	21.06	14.71
LTE Band 26	10	26740	1	#Max	QAM64	21.03	14.68
LTE Band 26	10	26740	25	#0	QAM64	20.75	14.40
LTE Band 26	10	26740	25	#Mid	QAM64	20.71	14.36



LTE Band 26	10	26740	25	#Max	QAM64	20.70	14.35
LTE Band 26	10	26740	50	#0	QAM64	20.35	14.00



### 6.2. Occupied Bandwidth

LTE Band 26							
RB	Modulation	Bandwidth (MHz)	Channel	Frequency (MHz)	99% Power Bandwidth(MHz)	-26dBc Bandwidth(MHz)	
100%	QPSK	1.4	26697	814.7	1.094	1.247	
			26740	819	1.098	1.248	
			26783	823.3	1.097	1.254	
		3	26705	815.5	2.719	3.031	
			26740	819	2.712	3.028	
			26775	822.5	2.712	3.020	
		5	26715	816.5	4.524	4.977	
			26740	819	4.513	4.993	
			26765	821.5	4.510	5.021	
		10	26740	819	8.992	9.740	
		16QAM	1.4	26697	814.7	1.098	1.257
				26740	819	1.093	1.243
	26783			823.3	1.095	1.248	
	3		26705	815.5	2.714	3.030	
			26740	819	2.701	3.022	
			26775	822.5	2.709	3.044	
	5		26715	816.5	4.507	4.956	
			26740	819	4.528	4.949	
			26765	821.5	4.504	4.965	
	10		26740	819	9.006	9.845	
	64QAM		1.4	26697	814.7	1.099	1.263
				26740	819	1.099	1.247
		26783		823.3	1.101	1.256	
		3	26705	815.5	2.709	3.015	
			26740	819	2.715	3.051	
			26775	822.5	2.709	3.056	
		5	26715	816.5	4.521	4.910	
			26740	819	4.506	4.976	
			26765	821.5	4.525	4.977	
		10	26740	819	8.984	9.734	

LTE Band 26 QPSK 1.4MHz CH Low

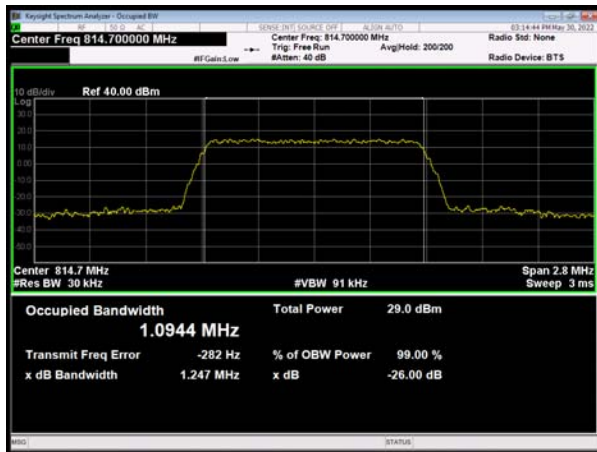

LTE Band 26 QPSK 3MHz CH Low



LTE Band 26 QPSK 1.4MHz CH Middle

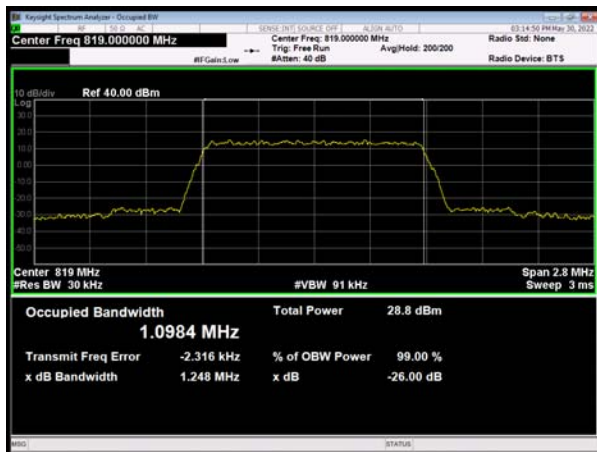

LTE Band 26 QPSK 3MHz CH Middle

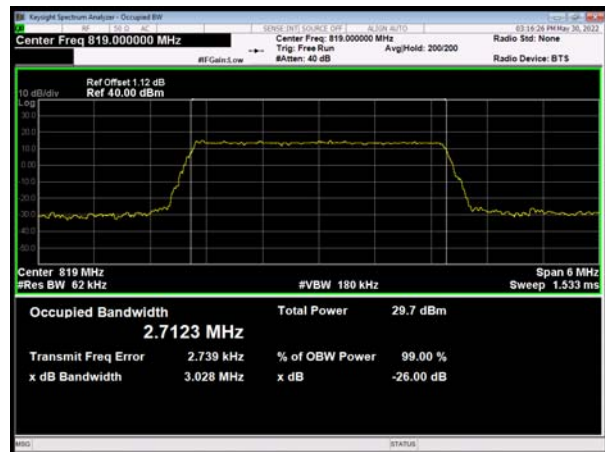

LTE Band 26 QPSK 1.4MHz CH High

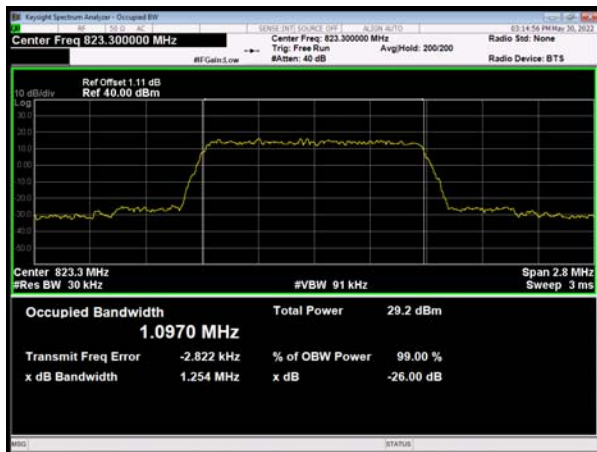

LTE Band 26 QPSK 3MHz CH High

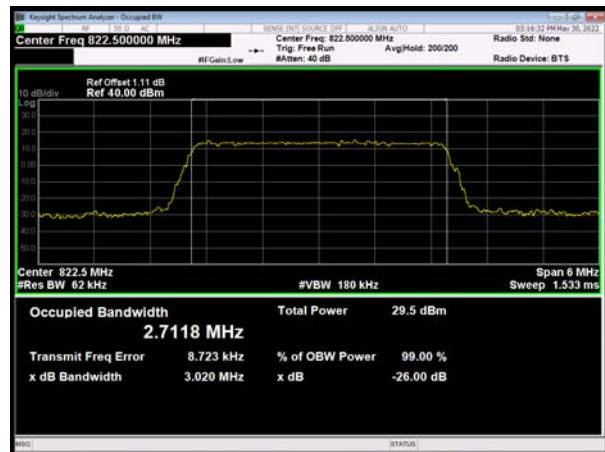



LTE Band 26 QPSK 5MHz CH Low



LTE Band 26 QPSK 5MHz CH Middle

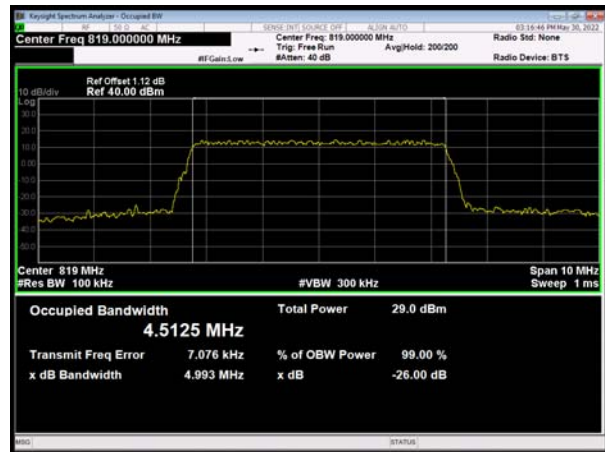

LTE Band 26 QPSK 5MHz CH High



LTE Band 26 QPSK 10MHz CH Middle



LTE Band 26 16QAM 1.4MHz CH Low

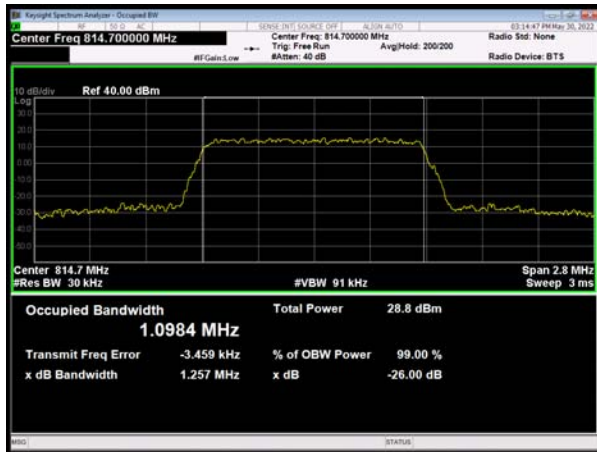

LTE Band 26 16QAM 3MHz CH Low



LTE Band 26 16QAM 1.4MHz CH Middle

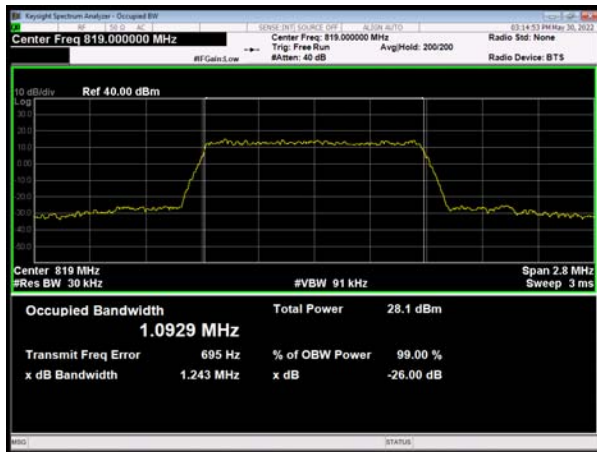

LTE Band 26 16QAM 3MHz CH Middle



LTE Band 26 16QAM 1.4MHz CH High

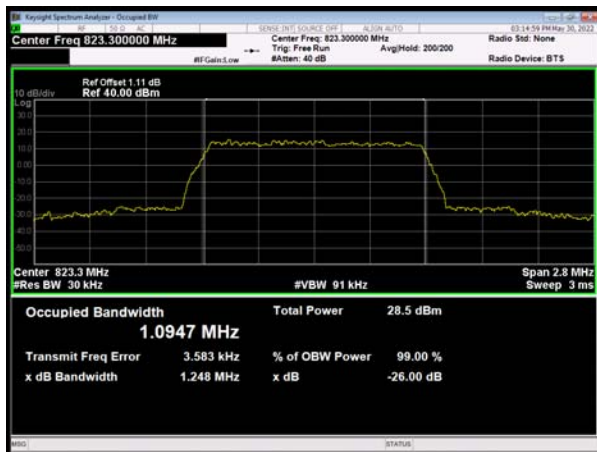

LTE Band 26 16QAM 3MHz CH High

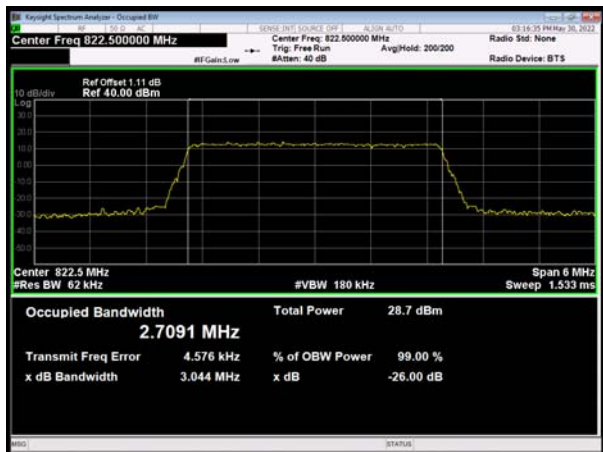

LTE Band 26 16QAM 5MHz CH Low

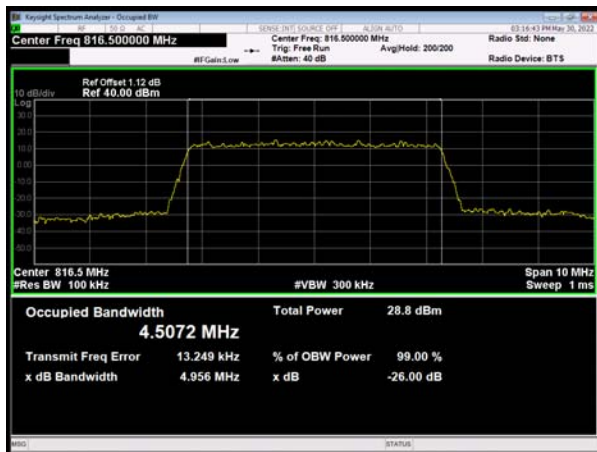

LTE Band 26 16QAM 5MHz CH Middle





LTE Band 26 16QAM 5MHz CH High



LTE Band 26 16QAM 10MHz CH Middle



LTE Band 26 64QAM 1.4MHz CH Low

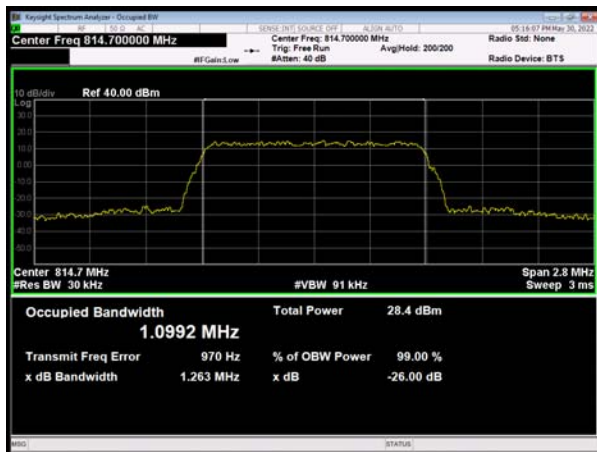

LTE Band 26 64QAM 3MHz CH Low

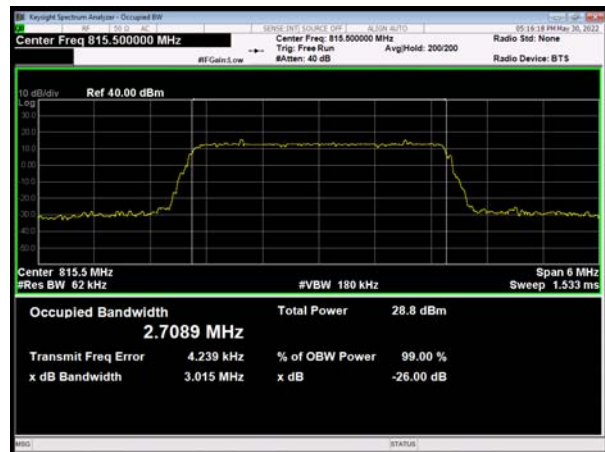

LTE Band 26 64QAM 1.4MHz CH Middle

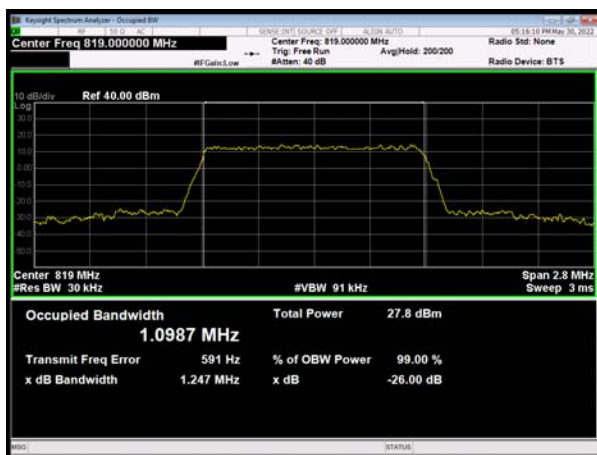

LTE Band 26 64QAM 3MHz CH Middle



LTE Band 26 64QAM 1.4MHz CH High

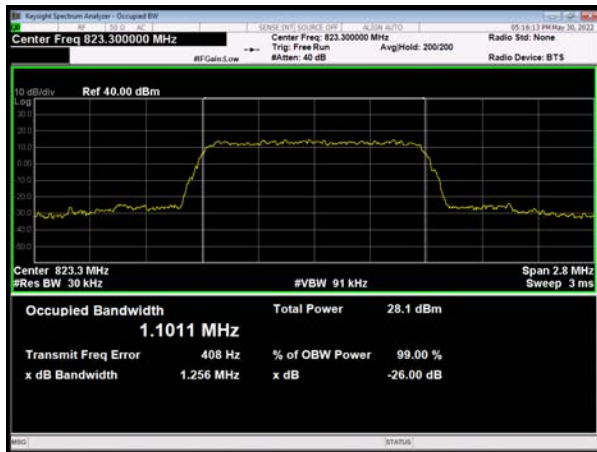

LTE Band 26 64QAM 3MHz CH High



LTE Band 26 64QAM 5MHz CH Low

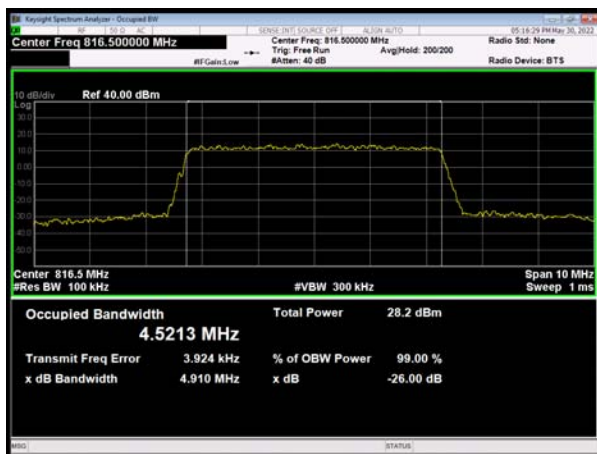

LTE Band 26 64QAM 5MHz CH Middle

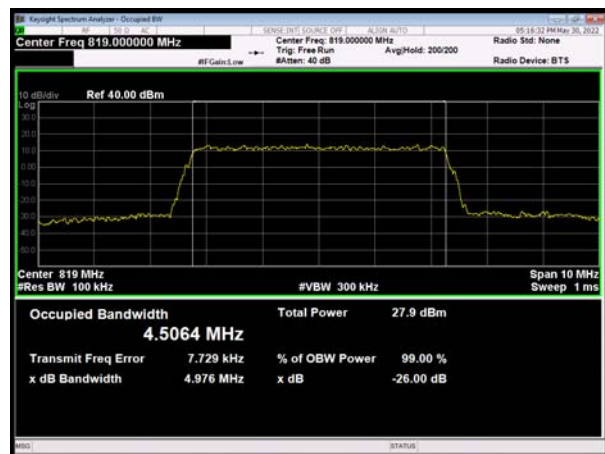

LTE Band 26 64QAM 5MHz CH High



LTE Band 26 64QAM 10MHz CH Middle



### 6.3. Emission Mask

LTE Band 26 QPSK 1.4MHz CH-Low 1RB

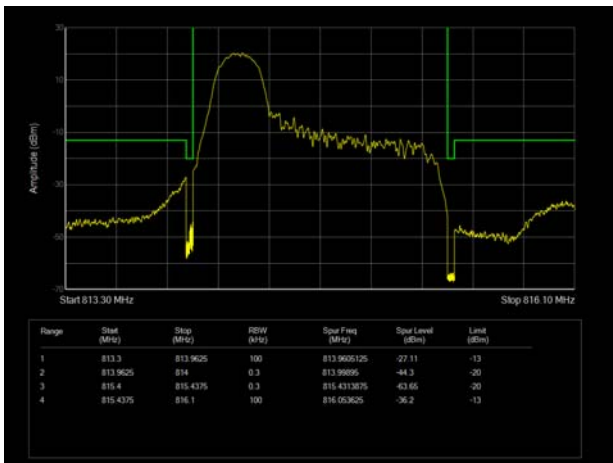

LTE Band 26 QPSK 1.4MHz CH-High 1RB

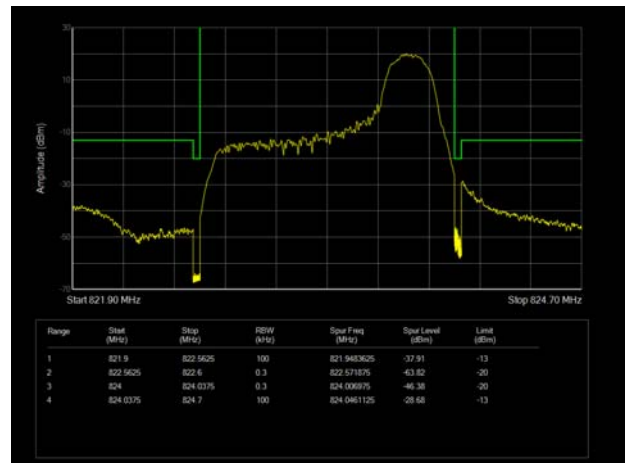

LTE Band 26 QPSK 1.4MHz CH-Low 100%RB

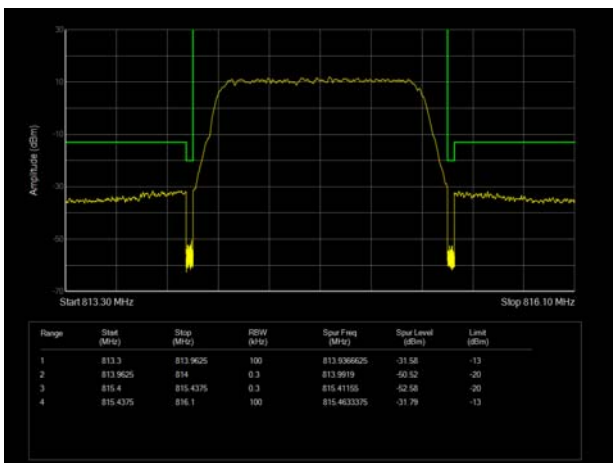

LTE Band 26 QPSK 1.4MHz CH-High 100%RB

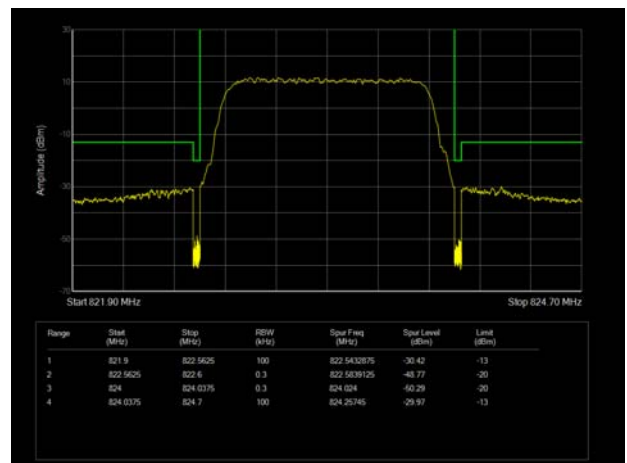

LTE Band 26 QPSK 3MHz CH-Low 1RB

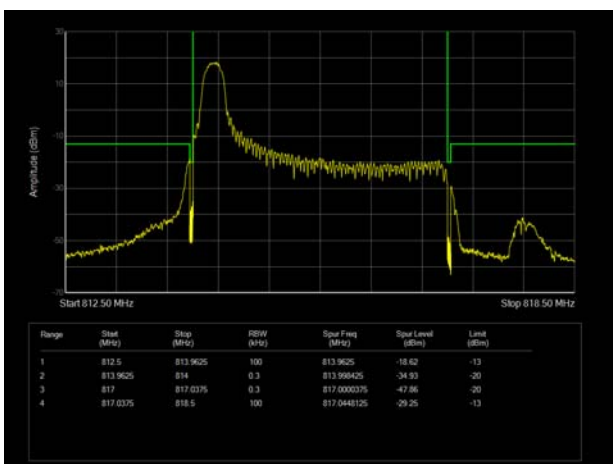

LTE Band 26 QPSK 3MHz CH-High 1RB

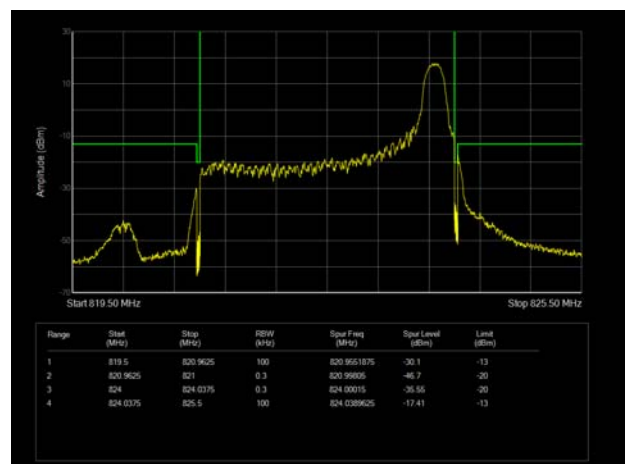

LTE Band 26 QPSK 3MHz CH-Low 100%RB

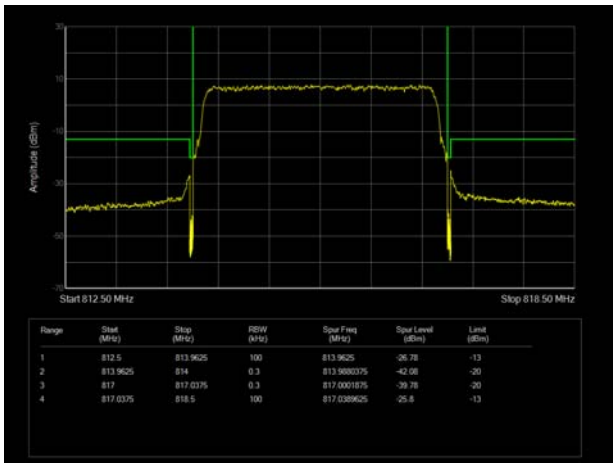

LTE Band 26 QPSK 3MHz CH-High 100%RB

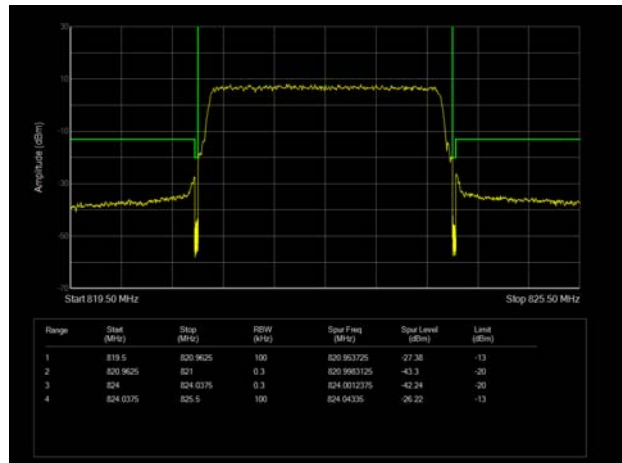

LTE Band 26 QPSK 5MHz CH-Low 1RB

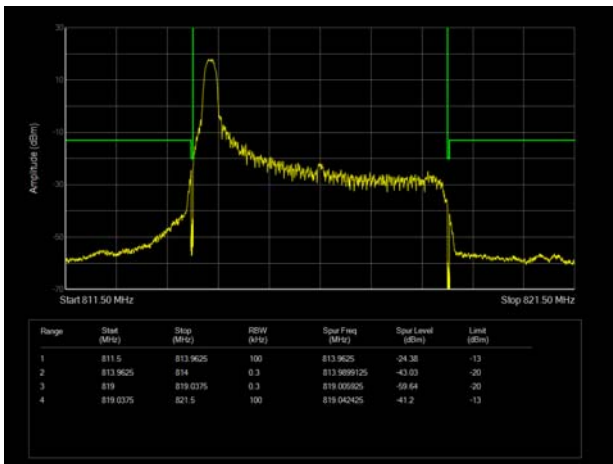

LTE Band 26 QPSK 5MHz CH-High 1RB

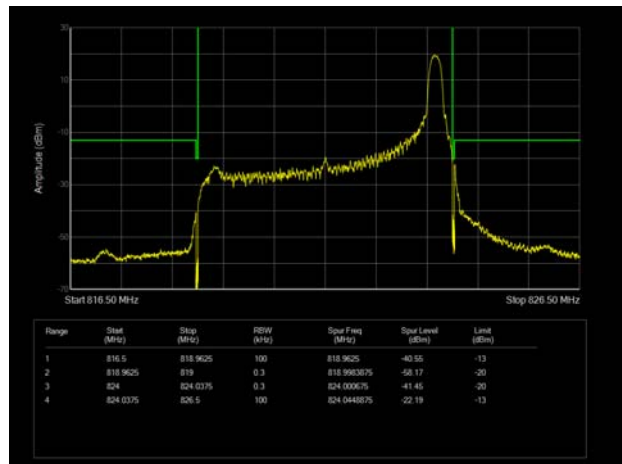

LTE Band 26 QPSK 5MHz CH-Low 100%RB

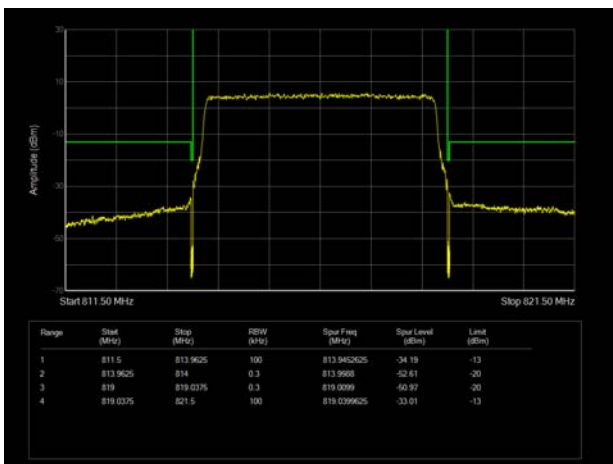

LTE Band 26 QPSK 5MHz CH-High 100%RB

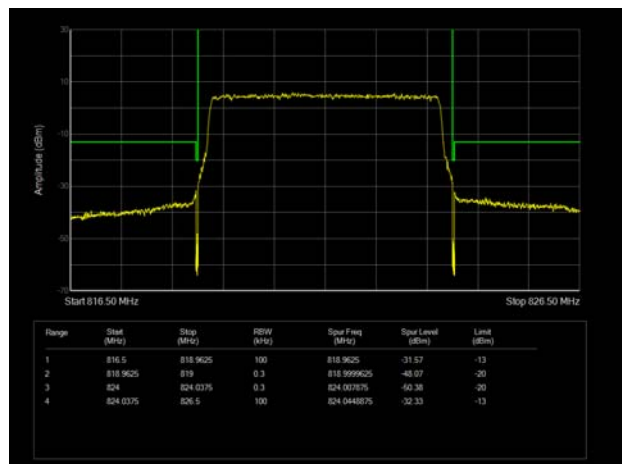



LTE Band 26 QPSK 10MHz CH-Low 1RB

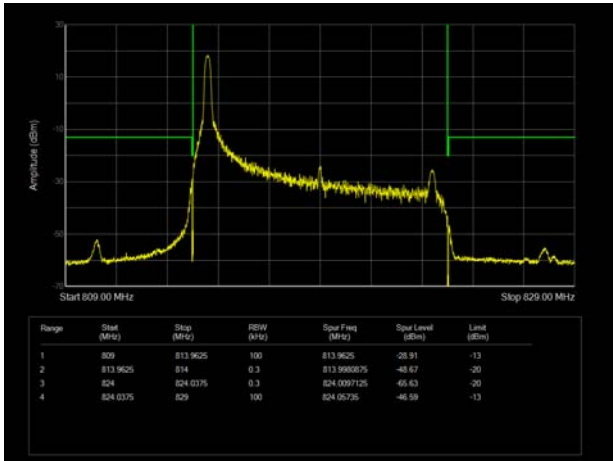

LTE Band 26 QPSK 10MHz CH-High 1RB

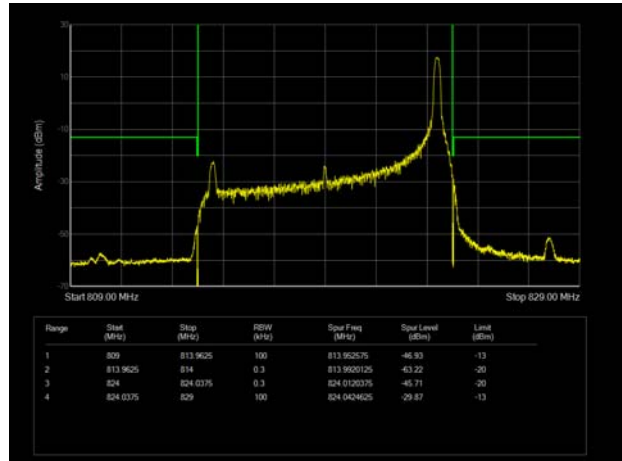

LTE Band 26 QPSK 10MHz CH-Low 100%RB

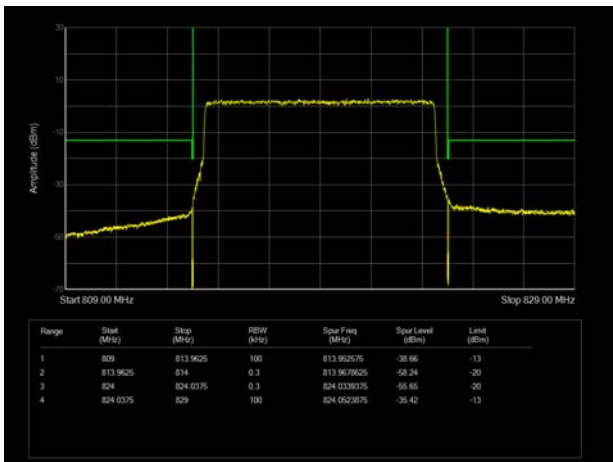

LTE Band 26 QPSK 10MHz CH-High 100%RB

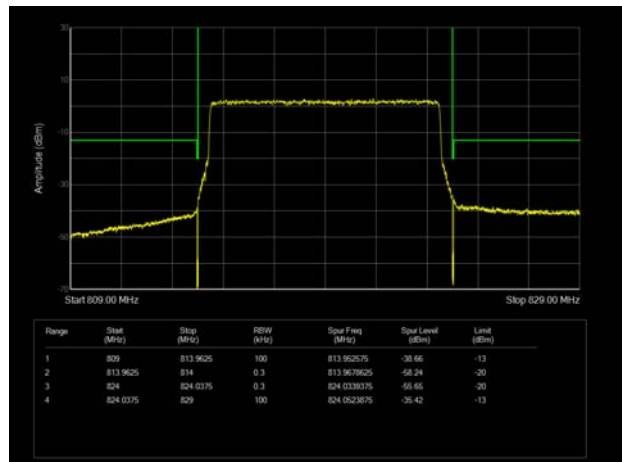

LTE Band 26 16QAM 1.4MHz CH-Low 1RB

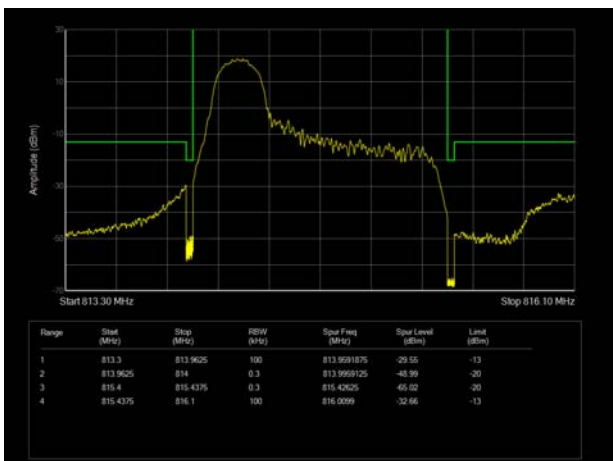

LTE Band 26 16QAM 1.4MHz CH-High 1RB

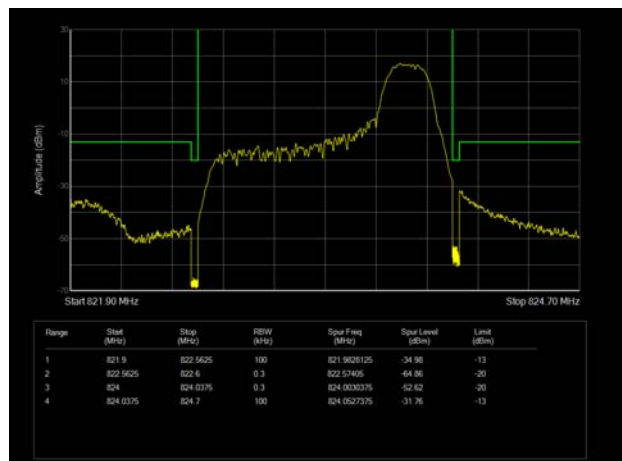

LTE Band 26 16QAM 1.4MHz CH-Low 100%RB

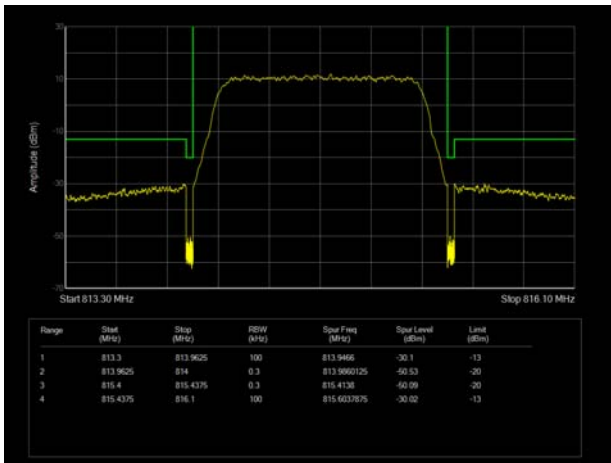

LTE Band 26 16QAM 1.4MHz CH-High 100%RB

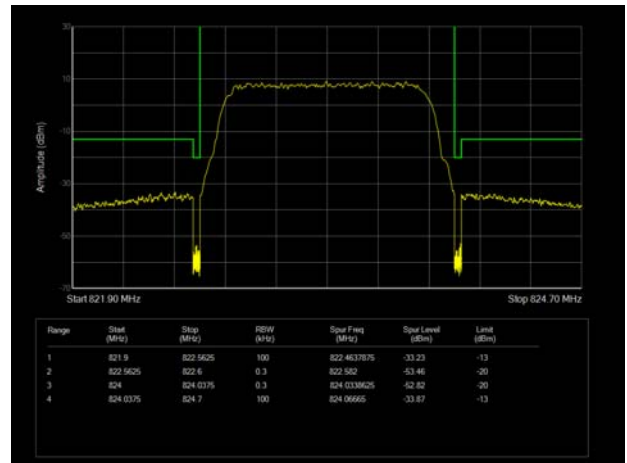

LTE Band 26 16QAM 3MHz CH-Low 1RB

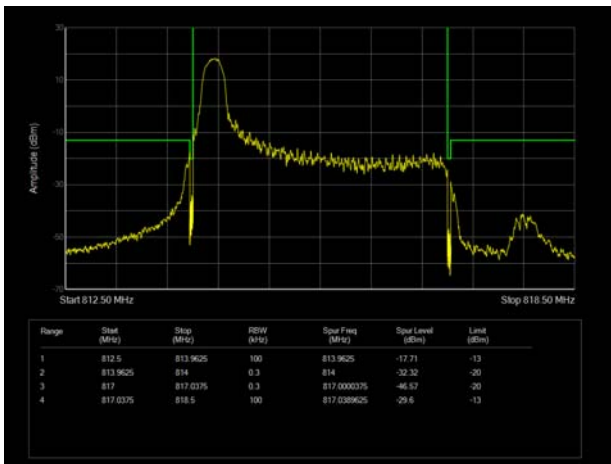

LTE Band 26 16QAM 3MHz CH-High 1RB

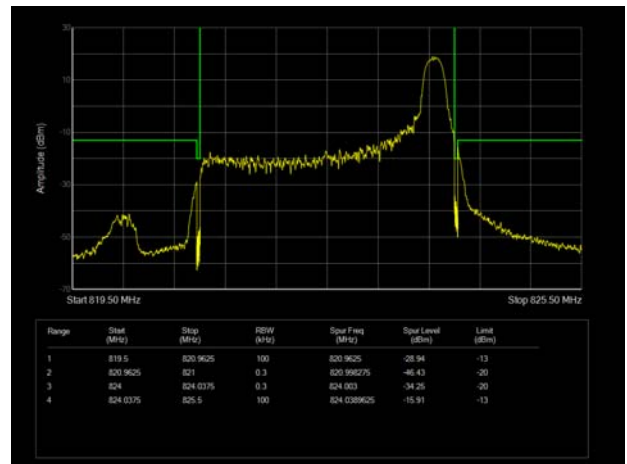

LTE Band 26 16QAM 3MHz CH-Low 100%RB

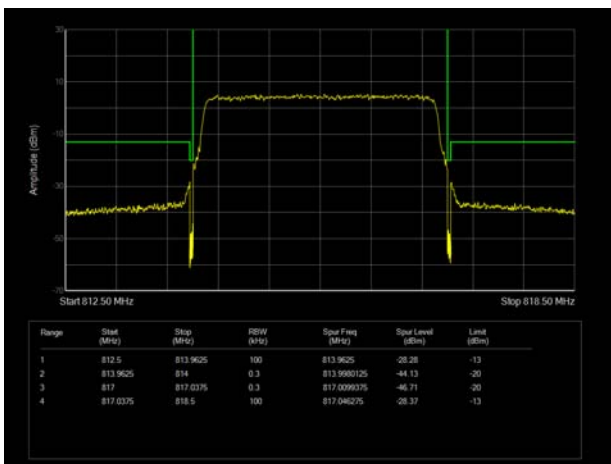

LTE Band 26 16QAM 3MHz CH-High 100%RB

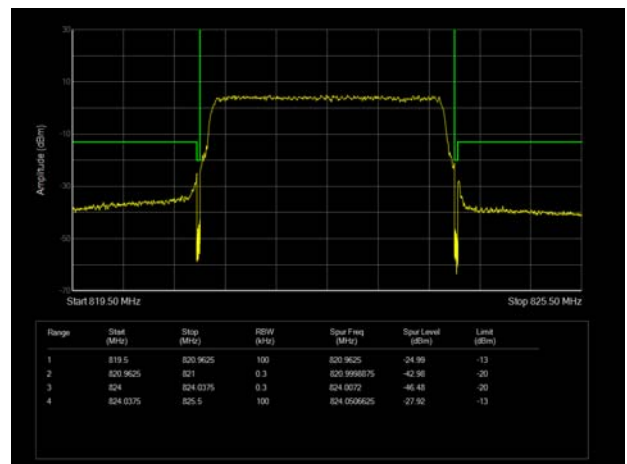

LTE Band 26 16QAM 5MHz CH-Low 1RB

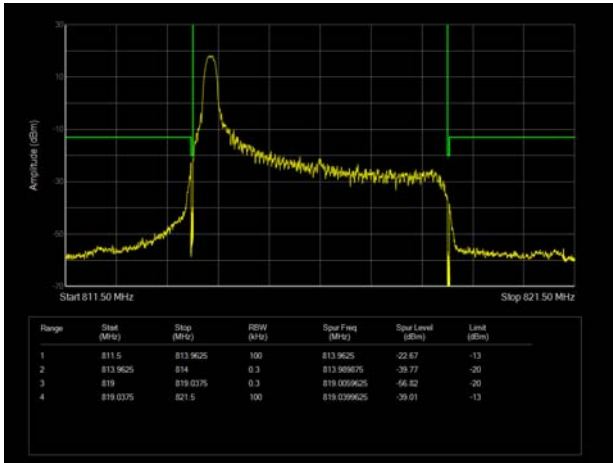

LTE Band 26 16QAM 5MHz CH-High 1RB

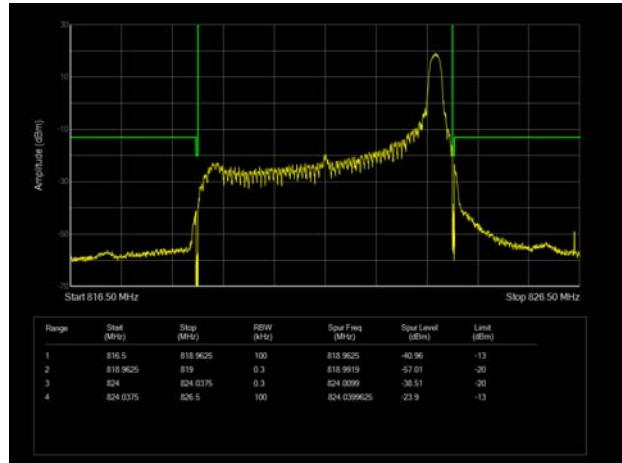

LTE Band 26 16QAM 5MHz CH-Low 100%RB

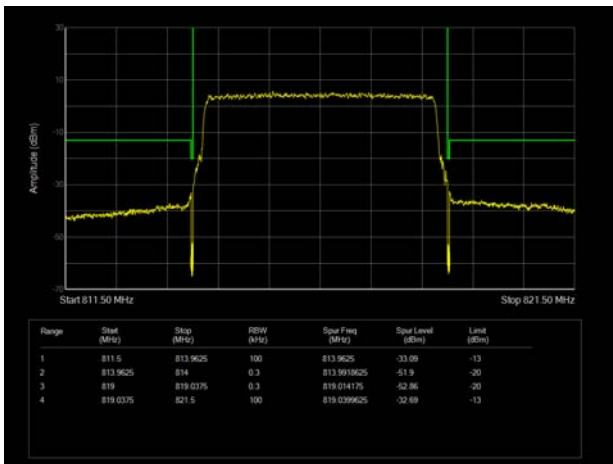

LTE Band 26 16QAM 5MHz CH-High 100%RB

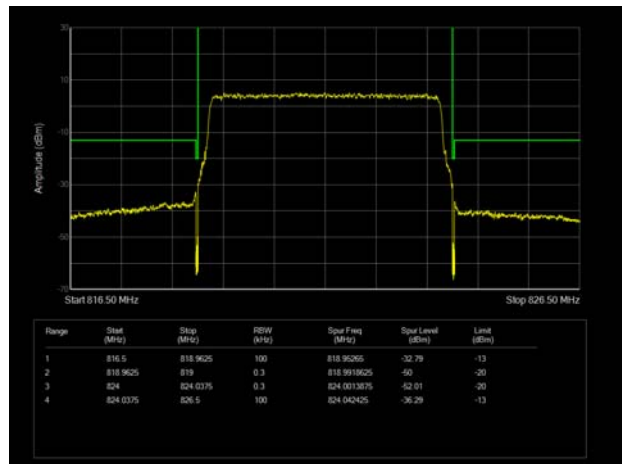

LTE Band 26 16QAM 10MHz CH-Low 1RB

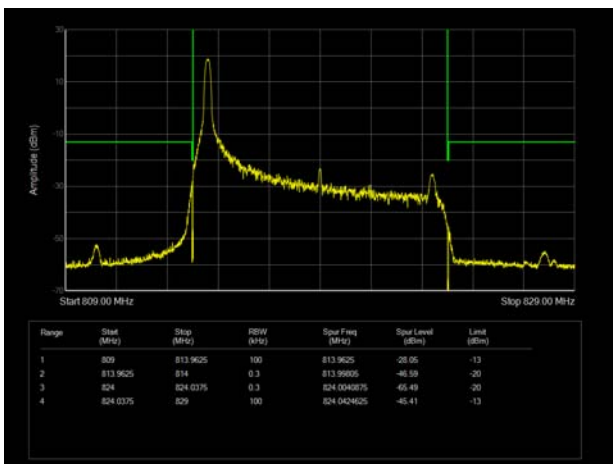

LTE Band 26 16QAM 10MHz CH-High 1RB

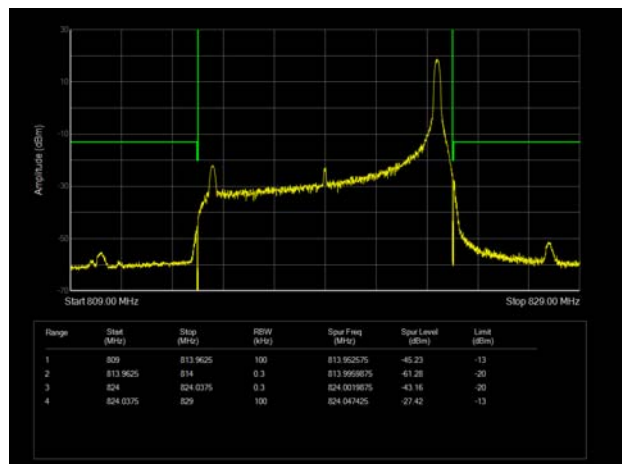

LTE Band 26 16QAM 10MHz CH-Low 100%RB

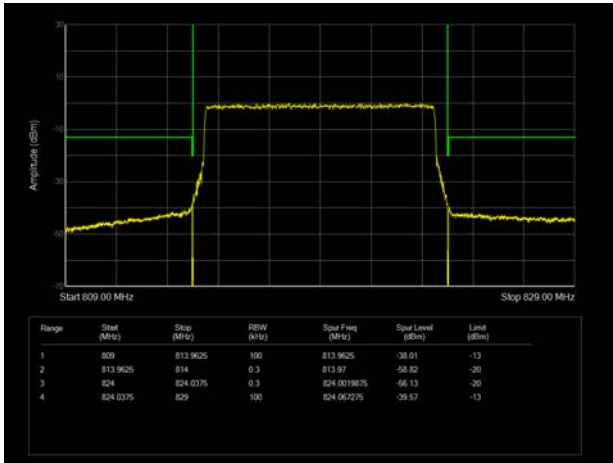

LTE Band 26 16QAM 10MHz CH-High 100%RB

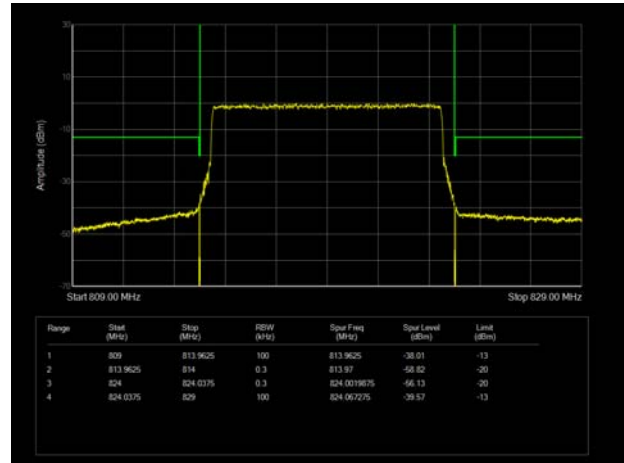

LTE Band 26 64QAM 1.4MHz CH-Low 1RB

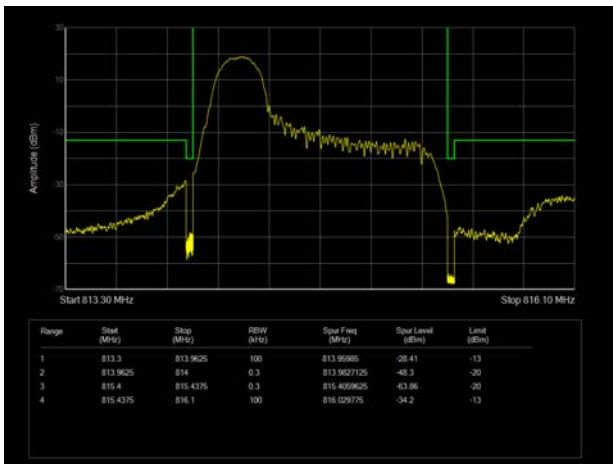

LTE Band 26 64QAM 1.4MHz CH-High 1RB

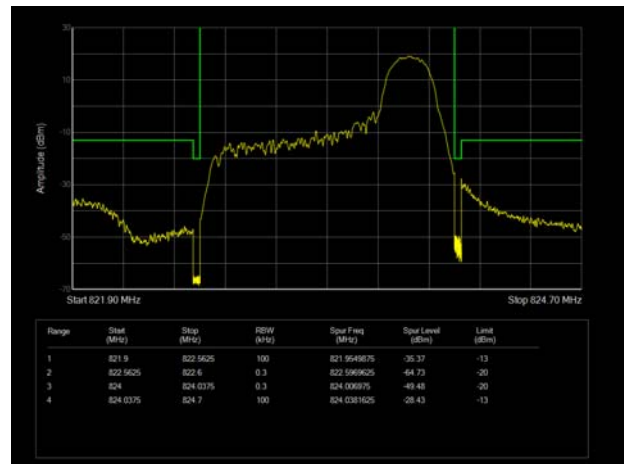

LTE Band 26 64QAM 1.4MHz CH-Low 100%RB

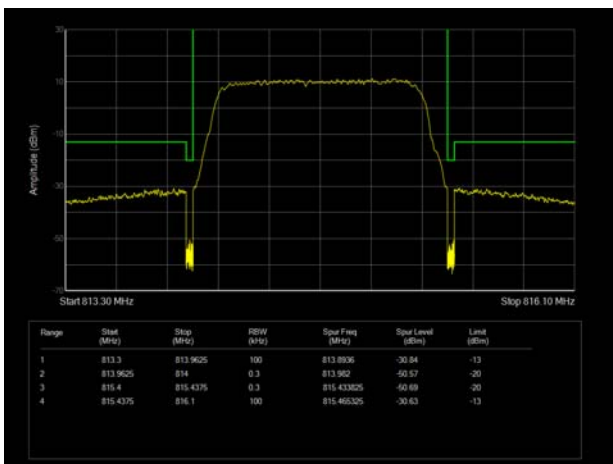

LTE Band 26 64QAM 1.4MHz CH-High 100%RB

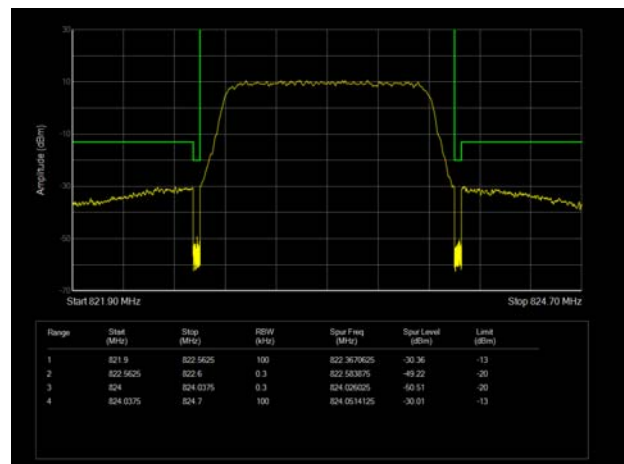

LTE Band 26 64QAM 3MHz CH-Low 1RB

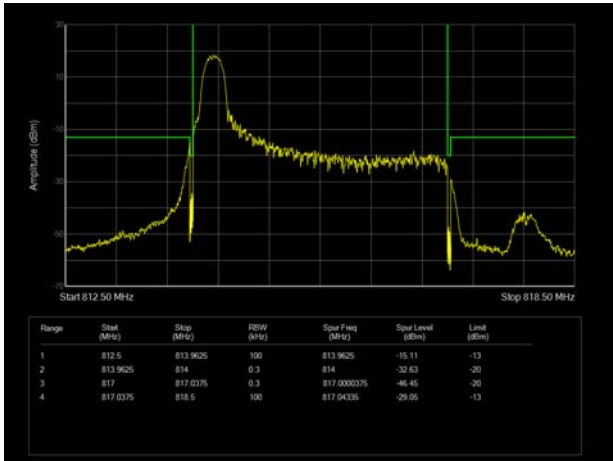

LTE Band 26 64QAM 3MHz CH-High 1RB

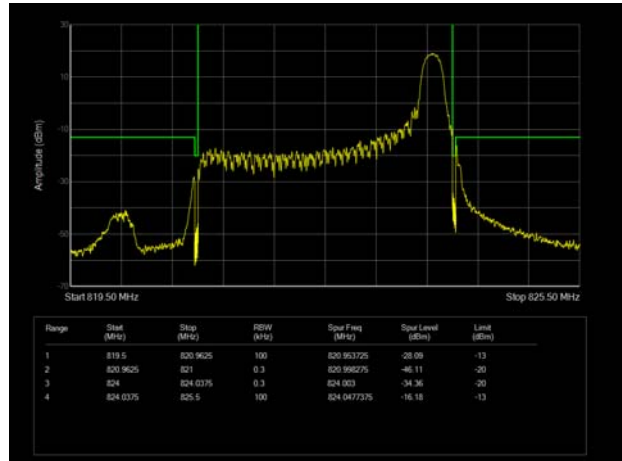

LTE Band 26 64QAM 3MHz CH-Low 100%RB

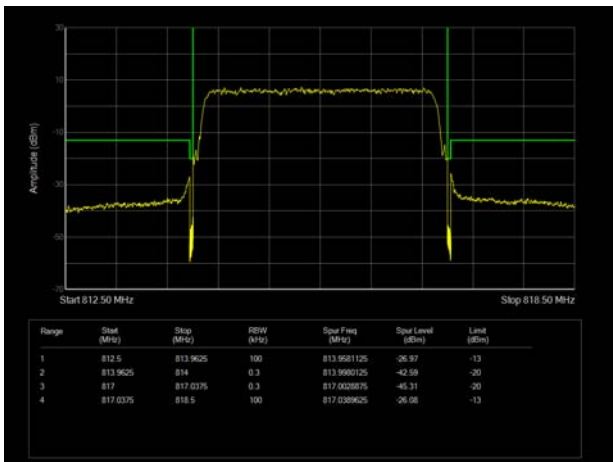

LTE Band 26 64QAM 3MHz CH-High 100%RB

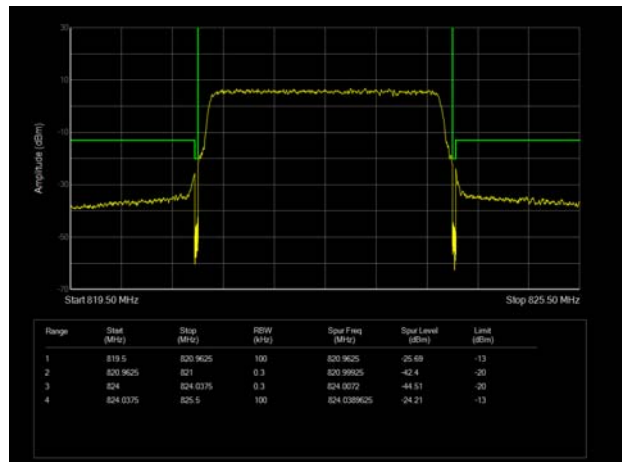

LTE Band 26 64QAM 5MHz CH-Low 1RB

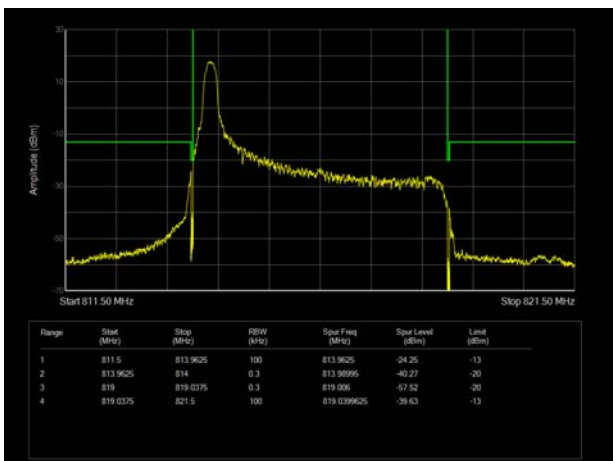

LTE Band 26 64QAM 5MHz CH-High 1RB

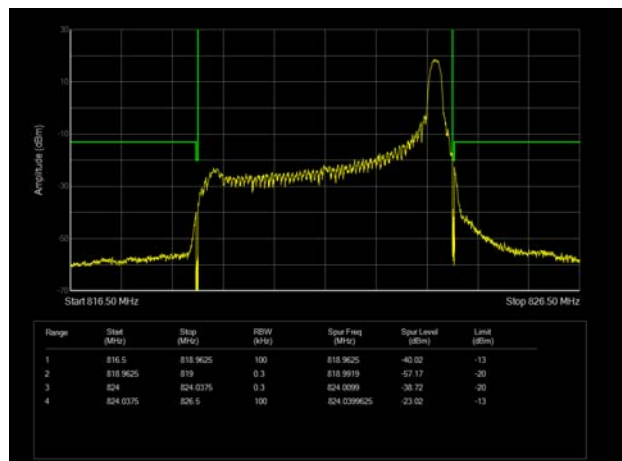

LTE Band 26 64QAM 5MHz CH-Low 100%RB

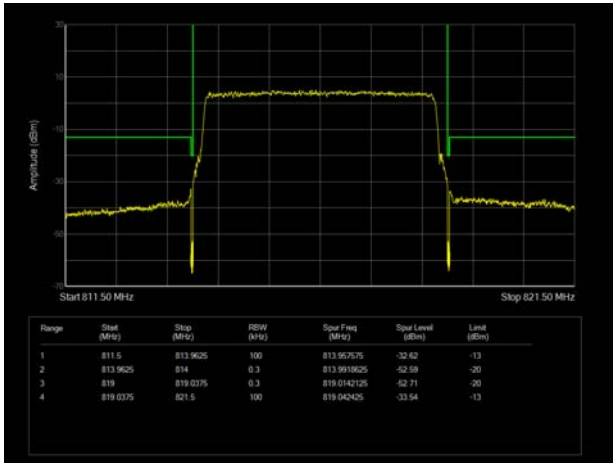

LTE Band 26 64QAM 5MHz CH-High 100%RB

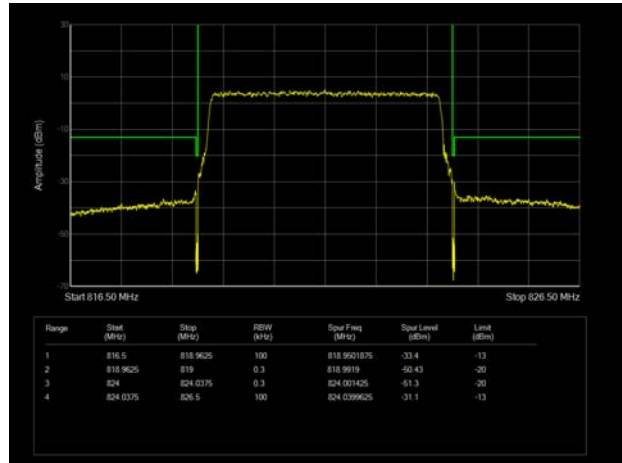

LTE Band 26 64QAM 10MHz CH-Low 1RB

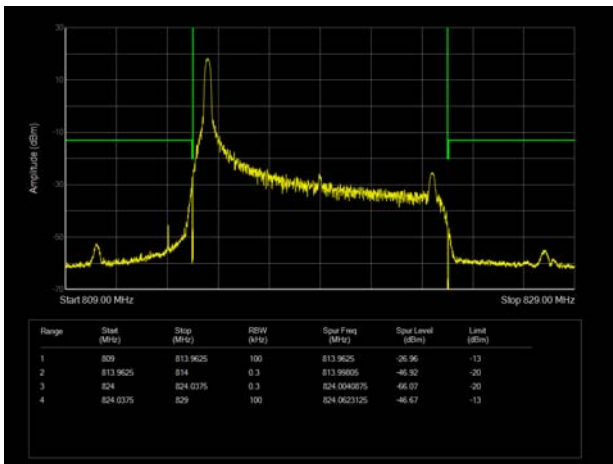

LTE Band 26 64QAM 10MHz CH-High 1RB

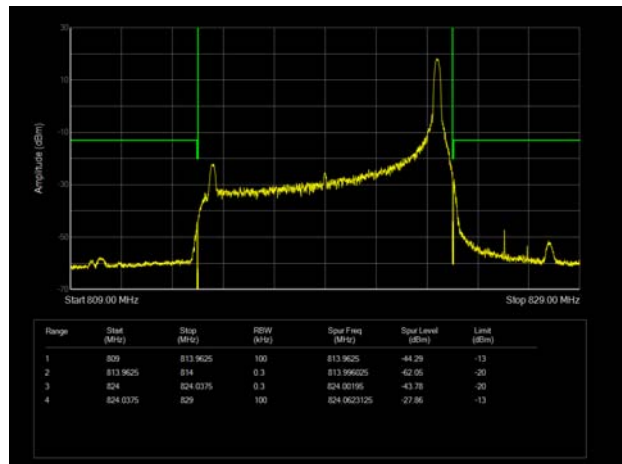

LTE Band 26 64QAM 10MHz CH-Low 100%RB

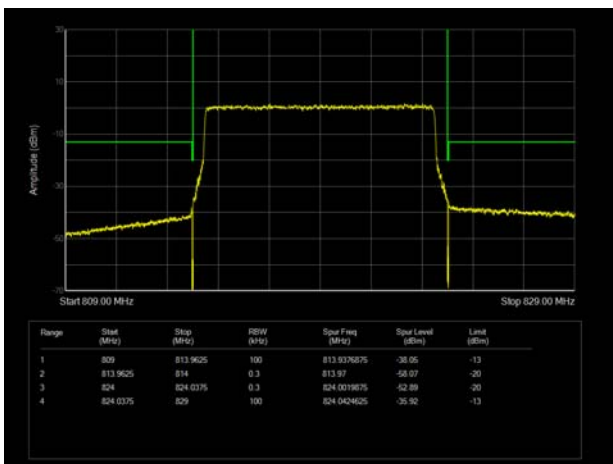

LTE Band 26 64QAM 10MHz CH-High 100%RB

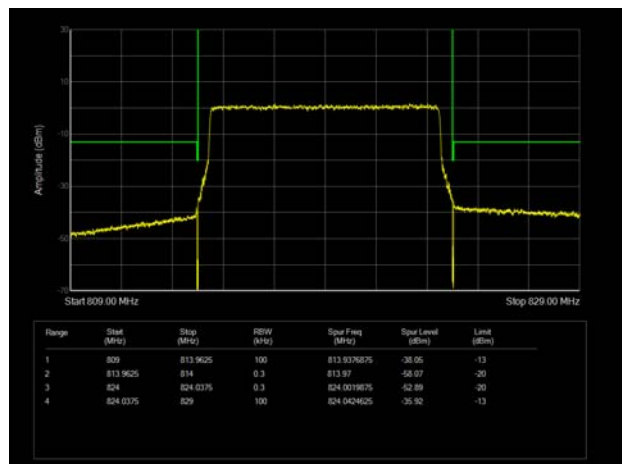

**6.4. Peak-to-Average Power Ratio (PAPR)**

Mode	Channel	Frequency (MHz)	Peak(dBm)	Avg(dBm)	PAPR(dB)	Limit(dB)	Conclusion
1.4 MHz (QPSK)	26697	814.7	26.65	21.04	5.61	13	PASS
	26740	819	26.74	21.09	5.65	13	PASS
	26783	823.3	26.66	21.00	5.66	13	PASS
3 MHz (QPSK)	26697	814.7	26.78	21.09	5.69	13	PASS
	26740	819	26.75	21.11	5.64	13	PASS
	26783	823.3	26.73	21.05	5.68	13	PASS
5 MHz (QPSK)	26697	814.7	26.66	21.06	5.60	13	PASS
	26740	819	26.66	21.02	5.64	13	PASS
	26783	823.3	26.67	21.03	5.64	13	PASS
10 MHz (QPSK)	26740	819	26.79	21.10	5.69	13	PASS

Mode	Channel	Frequency (MHz)	Peak(dBm)	Avg(dBm)	PAPR(dB)	Limit(dB)	Conclusion
1.4 MHz (16QAM)	26697	814.7	26.88	20.69	6.19	13	PASS
	26740	819	26.51	20.14	6.37	13	PASS
	26783	823.3	26.65	20.27	6.38	13	PASS
3 MHz (16QAM)	26697	814.7	26.89	20.53	6.36	13	PASS
	26740	819	26.59	20.19	6.40	13	PASS
	26783	823.3	26.53	20.06	6.47	13	PASS
5 MHz (16QAM)	26697	814.7	26.85	20.62	6.23	13	PASS
	26740	819	26.56	20.17	6.39	13	PASS
	26783	823.3	26.83	20.42	6.41	13	PASS
10 MHz (16QAM)	26740	819	26.54	20.17	6.37	13	PASS

Mode	Channel	Frequency (MHz)	Peak(dBm)	Avg(dBm)	PAPR(dB)	Limit(dB)	Conclusion
1.4 MHz (64QAM)	26697	814.7	26.44	20.29	6.15	13	PASS
	26740	819	26.32	19.87	6.45	13	PASS
	26783	823.3	26.37	20.00	6.37	13	PASS
3 MHz (64QAM)	26697	814.7	26.52	20.19	6.33	13	PASS
	26740	819	26.31	19.89	6.42	13	PASS
	26783	823.3	26.23	19.74	6.49	13	PASS
5 MHz (64QAM)	26697	814.7	26.48	20.22	6.26	13	PASS
	26740	819	26.20	19.85	6.35	13	PASS
	26783	823.3	26.42	20.04	6.38	13	PASS
10 MHz (64QAM)	26740	819	26.26	19.88	6.38	13	PASS

### 6.5. Frequency Stability

LTE Band 26								
Condition		Freq.Error (Hz)	Freq.Error (Hz)	Freq.Error (Hz)	Frequency Stability (ppm)	Frequency Stability (ppm)	Frequency Stability (ppm)	Verdict
BANDWIDTH	1.4MHz							
Temperature	Voltage	64QAM	16QAM	QPSK	64QAM	16QAM	QPSK	
Normal (25°C)	Normal	2.41	5.98	5.23	0.00128	0.00318	0.00278	PASS
Extreme (50°C)		2.11	7.86	8.43	0.00112	0.00418	0.00448	PASS
Extreme (40°C)		10.20	11.98	9.27	0.00542	0.00637	0.00493	PASS
Extreme (30°C)		1.82	12.74	7.03	0.00097	0.00678	0.00374	PASS
Extreme (20°C)		11.44	1.21	6.82	0.00609	0.00064	0.00363	PASS
Extreme (10°C)		2.36	9.35	6.28	0.00125	0.00497	0.00334	PASS
Extreme (0°C)		1.57	4.31	13.48	0.00084	0.00229	0.00717	PASS
Extreme (-10°C)		6.16	11.81	5.91	0.00327	0.00628	0.00315	PASS
Extreme (-20°C)		8.33	14.63	1.94	0.00443	0.00778	0.00103	PASS
Extreme (-30°C)		3.98	9.13	3.82	0.00212	0.00486	0.00203	PASS
25°C	LV	10.97	15.21	8.22	0.00583	0.00809	0.00437	PASS
	HV	17.28	15.82	17.43	0.00919	0.00841	0.00927	PASS
Condition		Freq.Error (Hz)	Freq.Error (Hz)	Freq.Error (Hz)	Frequency Stability (ppm)	Frequency Stability (ppm)	Frequency Stability (ppm)	Verdict
BANDWIDTH	3MHz							
Temperature	Voltage	64QAM	16QAM	QPSK	64QAM	16QAM	QPSK	
Normal (25°C)	Normal	11.37	4.96	14.67	0.00605	0.00264	0.00780	PASS
Extreme (50°C)		11.63	4.80	9.45	0.00618	0.00255	0.00503	PASS
Extreme (40°C)		13.57	10.48	6.65	0.00722	0.00557	0.00354	PASS
Extreme (30°C)		11.00	5.00	3.97	0.00585	0.00266	0.00211	PASS
Extreme (20°C)		15.57	12.07	13.12	0.00828	0.00642	0.00698	PASS
Extreme (10°C)		6.74	15.61	17.88	0.00358	0.00830	0.00951	PASS
Extreme (0°C)		12.53	6.32	3.51	0.00667	0.00336	0.00187	PASS
Extreme (-10°C)		5.61	14.29	5.19	0.00298	0.00760	0.00276	PASS
Extreme (-20°C)		5.50	7.41	2.93	0.00293	0.00394	0.00156	PASS
Extreme (-30°C)		15.82	10.16	5.13	0.00842	0.00540	0.00273	PASS
25°C	LV	7.98	16.19	12.68	0.00424	0.00861	0.00675	PASS
	HV	10.06	10.40	11.40	0.00535	0.00553	0.00607	PASS
Condition		Freq.Error (Hz)	Freq.Error (Hz)	Freq.Error (Hz)	Frequency Stability (ppm)	Frequency Stability (ppm)	Frequency Stability (ppm)	Verdict
BANDWIDTH	5MHz							
Temperature	Voltage	64QAM	16QAM	QPSK	64QAM	16QAM	QPSK	
Normal (25°C)	Normal	3.38	10.24	16.02	0.00180	0.00545	0.00852	PASS
Extreme (50°C)		13.62	6.45	10.10	0.00724	0.00343	0.00537	PASS
Extreme (40°C)		7.38	8.81	14.76	0.00392	0.00469	0.00785	PASS





Extreme (30°C)		2.53	1.10	2.29	0.00135	0.00058	0.00122	PASS
Extreme (20°C)		13.72	9.53	13.96	0.00730	0.00507	0.00743	PASS
Extreme (10°C)		13.31	8.56	7.49	0.00708	0.00456	0.00398	PASS
Extreme (0°C)		4.73	3.05	14.20	0.00252	0.00162	0.00755	PASS
Extreme (-10°C)		8.90	12.08	17.42	0.00473	0.00643	0.00927	PASS
Extreme (-20°C)		14.95	9.25	7.88	0.00795	0.00492	0.00419	PASS
Extreme (-30°C)		7.53	9.18	16.72	0.00401	0.00488	0.00889	PASS
25°C	LV	15.51	3.30	10.85	0.00825	0.00175	0.00577	PASS
	HV	3.79	3.72	13.24	0.00201	0.00198	0.00704	PASS
Condition		Freq.Error (Hz)	Freq.Error (Hz)	Freq.Error (Hz)	Frequency Stability (ppm)	Frequency Stability (ppm)	Frequency Stability (ppm)	Verdict
BANDWIDTH	10MHz							
Temperature	Voltage	64QAM	16QAM	QPSK	64QAM	16QAM	QPSK	
Normal (25°C)	Normal	2.77	1.42	14.87	0.00147	0.00076	0.00791	PASS
Extreme (50°C)		4.46	12.28	5.79	0.00237	0.00653	0.00308	PASS
Extreme (40°C)		16.48	2.56	9.46	0.00876	0.00136	0.00503	PASS
Extreme (30°C)		5.33	16.00	7.00	0.00284	0.00851	0.00372	PASS
Extreme (20°C)		2.16	2.86	7.95	0.00115	0.00152	0.00423	PASS
Extreme (10°C)		15.76	8.22	12.18	0.00838	0.00437	0.00648	PASS
Extreme (0°C)		4.42	9.64	10.67	0.00235	0.00513	0.00568	PASS
Extreme (-10°C)		7.40	8.71	13.08	0.00393	0.00463	0.00696	PASS
Extreme (-20°C)		15.53	14.22	6.19	0.00826	0.00757	0.00329	PASS
Extreme (-30°C)		17.48	15.84	7.33	0.00930	0.00842	0.00390	PASS
25°C	LV	4.02	6.64	7.04	0.00214	0.00353	0.00375	PASS
	HV	16.04	3.48	10.90	0.00853	0.00185	0.00580	PASS

### 6.6. Spurious Emissions at Antenna Terminals

If disturbances were found more than 20dB below limit line, the mark is not required for the EUT. The signal beyond the limit is carrier.

LTE Band 26 1.4MHz CH Low 9KHz~10GHz

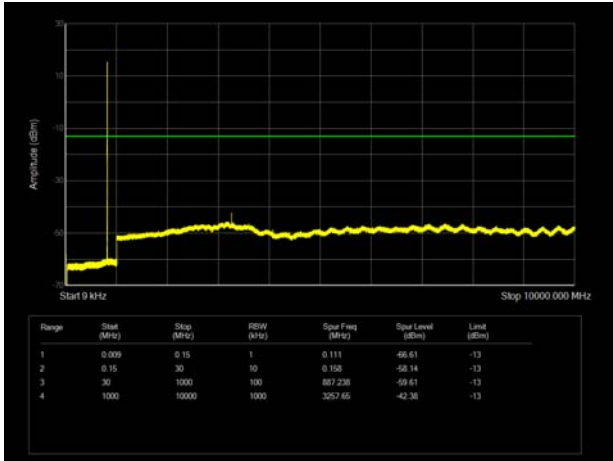

LTE Band 26 3MHz CH Low 9KHz~10GHz

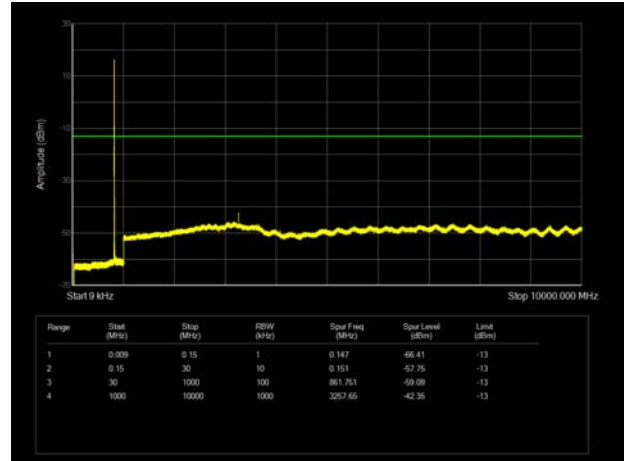

LTE Band 26 1.4MHz CH Middle 9KHz~10GHz

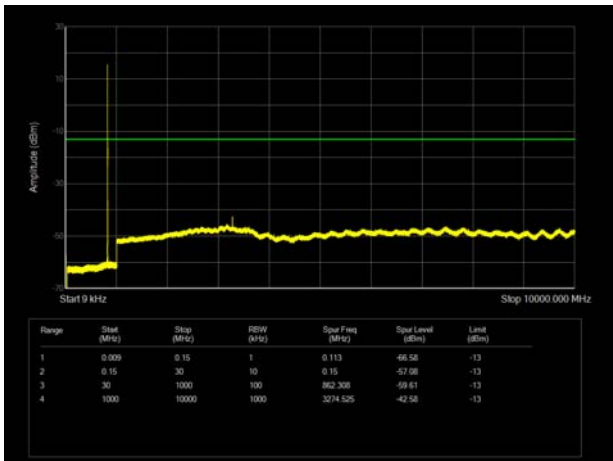

LTE Band 26 3MHz CH Middle 9KHz~10GHz

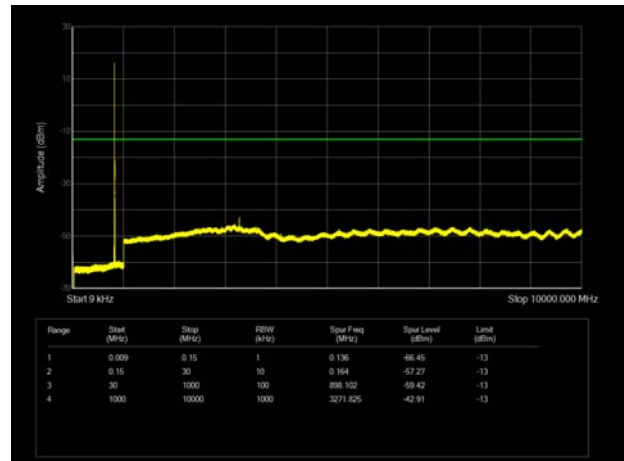

LTE Band 26 1.4MHz CH High 9KHz~10GHz

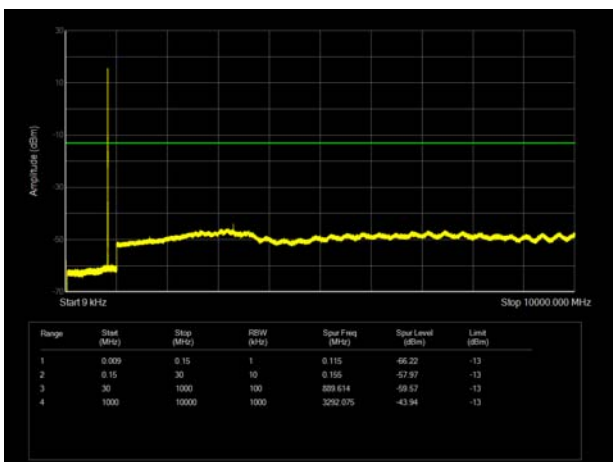

LTE Band 26 3MHz CH High 9KHz~10GHz

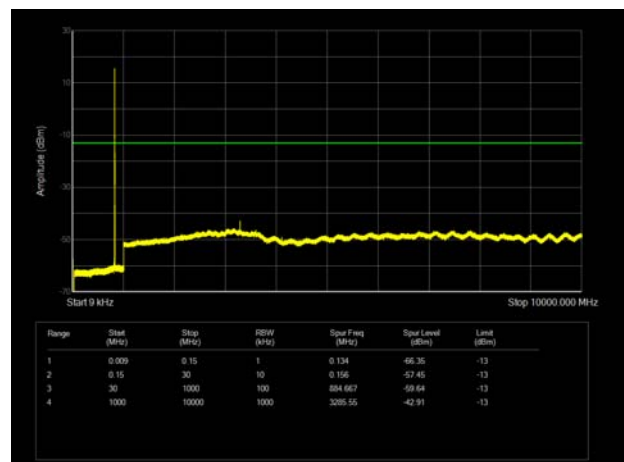



LTE Band 26 5MHz CH Low 9KHz~10GHz

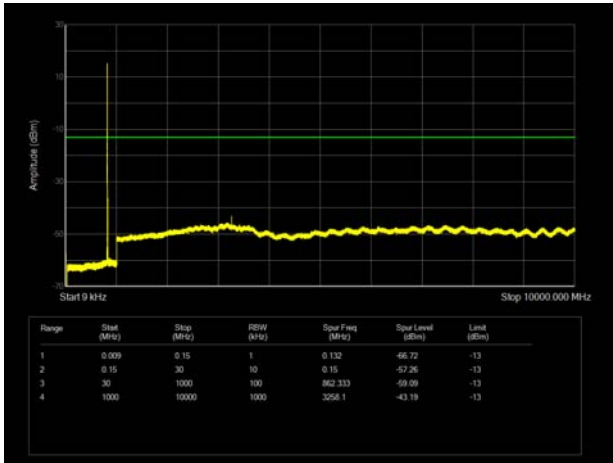

LTE Band 26 5MHz CH Low 9KHz~10GHz

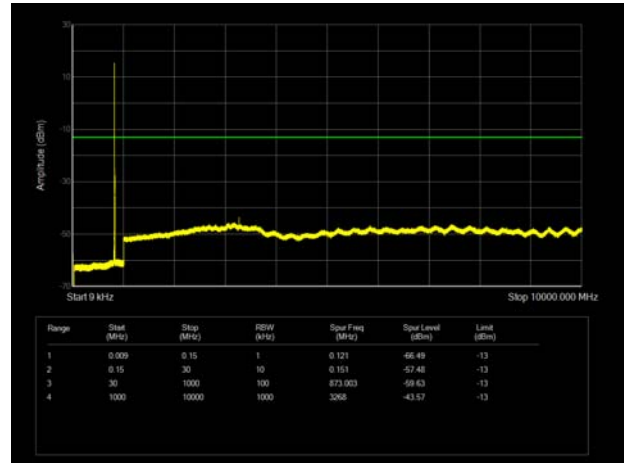

LTE Band 26 5MHz CH Middle 9KHz~10GHz

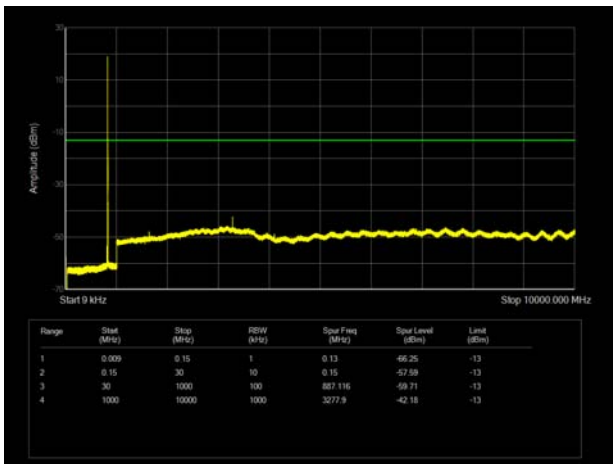

LTE Band 26 10MHz CH Middle 9KHz~10GHz

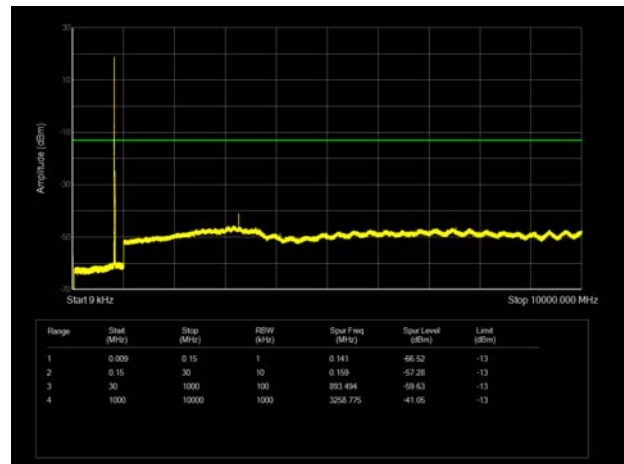

### 6.7. Radiates Spurious Emission

Sweep the whole frequency band through the range from 30MHz to the 10th harmonic of the carrier, the emissions below the noise floor will not be recorded in the report.

LTE Band 26 1.4MHz CH Middle

Harmonic	Frequency (MHz)	SG (dBm)	Cable Loss (dB)	Gain (dBi)	Antenna Polarization	ERP Level (dBm)	Limit (dBm)	Margin (dB)	Azimuth (deg)
2	1636.60	-60.12	1.70	8.70	Horizontal	-55.27	-13.00	42.27	180
3	2454.90	-55.13	2.30	12.00	Horizontal	-47.58	-13.00	34.58	45
4	3273.20	-56.02	2.20	13.10	Horizontal	-47.27	-13.00	34.27	225
5	4091.50	-61.11	3.00	12.50	Horizontal	-53.76	-13.00	40.76	135
6	4909.80	-62.72	3.10	12.50	Horizontal	-55.47	-13.00	42.47	45
7	5728.10	-60.28	3.40	12.50	Horizontal	-53.33	-13.00	40.33	315
8	6546.40	-60.04	3.80	11.50	Horizontal	-54.49	-13.00	41.49	180
9	7364.70	-50.59	4.20	12.20	Horizontal	-44.74	-13.00	31.74	0
10	8183.00	-49.44	4.30	12.30	Horizontal	-43.59	-13.00	30.59	45

Note: 1. The other Spurious RF Radiated emissions level is no more than noise floor.  
 2. The worst emission was found in the antenna is Horizontal position.

LTE Band 26 5MHz CH Middle

Harmonic	Frequency (MHz)	SG (dBm)	Cable Loss (dB)	Gain (dBi)	Antenna Polarization	ERP Level (dBm)	Limit (dBm)	Margin (dB)	Azimuth (deg)
2	1633.00	-60.02	1.70	8.70	Horizontal	-55.17	-13.00	42.17	135
3	2449.50	-51.76	2.30	12.00	Horizontal	-44.21	-13.00	31.21	270
4	3266.00	-52.98	2.20	13.10	Horizontal	-44.23	-13.00	31.23	135
5	4082.50	-61.44	3.00	12.50	Horizontal	-54.09	-13.00	41.09	90
6	4899.00	-63.65	3.10	12.50	Horizontal	-56.40	-13.00	43.40	225
7	5715.50	-61.59	3.40	12.50	Horizontal	-54.64	-13.00	41.64	45
8	6532.00	-58.08	3.80	11.50	Horizontal	-52.53	-13.00	39.53	315
9	7348.50	-49.48	4.20	12.20	Horizontal	-43.63	-13.00	30.63	135
10	8165.00	-49.11	4.30	12.30	Horizontal	-43.26	-13.00	30.26	225

Note: 1. The other Spurious RF Radiated emissions level is no more than noise floor.  
 2. The worst emission was found in the antenna is Horizontal position.



## LTE Band 26 10MHz CH Middle

Harmonic	Frequency (MHz)	SG (dBm)	Cable Loss (dB)	Gain (dBi)	Antenna Polarization	ERP Level (dBm)	Limit (dBm)	Margin (dB)	Azimuth (deg)
2	1628.00	-63.46	1.70	8.70	Horizontal	-58.61	-13.00	45.61	45
3	2442.00	-50.04	2.30	12.00	Horizontal	-42.49	-13.00	29.49	0
4	3256.00	-53.28	2.20	13.10	Horizontal	-44.53	-13.00	31.53	135
5	4070.00	-61.00	3.00	12.50	Horizontal	-53.65	-13.00	40.65	45
6	4884.00	-62.14	3.10	12.50	Horizontal	-54.89	-13.00	41.89	90
7	5698.00	-63.60	3.40	12.50	Horizontal	-56.65	-13.00	43.65	270
8	6512.00	-59.03	3.80	11.50	Horizontal	-53.48	-13.00	40.48	45
9	7326.00	-47.30	4.20	12.20	Horizontal	-41.45	-13.00	28.45	225
10	8140.00	-45.90	4.30	12.30	Horizontal	-40.05	-13.00	27.05	180

Note: 1.The other Spurious RF Radiated emissions level is no more than noise floor.

2.The worst emission was found in the antenna is Horizontal position.



## 7. Main Test Instruments

Name	Manufacturer	Type	Serial Number	Calibration Date	Expiration Date
Climate Chamber	ESPEC	SU-242	93000506	2021-12-12	2022-12-11
Universal Radio Communication Tester	R&S	CMW500	150415	2022-05-14	2023-05-13
Spectrum Analyzer	Keysight	N9020A	MY50510203	2021-12-12	2022-12-11
Universal Radio Communication Tester	Agilent	E5515C	GB44400275	2021-12-12	2022-12-11
Spectrum Analyzer	R&S	FSV3030	101411	2021-12-12	2022-12-11
Spectrum Analyzer	R&S	FSV40	101297	2021-12-12	2022-12-11
Loop antenna	SCHWARZBECK	FMZB1519	1519-047	2020-04-02	2023-04-01
TRILOG Broadband Antenna	Schwarzbeck	VULB 9163	01111	2019-09-12	2022-09-11
Horn Antenna	Schwarzbeck	BBHA 9120D	1594	2020-12-17	2023-12-16
Software	R&S	EMC32	10.35.10	/	/

\*\*\*\*\*END OF REPORT \*\*\*\*\*



## **ANNEX A: The EUT Appearance**

The EUT Appearance is submitted separately.



## **ANNEX B: Test Setup Photos**

The Test Setup Photos is submitted separately.