



RF TEST REPORT

Applicant ZTE Corporation
FCC ID SRQ-A31PLUS3
Product LTE/WCDMA/GSM(GPRS)
Multi-Mode Digital Mobile Phone
Model ZTE Blade A31 Plus
Report No. R2205A0440-R1
Issue Date June 14, 2022

TA Technology (Shanghai) Co., Ltd. tested the above equipment in accordance with the requirements in **FCC CFR47 Part 2 (2021)/ FCC CFR 47 Part 22H (2021)**. The test results show that the equipment tested is capable of demonstrating compliance with the requirements as documented in this report.

Prepared by: Peng Tao

Approved by: Kai Xu

TA Technology (Shanghai) Co., Ltd.

No.145, Jintang Rd, Tangzhen Industry Park, Pudong Shanghai, China

TEL: +86-021-50791141/2/3

FAX: +86-021-50791141/2/3-8000

TABLE OF CONTENT

1. Test Laboratory	4
1.1. Notes of the Test Report	4
1.2. Test facility	4
1.3. Testing Location	4
2. General Description of Equipment under Test.....	5
2.1. Applicant and Manufacturer Information	5
2.2. General Information.....	5
3. Applied Standards.....	7
4. Test Configuration.....	8
5. Test Case Results.....	10
5.1. RF Power Output and Effective Radiated Power	10
5.2. Occupied Bandwidth	15
5.3. Band Edge Compliance.....	27
5.4. Peak-to-Average Power Ratio (PAPR)	38
5.5. Frequency Stability	41
5.6. Spurious Emissions at Antenna Terminals	45
5.7. Radiates Spurious Emission	50
6. Main Test Instruments	56
ANNEX A: The EUT Appearance	57
ANNEX B: Test Setup Photos	58
ANNEX C: Product Change Description (Variant1).....	59
ANNEX D: Product Change Description (Variant2).....	60

Summary of measurement results

No.	Test Case	Clause in FCC rules	Verdict
1	RF Power Output and Effective Radiated Power	2.1046 22.913(a)(5)	PASS
2	Occupied Bandwidth	2.1049	PASS
3	Band Edge Compliance	2.1051 / 22.917(a)	PASS
4	Peak-to-Average Power Ratio	22.913(d)/ KDB 971168 D01(5.7)	PASS
5	Frequency Stability	2.1055 / 22.355	PASS
6	Spurious Emissions at Antenna Terminals	2.1051 / 22.917(a)	PASS
7	Radiates Spurious Emission	2.1053 / 22.917 (a)	PASS
Date of Testing: (Original) August 3, 2021 ~ August 5, 2021 (Variant) November 24, 2021 Date of Sample Received: August 1, 2021			
Note: PASS: The EUT complies with the essential requirements in the standard. FAIL: The EUT does not comply with the essential requirements in the standard. All indications of Pass/Fail in this report are opinions expressed by TA Technology (Shanghai) Co., Ltd. based on interpretations and/or observations of test results. Measurement Uncertainties were not taken into account and are published for informational purposes only.			

ZTE Blade A31 Plus (Report No.: R2205A0440-R1) is a variant model (Variant 2) of ZTE Blade A31 Plus (Report No.: R2110A0943-R1). This report only changed Software Version and changed to single card slot. The power of new variant is varied due to measurement uncertainty, and sample tolerance of the acceptance range. The detailed product change description please refers to the Difference Declaration Letter.

ZTE Blade A31 Plus (Report No.: R2110A0943-R1) is a variant model (Variant 1) of ZTE Blade A31 Plus (Report No.: R2108A0671-R1). This product only added LTE Band 12/17, changed Software Version and changed to dual card slots. This report verified the worst Radiates Spurious Emission of LTE mode (LTE Band 5). The detailed product change description please refers to the Difference Declaration Letter.

1. Test Laboratory

1.1. Notes of the Test Report

This report shall not be reproduced in full or partial, without the written approval of **TA technology (shanghai) co., Ltd.** The results documented in this report apply only to the tested sample, under the conditions and modes of operation as described herein. Measurement Uncertainties were not taken into account and are published for informational purposes only. This report is written to support regulatory compliance of the applicable standards stated above.

1.2. Test facility

FCC (Designation number: CN1179, Test Firm Registration Number: 446626)

TA Technology (Shanghai) Co., Ltd. has been listed on the US Federal Communications Commission list of test facilities recognized to perform measurements.

A2LA (Certificate Number: 3857.01)

TA Technology (Shanghai) Co., Ltd. has been listed by American Association for Laboratory Accreditation to perform measurement.

1.3. Testing Location

Company: TA Technology (Shanghai) Co., Ltd.
Address: No.145, Jintang Rd, Tangzhen Industry Park, Pudong
City: Shanghai
Post code: 201201
Country: P. R. China
Contact: Xu Kai
Telephone: +86-021-50791141/2/3
Fax: +86-021-50791141/2/3-8000
Website: <http://www.ta-shanghai.com>
E-mail: xukai@ta-shanghai.com

2. General Description of Equipment under Test

2.1. Applicant and Manufacturer Information

Applicant	ZTE Corporation
Applicant address	ZTE Plaza, #55 Keji Road South, Hi-Tech Industrial Park, Nanshan District, Shenzhen, China
Manufacturer	ZTE Corporation
Manufacturer address	ZTE Plaza, #55 Keji Road South, Hi-Tech Industrial Park, Nanshan District, Shenzhen, China

2.2. General Information

EUT Description			
Model	ZTE Blade A31 Plus		
IMEI	IMEI 1: 866591060000396 IMEI 2: 866591060001543		
Hardware Version	z1kA		
Software Version	4.0.0_A31Plus_TEL		
Power Supply	Battery / AC adapter		
Antenna Type	Internal Antenna		
Antenna Gain	-3.9dBi		
Test Mode(s)	GSM 850; WCDMA Band V; LTE Band 5;		
Test Modulation	(GSM/GPRS)GMSK, (EGPRS) GMSK/ 8PSK; (WCDMA) BPSK, QPSK, 16QAM; (LTE) QPSK, 16QAM, 64QAM;		
GPRS Multislot Class	12		
EGPRS Multislot Class	12		
HSDPA UE Category	24		
HSUPA UE Category	7		
LTE Category	5		
Maximum E.R.P.	GSM 850:	27.36dBm	
	WCDMA Band V:	17.96dBm	
	LTE Band 5:	16.28dBm	
Rated Power Supply Voltage	3.8V		
Operating Voltage	Minimum: 3.4V Maximum: 4.35V		
Operating Temperature	Lowest: -10°C Highest: +55°C		
Extreme Temperature	Lowest: -30°C Highest: +50°C		
Operating Frequency Range(s)	Band	Tx (MHz)	Rx (MHz)
	GSM850	824 ~ 849	869 ~ 894
	WCDMA Band V	824 ~ 849	869 ~ 894
	LTE Band 5	824 ~ 849	869 ~ 894

EUT Accessory	
Adapter 1	Manufacturer: Shenzhen Ruijing Industrial Co.,Ltd Model: STC-A51D-Z
Adapter 2	Manufacturer: HUIZHOU PUAN ELECTRONICS CO.,LTD Model: STC-A51D-Z
Battery	Manufacturer: Guangdong Fenghua New Energy Co.,Ltd. Model: Li3830T43P8h486375
Earphone 1	Manufacturer: Shenzhen FDC Electronics Co. ,Ltd. Model: DEM-8A
Earphone 2	Manufacturer: JUWEI ELECTRONICS CO., LTD Model: JWEP1091-Z01
USB Cable 1	Manufacturer: Dongguan Guojun Plastic Electronic Co.,Ltd Model: USB-MU5-B-70-M-L
USB Cable 2	Manufacturer: Shenzhen Yihuaxing Electronic Co., Ltd. Model: USB-MU5-B-70-M-L
<p>Note: 1. The EUT is sent from the applicant to TA and the information of the EUT is declared by the applicant.</p> <p>2. There are more than one Adapter, Earphone and USB Cable, each one should be applied throughout the compliance test respectively, however, only the worst case (Adapter 1, Earphone 2 and USB Cable 1) will be recorded in this report.</p>	

3. Applied Standards

According to the specifications of the manufacturer, it must comply with the requirements of the following standards:

Test standards:

FCC CFR 47 Part 22H (2021)

ANSI C63.26 (2015)

Reference standard:

FCC CFR47 Part 2 (2021)

KDB 971168 D01 Power Meas License Digital Systems v03r01

4. Test Configuration

There is more than one SIM card slot, each one should be applied throughout the compliance test respectively, and however, only the worst case (SIM 1) will be recorded in this report.

Radiated measurements are performed by rotating the EUT in three different orthogonal test planes. EUT stand-up position (Z axis), lie-down position (X, Y axis). Receiver antenna polarization (horizontal and vertical), the worst emission was found in position (Z axis, horizontal polarization) and the worst case was recorded.

All mode and data rates and positions and RB size and modulations were investigated.

Subsequently, only the worst case emissions are reported.

The following testing in GSM/WCDMA/LTE is set based on the maximum RF Output Power.

Test modes are chosen to be reported as the worst case configuration below:

Test items	Modes/Modulation	
	GSM 850	WCDMA Band V
RF Power Output and Effective Radiated power	GSM GPRS EGPRS	RMC/ AMR HSDPA/HSUPA DC-HSDPA/HSPA+
Occupied Bandwidth	GSM GPRS(1Tx slot) EGPRS(1Tx slot)	RMC
Band Edge Compliance	GSM GPRS(1Tx slot) EGPRS(1Tx slot)	RMC
Peak-to-Average Power Ratio	GSM GPRS(1Tx slot) EGPRS(1Tx slot)	RMC
Frequency Stability	GSM GPRS(1Tx slot) EGPRS(1Tx slot)	RMC
Spurious Emissions at Antenna Terminals	GSM	RMC
Radiates Spurious Emission	GSM	RMC

Test modes are chosen as the worst case configuration below for LTE Band 5:

Test items	Modes	Bandwidth (MHz)					Modulation		RB			Test Channel		
		1.4	3	5	10	15	QPSK	16QAM/ 64QAM	1	50%	100%	L	M	H
RF power output and Effective Radiated power	LTE 5	O	O	O	O	-	O	O	O	O	O	O	O	O
Occupied Bandwidth	LTE 5	O	O	O	O	-	O	O	-	-	O	O	O	O
Band Edge Compliance	LTE 5	O	O	O	O	-	O	O	O	-	O	O	-	O
Peak-to-Average Power Ratio	LTE 5	O	O	O	O	-	O	O	-	-	O	O	O	O
Frequency Stability	LTE 5	O	O	O	O	-	O	O	O	-	-	-	O	-
Spurious Emissions at Antenna Terminals	LTE 5	O	O	O	O	-	O	-	O	-	-	O	O	O
Radiates Spurious Emission	LTE 5	O	-	O	O	-	O	-	O	-	-	-	O	-
Note	1. The mark "O" means that this configuration is chosen for testing. 2. The mark "-" means that this configuration is not testing.													

5. Test Case Results

5.1. RF Power Output and Effective Radiated Power

Ambient condition

Temperature	Relative humidity	Pressure
23°C ~25°C	45%~50%	101.5kPa

Methods of Measurement

During the process of the testing, The EUT was connected to the Base Station Simulator with a known loss. The EUT is controlled by the Base Station Simulator test set to ensure max power transmission with proper modulation.

ERP can then be calculated as follows:

$$\text{EIRP (dBm)} = \text{Output Power (dBm)} - \text{Losses (dB)} + \text{Antenna Gain (dBi)}$$

where:dBd refers to gain relative to an ideal dipole.

$$\text{EIRP (dBm)} = \text{ERP (dBm)} + 2.15 \text{ (dB)}.$$

Test Setup

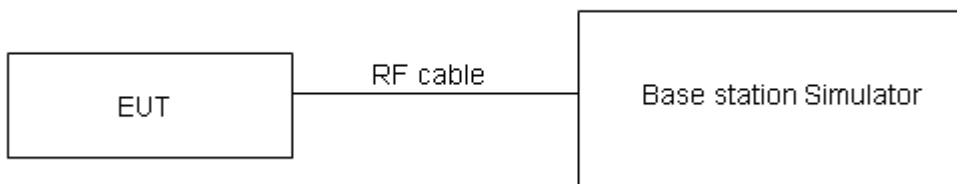

Limits

No specific RF power output requirements in part 2.1046.

Rule Part 22.913(a)(5) specifies that "Mobile/portable stations are limited to 7 watts ERP".

Limit	≤ 7 W (38.45 dBm)
-------	-------------------

Measurement Uncertainty

The assessed measurement uncertainty to ensure 95% confidence level for the normal distribution is with the coverage factor $k = 2$, $U = 0.4 \text{ dB}$ for RF power output, $k = 2$, $U = 1.19 \text{ dB}$ for ERP.

Test Results

GSM 850		Maximum Output Power (dBm)			ERP (dBm)		
		Channel 128	Channel 190	Channel 251	Channel 128	Channel 190	Channel 251
		824.2 (MHz)	836.6 (MHz)	848.8 (MHz)	824.2 (MHz)	836.6 (MHz)	848.8 (MHz)
GSM(GMSK)	Results	33.41	33.38	33.39	27.36	27.33	27.34
GPRS (GMSK)	1TXslot	33.35	33.37	33.37	27.30	27.32	27.32
	2TXslots	31.30	31.23	31.15	25.25	25.18	25.10
	3TXslots	29.34	29.25	29.17	23.29	23.20	23.12
	4TXslots	27.30	27.25	27.14	21.25	21.20	21.09
EGPRS (8PSK)	1TXslot	26.20	26.31	25.82	20.15	20.26	19.77
	2TXslots	24.50	24.70	24.51	18.45	18.65	18.46
	3TXslots	22.70	23.12	23.14	16.65	17.07	17.09
	4TXslots	20.98	21.24	20.84	14.93	15.19	14.79

WCDMA Band V		Maximum Output Power (dBm)			ERP (dBm)		
		Channel 4132	Channel 4183	Channel 4233	Channel 4132	Channel 4183	Channel 4233
		826.4 (MHz)	836.6 (MHz)	846.6 (MHz)	826.4 (MHz)	836.6 (MHz)	846.6 (MHz)
RMC		23.85	23.86	23.89	17.80	17.81	17.84
AMR		23.97	23.76	24.01	17.92	17.71	17.96
HSDPA	Sub - Test 1	23.39	23.44	23.55	17.34	17.39	17.50
	Sub - Test 2	23.31	23.52	23.31	17.26	17.47	17.26
	Sub - Test 3	22.91	22.82	22.95	16.86	16.77	16.90
	Sub - Test 4	22.85	22.78	22.75	16.80	16.73	16.70
HSUPA	Sub - Test 1	23.29	23.48	23.25	17.24	17.43	17.20
	Sub - Test 2	22.51	22.38	22.43	16.46	16.33	16.38
	Sub - Test 3	22.69	22.70	22.97	16.64	16.65	16.92
	Sub - Test 4	22.45	22.28	22.41	16.40	16.23	16.36
	Sub - Test 5	23.31	23.40	23.35	17.26	17.35	17.30
DC-HSDPA	Sub - Test 1	23.49	23.26	23.45	17.44	17.21	17.40
	Sub - Test 2	23.49	23.22	23.37	17.44	17.17	17.32
	Sub - Test 3	22.97	22.90	22.99	16.92	16.85	16.94
	Sub - Test 4	23.01	22.90	22.97	16.96	16.85	16.92
HSPA+	16QAM	22.91	23.02	22.99	16.86	16.97	16.94

LTE Band 5				Maximum Output Power(dBm)			ERP (dBm)		
BW	Modulation	RB size	RB offset	Channel/Frequency(MHz)					
				20407 /824.7	20525 /836.5	20643 /848.3	20407 /824.7	20525 /836.5	20643 /848.3
1.4MHz	QPSK	1	0	22.06	22.27	22.16	16.01	16.22	16.11
		1	2	22.08	22.24	22.17	16.03	16.19	16.12
		1	5	22.04	22.19	22.29	15.99	16.14	16.24
		3	0	22.01	22.18	22.20	15.96	16.13	16.15
		3	2	22.08	22.18	22.05	16.03	16.13	16.00
		3	3	22.11	22.03	22.12	16.06	15.98	16.07
		6	0	21.19	21.18	21.11	15.14	15.13	15.06
	16QAM	1	0	21.68	21.56	21.68	15.63	15.51	15.63
		1	2	21.66	21.68	21.55	15.61	15.63	15.50
		1	5	21.84	21.70	21.75	15.79	15.65	15.70
		3	0	21.56	21.54	21.51	15.51	15.49	15.46
		3	2	21.15	21.05	21.51	15.10	15.00	15.46
		3	3	21.66	21.02	21.03	15.61	14.97	14.98
		6	0	20.31	20.12	20.65	14.26	14.07	14.60
	64QAM	1	0	21.75	21.73	21.81	15.70	15.68	15.76
		1	2	21.27	21.24	21.30	15.22	15.19	15.25
		1	5	21.45	21.48	21.50	15.40	15.43	15.45
		3	0	20.72	20.65	20.70	14.67	14.60	14.65
		3	2	20.82	20.77	20.84	14.77	14.72	14.79
		3	3	20.86	20.83	20.88	14.81	14.78	14.83
		6	0	19.82	19.78	19.86	13.77	13.73	13.81
BW	Modulation	RB size	RB offset	Channel/Frequency(MHz)					
				20415 /825.5	20525 /836.5	20635 /847.5	20415 /825.5	20525 /836.5	20635 /847.5
3MHz	QPSK	1	0	22.08	22.31	22.19	16.03	16.26	16.14
		1	7	22.06	22.27	22.21	16.01	16.22	16.16
		1	14	22.07	22.24	22.33	16.02	16.19	16.28
		8	0	21.10	21.30	21.33	15.05	15.25	15.28
		8	4	21.20	21.28	21.17	15.15	15.23	15.12
		8	7	21.21	21.14	21.22	15.16	15.09	15.17
		15	0	21.19	21.22	21.14	15.14	15.17	15.09
	16QAM	1	0	21.71	21.58	21.71	15.66	15.53	15.66
		1	7	21.69	21.68	21.59	15.64	15.63	15.54

		1	14	21.86	21.74	21.78	15.81	15.69	15.73	
		8	0	20.67	20.67	20.63	14.62	14.62	14.58	
		8	4	20.26	20.18	20.63	14.21	14.13	14.58	
		8	7	20.76	20.12	20.16	14.71	14.07	14.11	
		15	0	20.34	20.16	20.68	14.29	14.11	14.63	
	64QAM	1	0	21.78	21.75	21.84	15.73	15.70	15.79	
		1	7	21.30	21.24	21.32	15.25	15.19	15.27	
		1	14	21.47	21.47	21.53	15.42	15.42	15.48	
		8	0	19.83	19.78	19.82	13.78	13.73	13.77	
		8	4	19.93	19.90	19.96	13.88	13.85	13.91	
		8	7	19.96	19.95	20.01	13.91	13.90	13.96	
		15	0	19.85	19.82	19.89	13.80	13.77	13.84	
	BW	Modulation	RB size	RB offset	Channel/Frequency(MHz)					
					20425 /826.5	20525 /836.5	20625 /846.5	20425 /826.5	20525 /836.5	20625 /846.5
5MHz	QPSK	1	0	22.06	22.26	22.16	16.01	16.21	16.11	
		1	13	22.05	22.27	22.19	16.00	16.22	16.14	
		1	24	22.03	22.18	22.28	15.98	16.13	16.23	
		12	0	21.08	21.26	21.30	15.03	15.21	15.25	
		12	6	21.18	21.24	21.12	15.13	15.19	15.07	
		12	13	21.18	21.13	21.19	15.13	15.08	15.14	
		25	0	21.21	21.19	21.11	15.16	15.14	15.06	
	16QAM	1	0	21.65	21.55	21.68	15.60	15.50	15.63	
		1	13	21.67	21.67	21.57	15.62	15.62	15.52	
		1	24	21.83	21.70	21.74	15.78	15.65	15.69	
		12	0	20.65	20.66	20.61	14.60	14.61	14.56	
		12	6	20.22	20.12	20.58	14.17	14.07	14.53	
		12	13	20.74	20.08	20.13	14.69	14.03	14.08	
		25	0	20.32	20.12	20.63	14.27	14.07	14.58	
	64QAM	1	0	21.72	21.72	21.81	15.67	15.67	15.76	
		1	13	21.28	21.23	21.30	15.23	15.18	15.25	
		1	24	21.48	21.46	21.53	15.43	15.41	15.48	
		12	0	19.83	19.81	19.84	13.78	13.76	13.79	
		12	6	19.90	19.86	19.94	13.85	13.81	13.89	
		12	13	19.94	19.91	19.98	13.89	13.86	13.93	
		25	0	19.83	19.78	19.84	13.78	13.73	13.79	

BW	Modulation	RB size	RB offset	Channel/Frequency(MHz)					
				20450 /829	20525 /836.5	20600 /844	20450 /829	20525 /836.5	20600 /844
10MHz	QPSK	1	0	22.03	22.22	22.13	15.98	16.17	16.08
		1	25	22.04	22.23	22.17	15.99	16.18	16.12
		1	49	22.01	22.17	22.25	15.96	16.12	16.20
		25	0	21.05	21.21	21.26	15.00	15.16	15.21
		25	13	21.16	21.20	21.09	15.11	15.15	15.04
		25	25	21.15	21.08	21.15	15.10	15.03	15.10
		50	0	21.18	21.14	21.07	15.13	15.09	15.02
	16QAM	1	0	21.68	21.51	21.63	15.63	15.46	15.58
		1	25	21.63	21.65	21.53	15.58	15.60	15.48
		1	49	21.81	21.67	21.72	15.76	15.62	15.67
		25	0	20.62	20.62	20.58	14.57	14.57	14.53
		25	13	20.19	20.10	20.55	14.14	14.05	14.50
		25	25	20.71	20.03	20.09	14.66	13.98	14.04
		50	0	20.30	20.08	20.60	14.25	14.03	14.55
	64QAM	1	0	21.70	21.68	21.76	15.65	15.63	15.71
		1	25	21.24	21.21	21.26	15.19	15.16	15.21
		1	49	21.42	21.40	21.47	15.37	15.35	15.42
		25	0	19.78	19.73	19.77	13.73	13.68	13.72
		25	13	19.86	19.82	19.88	13.81	13.77	13.83
		25	25	19.91	19.86	19.94	13.86	13.81	13.89
		50	0	19.81	19.74	19.81	13.76	13.69	13.76

5.2. Occupied Bandwidth

Ambient condition

Temperature	Relative humidity	Pressure
23°C ~25°C	45%~50%	101.5kPa

Method of Measurement

The EUT was connected to Spectrum Analyzer and Base Station Simulator via power Splitter. The occupied bandwidth is measured using spectrum analyzer.

RBW is set to 6.2kHz, VBW is set to 20kHz for GSM 850,
 RBW is set to 51kHz, VBW is set to 160kHz for WCDMA Band V,
 RBW is set to 30 kHz, VBW is set to 91kHz for LTE Band 5 (1.4MHz),
 RBW is set to 62 kHz, VBW is set to 180kHz for LTE Band 5 (3MHz),
 RBW is set to 100 kHz, VBW is set to 300kHz for LTE Band 5 (5MHz),
 RBW is set to 200 kHz, VBW is set to 620kHz for LTE Band 5 (10MHz),

99% power and -26dBc occupied bandwidths are recorded. Spectrum analyzer plots are included on the following pages.

Test Setup

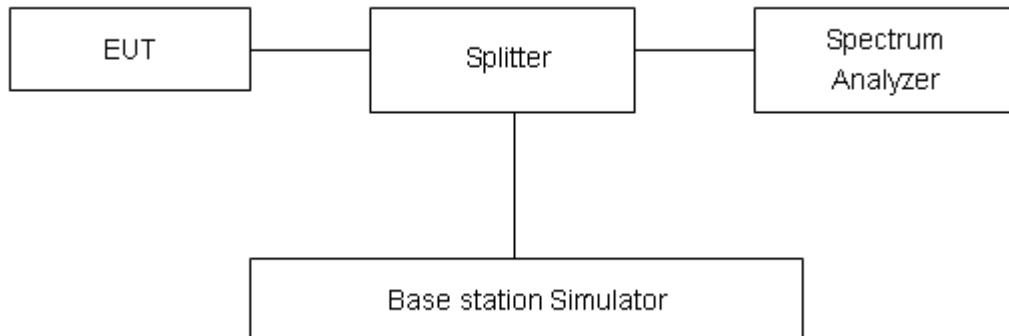

Limits

No specific occupied bandwidth requirements in part 2.1049.

Measurement Uncertainty

The assessed measurement uncertainty to ensure 95% confidence level for the normal distribution is with the coverage factor $k = 2$, $U = 624\text{Hz}$.

Test Result

Mode	Channel	Frequency (MHz)	99% Power Bandwidth (MHz)	-26dBc Bandwidth(MHz)
GSM 850 (GMSK)	128	824.2	0.242	0.305
	190	836.6	0.243	0.310
	251	848.8	0.243	0.307
GPRS 850 (GMSK)	128	824.2	0.246	0.314
	190	836.6	0.243	0.314
	251	848.8	0.246	0.316
EGPRS 850 (8PSK)	128	824.2	0.246	0.309
	190	836.6	0.241	0.315
	251	848.8	0.243	0.307
WCDMA Band V (RMC)	4132	826.4	4.154	4.666
	4183	836.6	4.153	4.644
	4233	846.6	4.154	4.630

LTE Band 5						
RB	Modulation	Bandwidth (MHz)	Channel	Frequency (MHz)	99% Power Bandwidth(MHz)	-26dBc Bandwidth(MHz)
100%	QPSK	1.4	20407	824.7	1.098	1.237
			20525	836.5	1.100	1.248
			20643	848.3	1.096	1.241
		3	20415	825.5	2.718	3.032
			20525	836.5	2.718	3.061
			20635	847.5	2.713	3.051
		5	20425	826.5	4.516	4.981
			20525	836.5	4.527	4.993
			20625	846.5	4.509	4.897
		10	20450	829	8.986	9.845
			20525	836.5	8.964	9.843
			20600	844	8.970	9.799
	16QAM	1.4	20407	824.7	1.100	1.234
			20525	836.5	1.094	1.249
			20643	848.3	1.106	1.246
		3	20415	825.5	2.701	3.046
			20525	836.5	2.703	3.023
			20635	847.5	2.707	3.049
		5	20425	826.5	4.528	4.950
			20525	836.5	4.516	4.971
			20625	846.5	4.543	4.958
		10	20450	829	9.018	9.788
			20525	836.5	9.011	9.792
			20600	844	8.980	9.875
	64QAM	1.4	20407	824.7	1.108	1.253
			20525	836.5	1.098	1.248
			20643	848.3	1.097	1.245
		3	20415	825.5	2.693	3.028
			20525	836.5	2.715	3.030
			20635	847.5	2.727	3.057
5		20425	826.5	4.510	4.947	
		20525	836.5	4.519	4.955	

			20625	846.5	4.522	5.003
		10	20450	829	8.994	9.879
			20525	836.5	8.962	9.662
			20600	844	8.964	9.793

GSM 850 CH-Low



GSM 850 GPRS CH-Low



GSM 850 CH-Middle



GSM 850 GPRS CH-Middle

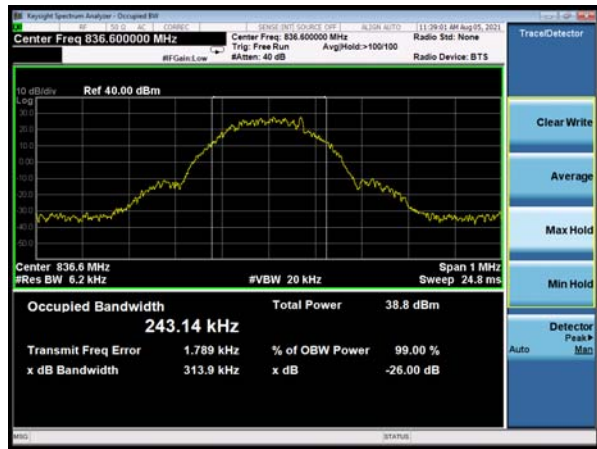

GSM 850 CH-High



GSM 850 GPRS CH-High



GSM 850 EGPRS CH-Low

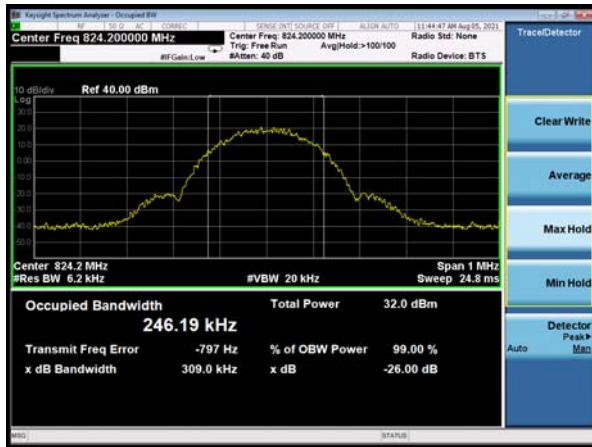

WCDMA Band V CH-Low



GSM 850 EGPRS CH-Middle

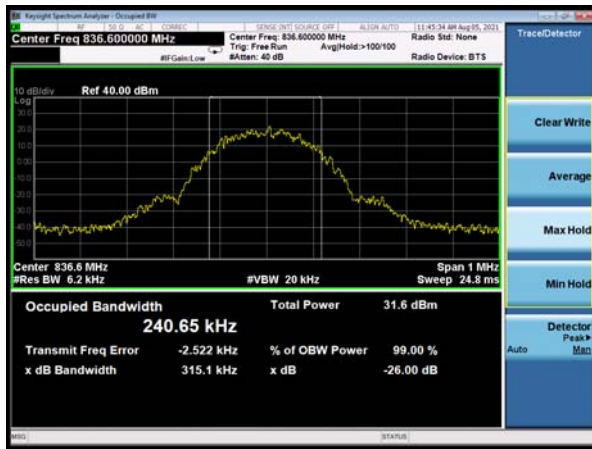

WCDMA Band V CH-Middle



GSM 850 EGPRS CH-High

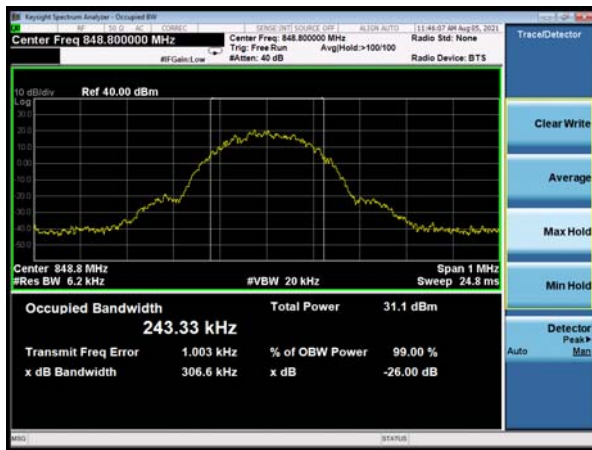

WCDMA Band V CH-High



LTE Band 5 QPSK 1.4MHz CH-Low



LTE Band 5 QPSK 3MHz CH-Low



LTE Band 5 QPSK 1.4MHz CH-Middle

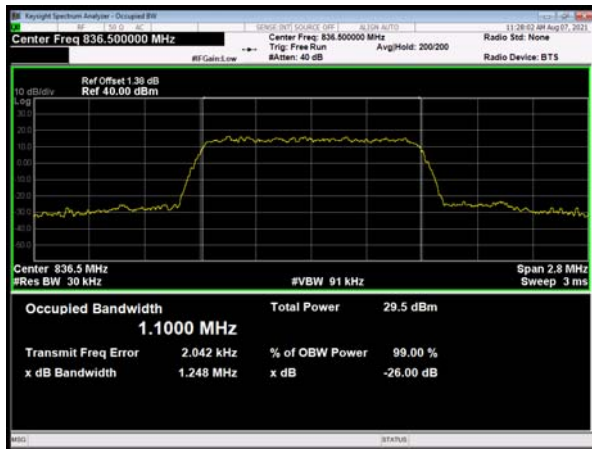

LTE Band 5 QPSK 3MHz CH-Middle



LTE Band 5 QPSK 1.4MHz CH-High

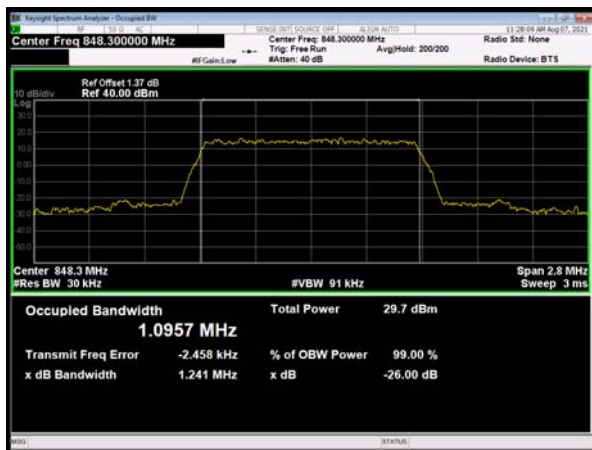

LTE Band 5 QPSK 3MHz CH-High

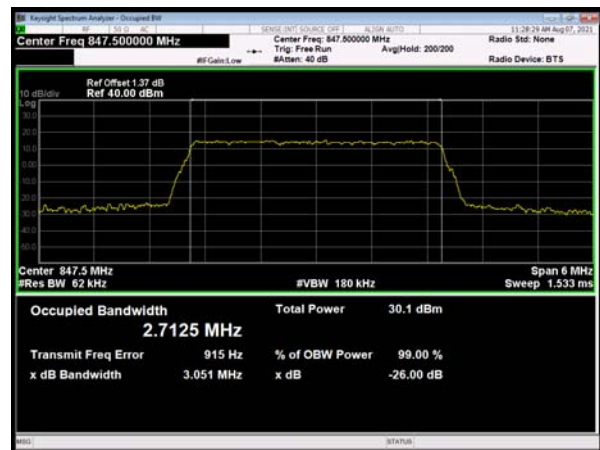

LTE Band 5 QPSK 5MHz CH-Low



LTE Band 5 QPSK 10MHz CH-Low



LTE Band 5 QPSK 5MHz CH-Middle

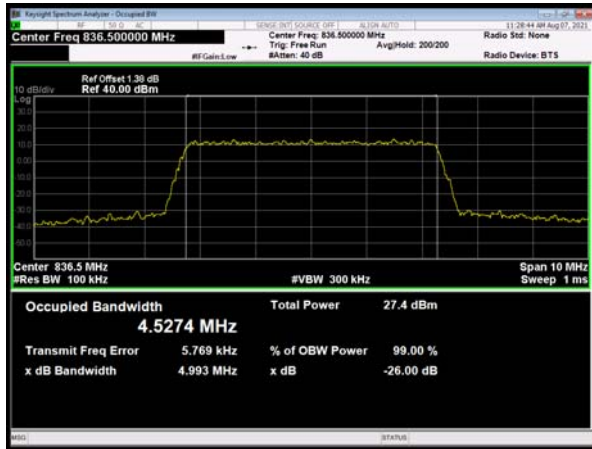

LTE Band 5 QPSK 10MHz CH-Middle



LTE Band 5 QPSK 5MHz CH-High



LTE Band 5 QPSK 10MHz CH-High



LTE Band 5 16QAM 1.4MHz CH-Low



LTE Band 5 16QAM 3MHz CH-Low



LTE Band 5 16QAM 1.4MHz CH-Middle



LTE Band 5 16QAM 3MHz CH-Middle

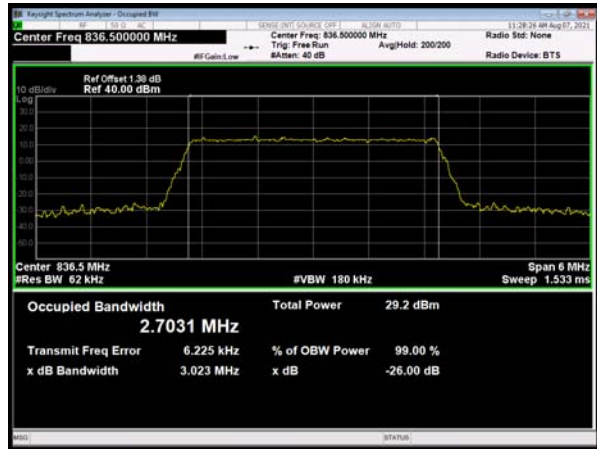

LTE Band 5 16QAM 1.4MHz CH-High

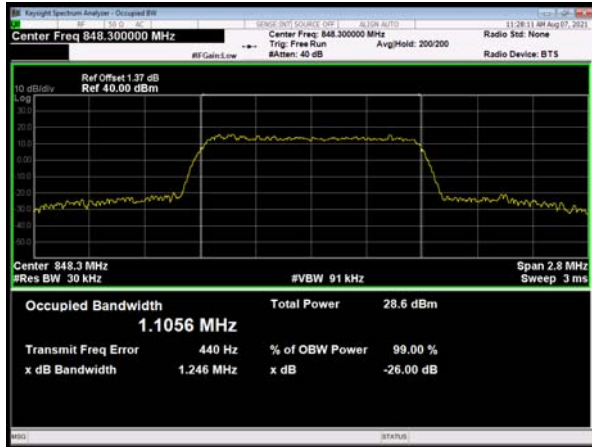

LTE Band 5 16QAM 3MHz CH-High

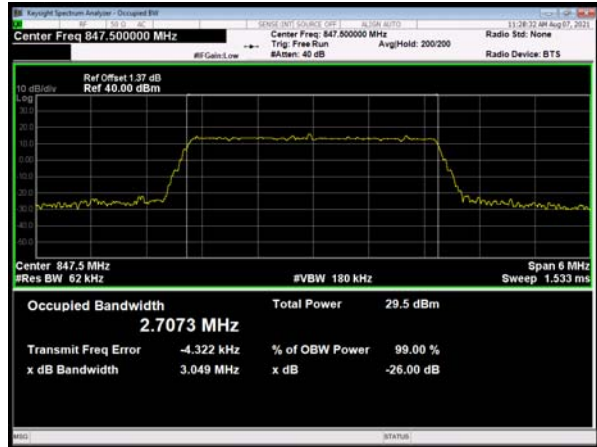

LTE Band 5 16QAM 5MHz CH-Low

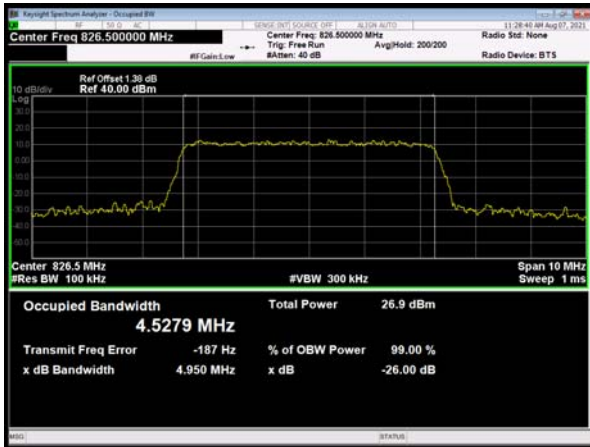

LTE Band 5 16QAM 10MHz CH-Low



LTE Band 5 16QAM 5MHz CH-Middle



LTE Band 5 16QAM 10MHz CH-Middle

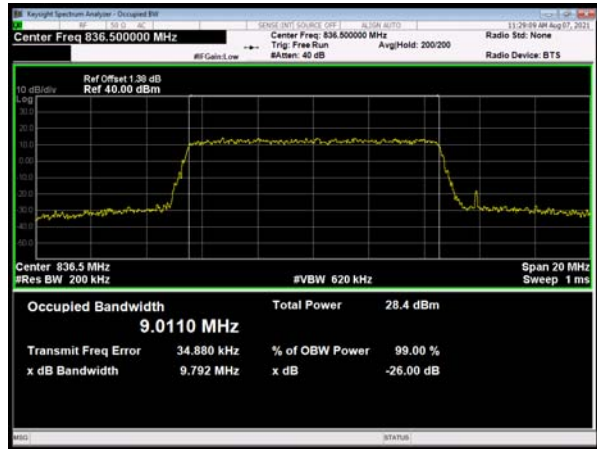

LTE Band 5 16QAM 5MHz CH-High

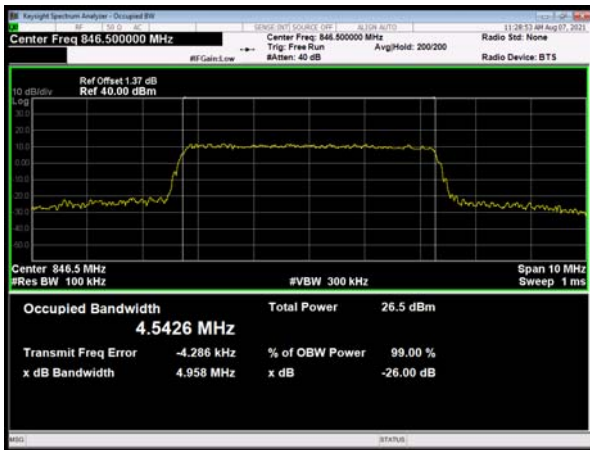

LTE Band 5 16QAM 10MHz CH-High



LTE Band 5 64QAM 1.4MHz CH-Low

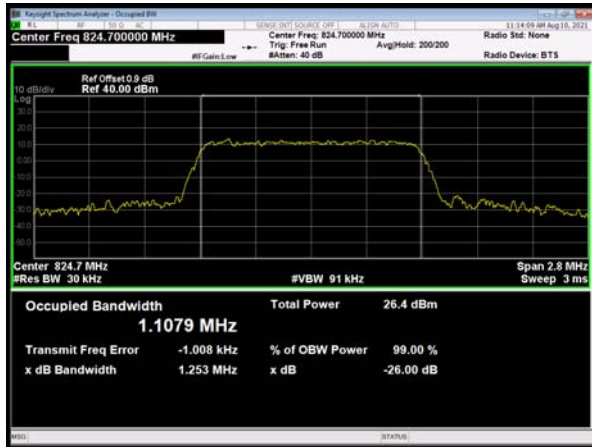

LTE Band 5 64QAM 3MHz CH-Low

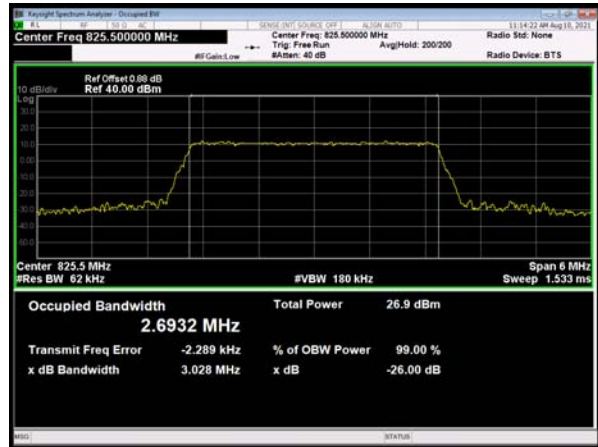

LTE Band 5 64QAM 1.4MHz CH-Middle



LTE Band 5 64QAM 3MHz CH-Middle

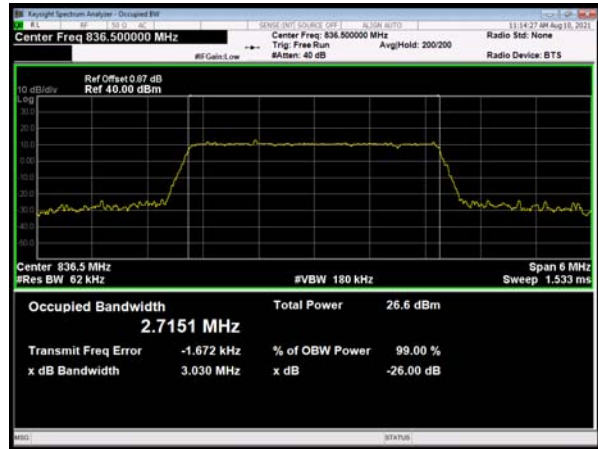

LTE Band 5 64QAM 1.4MHz CH-High



LTE Band 5 64QAM 3MHz CH-High

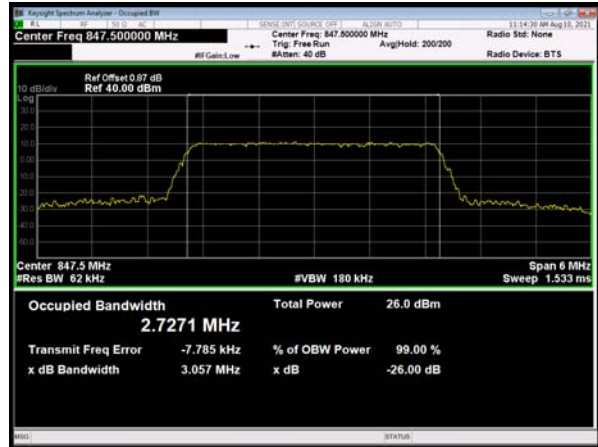

LTE Band 5 64QAM 5MHz CH-Low



LTE Band5 64QAM 10MHz CH-Low



LTE Band5 64QAM 5MHz CH-Middle



LTE Band 5 64QAM 10MHz CH-Middle



LTE Band 5 64QAM 5MHz CH-High

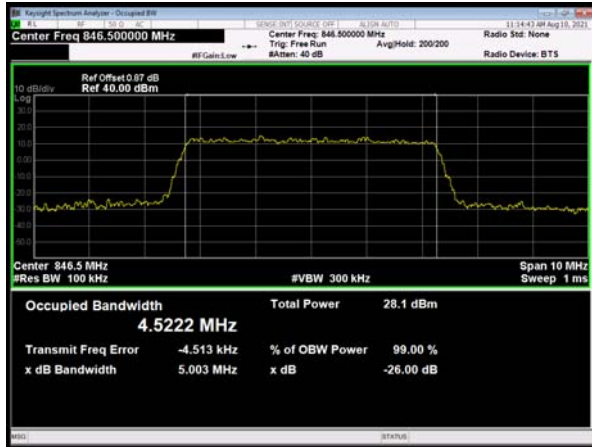

LTE Band 5 64QAM 10MHz CH-High



5.3. Band Edge Compliance

Ambient condition

Temperature	Relative humidity	Pressure
23°C ~25°C	45%~50%	101.5kPa

Method of Measurement

The EUT was connected to Spectrum Analyzer and Base Station Simulator via power Splitter. The band edge of the lowest and highest channels were measured. The average detector is used.

RBW is set to 6.2kHz,VBW is set to 20kHz for GSM 850,

RBW is set to 51kHz,VBW is set to 160kHz for WCDMA Band V,

RBW is set to 15kHz, VBW is set to 43kHz for LTE Band 5 (1.4MHz),

RBW is set to 33kHz,VBW is set to 100kHz for LTE Band 5 (3MHz),

RBW is set to 51kHz,VBW is set to 150kHz for LTE Band 5 (5MHz),

RBW is set to 100kHz,VBW is set to 300kHz for LTE Band 5 (10MHz),

Spectrum analyzer plots are included on the following pages.

Test Setup

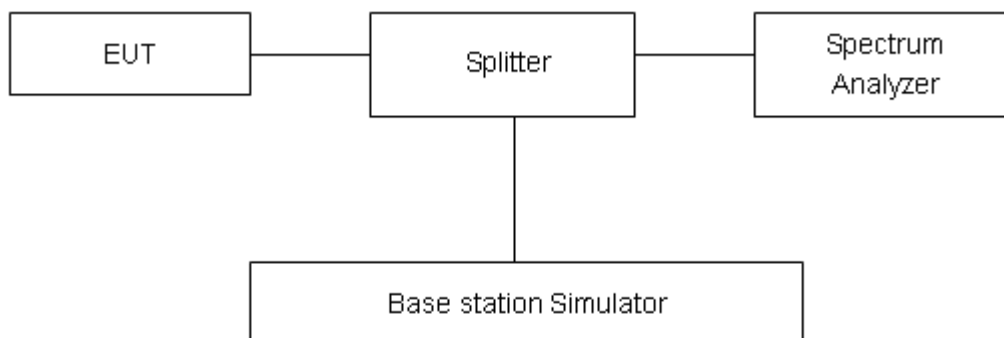

Limits

Rule Part 22.917(a) specifies that “The power of any emission outside of the authorized operating frequency ranges must be attenuated below the transmitting power (P) by a factor of at least $43 + 10 \log(P)$ dB.”

Limit	-13 dBm
-------	---------

Measurement Uncertainty

The assessed measurement uncertainty to ensure 95% confidence level for the normal distribution is with the coverage factor $k = 1.96$, $U=0.684$ dB.

Test Result:

GSM 850 CH-Low



GSM 850 CH-High



GSM 850 GPRS CH-Low



GSM 850 GPRS CH-High

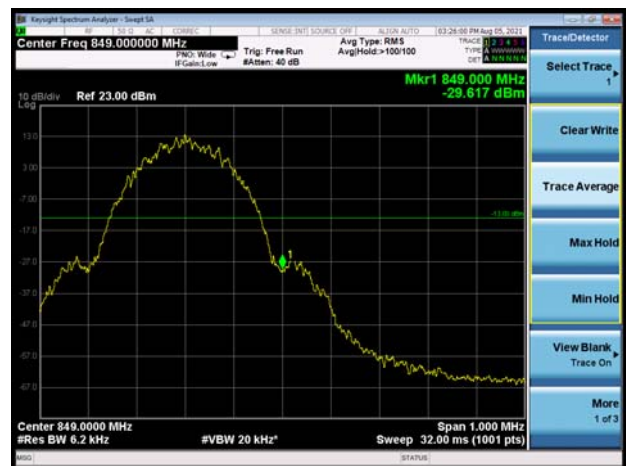

GSM 850 EGPRS CH-Low

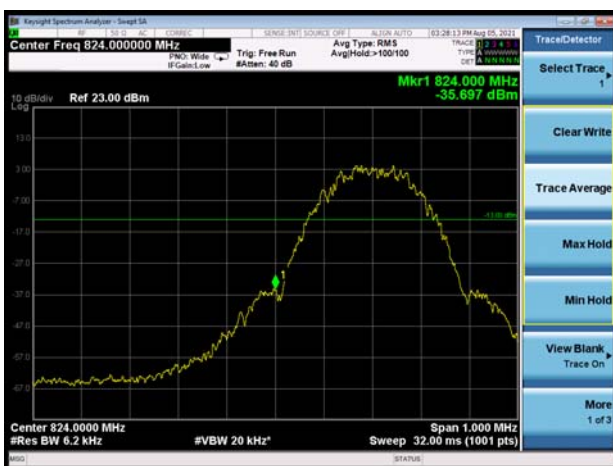

GSM 850 EGPRS CH-High



WCDMA Band V CH-Low



WCDMA Band V CH-High



LTE Band 5 QPSK 1.4MHz CH-Low 1RB

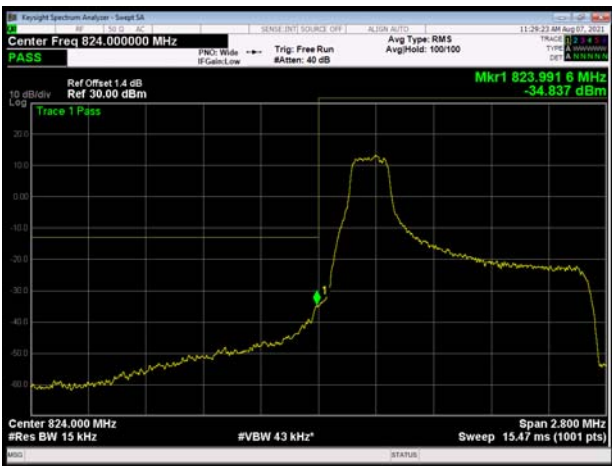

LTE Band 5 QPSK 1.4MHz CH-High 1RB

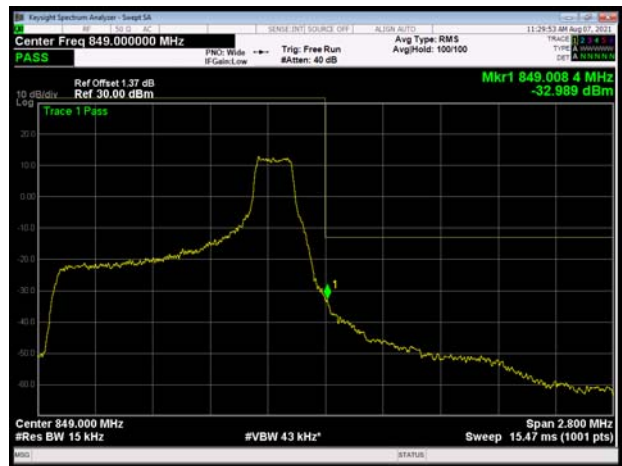

LTE Band 5 QPSK 1.4MHz CH-Low 100%RB

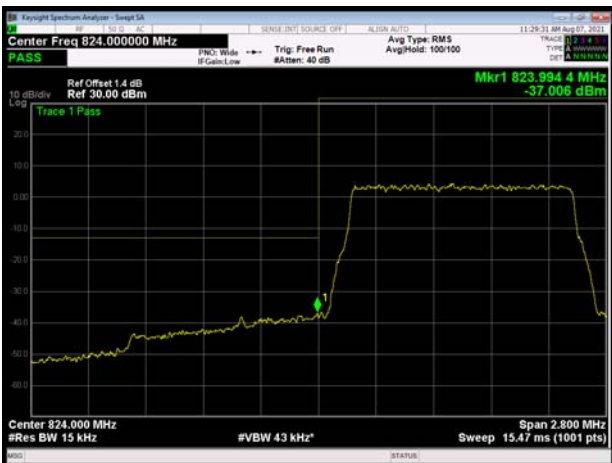

LTE Band 5 QPSK 1.4MHz CH-High 100%RB



LTE Band 5 QPSK 3MHz CH-Low 1RB

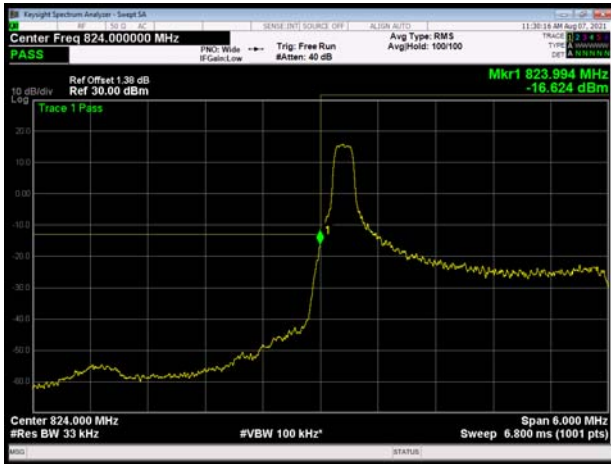

LTE Band 5 QPSK 3MHz CH-High 1RB

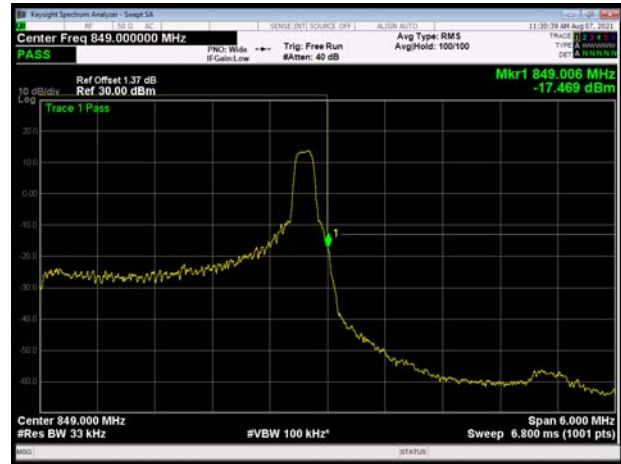

LTE Band 5 QPSK 3MHz CH-Low 100%RB

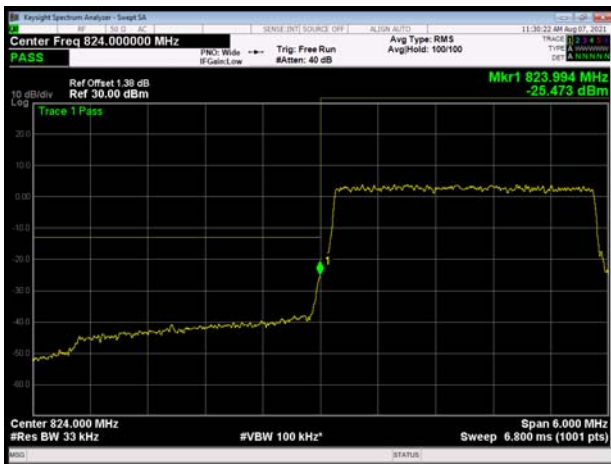

LTE Band 5 QPSK 3MHz CH-High 100%RB

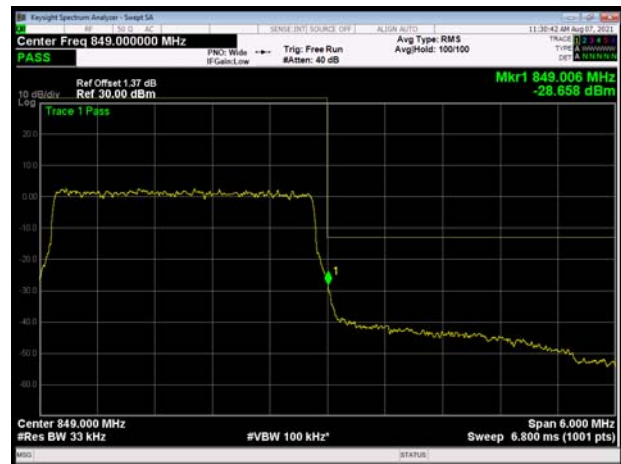

LTE Band 5 QPSK 5MHz CH-Low 1RB

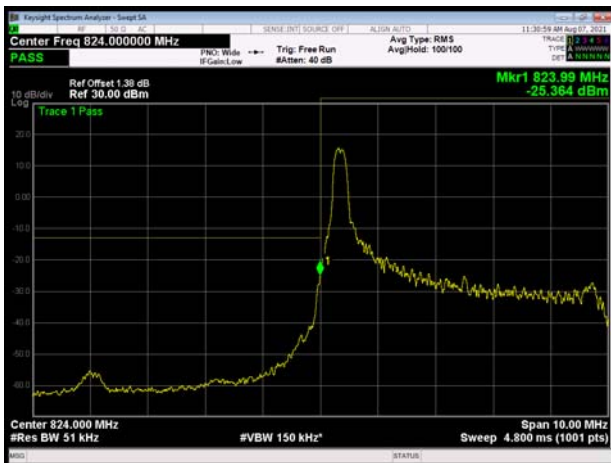

LTE Band 5 QPSK 5MHz CH-High 1RB

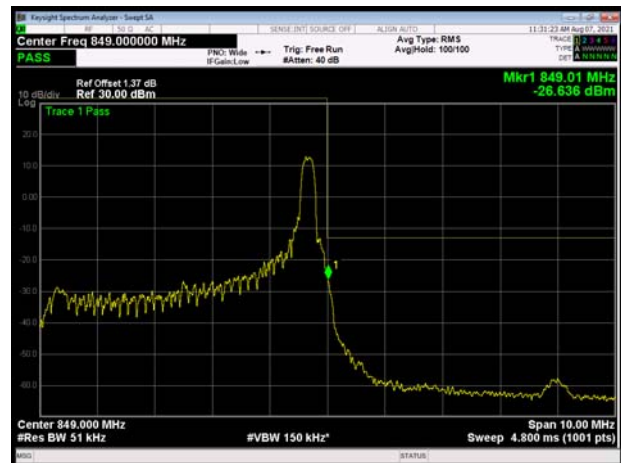

LTE Band 5 QPSK 5MHz CH-Low 100%RB

LTE Band 5 QPSK 5MHz CH-High 100%RB

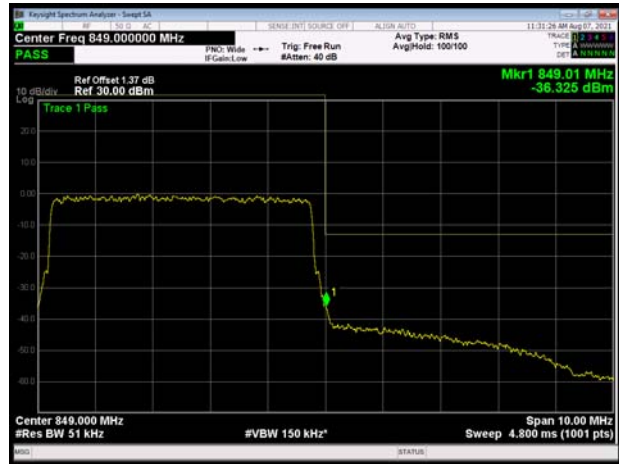
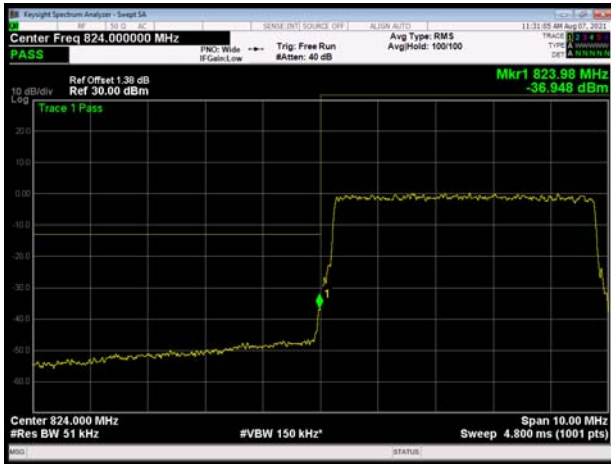

LTE Band 5 QPSK 10MHz CH-Low 1RB

LTE Band 5 QPSK 10MHz CH-High 1RB

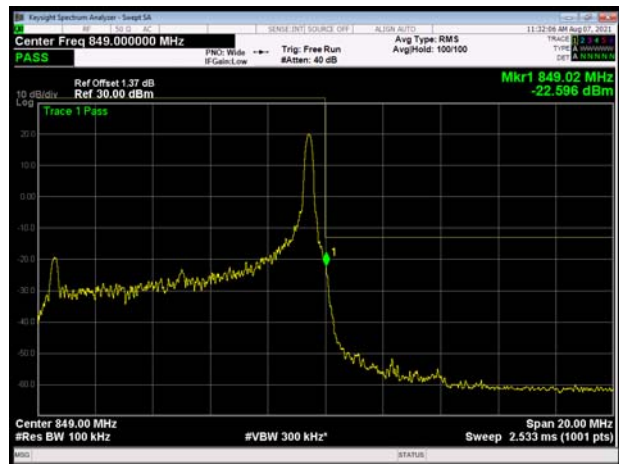
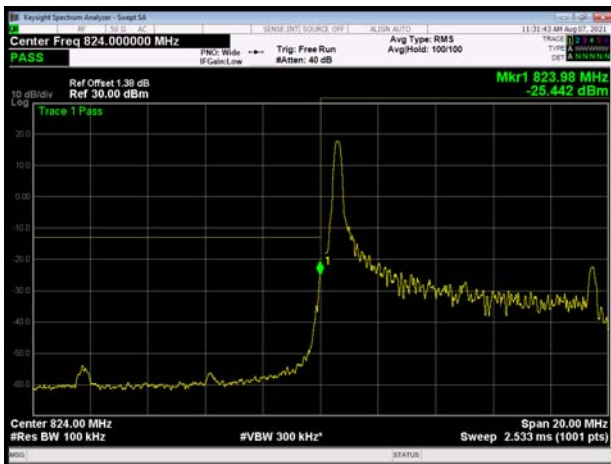

LTE Band 5 QPSK 10MHz CH-Low 100%RB

LTE Band 5 QPSK 10MHz CH-High 100%RB

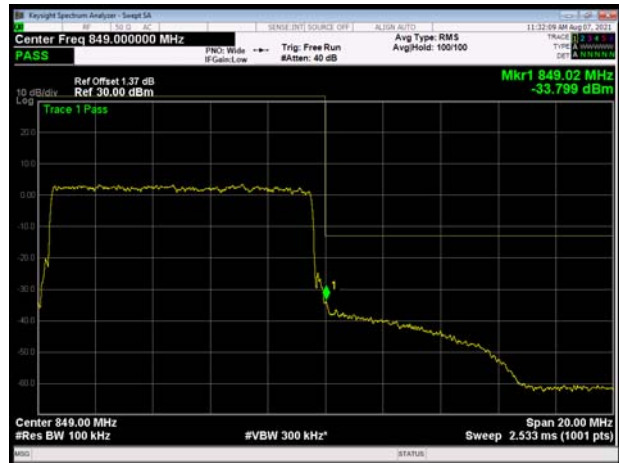
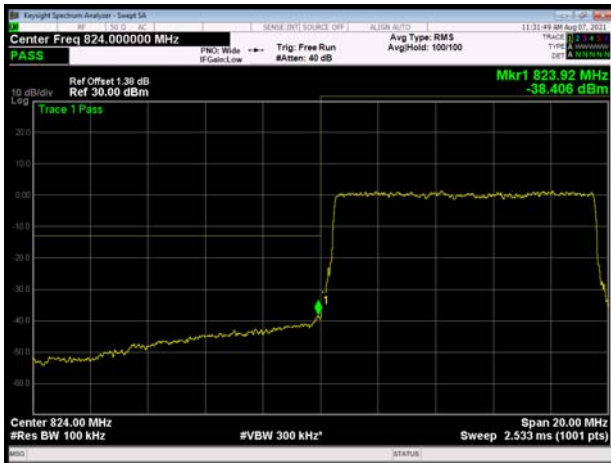

LTE Band 5 16QAM 1.4MHz CH-Low 1RB

LTE Band 5 16QAM 1.4MHz CH-High 1RB

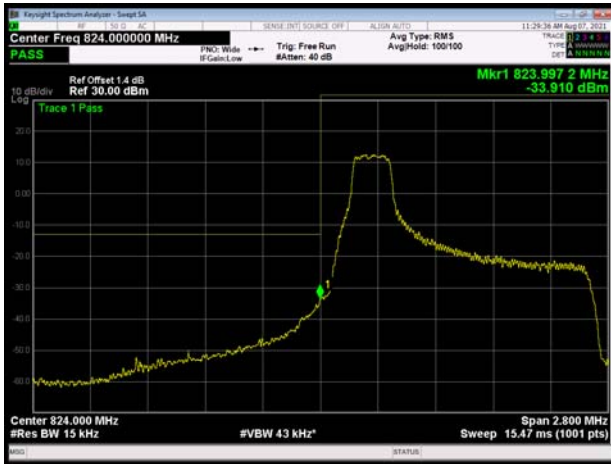

LTE Band 5 16QAM 1.4MHz CH-Low 100%RB

LTE Band 5 16QAM 1.4MHz CH-High 100%RB

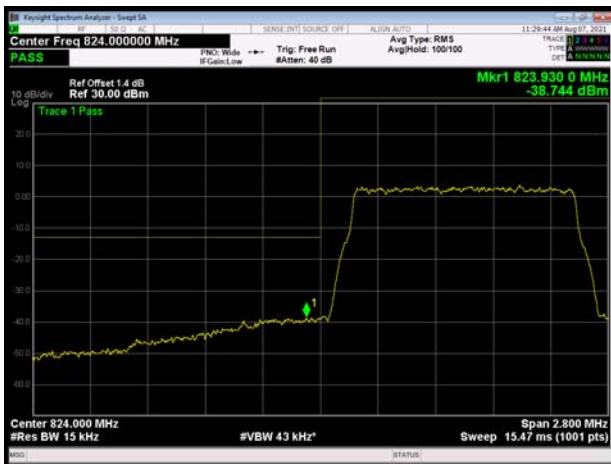

LTE Band 5 16QAM 3MHz CH-Low 1RB

LTE Band 5 16QAM 3MHz CH-High 1RB

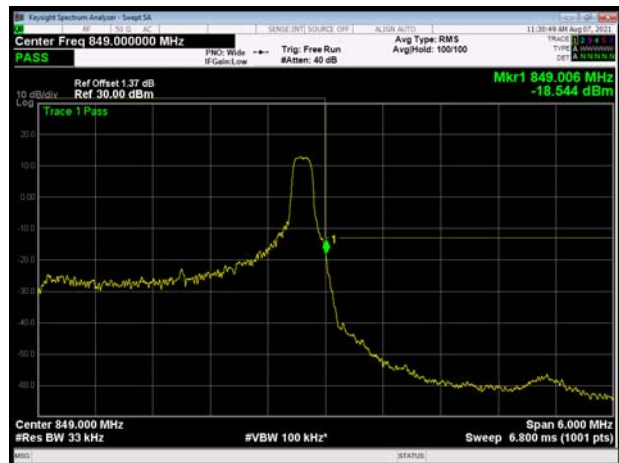
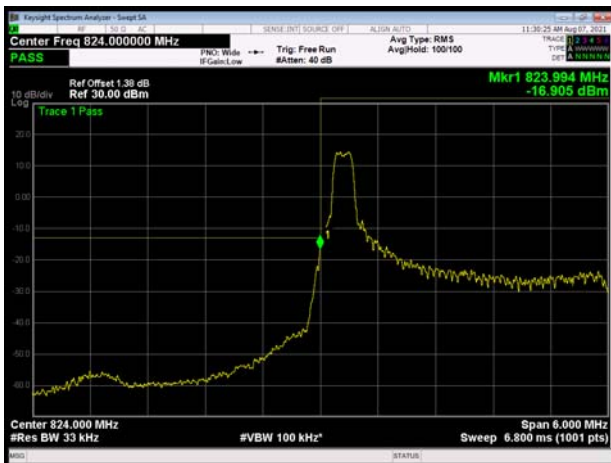

LTE Band 5 16QAM 3MHz CH-Low 100%RB

LTE Band 5 16QAM 3MHz CH-High 100%RB

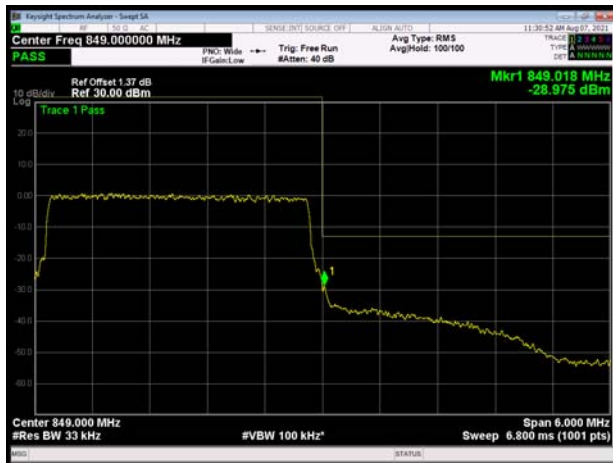
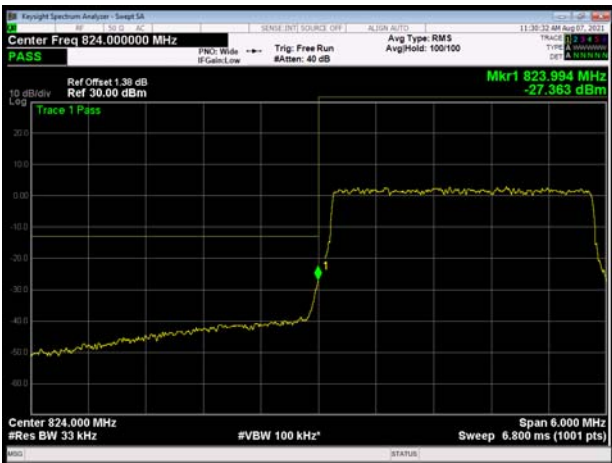

LTE Band 5 16QAM 5MHz CH-Low 1RB

LTE Band 5 16QAM 5MHz CH-High 1RB

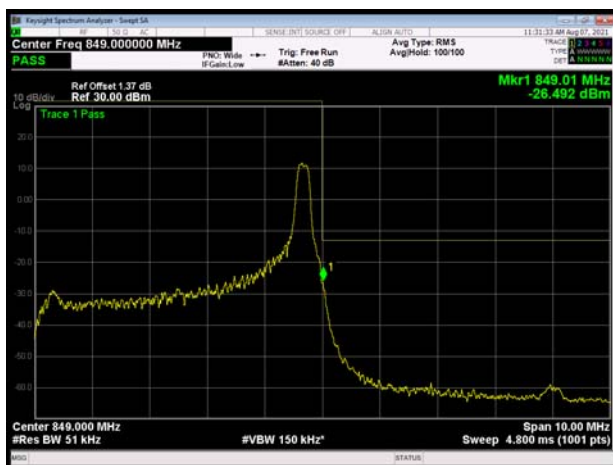
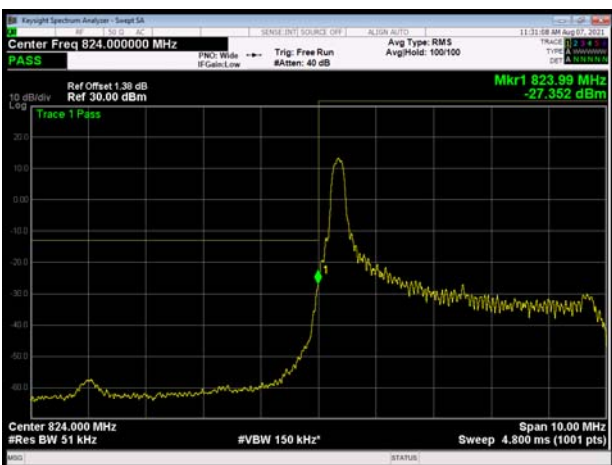

LTE Band 5 16QAM 5MHz CH-Low 100%RB

LTE Band 5 16QAM 5MHz CH-High 100%RB

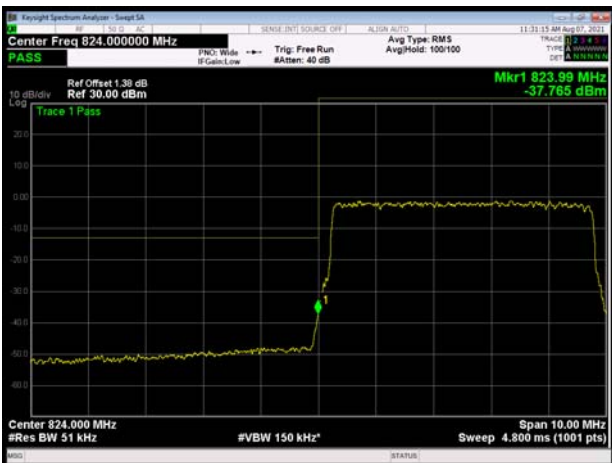

LTE Band 5 16QAM 10MHz CH-Low 1RB

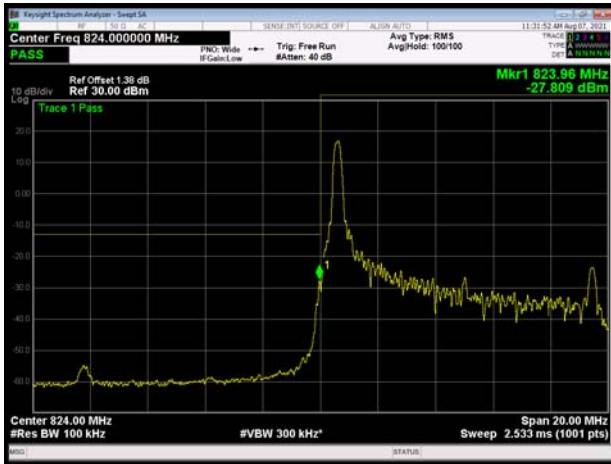

LTE Band 5 16QAM 10MHz CH-High 1RB

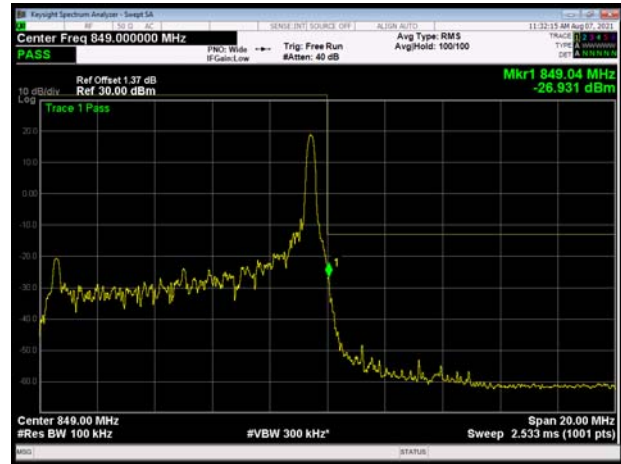

LTE Band 5 16QAM 10MHz CH-Low 100%RB

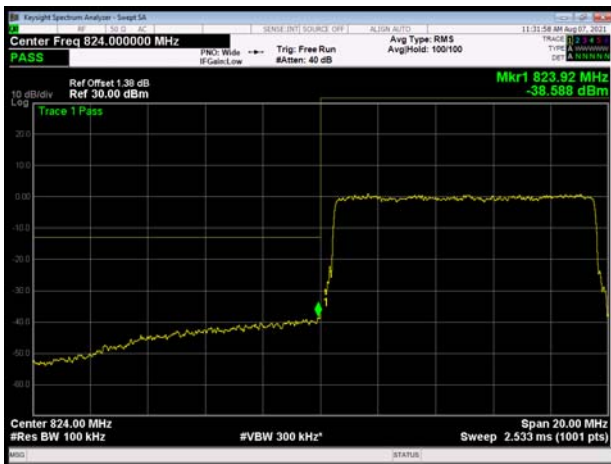

LTE Band 5 16QAM 10MHz CH-High 100%RB



LTE Band 5 64QAM 1.4MHz CH-Low 1RB

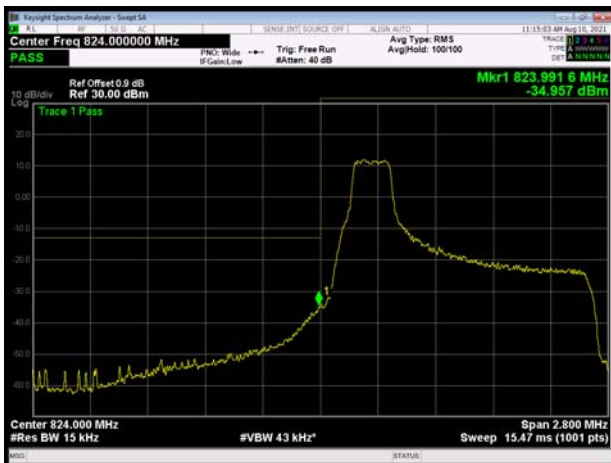

LTE Band 5 64QAM 1.4MHz CH-High 1RB

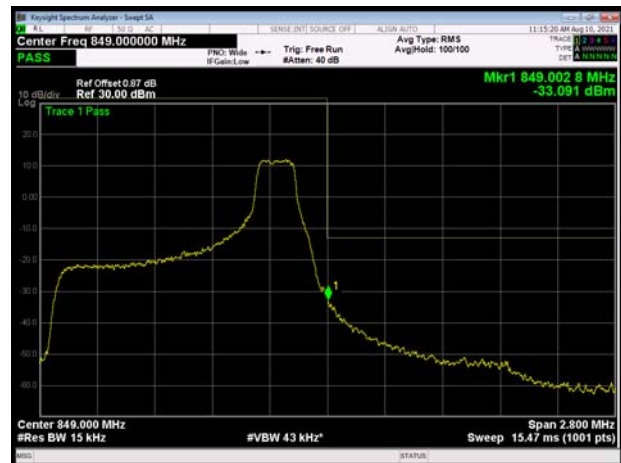

LTE Band 5 64QAM 1.4MHz CH-Low 100%RB

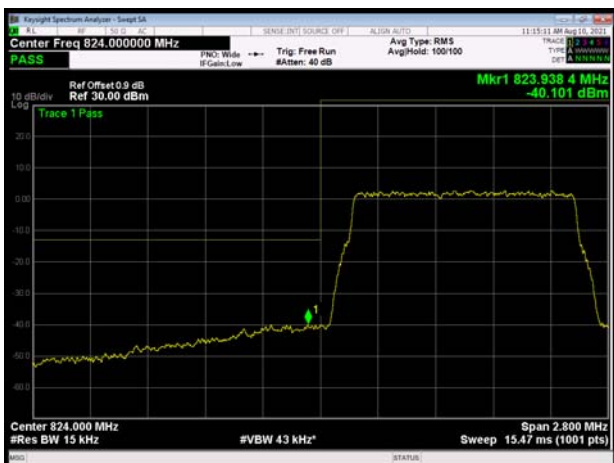

LTE Band 5 64QAM 1.4MHz CH-High 100%RB

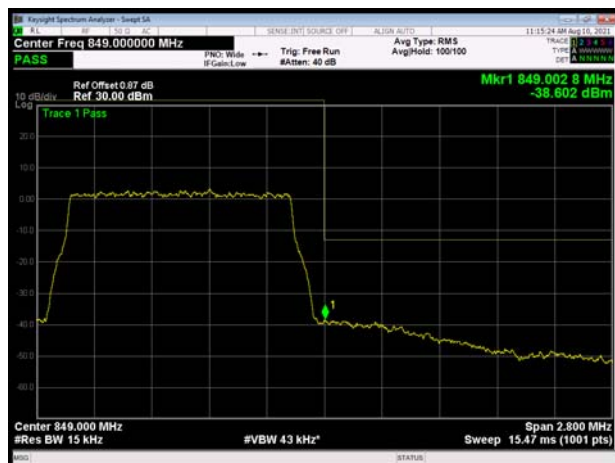

LTE Band 5 64QAM 3MHz CH-Low 1RB

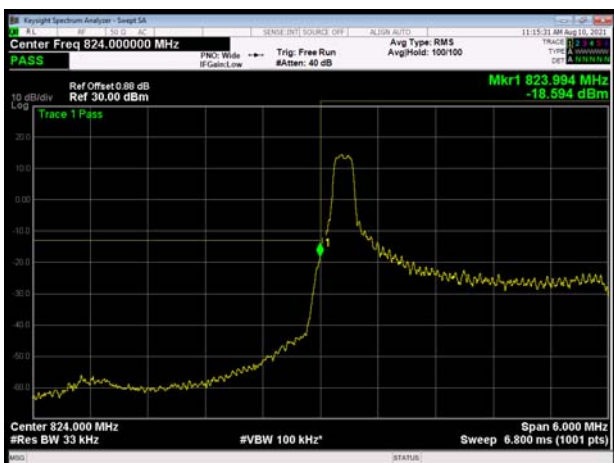

LTE Band 5 64QAM 3MHz CH-High 1RB

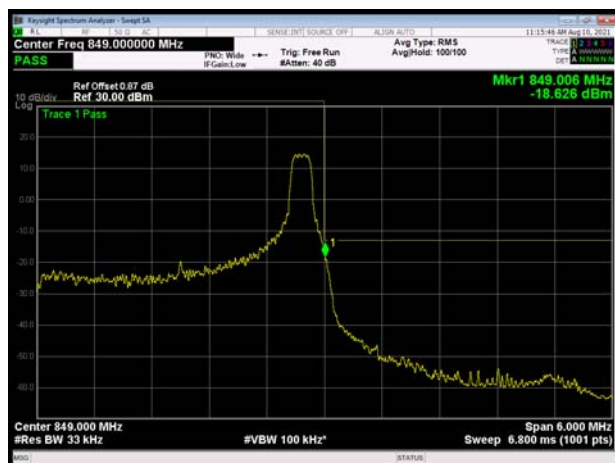

LTE Band 5 64QAM 3MHz CH-Low 100%RB

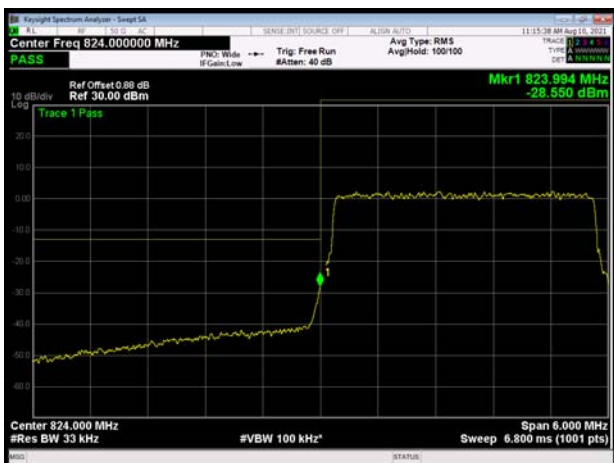

LTE Band 5 64QAM 3MHz CH-High 100%RB



LTE Band 5 64QAM 5MHz CH-Low 1RB

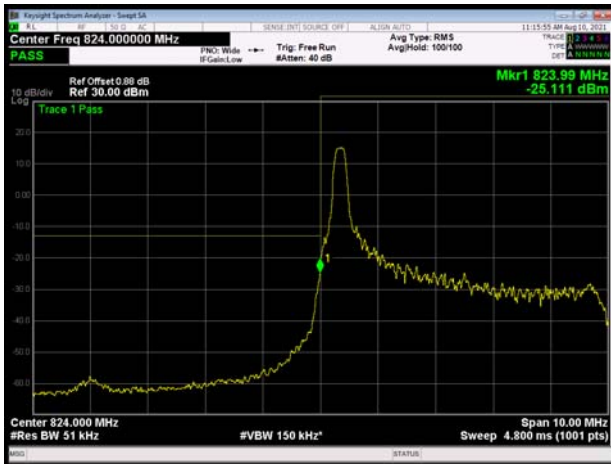

LTE Band 5 64QAM 5MHz CH-High 1RB

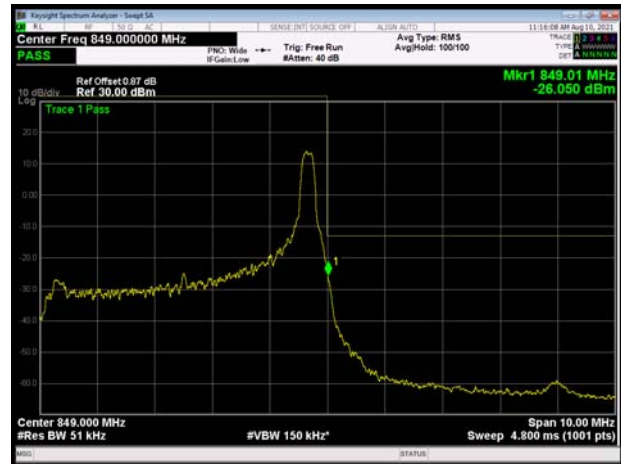

LTE Band 5 64QAM 5MHz CH-Low 100%RB

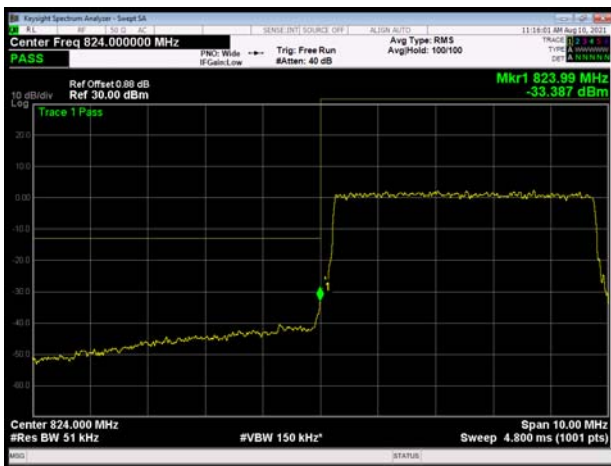

LTE Band 5 64QAM 5MHz CH-High 100%RB

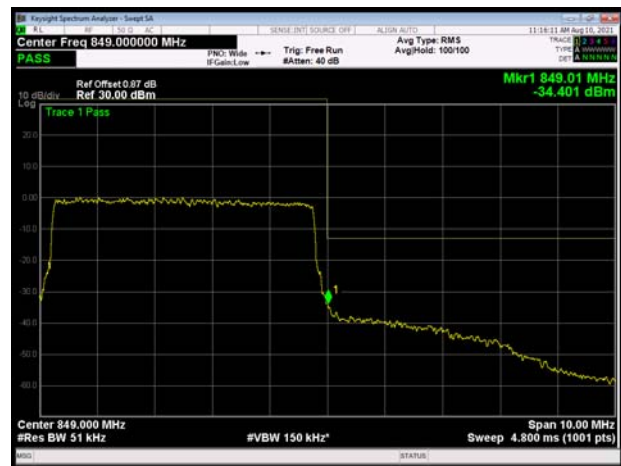

LTE Band 5 64QAM 10MHz CH-Low 1RB

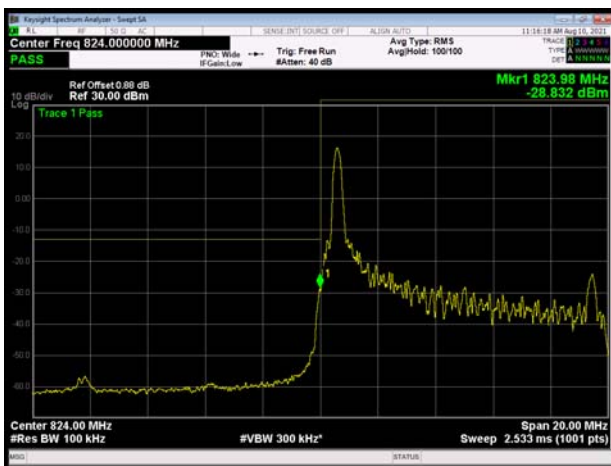

LTE Band 5 64QAM 10MHz CH-High 1RB

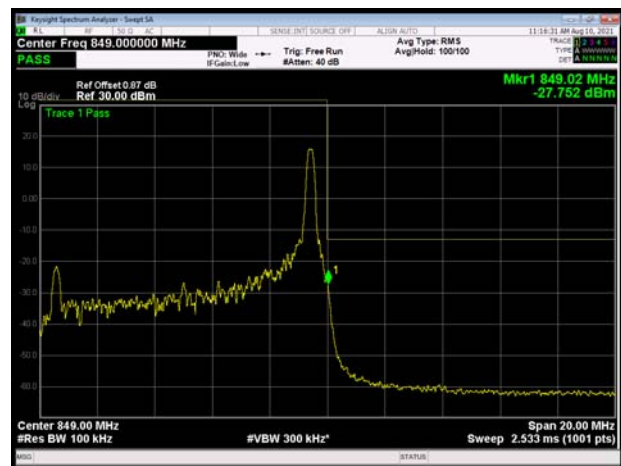

LTE Band 5 64QAM 10MHz CH-Low 100%RB

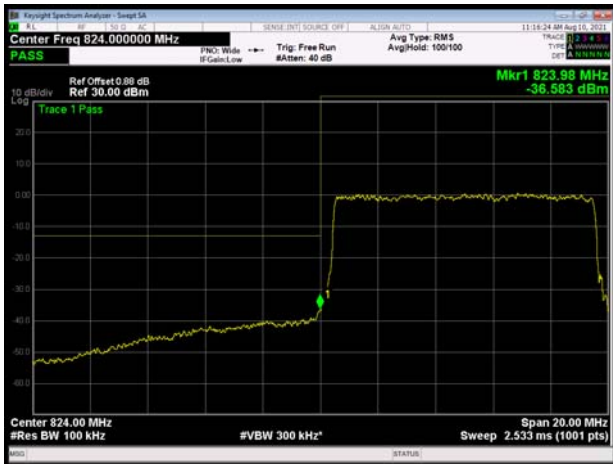

LTE Band 5 64QAM 10MHz CH-High 100%RB



5.4. Peak-to-Average Power Ratio (PAPR)

Ambient condition

Temperature	Relative humidity	Pressure
23°C ~25°C	45%~50%	101.5kPa

Methods of Measurement

Measure the total peak power and record as P_{Pk} . And measure the total average power and record as P_{Avg} . Both the peak and average power levels must be expressed in the same logarithmic units (e.g., dBm). Determine the PAPR from:

$$PAPR (dB) = P_{Pk} (dBm) - P_{Avg} (dBm).$$

Test Setup

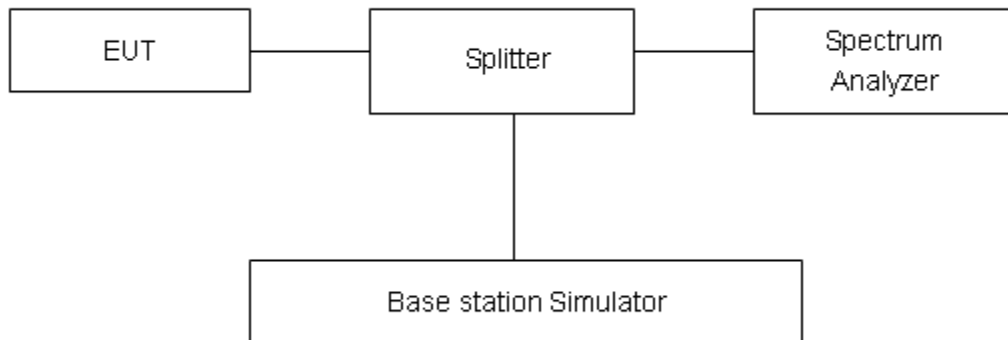

Limits

According to the Sec. 22.913(d), The peak-to-average ratio (PAR) of the transmission must not exceed 13 dB.

Measurement Uncertainty

The assessed measurement uncertainty to ensure 95% confidence level for the normal distribution is with the coverage factor $k = 2$, $U = 0.4$ dB.

Test Results

Mode	Channel	Frequency (MHz)	Peak (dBm)	Avg (dBm)	PAPR (dB)	Limit (dB)	Conclusion
GSM 850 (GMSK)	128	824.2	32.59	29.96	2.63	≤13	PASS
	190	836.6	32.66	30.03	2.63	≤13	PASS
	251	848.8	32.76	30.13	2.63	≤13	PASS
GPRS 850 (GMSK)	128	824.2	32.62	29.99	2.63	≤13	PASS
	190	836.6	32.67	30.04	2.63	≤13	PASS
	251	848.8	32.77	30.14	2.63	≤13	PASS
EGPRS 850 (8PSK)	128	824.2	28.17	22.59	5.58	≤13	PASS
	190	836.6	28.46	22.93	5.53	≤13	PASS
	251	848.8	27.99	22.41	5.58	≤13	PASS
WCDMA Band V (RMC)	4132	826.4	26.56	23.54	3.02	≤13	PASS
	4183	836.6	26.42	23.49	2.93	≤13	PASS
	4233	846.6	26.40	23.52	2.88	≤13	PASS

LTE Band 5								
Modulation	Bandwidth (MHz)	Channel	Frequency (MHz)	Peak (dBm)	Avg (dBm)	PAPR (dB)	Limit (dB)	Conclusion
QPSK	1.4	20407	824.7	27.08	21.54	5.54	≤13	PASS
		20525	836.5	26.80	21.51	5.29	≤13	PASS
		20643	848.3	26.79	21.53	5.26	≤13	PASS
	3	20415	825.5	27.01	21.44	5.57	≤13	PASS
		20525	836.5	26.81	21.53	5.28	≤13	PASS
		20635	847.5	26.83	21.50	5.33	≤13	PASS
	5	20425	826.5	27.20	21.65	5.55	≤13	PASS
		20525	836.5	26.95	21.56	5.39	≤13	PASS
		20625	846.5	26.91	21.62	5.29	≤13	PASS
	10	20450	829	27.10	21.53	5.57	≤13	PASS
		20525	836.5	26.99	21.61	5.38	≤13	PASS
		20600	844	26.91	21.50	5.41	≤13	PASS
16QAM	1.4	20407	824.7	26.90	20.64	6.26	≤13	PASS
		20525	836.5	26.65	20.61	6.04	≤13	PASS
		20643	848.3	26.67	20.60	6.07	≤13	PASS
	3	20415	825.5	26.85	20.50	6.35	≤13	PASS
		20525	836.5	26.79	20.63	6.16	≤13	PASS
		20635	847.5	26.99	20.96	6.03	≤13	PASS
	5	20425	826.5	26.89	20.64	6.25	≤13	PASS
		20525	836.5	26.73	20.65	6.08	≤13	PASS
		20625	846.5	26.97	20.92	6.05	≤13	PASS
	10	20450	829	26.99	20.66	6.33	≤13	PASS
		20525	836.5	26.85	20.66	6.19	≤13	PASS
		20600	844	26.84	20.66	6.18	≤13	PASS
64QAM	1.4	20407	824.7	24.42	18.62	5.80	≤13	PASS
		20525	836.5	24.01	18.25	5.76	≤13	PASS
		20643	848.3	23.02	17.50	5.52	≤13	PASS
	3	20415	825.5	24.21	18.45	5.76	≤13	PASS
		20525	836.5	25.85	19.70	6.15	≤13	PASS
		20635	847.5	26.01	19.96	6.05	≤13	PASS
	5	20425	826.5	26.02	19.82	6.20	≤13	PASS
		20525	836.5	25.85	19.70	6.15	≤13	PASS
		20625	846.5	26.13	20.10	6.03	≤13	PASS
	10	20450	829	26.05	19.77	6.28	≤13	PASS
		20525	836.5	26.01	19.82	6.19	≤13	PASS
		20600	844	25.82	19.66	6.16	≤13	PASS

5.5. Frequency Stability

Ambient condition

Temperature	Relative humidity	Pressure
23°C ~25°C	45%~50%	101.5kPa

Method of Measurement

Frequency Stability (Temperature Variation)

The temperature inside the climate chamber is varied from -30°C to +50°C in 10°C step size,

(1) With all power removed, the temperature was decreased to 0°C and permitted to stabilize for three hours.

(2) Measure the carrier frequency with the test equipment in a “call mode”. These measurements should be made within 1 minute of powering up the mobile station, to prevent significant self warming.

(3) Repeat the above measurements at 10°C increments from -30°C to +50°C. Allow at least 1.5 hours at each temperature, un-powered, before making measurements. Frequency Stability (Voltage Variation)

The frequency stability shall be measured with variation of primary supply voltage as follows:

Primary Supply Voltage: The primary supply voltage is varied from 85% to 115% of the nominal value for non hand-carried battery and AC powered equipment. For hand-carried, battery-powered equipment, primary supply voltage is reduced to the battery operating end point which shall be specified by the manufacturer.

This transceiver is specified to operate with an input voltage of between 3.4 V and 4.35 V, with a nominal voltage of 3.8V.

Test setup

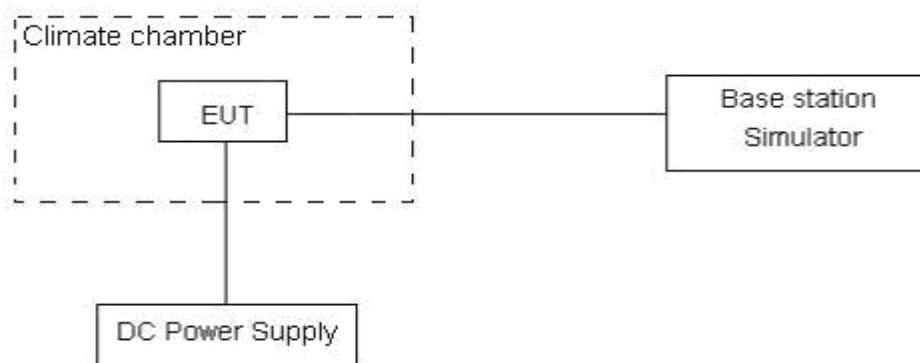

Limits

According to the Sec. 22.355, the frequency stability of the carrier shall be accurate to within 2.5 ppm of the received frequency for mobile stations.

Limits	≤ 2.5 ppm
--------	-----------

Measurement Uncertainty

The assessed measurement uncertainty to ensure 99.75% confidence level for the normal distribution is with the coverage factor $k = 3$, $U = 0.01\text{ppm}$.

Test Result

GSM850						
Condition		Freq.Error (Hz)	Freq.Error (Hz)	Frequency Stability (ppm)	Frequency Stability (ppm)	Verdict
Temperature	Voltage	GMSK	8PSK	GMSK	8PSK	
Normal (25℃)	Normal	4.56	16.43	0.00545	0.01964	PASS
Extreme (50℃)		6.26	8.35	0.00748	0.00998	PASS
Extreme (40℃)		4.49	1.60	0.00537	0.00191	PASS
Extreme (30℃)		4.24	12.40	0.00507	0.01482	PASS
Extreme (20℃)		2.67	17.39	0.00319	0.02079	PASS
Extreme (10℃)		7.47	14.29	0.00892	0.01708	PASS
Extreme (0℃)		4.60	1.22	0.00550	0.00146	PASS
Extreme (-10℃)		1.04	13.88	0.00125	0.01659	PASS
Extreme (-20℃)		10.43	6.97	0.01246	0.00834	PASS
Extreme (-30℃)		1.15	2.64	0.00137	0.00315	PASS
25℃	LV	17.85	9.98	0.02134	0.01192	PASS
	HV	10.58	6.73	0.01265	0.00804	PASS

WCDMA Band V						
Condition		Freq.Error (Hz)	Freq.Error (Hz)	Frequency Stability (ppm)	Frequency Stability (ppm)	Verdict
Temperature	Voltage	BPSK	QPSK	BPSK	QPSK	
Normal (25℃)	Normal	13.88	9.03	0.01659	0.01080	PASS
Extreme (50℃)		17.23	15.75	0.02059	0.01882	PASS
Extreme (40℃)		11.10	5.71	0.01327	0.00683	PASS
Extreme (30℃)		8.63	11.43	0.01031	0.01366	PASS
Extreme (20℃)		13.84	8.68	0.01654	0.01038	PASS
Extreme (10℃)		17.50	3.88	0.02092	0.00463	PASS
Extreme (0℃)		7.88	7.30	0.00942	0.00872	PASS
Extreme (-10℃)		17.76	8.57	0.02123	0.01024	PASS
Extreme (-20℃)		5.86	5.79	0.00701	0.00692	PASS
Extreme (-30℃)		9.55	16.64	0.01142	0.01989	PASS
25℃	LV	16.91	5.81	0.02022	0.00694	PASS
	HV	11.55	10.38	0.01381	0.01240	PASS

LTE band 5								
Condition		Freq.Error (Hz)	Freq.Error (Hz)	Freq.Error (Hz)	Frequency Stability (ppm)	Frequency Stability (ppm)	Frequency Stability (ppm)	Verdict
BANDWIDTH	1.4MHz							
Temperature	Voltage	64QAM	16QAM	QPSK	64QAM	16QAM	QPSK	
Normal (25°C)	Normal	10.57	15.26	4.06	0.01264	0.01824	0.00485	PASS
Extreme (50°C)		8.20	14.21	11.22	0.00981	0.01698	0.01341	PASS
Extreme (40°C)		3.41	3.82	17.18	0.00408	0.00456	0.02053	PASS
Extreme (30°C)		8.25	11.92	10.90	0.00986	0.01425	0.01303	PASS
Extreme (20°C)		3.84	4.90	8.34	0.00459	0.00586	0.00997	PASS
Extreme (10°C)		9.42	15.79	3.60	0.01126	0.01888	0.00430	PASS
Extreme (0°C)		4.30	17.79	17.60	0.00514	0.02127	0.02104	PASS
Extreme (-10°C)		5.63	11.23	9.23	0.00673	0.01343	0.01103	PASS
Extreme (-20°C)		1.46	1.70	12.87	0.00174	0.00204	0.01539	PASS
Extreme (-30°C)		1.35	17.08	5.18	0.00161	0.02042	0.00620	PASS
25°C		LV	11.68	9.30	10.88	0.01396	0.01112	0.01300
	HV	10.78	5.86	3.00	0.01288	0.00700	0.00359	PASS
Condition		Freq.Error (Hz)	Freq.Error (Hz)	Freq.Error (Hz)	Frequency Stability (ppm)	Frequency Stability (ppm)	Frequency Stability (ppm)	Verdict
BANDWIDTH	3MHz							
Temperature	Voltage	64QAM	16QAM	QPSK	64QAM	16QAM	QPSK	
Normal (25°C)	Normal	8.21	7.80	13.45	0.00981	0.00933	0.01608	PASS
Extreme (50°C)		6.26	17.36	13.71	0.00748	0.02076	0.01639	PASS
Extreme (40°C)		16.18	17.45	2.03	0.01934	0.02086	0.00242	PASS
Extreme (30°C)		13.68	17.66	4.85	0.01636	0.02111	0.00580	PASS
Extreme (20°C)		16.85	4.03	4.59	0.02014	0.00482	0.00549	PASS
Extreme (10°C)		7.38	12.79	4.49	0.00882	0.01528	0.00537	PASS
Extreme (0°C)		16.51	12.55	10.80	0.01974	0.01501	0.01291	PASS
Extreme (-10°C)		9.63	13.88	10.32	0.01151	0.01660	0.01234	PASS
Extreme (-20°C)		17.23	13.73	17.58	0.02060	0.01641	0.02102	PASS
Extreme (-30°C)		5.92	16.60	11.54	0.00708	0.01984	0.01379	PASS
25°C		LV	2.28	15.87	6.50	0.00273	0.01897	0.00777
	HV	5.63	6.44	17.93	0.00673	0.00770	0.02144	PASS
Condition		Freq.Error (Hz)	Freq.Error (Hz)	Freq.Error (Hz)	Frequency Stability (ppm)	Frequency Stability (ppm)	Frequency Stability (ppm)	Verdict
BANDWIDTH	5MHz							
Temperature	Voltage	64QAM	16QAM	QPSK	64QAM	16QAM	QPSK	
Normal (25°C)	Normal	6.44	2.84	13.04	0.00770	0.00340	0.01559	PASS
Extreme (50°C)		10.60	10.59	17.58	0.01267	0.01266	0.02102	PASS
Extreme (40°C)		11.62	1.77	2.98	0.01389	0.00212	0.00356	PASS

Extreme (30℃)		7.82	12.65	1.75	0.00935	0.01512	0.00209	PASS
Extreme (20℃)		11.91	17.46	17.89	0.01423	0.02088	0.02138	PASS
Extreme (10℃)		11.26	10.77	11.59	0.01346	0.01287	0.01386	PASS
Extreme (0℃)		9.50	14.46	8.44	0.01136	0.01729	0.01009	PASS
Extreme (-10℃)		4.32	10.39	16.26	0.00516	0.01242	0.01944	PASS
Extreme (-20℃)		3.06	8.30	2.77	0.00366	0.00993	0.00331	PASS
Extreme (-30℃)		14.81	5.26	14.20	0.01770	0.00629	0.01697	PASS
25℃	LV	13.72	9.22	9.73	0.01640	0.01103	0.01163	PASS
	HV	8.35	10.34	6.63	0.00998	0.01236	0.00793	PASS
Condition		Freq.Error (Hz)	Freq.Error (Hz)	Freq.Error (Hz)	Frequency Stability (ppm)	Frequency Stability (ppm)	Frequency Stability (ppm)	Verdict
BANDWIDTH	10MHz							
Temperature	Voltage	64QAM	16QAM	QPSK	64QAM	16QAM	QPSK	
Normal (25℃)	Normal	10.87	11.47	5.62	0.01300	0.01371	0.00672	PASS
Extreme (50℃)		2.84	12.88	4.39	0.00340	0.01540	0.00524	PASS
Extreme (40℃)		2.74	7.77	17.55	0.00328	0.00929	0.02098	PASS
Extreme (30℃)		14.81	1.38	8.85	0.01771	0.00165	0.01058	PASS
Extreme (20℃)		9.39	1.03	14.97	0.01123	0.00123	0.01790	PASS
Extreme (10℃)		4.63	3.11	4.06	0.00554	0.00372	0.00485	PASS
Extreme (0℃)		4.36	3.52	14.55	0.00521	0.00421	0.01739	PASS
Extreme (-10℃)		7.10	4.10	2.27	0.00849	0.00490	0.00271	PASS
Extreme (-20℃)		16.09	9.15	11.30	0.01923	0.01093	0.01351	PASS
Extreme (-30℃)		14.39	3.79	11.26	0.01720	0.00453	0.01346	PASS
25℃	LV	5.39	5.09	4.93	0.00644	0.00609	0.00589	PASS
	HV	13.49	5.11	4.99	0.01613	0.00611	0.00596	PASS

5.6. Spurious Emissions at Antenna Terminals

Ambient condition

Temperature	Relative humidity	Pressure
23°C ~25°C	45%~50%	101.5kPa

Method of Measurement

The EUT was connected to Spectrum Analyzer and Base Station Simulator via power Splitter. The measurement is carried out using a spectrum analyzer. The spectrum analyzer scans from 9kHz to the 10th harmonic of the carrier.

The peak detector is used. RBW are set to 100 kHz and VBW are set to 300 kHz for below 1G, RBW are set to 1MHz and VBW are set to 3MHz for above 1G, Sweep is set to ATUO.

RBW is set to 1 kHz (0.009MHz~ 0.15 MHz),

RBW is set to 10 kHz (0.15 MHz~ 30 MHz)

RBW is set to 100 kHz (30MHz~1000 MHz)

RBW is set to 1000 kHz (above 1000MHz)

The modulation mode and RB allocation refer to section 5.1, using the maximum output power configuration.

Test setup

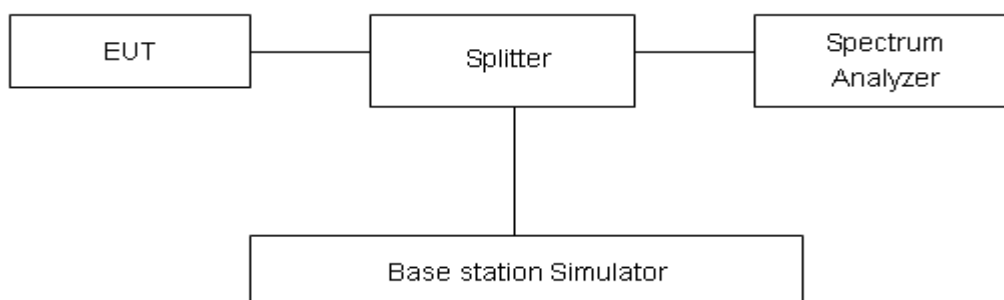

Limits

Rule Part 22.917(a) specifies that “The power of any emission outside of the authorized operating frequency ranges must be attenuated below the transmitting power (P) by a factor of at least 43 + 10 log (P) dB.”

Limit	-13 dBm
-------	---------

Measurement Uncertainty

The assessed measurement uncertainty to ensure 99.75% confidence level for the normal distribution is with the coverage factor $k = 1.96$.

Frequency	Uncertainty
9kHz-1GHz	0.684 dB
1GHz-18GHz	1.407 dB

Test Result

Sweep the whole frequency band through the range from 9kHz to the 10th harmonic of the carrier, the emissions more than 20 dB below the limit are not reported. The signal beyond the limit is carrier.

GSM 850 CH-Low 9kHz ~ 20GHz

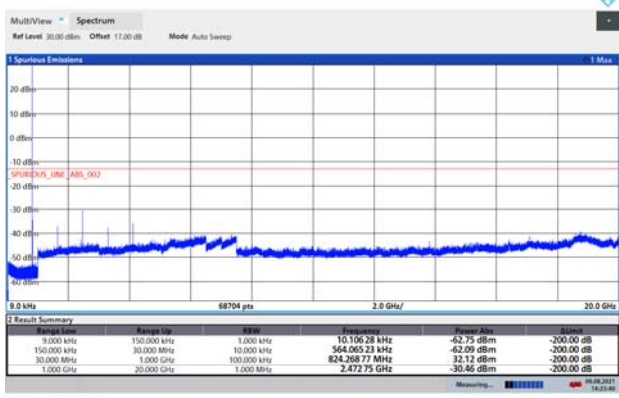

14:23:40 09.08.2021

GPRS 850 CH-Low 9kHz ~ 20GHz

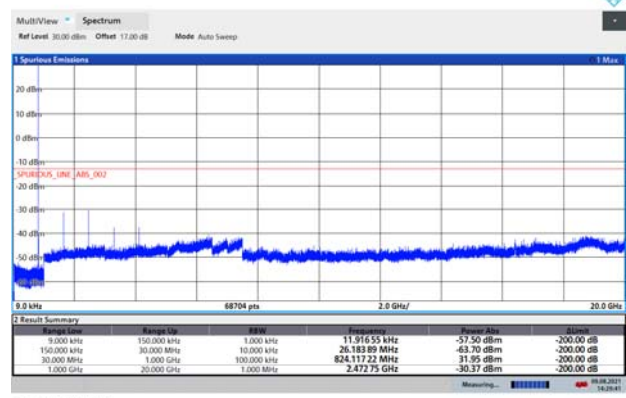

14:23:42 09.08.2021

GSM 850 CH-Middle 9kHz ~ 20GHz

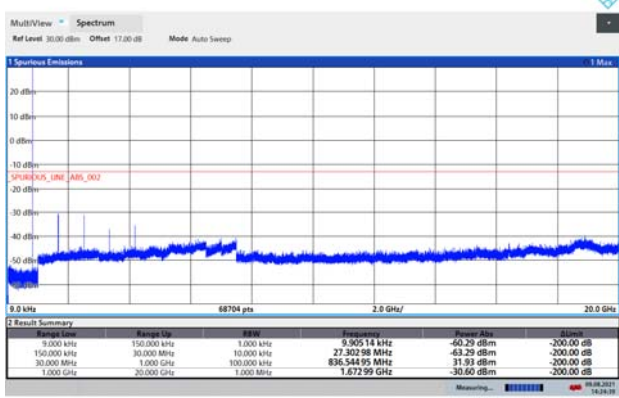

14:24:40 09.08.2021

GPRS 850 CH-Middle 9kHz ~ 20GHz

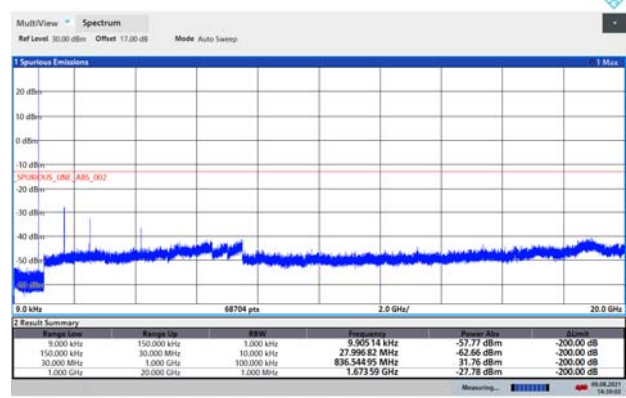

14:30:03 09.08.2021

GSM 850 CH-High 9kHz ~ 20GHz

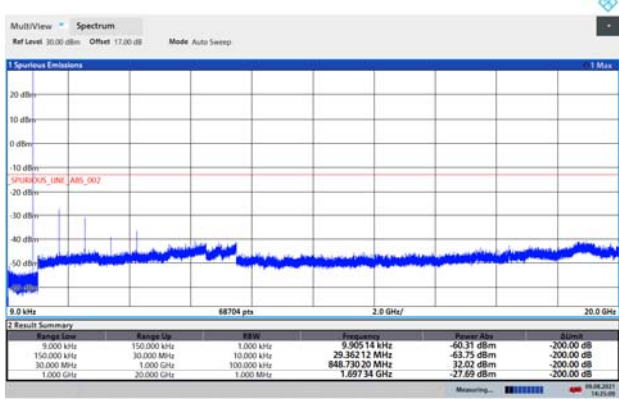

14:25:09 09.08.2021

GPRS 850 CH-High 9kHz ~ 20GHz

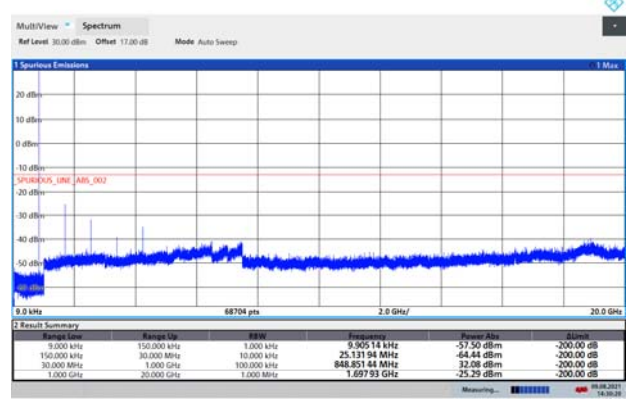

14:30:21 09.08.2021

EGPRS 850 CH-Low 9kHz ~ 20GHz

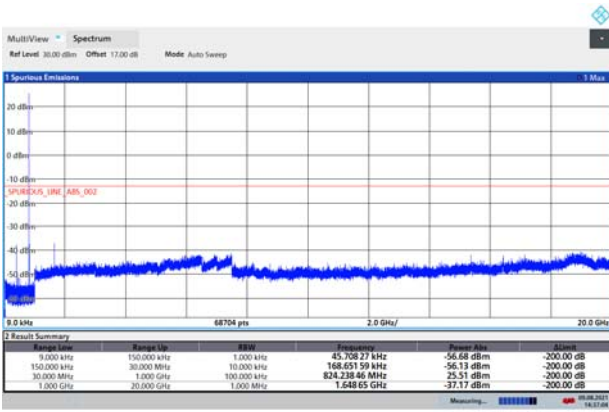

WCDMA BAND V CH-Low 9kHz ~ 20GHz

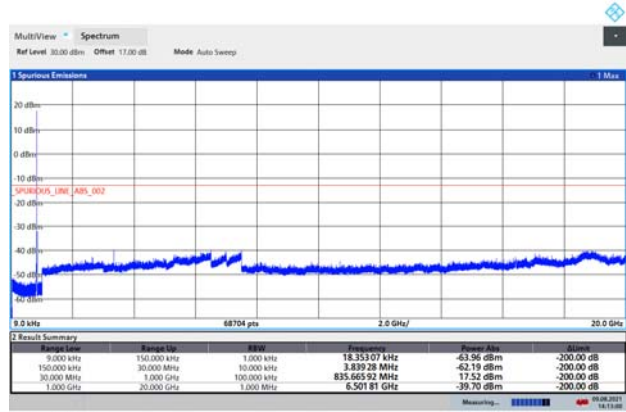

EGPRS 850 CH-Middle 9kHz ~ 20GHz

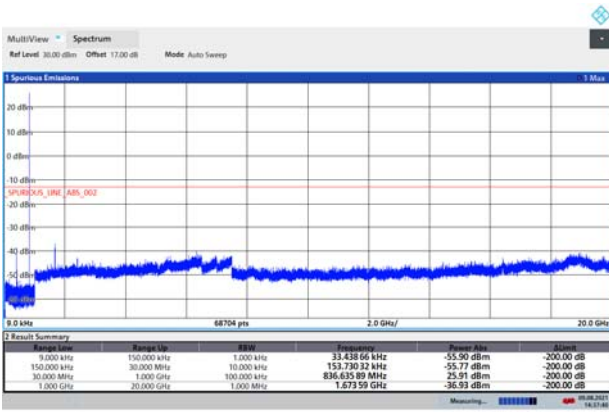

WCDMA BAND V CH-Middle 9kHz ~ 20GHz

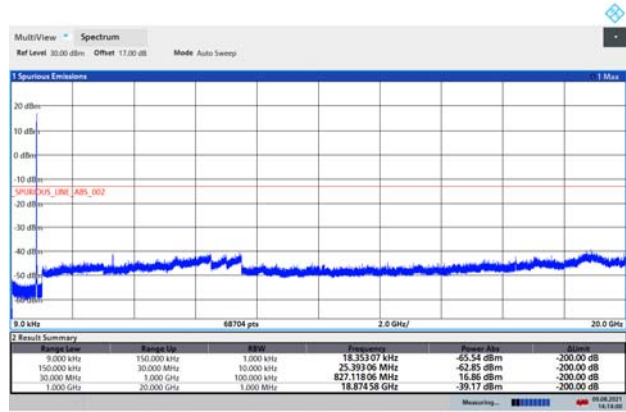

EGPRS 850 CH-High 9kHz ~ 20GHz

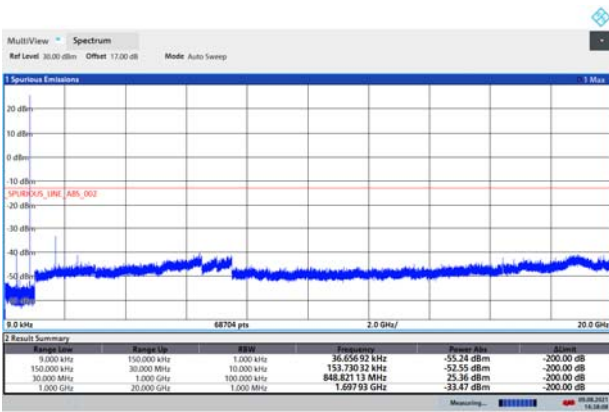

WCDMA BAND V CH-High 9kHz ~ 20GHz

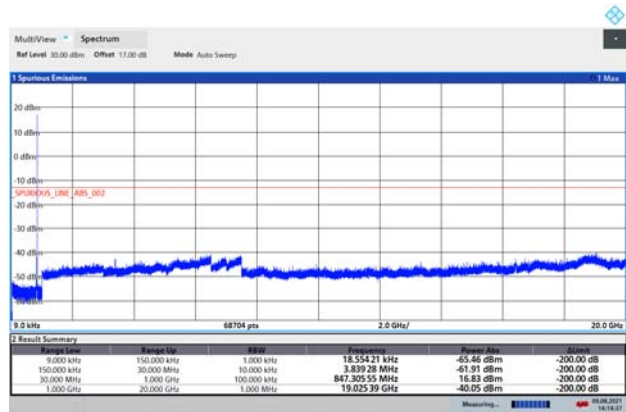

LTE Band 5 1.4MHz CH-Low 9kHz~10GHz

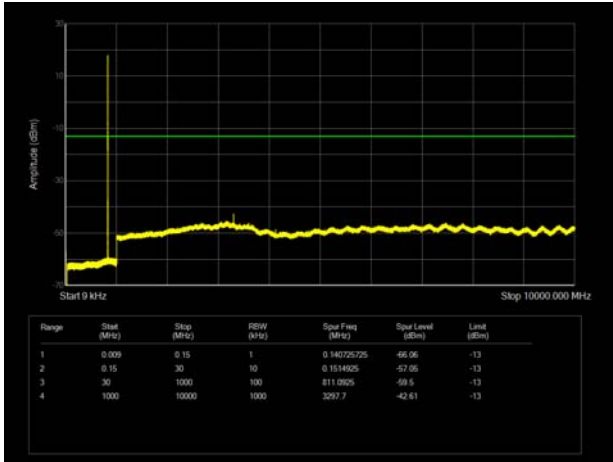

LTE Band 5 3MHz CH-Low 9kHz~10GHz

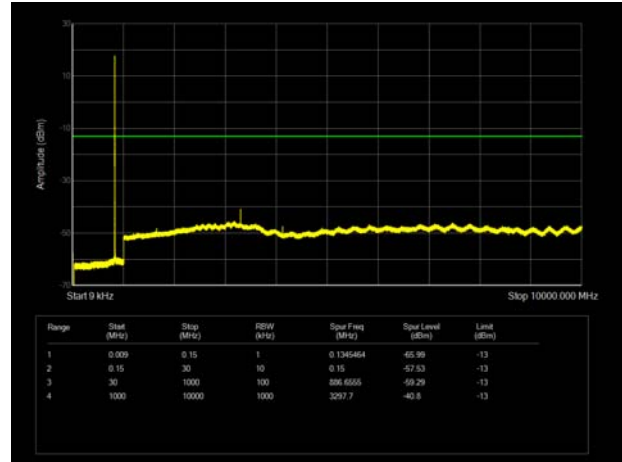

LTE Band 5 1.4MHz CH-Middle 9kHz~10GHz

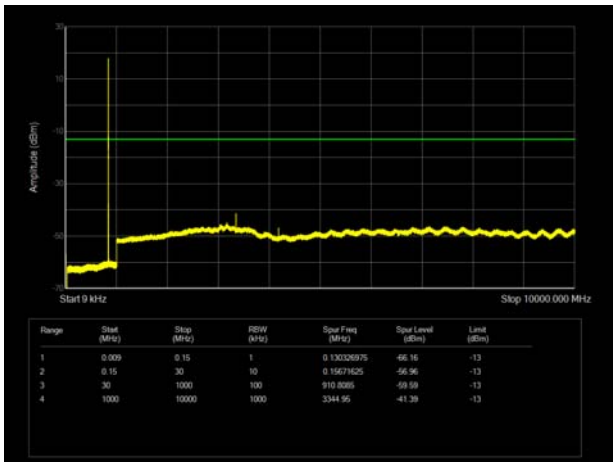

LTE Band 5 3MHz CH-Middle 9kHz~10GHz

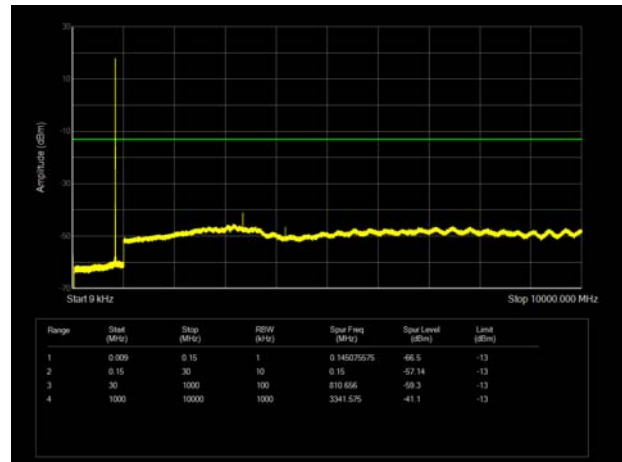

LTE Band 5 1.4MHz CH-High 9kHz~10GHz

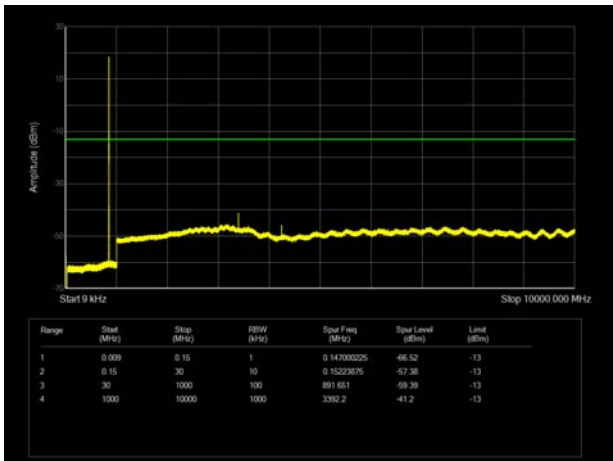

LTE Band 5 3MHz CH-High 9kHz~10GHz

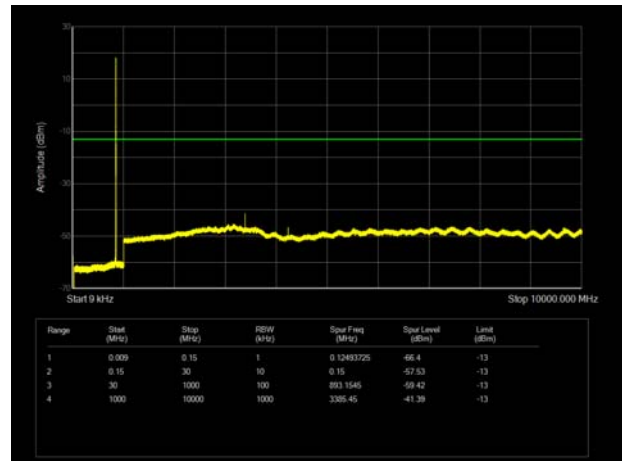

LTE Band 5 5MHz CH-Low 9kHz~10GHz

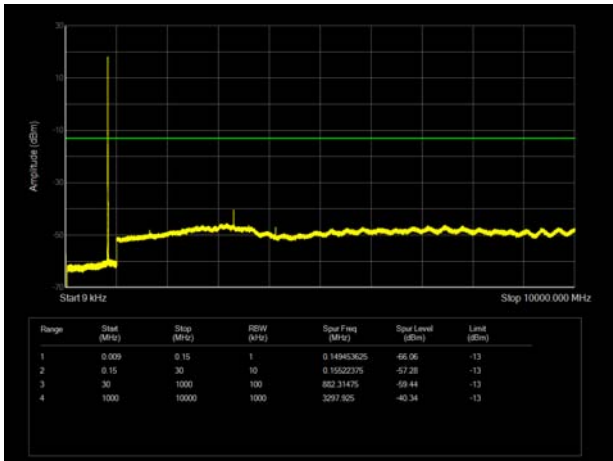

LTE Band 5 10MHz CH-Low 9kHz~10GHz

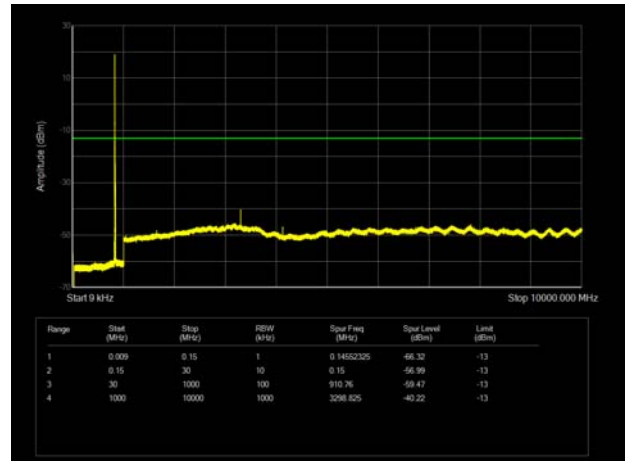

LTE Band 5 5MHz CH-Middle 9kHz~10GHz

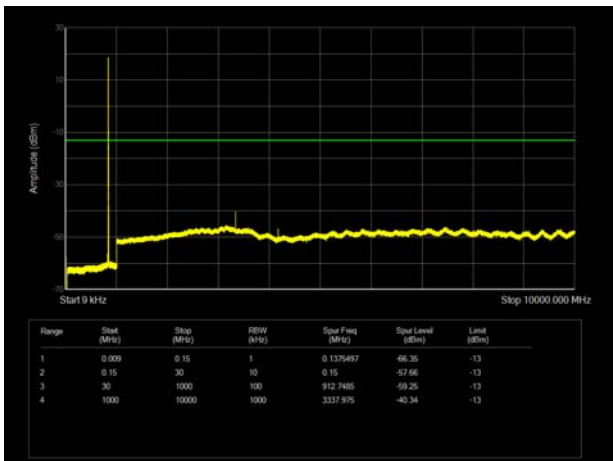

LTE Band 5 10MHz CH-Middle 9kHz~10GHz

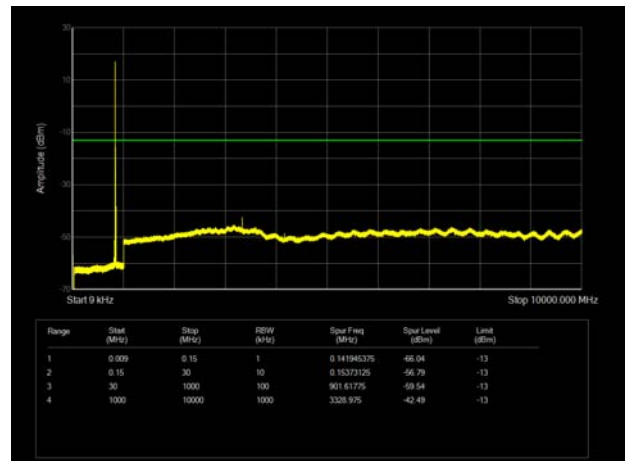

LTE Band 5 5MHz CH-High 9kHz~10GHz

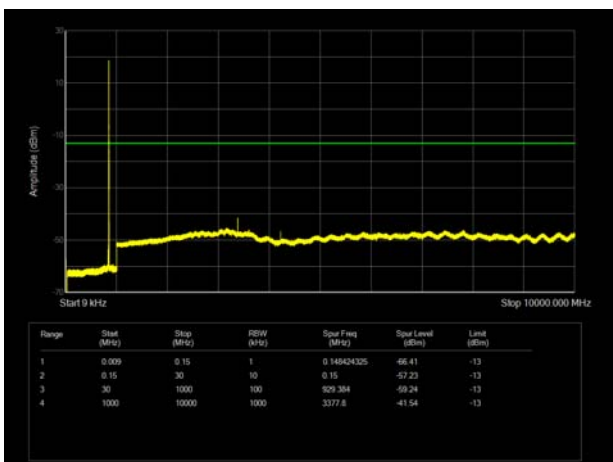

LTE Band 5 10MHz CH-High 9kHz~10GHz

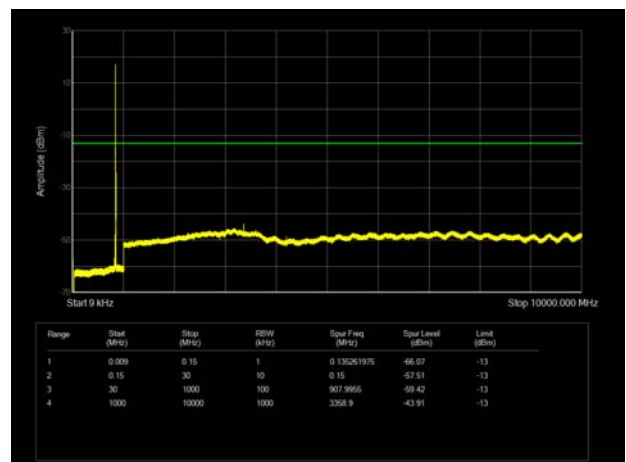

5.7. Radiates Spurious Emission

Ambient condition

Temperature	Relative humidity	Pressure
23°C ~25°C	45%~50%	101.5kPa

Method of Measurement

1. The testing follows FCC KDB 971168 v03r01 Section 5.8 and ANSI C63.26 (2015).
2. Below 1GHz: The EUT is placed on a turntable 0.8 meters above the ground in the chamber, 3 meter away from the antenna. The maximal emission value is acquired by adjusting the antenna height, polarisation and turntable azimuth. Normally, the height range of antenna is 1 m to 4 m, the azimuth range of turntable is 0° to 360°, and the receive antenna has two polarizations Vertical (V) and Horizontal (H). Above 1GHz: (Note: the FCC's permission to use 1.5m as an alternative per TCBC Conf call of Dec. 2, 2014.) The EUT is placed on a turntable 1.5 meters above the ground in the chamber, 3 meter away from the antenna. The maximal emission value is acquired by adjusting the antenna height, polarisation and turntable azimuth. Normally, the height range of antenna is 1 m to 4 m, the azimuth range of turntable is 0° to 360°, and the receive antenna has two polarizations Vertical (V) and Horizontal (H).
3. A loop antenna, A log-periodic antenna or horn antenna shall be substituted in place of the EUT. The log-periodic antenna will be driven by a signal generator and the level will be adjusted till the same power value on the spectrum analyzer or receiver. The level of the spurious emissions can be calculated through the level of the signal generator, cable loss, the gain of the substitution antenna and the reading of the spectrum analyzer or receiver.
4. The EUT is then put into continuously transmitting mode at its maximum power level during the test. Set Test Receiver or Spectrum RBW=100kHz,VBW=300kHz, and the maximum value of the receiver should be recorded as (Pr).
5. The EUT shall be replaced by a substitution antenna. In the chamber, an substitution antenna for the frequency band of interest is placed at the reference point of the chamber. An RF Signal source for the frequency band of interest is connected to the substitution antenna with a cable that has been constructed to not interfere with the radiation pattern of the antenna. A power (PMea) is applied to the input of the substitution antenna, and adjust the level of the signal generator output until the value of the receiver reach the previously recorded (Pr). The power of signal source (PMea) is recorded. The test should be performed by rotating the test item and adjusting the receiving antenna polarization.
6. A amplifier should be connected to the Signal Source output port. And the cable should be connect between the Amplifier and the Substitution Antenna. The cable loss (Pcl) ,the Substitution Antenna Gain (Ga) and the Amplifier Gain (PAg) should be recorded after test.
7. The measurement results are obtained as described below:

$$\text{Power(EIRP)} = \text{PMea} - \text{PAg} - \text{Pcl} + \text{Ga}$$
 The measurement results are amend as described below:

$$\text{Power(EIRP)} = \text{PMea} - \text{Pcl} + \text{Ga}$$
8. This value is EIRP since the measurement is calibrated using an antenna of known gain (2.15 dBi) and known input power. ERP can be calculated from EIRP by subtracting the gain of the dipole, $\text{ERP} = \text{EIRP} - 2.15\text{dBi}$.

The modulation mode and RB allocation refer to section 5.1, using the maximum output power configuration.

Test setup

9KHz ~ 30MHz

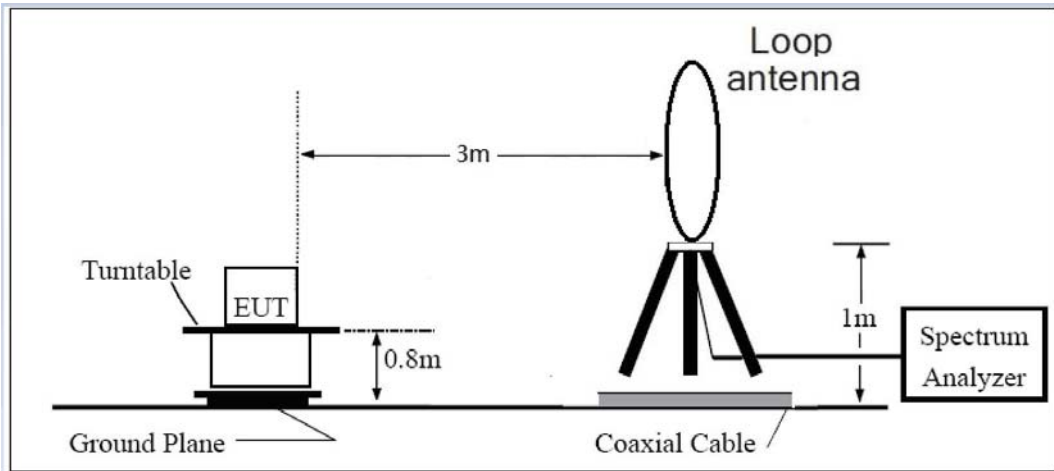

30MHz ~ 1GHz

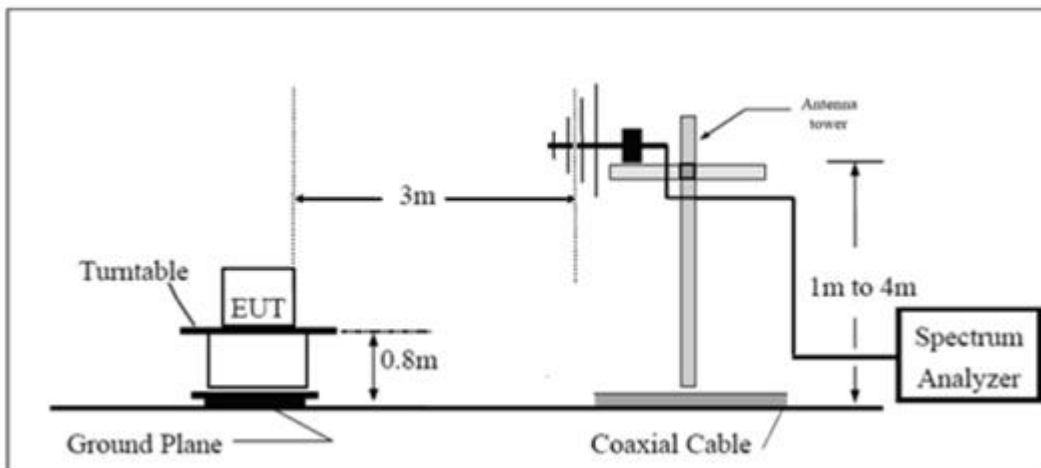

Above 1GHz

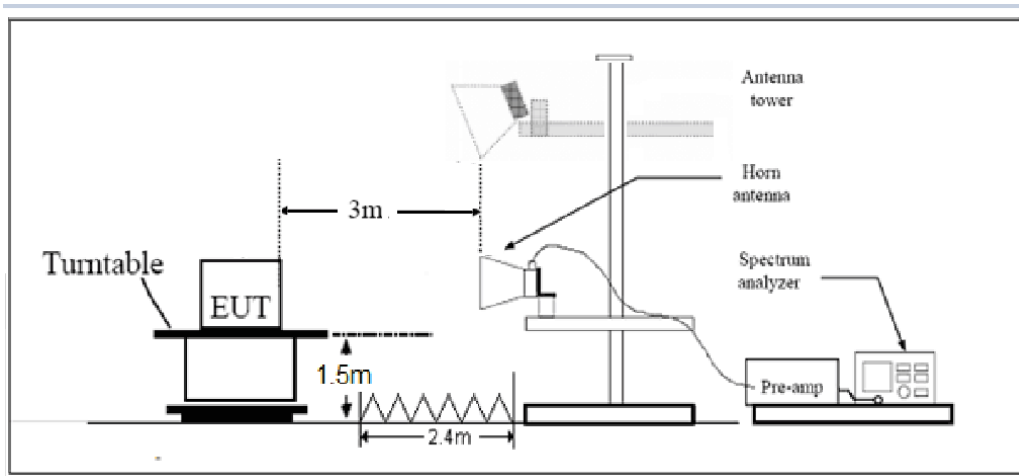

Note: Area side:2.4mX3.6m

Limits

Rule Part 22.917(a) specifies that “The power of any emission outside of the authorized operating frequency ranges must be attenuated below the transmitting power (P) by a factor of at least $43 + 10 \log (P)$ dB.”

Limit	-13 dBm
-------	---------

Measurement Uncertainty

The assessed measurement uncertainty to ensure 95% confidence level for the normal distribution is with the coverage factor $k = 1.96$, $U = 3.55$ dB.

Test Result

Sweep the whole frequency band through the range from 9kHz to the 10th harmonic of the carrier, the emissions below the noise floor will not be recorded in the report.

GSM 850 CH-Middle

Harmonic	Frequency (MHz)	SG (dBm)	Cable Loss (dB)	Gain (dBi)	Antenna Polarization	ERP Level (dBm)	Limit (dBm)	Margin (dB)	Azimuth (deg)
2	1673.20	-49.27	1.70	8.70	Horizontal	-44.42	-13.00	31.42	45
3	2509.90	-38.65	2.30	12.00	Horizontal	-31.10	-13.00	18.10	0
4	3346.40	-54.18	2.70	12.70	Horizontal	-46.33	-13.00	33.33	45
5	4183.00	-57.69	3.00	12.50	Horizontal	-50.34	-13.00	37.34	135
6	5019.60	-57.83	3.40	12.50	Horizontal	-50.88	-13.00	37.88	180
7	5856.20	-58.14	3.40	12.80	Horizontal	-50.89	-13.00	37.89	315
8	6692.80	-57.13	4.10	11.50	Horizontal	-51.88	-13.00	38.88	90
9	7529.40	-54.36	4.20	12.20	Horizontal	-48.51	-13.00	35.51	45
10	8366.00	-53.38	4.30	12.50	Horizontal	-47.33	-13.00	34.33	225

Note: 1.The other Spurious RF Radiated emissions level is no more than noise floor.
2.The worst emission was found in the antenna is Horizontal position.

WCDMA Band V CH-Middle

Harmonic	Frequency (MHz)	SG (dBm)	Cable Loss (dB)	Gain (dBi)	Antenna Polarization	ERP Level (dBm)	Limit (dBm)	Margin (dB)	Azimuth (deg)
2	1673.20	-66.10	1.70	8.70	Horizontal	-61.25	-13.00	48.25	45
3	2509.80	-65.79	2.30	12.00	Horizontal	-58.24	-13.00	45.24	225
4	3346.40	-63.12	2.70	12.70	Horizontal	-55.27	-13.00	42.27	225
5	4183.00	-62.84	3.00	12.50	Horizontal	-55.49	-13.00	42.49	270
6	5019.60	-58.56	3.40	12.50	Horizontal	-51.61	-13.00	38.61	315
7	5856.20	-59.36	3.40	12.80	Horizontal	-52.11	-13.00	39.11	90
8	6692.80	-57.41	4.10	11.50	Horizontal	-52.16	-13.00	39.16	45
9	7529.40	-53.69	4.20	12.20	Horizontal	-47.84	-13.00	34.84	225
10	8366.00	-53.49	4.30	12.50	Horizontal	-47.44	-13.00	34.44	90

Note: 1.The other Spurious RF Radiated emissions level is no more than noise floor.
2.The worst emission was found in the antenna is Horizontal position.

LTE Band 5 1.4MHz CH-Middle

Harmonic	Frequency (MHz)	SG (dBm)	Cable Loss (dB)	Gain (dBi)	Antenna Polarization	ERP Level (dBm)	Limit (dBm)	Margin (dB)	Azimuth (deg)
2	1673.00	-56.81	1.70	8.70	Horizontal	-51.96	-13.00	38.96	225
3	2509.50	-55.19	2.30	12.00	Horizontal	-47.64	-13.00	34.64	90
4	3343.20	-52.50	2.70	12.70	Horizontal	-44.65	-13.00	31.65	135
5	4179.00	-54.00	3.00	12.50	Horizontal	-46.65	-13.00	33.65	270
6	5014.80	-58.68	3.40	12.50	Horizontal	-51.73	-13.00	38.73	45
7	5850.60	-61.26	3.40	12.80	Horizontal	-54.01	-13.00	41.01	315
8	6686.40	-55.28	4.10	11.50	Horizontal	-50.03	-13.00	37.03	0
9	7522.20	-46.51	4.20	12.20	Horizontal	-40.66	-13.00	27.66	180
10	8358.00	-47.71	4.30	12.50	Horizontal	-41.66	-13.00	28.66	45

Note: 1.The other Spurious RF Radiated emissions level is no more than noise floor.

2.The worst emission was found in the antenna is Horizontal position.

LTE Band 5 5MHz CH-Middle

Harmonic	Frequency (MHz)	SG (dBm)	Cable Loss (dB)	Gain (dBi)	Antenna Polarization	ERP Level (dBm)	Limit (dBm)	Margin (dB)	Azimuth (deg)
2	1668.60	-56.93	1.70	8.70	Horizontal	-52.08	-13.00	39.08	0
3	2503.30	-55.75	2.30	12.00	Horizontal	-48.20	-13.00	35.20	135
4	3336.00	-51.57	2.70	12.70	Horizontal	-43.72	-13.00	30.72	135
5	4170.00	-53.14	3.00	12.50	Horizontal	-45.79	-13.00	32.79	90
6	5004.00	-59.60	3.40	12.50	Horizontal	-52.65	-13.00	39.65	270
7	5838.00	-61.06	3.40	12.80	Horizontal	-53.81	-13.00	40.81	0
8	6672.00	-55.38	4.10	11.50	Horizontal	-50.13	-13.00	37.13	225
9	7506.00	-45.89	4.20	12.20	Horizontal	-40.04	-13.00	27.04	45
10	8340.00	-44.02	4.30	12.50	Horizontal	-37.97	-13.00	24.97	315

Note: 1.The other Spurious RF Radiated emissions level is no more than noise floor.

2.The worst emission was found in the antenna is Horizontal position.

LTE Band 5 10MHz CH-Middle

Harmonic	Frequency (MHz)	SG (dBm)	Cable Loss (dB)	Gain (dBi)	Antenna Polarization	ERP Level (dBm)	Limit (dBm)	Margin (dB)	Azimuth (deg)
2	1664.40	-55.43	1.70	8.70	Horizontal	-50.58	-13.00	37.58	45
3	2496.60	-55.42	2.30	12.00	Horizontal	-47.87	-13.00	34.87	315
4	3326.00	-53.06	2.70	12.70	Horizontal	-45.21	-13.00	32.21	0
5	4157.50	-53.13	3.00	12.50	Horizontal	-45.78	-13.00	32.78	135
6	4989.00	-59.94	3.40	12.50	Horizontal	-52.99	-13.00	39.99	180
7	5820.50	-61.49	3.40	12.80	Horizontal	-54.24	-13.00	41.24	45
8	6652.00	-54.20	4.10	11.50	Horizontal	-48.95	-13.00	35.95	225
9	7483.50	-45.75	4.20	12.20	Horizontal	-39.90	-13.00	26.90	90
10	8315.00	-43.78	4.30	12.50	Horizontal	-37.73	-13.00	24.73	315

Note: 1.The other Spurious RF Radiated emissions level is no more than noise floor.

2.The worst emission was found in the antenna is Horizontal position.

6. Main Test Instruments

Name	Manufacturer	Type	Serial Number	Calibration Date	Expiration Date
Base Station Simulator	R&S	CMW500	113645	2021-05-15	2022-05-14
Power Splitter	Hua Xiang	SHX-GF2-2-13	10120101	/	/
Spectrum Analyzer	Key sight	N9010A	MY50210259	2020-12-13	2021-12-12
Universal Radio Communication Tester	Key sight	E5515C	MY48367192	2021-05-15	2022-05-14
Signal Analyzer	R&S	FSV3030	101411	2020-12-13	2021-12-12
Loop Antenna	SCHWARZBECK	FMZB1519	1519-047	2020-04-02	2023-04-01
TRILOG Broadband Antenna	SCHWARZBECK	VULB 9163	391	2019-12-16	2021-12-15
Horn Antenna	R&S	HF907	100125	2020-05-25	2023-05-24
Horn Antenna	ETS-Lindgren	3160-09	00102644	2018-06-20	2023-06-19
Signal generator	R&S	SMB 100A	180235	2021-05-15	2022-05-14
Climatic Chamber	ESPEC	SU-242	93000506	2020-12-13	2021-12-12
Preamplifier	R&S	SCU18	102327	2021-05-15	2022-05-14
MOB COMMS DC SUPPLY	Keysight	66319D	MY43004105	2021-05-15	2022-05-14
RF Cable	Agilent	SMA 15cm	0001	2021-06-09	2021-12-08
Software	R&S	EMC32	9.26.0	/	/

*****END OF REPORT *****

ANNEX A: The EUT Appearance

The EUT Appearance are submitted separately.

ANNEX B: Test Setup Photos

The Test Setup Photos are submitted separately.

ANNEX C: Product Change Description (Variant1)

The Product Change Description are submitted separately.

ANNEX D: Product Change Description (Variant2)

The Product Change Description are submitted separately.