



RF TEST REPORT

Applicant ZTE Corporation
FCC ID SRQ-A31PLUS2
Product LTE/WCDMA/GSM(GPRS)
Multi-Mode Digital Mobile Phone
Model ZTE Blade A31 Plus
Report No. R2110A0943-R4
Issue Date November 24, 2021

TA Technology (Shanghai) Co., Ltd. tested the above equipment in accordance with the requirements in **FCC CFR47 Part 2 (2020)/ FCC CFR47 Part 27C (2020)**. The test results show that the equipment tested is capable of demonstrating compliance with the requirements as documented in this report.

Prepared by: Peng Tao

Approved by: Kai Xu

TA Technology (Shanghai) Co., Ltd.

No.145, Jintang Rd, Tangzhen Industry Park, Pudong Shanghai, China

TEL: +86-021-50791141/2/3

FAX: +86-021-50791141/2/3-8000



TABLE OF CONTENT

1	Test Laboratory	4
1.1	Notes of the Test Report	4
1.2.	Test facility	4
1.3	Testing Location	4
2	General Description of Equipment under Test	5
2.1	Applicant and Manufacturer Information	5
2.2	General information	5
3	Applied Standards	7
4	Test Configuration	8
5	Test Case Results	9
5.1	RF Power Output and Effective Isotropic Radiated Power	9
5.2	Occupied Bandwidth	12
5.3	Band Edge Compliance	16
5.4	Peak-to-Average Power Ratio (PAPR)	22
5.5	Frequency Stability	24
5.6	Spurious Emissions at Antenna Terminals	26
5.7	Radiates Spurious Emission	29
6	Main Test Instruments	34
ANNEX A: The EUT Appearance		35
ANNEX B: Test Setup Photos		36



Summary of Measurement Results

Number	Test Case	Clause in FCC rules	Verdict
1	RF Power Output and Effective Isotropic Radiated Power	2.1046 27.50(b)(10)	PASS
2	Occupied Bandwidth	2.1049	PASS
3	Band Edge Compliance	27.53(f) /27.53(c)	PASS
4	Peak-to-Average Power Ratio	27.50(d)/KDB971168 D01(5.7)	PASS
5	Frequency Stability	2.1055 / 27.54	PASS
6	Spurious Emissions at Antenna Terminals	2.1051 27.53(f) /27.53(c)	PASS
7	Radiates Spurious Emission	2.1053 27.53(f) /27.53(c)	PASS

Date of Testing: October 30, 2021 ~ November 2, 2021
Date of Sample Received: August 1, 2021

Note: PASS: The EUT complies with the essential requirements in the standard.
FAIL: The EUT does not comply with the essential requirements in the standard.
All indications of Pass/Fail in this report are opinions expressed by TA Technology (Shanghai) Co., Ltd. based on interpretations and/or observations of test results. Measurement Uncertainties were not taken into account and are published for informational purposes only.

ZTE Blade A31 Plus (Report No.: R2110A0943-R4) is a variant model of ZTE Blade A31 Plus (Report No.: R2108A0671-R8). This product only added LTE Band 12/17, changed Software Version and changed to dual card slots. Test values partial duplicated from Original for variant. The power has been verified and there is no worse than the original, so it didn't record in this report. The detailed product change description please refers to the Difference Declaration Letter.



1 Test Laboratory

1.1 Notes of the Test Report

This report shall not be reproduced in full or partial, without the written approval of **TA technology (shanghai) co., Ltd.** The results documented in this report apply only to the tested sample, under the conditions and modes of operation as described herein .Measurement Uncertainties were not taken into account and are published for informational purposes only. This report is written to support regulatory compliance of the applicable standards stated above.

1.2. Test facility

FCC (Designation number: CN1179, Test Firm Registration Number: 446626)

TA Technology (Shanghai) Co., Ltd. has been listed on the US Federal Communications Commission list of test facilities recognized to perform measurements.

A2LA (Certificate Number: 3857.01)

TA Technology (Shanghai) Co., Ltd. has been listed by American Association for Laboratory Accreditation to perform measurement.

1.3 Testing Location

Company: TA Technology (Shanghai) Co., Ltd.
Address: No.145, Jintang Rd, Tangzhen Industry Park, Pudong Shanghai, China
City: Shanghai
Post code: 201201
Country: P. R. China
Contact: Xu Kai
Telephone: +86-021-50791141/2/3
Fax: +86-021-50791141/2/3-8000
Website: <http://www.ta-shanghai.com>
E-mail: xukai@ta-shanghai.com

2 General Description of Equipment under Test

2.1 Applicant and Manufacturer Information

Applicant	ZTE Corporation
Applicant address	ZTE Plaza, Keji Road South, Hi-Tech, Industrial Park, Nanshan District, Shenzhen, Guangdong, 518057, P.R.China
Manufacturer	ZTE Corporation
Manufacturer address	ZTE Plaza, Keji Road South, Hi-Tech, Industrial Park, Nanshan District, Shenzhen, Guangdong, 518057, P.R.China

2.2 General information

EUT Description			
Model	ZTE Blade A31 Plus		
IMEI	IMEI 1: 866591060000396 IMEI 2: 866591060001543		
Hardware Version	z1kA		
Software Version	GEN_LA_A31_Plus_V1.0		
Power Supply	Battery / AC adapter		
Antenna Type	Internal Antenna		
Antenna Gain	-4.1dBi		
Test Mode(s)	LTE Band 13		
Test Modulation	(LTE)QPSK, 16QAM, 64QAM;		
LTE Category	5		
Maximum E.I.R.P./ E.R.P.	LTE Band 13:	16.24dBm	
Rated Power Supply Voltage	3.8V		
Operating Voltage	Minimum: 3.4V Maximum: 4.35V		
Operating Temperature	Lowest: -10°C Highest: +55°C		
Extreme Temperature	Lowest: -30°C Highest: +50°C		
Operating Frequency Range(s)	Mode	Tx (MHz)	Rx (MHz)
	LTE Band 13	777 ~ 787	746 ~ 756
EUT Accessory			
Adapter 1	Manufacturer: Shenzhen Ruijing Industrial Co Ltd Model: STC-A51D-Z		
Adapter 2	Manufacturer: HUIZHOU PUAN ELECTRONICS CO.,LTD Model: STC-A51D-Z		
Battery	Manufacturer: Guangdong Fenghua New Energy Co.,Ltd. Model: Li3830T43P8h486375		
Earphone 1	Manufacturer: Shenzhen FDC Electronics Co. ,Ltd. Model: DEM-8A		



Earphone 2	Manufacturer: JUWEI ELECTRONICS CO., LTD Model: JWEP1091-Z01
USB Cable 1	Manufacturer: Dongguan Guojun Plastic Electronic Co.,Ltd Model: USB-MU5-B-70-M-L
USB Cable 2	Manufacturer: Shenzhen Yihuaxing Electronic Co., Ltd. Model: USB-MU5-B-70-M-L
<p>Note: 1. The EUT is sent from the applicant to TA and the information of the EUT is declared by the applicant.</p> <p>2. There are more than one Adapter, Earphone and USB Cable, each one should be applied throughout the compliance test respectively, however, only the worst case (Adapter 1, Earphone 2 and USB Cable 1) will be recorded in this report.</p>	



3 Applied Standards

According to the specifications of the manufacturer, it must comply with the requirements of the following standards:

Test standards:

FCC CFR47 Part 27C (2020)

FCC CFR47 Part 2 (2020)

Reference standard:

ANSI C63.26 (2015)

KDB 971168 D01 Power Meas License Digital Systems v03r01

4 Test Configuration

Radiated measurements are performed by rotating the EUT in three different orthogonal test planes. EUT stand-up position (Z axis), lie-down position (X, Y axis). Receiver antenna polarization (horizontal and vertical), the worst emission was found in position (X axis, horizontal polarization) and the worst case was recorded.

All mode and data rates and positions and RB size and modulations were investigated.

Subsequently, only the worst case emissions are reported.

The following testing in LTE is set based on the maximum RF Output Power.

The following testing in different Bandwidth is set to detail in the following table:

Test modes are chosen to be reported as the worst case configuration below for LTE Band 13:

Test items	Modes	Bandwidth (MHz)						Modulation		RB			Test Channel		
		1.4	3	5	10	15	20	QPSK	16QAM/ 64QAM	1	50%	100%	L	M	H
RF Power Output and Effective Isotropic Radiated Power	LTE 13	-	-	O	O	-	-	O	O	O	O	O	O	O	O
Occupied Bandwidth	LTE 13	-	-	O	O	-	-	O	O			O	O	O	O
Band Edge Compliance	LTE 13	-	-	O	O	-	-	O	O	O	-	O	O	-	O
Peak-to-Average Power Ratio	LTE 13	-	-	O	O	-	-	O	O	-	-	O	O	O	O
Frequency Stability	LTE 13	-	-	O	O	-	-	O	O	O	-	-	-	O	-
Spurious Emissions at Antenna Terminals	LTE 13	-	-	O	O	-	-	O	-	O	-	-	O	O	O
Radiates Spurious Emission	LTE 13	-	-	O	O	-	-	O	-	O	-	-	-	O	-
Note	1. The mark "O" means that this configuration is chosen for testing. 2. The mark "-" means that this configuration is not testing.														

5 Test Case Results

5.1 RF Power Output and Effective Isotropic Radiated Power

Ambient condition

Temperature	Relative humidity	Pressure
23°C ~25°C	45%~50%	101.5kPa

Methods of Measurement

During the process of the testing, The EUT was connected to the Base Station Simulator with a known loss. The EUT is controlled by the Base Station Simulator test set to ensure max power transmission with proper modulation.

ERP can then be calculated as follows:

$$\text{EIRP (dBm)} = \text{Output Power (dBm)} - \text{Losses (dB)} + \text{Antenna Gain (dBi)}$$

where:dBd refers to gain relative to an ideal dipole.

$$\text{EIRP (dBm)} = \text{ERP (dBm)} + 2.15 \text{ (dB.)}$$

Test Setup

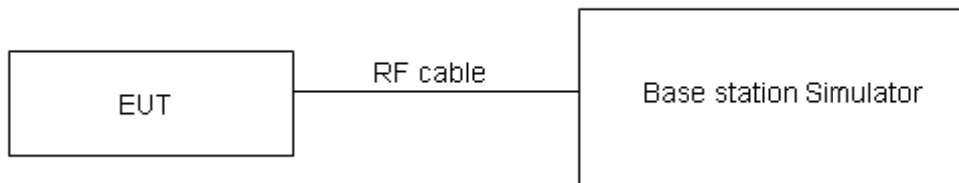

Limits

No specific RF power output requirements in part 2.1046.

Rule Part 27.50(b) (10) specifies that “Portable stations (hand-held devices) transmitting in the 746-757 MHz, 776-788 MHz, and 805-806 MHz bands are limited to 3 watts ERP”

Part 27.50(b)(10)Limit	$\leq 3 \text{ W} \text{ (34.77 dBm)}$
------------------------	--

Measurement Uncertainty

The assessed measurement uncertainty to ensure 95% confidence level for the normal distribution is with the coverage factor $k = 2$, $U=0.4 \text{ dB}$ for RF power output, $k = 2$, $U= 1.19 \text{ dB}$ for ERP/EIRP.



Test Results

LTE Band 13				Maximum Output Power(dBm)			ERP (dBm)		
BW	Modulation	RB size	RB offset	Channel/Frequency(MHz)					
				23205/ 779.5	23230/ 782	23255/ 784.5	23205/ 779.5	23230/ 782	23255/ 784.5
5MHz	QPSK	1	0	22.22	22.29	22.37	15.97	16.04	16.12
		1	13	22.22	22.22	22.26	15.97	15.97	16.01
		1	24	22.36	22.38	22.49	16.11	16.13	16.24
		12	0	21.15	21.19	21.28	14.90	14.94	15.03
		12	6	21.28	21.32	21.42	15.03	15.07	15.17
		12	13	21.50	21.54	21.65	15.25	15.29	15.40
		25	0	21.10	21.17	21.25	14.85	14.92	15.00
	16QAM	1	0	21.55	21.58	21.65	15.30	15.33	15.40
		1	13	21.53	21.54	21.63	15.28	15.29	15.38
		1	24	21.66	21.71	21.79	15.41	15.46	15.54
		12	0	20.37	20.38	20.46	14.12	14.13	14.21
		12	6	20.45	20.48	20.60	14.20	14.23	14.35
		12	13	20.59	20.63	20.72	14.34	14.38	14.47
		25	0	20.32	20.36	20.46	14.07	14.11	14.21
	64QAM	1	0	20.40	20.47	20.60	14.15	14.22	14.35
		1	13	20.45	20.50	20.59	14.20	14.25	14.34
		1	24	20.49	20.54	20.66	14.24	14.29	14.41
		12	0	19.16	19.17	19.25	12.91	12.92	13.00
		12	6	19.33	19.36	19.48	13.08	13.11	13.23
		12	13	19.36	19.40	19.49	13.11	13.15	13.24
		25	0	19.22	19.26	19.36	12.97	13.01	13.11
BW	Modulation	RB size	RB offset	Channel/Frequency(MHz)					
				/	23230/ 782	/	/	23230/ 782	/
10MHz	QPSK	1	0	/	22.17	/	/	15.92	/
		1	25	/	22.20	/	/	15.95	/
		1	49	/	22.30	/	/	16.05	/
		25	0	/	21.16	/	/	14.91	/
		25	13	/	21.24	/	/	14.99	/
		25	25	/	21.44	/	/	15.19	/
		50	0	/	21.09	/	/	14.84	/



	16QAM	1	0	/	21.52	/	/	15.27	/
		1	25	/	21.47	/	/	15.22	/
		1	49	/	21.61	/	/	15.36	/
		25	0	/	20.32	/	/	14.07	/
		25	13	/	20.38	/	/	14.13	/
		25	25	/	20.54	/	/	14.29	/
		50	0	/	20.28	/	/	14.03	/
	64QAM	1	0	/	20.32	/	/	14.07	/
		1	25	/	20.39	/	/	14.14	/
		1	49	/	20.44	/	/	14.19	/
		25	0	/	19.11	/	/	12.86	/
		25	13	/	19.26	/	/	13.01	/
		25	25	/	19.31	/	/	13.06	/
		50	0	/	19.18	/	/	12.93	/

5.2 Occupied Bandwidth

Ambient condition

Temperature	Relative humidity	Pressure
23°C ~25°C	45%~50%	101.5kPa

Method of Measurement

The EUT was connected to Spectrum Analyzer and Base Station Simulator via power Splitter. The occupied bandwidth is measured using spectrum analyzer.

RBW is set to $\geq 1\%EBW$, VBW is set to 3x RBW.

99% power and -26dBc occupied bandwidths are recorded. Spectrum analyzer plots are included on the following pages.

Test Setup

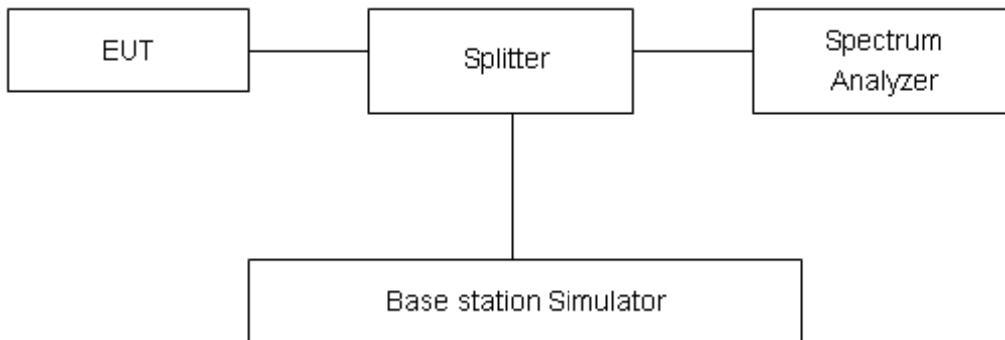

Limits

No specific occupied bandwidth requirements in part 2.1049.

Measurement Uncertainty

The assessed measurement uncertainty to ensure 95% confidence level for the normal distribution is with the coverage factor $k = 2$, $U=624\text{Hz}$.



Test Result

LTE Band 13						
RB	Modulation	Bandwidth (MHz)	Channel	Frequency (MHz)	99% Power Bandwidth(MHz)	-26dBc Bandwidth(MHz)
100%	QPSK	5	23205	779.5	4.500	4.888
			23230	782	4.513	5.002
			23255	784.5	4.515	4.928
		10	23230	782	9.036	9.809
	16QAM	5	23205	779.5	4.503	4.926
			23230	782	4.535	5.002
			23255	784.5	4.518	4.991
		10	23230	782	9.017	9.936
	64QAM	5	23205	779.5	4.498	4.983
			23230	782	4.538	4.957
			23255	784.5	4.534	4.970
		10	23230	782	9.034	9.920



LTE Band 13 QPSK 5MHz CH-Low

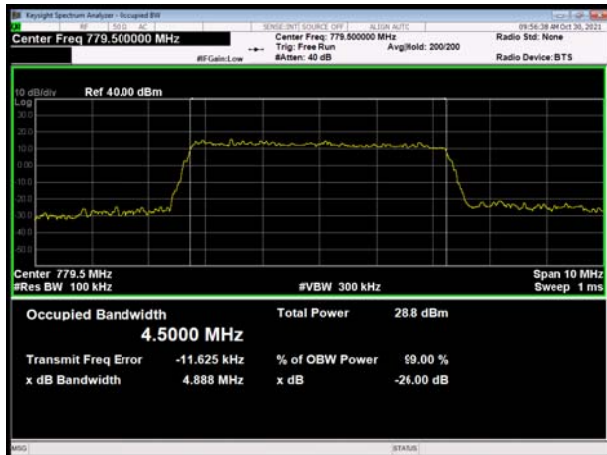

LTE Band 13 QPSK 5MHz CH-Middle

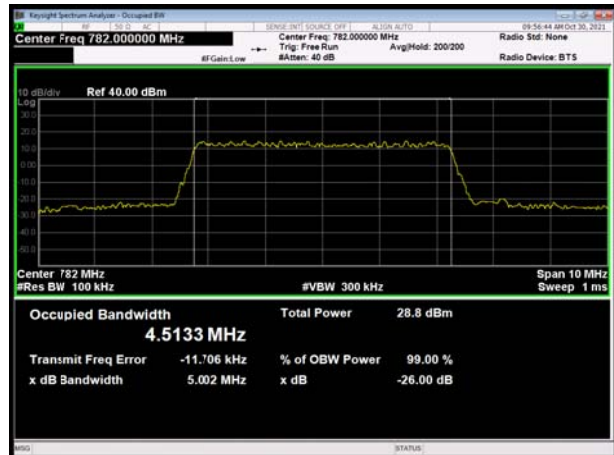

LTE Band 13 QPSK 5MHz CH-High

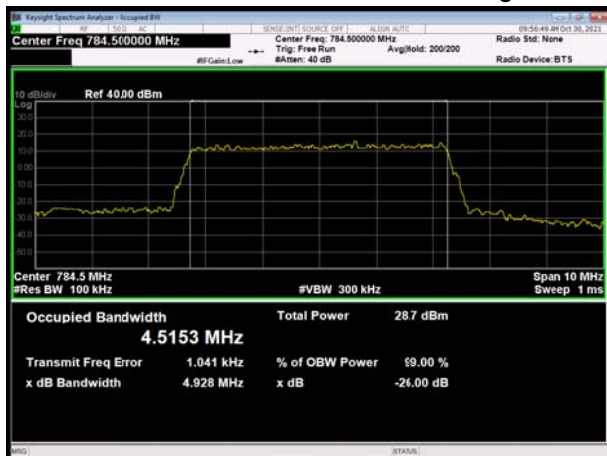

LTE Band 13 QPSK 10MHz CH-Middle



LTE Band 13 16QAM 5MHz CH-Low

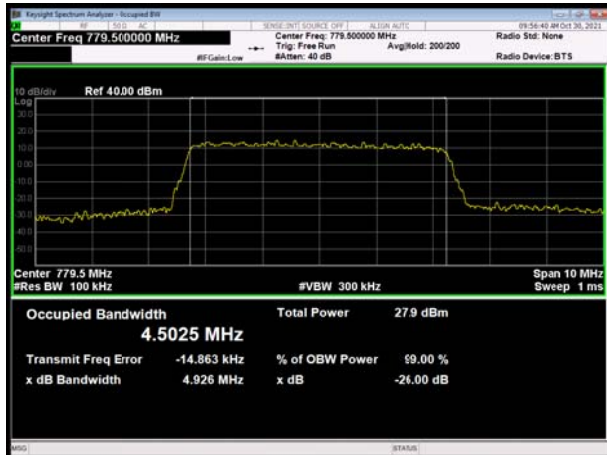

LTE Band 13 16QAM 5MHz CH-Middle

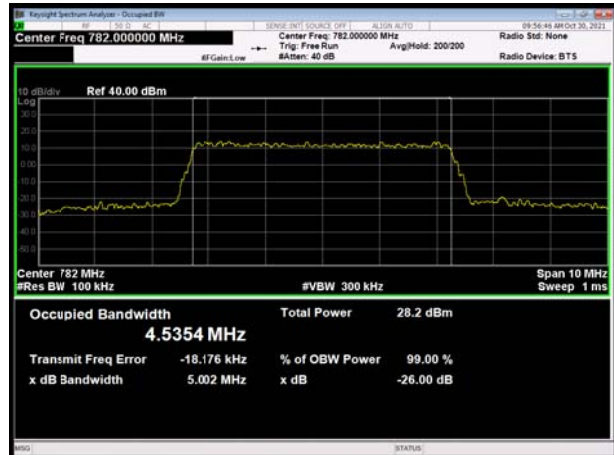



LTE Band 13 16QAM 5MHz CH-High

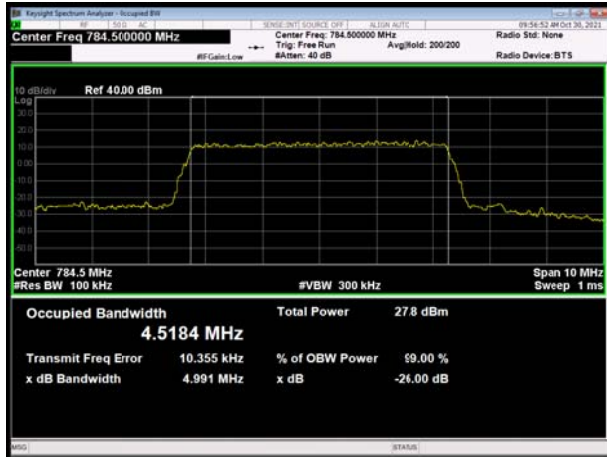

LTE Band 13 16QAM 10MHz CH-Middle

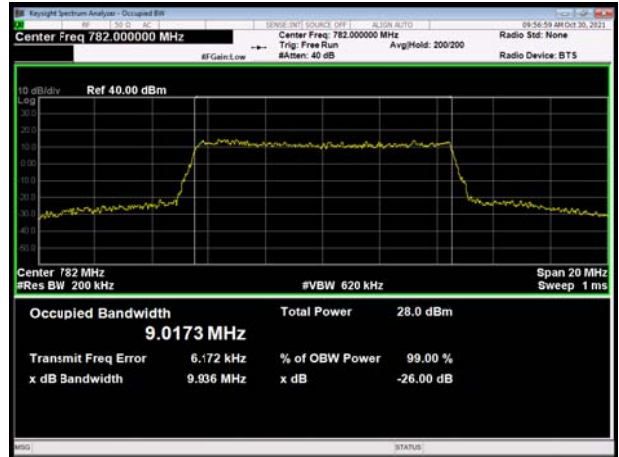

LTE Band 13 64QAM 5MHz CH-Low

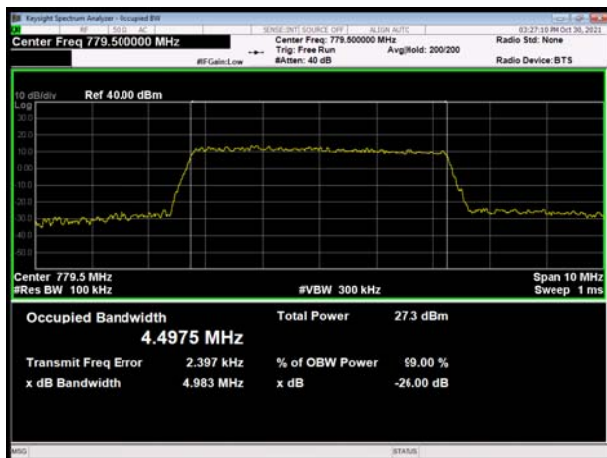

LTE Band 13 64QAM 5MHz CH-Middle



LTE Band 13 64QAM 5MHz CH-High

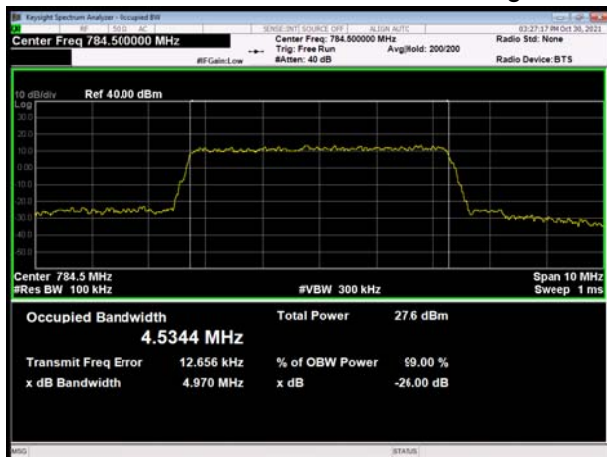

LTE Band 13 64QAM 10MHz CH-Middle



5.3 Band Edge Compliance

Ambient condition

Temperature	Relative humidity	Pressure
23°C ~25°C	45%~50%	101.5kPa

Method of Measurement

The EUT was connected to Spectrum Analyzer and Base Station Simulator via power Splitter. The band edge of the lowest and highest channels were measured.

The testing follows KDB 971168 D01 v03r01 Section 6.0

The EUT was connected to spectrum analyzer and system simulator via a power divider.

The band edges of low and high channels for the highest RF powers were measured.

RBW is set to $\geq 1\%EBW$, VBW is set to 3x RBW.

on spectrum analyzer.

Set spectrum analyzer with RMS detector.

The RF fundamental frequency should be excluded against the limit line in the operating frequency band.

Checked that all the results comply with the emission limit line.

Test Setup

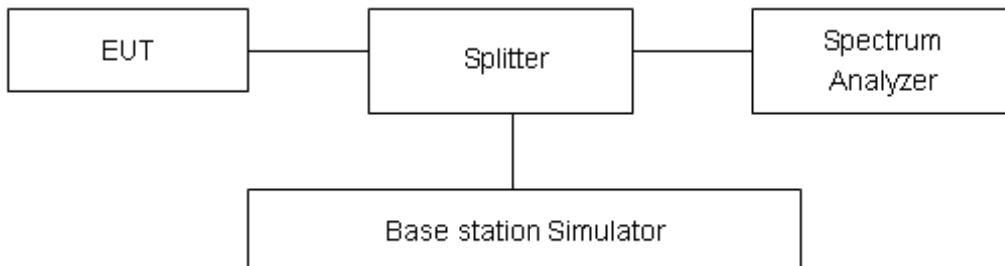

Limits

Rule Part 27.53(f) For operations in the 746-758 MHz, 775-788 MHz, and 805-806 MHz bands, emissions in the band 1559-1610 MHz shall be limited to -70 dBW/MHz equivalent isotropically radiated power (EIRP) for wideband signals, and -80 dBW EIRP for discrete emissions of less than 700 Hz bandwidth. For the purpose of equipment authorization, a transmitter shall be tested with an antenna that is representative of the type that will be used with the equipment in normal operation.

Rule Part 27.53 (c) For operations in the 746-758 MHz band and the 776-788 MHz band, the power of any emission outside the licensee's frequency band(s) of operation shall be attenuated below the transmitter power (P) within the licensed band(s) of operation, measured in watts, in accordance with the following:

- (1) On any frequency outside the 746-758 MHz band, the power of any emission shall be attenuated outside the band below the transmitter power (P) by at least $43 + 10 \log (P)$ dB;
- (2) On any frequency outside the 776-788 MHz band, the power of any emission shall be attenuated



outside the band below the transmitter power (P) by at least $43 + 10 \log (P)$ dB;

(3) On all frequencies between 763-775 MHz and 793-805 MHz, by a factor not less than $76 + 10 \log (P)$ dB in a 6.25 kHz band segment, for base and fixed stations;

(4) On all frequencies between 763-775 MHz and 793-805 MHz, by a factor not less than $65 + 10 \log (P)$ dB in a 6.25 kHz band segment, for mobile and portable stations;

(5) Compliance with the provisions of paragraphs (c)(1) and (c)(2) of this section is based on the use of measurement instrumentation employing a resolution bandwidth of 100 kHz or greater. However, in the 100 kHz bands immediately outside and adjacent to the frequency block, a resolution bandwidth of at least 30 kHz may be employed;

Measurement Uncertainty

The assessed measurement uncertainty to ensure 95% confidence level for the normal distribution is with the coverage factor $k = 1.96$, $U=0.684$ dB.

Test Result

All the test traces in the plots shows the test results clearly.

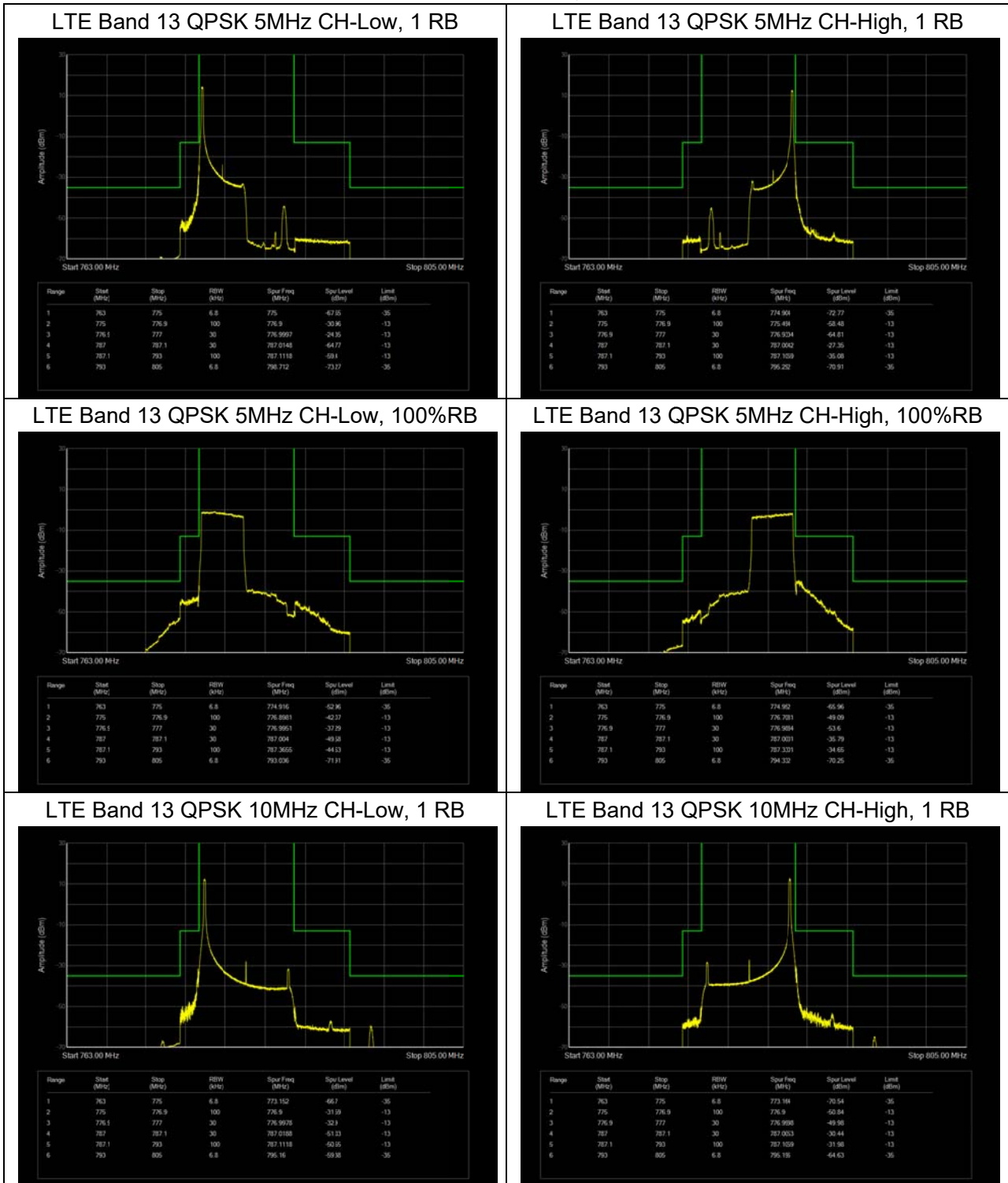



LTE Band 13 QPSK 10MHz CH-Low, 100%RB

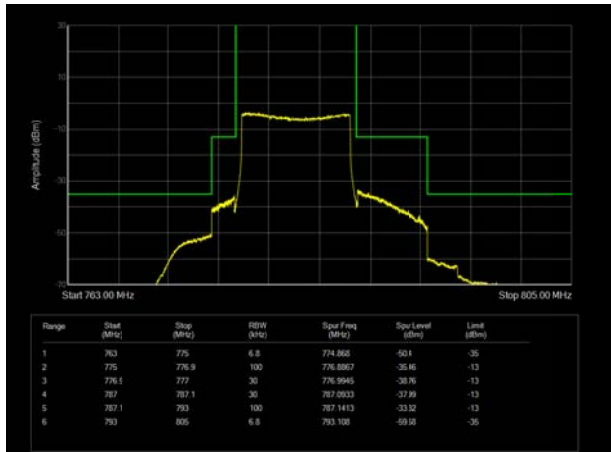

LTE Band 13 QPSK 10MHz CH-High, 100%RB

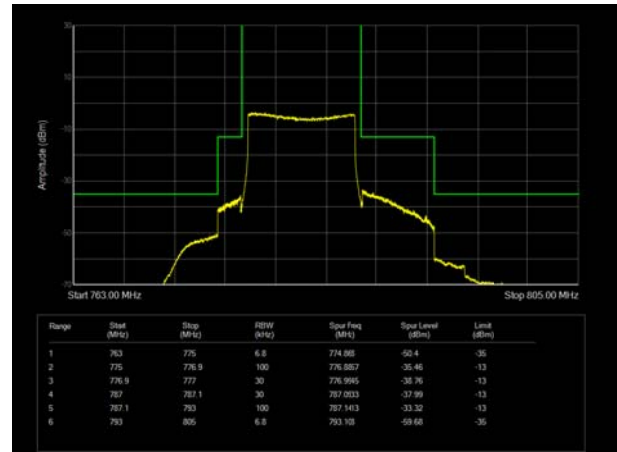

LTE Band 13 16QAM 5MHz CH-Low, 1 RB

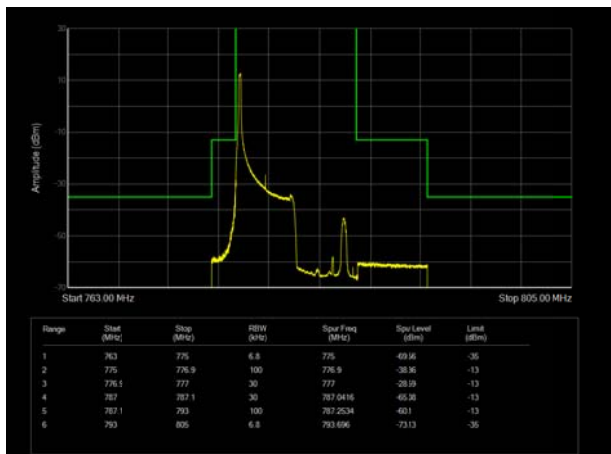

LTE Band 13 16QAM 5MHz CH-High, 1 RB

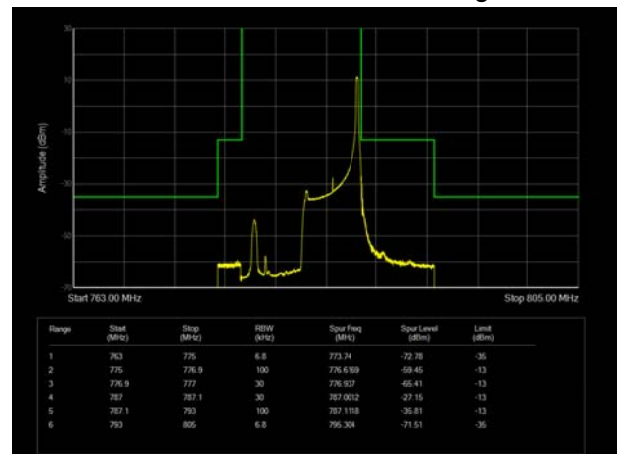

LTE Band 13 16QAM 5MHz CH-Low, 100%RB

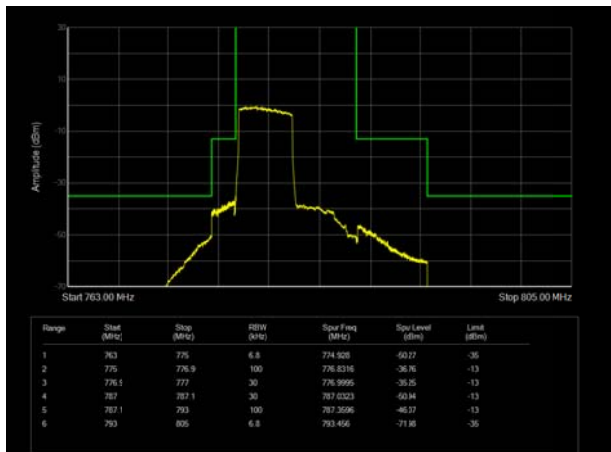

LTE Band 13 16QAM 5MHz CH-High, 100%RB

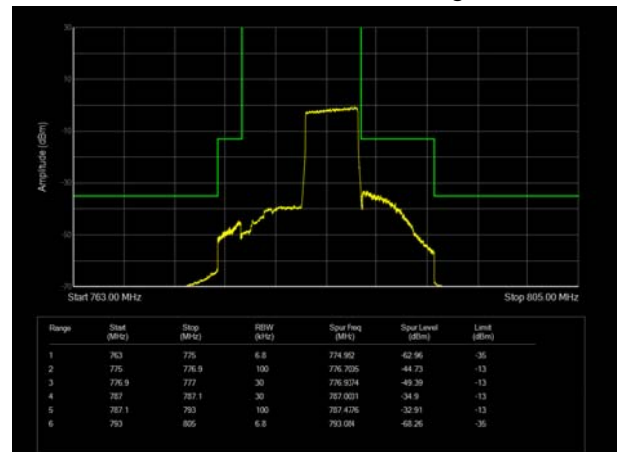

LTE Band 13 16QAM 10MHz CH-Low, 1 RB

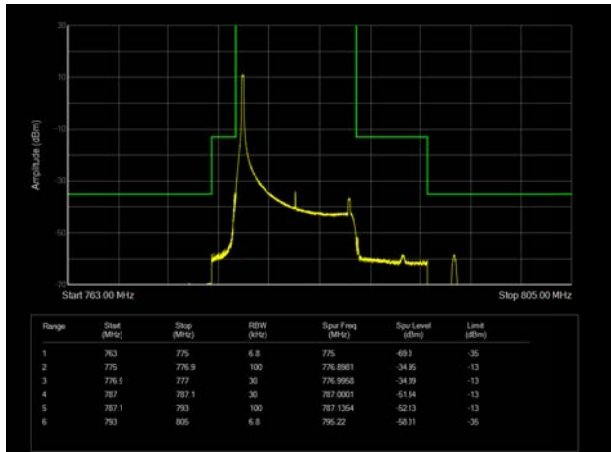

LTE Band 13 16QAM 10MHz CH-High, 1 RB

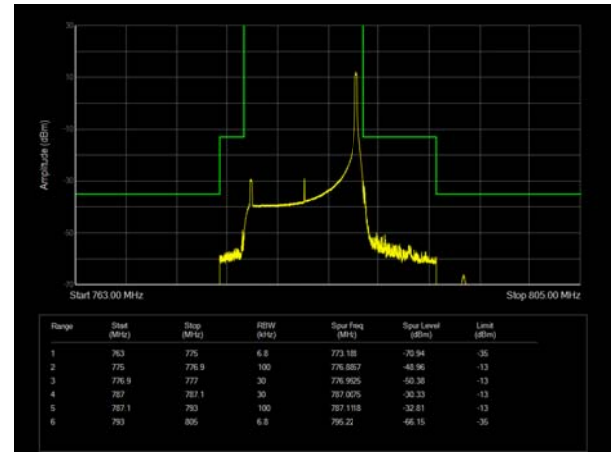

LTE Band 13 16QAM 10MHz CH-Low, 100%RB

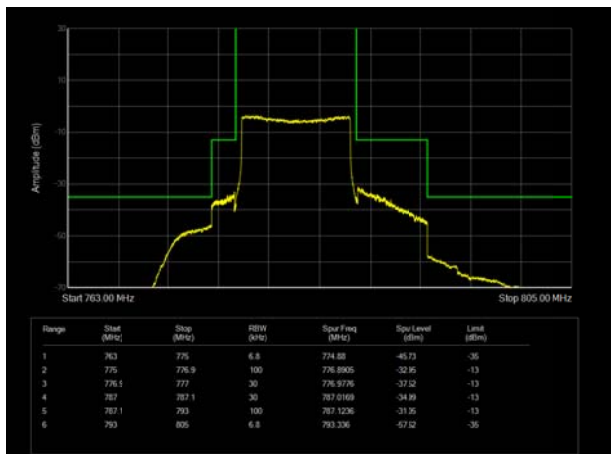

LTE Band 13 16QAM 10MHz CH-High, 100%RB

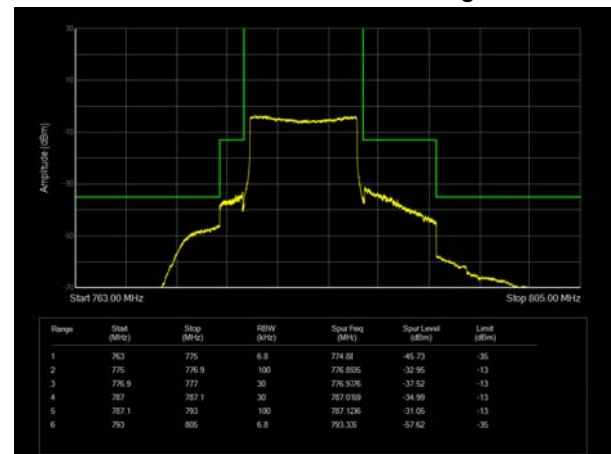

LTE Band 13 64QAM 5MHz CH-Low, 1 RB

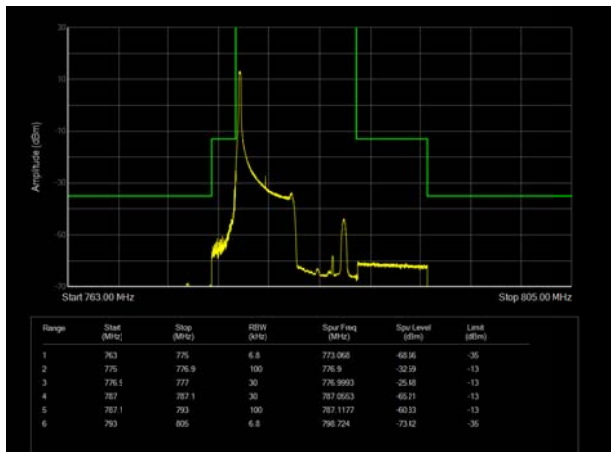

LTE Band 13 64QAM 5MHz CH-High, 1 RB

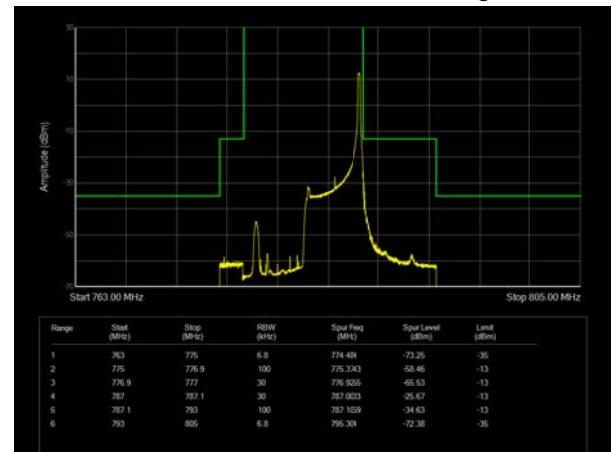

LTE Band 13 64QAM 5MHz CH-Low, 100%RB

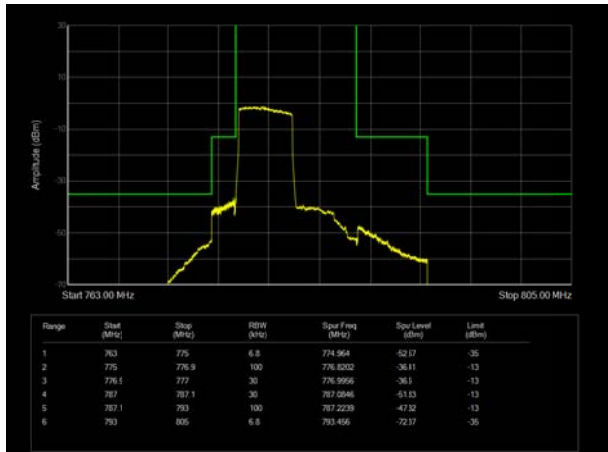

LTE Band 13 64QAM 5MHz CH-High, 100%RB

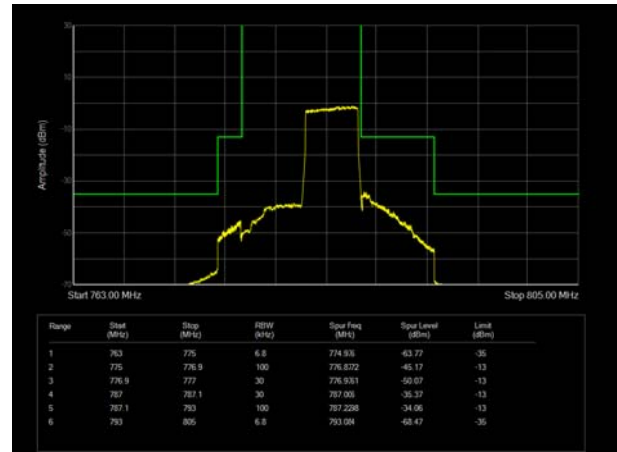

LTE Band 13 64QAM 10MHz CH-Low, 1 RB

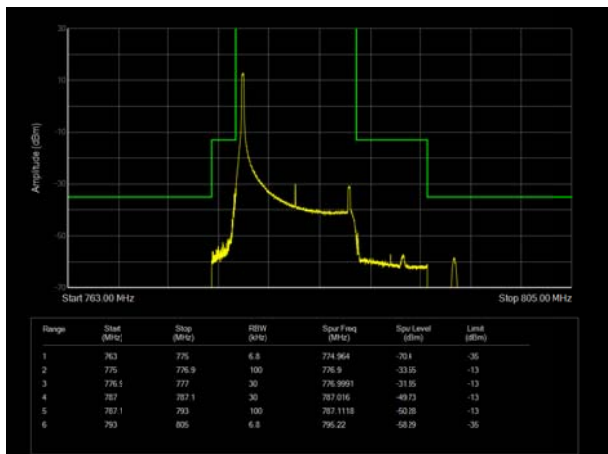

LTE Band 13 64QAM 10MHz CH-High, 1 RB

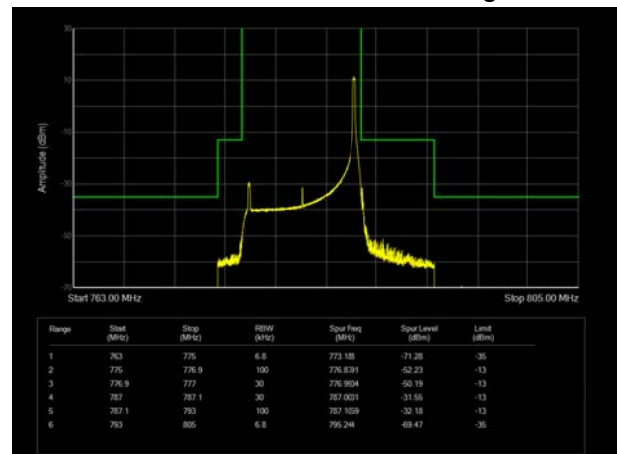

LTE Band 13 64QAM 10MHz CH-Low, 100%RB

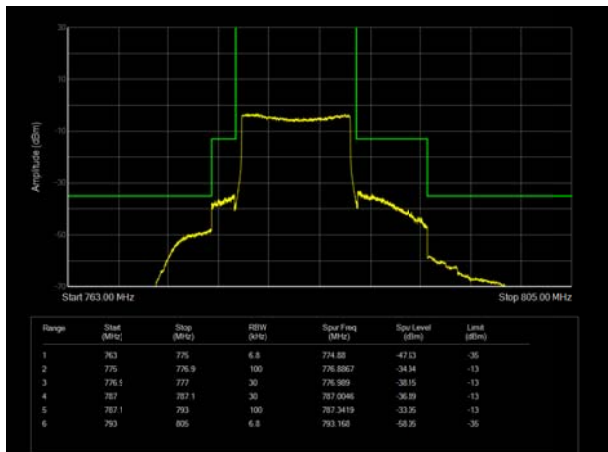

LTE Band 13 64QAM 10MHz CH-High, 100%RB

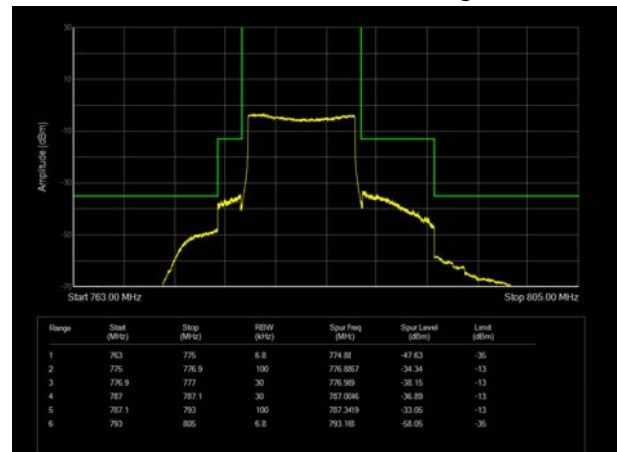

5.4 Peak-to-Average Power Ratio (PAPR)

Ambient condition

Temperature	Relative humidity	Pressure
23°C ~25°C	45%~50%	101.5kPa

Methods of Measurement

Measure the total peak power and record as PPk. And measure the total average power and record as PAvg. Both the peak and average power levels must be expressed in the same logarithmic units (e.g., dBm). Determine the PAPR from:

$$PAPR (dB) = PPk (dBm) - PAvg (dBm).$$

Test Setup

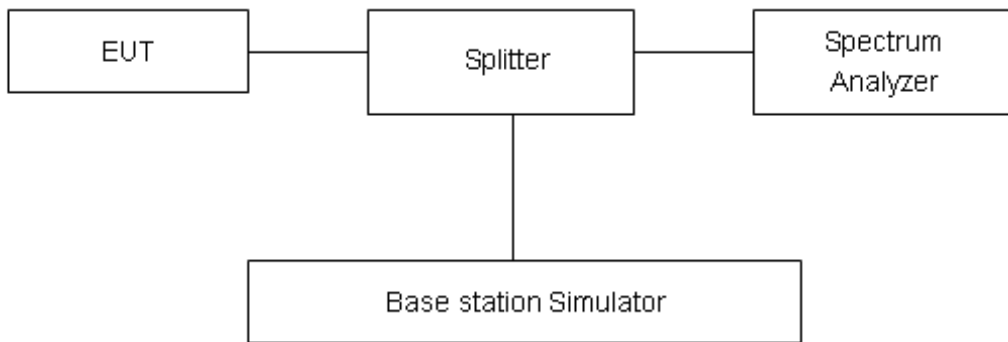

Limits

Rule Part 27.50(d)(5) Equipment employed must be authorized in accordance with the provisions of 24.51. Power measurements for transmissions by stations authorized under this section may be made either in accordance with a Commission-approved average power technique or in compliance with paragraph (d)(6) of this section. In measuring transmissions in this band using an average power technique, the peak-to-average ratio (PAR) of the transmission may not exceed 13 dB.

Measurement Uncertainty

The assessed measurement uncertainty to ensure 95% confidence level for the normal distribution is with the coverage factor $k = 2$, $U = 0.4$ dB.



Test Results

LTE Band 13								
Modulation	Bandwidth (MHz)	Channel	Frequency (MHz)	Peak (dBm)	Avg (dBm)	PAPR (dB)	Limit (dB)	Conclusion
QPSK	5	23205	779.5	26.15	20.90	5.25	≤13	PASS
		23230	782	26.40	20.66	5.74	≤13	PASS
		23255	784.5	26.36	20.73	5.63	≤13	PASS
	10	23230	782	26.45	20.74	5.71	≤13	PASS
16QAM	5	23205	779.5	25.83	19.83	6.00	≤13	PASS
		23230	782	26.46	20.08	6.38	≤13	PASS
		23255	784.5	26.19	19.81	6.38	≤13	PASS
	10	23230	782	26.44	20.10	6.34	≤13	PASS
64QAM	5	23205	779.5	25.47	19.45	6.02	≤13	PASS
		23230	782	26.18	19.91	6.27	≤13	PASS
		23255	784.5	25.70	19.35	6.35	≤13	PASS
	10	23230	782	26.15	19.86	6.29	≤13	PASS

5.5 Frequency Stability

Ambient condition

Temperature	Relative humidity	Pressure
23°C ~25°C	45%~50%	101.5kPa

Method of Measurement

Frequency Stability (Temperature Variation)

The temperature inside the climate chamber is varied from -30°C to +50°C in 10°C step size.

(1) With all power removed, the temperature was decreased to -10°C and permitted to stabilize for three hours.

(2) Measure the carrier frequency with the test equipment in a “call mode”. These measurements should be made within 1 minute of powering up the mobile station, to prevent significant self warming.

(3) Repeat the above measurements at 10°C increments from -30°C to +50°C. Allow at least 1.5 hours at each temperature, un-powered, before making measurements.

Frequency Stability (Voltage Variation)

The frequency stability shall be measured with variation of primary supply voltage as follows:

Primary Supply Voltage: The primary supply voltage is varied from 85% to 115% of the nominal value for non hand-carried battery and AC powered equipment. For hand-carried, battery-powered equipment, primary supply voltage is reduced to the battery operating end point which shall be specified by the manufacturer.

This transceiver is specified to operate with an input voltage of between 3.4 V and 4.35 V, with a nominal voltage of 3.8V.

Test setup

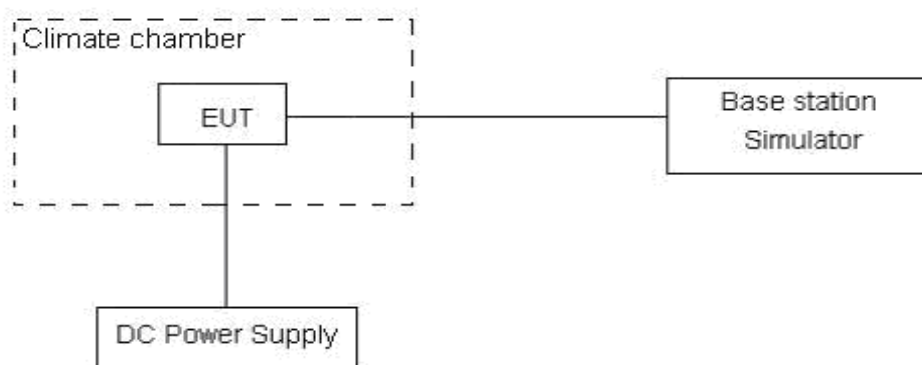

Limits

The frequency stability shall be sufficient to ensure that the fundamental emissions stay within the authorized bands of operation.

Measurement Uncertainty

The assessed measurement uncertainty to ensure 99.75% confidence level for the normal distribution is with the coverage factor $k = 3, U = 0.01\text{ppm}$.



Test Result

LTE Band 13								
Condition		Freq.Error (Hz)	Freq.Error (Hz)	Freq.Error (Hz)	Frequency Stability (ppm)	Frequency Stability (ppm)	Frequency Stability (ppm)	Verdict
BANDWIDTH	5MHz							
Temperature	Voltage	64QAM	16QAM	QPSK	64QAM	16QAM	QPSK	
Normal (25°C)	Normal	13.34	17.80	1.72	0.01706	0.02276	0.00219	PASS
Extreme (50°C)		8.69	5.92	14.27	0.01112	0.00757	0.01824	PASS
Extreme (40°C)		14.55	1.51	13.38	0.01861	0.00193	0.01711	PASS
Extreme (30°C)		14.69	3.33	10.64	0.01878	0.00425	0.01361	PASS
Extreme (20°C)		2.33	8.59	7.04	0.00298	0.01098	0.00901	PASS
Extreme (10°C)		16.36	3.85	17.98	0.02092	0.00492	0.02299	PASS
Extreme (0°C)		3.57	6.03	9.90	0.00456	0.00772	0.01266	PASS
Extreme (-10°C)		6.53	7.98	1.43	0.00835	0.01020	0.00183	PASS
Extreme (-20°C)		17.20	2.04	15.60	0.02200	0.00261	0.01994	PASS
Extreme (-30°C)		9.05	15.53	8.50	0.01158	0.01986	0.01087	PASS
25°C	LV	5.72	15.86	11.57	0.00731	0.02028	0.01479	PASS
	HV	12.66	9.84	10.42	0.01619	0.01259	0.01333	PASS
Condition		Freq.Error (Hz)	Freq.Error (Hz)	Freq.Error (Hz)	Frequency Stability (ppm)	Frequency Stability (ppm)	Frequency Stability (ppm)	Verdict
BANDWIDTH	10MHz							
Temperature	Voltage	64QAM	16QAM	QPSK	64QAM	16QAM	QPSK	
Normal (25°C)	Normal	1.09	4.18	12.24	0.00139	0.00535	0.01566	PASS
Extreme (50°C)		11.01	11.63	16.57	0.01407	0.01487	0.02119	PASS
Extreme (40°C)		13.71	10.32	7.00	0.01753	0.01319	0.00896	PASS
Extreme (30°C)		15.59	15.07	14.83	0.01993	0.01927	0.01896	PASS
Extreme (20°C)		10.26	2.58	15.26	0.01312	0.00330	0.01952	PASS
Extreme (10°C)		3.95	3.45	8.75	0.00505	0.00441	0.01119	PASS
Extreme (0°C)		9.77	3.95	17.96	0.01249	0.00505	0.02296	PASS
Extreme (-10°C)		3.64	7.48	10.69	0.00465	0.00957	0.01367	PASS
Extreme (-20°C)		13.59	8.43	16.71	0.01738	0.01078	0.02137	PASS
Extreme (-30°C)		12.97	10.44	9.52	0.01659	0.01335	0.01217	PASS
25°C	LV	12.01	9.78	9.70	0.01536	0.01251	0.01240	PASS
	HV	7.36	5.60	5.43	0.00941	0.00716	0.00695	PASS

5.6 Spurious Emissions at Antenna Terminals

Ambient condition

Temperature	Relative humidity	Pressure
23°C ~25°C	45%~50%	101.5kPa

Method of Measurement

The EUT was connected to Spectrum Analyzer and Base Station Simulator via power Splitter. The measurement is carried out using a spectrum analyzer. The spectrum analyzer scans from 9kHz to the 10th harmonic of the carrier. The peak detector is used.

RBW is set to 100kHz, VBW is set to 300kHz for 30MHz~1GHz

RBW is set to 1MHz, VBW is set to 3MHz for above 1GHz, Sweep is set to ATUO.

RBW is set to 1 kHz (0.009MHz~ 0.15 MHz),

RBW is set to 10 kHz (0.15 MHz~ 30 MHz)

RBW is set to 100 kHz (30MHz~1000 MHz)

RBW is set to 1000 kHz (above 1000MHz)

Of those disturbances below (limit – 20 dB), the mark is not required for the EUT.

The modulation mode and RB allocation refer to section 5.1, using the maximum output power configuration.

Test setup

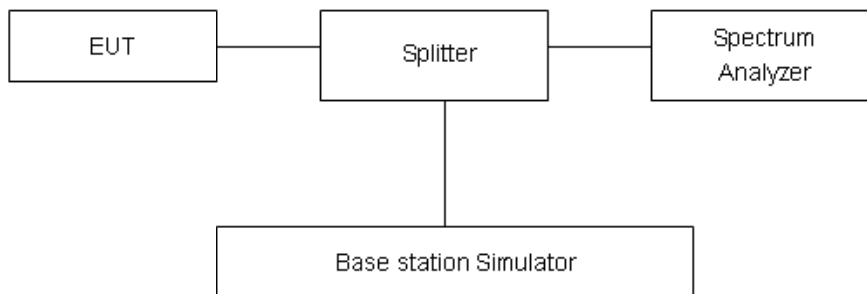

Limits

Rule Part 27.53(f) For operations in the 746-758 MHz, 775-788 MHz, and 805-806 MHz bands, emissions in the band 1559-1610 MHz shall be limited to -70 dBW/MHz equivalent isotropically radiated power (EIRP) for wideband signals, and -80 dBW EIRP for discrete emissions of less than 700 Hz bandwidth. For the purpose of equipment authorization, a transmitter shall be tested with an antenna that is representative of the type that will be used with the equipment in normal operation.

Part 27.53 (c) For operations in the 746-758 MHz band and the 776-788 MHz band, the power of any emission outside the licensee's frequency band(s) of operation shall be attenuated below the transmitter power (P) within the licensed band(s) of operation, measured in watts, in accordance with the following:

(1) On any frequency outside the 746-758 MHz band, the power of any emission shall be attenuated



- outside the band below the transmitter power (P) by at least $43 + 10 \log (P)$ dB;
- (2) On any frequency outside the 776-788 MHz band, the power of any emission shall be attenuated outside the band below the transmitter power (P) by at least $43 + 10 \log (P)$ dB;
- (3) On all frequencies between 763-775 MHz and 793-805 MHz, by a factor not less than $76 + 10 \log (P)$ dB in a 6.25 kHz band segment, for base and fixed stations;
- (4) On all frequencies between 763-775 MHz and 793-805 MHz, by a factor not less than $65 + 10 \log (P)$ dB in a 6.25 kHz band segment, for mobile and portable stations;
- (5) Compliance with the provisions of paragraphs (c)(1) and (c)(2) of this section is based on the use of measurement instrumentation employing a resolution bandwidth of 100 kHz or greater. However, in the 100 kHz bands immediately outside and adjacent to the frequency block, a resolution bandwidth of at least 30 kHz may be employed;

Part 27.53(f) Limit	Limit out of the band 1559-1610 MHz	-13 dBm
	Limit in the band 1559-1610 MHz	-40 dBm

Measurement Uncertainty

The assessed measurement uncertainty to ensure 99.75% confidence level for the normal distribution is with the coverage factor $k = 1.96$.

Frequency	Uncertainty
9kHz-1GHz	0.684 dB
1GHz-27GHz	1.407 dB



Test Result

Sweep the whole frequency band through the range from 9kHz to the 10th harmonic of the carrier, the emissions more than 20 dB below the limit are not reported.

The signal beyond the limit is carrier.

LTE Band 13 5MHz CH-Low 9kHz ~10GHz

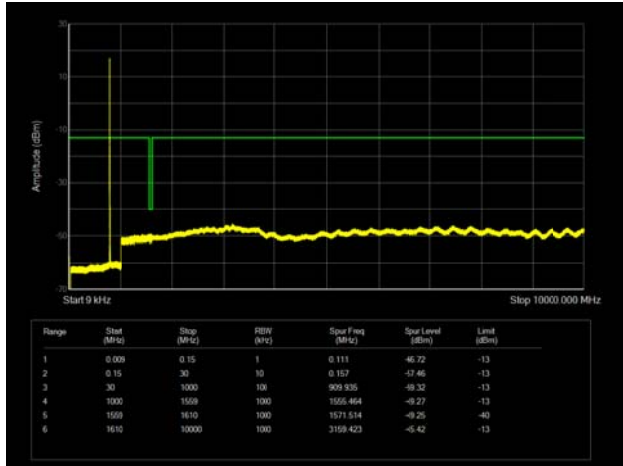

LTE Band 13 5MHz CH-Middle 9kHz ~10GHz

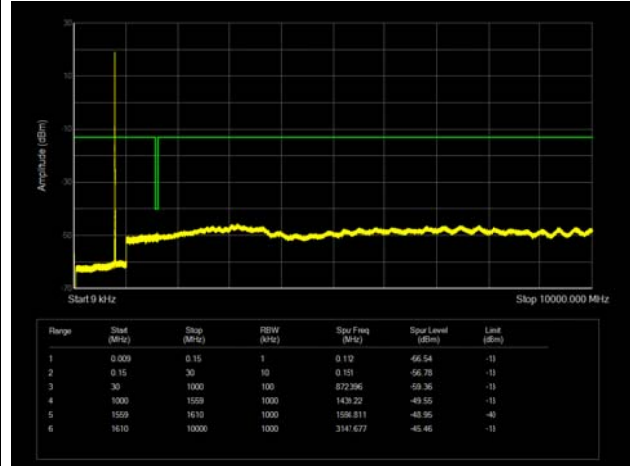

LTE Band 13 5MHz CH-High 9kHz ~10GHz

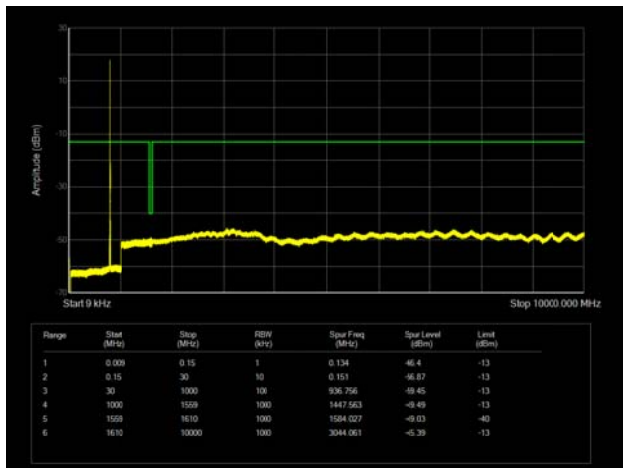

LTE Band 13 10MHz CH-Middle 9kHz ~10GHz

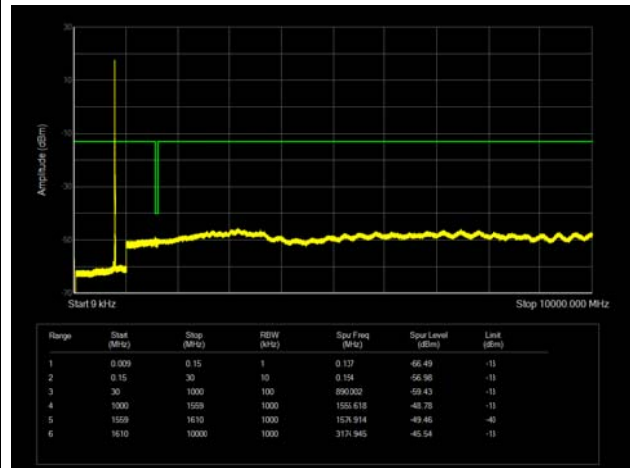

5.7 Radiates Spurious Emission

Ambient condition

Temperature	Relative humidity	Pressure
23°C ~25°C	45%~50%	101.5kPa

Method of Measurement

1. The testing follows FCC KDB 971168 D01 v03r01 Section 5.8 and ANSI C63.26 (2015).
2. Below 1GHz: The EUT is placed on a turntable 0.8 meters above the ground in the chamber, 3 meter away from the antenna. The maximal emission value is acquired by adjusting the antenna height, polarisation and turntable azimuth. Normally, the height range of antenna is 1 m to 4 m, the azimuth range of turntable is 0° to 360°, and the receive antenna has two polarizations Vertical (V) and Horizontal (H). Above 1GHz: (Note: the FCC's permission to use 1.5m as an alternative per TCBC Conf call of Dec. 2, 2014.) The EUT is placed on a turntable 1.5 meters above the ground in the chamber, 3 meter away from the antenna. The maximal emission value is acquired by adjusting the antenna height, polarisation and turntable azimuth. Normally, the height range of antenna is 1 m to 4 m, the azimuth range of turntable is 0° to 360°, and the receive antenna has two polarizations Vertical (V) and Horizontal (H).
3. A loop antenna, A log-periodic antenna or horn antenna shall be substituted in place of the EUT. The log-periodic antenna will be driven by a signal generator and the level will be adjusted till the same power value on the spectrum analyzer or receiver. The level of the spurious emissions can be calculated through the level of the signal generator, cable loss, the gain of the substitution antenna and the reading of the spectrum analyzer or receiver.
4. The EUT is then put into continuously transmitting mode at its maximum power level during the test. Set Test Receiver or Spectrum RBW=100kHz, VBW=300kHz for 30MHz to 1GHz and RBW=1MHz, VBW=3MHz for above 1GHz, and the maximum value of the receiver should be recorded as (Pr).
5. The EUT shall be replaced by a substitution antenna. In the chamber, an substitution antenna for the frequency band of interest is placed at the reference point of the chamber. An RF Signal source for the frequency band of interest is connected to the substitution antenna with a cable that has been constructed to not interfere with the radiation pattern of the antenna. A power (PMea) is applied to the input of the substitution antenna, and adjust the level of the signal generator output until the value of the receiver reach the previously recorded (Pr). The power of signal source (PMea) is recorded. The test should be performed by rotating the test item and adjusting the receiving antenna polarization.
6. A amplifier should be connected to the Signal Source output port. And the cable should be connect between the Amplifier and the Substitution Antenna. The cable loss (Pcl) ,the Substitution Antenna Gain (Ga) and the Amplifier Gain (PAg) should be recorded after test.
7. The measurement results are obtained as described below:
$$\text{Power(EIRP)} = \text{PMea} - \text{PAg} - \text{Pcl} + \text{Ga}$$

The measurement results are amend as described below:
$$\text{Power(EIRP)} = \text{PMea} - \text{Pcl} + \text{Ga}$$
8. This value is EIRP since the measurement is calibrated using an antenna of known gain (2.15 dB) and known input power. ERP can be calculated from EIRP by subtracting the gain of the dipole, $\text{ERP} = \text{EIRP} - 2.15\text{dB}$.

The modulation mode and RB allocation refer to section 5.1, using the maximum output power configuration.

Test setup

9KHz ~ 30MHz

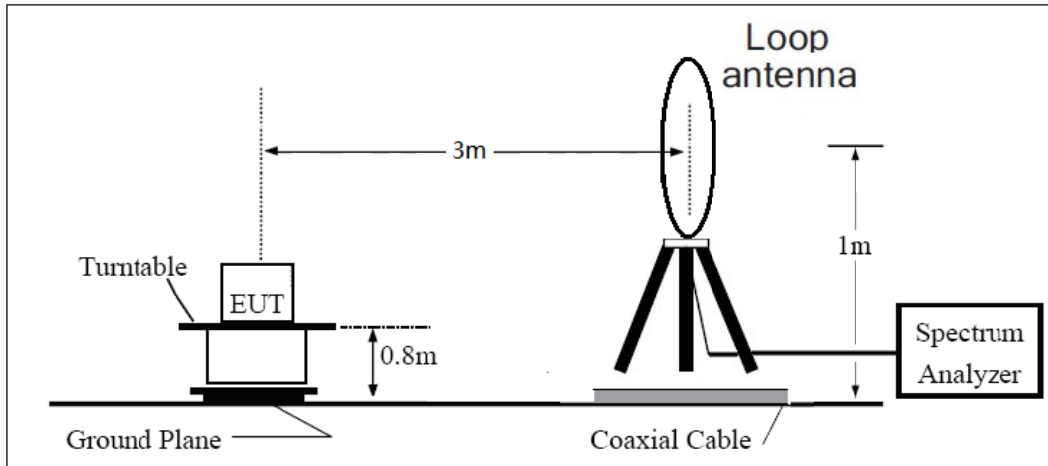

30MHz ~ 1GHz

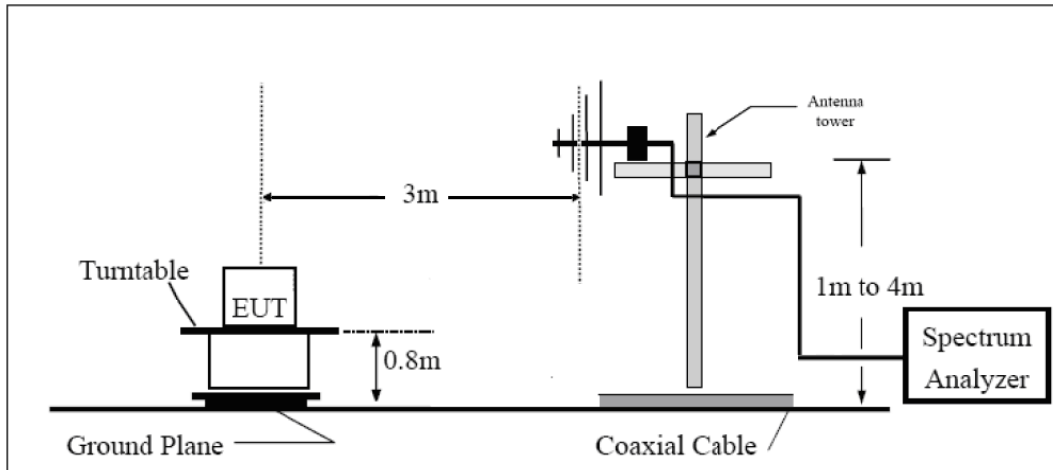

Above 1GHz

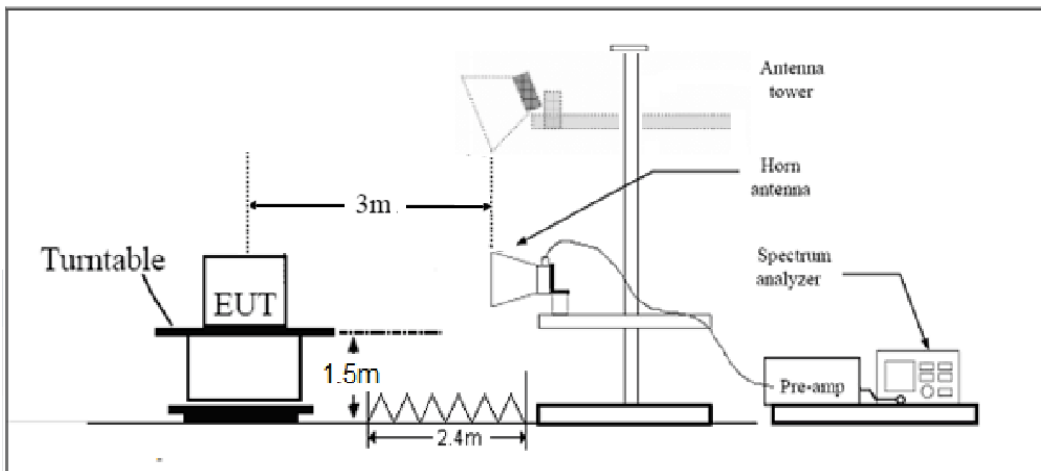

Note: Area side:2.4mX3.6m

Limits

Rule Part 27.53(f) For operations in the 746-758 MHz, 775-788 MHz, and 805-806 MHz bands, emissions in the band 1559-1610 MHz shall be limited to -70 dBW/MHz equivalent isotropically radiated power (EIRP) for wideband signals, and -80 dBW EIRP for discrete emissions of less than 700 Hz bandwidth. For the purpose of equipment authorization, a transmitter shall be tested with an antenna that is representative of the type that will be used with the equipment in normal operation. Part 27.53 (c) For operations in the 746-758 MHz band and the 776-788 MHz band, the power of any emission outside the licensee's frequency band(s) of operation shall be attenuated below the transmitter power (P) within the licensed band(s) of operation, measured in watts, in accordance with the following:

- (1) On any frequency outside the 746-758 MHz band, the power of any emission shall be attenuated outside the band below the transmitter power (P) by at least $43 + 10 \log (P)$ dB;
- (2) On any frequency outside the 776-788 MHz band, the power of any emission shall be attenuated outside the band below the transmitter power (P) by at least $43 + 10 \log (P)$ dB;
- (3) On all frequencies between 763-775 MHz and 793-805 MHz, by a factor not less than $76 + 10 \log (P)$ dB in a 6.25 kHz band segment, for base and fixed stations;
- (4) On all frequencies between 763-775 MHz and 793-805 MHz, by a factor not less than $65 + 10 \log (P)$ dB in a 6.25 kHz band segment, for mobile and portable stations;
- (5) Compliance with the provisions of paragraphs (c)(1) and (c)(2) of this section is based on the use of measurement instrumentation employing a resolution bandwidth of 100 kHz or greater. However, in the 100 kHz bands immediately outside and adjacent to the frequency block, a resolution bandwidth of at least 30 kHz may be employed;

Part 27.53(f) Limit	Limit out of the band 1559-1610 MHz	-13 dBm
	Limit in the band 1559-1610 MHz	-40 dBm

Measurement Uncertainty

The assessed measurement uncertainty to ensure 95% confidence level for the normal distribution is with the coverage factor $k = \pm 1.96$, $U = \pm 3.55$ dB.

**Test Result**

Sweep the whole frequency band through the range from 9kHz to the 10th harmonic of the carrier, the emissions below the noise floor will not be recorded in the report.

LTE Band 13 QPSK 5MHz CH-Middle, RB 1

Harmonic	Frequency (MHz)	SG (dBm)	Cable Loss (dB)	Gain (dBi)	Antenna Polarization	EIRP Level (dBm)	Limit (dBm)	Margin (dB)	Azimuth (deg)
2	1559.73	-54.49	1.70	8.70	Horizontal	-49.64	-40.00	9.64	0
Harmonic	Frequency (MHz)	SG (dBm)	Cable Loss (dB)	Gain (dBi)	Antenna Polarization	ERP Level (dBm)	Limit (dBm)	Margin (dB)	Azimuth (deg)
3	2339.67	-54.28	2.10	12.00	Horizontal	-46.53	-13.00	33.53	0
4	3118.00	-63.43	2.30	13.10	Horizontal	-54.78	-13.00	41.78	0
5	3897.50	-51.27	2.90	12.50	Horizontal	-43.82	-13.00	30.82	225
6	4677.00	-60.62	3.10	12.50	Horizontal	-53.37	-13.00	40.37	315
7	5456.50	-58.15	3.30	12.50	Horizontal	-51.10	-13.00	38.10	0
8	6236.00	-61.02	3.50	12.80	Horizontal	-53.87	-13.00	40.87	180
9	7015.50	-55.37	4.20	11.80	Horizontal	-49.92	-13.00	36.92	0
10	7795.00	-54.54	4.40	12.30	Horizontal	-48.79	-13.00	35.79	90

Note: 1. The other Spurious RF Radiated emissions level is no more than noise floor.

2. The worst emission was found in the antenna is Horizontal position.



LTE Band 13 QPSK 10MHz CH-Middle, RB 1

Harmonic	Frequency (MHz)	SG (dBm)	Cable Loss (dB)	Gain (dBi)	Antenna Polarization	ERP Level (dBm)	Limit (dBm)	Margin (dB)	Azimuth (deg)
2	1555.13	-60.11	1.70	8.70	Horizontal	-55.26	-40.00	42.26	45
Harmonic	Frequency (MHz)	SG (dBm)	Cable Loss (dB)	Gain (dBi)	Antenna Polarization	ERP Level (dBm)	Limit (dBm)	Margin (dB)	Azimuth (deg)
3	2332.86	-60.27	2.10	12.00	Horizontal	-52.52	-13.00	39.52	315
4	3108.00	-65.07	2.30	13.10	Horizontal	-56.42	-13.00	43.42	270
5	3888.00	-52.56	2.90	12.50	Horizontal	-45.11	-13.00	32.11	315
6	4662.00	-61.70	3.10	12.50	Horizontal	-54.45	-13.00	41.45	315
7	5439.00	-58.31	3.30	12.50	Horizontal	-51.26	-13.00	38.26	315
8	6216.00	-60.68	3.50	12.80	Horizontal	-53.53	-13.00	40.53	90
9	6993.00	-58.76	4.20	11.80	Horizontal	-53.31	-13.00	40.31	225
10	7770.00	-53.95	4.40	12.30	Horizontal	-48.20	-13.00	35.20	90

Note: 1. The other Spurious RF Radiated emissions level is no more than noise floor.

2. The worst emission was found in the antenna is Horizontal position.



6 Main Test Instruments

Name	Manufacturer	Type	Serial Number	Calibration Date	Expiration Date
Horn Antenna	Schwarzbeck	BBHA 9120D	01799	2019-09-21	2022-09-20
Signal Analyzer	R&S	FSV30	100815	2020-12-17	2021-12-16
TRILOG Broadband Antenna	Schwarzbeck	VULB 9163	01439	2021-06-30	2024-06-29
Software	R&S	EMC32	10.35.10	/	/
Universal Radio Communication Tester	R&S	CMW500	150415	2021-05-15	2022-05-14
Spectrum Analyzer	Keysight	N9020A	MY52330084	2021-05-15	2022-05-14
Universal Radio Communication Tester	Agilent	E5515C	GB44400275	2021-05-15	2022-05-14
Spectrum Analyzer	R&S	FSV3030	101411	2020-12-13	2021-12-12
Climate Chamber	Weiss	VT4002	582261194500 10	2021-05-15	2022-05-14

*****END OF REPORT *****



ANNEX A: The EUT Appearance

The EUT Appearance are submitted separately.



ANNEX B: Test Setup Photos

The Test Setup Photos are submitted separately.