



RF TEST REPORT

Applicant ZTE Corporation
FCC ID SRQ-A31PLUS2
Product LTE/WCDMA/GSM(GPRS)
Multi-Mode Digital Mobile Phone
Model ZTE Blade A31 Plus
Report No. R2110A0943-R2
Issue Date November 24, 2021

TA Technology (Shanghai) Co., Ltd. tested the above equipment in accordance with the requirements in **FCC CFR47 Part 2 (2020)/ FCC CFR 47 Part 24E (2020)**. The test results show that the equipment tested is capable of demonstrating compliance with the requirements as documented in this report.

Prepared by: Peng Tao

Approved by: Kai Xu

TA Technology (Shanghai) Co., Ltd.

No.145, Jintang Rd, Tangzhen Industry Park, Pudong Shanghai, China

TEL: +86-021-50791141/2/3

FAX: +86-021-50791141/2/3-8000



TABLE OF CONTENT

1. Test Laboratory	4
1.1. Notes of the test report.....	4
1.2. Test facility.....	4
1.3. Testing Location	4
2. General Description of Equipment under Test.....	5
2.3. Applicant and Manufacturer Information	5
2.4. General information	5
3. Applied Standards.....	7
4. Test Configuration.....	8
5. Test Case Results.....	10
5.1. RF Power Output and Effective Isotropic Radiated Power	10
5.2. Occupied Bandwidth	16
5.3. Band Edge Compliance.....	31
5.4. Peak-to-Average Power Ratio (PAPR)	46
5.5. Frequency Stability.....	50
5.6. Spurious Emissions at Antenna Terminals	56
5.7. Radiates Spurious Emission	62
6. Main Test Instruments	68
ANNEX A: The EUT Appearance.....	69
ANNEX B: Test Setup Photos	70
ANNEX C: Product Change Description	71

Summary of measurement results

No.	Test Case	Clause in FCC rules	Verdict
1	RF Power Output and Effective Isotropic Radiated Power	2.1046 24.232(c)	PASS
2	Occupied Bandwidth	2.1049	PASS
3	Band Edge Compliance	2.1051 /24.238(a)	PASS
4	Peak-to-Average Power Ratio	24.232/KDB 971168 D01(5.7)	PASS
5	Frequency Stability	2.1055 / 24.235	PASS
6	Spurious Emissions at Antenna Terminals	2.1051 / 24.238(a)	PASS
7	Radiates Spurious Emission	2.1053 / 24.238(a)	PASS
Date of Testing: (Original) August 3, 2021 ~ August 5, 2021 (Variant) November 24, 2021 Date of Sample Received: August 1, 2021			
Note: PASS: The EUT complies with the essential requirements in the standard. FAIL: The EUT does not comply with the essential requirements in the standard. All indications of Pass/Fail in this report are opinions expressed by TA Technology (Shanghai) Co., Ltd. based on interpretations and/or observations of test results. Measurement Uncertainties were not taken into account and are published for informational purposes only.			

ZTE Blade A31 Plus (Report No.: R2110A0943-R2) is a variant model of ZTE Blade A31 Plus (Report No.: R2108A0671-R2). This product only added LTE Band 12/17, changed Software Version and changed to dual card slots. This report verified and retested the worst Radiates Spurious Emission of GSM and WCDMA mode (GSM1900; WCDMA Band II). The detailed product change description please refers to the Difference Declaration Letter.



1. Test Laboratory

1.1. Notes of the test report

This report shall not be reproduced in full or partial, without the written approval of **TA technology (shanghai) co., Ltd.** The results documented in this report apply only to the tested sample, under the conditions and modes of operation as described herein. Measurement Uncertainties were not taken into account and are published for informational purposes only. This report is written to support regulatory compliance of the applicable standards stated above.

1.2. Test facility

FCC (Designation number: CN1179, Test Firm Registration Number: 446626)

TA Technology (Shanghai) Co., Ltd. has been listed on the US Federal Communications Commission list of test facilities recognized to perform measurements.

A2LA (Certificate Number: 3857.01)

TA Technology (Shanghai) Co., Ltd. has been listed by American Association for Laboratory Accreditation to perform measurement.

1.3. Testing Location

Company: TA Technology (Shanghai) Co., Ltd.
Address: No.145, Jintang Rd, Tangzhen Industry Park, Pudong
City: Shanghai
Post code: 201201
Country: P. R. China
Contact: Xu Kai
Telephone: +86-021-50791141/2/3
Fax: +86-021-50791141/2/3-8000
Website: <http://www.ta-shanghai.com>
E-mail: xukai@ta-shanghai.com

2. General Description of Equipment under Test

2.3. Applicant and Manufacturer Information

Applicant	ZTE Corporation
Applicant address	ZTE Plaza, Keji Road South, Hi-Tech, Industrial Park, Nanshan District, Shenzhen, Guangdong, 518057, P.R.China
Manufacturer	ZTE Corporation
Manufacturer address	ZTE Plaza, Keji Road South, Hi-Tech, Industrial Park, Nanshan District, Shenzhen, Guangdong, 518057, P.R.China

2.4. General information

EUT Description			
Model	ZTE Blade A31 Plus		
IME	IMEI 1: 866591060000396 IMEI 2: 866591060001543		
Hardware Version	z1kA		
Software Version	GEN_LA_A31_Plus_V1.0		
Power Supply	Battery / AC adapter		
Antenna Type	Internal Antenna		
Antenna Gain	-1.3dBi		
Test Mode(s)	GSM1900; WCDMA Band II; LTE Band 2;		
Test Modulation	(GSM/GPRS)GMSK, (EGPRS) GMSK/ 8PSK; (WCDMA) BPSK, QPSK,16QAM; (LTE) QPSK, 16QAM, 64QAM;		
GPRS Multislot Class	12		
EGPRS Multislot Class	12		
HSDPA UE Category	24		
HSUPA UE Category	7		
LTE Category	5		
Maximum E.I.R.P	GSM 1900:	29.02dBm	
	WCDMA Band II:	22.52dBm	
	LTE Band 2:	21.59 dBm	
Rated Power Supply Voltage	3.8V		
Operating Voltage	Minimum: 3.4V Maximum: 4.35V		
Operating Temperature	Lowest: -10°C Highest: +55°C		
Extreme Temperature	Lowest: -30°C Highest: +50°C		
Operating Frequency Range(s)	Band	Tx (MHz)	Rx (MHz)
	GSM1900	1850 ~ 1910	1930 ~ 1990
	WCDMA Band II	1850 ~ 1910	1930 ~ 1990



	LTE Band 2	1850 ~ 1910	1930 ~ 1990
EUT Accessory			
Adapter 1	Manufacturer: Shenzhen Ruijing Industrial Co.,Ltd Model: STC-A51D-Z		
Adapter 2	Manufacturer: HUIZHOU PUAN ELECTRONICS CO.,LTD Model: STC-A51D-Z		
Battery	Manufacturer: Guangdong Fenghua New Energy Co.,Ltd. Model: Li3830T43P8h486375		
Earphone 1	Manufacturer: Shenzhen FDC Electronics Co. ,Ltd. Model: DEM-8A		
Earphone 2	Manufacturer: JUWEI ELECTRONICS CO., LTD Model: JWEP1091-Z01		
USB Cable 1	Manufacturer: Dongguan Guojun Plastic Electronic Co.,Ltd Model: USB-MU5-B-70-M-L		
USB Cable 2	Manufacturer: Shenzhen Yihuaxing Electronic Co., Ltd. Model: USB-MU5-B-70-M-L		
Note: 1. The EUT is sent from the applicant to TA and the information of the EUT is declared by the applicant. 2. There are more than one Adapter, Earphone and USB Cable, each one should be applied throughout the compliance test respectively, however, only the worst case (Adapter 1, Earphone 2 and USB Cable 1) will be recorded in this report.			

3. Applied Standards

According to the specifications of the manufacturer, it must comply with the requirements of the following standards:

Test standards:

FCC CFR 47 Part 24E (2020)

ANSI C63.26 (2015)

Reference standard:

FCC CFR47 Part 2 (2020)

KDB 971168 D01 Power Meas License Digital Systems v03r01

4. Test Configuration

There is more than one SIM card slot, each one should be applied throughout the compliance test respectively, and however, only the worst case (SIM 1) will be recorded in this report.

Radiated measurements are performed by rotating the EUT in three different orthogonal test planes. EUT stand-up position (Z axis), lie-down position (X, Y axis). Receiver antenna polarization (horizontal and vertical), the worst emission was found in position (Z axis, horizontal polarization) and the worst case was recorded.

All mode and data rates and positions and RB size and modulations were investigated. Subsequently, only the worst case emissions are reported.

The following testing in GSM/WCDMA/LTE is set based on the maximum RF Output Power.

Test modes are chosen to be reported as the worst case configuration below:

Test items	Modes/Modulation	
	GSM 1900	WCDMA Band II
RF Power Output and Effective Isotropic Radiated Power	GSM GPRS EGPRS	RMC/ AMR HSDPA/HSUPA DC-HSDPA/HSPA+
Occupied Bandwidth	GSM GPRS(1Tx slot) EGPRS(1Tx slot)	RMC
Band Edge Compliance	GSM GPRS(1Tx slot) EGPRS(1Tx slot)	RMC
Peak-to-Average Power Ratio	GSM GPRS(1Tx slot) EGPRS(1Tx slot)	RMC
Frequency Stability	GSM GPRS(1Tx slot) EGPRS(1Tx slot)	RMC
Spurious Emissions at Antenna Terminals	GSM	RMC
Radiates Spurious Emission	GSM	RMC

Test modes are chosen to be reported as the worst case configuration below for LTE Band 2:

Test items	Bandwidth (MHz)						Modulation		RB			Test Channel		
	1.4	3	5	10	15	20	QPSK	16QAM/ 64QAM	1	50%	100%	L	M	H



RF Power Output and Effective Isotropic Radiated Power	○	○	○	○	○	○	○	○	○	○	○	○	○	○
Occupied Bandwidth	○	○	○	○	○	○	○	○	-	-	○	○	○	○
Band Edge Compliance	○	○	○	○	○	○	○	○	○	-	○	○	-	○
Peak-to-Average Power Ratio	○	○	○	○	○	○	○	○	-	-	○	○	○	○
Frequency Stability	○	○	○	○	○	○	○	○	○	-	-	-	○	-
Spurious Emissions at Antenna Terminals	○	○	○	○	○	○	○	-	○	-	-	○	○	○
Radiates Spurious Emission	○	-	○	-	-	○	○	-	○	-	-	-	○	-
Note	<p>1. The mark "O" means that this configuration is chosen for testing.</p> <p>2. The mark "-" means that this configuration is not testing.</p>													

5. Test Case Results

5.1.RF Power Output and Effective Isotropic Radiated Power

Ambient condition

Temperature	Relative humidity	Pressure
23°C ~25°C	45%~50%	101.5kPa

Methods of Measurement

During the process of the testing, The EUT was connected to the Base Station Simulator with a known loss. The EUT is controlled by the Base Station Simulator test set to ensure max power transmission with proper modulation.

ERP can then be calculated as follows:

$$\text{EIRP (dBm)} = \text{Output Power (dBm)} - \text{Losses (dB)} + \text{Antenna Gain (dBi)}$$

where:dBd refers to gain relative to an ideal dipole.

$$\text{EIRP (dBm)} = \text{ERP (dBm)} + 2.15 \text{ (dB.)}$$

Test Setup

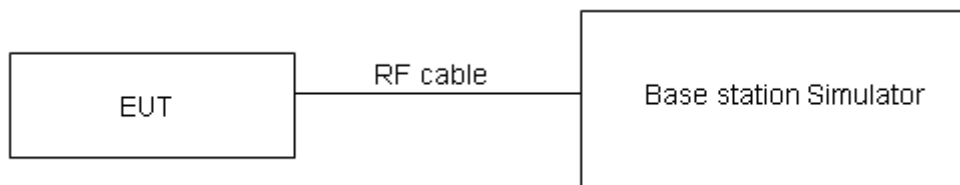

Limits

No specific RF power output requirements in part 2.1046.

Rule Part 24.232(c) Mobile and portable stations are limited to 2 watts EIRP.

Rule Part 24.232(e) Peak transmit power must be measured over any interval of continuous transmission using instrumentation calibrated in terms of an rms-equivalent voltage.

Limit	$\leq 2 \text{ W}$ (33 dBm)
-------	-----------------------------

Measurement Uncertainty

The assessed measurement uncertainty to ensure 95% confidence level for the normal distribution is with the coverage factor $k = 2$, $U = 0.4 \text{ dB}$ for RF power output, $k = 2$, $U = 1.19 \text{ dB}$ for EIRP.

Test Results

GSM 1900		Maximum Output Power (dBm)			EIRP (dBm)		
		Channel 512	Channel 661	Channel 810	Channel 512	Channel 661	Channel 810
		1850.2 (MHz)	1880 (MHz)	1909.8 (MHz)	1850.2 (MHz)	1880 (MHz)	1909.8 (MHz)
GSM(GMSK)	Results	30.16	30.25	30.32	28.86	28.95	29.02
GPRS (GMSK)	1TXslot	30.14	30.24	30.16	28.84	28.94	28.86
	2TXslots	28.14	28.12	28.17	26.84	26.82	26.87
	3TXslots	26.65	26.62	26.68	25.35	25.32	25.38
	4TXslots	24.69	24.60	24.70	23.39	23.30	23.40
EGPRS (8PSK)	1TXslot	26.60	26.87	26.20	25.30	25.57	24.90
	2TXslots	24.65	24.88	24.01	23.35	23.58	22.71
	3TXslots	22.19	22.39	21.07	20.89	21.09	19.77
	4TXslots	19.20	19.36	19.12	17.90	18.06	17.82

WCDMA Band II		Maximum Output Power (dBm)			EIRP (dBm)		
		Channel 9262	Channel 9400	Channel 9538	Channel 9262	Channel 9400	Channel 9538
		1852.4 (MHz)	1880 (MHz)	1907.6 (MHz)	1852.4 (MHz)	1880 (MHz)	1907.6 (MHz)
RMC		23.66	23.61	23.70	22.36	22.31	22.40
AMR		23.82	23.45	23.54	22.52	22.15	22.24
HSDPA	Sub - Test 1	23.14	23.21	23.30	21.84	21.91	22.00
	Sub - Test 2	23.04	23.01	23.20	21.74	21.71	21.90
	Sub - Test 3	22.66	22.65	22.54	21.36	21.35	21.24
	Sub - Test 4	22.78	22.69	22.60	21.48	21.39	21.30
HSUPA	Sub - Test 1	23.14	23.03	23.20	21.84	21.73	21.90
	Sub - Test 2	22.20	22.23	22.10	20.90	20.93	20.80
	Sub - Test 3	22.74	22.77	22.76	21.44	21.47	21.46
	Sub - Test 4	22.10	22.09	22.32	20.80	20.79	21.02
	Sub - Test 5	23.14	23.09	23.36	21.84	21.79	22.06
DC-HSDPA	Sub - Test 1	23.32	23.23	23.30	22.02	21.93	22.00
	Sub - Test 2	23.16	23.25	23.16	21.86	21.95	21.86
	Sub - Test 3	22.60	22.63	22.82	21.30	21.33	21.52
	Sub - Test 4	22.64	22.51	22.82	21.34	21.21	21.52
HSPA+	16QAM	22.80	22.83	22.92	21.50	21.53	21.62



LTE Band 2				Maximum Output Power(dBm)			EIRP (dBm)		
BW	Modulation	RB size	RB offset	Channel/Frequency(MHz)					
				18607/1850.7	18900/1880	19193/1909.3	18607/1850.7	18900/1880	19193/1909.3
1.4MHz	QPSK	1	0	22.26	22.78	22.81	20.96	21.48	21.51
		1	2	22.37	22.70	22.84	21.07	21.40	21.54
		1	5	22.33	22.75	22.84	21.03	21.45	21.54
		3	0	22.40	22.45	22.48	21.10	21.15	21.18
		3	2	22.25	22.44	22.58	20.95	21.14	21.28
		3	3	22.41	22.35	22.57	21.11	21.05	21.27
		6	0	21.45	21.45	21.55	20.15	20.15	20.25
	16QAM	1	0	21.96	21.45	22.04	20.66	20.15	20.74
		1	2	21.94	21.46	22.05	20.64	20.16	20.75
		1	5	21.93	21.54	22.00	20.63	20.24	20.70
		3	0	21.47	21.55	21.54	20.17	20.25	20.24
		3	2	21.45	21.49	21.60	20.15	20.19	20.30
		3	3	21.39	21.52	21.58	20.09	20.22	20.28
		6	0	20.50	20.61	20.74	19.20	19.31	19.44
	64QAM	1	0	20.97	20.93	21.00	19.67	19.63	19.70
		1	2	20.85	20.83	20.91	19.55	19.53	19.61
		1	5	21.56	21.58	21.57	20.26	20.28	20.27
		3	0	21.55	21.49	21.58	20.25	20.19	20.28
		3	2	21.54	21.51	21.59	20.24	20.21	20.29
		3	3	21.57	21.54	21.60	20.27	20.24	20.30
		6	0	20.46	20.45	20.56	19.16	19.15	19.26
BW	Modulation	RB size	RB offset	Channel/Frequency(MHz)					
				18615/1851.5	18900/1880	19185/1908.5	18615/1851.5	18900/1880	19185/1908.5
3MHz	QPSK	1	0	22.28	22.82	22.84	20.98	21.52	21.54
		1	7	22.35	22.73	22.88	21.05	21.43	21.58
		1	14	22.36	22.80	22.88	21.06	21.50	21.58
		8	0	21.50	21.57	21.61	20.20	20.27	20.31
		8	4	21.37	21.54	21.70	20.07	20.24	20.40
		8	7	21.51	21.46	21.67	20.21	20.16	20.37
		15	0	21.45	21.49	21.58	20.15	20.19	20.28
	16QAM	1	0	21.99	21.47	22.07	20.69	20.17	20.77



		1	7	21.97	21.46	22.09	20.67	20.16	20.79
		1	14	21.95	21.58	22.03	20.65	20.28	20.73
		8	0	20.58	20.68	20.66	19.28	19.38	19.36
		8	4	20.56	20.62	20.72	19.26	19.32	19.42
		8	7	20.49	20.64	20.71	19.19	19.34	19.41
		15	0	20.53	20.65	20.77	19.23	19.35	19.47
	64QAM	1	0	21.00	20.95	21.03	19.70	19.65	19.73
		1	7	20.88	20.83	20.93	19.58	19.53	19.63
		1	14	21.58	21.57	21.60	20.28	20.27	20.30
		8	0	20.66	20.62	20.70	19.36	19.32	19.40
		8	4	20.65	20.64	20.71	19.35	19.34	19.41
		8	7	20.67	20.66	20.73	19.37	19.36	19.43
		15	0	20.49	20.49	20.59	19.19	19.19	19.29
BW	Modulation	RB size	RB offset	Channel/Frequency(MHz)					
				18625/ 1852.5	18900/ 1880	19175/ 1907.5	18625/ 1852.5	18900/ 1880	19175/ 1907.5
5MHz	QPSK	1	0	22.25	22.80	22.80	20.95	21.50	21.50
		1	13	22.33	22.69	22.85	21.03	21.39	21.55
		1	24	22.33	22.75	22.84	21.03	21.45	21.54
		12	0	21.47	21.52	21.57	20.17	20.22	20.27
		12	6	21.35	21.50	21.65	20.05	20.20	20.35
		12	13	21.49	21.44	21.63	20.19	20.14	20.33
		25	0	21.45	21.48	21.56	20.15	20.18	20.26
	16QAM	1	0	21.96	21.43	22.04	20.66	20.13	20.74
		1	13	21.94	21.44	22.06	20.64	20.14	20.76
		1	24	21.92	21.56	21.99	20.62	20.26	20.69
		12	0	20.56	20.64	20.63	19.26	19.34	19.33
		12	6	20.53	20.57	20.68	19.23	19.27	19.38
		12	13	20.46	20.59	20.67	19.16	19.29	19.37
		25	0	20.51	20.61	20.72	19.21	19.31	19.42
	64QAM	1	0	20.97	20.95	21.00	19.67	19.65	19.70
		1	13	20.85	20.85	20.90	19.55	19.55	19.60
		1	24	21.59	21.55	21.56	20.29	20.25	20.26
		12	0	20.64	20.58	20.71	19.34	19.28	19.41
		12	6	20.62	20.59	20.67	19.32	19.29	19.37
		12	13	20.64	20.61	20.69	19.34	19.31	19.39
		25	0	20.47	20.45	20.54	19.17	19.15	19.24



BW	Modulation	RB size	RB offset	Channel/Frequency(MHz)					
				18650/1855	18900/1880	19150/1905	18650/1855	18900/1880	19150/1905
10MHz	QPSK	1	0	22.27	22.81	22.83	20.97	21.51	21.53
		1	25	22.36	22.74	22.89	21.06	21.44	21.59
		1	49	22.35	22.79	22.87	21.05	21.49	21.57
		25	0	21.50	21.57	21.61	20.20	20.27	20.31
		25	13	21.38	21.55	21.69	20.08	20.25	20.39
		25	25	21.51	21.48	21.68	20.21	20.18	20.38
		50	0	21.49	21.50	21.60	20.19	20.20	20.30
	16QAM	1	0	21.98	21.46	22.06	20.68	20.16	20.76
		1	25	21.97	21.48	22.09	20.67	20.18	20.79
		1	49	21.95	21.58	22.02	20.65	20.28	20.72
		25	0	20.59	20.69	20.67	19.29	19.39	19.37
		25	13	20.55	20.61	20.71	19.25	19.31	19.41
		25	25	20.49	20.64	20.71	19.19	19.34	19.41
		50	0	20.54	20.66	20.76	19.24	19.36	19.46
	64QAM	1	0	20.99	20.94	21.02	19.69	19.64	19.72
		1	25	20.88	20.85	20.93	19.58	19.55	19.63
		1	49	21.58	21.57	21.59	20.28	20.27	20.29
		25	0	20.67	20.63	20.71	19.37	19.33	19.41
		25	13	20.64	20.63	20.70	19.34	19.33	19.40
		25	25	20.67	20.66	20.73	19.37	19.36	19.43
		50	0	20.50	20.50	20.58	19.20	19.20	19.28
BW	Modulation	RB size	RB offset	Channel/Frequency(MHz)					
				18675/1857.5	18900/1880	19125/1902.5	18675/1857.5	18900/1880	19125/1902.5
15MHz	QPSK	1	0	22.26	22.77	22.81	20.96	21.47	21.51
		1	38	22.34	22.73	22.86	21.04	21.43	21.56
		1	74	22.32	22.74	22.83	21.02	21.44	21.53
		36	0	21.48	21.53	21.58	20.18	20.23	20.28
		36	18	21.35	21.50	21.65	20.05	20.20	20.35
		36	39	21.48	21.45	21.64	20.18	20.15	20.34
		75	0	21.47	21.46	21.55	20.17	20.16	20.25
	16QAM	1	0	21.93	21.44	22.04	20.63	20.14	20.74
		1	38	21.95	21.45	22.07	20.65	20.15	20.77
		1	74	21.92	21.54	21.99	20.62	20.24	20.69



		36	0	20.56	20.67	20.64	19.26	19.37	19.34
		36	18	20.52	20.56	20.67	19.22	19.26	19.37
		36	39	20.47	20.60	20.68	19.17	19.30	19.38
		75	0	20.51	20.61	20.72	19.21	19.31	19.42
	64QAM	1	0	20.94	20.92	21.00	19.64	19.62	19.70
		1	38	20.86	20.82	20.91	19.56	19.52	19.61
		1	74	21.59	21.56	21.60	20.29	20.26	20.30
		36	0	20.66	20.65	20.72	19.36	19.35	19.42
		36	18	20.62	20.60	20.69	19.32	19.30	19.39
		36	39	20.65	20.62	20.70	19.35	19.32	19.40
		75	0	20.47	20.45	20.54	19.17	19.15	19.24
BW	Modulation	RB size	RB offset	Channel/Frequency(MHz)					
				18700/1860	18900/1880	19100/1900	18700/1860	18900/1880	19100/1900
20MHz	QPSK	1	0	22.23	22.73	22.78	20.93	21.43	21.48
		1	50	22.33	22.69	22.84	21.03	21.39	21.54
		1	99	22.30	22.73	22.80	21.00	21.43	21.50
		50	0	21.45	21.48	21.54	20.15	20.18	20.24
		50	25	21.33	21.46	21.62	20.03	20.16	20.32
		50	50	21.45	21.40	21.60	20.15	20.10	20.30
		100	0	21.44	21.41	21.51	20.14	20.11	20.21
	16QAM	1	0	21.91	21.40	21.99	20.61	20.10	20.69
		1	50	21.91	21.43	22.03	20.61	20.13	20.73
		1	99	21.90	21.51	21.97	20.60	20.21	20.67
		50	0	20.53	20.63	20.61	19.23	19.33	19.31
		50	25	20.49	20.54	20.64	19.19	19.24	19.34
		50	50	20.44	20.55	20.64	19.14	19.25	19.34
		100	0	20.49	20.57	20.69	19.19	19.27	19.39
	64QAM	1	0	20.92	20.88	20.95	19.62	19.58	19.65
		1	50	20.82	20.80	20.87	19.52	19.50	19.57
		1	99	21.53	21.50	21.54	20.23	20.20	20.24
		50	0	20.61	20.57	20.65	19.31	19.27	19.35
		50	25	20.58	20.56	20.63	19.28	19.26	19.33
		50	50	20.62	20.57	20.66	19.32	19.27	19.36
		100	0	20.45	20.41	20.51	19.15	19.11	19.21

5.2.Occupied Bandwidth

Ambient condition

Temperature	Relative humidity	Pressure
23°C ~25°C	45%~50%	101.5kPa

Method of Measurement

The EUT was connected to Spectrum Analyzer and Base Station Simulator via power Splitter. The occupied bandwidth is measured using spectrum analyzer.

RBW is set to 6.2kHz, VBW is set to 20kHz for GSM 1900,
 RBW is set to 51 kHz, VBW is set to 160kHz for WCDMA Band II,
 RBW is set to 30 kHz, VBW is set to 91kHz for LTE Band 2 (1.4MHz),
 RBW is set to 62 kHz, VBW is set to 180 kHz for LTE Band 2 (3MHz),
 RBW is set to 100 kHz, VBW is set to 300 kHz for LTE Band 2(5MHz),
 RBW is set to 200 kHz, VBW is set to 620kHz for LTE Band 2 (10MHz),
 RBW is set to 300kHz,VBW is set to 910kHz for LTE Band 2 (15MHz).
 RBW is set to 430kHz,VBW is set to 1.2MHz for LTE Band 2 (20MHz).

99% power and -26dBc occupied bandwidths are recorded. Spectrum analyzer plots are included on the following pages.

Test Setup

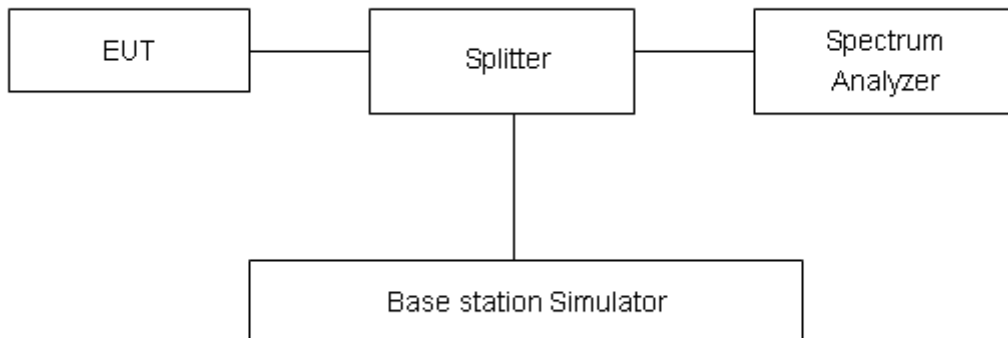

Limits

No specific occupied bandwidth requirements in part 2.1049.

Measurement Uncertainty

The assessed measurement uncertainty to ensure 95% confidence level for the normal distribution is with the coverage factor $k = 2$, $U = 624\text{Hz}$.

Test Result

Mode	Channel	Frequency (MHz)	99% Power Bandwidth (MHz)	-26dBc Bandwidth(MHz)
GSM 1900 (GMSK)	512	1850.2	0.242	0.304
	661	1880.0	0.245	0.313
	810	1909.8	0.244	0.312
GPRS 1900 (GMSK)	512	1850.2	0.240	0.314
	661	1880.0	0.244	0.314
	810	1909.8	0.243	0.310
EGPRS 1900 (8PSK)	512	1850.2	0.248	0.316
	661	1880.0	0.248	0.324
	810	1909.8	0.250	0.313
WCDMA Band II (RMC)	9262	1852.4	4.153	4.652
	9400	1880	4.155	4.672
	9538	1907.6	4.165	4.697

LTE Band 2					
Modulation	Bandwidth (MHz)	Channel	Frequency (MHz)	99% Power Bandwidth(MHz)	-26dBc Bandwidth(MHz)
QPSK	1.4	18607	1850.7	1.092	1.245
		18900	1880	1.100	1.252
		19193	1909.3	1.097	1.242
	3	18615	1851.5	2.711	3.020
		18900	1880	2.724	3.034
		19185	1908.5	2.700	3.048
	5	18625	1852.5	4.514	4.939
		18900	1880	4.518	4.989
		19175	1907.5	4.507	4.939
	10	18650	1855	8.975	9.856
		18900	1880	8.973	9.816
		19150	1905	9.017	9.816
	15	18675	1857.5	13.465	14.902
		18900	1880	13.443	14.883



		19125	1902.5	13.502	14.906	
	20	18700	1860	18.019	19.760	
		18900	1880	18.008	19.613	
		19100	1900	18.062	19.711	
16QAM	1.4	18607	1850.7	1.103	1.250	
		18900	1880	1.088	1.246	
		19193	1909.3	1.106	1.248	
	3	18615	1851.5	2.714	3.040	
		18900	1880	2.713	3.051	
		19185	1908.5	2.707	3.043	
	5	18625	1852.5	4.502	4.991	
		18900	1880	4.539	4.958	
		19175	1907.5	4.525	4.933	
	10	18650	1855	8.995	9.843	
		18900	1880	8.992	9.920	
		19150	1905	9.005	9.767	
	15	18675	1857.5	13.479	14.831	
		18900	1880	13.532	14.855	
		19125	1902.5	13.499	14.654	
	20	18700	1860	17.973	19.670	
		18900	1880	17.991	19.693	
		19100	1900	18.043	19.545	
	64QAM	1.4	18607	1850.7	1.099	1.252
			18900	1880	1.093	1.247
			19193	1909.3	1.096	1.249
3		18615	1851.5	2.697	3.064	
		18900	1880	2.701	3.052	
		19185	1908.5	2.704	3.026	
5		18625	1852.5	4.522	4.955	
		18900	1880	4.508	4.946	
		19175	1907.5	4.537	4.954	
10		18650	1855	8.998	9.768	
		18900	1880	8.997	9.899	
		19150	1905	8.998	9.797	



	15	18675	1857.5	13.491	14.894
		18900	1880	13.484	14.949
		19125	1902.5	13.502	14.785
	20	18700	1860	17.993	19.489
		18900	1880	18.055	19.678
		19100	1900	18.035	19.801

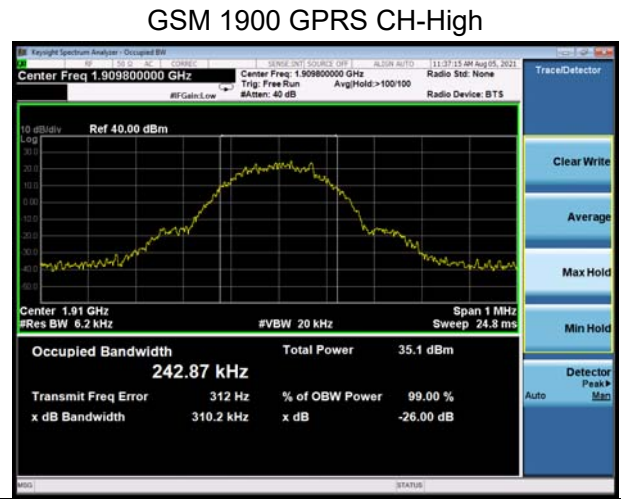
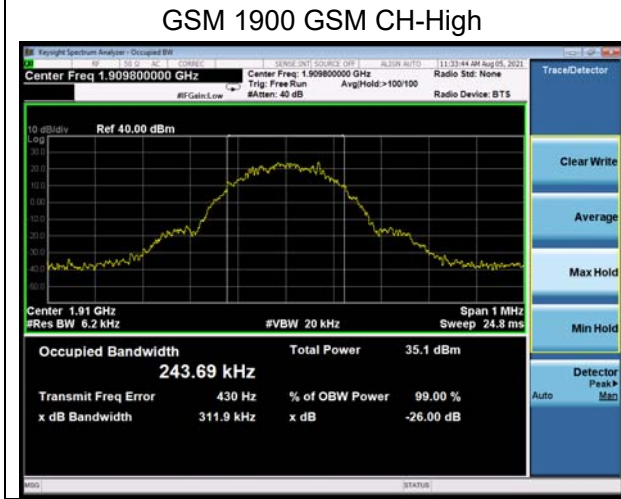
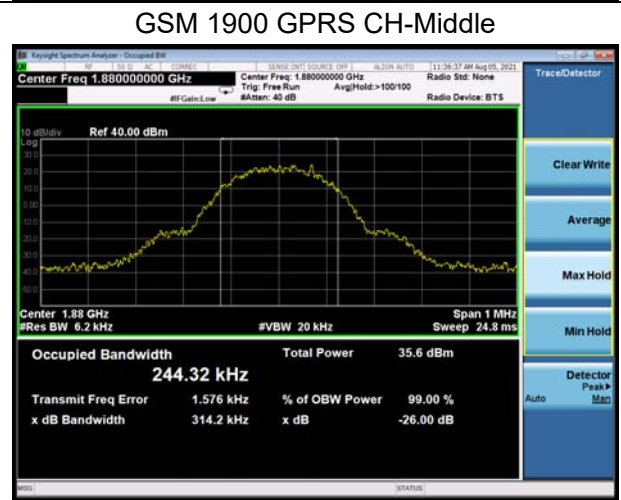
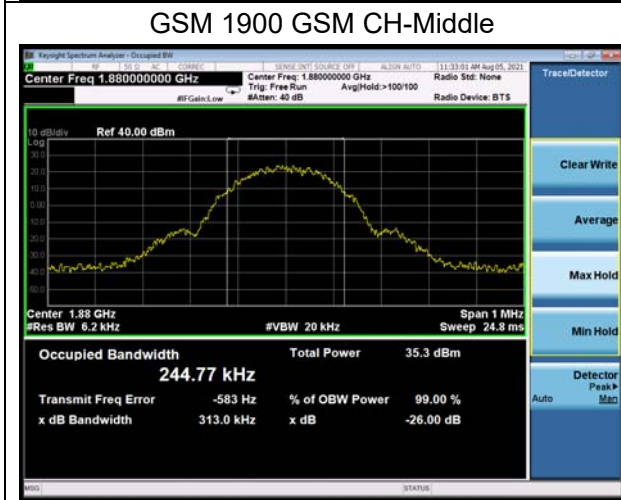
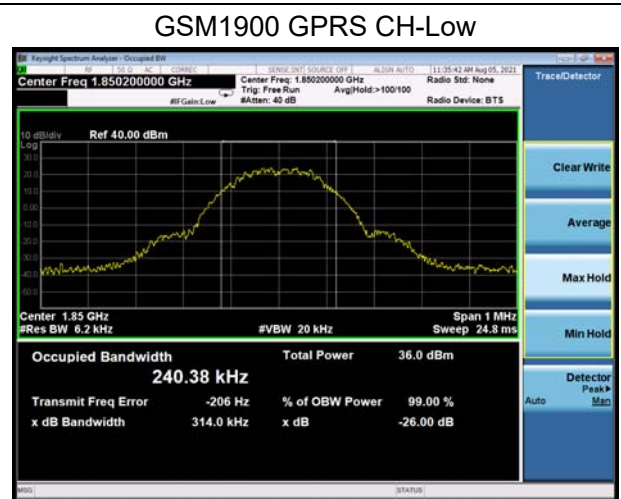
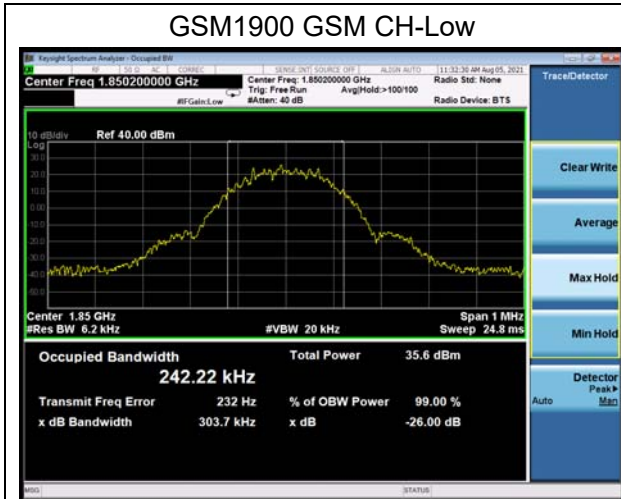

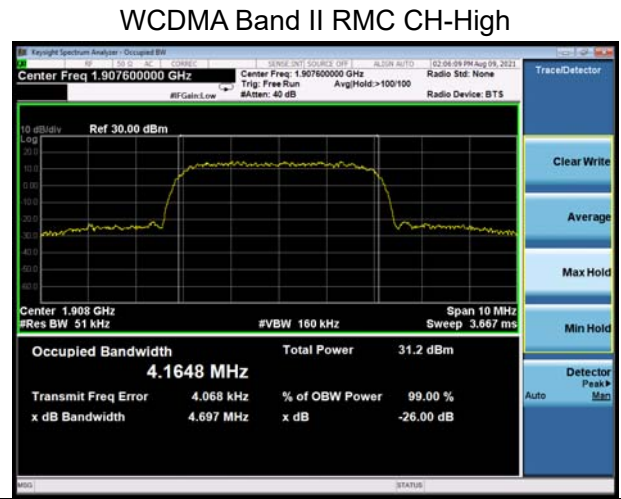
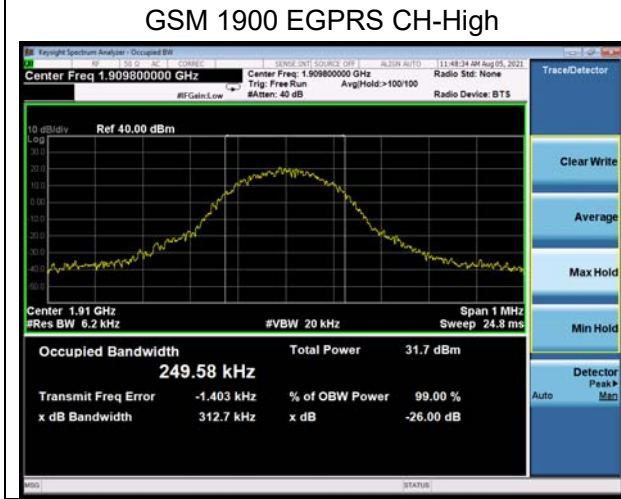
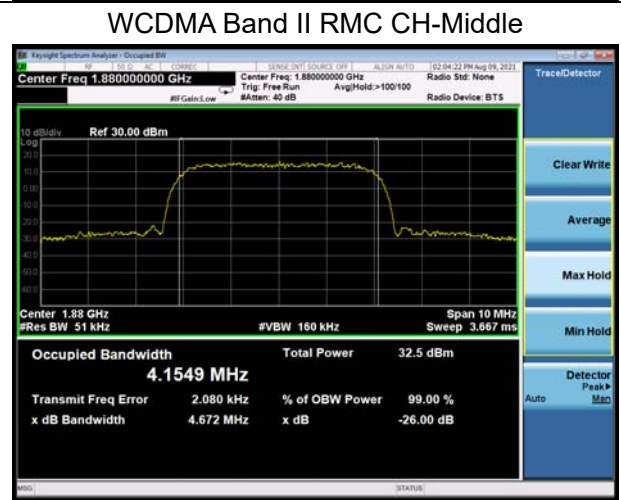
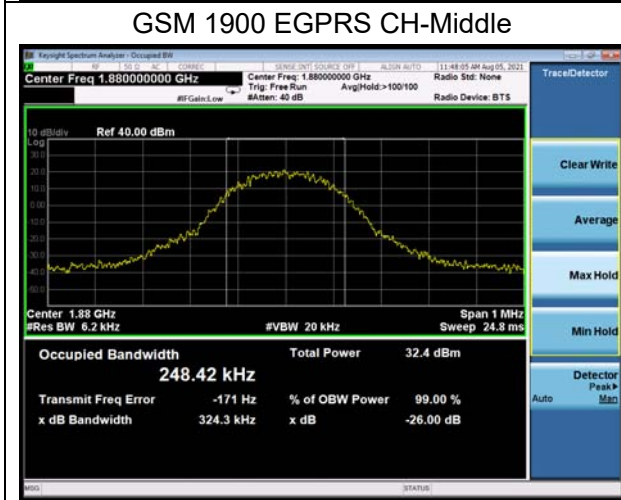
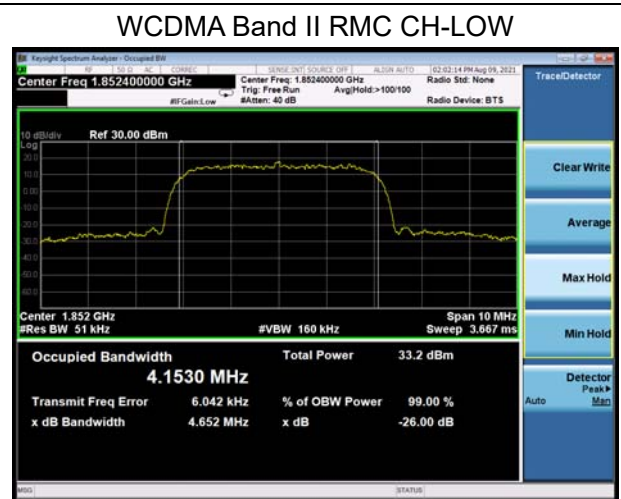
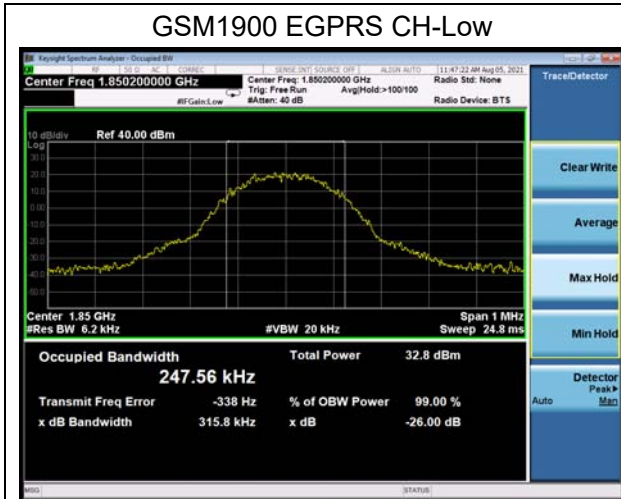



LTE Band 2 1.4 MHz QPSK CH-Low

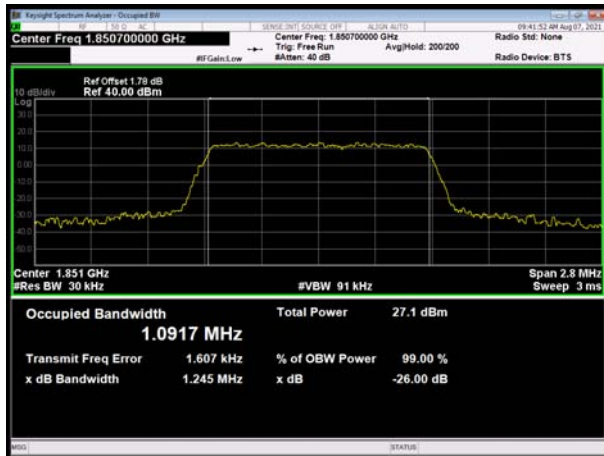

LTE Band 2 3MHz QPSK CH-Low

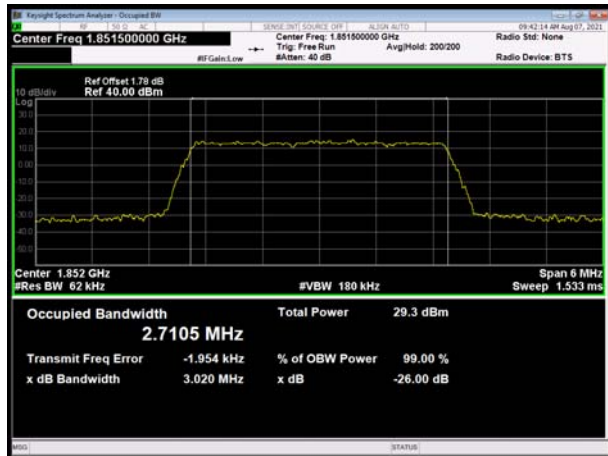

LTE Band 2 1.4MHz QPSK CH-Middle

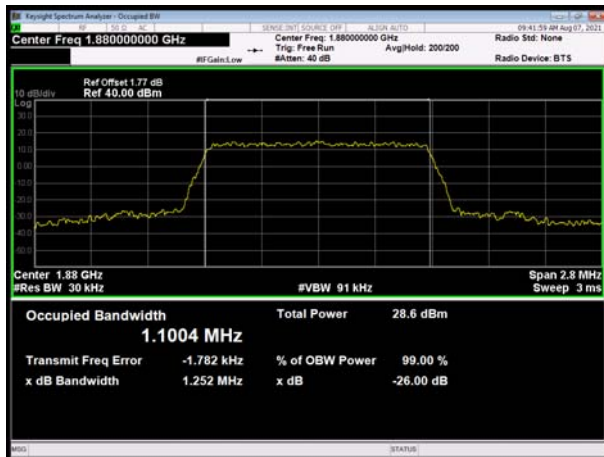

LTE Band 2 3MHz QPSK CH-Middle

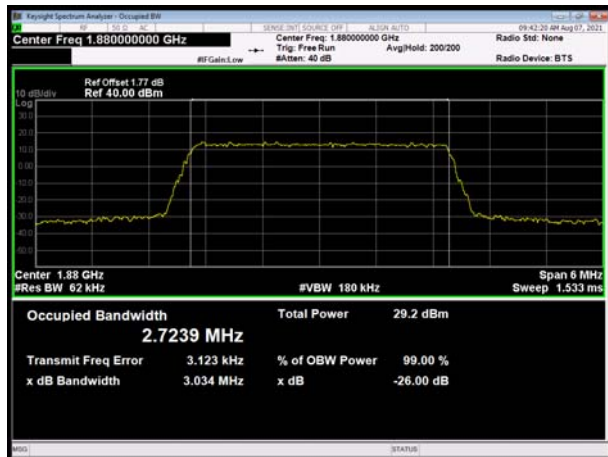

LTE Band 2 1.4MHz QPSK CH-High



LTE Band 2 3MHz QPSK CH-High

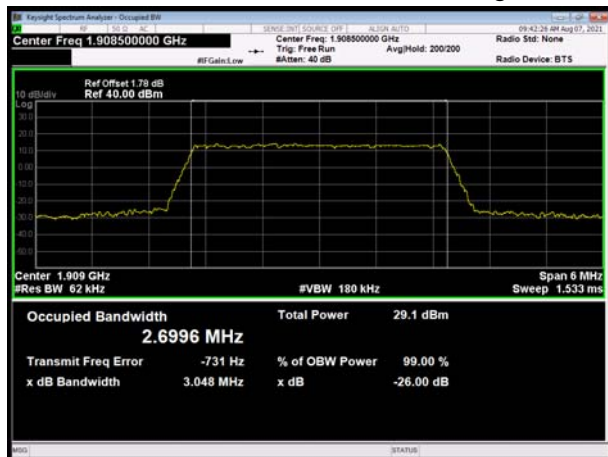

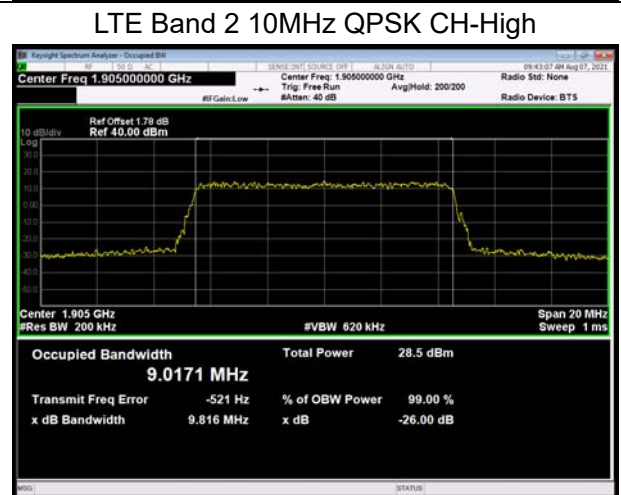
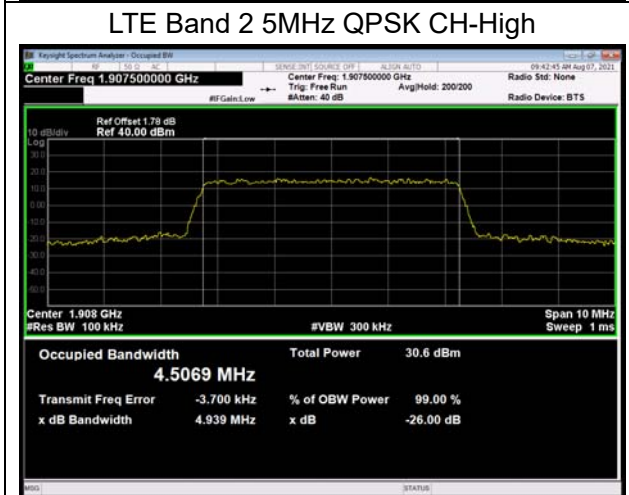
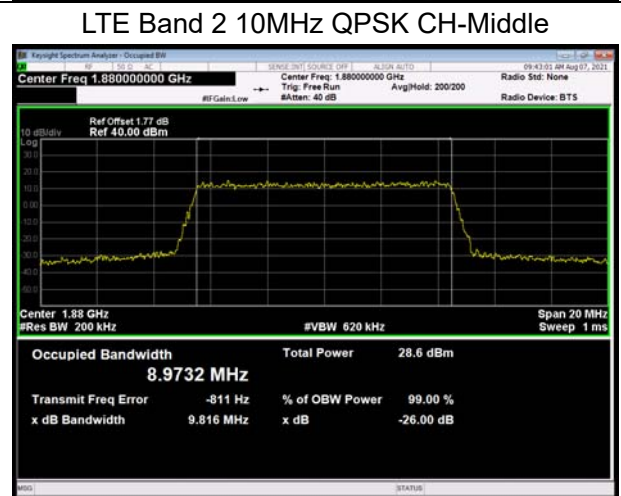
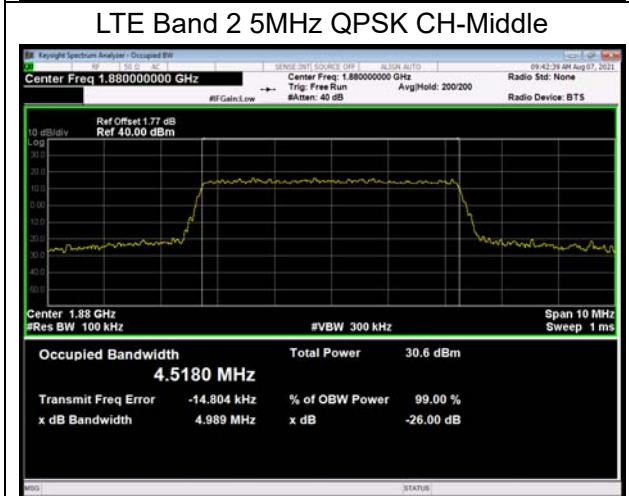
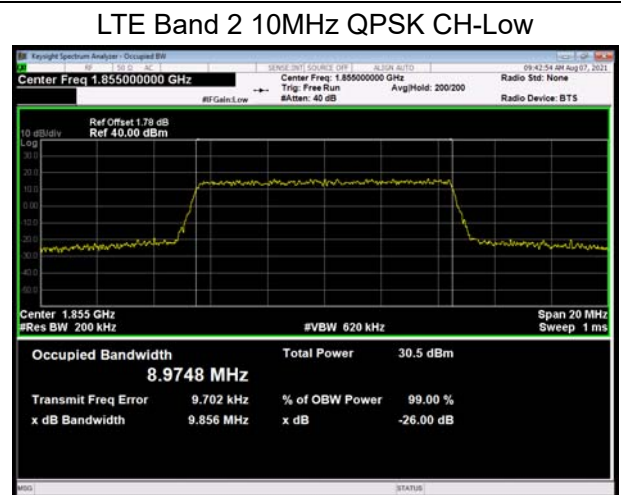
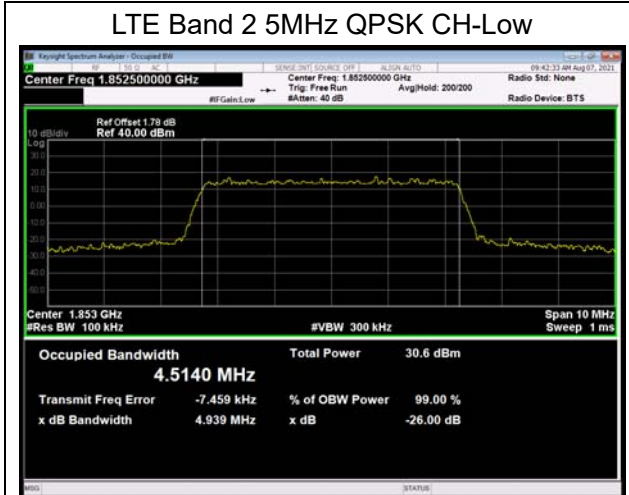

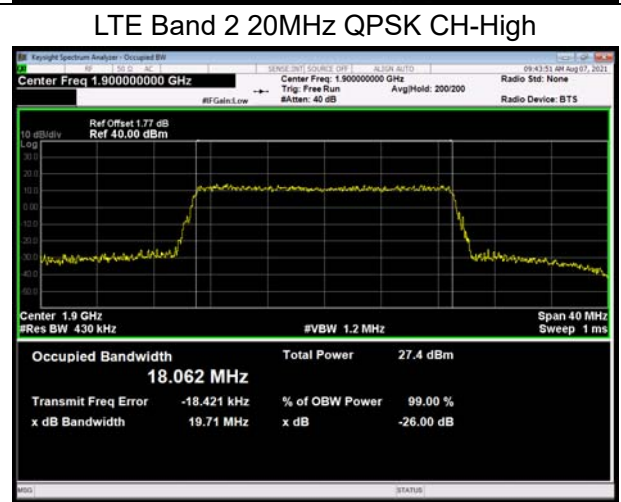
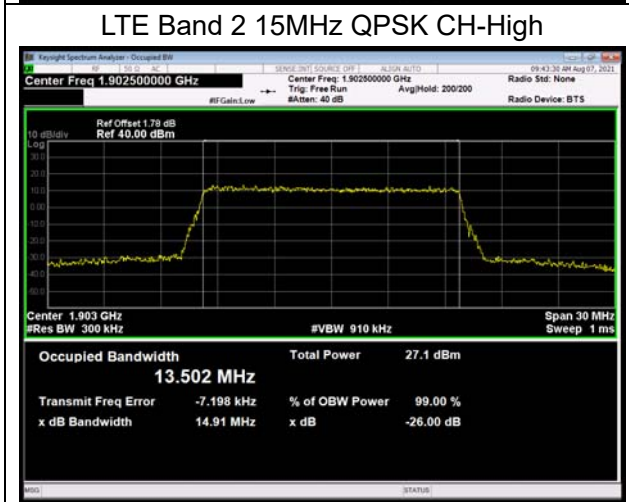
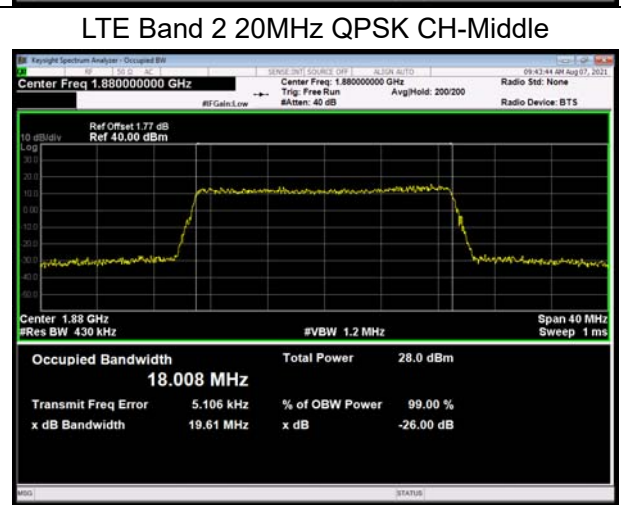
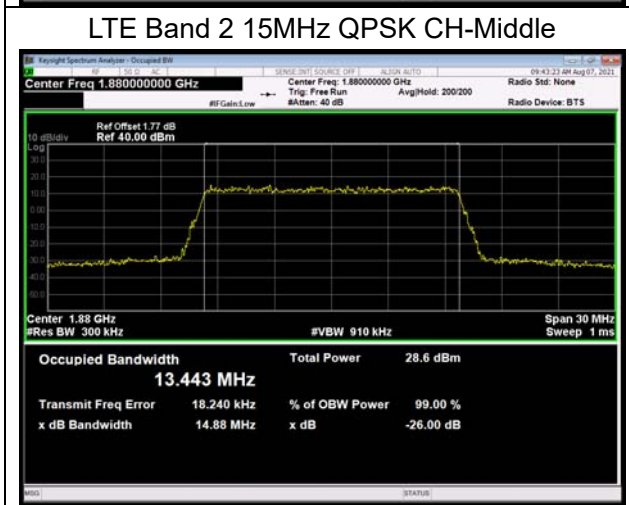
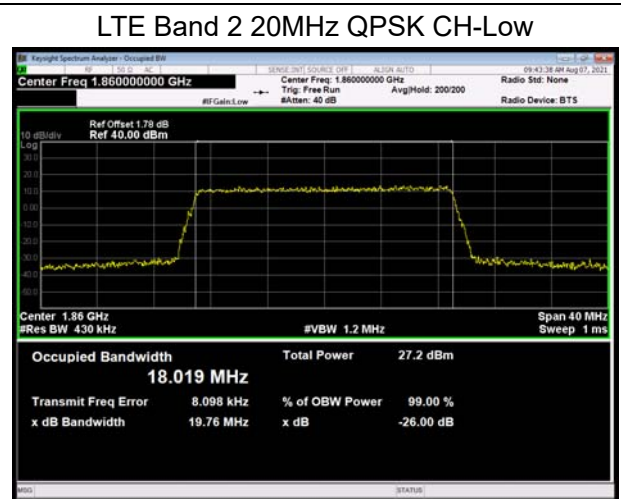
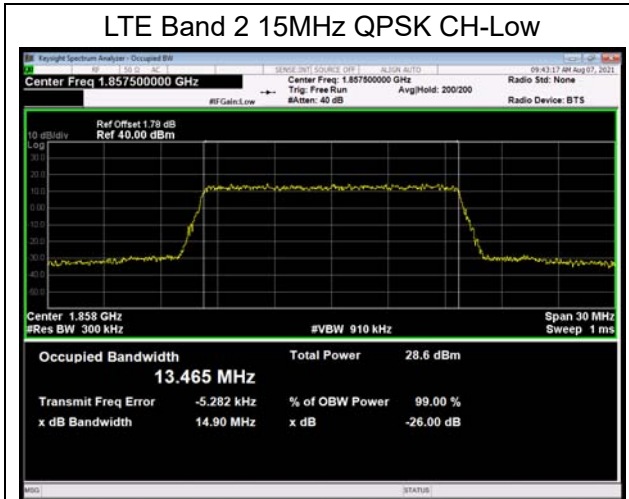



LTE Band 2 1.4MHz 16QAM CH-Low

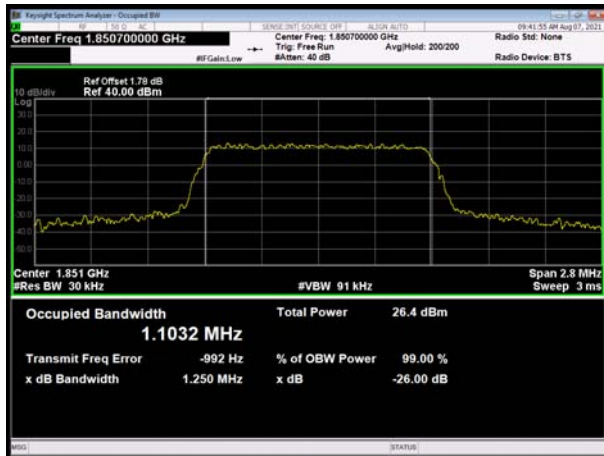

LTE Band 2 3MHz 16QAM CH-Low

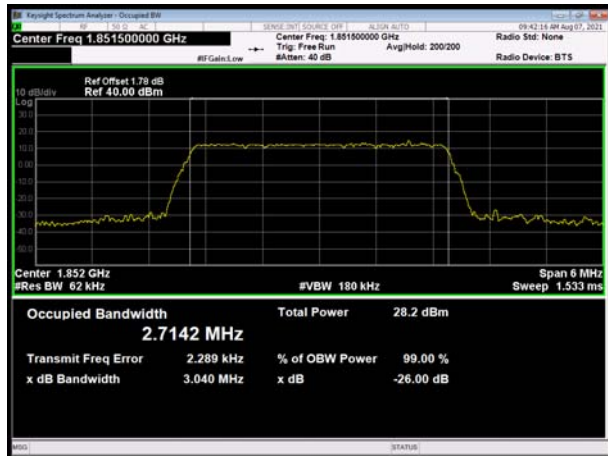

LTE Band 2 1.4MHz 16QAM CH-Middle

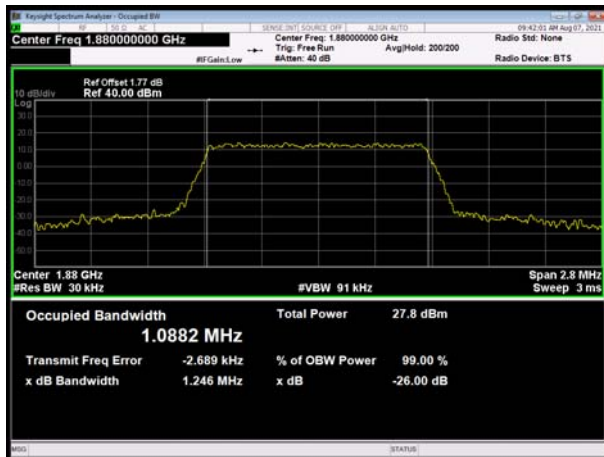

LTE Band 2 3MHz 16QAM CH-Middle

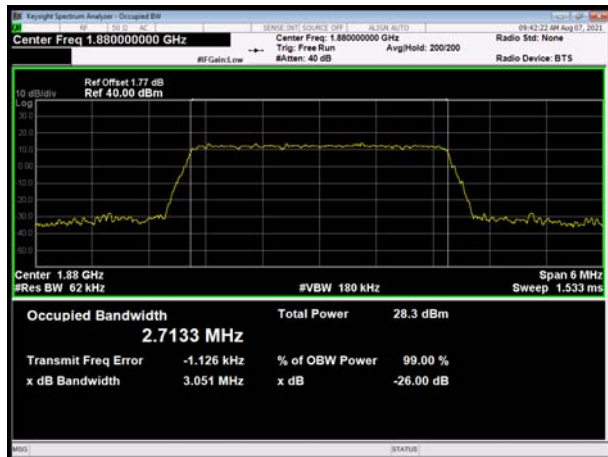

LTE Band 2 1.4MHz 16QAM CH-High

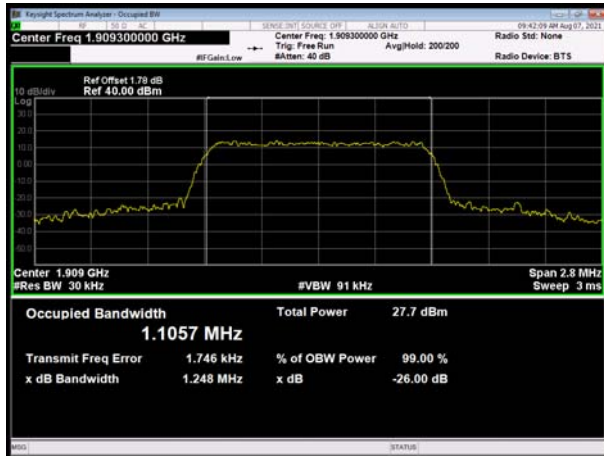

LTE Band 2 3MHz 16QAM CH-High

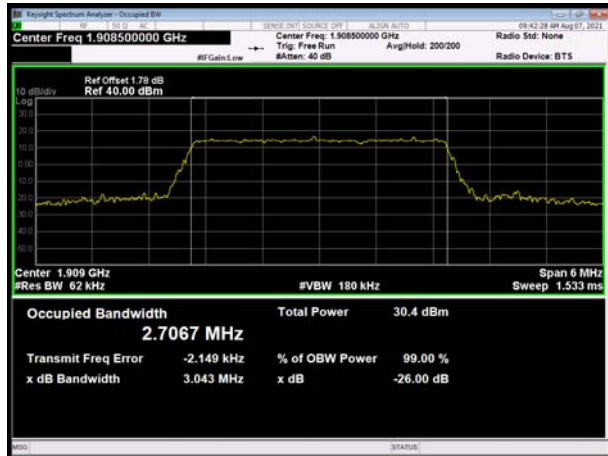

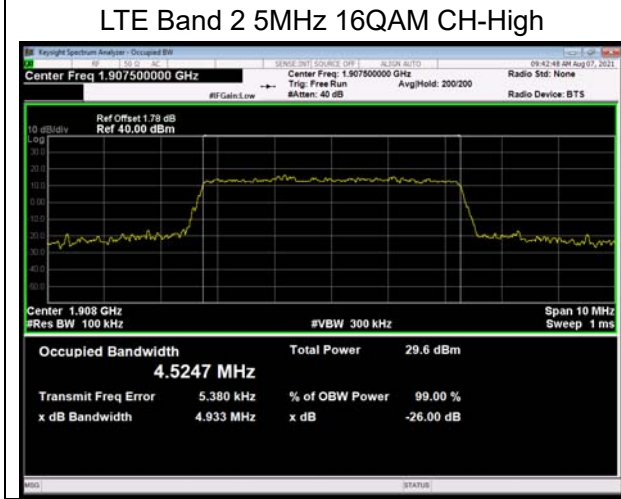
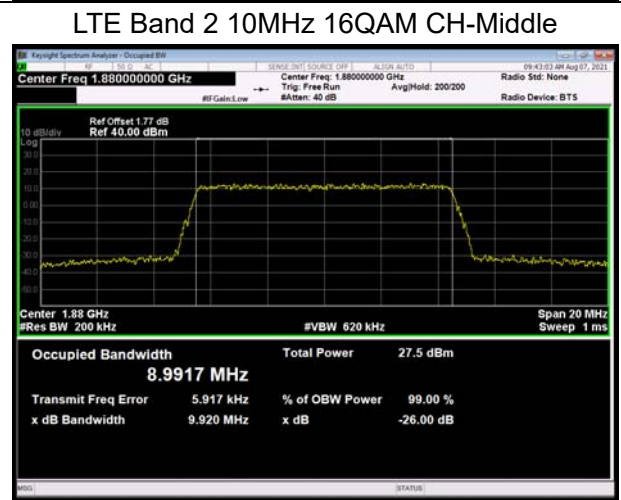
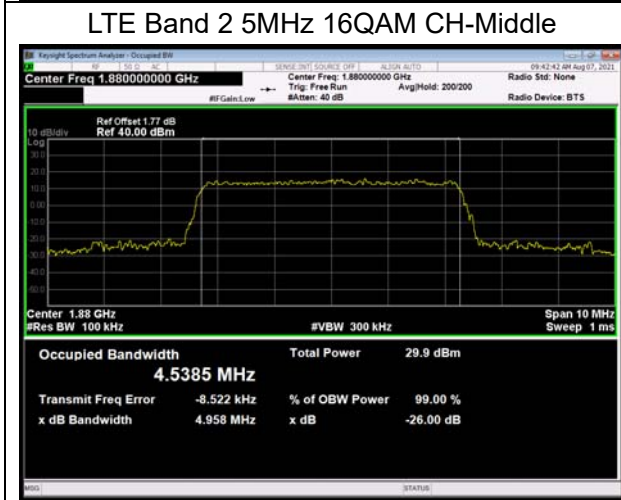
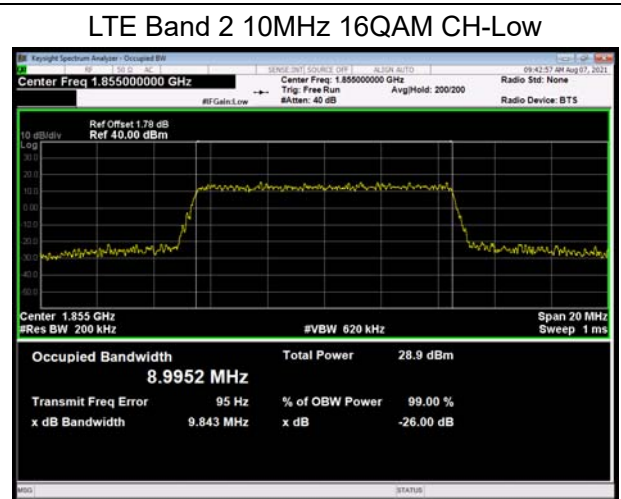
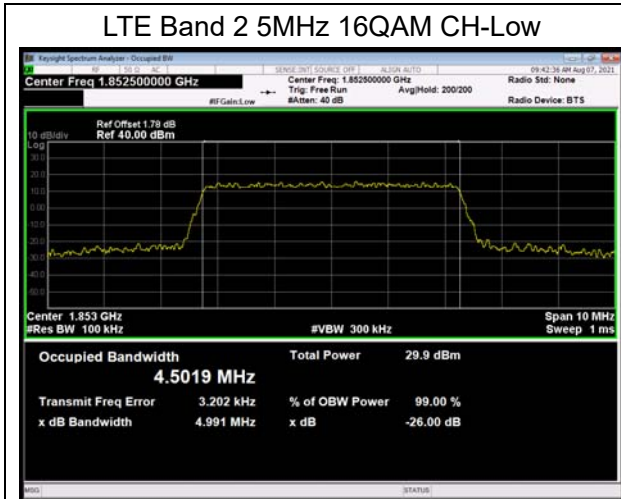

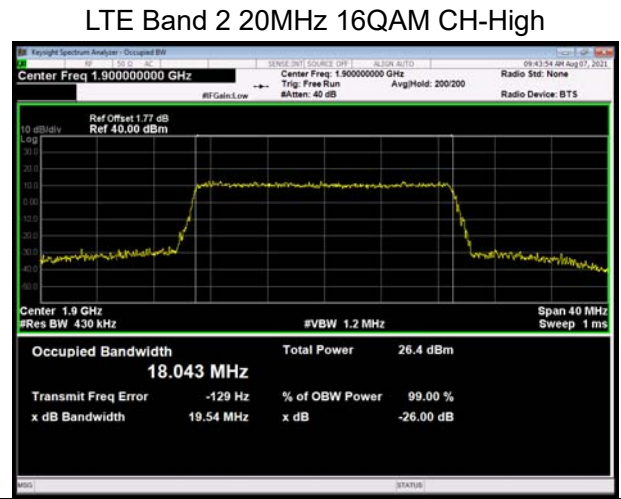
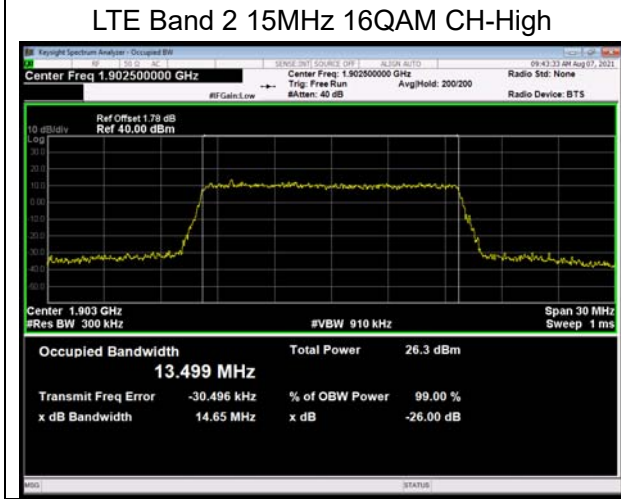
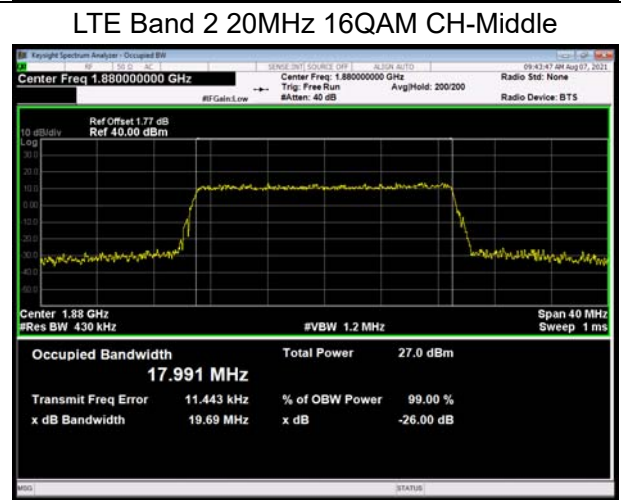
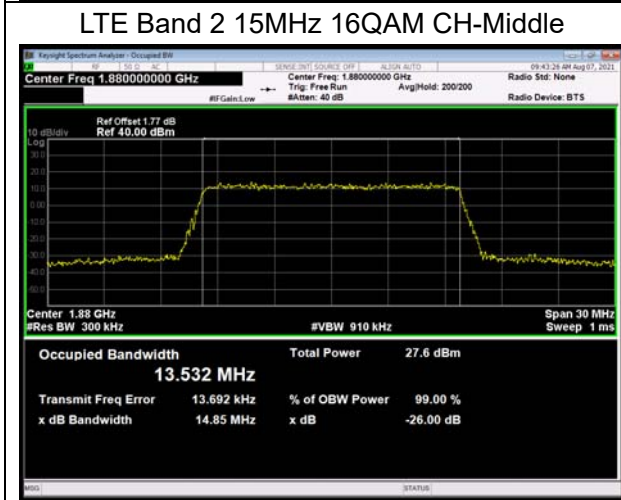
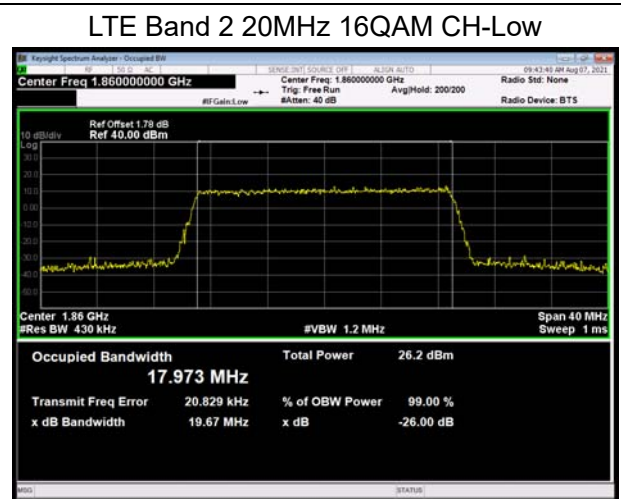
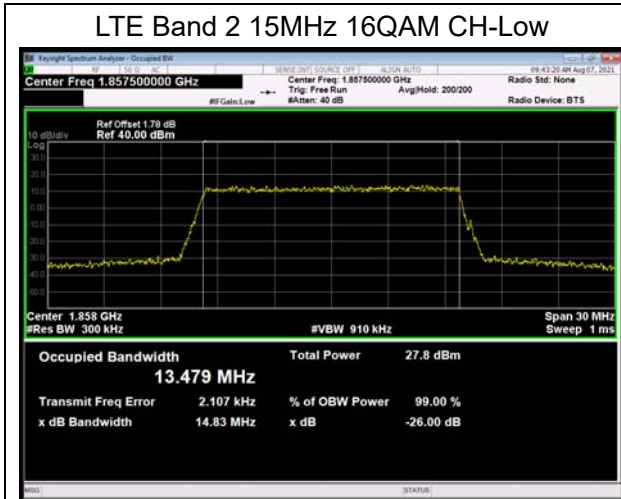



LTE Band 2 1.4MHz 64QAM CH-Low



LTE Band 2 3MHz 64QAM CH-Low

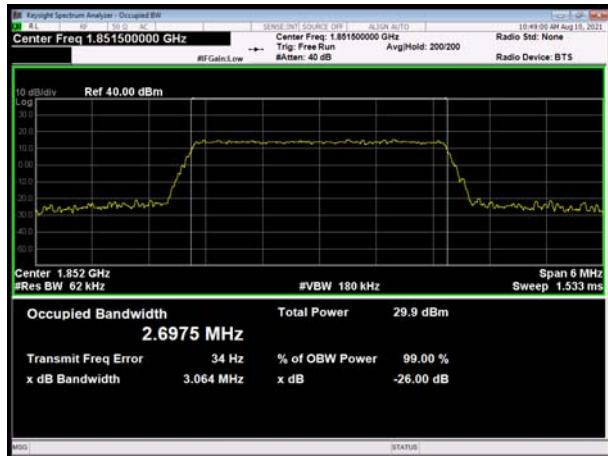

LTE Band 2 1.4MHz 64QAM CH-Middle

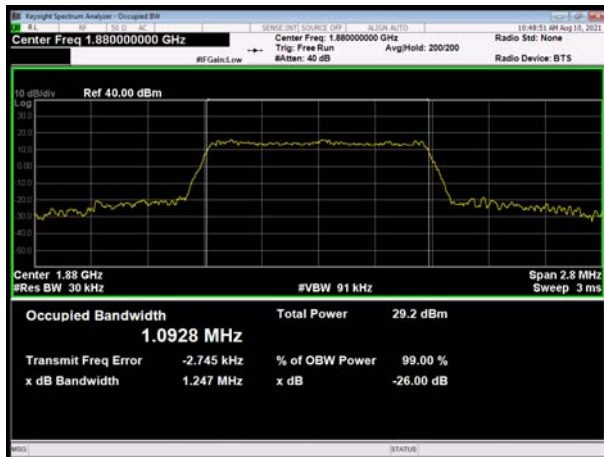

LTE Band 2 3MHz 64QAM CH-Middle

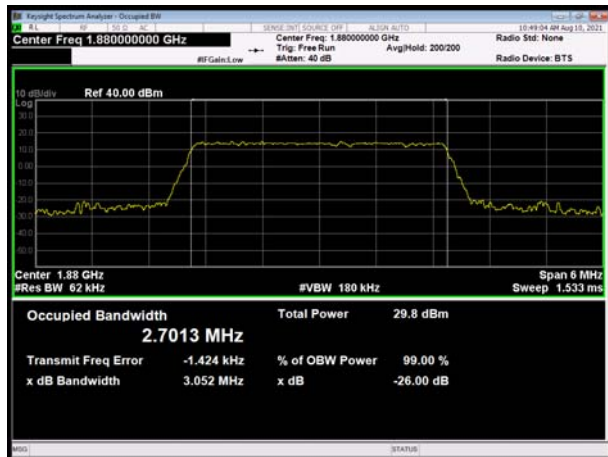

LTE Band 2 1.4MHz 64QAM CH-High

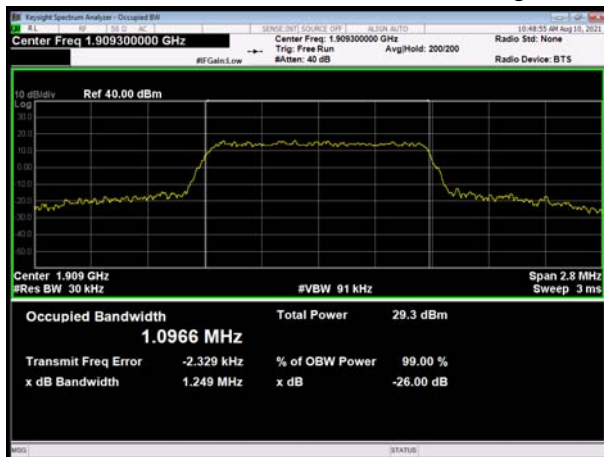

LTE Band 2 3MHz 64QAM CH-High

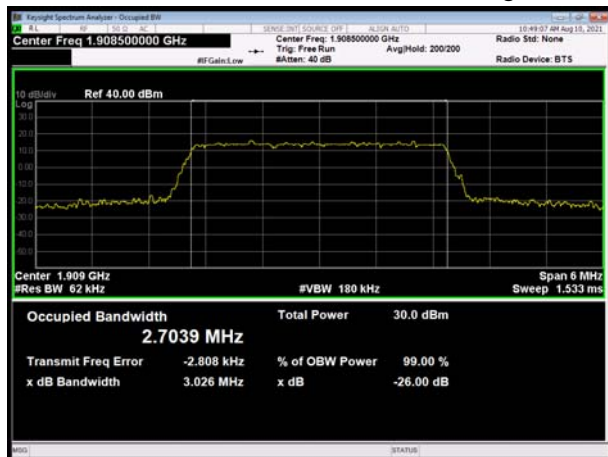

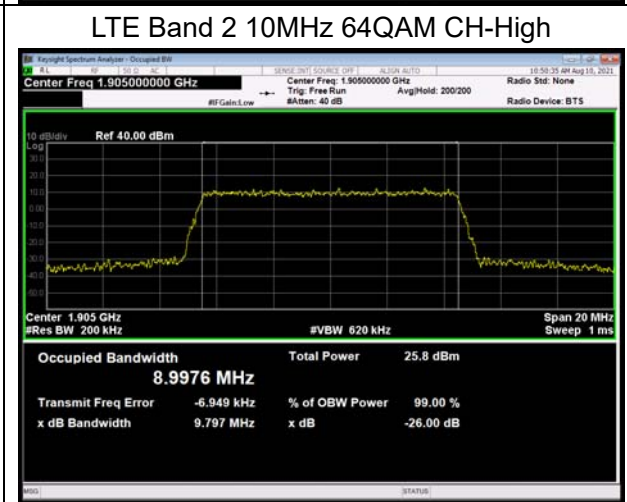
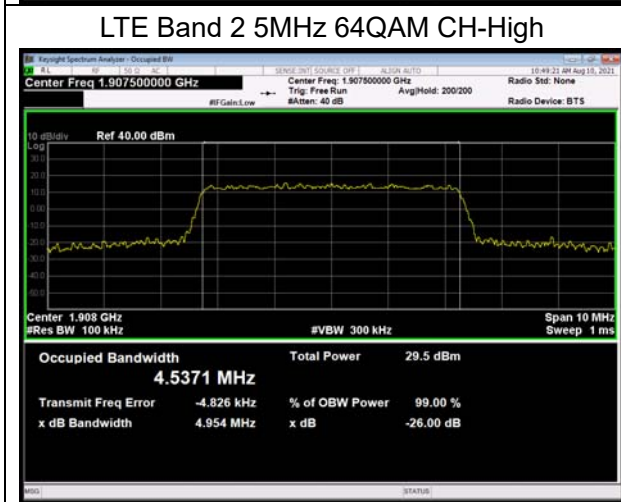
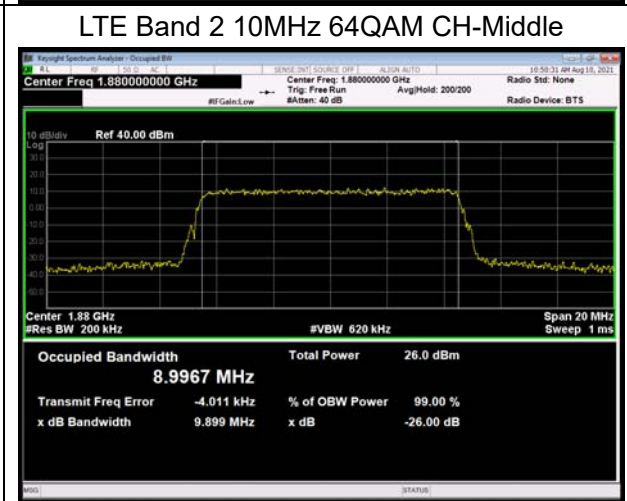
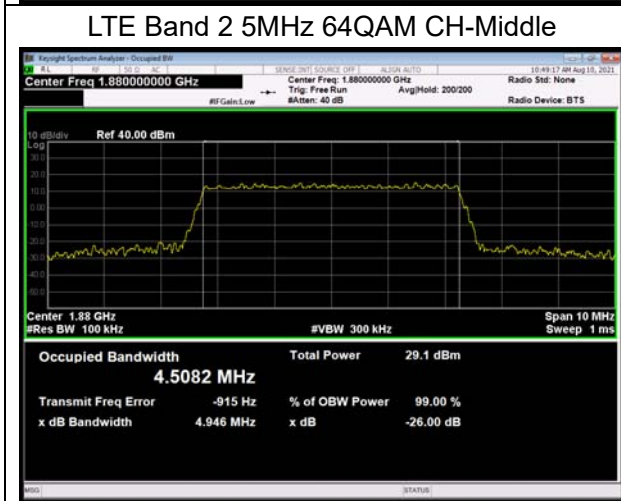
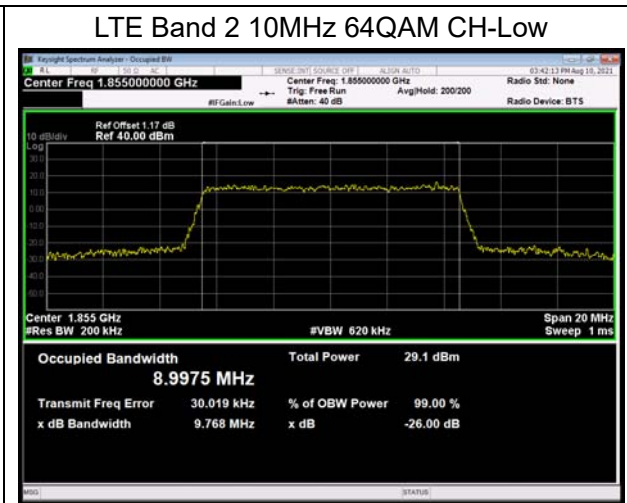
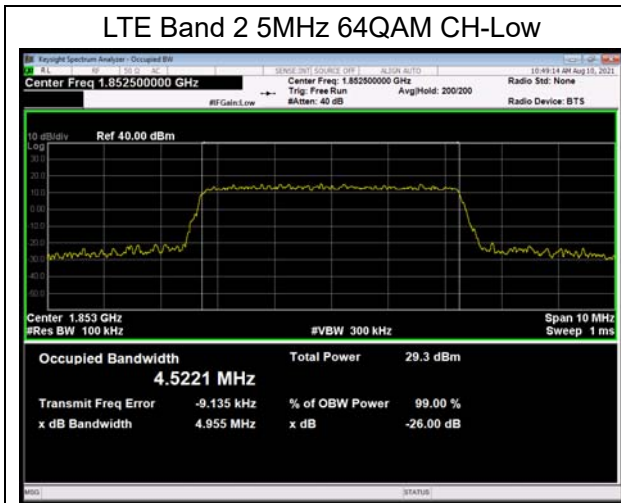

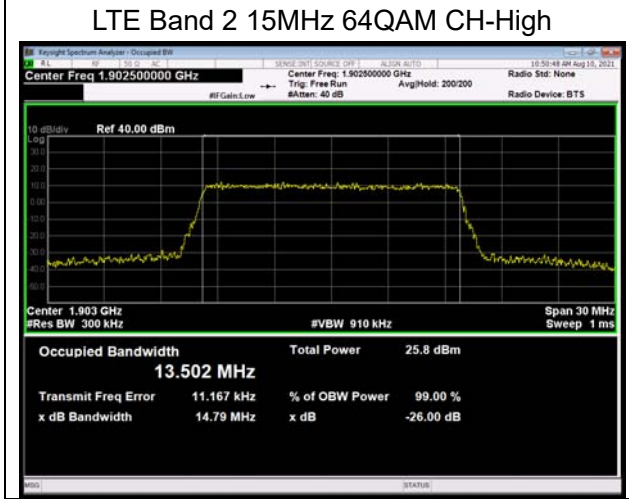
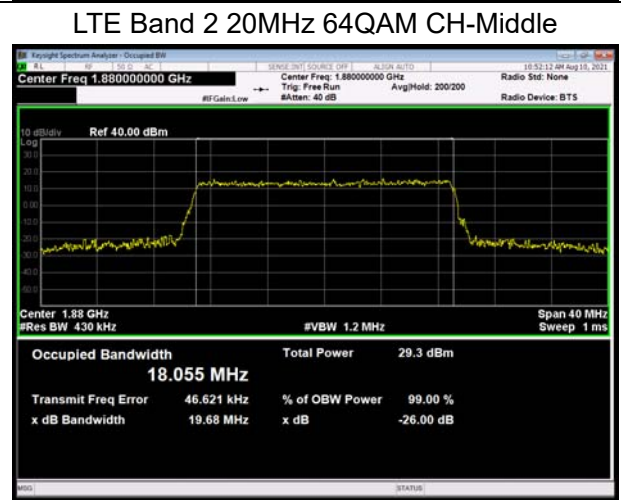
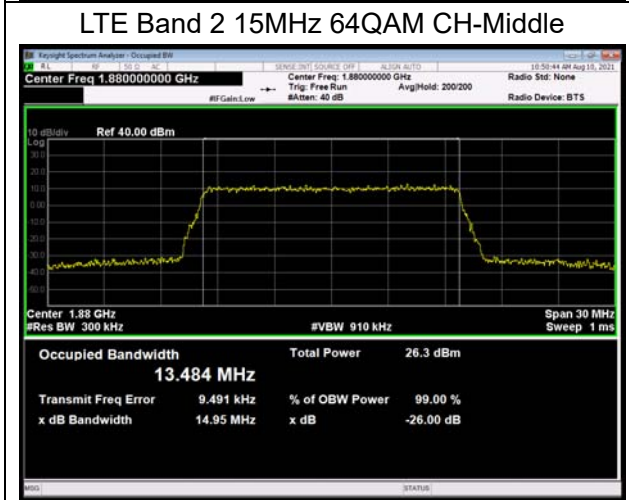
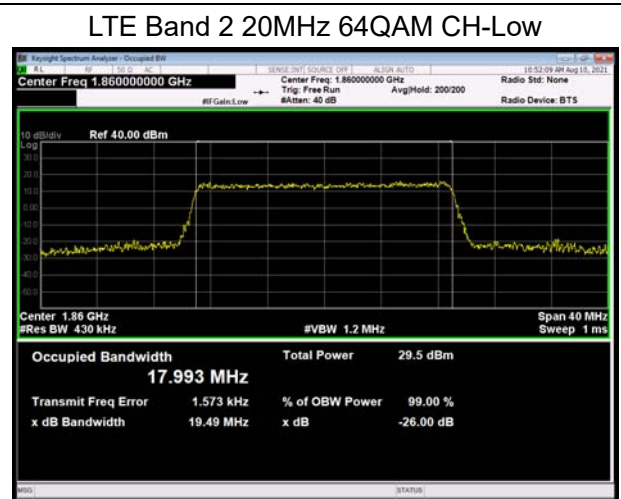
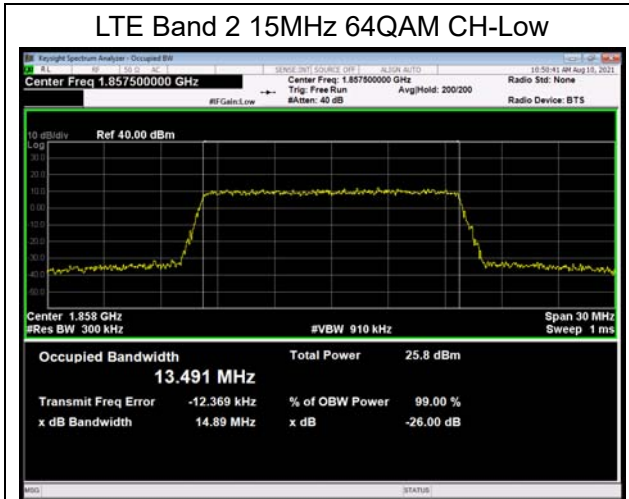

5.3. Band Edge Compliance

Ambient condition

Temperature	Relative humidity	Pressure
23°C ~25°C	45%~50%	101.5kPa

Method of Measurement

The EUT was connected to Spectrum Analyzer and Base Station Simulator via power Splitter. The band edge of the lowest and highest channels were measured. The Average detector is used and RBW is set to 6.2kHz, VBW is set to 20kHz for GSM 1900, RBW is set to 51kHz, VBW is set to 160kHz for WCDMA Band II, RBW is set to 15kHz, VBW is set to 43kHz for LTE Band 2 (1.4MHz), RBW is set to 33kHz, VBW is set to 100kHz for LTE Band 2 (3MHz), RBW is set to 51kHz, VBW is set to 150kHz for LTE Band 2 (5MHz), RBW is set to 100kHz, VBW is set to 300kHz for LTE Band 2 (10MHz), RBW is set to 150kHz, VBW is set to 470kHz for LTE Band 2 (15MHz), RBW is set to 200kHz, VBW is set to 620kHz for LTE Band 2 (20MHz).

Spectrum analyzer plots are included on the following pages.

Test Setup

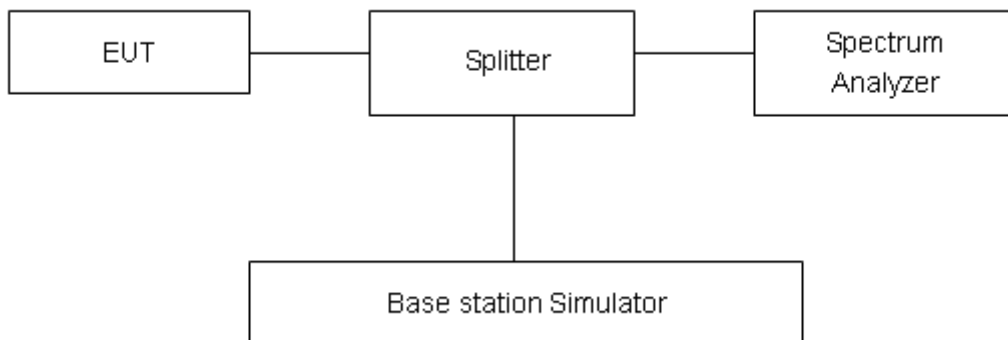

Limits

Rule Part 24.238(a) specifies that “on any frequency outside a licensee’s frequency block, the power of any emission shall be attenuated below the transmitter power (P) by at least 43 + 10 log10 (P) dB.”

Limit	-13 dBm
-------	---------

Measurement Uncertainty

The assessed measurement uncertainty to ensure 95% confidence level for the normal distribution is with the coverage factor $k = 1.96$, $U=0.684$ dB.

Test Result:

GSM1900 GSM CH-Low



GSM 1900 GSM CH-High



GSM1900 GPRS CH-Low



GSM 1900 GPRS CH-High



GSM1900 EGPRS CH-Low

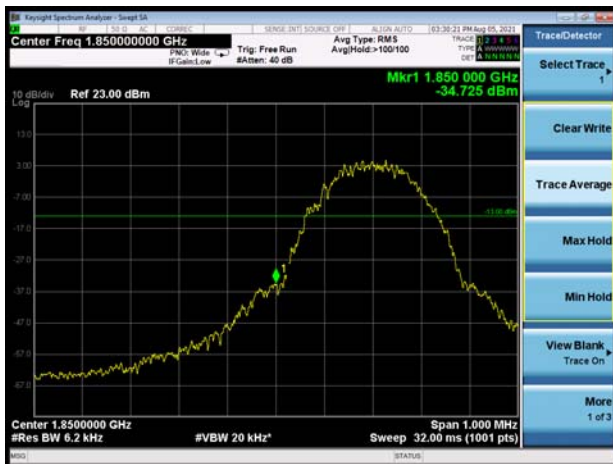

GSM 1900 EGPRS CH-High





WCDMA Band II RMC CH-Low



WCDMA Band II RMC CH-High



LTE Band 2 1.4MHz QPSK 1RB CH-Low

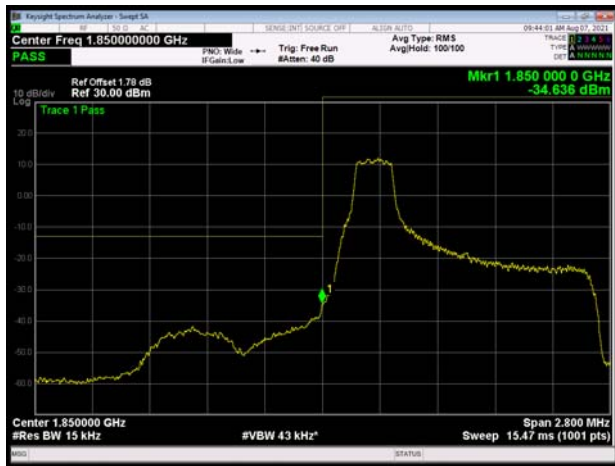

LTE Band 2 1.4MHz QPSK 1RB CH-High



LTE Band 2 1.4MHz QPSK 100%RB CH-Low



LTE Band 2 1.4MHz QPSK 100%RB CH-High





LTE Band 2 3MHz QPSK 1RB CH-Low

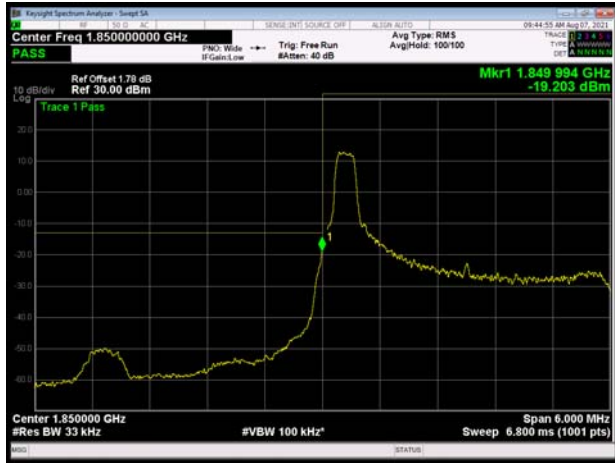

LTE Band 2 3MHz QPSK 1RB CH-High

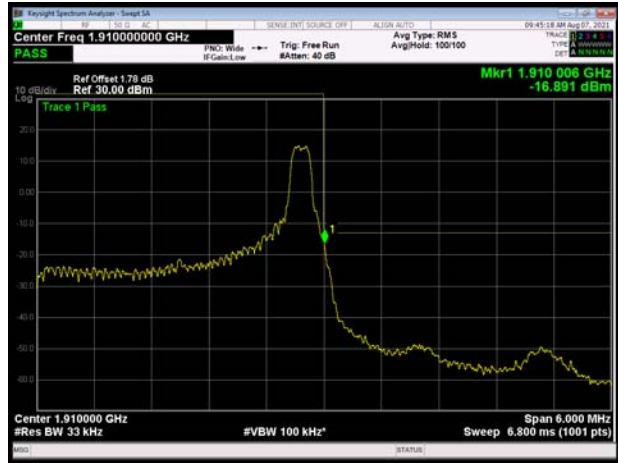

LTE Band 2 3MHz QPSK 100%RB CH-Low

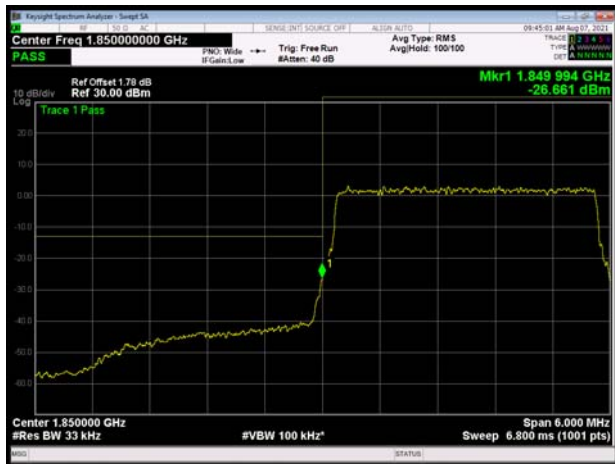

LTE Band 2 3MHz QPSK 100%RB CH-High



LTE Band 2 5MHz QPSK 1RB CH-Low

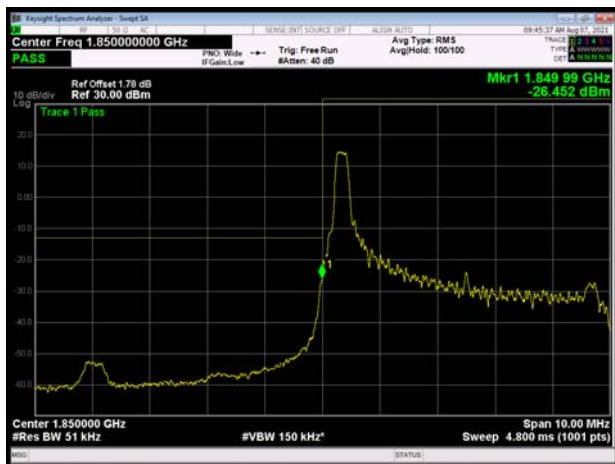

LTE Band 2 5MHz QPSK 1RB CH-High

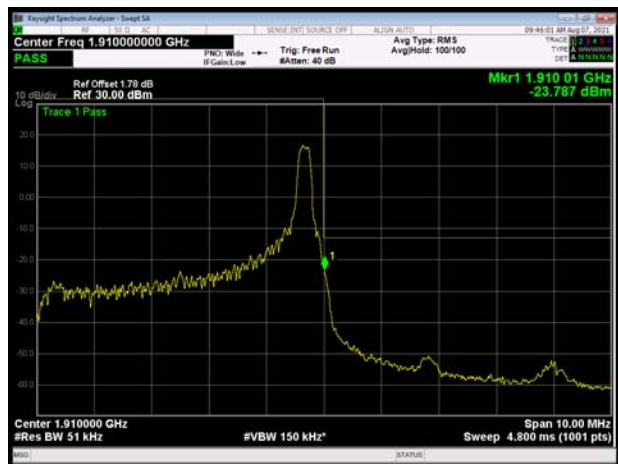



LTE Band 2 5MHz QPSK 100%RB CH-Low

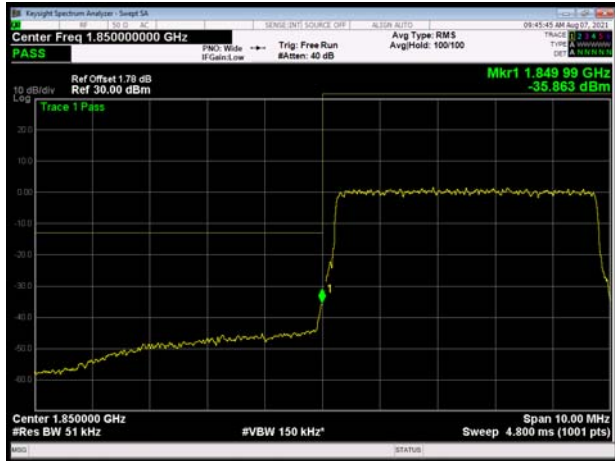

LTE Band 2 5MHz QPSK 100%RB CH-High



LTE Band 2 10MHz QPSK 1RB CH-Low

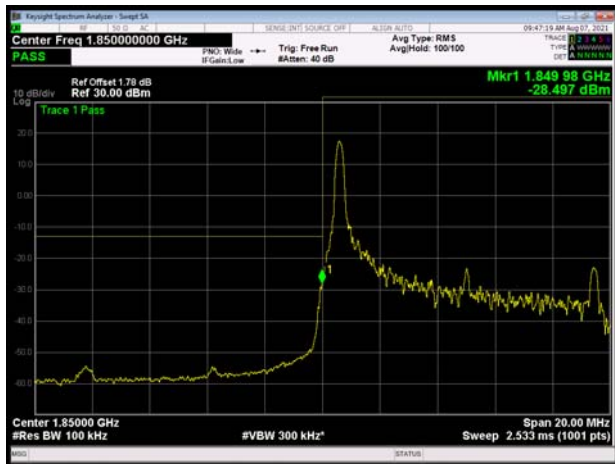

LTE Band 2 10MHz QPSK 1RB CH-High

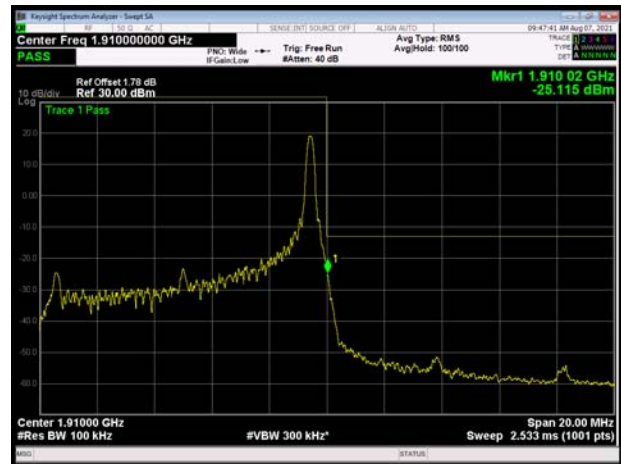

LTE Band 2 10MHz QPSK 100%RB CH-Low

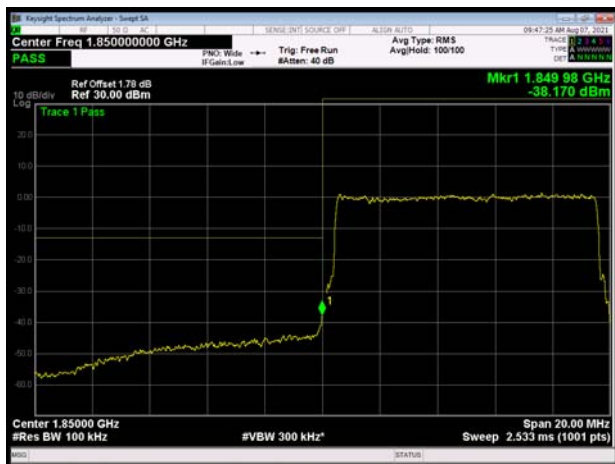

LTE Band 2 10MHz QPSK 100%RB CH-High



LTE Band 2 15MHz QPSK 1RB CH-Low

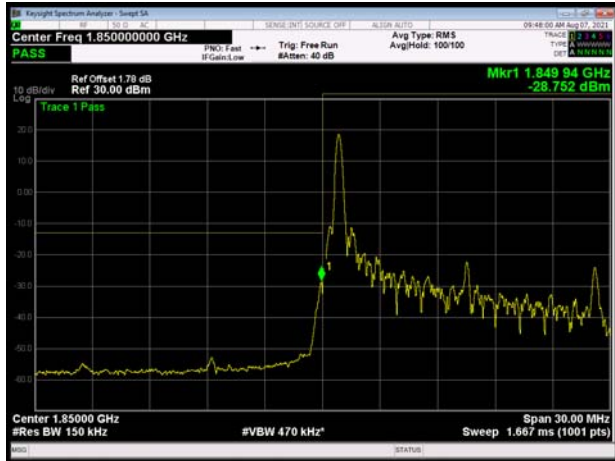

LTE Band 2 15MHz QPSK 1RB CH-High

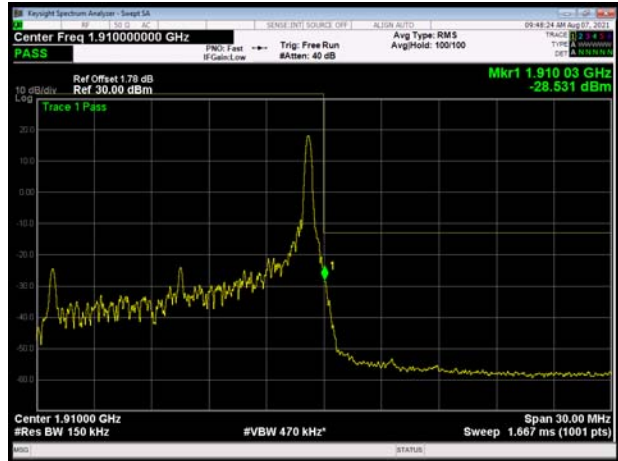

LTE Band 2 15MHz QPSK 100%RB CH-Low

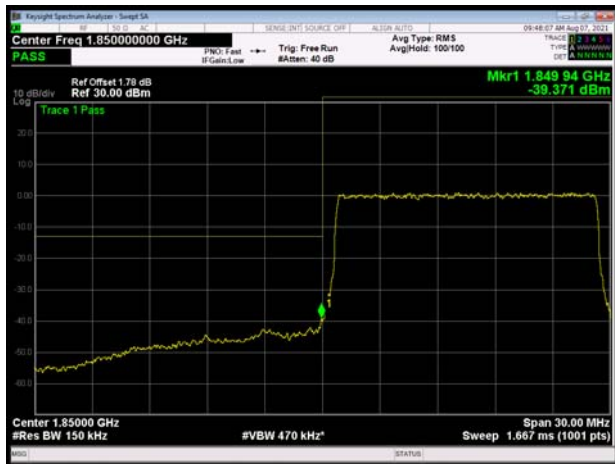

LTE Band 2 15MHz QPSK 100%RB CH-High



LTE Band 2 20MHz QPSK 1RB CH-Low

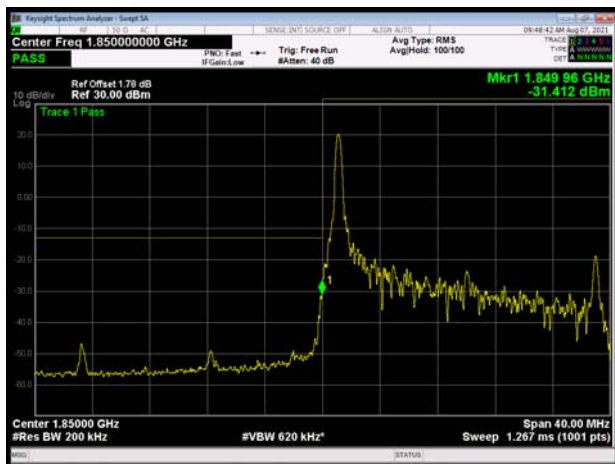

LTE Band 2 20MHz QPSK 1RB CH-High

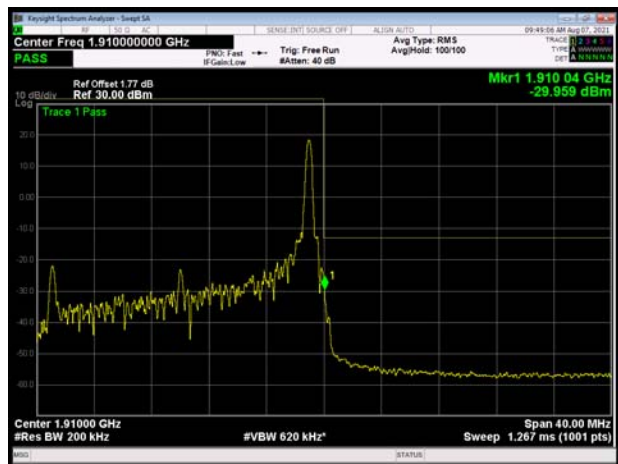

LTE Band 2 20MHz QPSK 100%RB CH-Low

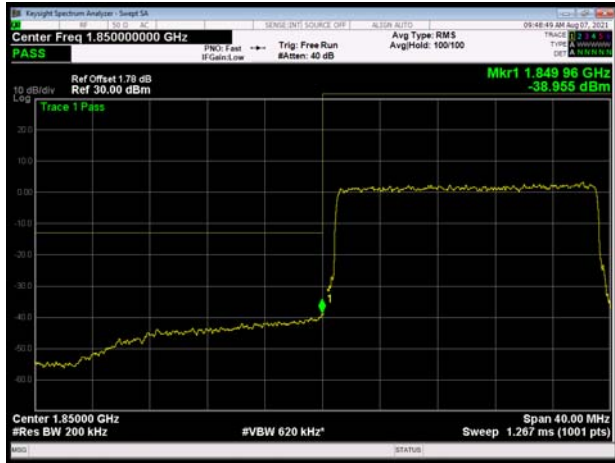

LTE Band 2 20MHz QPSK 100%RB CH-High



LTE Band 2 1.4MHz 16QAM 1RB CH-Low

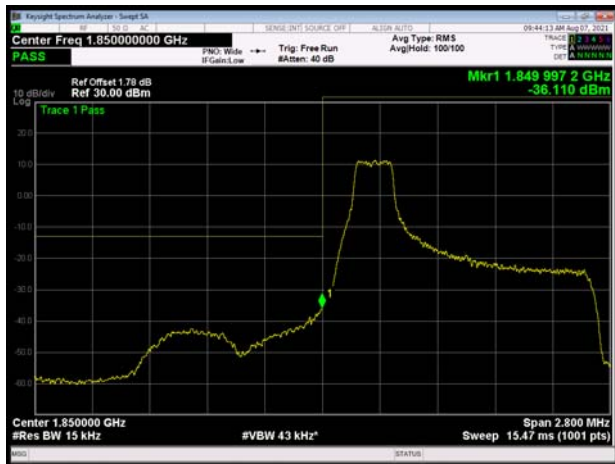

LTE Band 2 1.4MHz 16QAM 1RB CH-High

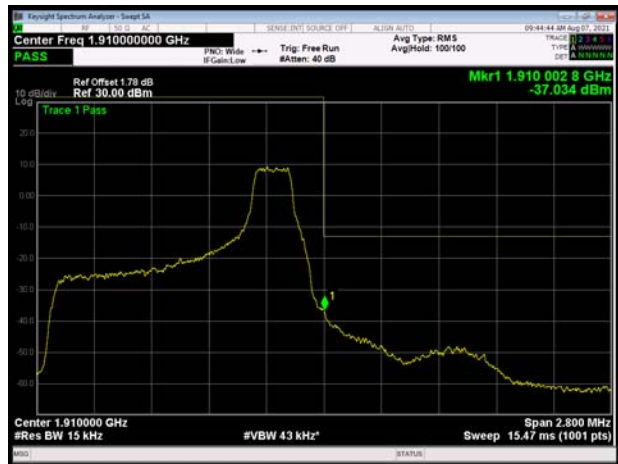

LTE Band 2 1.4MHz 16QAM 100%RB CH-Low



LTE Band 2 1.4MHz 16QAM 100%RB CH-High





LTE Band 2 3MHz 16QAM 1RB CH-Low

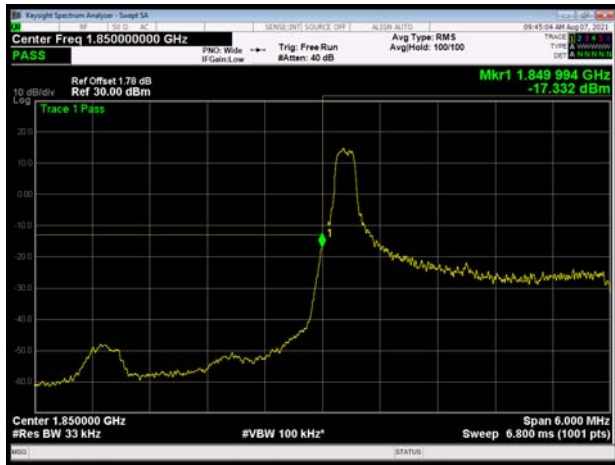

LTE Band 2 3MHz 16QAM 1RB CH-High

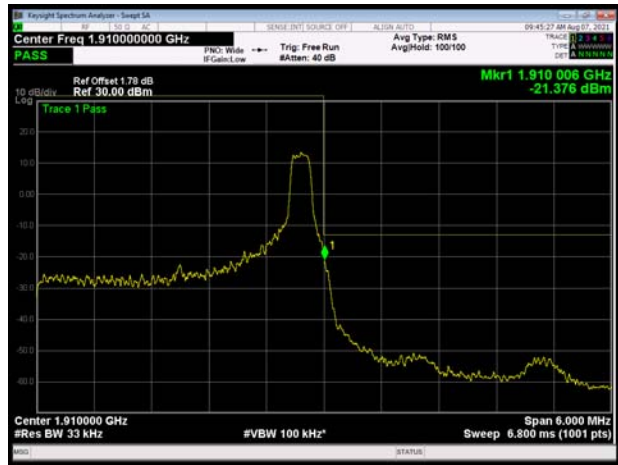

LTE Band 2 3MHz 16QAM 100%RB CH-Low

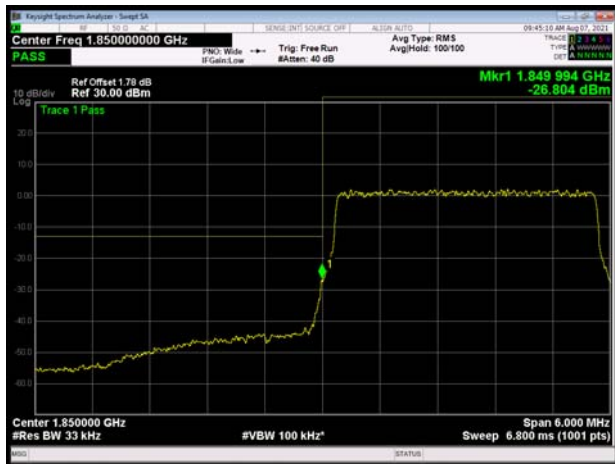

LTE Band 2 3MHz 16QAM 100%RB CH-High



LTE Band 2 5MHz 16QAM 1RB CH-Low

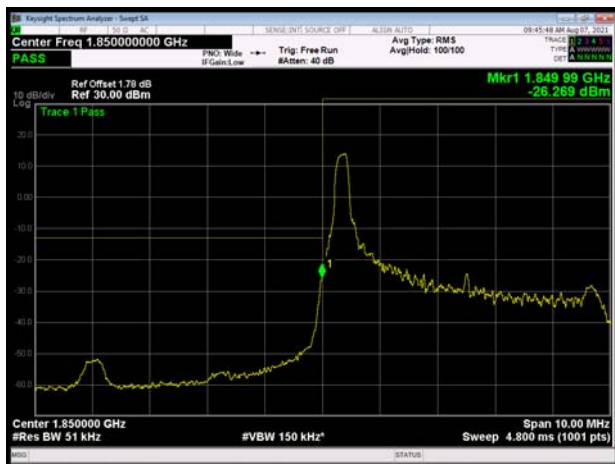

LTE Band 2 5MHz 16QAM 1RB CH-High

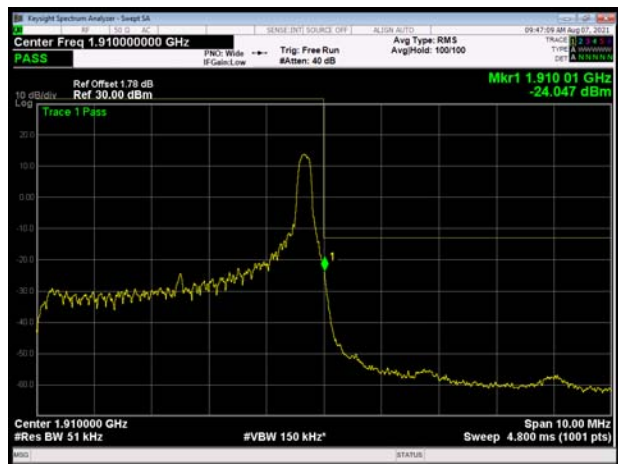



LTE Band 2 5MHz 16QAM 100%RB CH-Low

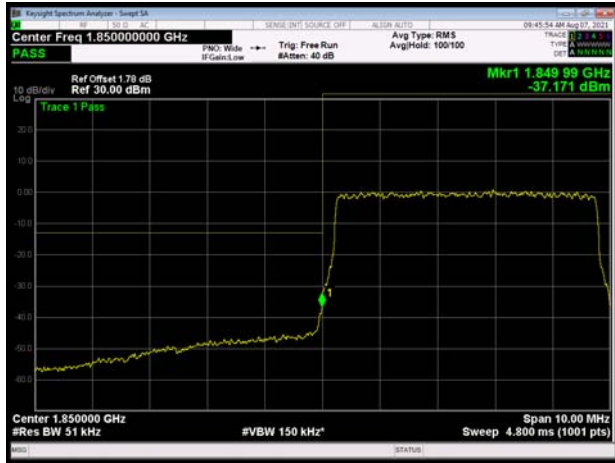

LTE Band 2 5MHz 16QAM 100%RB CH-High

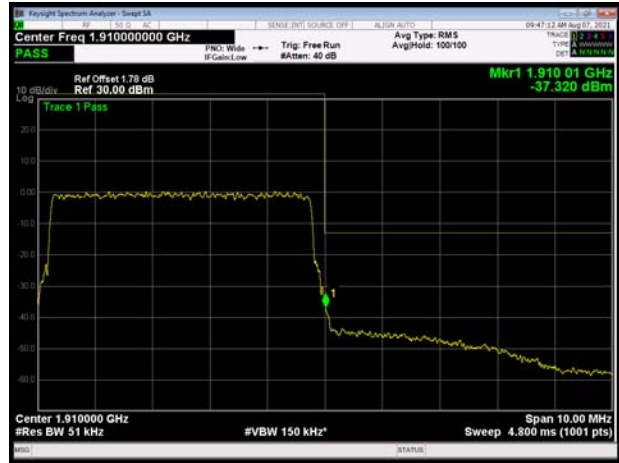

LTE Band 2 10MHz 16QAM 1RB CH-Low

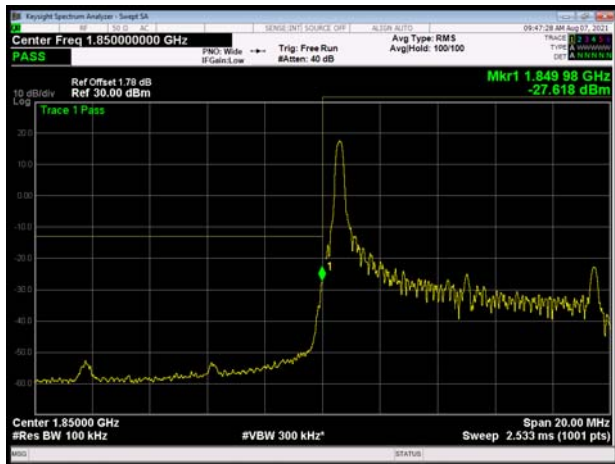

LTE Band 2 10MHz 16QAM 1RB CH-High

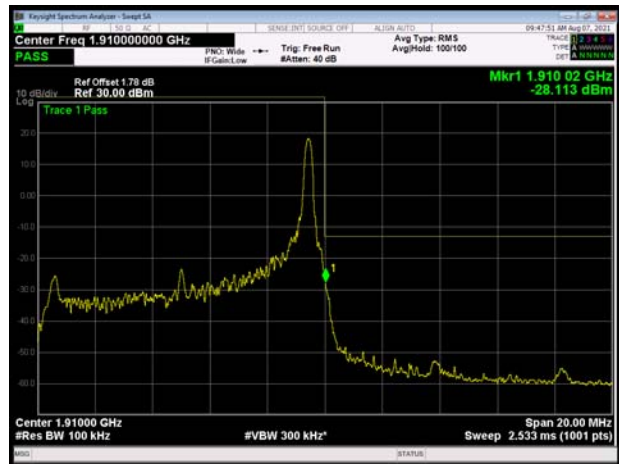

LTE Band 2 10MHz 16QAM 100%RB CH-Low

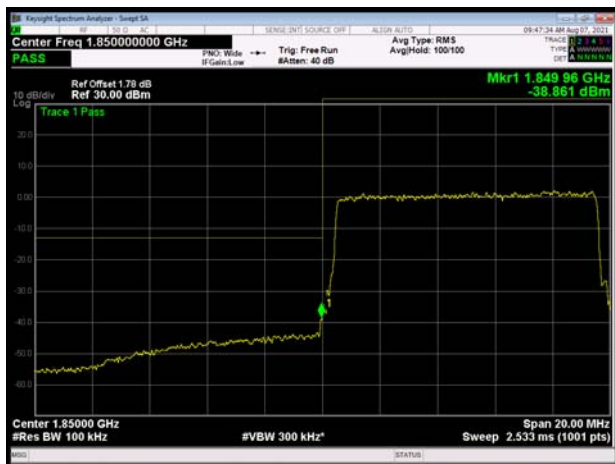

LTE Band 2 10MHz 16QAM 100%RB CH-High





LTE Band 2 15MHz 16QAM 1RB CH-Low

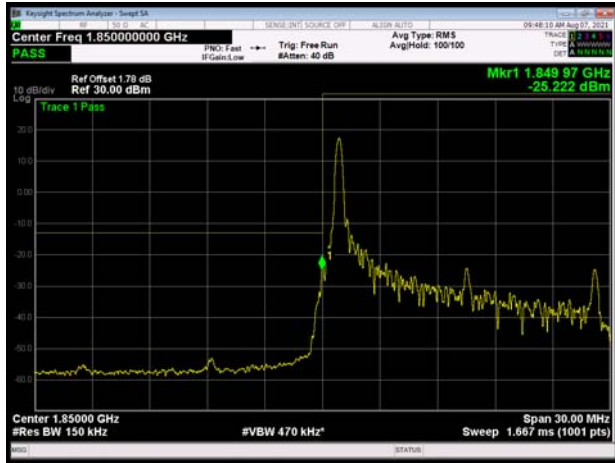

LTE Band 2 15MHz 16QAM 1RB CH-High

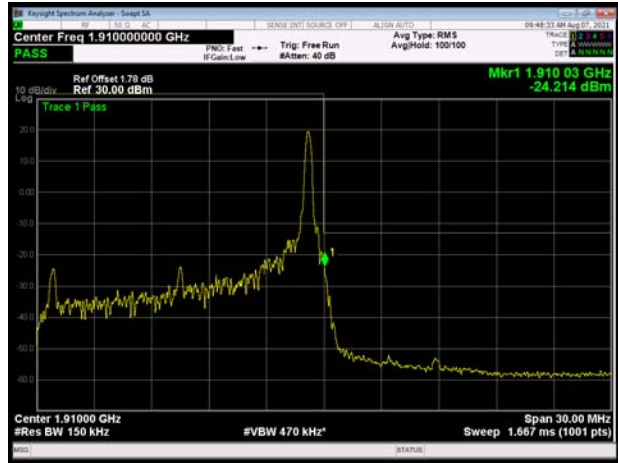

LTE Band 2 15MHz 16QAM 100%RB CH-Low

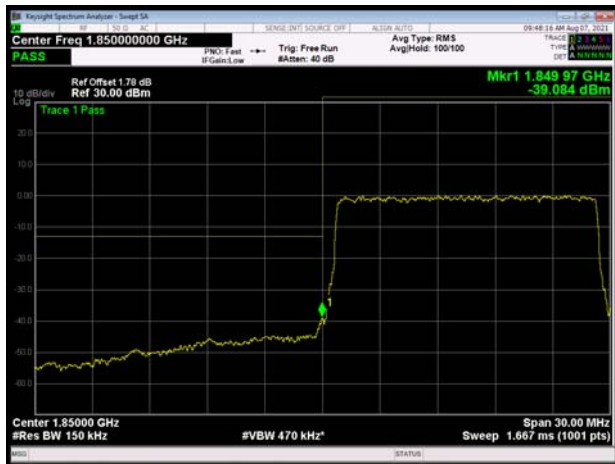

LTE Band 2 15MHz 16QAM 100%RB CH-High



LTE Band 2 20MHz 16QAM 1RB CH-Low

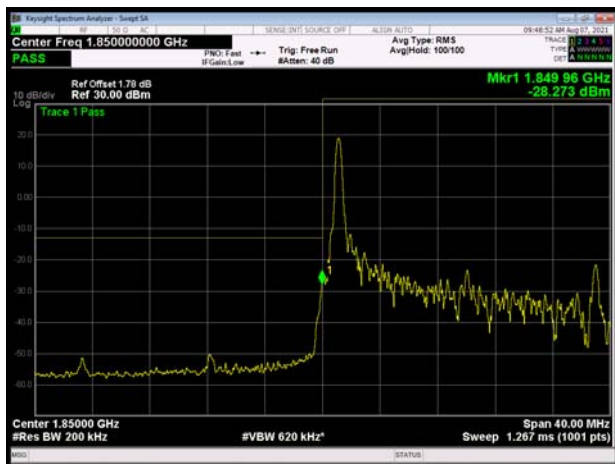

LTE Band 2 20MHz 16QAM 1RB CH-High

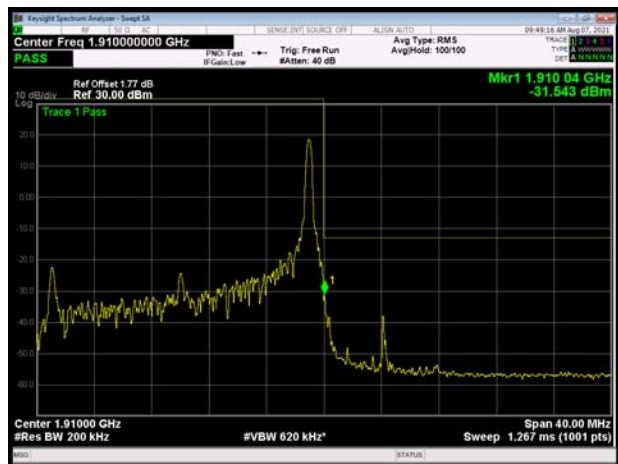



LTE Band 2 20MHz 16QAM 100%RB CH-Low

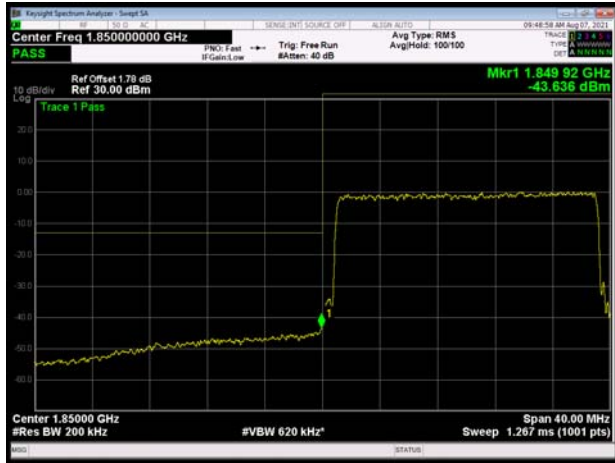

LTE Band 2 20MHz 16QAM 100%RB CH-High

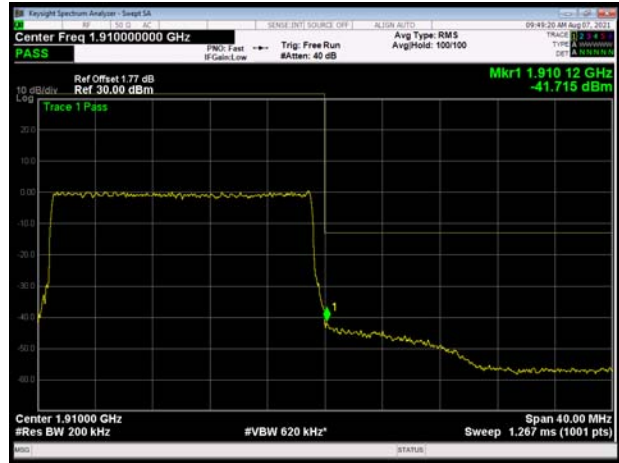

LTE Band 2 1.4MHz 64QAM 1RB CH-Low

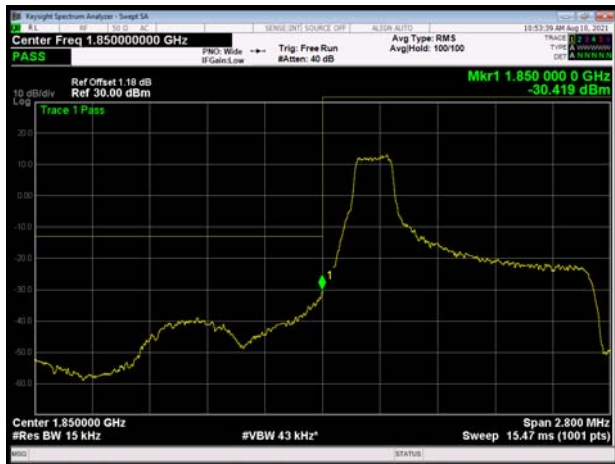

LTE Band 2 1.4MHz 64QAM 1RB CH-High

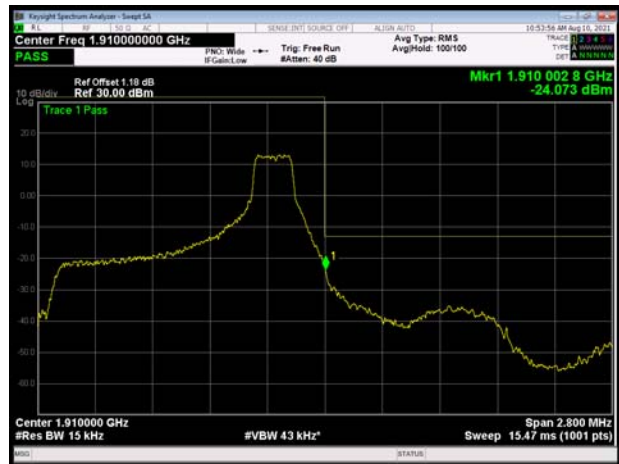

LTE Band 2 1.4MHz 64QAM 100%RB CH-Low



LTE Band 2 1.4MHz 64QAM 100%RB CH-High





LTE Band 2 3MHz 64QAM 1RB CH-Low

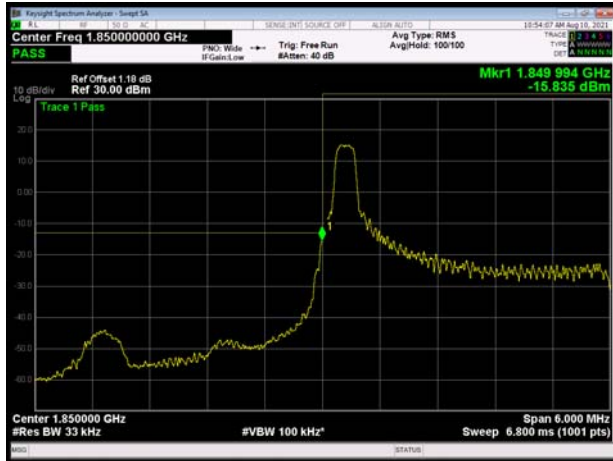

LTE Band 2 3MHz 64QAM 1RB CH-High

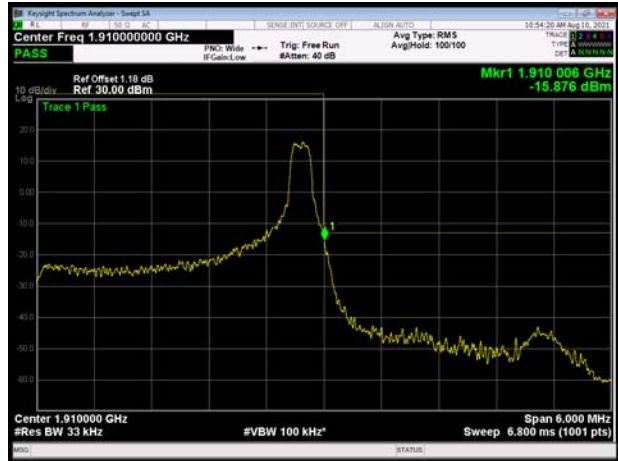

LTE Band 2 3MHz 64QAM 100%RB CH-Low

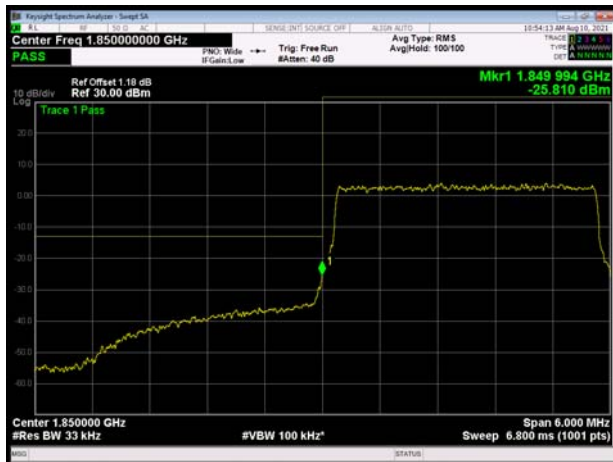

LTE Band 2 3MHz 64QAM 100%RB CH-High

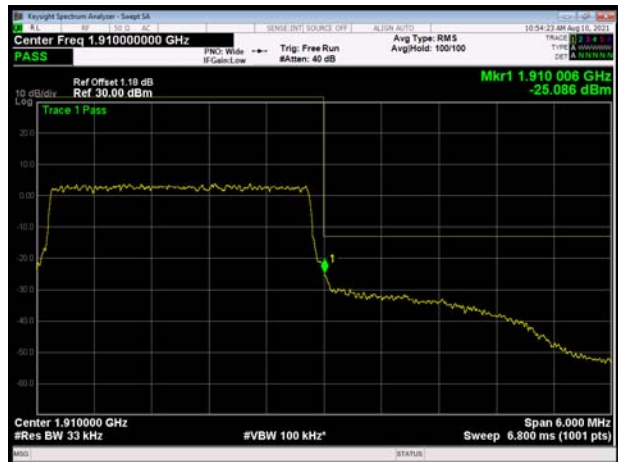

LTE Band 2 5MHz 64QAM 1RB CH-Low

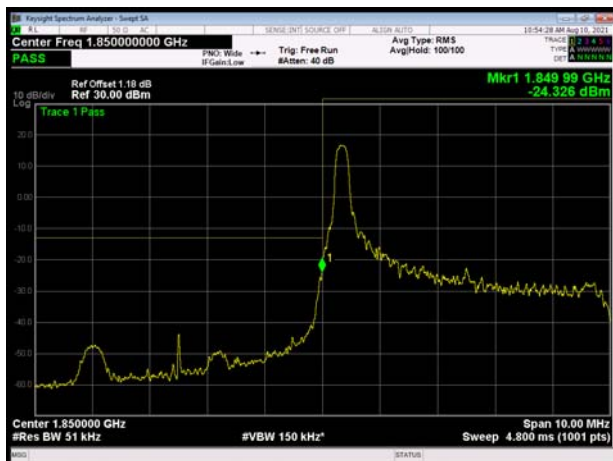

LTE Band 2 5MHz 64QAM 1RB CH-High

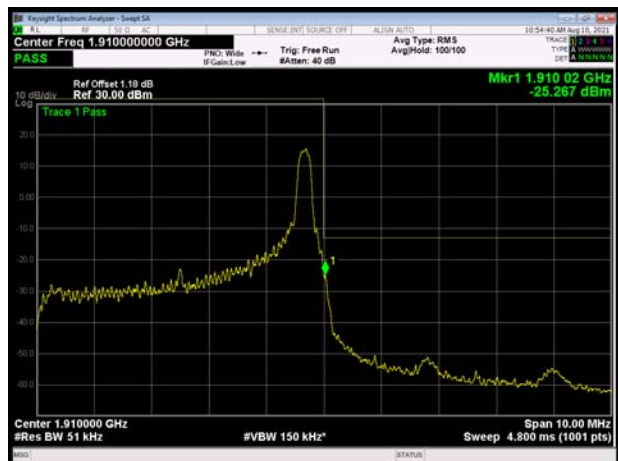



LTE Band 2 5MHz 64QAM 100%RB CH-Low

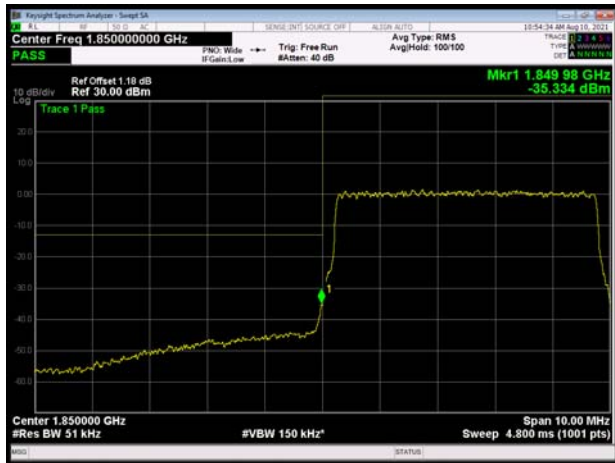

LTE Band 2 5MHz 64QAM 100%RB CH-High



LTE Band 2 10MHz 64QAM 1RB CH-Low

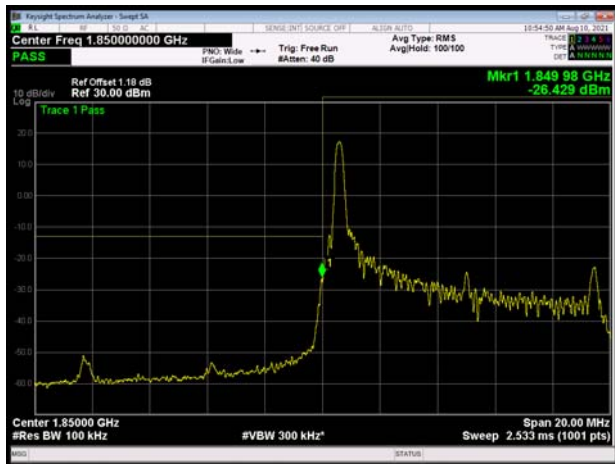

LTE Band 2 10MHz 64QAM 1RB CH-High

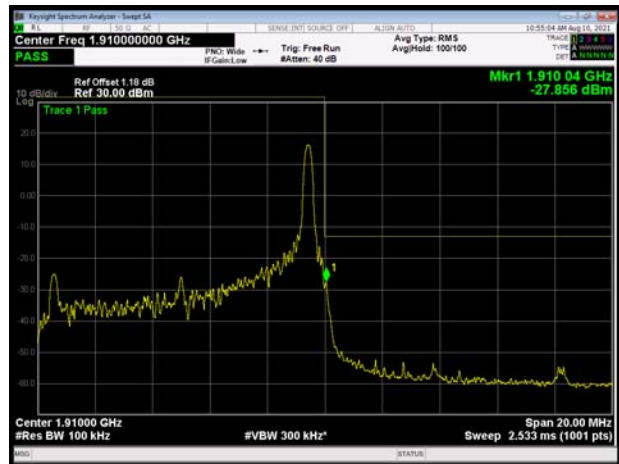

LTE Band 2 10MHz 64QAM 100%RB CH-Low

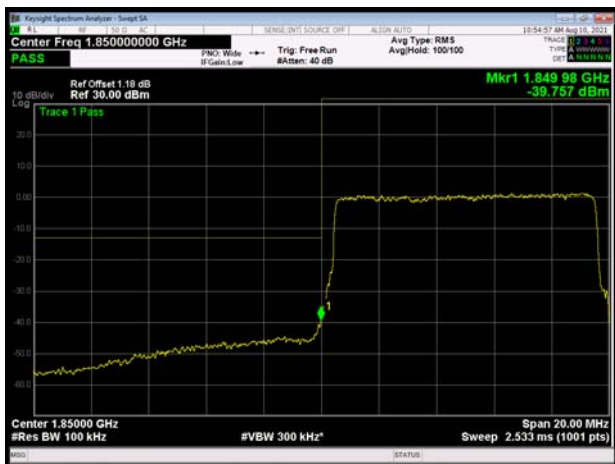

LTE Band 2 10MHz 64QAM 100%RB CH-High

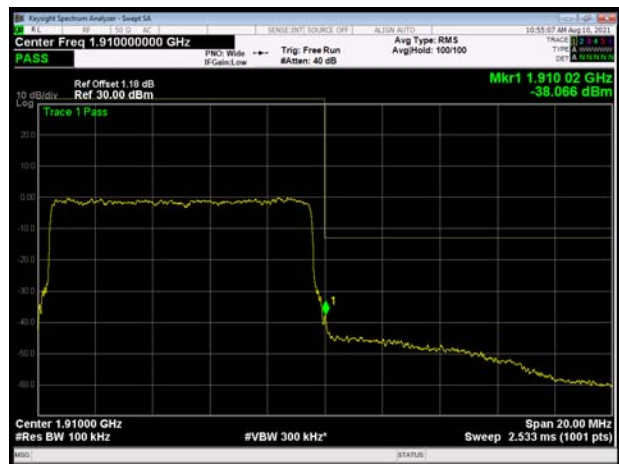



LTE Band 2 15MHz 64QAM 1RB CH-Low

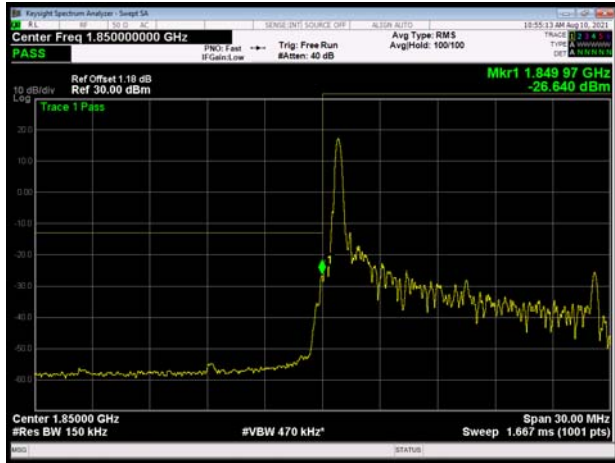

LTE Band 2 15MHz 64QAM 1RB CH-High

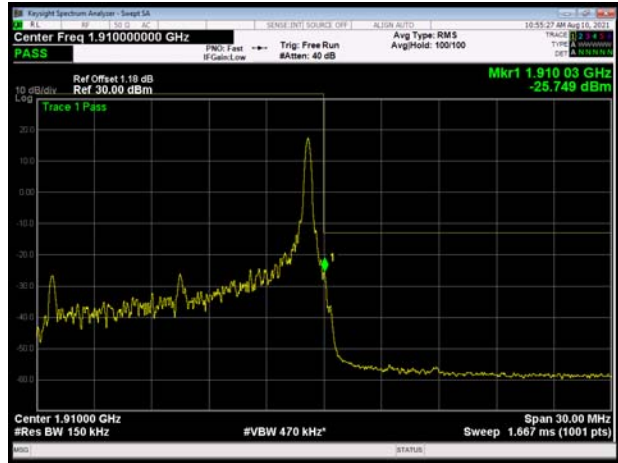

LTE Band 2 15MHz 64QAM 100%RB CH-Low

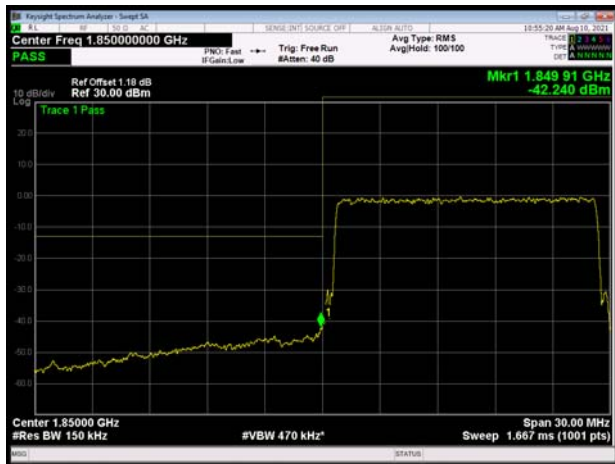

LTE Band 2 15MHz 64QAM 100%RB CH-High

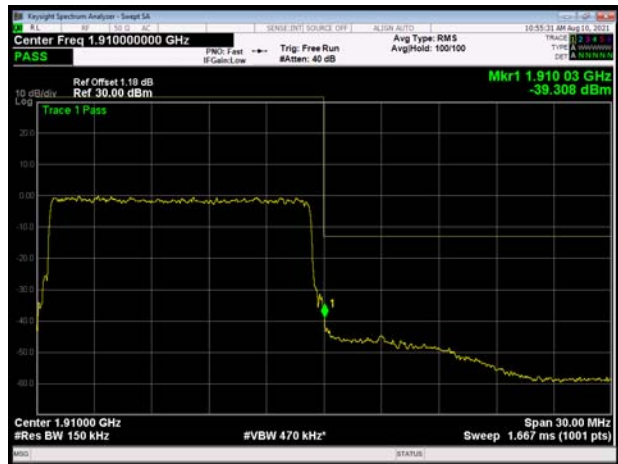

LTE Band 2 20MHz 64QAM 1RB CH-Low

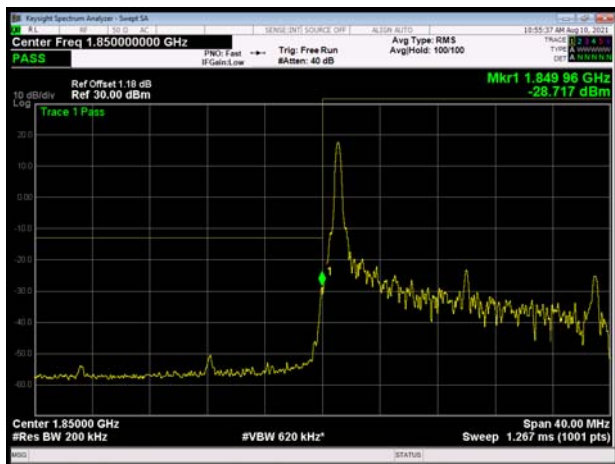

LTE Band 2 20MHz 64QAM 1RB CH-High

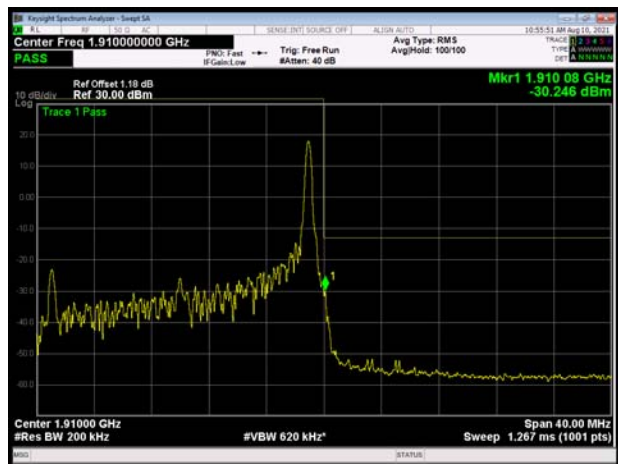



LTE Band 2 20MHz 64QAM 100%RB CH-Low

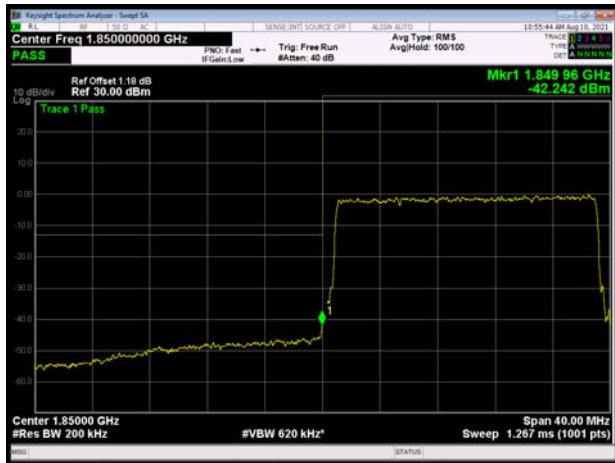

LTE Band 2 20MHz 64QAM 100%RB CH-High

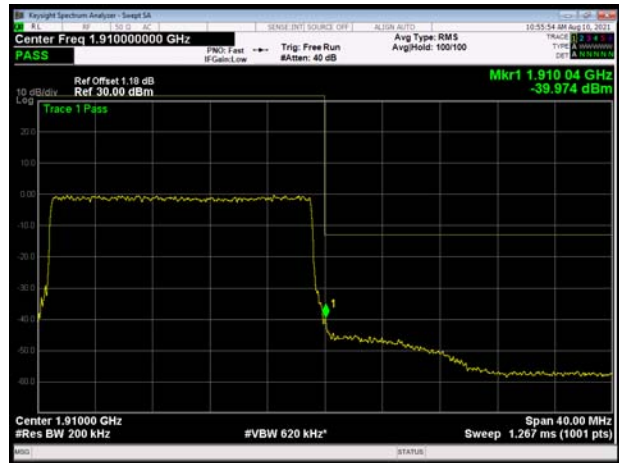

5.4. Peak-to-Average Power Ratio (PAPR)

Ambient condition

Temperature	Relative humidity	Pressure
23°C ~25°C	45%~50%	101.5kPa

Methods of Measurement

Measure the total peak power and record as PPk. And measure the total average power and record as PAvg. Both the peak and average power levels must be expressed in the same logarithmic units (e.g., dBm). Determine the PAPR from:

$$PAPR (dB) = PPk (dBm) - PAvg (dBm).$$

Test Setup

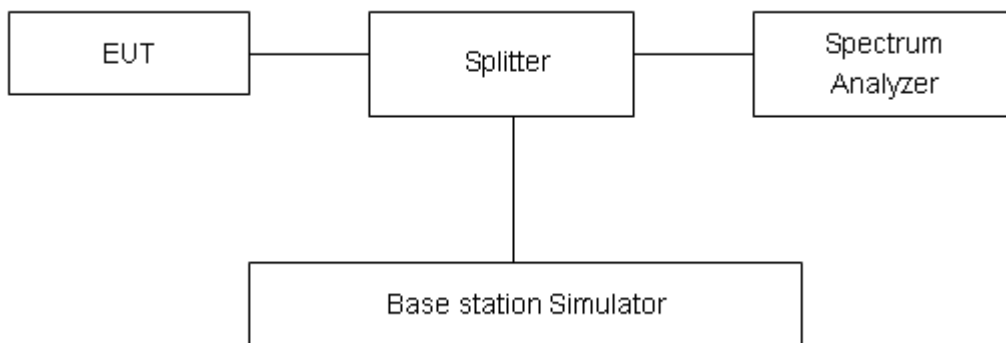

Limits

In measuring transmissions in this band using an average power technique, the peak-to-average ratio (PAR) of the transmission may not exceed 13 dB in 24.232(d).

Measurement Uncertainty

The assessed measurement uncertainty to ensure 95% confidence level for the normal distribution is with the coverage factor $k = 2$, $U = 0.4$ dB.

**Test Results**

Mode	Channel	Frequency (MHz)	Peak(dBm)	Avg(dBm)	PAPR(dB)	Limit(dB)	Conclusion
GSM 1900 (GMSK)	512	1850.2	29.60	26.91	2.69	≤13	PASS
	661	1880	29.38	26.69	2.69	≤13	PASS
	810	1909.8	29.03	26.34	2.69	≤13	PASS
GPRS 1900 (GMSK)	512	1850.2	29.65	26.96	2.69	≤13	PASS
	661	1880	29.41	26.72	2.69	≤13	PASS
	810	1909.8	29.07	26.38	2.69	≤13	PASS
EGPRS 1900 (8PSK)	512	1850.2	28.90	23.57	5.33	≤13	PASS
	661	1880	28.81	23.62	5.19	≤13	PASS
	810	1909.8	28.04	22.77	5.27	≤13	PASS
WCDMA Band II (RMC)	9262	1852.4	26.61	23.86	2.75	≤13	PASS
	9400	1880	26.30	23.55	2.75	≤13	PASS
	9538	1907.6	24.91	22.41	2.50	≤13	PASS



LTE Band 2								
Modulation	Bandwidth (MHz)	Channel	Frequency (MHz)	Peak (dBm)	Avg (dBm)	PAPR (dB)	Limit (dB)	Conclusion
QPSK	1.4	18607	1850.7	24.75	19.29	5.46	≤13	PASS
		18900	1880.0	24.96	19.53	5.43	≤13	PASS
		19193	1909.3	25.85	20.62	5.23	≤13	PASS
	3	18615	1851.5	26.11	20.65	5.46	≤13	PASS
		18900	1880	25.91	20.57	5.34	≤13	PASS
		19185	1908.5	25.89	20.60	5.29	≤13	PASS
	5	18625	1852.5	27.37	21.45	5.92	≤13	PASS
		18900	1880	27.66	22.58	5.08	≤13	PASS
		19175	1907.5	27.23	22.76	4.47	≤13	PASS
	10	18650	1855	27.70	22.68	5.02	≤13	PASS
		18900	1880	27.71	22.69	5.02	≤13	PASS
		19150	1905	26.08	20.74	5.34	≤13	PASS
	15	18675	1857.5	26.50	20.69	5.81	≤13	PASS
		18900	1880	26.51	20.69	5.82	≤13	PASS
		19125	1902.5	26.33	20.58	5.75	≤13	PASS
20	18700	1860	24.82	19.24	5.58	≤13	PASS	
	18900	1880	25.56	19.97	5.59	≤13	PASS	
	19100	1900	25.06	19.47	5.59	≤13	PASS	
16QAM	1.4	18607	1850.7	24.53	18.31	6.22	≤13	PASS
		18900	1880.0	24.85	18.59	6.26	≤13	PASS
		19193	1909.3	25.92	19.97	5.95	≤13	PASS
	3	18615	1851.5	25.90	19.70	6.20	≤13	PASS
		18900	1880	25.93	19.73	6.20	≤13	PASS
		19185	1908.5	25.66	19.67	5.99	≤13	PASS
	5	18625	1852.5	27.56	21.82	5.74	≤13	PASS
		18900	1880	27.49	21.67	5.82	≤13	PASS
		19175	1907.5	27.08	21.69	5.39	≤13	PASS
	10	18650	1855	27.58	21.83	5.75	≤13	PASS
		18900	1880	27.57	21.75	5.82	≤13	PASS
		19150	1905	25.87	19.77	6.10	≤13	PASS
	15	18675	1857.5	26.05	19.79	6.26	≤13	PASS
		18900	1880	26.01	19.75	6.26	≤13	PASS
		19125	1902.5	25.99	19.81	6.18	≤13	PASS
20	18700	1860	24.52	18.21	6.31	≤13	PASS	
	18900	1880	25.26	18.98	6.28	≤13	PASS	
	19100	1900	24.83	18.57	6.26	≤13	PASS	
64QAM	1.4	18607	1850.7	24.06	17.87	6.19	≤13	PASS
		18900	1880.0	24.32	18.09	6.23	≤13	PASS
		19193	1909.3	23.74	17.73	6.01	≤13	PASS



	3	18615	1851.5	26.99	21.25	5.74	≤13	PASS
		18900	1880	27.06	21.22	5.84	≤13	PASS
		19185	1908.5	26.52	21.32	5.20	≤13	PASS
	5	18625	1852.5	26.94	21.23	5.71	≤13	PASS
		18900	1880	25.31	19.16	6.15	≤13	PASS
		19175	1907.5	25.26	19.31	5.95	≤13	PASS
	10	18650	1855	25.44	19.25	6.19	≤13	PASS
		18900	1880	25.50	19.29	6.21	≤13	PASS
		19150	1905	25.38	19.24	6.14	≤13	PASS
	15	18675	1857.5	27.31	21.42	5.89	≤13	PASS
		18900	1880	27.34	21.30	6.04	≤13	PASS
		19125	1902.5	27.11	21.37	5.74	≤13	PASS
	20	18700	1860	27.25	21.25	6.00	≤13	PASS
		18900	1880	27.29	21.21	6.08	≤13	PASS
		19100	1900	27.31	21.37	5.94	≤13	PASS

5.5. Frequency Stability

Ambient condition

Temperature	Relative humidity	Pressure
23°C ~25°C	45%~50%	101.5kPa

Method of Measurement

Frequency Stability (Temperature Variation)

The temperature inside the climate chamber is varied from -30°C to +50°C in 10°C step size,

(1) With all power removed, the temperature was decreased to 0°C and permitted to stabilize for three hours.

(2) Measure the carrier frequency with the test equipment in a “call mode”. These measurements should be made within 1 minute of powering up the mobile station, to prevent significant self warming.

(3) Repeat the above measurements at 10°C increments from -30°C to +50°C. Allow at least 1.5 hours at each temperature, un-powered, before making measurements.

Frequency Stability (Voltage Variation)

The frequency stability shall be measured with variation of primary supply voltage as follows:

Primary Supply Voltage: The primary supply voltage is varied from 85% to 115% of the nominal value for non hand-carried battery and AC powered equipment. For hand-carried, battery-powered equipment, primary supply voltage is reduced to the battery operating end point which shall be specified by the manufacturer.

This transceiver is specified to operate with an input voltage of between 3.4 V and 4.35 V, with a nominal voltage of 3.8V.

Test setup

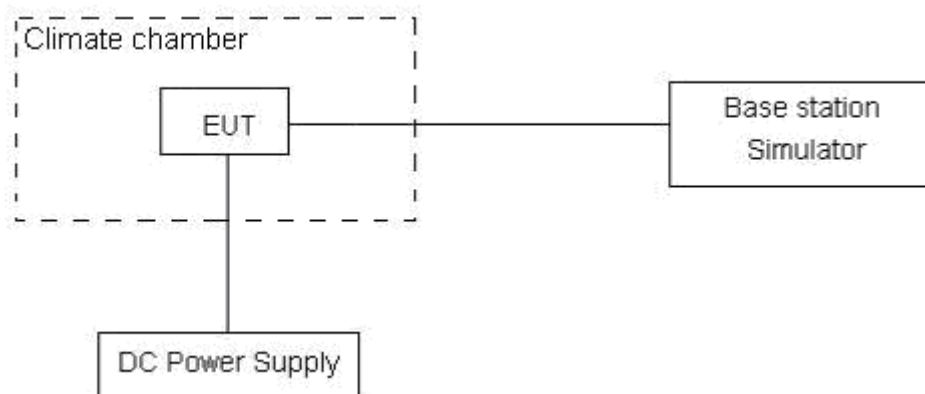

**Limits**

The frequency stability shall be sufficient to ensure that the fundamental emission stays within the authorized frequency block

Measurement Uncertainty

The assessed measurement uncertainty to ensure 99.75% confidence level for the normal distribution is with the coverage factor $k = 3$, $U = 0.01\text{ppm}$.



Test Result

GSM1900						
Condition		Freq.Error (Hz)	Freq.Error (Hz)	Frequency Stability (ppm)	Frequency Stability (ppm)	Verdict
Temperature	Voltage	GMSK	8PSK	GMSK	8PSK	
Normal (25°C)	Normal	17.27	7.15	0.00919	0.00380	PASS
Extreme (50°C)		11.95	12.73	0.00636	0.00677	PASS
Extreme (40°C)		11.21	4.39	0.00596	0.00234	PASS
Extreme (30°C)		9.84	6.56	0.00524	0.00349	PASS
Extreme (20°C)		14.90	11.43	0.00792	0.00608	PASS
Extreme (10°C)		14.00	6.33	0.00745	0.00337	PASS
Extreme (0°C)		13.92	11.60	0.00741	0.00617	PASS
Extreme (-10°C)		12.52	15.61	0.00666	0.00830	PASS
Extreme (-20°C)		6.34	11.64	0.00337	0.00619	PASS
Extreme (-30°C)		8.62	3.77	0.00459	0.00200	PASS
25°C	LV	16.02	16.59	0.00852	0.00882	PASS
	HV	2.72	14.41	0.00145	0.00767	PASS

WCDMA Band II						
Condition		Freq.Error (Hz)	Freq.Error (Hz)	Frequency Stability (ppm)	Frequency Stability (ppm)	Verdict
Temperature	Voltage	BPSK	QPSK	BPSK	QPSK	
Normal (25°C)	Normal	17.92	8.47	0.00953	0.00451	PASS
Extreme (50°C)		1.81	17.37	0.00096	0.00924	PASS
Extreme (40°C)		14.58	4.33	0.00775	0.00230	PASS
Extreme (30°C)		4.01	10.44	0.00213	0.00555	PASS
Extreme (20°C)		2.62	5.05	0.00140	0.00269	PASS
Extreme (10°C)		5.25	3.84	0.00279	0.00204	PASS
Extreme (0°C)		5.25	7.32	0.00279	0.00389	PASS
Extreme (-10°C)		9.62	1.58	0.00511	0.00084	PASS
Extreme (-20°C)		7.21	15.38	0.00383	0.00818	PASS
Extreme (-30°C)		2.45	5.36	0.00130	0.00285	PASS
25°C	LV	5.13	10.49	0.00273	0.00558	PASS
	HV	6.93	17.37	0.00369	0.00924	PASS



LTE Band 2								
Condition		Freq.Error (Hz)	Freq.Error (Hz)	Freq.Error (Hz)	Frequency Stability (ppm)	Frequency Stability (ppm)	Frequency Stability (ppm)	Verdict
BANDWIDTH	1.4MHz							
Temperature	Voltage	64QAM	16QAM	QPSK	64QAM	16QAM	QPSK	
Normal (25°C)	Normal	3.45	13.44	5.91	0.00183	0.00715	0.00314	PASS
Extreme (50°C)		6.48	1.25	4.65	0.00345	0.00066	0.00247	PASS
Extreme (40°C)		14.36	7.34	2.88	0.00764	0.00390	0.00153	PASS
Extreme (30°C)		6.32	12.87	10.94	0.00336	0.00685	0.00582	PASS
Extreme (20°C)		12.85	4.70	7.89	0.00683	0.00250	0.00420	PASS
Extreme (10°C)		13.14	16.62	1.56	0.00699	0.00884	0.00083	PASS
Extreme (0°C)		15.43	17.65	8.52	0.00821	0.00939	0.00453	PASS
Extreme (-10°C)		16.05	14.85	16.81	0.00854	0.00790	0.00894	PASS
Extreme (-20°C)		14.02	8.12	8.93	0.00746	0.00432	0.00475	PASS
Extreme (-30°C)		11.81	12.77	6.80	0.00628	0.00679	0.00362	PASS
25°C	LV	15.27	7.01	6.74	0.00812	0.00373	0.00358	PASS
	HV	17.56	9.37	5.21	0.00934	0.00498	0.00277	PASS
Condition		Freq.Error (Hz)	Freq.Error (Hz)	Freq.Error (Hz)	Frequency Stability (ppm)	Frequency Stability (ppm)	Frequency Stability (ppm)	Verdict
BANDWIDTH	3MHz							
Temperature	Voltage	64QAM	16QAM	QPSK	64QAM	16QAM	QPSK	
Normal (25°C)	Normal	12.99	10.12	10.31	0.00691	0.00538	0.00548	PASS
Extreme (50°C)		11.64	12.12	11.56	0.00619	0.00645	0.00615	PASS
Extreme (40°C)		5.12	11.77	10.82	0.00272	0.00626	0.00576	PASS
Extreme (30°C)		10.34	6.01	7.48	0.00550	0.00320	0.00398	PASS
Extreme (20°C)		9.51	12.90	8.73	0.00506	0.00686	0.00464	PASS
Extreme (10°C)		10.41	13.13	5.59	0.00554	0.00698	0.00297	PASS
Extreme (0°C)		16.27	3.07	6.14	0.00865	0.00163	0.00326	PASS
Extreme (-10°C)		3.87	1.77	3.52	0.00206	0.00094	0.00187	PASS
Extreme (-20°C)		12.64	16.69	16.20	0.00672	0.00888	0.00862	PASS
Extreme (-30°C)		11.57	3.52	10.75	0.00615	0.00187	0.00572	PASS
25°C	LV	14.22	4.45	17.12	0.00757	0.00236	0.00910	PASS
	HV	12.51	10.86	3.04	0.00665	0.00577	0.00162	PASS
Condition		Freq.Error (Hz)	Freq.Error (Hz)	Freq.Error (Hz)	Frequency Stability (ppm)	Frequency Stability (ppm)	Frequency Stability (ppm)	Verdict
BANDWIDTH	5MHz							
Temperature	Voltage	64QAM	16QAM	QPSK	64QAM	16QAM	QPSK	
Normal (25°C)	Normal	12.97	8.99	8.21	0.00690	0.00478	0.00437	PASS
Extreme (50°C)		1.29	5.64	3.76	0.00069	0.00300	0.00200	PASS



Extreme (40°C)		7.10	7.48	4.77	0.00378	0.00398	0.00254	PASS
Extreme (30°C)		14.33	3.30	14.52	0.00762	0.00175	0.00772	PASS
Extreme (20°C)		8.92	10.66	5.44	0.00475	0.00567	0.00289	PASS
Extreme (10°C)		17.30	17.20	13.37	0.00920	0.00915	0.00711	PASS
Extreme (0°C)		11.46	3.19	13.16	0.00609	0.00170	0.00700	PASS
Extreme (-10°C)		10.36	16.20	16.44	0.00551	0.00862	0.00874	PASS
Extreme (-20°C)		8.44	17.42	8.75	0.00449	0.00927	0.00466	PASS
Extreme (-30°C)		3.55	9.71	2.91	0.00189	0.00516	0.00155	PASS
25°C	LV	3.34	3.47	10.48	0.00178	0.00185	0.00557	PASS
	HV	12.17	3.03	15.26	0.00647	0.00161	0.00812	PASS
Condition		Freq.Error (Hz)	Freq.Error (Hz)	Freq.Error (Hz)	Frequency Stability (ppm)	Frequency Stability (ppm)	Frequency Stability (ppm)	Verdict
BANDWIDTH	10MHz							
Temperature	Voltage	64QAM	16QAM	QPSK	64QAM	16QAM	QPSK	
Normal (25°C)	Normal	10.68	9.29	15.27	0.00568	0.00494	0.00812	PASS
Extreme (50°C)		15.35	14.29	14.16	0.00816	0.00760	0.00753	PASS
Extreme (40°C)		5.58	14.18	6.60	0.00297	0.00754	0.00351	PASS
Extreme (30°C)		10.45	9.25	5.55	0.00556	0.00492	0.00295	PASS
Extreme (20°C)		13.91	2.40	14.61	0.00740	0.00128	0.00777	PASS
Extreme (10°C)		3.07	9.40	13.93	0.00163	0.00500	0.00741	PASS
Extreme (0°C)		13.40	16.06	12.67	0.00713	0.00854	0.00674	PASS
Extreme (-10°C)		1.25	3.38	12.59	0.00066	0.00180	0.00670	PASS
Extreme (-20°C)		2.45	9.52	1.72	0.00130	0.00506	0.00091	PASS
Extreme (-30°C)		3.62	2.82	14.49	0.00193	0.00150	0.00771	PASS
25°C	LV	13.55	8.50	8.86	0.00721	0.00452	0.00471	PASS
	HV	1.69	10.81	16.46	0.00090	0.00575	0.00875	PASS
Condition		Freq.Error (Hz)	Freq.Error (Hz)	Freq.Error (Hz)	Frequency Stability (ppm)	Frequency Stability (ppm)	Frequency Stability (ppm)	Verdict
BANDWIDTH	15MHz							
Temperature	Voltage	64QAM	16QAM	QPSK	64QAM	16QAM	QPSK	
Normal (25°C)	Normal	6.92	6.42	11.84	0.00368	0.00341	0.00630	PASS
Extreme (50°C)		5.51	14.52	13.73	0.00293	0.00772	0.00730	PASS
Extreme (40°C)		4.80	8.05	5.11	0.00255	0.00428	0.00272	PASS
Extreme (30°C)		8.70	5.36	3.66	0.00463	0.00285	0.00195	PASS
Extreme (20°C)		2.93	11.18	11.56	0.00156	0.00594	0.00615	PASS
Extreme (10°C)		13.27	17.12	8.20	0.00706	0.00911	0.00436	PASS
Extreme (0°C)		6.62	3.44	1.27	0.00352	0.00183	0.00068	PASS
Extreme (-10°C)		12.09	9.16	14.03	0.00643	0.00487	0.00746	PASS
Extreme (-20°C)		8.87	16.07	13.14	0.00472	0.00855	0.00699	PASS
Extreme (-30°C)		6.31	6.33	9.16	0.00336	0.00337	0.00487	PASS
25°C	LV	2.08	7.58	10.61	0.00111	0.00403	0.00564	PASS



	HV	2.43	13.90	9.74	0.00129	0.00739	0.00518	PASS
Condition		Freq.Error (Hz)	Freq.Error (Hz)	Freq.Error (Hz)	Frequency Stability (ppm)	Frequency Stability (ppm)	Frequency Stability (ppm)	Verdict
BANDWIDTH	20MHz							
Temperature	Voltage	64QAM	16QAM	QPSK	64QAM	16QAM	QPSK	
Normal (25°C)	Normal	16.72	9.82	16.04	0.00889	0.00523	0.00853	PASS
Extreme (50°C)		3.50	3.73	12.04	0.00186	0.00198	0.00641	PASS
Extreme (40°C)		14.50	16.28	6.33	0.00771	0.00866	0.00336	PASS
Extreme (30°C)		10.21	15.82	2.51	0.00543	0.00841	0.00133	PASS
Extreme (20°C)		1.16	3.13	12.45	0.00062	0.00166	0.00662	PASS
Extreme (10°C)		1.42	2.30	14.93	0.00075	0.00122	0.00794	PASS
Extreme (0°C)		12.69	7.85	11.21	0.00675	0.00417	0.00596	PASS
Extreme (-10°C)		4.82	6.35	9.12	0.00256	0.00338	0.00485	PASS
Extreme (-20°C)		1.16	13.64	16.77	0.00062	0.00725	0.00892	PASS
Extreme (-30°C)		8.48	17.97	2.83	0.00451	0.00956	0.00151	PASS
25°C	LV	14.38	2.68	4.36	0.00765	0.00142	0.00232	PASS
	HV	8.59	12.32	9.26	0.00457	0.00655	0.00493	PASS

5.6. Spurious Emissions at Antenna Terminals

Ambient condition

Temperature	Relative humidity	Pressure
23°C ~25°C	45%~50%	101.5kPa

Method of Measurement

The EUT was connected to Spectrum Analyzer and Base Station Simulator via power Splitter. The measurement is carried out using a spectrum analyzer. The spectrum analyzer scans from 9kHz to the 10th harmonic of the carrier. The peak detector is used.

RBW is set to 100kHz, VBW is set to 300kHz for 30MHz~1GHz

RBW is set to 1MHz, VBW is set to 3MHz for above 1GHz, Sweep is set to ATUO.

RBW is set to 1 kHz (0.009MHz~ 0.15 MHz),

RBW is set to 10 kHz (0.15 MHz~ 30 MHz)

RBW is set to 100 kHz (30MHz~1000 MHz)

RBW is set to 1000 kHz (above 1000MHz)

The modulation mode and RB allocation refer to section 5.1, using the maximum output power configuration.

Test setup

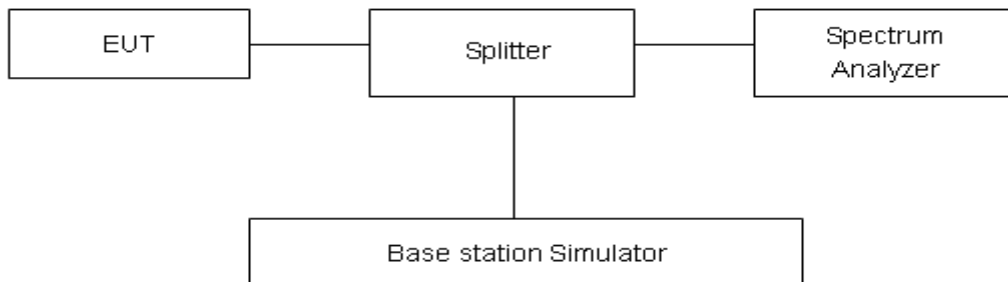

Limits

Rule Part 24.238(a) specifies that “on any frequency outside a licensee’s frequency block, the power of any emission shall be attenuated below the transmitter power (P) by at least 43 + 10 log₁₀ (P) dB.”

Limit	-13 dBm
-------	---------

Measurement Uncertainty

The assessed measurement uncertainty to ensure 99.75% confidence level for the normal distribution is with the coverage factor $k = 1.96$.

Frequency	Uncertainty
9kHz-1GHz	0.684 dB
1GHz-20GHz	1.407 dB



Test Result

Sweep the whole frequency band through the range from 9kHz to the 10th harmonic of the carrier, the emissions more than 20 dB below the limit are not reported. The signal beyond the limit is carrier.

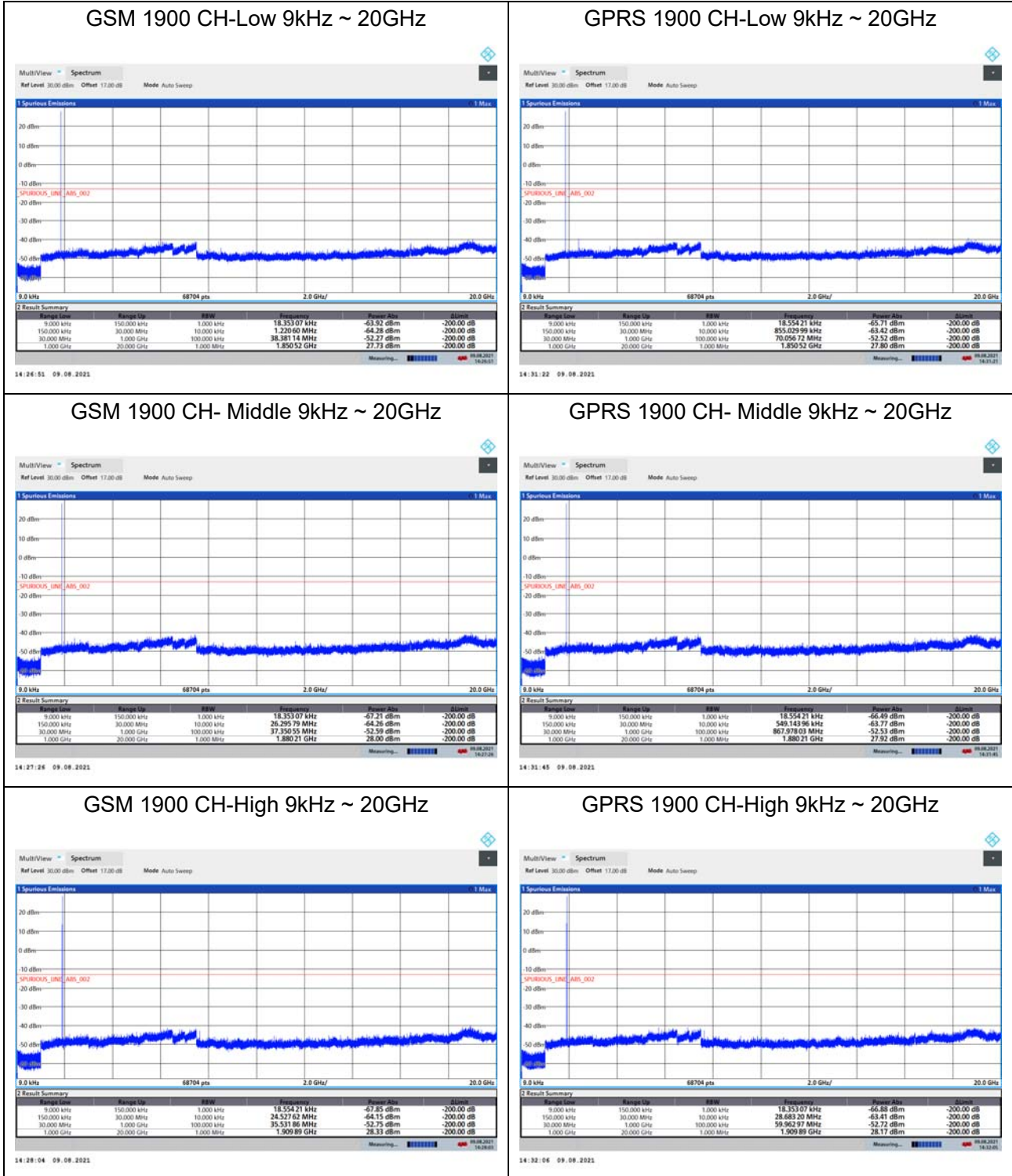



EGPRS 1900 CH-Low 9kHz ~ 20GHz

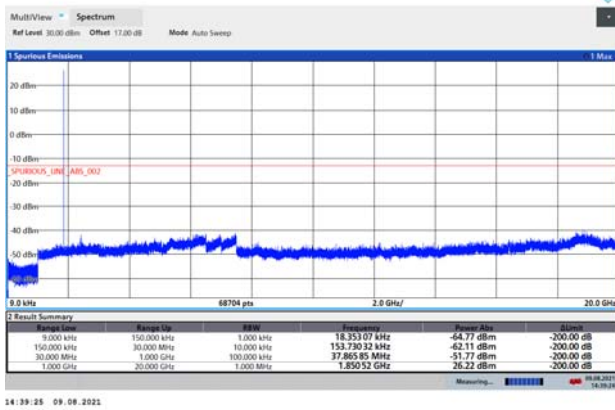

14:39:28 09.08.2021

WCDMA BAND II CH-Low 9kHz ~ 20GHz

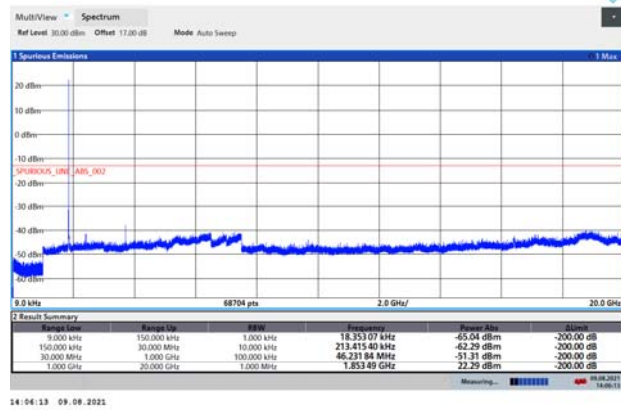

14:06:13 09.08.2021

EGPRS 1900 CH- Middle 9kHz ~ 20GHz

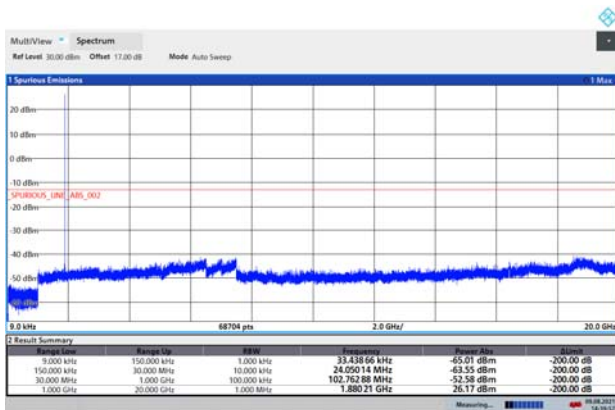

14:39:58 09.08.2021

WCDMA BAND II CH- Middle 9kHz ~ 20GHz

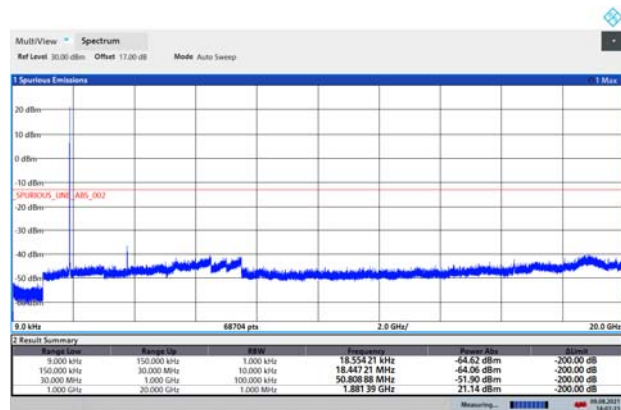

14:07:23 09.08.2021

EGPRS 1900 CH-High 9kHz ~ 20GHz

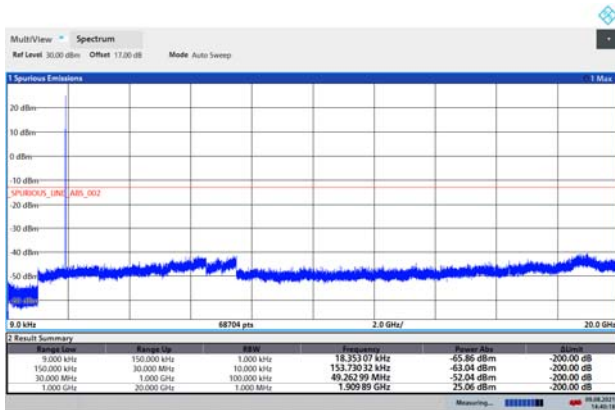

14:40:19 09.08.2021

WCDMA BAND II CH-High 9kHz ~ 20GHz

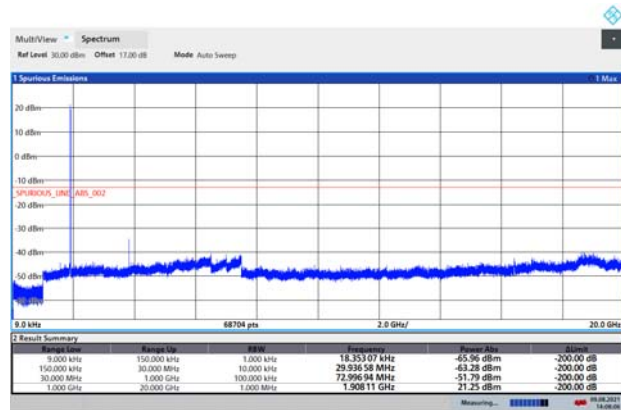

14:08:06 09.08.2021

LTE Band 2 1.4MHz CH-Low 9kHz~20GHz

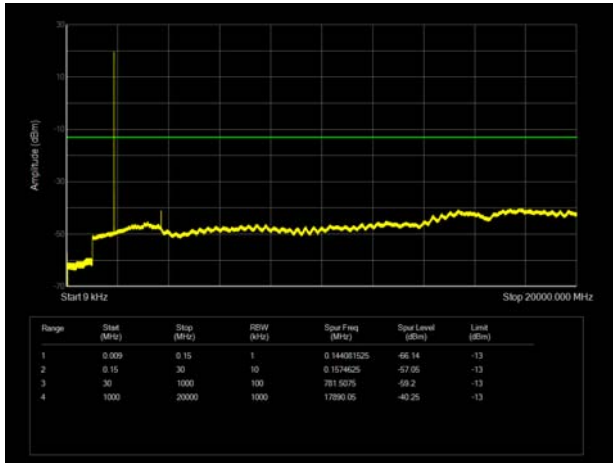

LTE Band 2 3MHz CH-Low 9kHz~20GHz

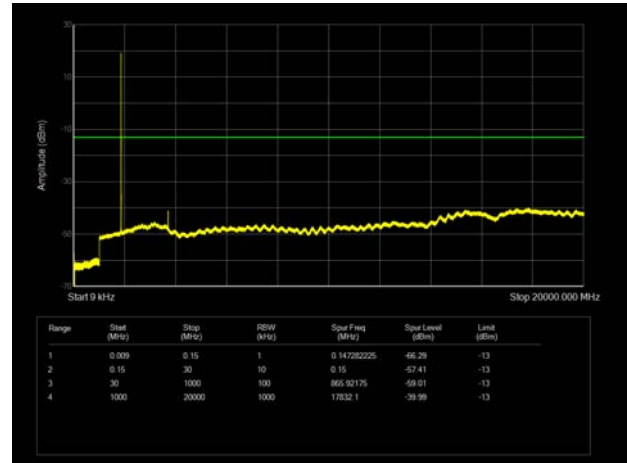

LTE Band 2 1.4MHz CH-Middle 9kHz~20GHz

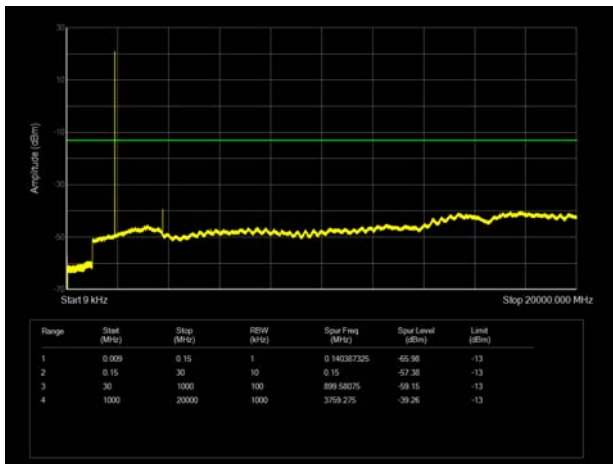

LTE Band 2 3MHz CH-Middle 9kHz~20GHz

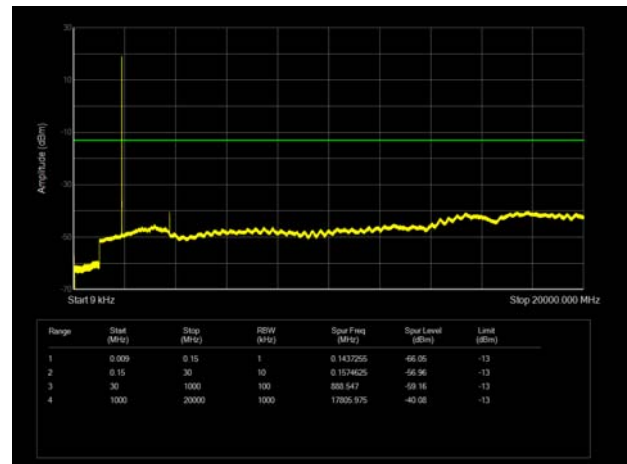

LTE Band 2 1.4MHz CH-High 9kHz~20GHz

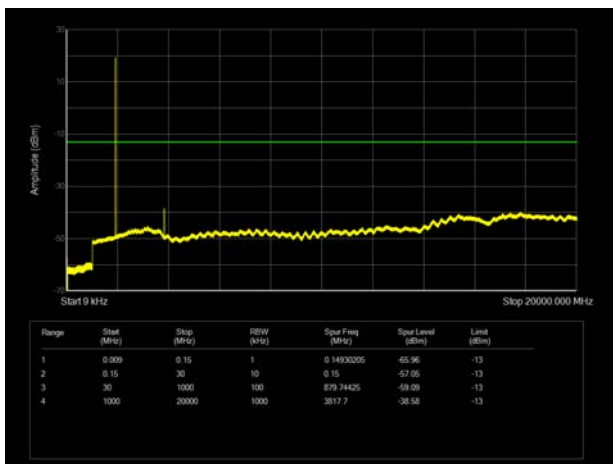

LTE Band 2 3MHz CH-High 9kHz~20GHz

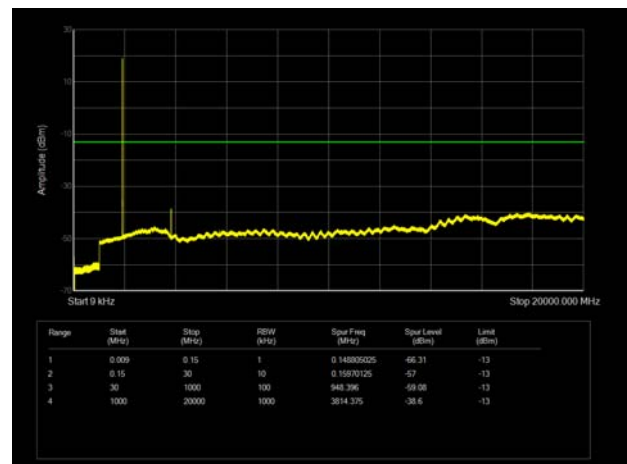

LTE Band 2 5MHz CH-Low 9kHz~20GHz

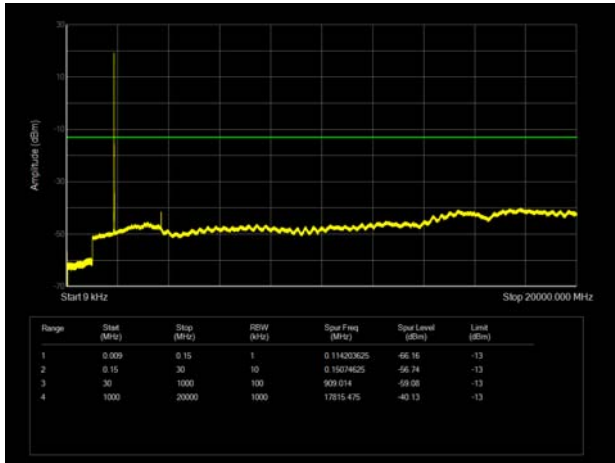

LTE Band 2 10MHz CH-Low 9kHz~20GHz

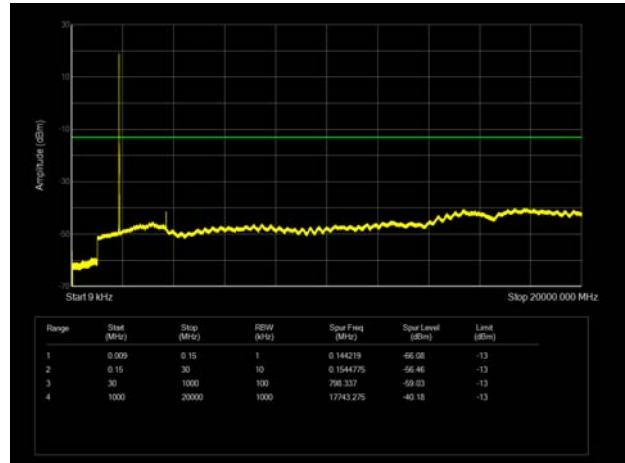

LTE Band 2 5MHz CH-Middle 9kHz~20GHz

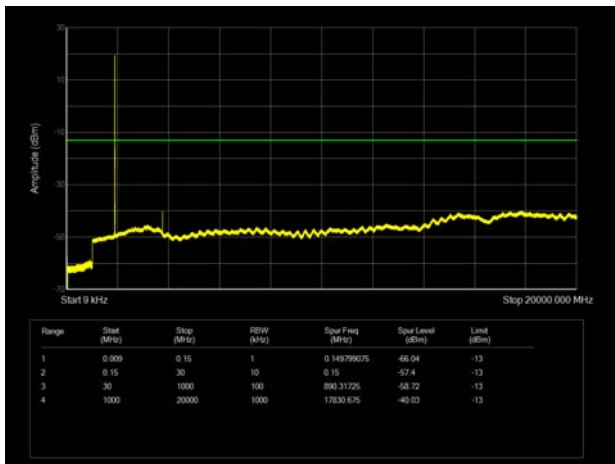

LTE Band 2 10MHz CH-Middle 9kHz~20GHz

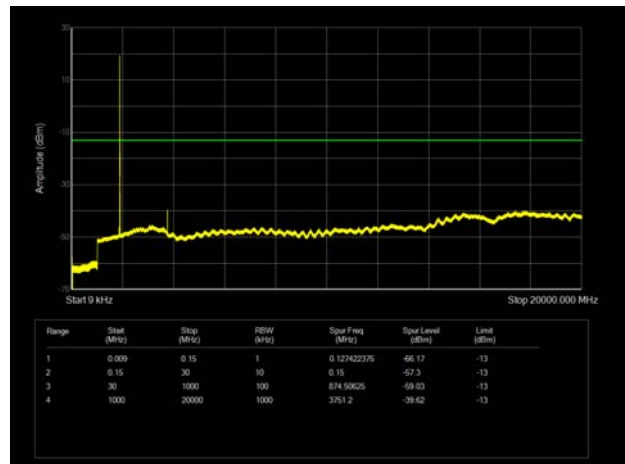

LTE Band 2 5MHz CH-High 9kHz~20GHz

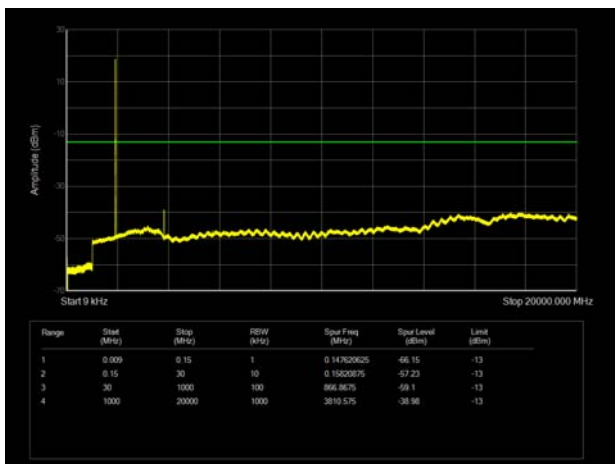

LTE Band 2 10MHz CH-High 9kHz~20GHz

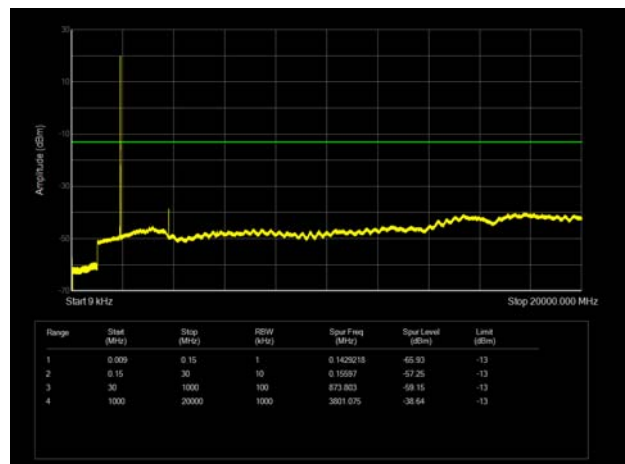

LTE Band 2 15MHz CH-Low 9kHz~20GHz

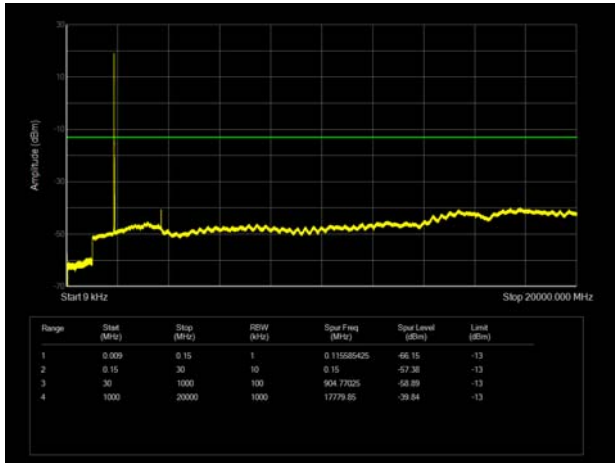

LTE Band 2 20MHz CH-Low 9kHz~20GHz

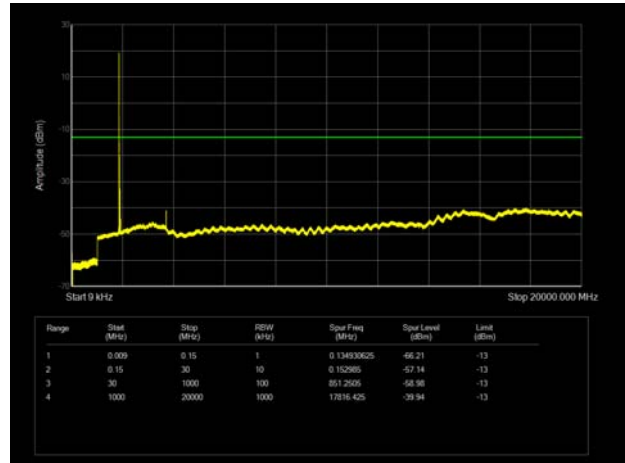

LTE Band 2 15MHz CH-Middle 9kHz~20GHz

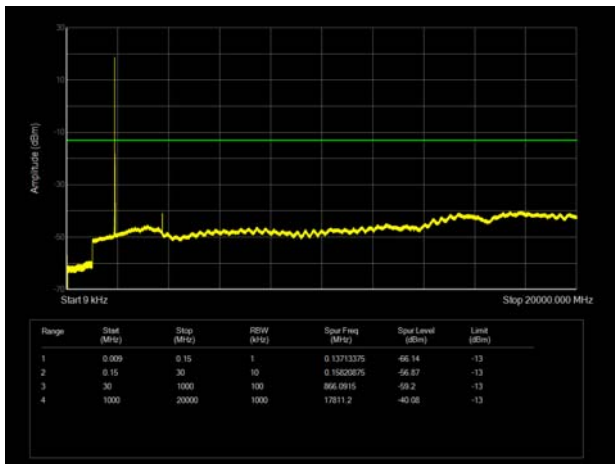

LTE Band 2 20MHz CH-Middle 9kHz~20GHz

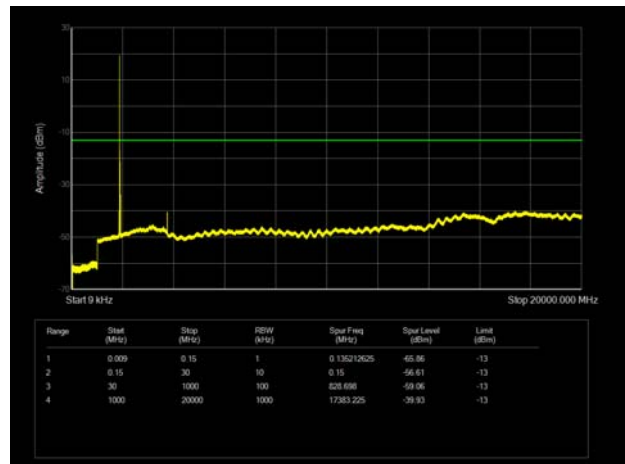

LTE Band 2 15MHz CH-High 9kHz~20GHz

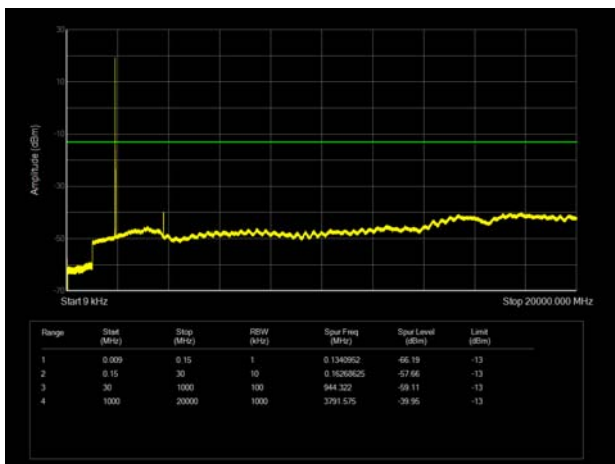

LTE Band 2 20MHz CH-High 9kHz~20GHz

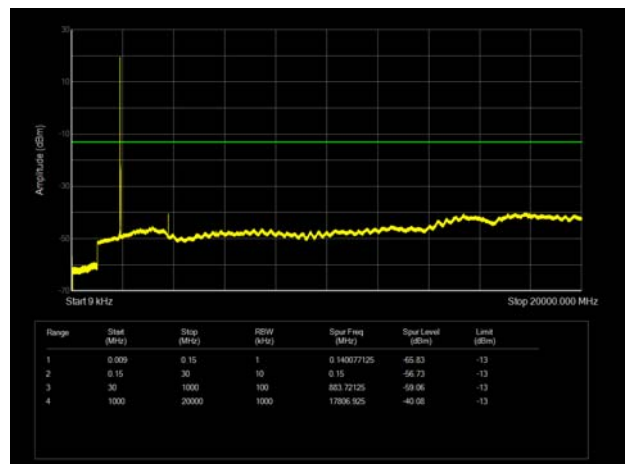

5.7. Radiates Spurious Emission

Ambient condition

Temperature	Relative humidity	Pressure
23°C ~25°C	45%~50%	101.5kPa

Method of Measurement

- The testing follows FCC KDB 971168 v03r01 Section 5.8 and ANSI C63.26 (2015).
- Below 1GHz: The EUT is placed on a turntable 0.8 meters above the ground in the chamber, 3 meter away from the antenna. The maximal emission value is acquired by adjusting the antenna height, polarisation and turntable azimuth. Normally, the height range of antenna is 1 m to 4 m, the azimuth range of turntable is 0° to 360°, and the receive antenna has two polarizations Vertical (V) and Horizontal (H). Above 1GHz: (Note: the FCC's permission to use 1.5m as an alternative per TCBC Conf call of Dec. 2, 2014.) The EUT is placed on a turntable 1.5 meters above the ground in the chamber, 3 meter away from the antenna. The maximal emission value is acquired by adjusting the antenna height, polarisation and turntable azimuth. Normally, the height range of antenna is 1 m to 4 m, the azimuth range of turntable is 0° to 360°, and the receive antenna has two polarizations Vertical (V) and Horizontal (H).
- A loop antenna, A log-periodic antenna or horn antenna shall be substituted in place of the EUT. The log-periodic antenna will be driven by a signal generator and the level will be adjusted till the same power value on the spectrum analyzer or receiver. The level of the spurious emissions can be calculated through the level of the signal generator, cable loss, the gain of the substitution antenna and the reading of the spectrum analyzer or receiver.
- The EUT is then put into continuously transmitting mode at its maximum power level during the test. Set Test Receiver or Spectrum RBW=1MHz, VBW=3MHz, and the maximum value of the receiver should be recorded as (Pr).
- The EUT shall be replaced by a substitution antenna. In the chamber, an substitution antenna for the frequency band of interest is placed at the reference point of the chamber. An RF Signal source for the frequency band of interest is connected to the substitution antenna with a cable that has been constructed to not interfere with the radiation pattern of the antenna. A power (PMea) is applied to the input of the substitution antenna, and adjust the level of the signal generator output until the value of the receiver reach the previously recorded (Pr). The power of signal source (PMea) is recorded. The test should be performed by rotating the test item and adjusting the receiving antenna polarization.
- A amplifier should be connected to the Signal Source output port. And the cable should be connect between the Amplifier and the Substitution Antenna. The cable loss (Pcl) ,the Substitution Antenna Gain (Ga) and the Amplifier Gain (PAG) should be recorded after test.
- The measurement results are obtained as described below:
 $Power(EIRP)=PMea- PAg - Pcl + Ga$
 The measurement results are amend as described below:
 $Power(EIRP)=PMea- Pcl + Ga$
- This value is EIRP since the measurement is calibrated using an antenna of known gain (2.15 dBi) and known input power. ERP can be calculated from EIRP by subtracting the gain of the dipole, ERP

= EIRP-2.15dBi.

The modulation mode and RB allocation refer to section 5.1, using the maximum output power configuration.

Test setup

9KHz ~ 30MHz

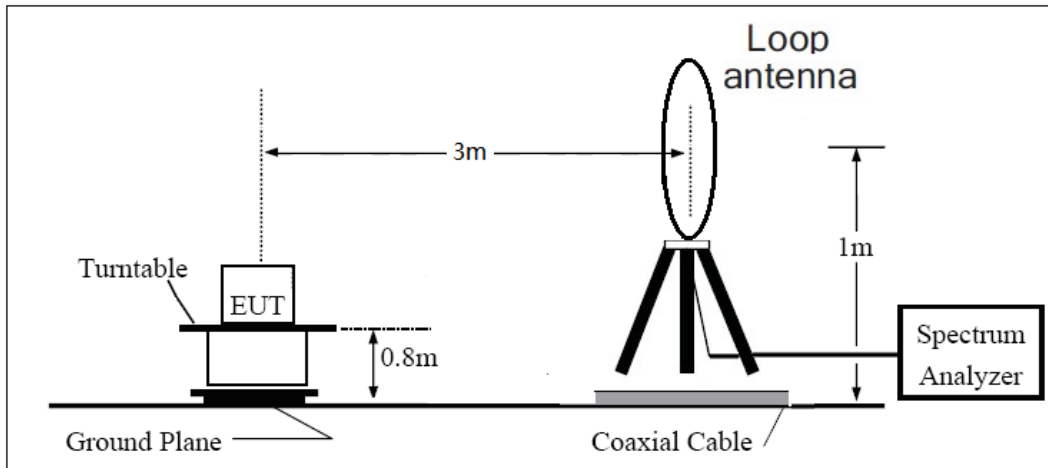

30MHz ~ 1GHz

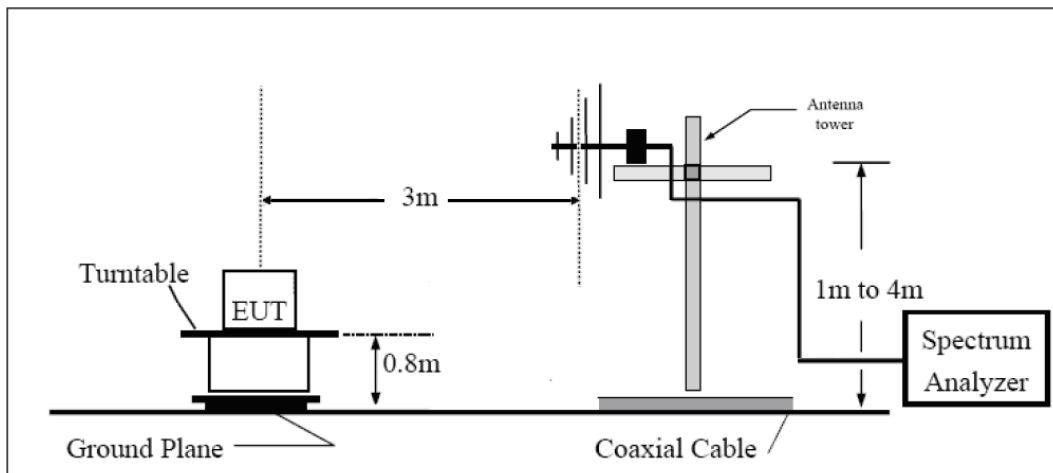

Above 1GHz

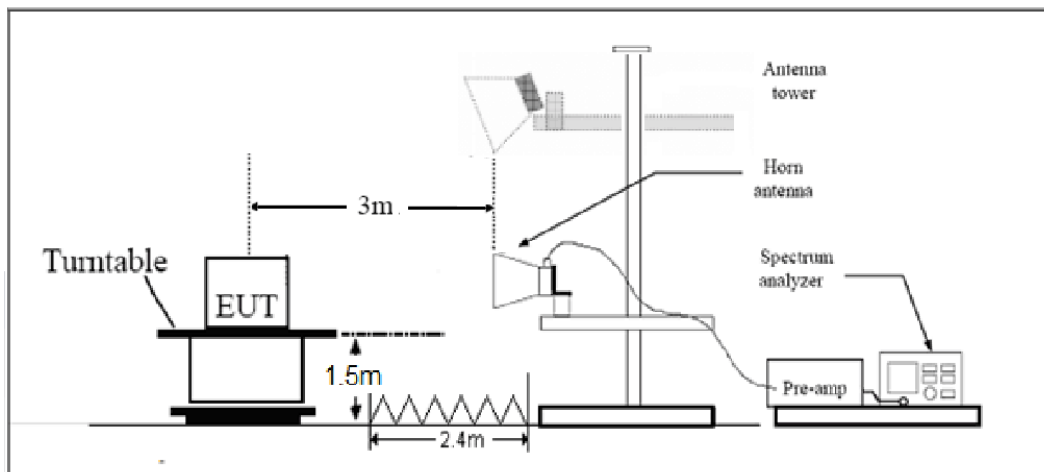

Note: Area side: 2.4mX3.6m

Limits

Rule Part 24.238(a) specifies that “on any frequency outside a licensee's frequency block, the power of any emission shall be attenuated below the transmitter power (P) by at least $43 + 10 \log_{10} (P)$ dB.”

Limit	-13 dBm
-------	---------

Measurement Uncertainty

The assessed measurement uncertainty to ensure 95% confidence level for the normal distribution is with the coverage factor $k = 1.96$, $U = 3.55$ dB.

**Test Result**

Sweep the whole frequency band through the range from 9kHz to the 10th harmonic of the carrier, the emissions below the noise floor will not be recorded in the report.

GSM 1900 CH-Middle

Harmonic	Frequency (MHz)	SG (dBm)	Cable Loss (dB)	Gain (dBi)	Antenna Polarization	EIRP Level (dBm)	Limit (dBm)	Margin (dB)	Azimuth (deg)
2	3760.00	-39.06	2.60	12.50	Horizontal	-29.16	-13.00	16.16	270
3	5640.00	-54.68	3.30	12.50	Horizontal	-45.48	-13.00	32.48	90
4	7520.00	-53.02	4.20	12.20	Horizontal	-45.02	-13.00	32.02	45
5	9400.00	-48.92	4.30	11.10	Horizontal	-42.12	-13.00	29.12	225
6	11280.00	-37.74	5.90	11.90	Horizontal	-31.74	-13.00	18.74	90
7	13160.00	-54.04	5.70	14.00	Horizontal	-45.74	-13.00	32.74	45
8	15040.00	-52.36	5.80	13.10	Horizontal	-45.06	-13.00	32.06	315
9	16920.00	-49.94	6.10	14.60	Horizontal	-41.44	-13.00	28.44	90
10	18800.00	-	-	-	-	-	-	-	-

Note: 1.The other Spurious RF Radiated emissions level is no more than noise floor.

2. The worst emission was found in the antenna is Horizontal position.

WCDMA Band II CH-Middle

Harmonic	Frequency (MHz)	SG (dBm)	Cable Loss (dB)	Gain (dBi)	Antenna Polarization	EIRP Level (dBm)	Limit (dBm)	Margin (dB)	Azimuth (deg)
2	3760.00	-65.45	2.60	12.50	Horizontal	-55.55	-13.00	42.55	90
3	5640.00	-64.33	3.30	12.50	Horizontal	-55.13	-13.00	42.13	45
4	7520.00	-56.72	4.20	12.20	Horizontal	-48.72	-13.00	35.72	135
5	9400.00	-55.08	4.30	11.10	Horizontal	-48.28	-13.00	35.28	315
6	11280.00	-49.69	5.90	11.90	Horizontal	-43.69	-13.00	30.69	90
7	13160.00	-52.18	5.70	14.00	Horizontal	-43.88	-13.00	30.88	45
8	15040.00	-51.90	5.80	13.10	Horizontal	-44.60	-13.00	31.60	315
9	16920.00	-48.72	6.10	14.60	Horizontal	-40.22	-13.00	27.22	90
10	18800.00	-	-	-	-	-	-	-	-

Note: 1.The other Spurious RF Radiated emissions level is no more than noise floor.

2. The worst emission was found in the antenna is Horizontal position.



LTE Band 2 1.4MHz CH-Middle

Harmonic	Frequency (MHz)	SG (dBm)	Cable Loss (dB)	Gain (dBi)	Antenna Polarization	EIRP Level (dBm)	Limit (dBm)	Margin (dB)	Azimuth (deg)
2	3760.00	-39.04	2.60	12.50	Horizontal	-29.14	-13.00	16.14	45
3	5640.00	-55.83	3.30	12.50	Horizontal	-46.63	-13.00	32.38	0
4	7520.00	-53.38	4.20	12.20	Horizontal	-45.38	-13.00	34.26	90
5	9400.00	-54.06	4.30	11.10	Horizontal	-47.26	-13.00	34.26	45
6	11280.00	-49.23	5.90	11.90	Horizontal	-43.23	-13.00	30.23	135
7	13160.00	-50.54	5.70	14.00	Horizontal	-42.24	-13.00	29.24	45
8	15040.00	-46.04	5.80	13.10	Horizontal	-38.74	-13.00	25.74	0
9	16920.00	-48.77	6.10	14.60	Horizontal	-40.27	-13.00	27.27	225
10	18800.00	-	-	-	-	-	-	-	-

Note: 1.The other Spurious RF Radiated emissions level is no more than noise floor.
2. The worst emission was found in the antenna is Horizontal position.

LTE Band 2 5MHz CH-Middle

Harmonic	Frequency (MHz)	SG (dBm)	Cable Loss (dB)	Gain (dBi)	Antenna Polarization	EIRP Level (dBm)	Limit (dBm)	Margin (dB)	Azimuth (deg)
2	3755.63	-37.77	2.60	12.50	Horizontal	-27.87	-13.00	14.87	45
3	5633.63	-56.55	3.30	12.50	Horizontal	-47.35	-13.00	34.35	0
4	7520.00	-53.28	4.20	12.20	Horizontal	-45.28	-13.00	32.28	0
5	9400.00	-51.83	4.30	11.10	Horizontal	-45.03	-13.00	32.03	225
6	11280.00	-52.61	5.90	11.90	Horizontal	-46.61	-13.00	33.61	225
7	13160.00	-51.51	5.70	14.00	Horizontal	-43.21	-13.00	30.21	45
8	15040.00	-47.52	5.80	13.10	Horizontal	-40.22	-13.00	27.22	0
9	16920.00	-50.55	6.10	14.60	Horizontal	-42.05	-13.00	29.05	135
10	18800.00	-	-	-	-	-	-	-	-

Note: 1.The other Spurious RF Radiated emissions level is no more than noise floor.
2. The worst emission was found in the antenna is Horizontal position.



LTE Band 2 20MHz CH-Middle

Harmonic	Frequency (MHz)	SG (dBm)	Cable Loss (dB)	Gain (dBi)	Antenna Polarization	EIRP Level (dBm)	Limit (dBm)	Margin (dB)	Azimuth (deg)
2	3742.13	-39.43	2.60	12.50	Horizontal	-29.53	-13.00	16.53	0
3	5613.38	-56.46	3.30	12.50	Horizontal	-47.26	-13.00	34.26	135
4	7484.63	-55.13	4.20	12.20	Horizontal	-47.13	-13.00	34.13	45
5	9400.00	-52.04	4.30	11.10	Horizontal	-45.24	-13.00	32.24	225
6	11280.00	-50.32	5.90	11.90	Horizontal	-44.32	-13.00	31.32	0
7	13160.00	-51.53	5.70	14.00	Horizontal	-43.23	-13.00	30.23	0
8	15040.00	-45.55	5.80	13.10	Horizontal	-38.25	-13.00	25.25	135
9	16920.00	-49.74	6.10	14.60	Horizontal	-41.24	-13.00	28.24	45
10	18800.00	-	-	-	-	-	-	-	-

Note: 1.The other Spurious RF Radiated emissions level is no more than noise floor.

2. The worst emission was found in the antenna is Horizontal position.

6. Main Test Instruments

Name	Manufacturer	Type	Serial Number	Calibration Date	Expiration Date
Base Station Simulator	R&S	CMW500	113645	2021-05-15	2022-05-14
Base Station Simulator	R&S	CMU200	118133	2021-05-15	2022-05-14
Power Splitter	Hua Xiang	SHX-GF2-2-13	10120101	/	/
Spectrum Analyzer	Key sight	N9010A	MY50210259	2021-05-15	2022-05-14
Universal Radio Communication Tester	Key sight	E5515C	MY48367192	2021-5-15	2022-5-14
Signal Analyzer	R&S	FSV3030	101411	2020-12-13	2021-12-12
Loop Antenna	SCHWARZBECK	FMZB1519	1519-047	2020-04-02	2023-04-01
TRILOG Broadband Antenna	SCHWARZBECK	VULB 9163	391	2019-12-16	2022-12-15
Horn Antenna	R&S	HF907	100125	2020-05-25	2023-05-24
Horn Antenna	ETS-Lindgren	3160-09	00102644	2018-06-20	2023-06-19
Signal generator	R&S	SMB 100A	102594	2021-05-15	2022-05-14
Climatic Chamber	ESPEC	SU-242	93000506	2020-12-13	2021-12-12
Preamplifier	R&S	SCU18	102327	2021-05-15	2022-05-14
MOB COMMS DC SUPPLY	Keysight	66319D	MY43004105	2021-06-09	2021-12-08
RF Cable	Agilent	SMA 15cm	0001	2021-06-09	2021-12-08
Software	R&S	EMC32	9.26.0	/	/

*****END OF REPORT *****



ANNEX A: The EUT Appearance

The EUT Appearance are submitted separately.



ANNEX B: Test Setup Photos

The Test Setup Photos are submitted separately.



ANNEX C: Product Change Description

The Product Change Description are submitted separately.