



RF TEST REPORT

Applicant	ZTE Corporation
FCC ID	SRQ-A103ZT
Product	5G Digital Mobile Phone
Model	A103ZT
Report No.	R2108A0736-R6
Issue Date	September 27, 2021

TA Technology (Shanghai) Co., Ltd. tested the above equipment in accordance with the requirements in **FCC CFR47 Part 15E (2020)**. The test results show that the equipment tested is capable of demonstrating compliance with the requirements as documented in this report.

Prepared by: Peng Tao

Approved by: Kai Xu

TA Technology (Shanghai) Co., Ltd.

No.145, Jintang Rd, Tangzhen Industry Park, Pudong Shanghai, China

TEL: +86-021-50791141/2/3

FAX: +86-021-50791141/2/3-8000



TABLE OF CONTENT

1. Test Laboratory	4
1.1. Notes of the test report.....	4
1.2. Test facility	4
1.3. Testing Location.....	4
2. General Description of Equipment under Test.....	5
2.1. Applicant and Manufacturer Information.....	5
2.2. General information.....	5
3. Applied Standards	6
4. Test Configuration	7
5. Test Case Results	9
5.1. Occupied Bandwidth	9
5.2. Average Power Output.....	21
5.3. Frequency Stability.....	28
5.4. Power Spectral Density.....	32
5.5. Unwanted Emission	46
5.6. Conducted Emission	165
6. Main Test Instruments.....	168
ANNEX A: The EUT Appearance	169
ANNEX B: Test Setup Photos	170



Summary of measurement results

Number	Test Case	Clause in FCC rules	Verdict
1	Average output power	15.407(a)	PASS
2	Occupied bandwidth	15.407(e)	PASS
3	Frequency stability	15.407(g)	PASS
4	Power spectral density	15.407(a)	PASS
5	Unwanted Emissions	15.407(b)	PASS
6	Conducted Emissions	15.207	PASS

Date of Testing: August 20, 2021~ September 26, 2021
Date of Sample Received: August 16, 2021

Note: PASS: The EUT complies with the essential requirements in the standard.
FAIL: The EUT does not comply with the essential requirements in the standard.
All indications of Pass/Fail in this report are opinions expressed by TA Technology (Shanghai) Co., Ltd. based on interpretations and/or observations of test results. Measurement Uncertainties were not taken into account and are published for informational purposes only.



1. Test Laboratory

1.1. Notes of the test report

This report shall not be reproduced in full or partial, without the written approval of **TA technology (shanghai) co., Ltd.** The results documented in this report apply only to the tested sample, under the conditions and modes of operation as described herein. Measurement Uncertainties were not taken into account and are published for informational purposes only. This report is written to support regulatory compliance of the applicable standards stated above.

1.2. Test facility

FCC (Designation number: CN1179, Test Firm Registration Number: 446626)

TA Technology (Shanghai) Co., Ltd. has been listed on the US Federal Communications Commission list of test facilities recognized to perform electromagnetic emissions measurements.

A2LA (Certificate Number: 3857.01)

TA Technology (Shanghai) Co., Ltd. has been listed by American Association for Laboratory Accreditation to perform electromagnetic emission measurement.

1.3. Testing Location

Company: TA Technology (Shanghai) Co., Ltd.
Address: No.145, Jintang Rd, Tangzhen Industry Park, Pudong
City: Shanghai
Post code: 201201
Country: P. R. China
Contact: Xu Kai
Telephone: +86-021-50791141/2/3
Fax: +86-021-50791141/2/3-8000
Website: <http://www.ta-shanghai.com>
E-mail: xukai@ta-shanghai.com

2. General Description of Equipment under Test

2.1. Applicant and Manufacturer Information

Applicant	ZTE Corporation
Applicant address	ZTE Plaza, Keji Road South, Hi-Tech, Industrial Park, Nanshan District, Shenzhen, Guangdong, 518057, P.R.China
Manufacturer	ZTE Corporation
Manufacturer address	ZTE Plaza, Keji Road South, Hi-Tech, Industrial Park, Nanshan District, Shenzhen, Guangdong, 518057, P.R.China

2.2. General information

EUT Description	
Model	A103ZT
IMEI	IMEI 1:863601050011015 IMEI 2:863601050015412
Hardware Version	zm3A
Software Version	A103ZT a.1.0
Power Supply	Battery / AC adapter
Antenna Type	IFA Antenna
Antenna Gain	0.67dBi
Operating Frequency Range(s)	U-NII-1: 5150MHz-5250MHz U-NII-2A: 5250MHz -5350MHz U-NII-2C: 5470MHz-5725MHz
Modulation Type	802.11a/n (HT20/HT40) : OFDM 802.11ac (VHT20/VHT40/VHT80): OFDM
Max. Conducted Power	15.08dBm
Extreme temperature range:	-20 ° C to 50° C
Operating temperature range:	-10 ° C to 55° C
Operating voltage range:	3.5 V to 4.38V
State DC voltage:	3.85V
EUT Accessory	
Battery	Manufacturer: NingDe Amperex Technoiogy Ltd. Model: Li3939T44P8h896443
Type-C to 3.5 mm Headphone Jack	Manufacturer: JUWEI ELECTRONICS CO., LTD Model: JWUB1430-Z01
USB to Type C cable	Manufacturer: kingpower-tech Model: USBAF-TC20-B-15-HF
Note:1. The EUT is sent from the applicant to TA and the information of the EUT is declared by the applicant.	



3. Applied Standards

According to the specifications of the manufacturer, it must comply with the requirements of the following standards:

Test standards:

FCC CFR47 Part 15E (2020) Unlicensed National Information Infrastructure Devices

ANSI C63.10 (2013)

Reference standard:

KDB 789033 D02 General UNII Test Procedures New Rules v02r01

4. Test Configuration

Test Mode

The EUT has been associated with peripherals and configuration operated in a manner tended to maximize its emission characteristics in a typical application.

The radiated emission was measured in the following position: EUT stand-up position (Z axis), lie-down position (X, Y axis). The worst emission was found in stand-up position (Z axis) and the worst case was recorded.

In order to find the worst case condition, Pre-tests are needed at the presence of different data rate. Preliminary tests have been done on all the configuration for confirming worst case. Data rate below means worst-case rate of each test item.

Worst-case data rates are shown as following table.

Mode	Data Rate
802.11a	6 Mbps
802.11n HT20	MCS0
802.11n HT40	MCS0
802.11ac VHT20	MCS0
802.11ac VHT40	MCS0
802.11ac VHT80	MCS0

Wireless Technology and Frequency Range

Wireless Technology		Bandwidth	Channel	Frequency	
Wi-Fi	U-NII-1	20 MHz	36	5180MHz	
			40	5200MHz	
			44	5220MHz	
			48	5240MHz	
		40 MHz	38	5190MHz	
			46	5230MHz	
	U-NII-2A	80 MHz	42	5210MHz	
			20 MHz	52	5260MHz
				56	5280MHz
		60		5300MHz	
		64		5320MHz	
		40 MHz	54	5270MHz	
			62	5310MHz	
		80 MHz	58	5290MHz	
U-NII-2C	20 MHz		100	5500MHz	
		104	5520MHz		



			108	5540MHz	
			112	5560MHz	
			116	5580MHz	
			120	5600MHz	
			124	5620MHz	
			128	5640MHz	
			132	5660MHz	
			136	5680MHz	
			140	5700MHz	
			144	5720MHz	
			40 MHz	102	5510MHz
				110	5550MHz
				118	5590MHz
				126	5630MHz
	134	5670MHz			
	142	5710MHz			
	80 MHz	106	5530MHz		
		122	5610MHz		
		138	5690MHz		
	U-NII-3	20 MHz	149	5745MHz	
			153	5765MHz	
			157	5785MHz	
			161	5805MHz	
			165	5825MHz	
		40 MHz	151	5755MHz	
			159	5795MHz	
		80 MHz	155	5775MHz	
		Does this device support TPC Function? <input type="checkbox"/> Yes <input checked="" type="checkbox"/> No			
Does this device support TDWR Band? <input checked="" type="checkbox"/> Yes <input type="checkbox"/> No					

5. Test Case Results

5.1. Occupied Bandwidth

Ambient condition

Temperature	Relative humidity	Pressure
23°C ~25°C	45%~50%	101.5kPa

Method of Measurement

The EUT was connected to the spectrum analyzer through an external attenuator (20dB) and a known loss cable.

For U-NII-1/U-NII-2A/U-NII-2C, set RBW \approx 1% OCB kHz, VBW \geq 3 \times RBW, measure the maximum width of the emission that is constrained by the frequencies associated with the two outermost amplitude points (upper and lower frequencies) that are attenuated by 26 dB relative to the maximum level measured in the fundamental emission.

For U-NII-3, Set RBW = 100 kHz, VBW \geq 3 \times RBW, measure the maximum width of the emission that is constrained by the frequencies associated with the two outermost amplitude points (upper and lower frequencies) that are attenuated by 6 dB relative to the maximum level measured in the fundamental emission.

Note: The automatic bandwidth measurement capability of a spectrum analyzer or EMI receiver may be employed if it implements the functionality described above.

Use the 99 % power bandwidth function of the instrument

Test Setup

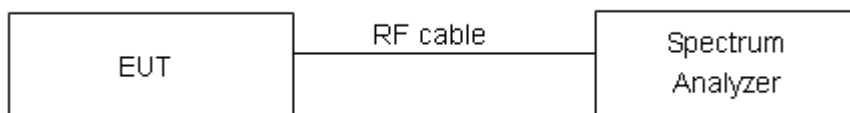

Limits

Rule FCC Part §15.407(e)

Within the 5.725-5.85 GHz band, the minimum 6 dB bandwidth of U-NII devices shall be at least 500 kHz.

Measurement Uncertainty

The assessed measurement uncertainty to ensure 95% confidence level for the normal distribution is with the coverage factor $k = 2$, $U = 936$ Hz.

Test Results:
U-NII-1

Mode	Carrier frequency (MHz)	99% bandwidth (MHz)	Minimum 26 dB bandwidth (MHz)	Conclusion
802.11a	5180	16.523	26.47	PASS
	5200	16.552	26.68	PASS
	5240	16.477	24.33	PASS
802.11n HT20	5180	17.656	25.96	PASS
	5200	17.622	25.59	PASS
	5240	17.655	27.71	PASS
802.11n HT40	5190	36.021	46.42	PASS
	5230	36.116	57.80	PASS
802.11ac VHT20	5180	17.550	19.74	PASS
	5200	17.534	19.97	PASS
	5240	17.551	19.94	PASS
802.11ac VHT40	5190	35.878	40.01	PASS
	5230	35.924	40.41	PASS
802.11ac VHT80	5210	75.401	82.00	PASS

U-NII-2A

Mode	Carrier frequency (MHz)	99% bandwidth (MHz)	Minimum 26 dB bandwidth (MHz)	Conclusion
802.11a	5260	16.511	29.66	PASS
	5300	16.508	24.51	PASS
	5320	16.555	25.26	PASS
802.11n HT20	5260	17.629	23.67	PASS
	5300	17.633	25.27	PASS
	5320	17.625	25.14	PASS
802.11n HT40	5270	36.208	58.94	PASS
	5310	36.046	58.55	PASS
802.11ac VHT20	5260	17.541	19.89	PASS
	5300	17.552	20.23	PASS
	5320	17.558	19.97	PASS
802.11ac VHT40	5270	35.928	40.20	PASS
	5310	35.898	40.15	PASS
802.11ac VHT80	5290	75.314	81.46	PASS



U-NII-2C

Mode	Carrier frequency (MHz)	99% bandwidth (MHz)	Minimum 26 dB bandwidth (MHz)	Conclusion
802.11a	5500	16.535	27.59	PASS
	5580	16.564	25.12	PASS
	5700	16.491	25.97	PASS
	5720	16.599	26.50	PASS
802.11n HT20	5500	17.635	27.90	PASS
	5580	17.721	27.75	PASS
	5700	17.607	23.87	PASS
	5720	17.624	27.72	PASS
802.11n HT40	5510	36.002	50.38	PASS
	5550	36.136	57.41	PASS
	5670	36.268	59.30	PASS
	5710	36.140	59.37	PASS
802.11ac VHT20	5500	17.551	20.16	PASS
	5580	17.542	20.21	PASS
	5700	17.540	20.12	PASS
	5720	17.544	20.04	PASS
802.11ac VHT40	5510	35.986	40.07	PASS
	5550	35.911	40.30	PASS
	5670	35.943	40.08	PASS
	5710	35.892	40.22	PASS
802.11ac VHT80	5530	75.319	101.40	PASS
	5690	75.355	97.88	PASS

U-NII-1, 802.11a
Carrier frequency (MHz): 5180



U-NII-1, 802.11n HT20
Carrier frequency (MHz): 5180

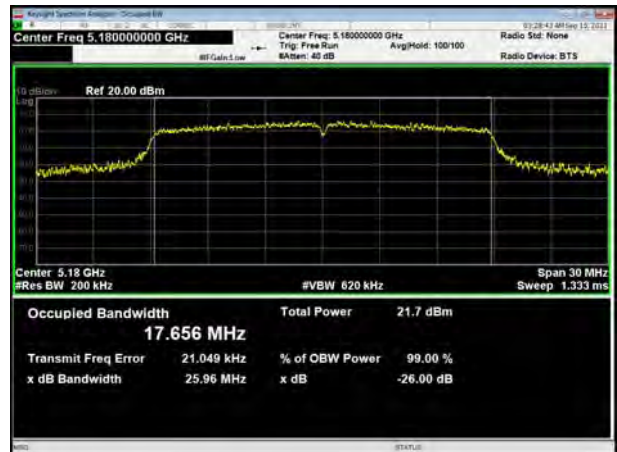

U-NII-1, 802.11a
Carrier frequency (MHz): 5200

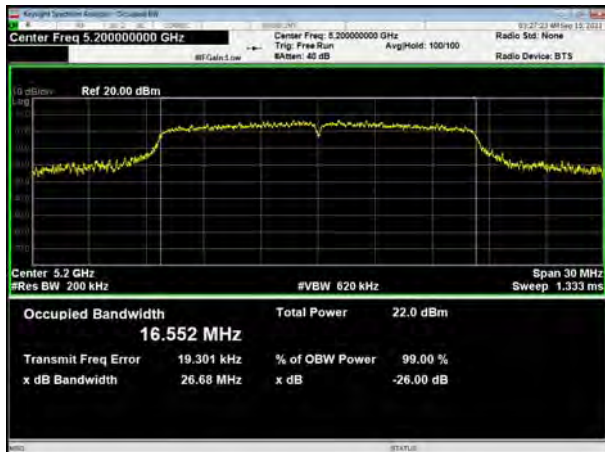

U-NII-1, 802.11n HT20
Carrier frequency (MHz): 5200

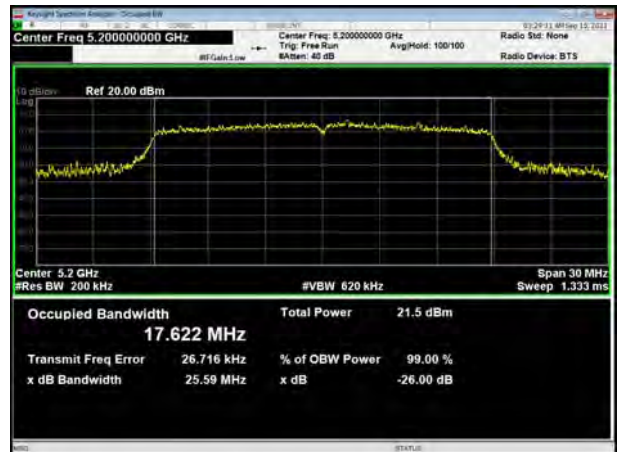

U-NII-1, 802.11a
Carrier frequency (MHz):5240



U-NII-1, 802.11n HT20
Carrier frequency (MHz):5240



U-NII-1, 802.11n HT40
Carrier frequency (MHz): 5190



U-NII-1, 802.11ac VHT20
Carrier frequency (MHz): 5180



U-NII-1, 802.11n HT40
Carrier frequency (MHz): 5230



U-NII-1, 802.11ac VHT20
Carrier frequency (MHz): 5200



U-NII-1, 802.11ac VHT40
Carrier frequency (MHz): 5190



U-NII-1, 802.11ac VHT20
Carrier frequency (MHz): 5240



U-NII-1, 802.11ac VHT40
Carrier frequency (MHz): 5230



U-NII-1, 802.11ac VHT80
Carrier frequency (MHz): 5210

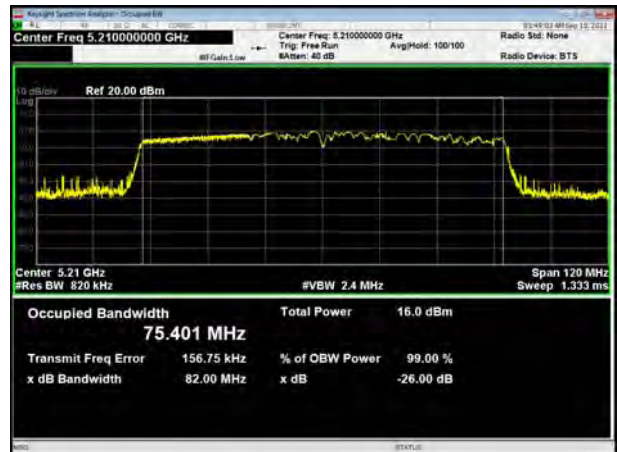

U-NII-2A, 802.11a
Carrier frequency (MHz): 5260

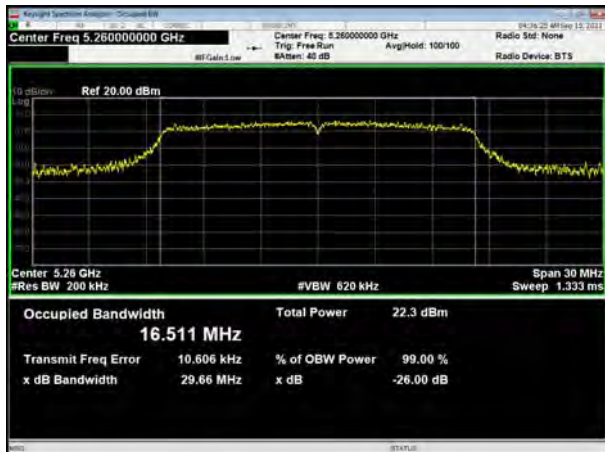

U-NII-2A, 802.11n HT20
Carrier frequency (MHz): 5260



U-NII-2A, 802.11a
Carrier frequency (MHz): 5300

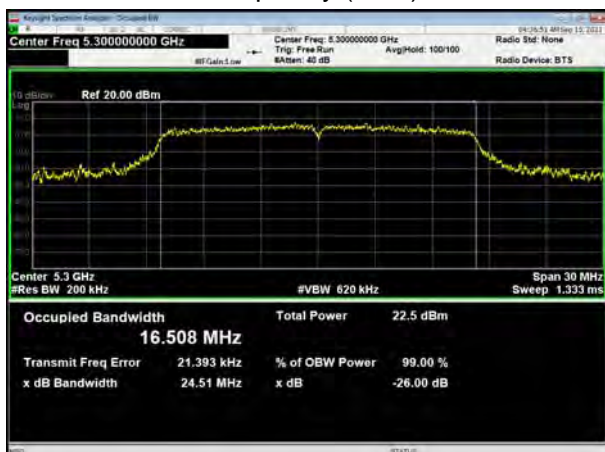

U-NII-2A, 802.11n HT20
Carrier frequency (MHz): 5300

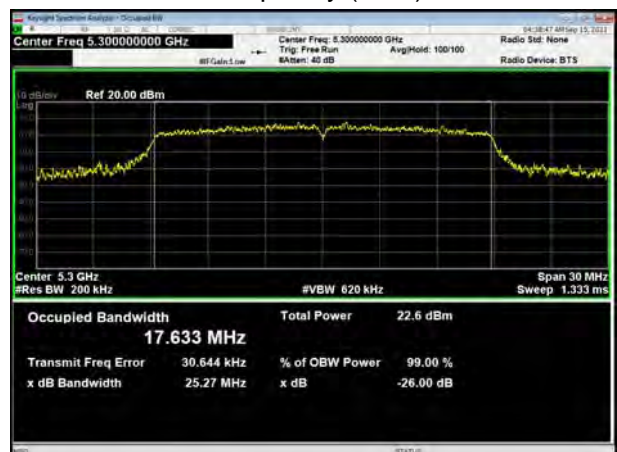



U-NII-2A, 802.11a
Carrier frequency (MHz):5320



U-NII-2A, 802.11n HT20
Carrier frequency (MHz):5320

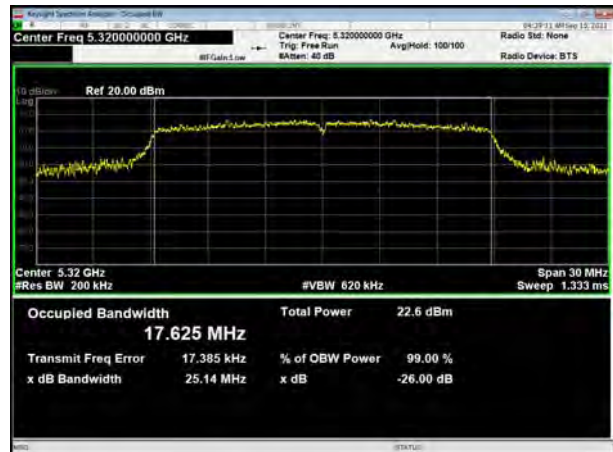

U-NII-2A, 802.11n HT40
Carrier frequency (MHz): 5270



U-NII-2A, 802.11ac VHT20
Carrier frequency (MHz):5260



U-NII-2A, 802.11n HT40
Carrier frequency (MHz): 5310



U-NII-2A, 802.11ac VHT20
Carrier frequency (MHz): 5300

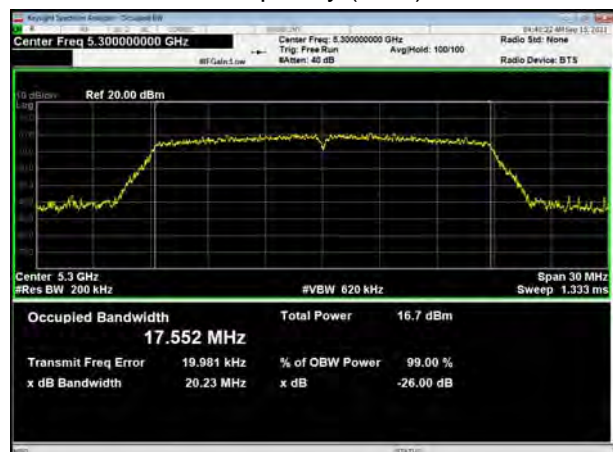



U-NII-2A, 802.11ac VHT40
Carrier frequency (MHz): 5270



U-NII-2A, 802.11ac VHT20
Carrier frequency (MHz): 5320



U-NII-2A, 802.11ac VHT40
Carrier frequency (MHz): 5310



U-NII-2A, 802.11ac VHT80
Carrier frequency (MHz): 5290

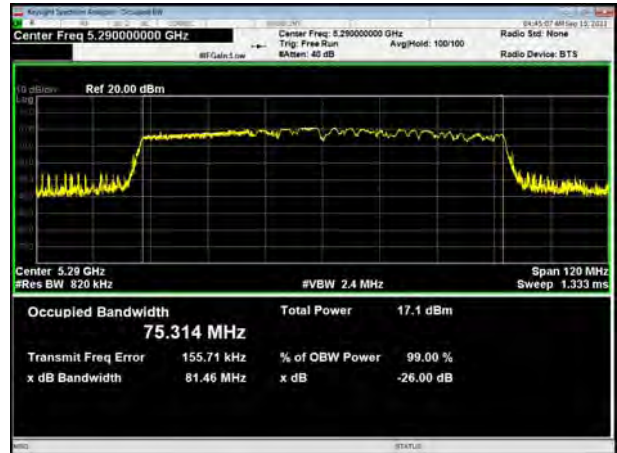

U-NII-2C, 802.11a
Carrier frequency (MHz): 5500



U-NII-2C, 802.11n HT20
Carrier frequency (MHz): 5500





U-NII-2C, 802.11a
Carrier frequency (MHz): 5580



U-NII-2C, 802.11n HT20
Carrier frequency (MHz): 5580

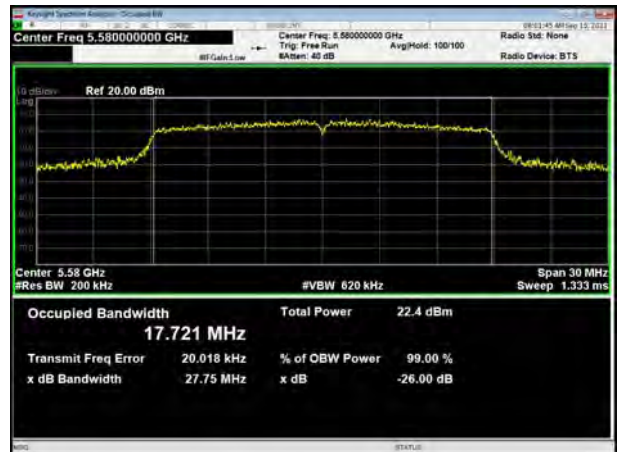

U-NII-2C, 802.11a
Carrier frequency (MHz):5700



U-NII-2C, 802.11n HT20
Carrier frequency (MHz):5700



U-NII-2C, 802.11a
Carrier frequency (MHz):5720



U-NII-2C, 802.11n HT20
Carrier frequency (MHz):5720



U-NII-2C, 802.11n HT40
Carrier frequency (MHz): 5510



U-NII-2C, 802.11ac VHT20
Carrier frequency (MHz): 5500



U-NII-2C, 802.11n HT40
Carrier frequency (MHz): 5550

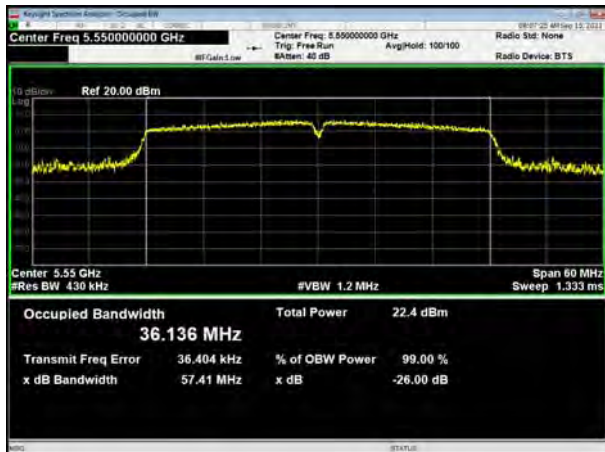

U-NII-2C, 802.11ac VHT20
Carrier frequency (MHz): 5580



U-NII-2C, 802.11n HT40
Carrier frequency (MHz): 5670

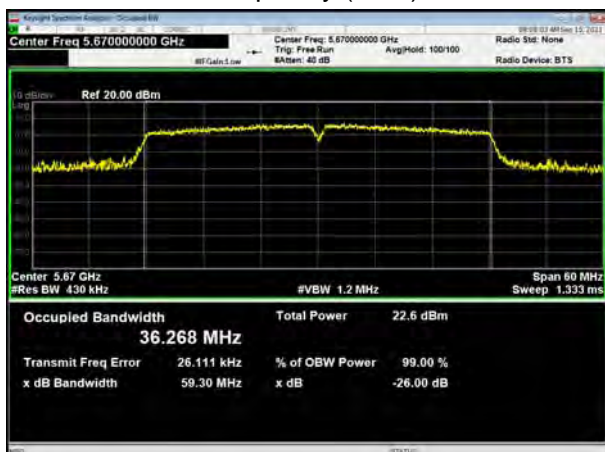

U-NII-2C, 802.11ac VHT20
Carrier frequency (MHz): 5700



U-NII-2C, 802.11n HT40
Carrier frequency (MHz): 5710



U-NII-2C, 802.11ac VHT20
Carrier frequency (MHz): 5720

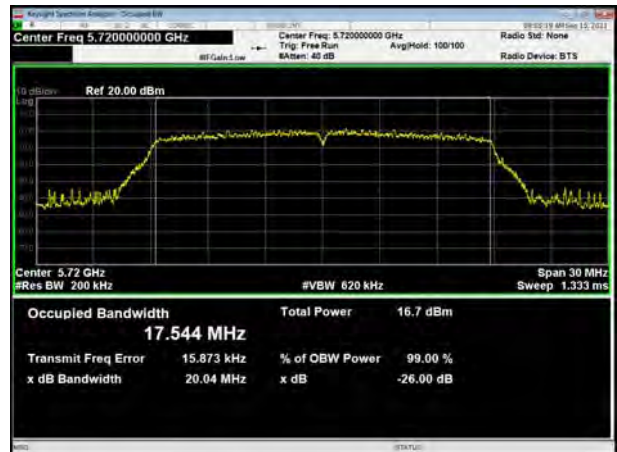

U-NII-2C, 802.11ac VHT40
Carrier frequency (MHz): 5510



U-NII-2C, 802.11ac VHT40
Carrier frequency (MHz): 5550



U-NII-2C, 802.11ac VHT40
Carrier frequency (MHz): 5670



U-NII-2C, 802.11ac VHT40
Carrier frequency (MHz): 5710





U-NII-2C, 802.11ac VHT80
Carrier frequency (MHz): 5530

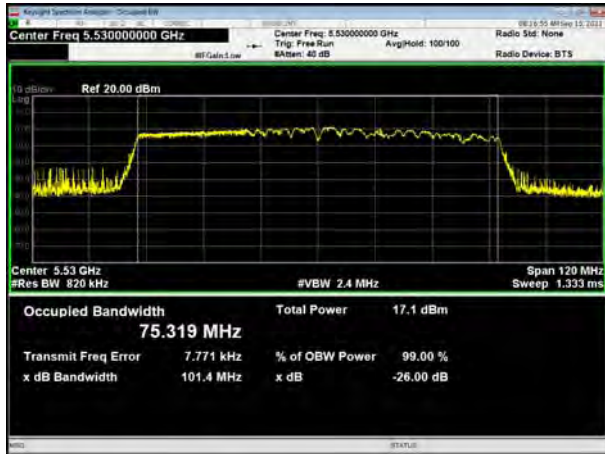

U-NII-2C, 802.11ac VHT80
Carrier frequency (MHz): 5690

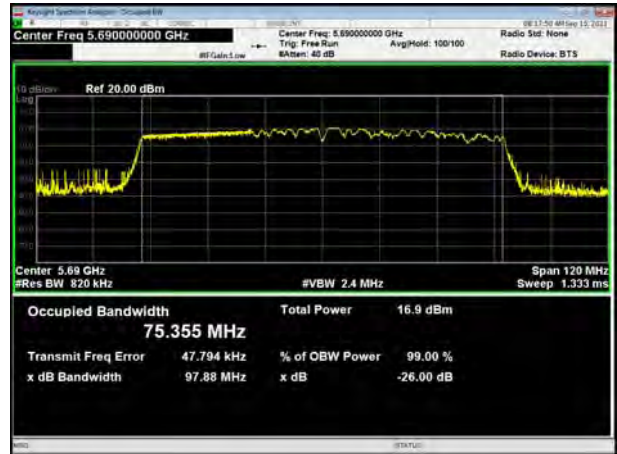

5.2. Average Power Output

Ambient condition

Temperature	Relative humidity	Pressure
23°C ~25°C	45%~50%	101.5kPa

Methods of Measurement

During the process of the testing, The EUT was connected to the average power meter through an external attenuator and a known loss cable. The EUT is max power transmission with proper modulation. We use Maximum average Conducted Output Power Level Method in KDB789033 for this test

Test Setup

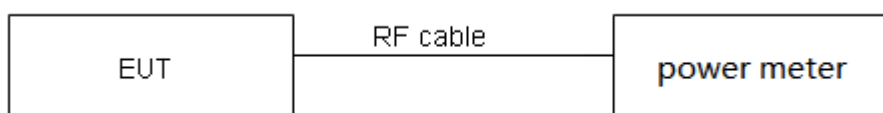

Limits

Rule FCC Part 15.407(a)(1)(2)(3)

(1) For the band 5.15-5.25 GHz.

(i) For an outdoor access point operating in the band 5.15-5.25 GHz, the maximum conducted output power over the frequency band of operation shall not exceed 1 W provided the maximum antenna gain does not exceed 6 dBi. In addition, the maximum power spectral density shall not exceed 17 dBm in any 1 megahertz band. If transmitting antennas of directional gain greater than 6 dBi are used, both the maximum conducted output power and the maximum power spectral density shall be reduced by the amount in dB that the directional gain of the antenna exceeds 6 dBi. The maximum e.i.r.p. at any elevation angle above 30 degrees as measured from the horizon must not exceed 125 mW (21 dBm).

(ii) For an indoor access point operating in the band 5.15-5.25 GHz, the maximum conducted output power over the frequency band of operation shall not exceed 1 W provided the maximum antenna gain does not exceed 6 dBi. In addition, the maximum power spectral density shall not exceed 17 dBm in any 1 megahertz band. If transmitting antennas of directional gain greater than 6 dBi are used, both the maximum conducted output power and the maximum power spectral density shall be reduced by the amount in dB that the directional gain of the antenna exceeds 6 dBi.

(iii) For fixed point-to-point access points operating in the band 5.15-5.25 GHz, the maximum conducted output power over the frequency band of operation shall not exceed 1 W. In addition, the maximum power spectral density shall not exceed 17 dBm in any 1 megahertz band. Fixed point-to-point U-NII devices may employ antennas with directional gain up to 23 dBi without any corresponding reduction in the maximum conducted output power or maximum power spectral density. For fixed point-to-point transmitters that employ a directional antenna gain greater than 23 dBi, a 1 dB reduction in maximum conducted output power and maximum power spectral density is required for each 1 dB of antenna gain in excess of 23 dBi. Fixed, point-to-point operations exclude



the use of point-to-multipoint systems, omnidirectional applications, and multiple collocated transmitters transmitting the same information. The operator of the U-NII device, or if the equipment is professionally installed, the installer, is responsible for ensuring that systems employing high gain directional antennas are used exclusively for fixed, point-to-point operations.

(iv) For client devices in the 5.15-5.25 GHz band, the maximum conducted output power over the frequency band of operation shall not exceed 250 mW provided the maximum antenna gain does not exceed 6 dBi. In addition, the maximum power spectral density shall not exceed 11 dBm in any 1 megahertz band. If transmitting antennas of directional gain greater than 6 dBi are used, both the maximum conducted output power and the maximum power spectral density shall be reduced by the amount in dB that the directional gain of the antenna exceeds 6 dBi.

(2) For the 5.25-5.35 GHz and 5.47-5.725 GHz bands, the maximum conducted output power over the frequency bands of operation shall not exceed the lesser of 250 mW or $11 \text{ dBm} + 10 \log B$, where B is the 26 dB emission bandwidth in megahertz. In addition, the maximum power spectral density shall not exceed 11 dBm in any 1 megahertz band. If transmitting antennas of directional gain greater than 6 dBi are used, both the maximum conducted output power and the maximum power spectral density shall be reduced by the amount in dB that the directional gain of the antenna exceeds 6 dBi.

Measurement Uncertainty

The assessed measurement uncertainty to ensure 95% confidence level for the normal distribution is with the coverage factor $k = 2$, $U = 0.44 \text{ dB}$.

Test Results

Mode	T _{on} (ms)	T _(on+off) (ms)	Duty cycle	Duty cycle correction Factor(dB)
802.11a	1.39	1.42	0.98	NA
802.11n HT20	1.30	1.34	0.97	0.13
802.11n HT40	0.65	0.68	0.95	0.23
802.11ac VHT20	1.29	1.32	0.98	0.11
802.11ac VHT40	0.64	0.67	0.95	0.24
802.11ac VHT80	1.05	1.08	0.97	0.11

Note: when Duty cycle ≥ 0.98 , Duty cycle correction Factor not required.

Power Index								
Channel	802.11a	802.11n HT20	802.11ac VHT20	Channel	802.11n HT40	802.11ac VHT40	Channel	802.11ac VHT80
CH36	20	20	14	CH38	19	14	CH42	14
CH40	20	20	14	CH46	20	14	/	/
CH48	20	20	14	/	/	/	/	/
CH52	20	20	14	CH54	20	14	CH58	14
CH60	20	20	14	CH62	19	14	/	/
CH64	20	20	14	/	/	/	/	/
CH100	20	20	14	CH102	17	14	CH106	14
CH116	20	20	14	CH110	20	14	CH138	14
CH140	19	19	14	CH134	20	14	/	/
CH144	20	20	14	CH142	20	14	/	/



Test Mode		Channel/Frequency (MHz)	B=26 dB bandwidth (MHz)	Limit 11 dBm + 10 log B (dBm)	Final Limit(dBm)
U-NII-2A	802.11a	52/5260	29.66	25.72>24	24.00
		60/5300	24.51	24.89>24	24.00
		64/5320	25.26	25.02>24	24.00
	802.11n HT20	52/5260	23.67	24.74>24	24.00
		60/5300	25.27	25.03>24	24.00
		64/5320	25.14	25.00>24	24.00
	802.11n HT40	54/5270	58.94	28.70>24	24.00
		62/5310	58.55	28.68>24	24.00
	802.11ac VHT20	52/5260	18.89	23.76<24	23.76
		60/5300	20.23	24.06>24	24.00
		64/5320	19.97	24.00	24.00
	802.11ac VHT40	54/5270	40.20	27.04>24	24.00
62/5310		40.15	27.04>24	24.00	
802.11ac VHT80	58/5290	81.46	30.11>24	24.00	
U-NII-2C	802.11a	100/5500	27.59	25.41>24	24.00
		116/5580	25.12	25.00>24	24.00
		140/5700	25.97	25.14>24	24.00
		144/5720	26.50	25.23>24	24.00
	802.11n HT20	100/5500	27.90	25.46>24	24.00
		116/5580	27.75	25.43>24	24.00
		140/5700	23.87	24.78>24	24.00
		144/5720	27.72	25.43>24	24.00
	802.11n HT40	102/5510	50.38	28.02>24	24.00
		110/5550	57.41	28.59>24	24.00
		134/5670	59.30	28.73>24	24.00
		142/5710	59.37	28.74>24	24.00
	802.11ac VHT20	100/5500	20.16	24.04>24	24.00
		116/5580	20.21	24.06>24	24.00
		140/5700	20.12	24.04>24	24.00
		144/5720	20.04	24.02>24	24.00
	802.11ac VHT40	102/5510	40.07	27.03>24	24.00
		110/5550	40.30	27.05>24	24.00
		134/5670	40.08	27.03>24	24.00
		142/5710	40.22	27.04>24	24.00
	802.11ac VHT80	106/5530	101.40	31.06>24	24.00
		138/5690	97.88	30.91>24	24.00

Note: 250mW=24dBm

Note: Average Power with duty factor = Average Power Measured +Duty cycle correction factor



U-NII-1

Test Mode	Channel/ Frequency (MHz)	Average Power Measured (dBm)	Average Power with duty factor (dBm)	Limit (dBm)	Conclusion
802.11a	36/5180	14.04	14.04	24	PASS
	40/5200	14.38	14.38	24	PASS
	48/5240	13.96	13.96	24	PASS
802.11n HT20	36/5180	13.89	14.02	24	PASS
	40/5200	14.24	14.37	24	PASS
	48/5240	14.95	15.08	24	PASS
802.11n HT40	38/5190	14.02	14.25	24	PASS
	46/5230	14.51	14.74	24	PASS
802.11ac VHT20	36/5180	8.19	8.30	24	PASS
	40/5200	8.54	8.65	24	PASS
	48/5240	8.13	8.24	24	PASS
802.11ac VHT40	38/5190	8.39	8.63	24	PASS
	46/5230	8.37	8.61	24	PASS
802.11ac VHT80	42/5210	8.19	8.30	24	PASS

Note: Average Power with duty factor = Average Power Measured +Duty cycle correction factor



U-NII-2A

Test Mode	Channel/ Frequency (MHz)	Average Power Measured (dBm)	Average Power with duty factor (dBm)	Limit (dBm)	Conclusion
802.11a	52/5260	14.15	14.15	24.00	PASS
	60/5300	14.47	14.47	24.00	PASS
	64/5320	14.72	14.72	24.00	PASS
802.11n HT20	52/5260	14.17	14.30	24.00	PASS
	60/5300	14.38	14.51	24.00	PASS
	64/5320	14.69	14.82	24.00	PASS
802.11n HT40	54/5270	14.51	14.74	24.00	PASS
	62/5310	13.85	14.08	24.00	PASS
802.11ac VHT20	52/5260	8.29	8.40	23.76	PASS
	60/5300	8.54	8.65	24.00	PASS
	64/5320	8.47	8.58	24.00	PASS
802.11ac VHT40	54/5270	8.49	8.73	24.00	PASS
	62/5310	8.68	8.92	24.00	PASS
802.11ac VHT80	58/5290	8.86	8.97	24.00	PASS

Note: Average Power with duty factor = Average Power Measured +Duty cycle correction factor



U-NII-2C

Test Mode	Channel/ Frequency (MHz)	Average Power Measured (dBm)	Average Power with duty factor (dBm)	Limit (dBm)	Conclusion
802.11a	100/5500	14.81	14.81	24.00	PASS
	116/5580	14.68	14.68	24.00	PASS
	140/5700	14.09	14.09	24.00	PASS
	144/5720	14.52	14.52	24.00	PASS
802.11n HT20	100/5500	14.68	14.81	24.00	PASS
	116/5580	14.49	14.62	24.00	PASS
	140/5700	13.97	14.10	24.00	PASS
	144/5720	14.07	14.20	24.00	PASS
802.11n HT40	102/5510	12.43	12.66	24.00	PASS
	110/5550	14.73	14.96	24.00	PASS
	134/5670	14.20	14.43	24.00	PASS
	142/5710	14.49	14.72	24.00	PASS
802.11ac VHT20	100/5500	8.76	8.87	24.00	PASS
	116/5580	8.54	8.65	24.00	PASS
	140/5700	8.12	8.23	24.00	PASS
	144/5720	8.51	8.62	24.00	PASS
802.11ac VHT40	102/5510	8.57	8.81	24.00	PASS
	110/5550	8.67	8.91	24.00	PASS
	134/5670	8.14	8.38	24.00	PASS
	142/5710	8.43	8.67	24.00	PASS
802.11ac VHT80	106/5530	8.69	8.80	24.00	PASS
	138/5690	8.43	8.54	24.00	PASS

Note: Average Power with duty factor = Average Power Measured +Duty cycle correction factor

5.3. Frequency Stability

Ambient condition

Temperature	Relative humidity	Pressure
23°C ~25°C	45%~50%	101.5kPa

Method of Measurement

1. Frequency stability with respect to ambient temperature

- a) Supply the EUT with a nominal ac voltage or install a new or fully charged battery in the EUT. If possible, a dummy load shall be connected to the EUT because an antenna near the metallic walls of an environmental test chamber could affect the output frequency of the EUT. If the EUT is equipped with a permanently attached, adjustable-length antenna, then the EUT shall be placed in the center of the chamber with the antenna adjusted to the shortest length possible. Turn ON the EUT and tune it to one of the number of frequencies shown in 5.6.
- b) Couple the unlicensed wireless device output to the measuring instrument by connecting an antenna to the measuring instrument with a suitable length of coaxial cable and placing the measuring antenna near the EUT (e.g., 15 cm away), or by connecting a dummy load to the measuring instrument, through an attenuator if necessary.
- c) Adjust the location of the measurement antenna and the controls on the measurement instrument to obtain a suitable signal level (i.e., a level that will not overload the measurement instrument but is strong enough to allow measurement of the operating or fundamental frequency of the EUT).
- d) Turn the EUT OFF and place it inside the environmental temperature chamber. For devices that have oscillator heaters, energize only the heater circuit.
- e) Set the temperature control on the chamber to the highest specified in the regulatory requirements for the type of device and allow the oscillator heater and the chamber temperature to stabilize.
- f) While maintaining a constant temperature inside the environmental chamber, turn the EUT ON and record the operating frequency at startup, and at 2 minutes, 5 minutes, and 10 minutes after the EUT is energized. Four measurements in total are made.
- g) Measure the frequency at each of frequencies specified in 5.6.
- h) Switch OFF the EUT but do not switch OFF the oscillator heater.
- i) Lower the chamber temperature by not more than 10°C, and allow the temperature inside the chamber to stabilize.
- j) Repeat step f) through step i) down to the lowest specified temperature.

2. Frequency stability when varying supply voltage

Unless otherwise specified, these tests shall be made at ambient room temperature (+15°C to +25 °C). An antenna shall be connected to the antenna output terminals of the EUT if possible. If the EUT is equipped with or uses an adjustable-length antenna, then it shall be fully extended.

- a) Supply the EUT with nominal voltage or install a new or fully charged battery in the EUT. Turn ON the EUT and couple its output to a frequency counter or other frequency-measuring instrument.



- b) Tune the EUT to one of the number of frequencies required in 5.6. Adjust the location of the measurement antenna and the controls on the measurement instrument to obtain a suitable signal level (i.e., a level that will not overload the measurement instrument but is strong enough to allow measurement of the operating or fundamental frequency of the EUT).
- c) Measure the frequency at each of the frequencies specified in 5.6.
- d) Repeat the above procedure at 85% and 115% of the nominal supply voltage.

Limit

Manufacturers of U-NII devices are responsible for ensuring frequency stability such that an emission is maintained within the band of operation under all conditions of normal operation as specified in the users manual.

Measurement Uncertainty

The assessed measurement uncertainty to ensure 95% confidence level for the normal distribution is with the coverage factor $k = 2$, $U = 936\text{Hz}$

**Test Results**

Voltage (V)	Temperature (°C)	U-NII-1 Test Results			
		5200MHz			
		1min	2min	5min	10min
3.85	-20	5200.004178	5199.999485	5199.994379	5199.986274
3.85	-10	5199.997047	5199.998404	5199.985930	5199.978835
3.85	0	5199.989850	5199.995696	5199.982760	5199.969291
3.85	10	5199.982555	5199.986469	5199.981907	5199.961634
3.85	20	5199.982183	5199.978877	5199.977155	5199.953851
3.85	30	5199.976105	5199.978273	5199.975127	5199.948699
3.85	40	5199.971468	5199.975973	5199.968942	5199.948398
3.85	50	5199.967708	5199.966488	5199.965254	5199.939354
3.50	20	5199.959752	5199.964710	5199.964920	5199.930717
4.38	20	5199.950719	5199.955678	5199.964213	5199.921587
Max. ΔMHz		-0.049281	-0.044322	-0.035787	-0.078413
PPM		-9.477086	-8.523443	-6.882027	-15.079515

Voltage (V)	Temperature (°C)	U-NII-2A Test Results			
		5300MHz			
		1min	2min	5min	10min
3.85	-20	5300.004745	5299.998321	5299.997759	5299.991376
3.85	-10	5299.995973	5299.993374	5299.992832	5299.989653
3.85	0	5299.989972	5299.993158	5299.985282	5299.981217
3.85	10	5299.984980	5299.988250	5299.983240	5299.974520
3.85	20	5299.981842	5299.981828	5299.977966	5299.969414
3.85	30	5299.980584	5299.979031	5299.972500	5299.968554
3.85	40	5299.976236	5299.977388	5299.970756	5299.961827
3.85	50	5299.968890	5299.977164	5299.962691	5299.961361
3.50	20	5299.959476	5299.976856	5299.954854	5299.961239
4.38	20	5299.956298	5299.968051	5299.945634	5299.952293
Max. ΔMHz		-0.043702	-0.031949	-0.054366	-0.047707
PPM		-8.245737	-6.028195	-10.257818	-9.001274



Voltage (V)	Temperature (°C)	U-NII-2C Test Results			
		5580MHz			
		1min	2min	5min	10min
3.85	-20	5579.998188	5579.994626	5579.991035	5579.986385
3.85	-10	5579.996834	5579.984887	5579.982068	5579.986305
3.85	0	5579.994520	5579.978951	5579.978003	5579.977742
3.85	10	5579.984877	5579.976461	5579.977953	5579.972808
3.85	20	5579.975447	5579.968208	5579.968153	5579.972484
3.85	30	5579.966717	5579.965080	5579.961809	5579.967098
3.85	40	5579.962248	5579.963574	5579.956750	5579.959336
3.85	50	5579.953110	5579.955993	5579.954024	5579.949514
3.50	20	5579.946764	5579.949075	5579.948251	5579.946522
4.38	20	5579.944783	5579.945814	5579.946523	5579.946211
Max. ΔMHz		-0.055217	-0.054186	-0.053477	-0.053789
PPM		-9.895532	-9.710726	-9.583771	-9.639616

5.4. Power Spectral Density

Ambient condition

Temperature	Relative humidity	Pressure
23°C ~25°C	45%~50%	101.5kPa

Method of Measurement

The EUT was connected to the spectrum analyzer through an external attenuator (20dB) and a known loss cable.

Set RBW = 1MHz, VBW =3MHz for the band 5.150-5.250GHz, 5.250-5.350GHz, 5.470-5.725GHz.

The conducted PSD is measured at each antenna port. The measured results at the various antenna ports are then summed mathematically.

Test setup

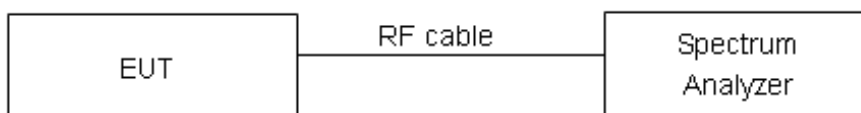

Limits

Rule FCC Part 15.407(a)(1)/ Part 15.407(a)(2) / Part 15.407(a)(3)

For an indoor access point operating in the band 5.15-5.25 GHz, the maximum power spectral density shall not exceed 17 dBm in any 1 megahertz band. If transmitting antennas of directional gain greater than 6 dBi are used, both the maximum conducted output power and the maximum power spectral density shall be reduced by the amount in dB that the directional gain of the antenna exceeds 6 dBi.

For client devices in the 5.15-5.25 GHz band, the maximum conducted output power over the frequency band of operation shall not exceed 250 mW provided the maximum antenna gain does not exceed 6 dBi. In addition, the maximum power spectral density shall not exceed 11 dBm in any 1 megahertz band. If transmitting antennas of directional gain greater than 6 dBi are used, both the maximum conducted output power and the maximum power spectral density shall be reduced by the amount in dB that the directional gain of the antenna exceeds 6 dBi.

For the 5.25-5.35 GHz and 5.47-5.725 GHz bands, the maximum power spectral density shall not exceed 11 dBm in any 1 megahertz band. If transmitting antennas of directional gain greater than 6 dBi are used, both the maximum conducted output power and the maximum power spectral density shall be reduced by the amount in dB that the directional gain of the antenna exceeds 6 dBi.

For the band 5.725-5.85 GHz, the maximum power spectral density shall not exceed 30 dBm in any 500kHz band. If transmitting antennas of directional gain greater than 6 dBi are used, both the maximum conducted output power and the maximum power spectral density shall be reduced by the amount in dB that the directional gain of the antenna exceeds 6 dBi.



Frequency Bands/MHz	Limits
5150-5250	11dBm/MHz
5.25-5.35 GHz and 5.47-5.725 GHz	11dBm/MHz
5725-5850	30dBm/500kHz

Measurement Uncertainty

The assessed measurement uncertainty to ensure 95% confidence level for the normal distribution is with the coverage factor $k = 2$, $U = 0.75\text{dB}$.

**Test Results:**

Note: Power Spectral Density =Read Value+Duty cycle correction factor

U-NII-1

Mode	Channel Number	Read Value (dBm /MHz)	Power Spectral Density (dBm /MHz)	Limit (dBm /MHz)	Conclusion
802.11a	36/5180	6.437	6.44	11	PASS
	40/5200	6.159	6.16	11	PASS
	48/5240	6.569	6.57	11	PASS
802.11n HT20	36/5180	5.770	5.90	11	PASS
	40/5200	6.165	6.30	11	PASS
	48/5240	6.211	6.34	11	PASS
802.11n HT40	38/5190	1.583	1.82	11	PASS
	46/5230	3.001	3.24	11	PASS
802.11ac VHT20	36/5180	-0.043	0.06	11	PASS
	40/5200	0.211	0.32	11	PASS
	48/5240	0.672	0.78	11	PASS
802.11ac VHT40	38/5190	-3.149	-2.91	11	PASS
	46/5230	-2.812	-2.57	11	PASS
802.11ac VHT80	42/5210	-4.980	-4.87	11	PASS

U-NII-2A

Mode	Channel Number	Read Value (dBm /MHz)	Power Spectral Density (dBm /MHz)	Limit (dBm /MHz)	Conclusion
802.11a	52/5260	7.102	7.10	11	PASS
	60/5300	7.468	7.47	11	PASS
	64/5320	7.294	7.29	11	PASS
802.11n HT20	52/5260	6.730	6.86	11	PASS
	60/5300	6.948	7.08	11	PASS
	64/5320	6.827	6.96	11	PASS
802.11n HT40	54/5270	4.016	4.25	11	PASS
	62/5310	3.049	3.28	11	PASS
802.11ac VHT20	52/5260	1.244	1.35	11	PASS
	60/5300	1.286	1.39	11	PASS
	64/5320	1.288	1.39	11	PASS
802.11ac VHT40	54/5270	-2.198	0.24	11	PASS
	62/5310	-1.626	-1.39	11	PASS
802.11ac VHT80	58/5290	-4.234	-4.12	11	PASS



U-NII-2C

Mode	Channel Number	Read Value (dBm /MHz)	Power Spectral Density (dBm /MHz)	Limit (dBm /MHz)	Conclusion
802.11a	100/5500	6.943	6.94	11	PASS
	116/5580	6.907	6.91	11	PASS
	140/5700	6.115	6.12	11	PASS
	144/5720	7.036	7.04	11	PASS
802.11n HT20	100/5500	6.807	6.94	11	PASS
	116/5580	6.545	6.68	11	PASS
	140/5700	5.742	5.87	11	PASS
	144/5720	6.881	7.01	11	PASS
802.11n HT40	102/5510	1.443	1.68	11	PASS
	110/5550	3.985	4.22	11	PASS
	134/5670	4.055	4.29	11	PASS
	142/5710	4.023	4.26	11	PASS
802.11ac VHT20	100/5500	1.541	1.65	11	PASS
	116/5580	0.711	0.82	11	PASS
	140/5700	0.880	0.99	11	PASS
	144/5720	1.355	1.46	11	PASS
802.11ac VHT40	102/5510	-2.252	-2.01	11	PASS
	110/5550	-1.745	-1.51	11	PASS
	134/5670	-2.410	-2.17	11	PASS
	142/5710	-1.998	-1.76	11	PASS
802.11ac VHT80	106/5530	-3.670	-3.56	11	PASS
	138/5690	-4.659	-4.54	11	PASS



U-NII-1, 802.11a, Channel No.: 36

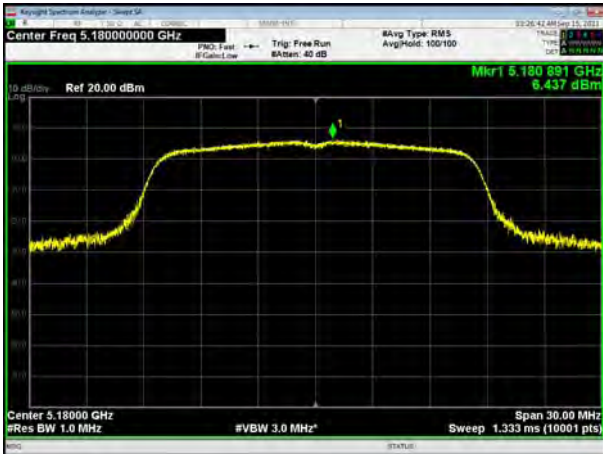

U-NII-1, 802.11n HT20, Channel No.: 36



U-NII-1, 802.11a, Channel No.: 40



U-NII-1, 802.11n HT20, Channel No.: 40



U-NII-1, 802.11a, Channel No.: 48

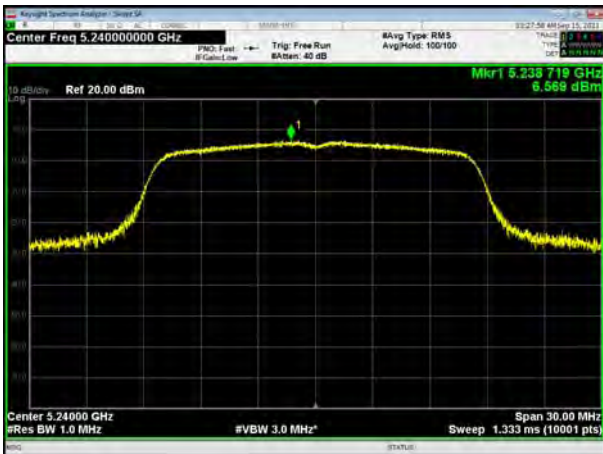

U-NII-1, 802.11n HT20, Channel No.: 48





U-NII-1, 802.11n HT40, Channel No.: 38



U-NII-1, 802.11ac VHT20, Channel No.: 36



U-NII-1, 802.11n HT40, Channel No.: 46



U-NII-1, 802.11ac VHT20, Channel No.: 40



U-NII-1, 802.11ac VHT40, Channel No.: 38



U-NII-1, 802.11ac VHT20, Channel No.: 48





U-NII-1, 802.11ac VHT40, Channel No.: 46



U-NII-1, 802.11ac VHT80, Channel No.: 42



U-NII-2A, 802.11a, Channel No.: 52

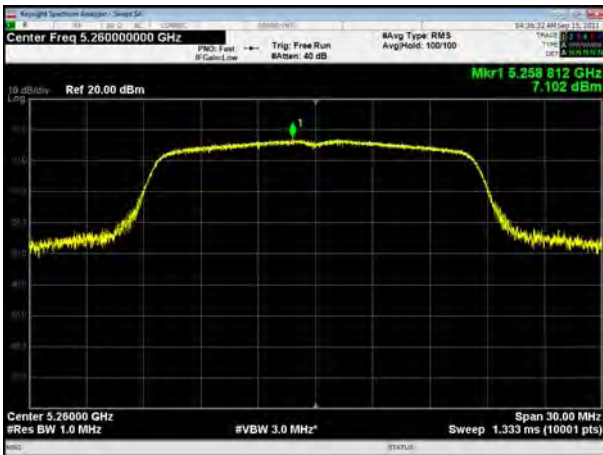

U-NII-2A, 802.11n HT20, Channel No.: 52

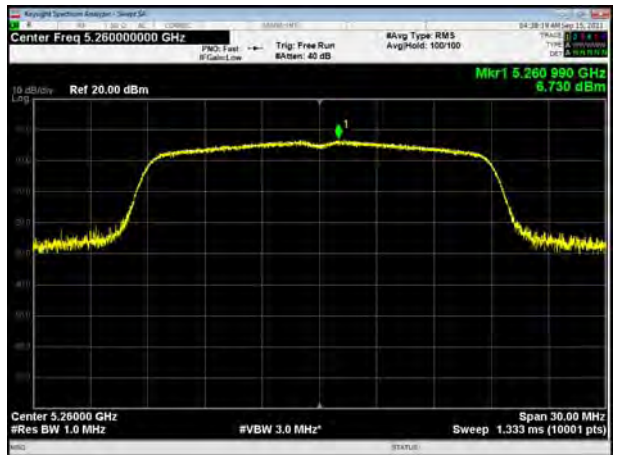

U-NII-2A, 802.11a, Channel No.: 60



U-NII-2A, 802.11n HT20, Channel No.: 60



U-NII-2A, 802.11a, Channel No.: 64



U-NII-2A, 802.11n HT20, Channel No.: 64

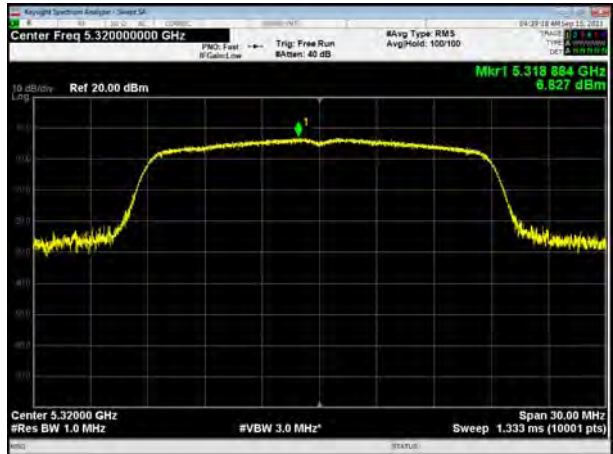

U-NII-2A, 802.11n HT40, Channel No.: 54



U-NII-2A, 802.11ac VHT20, Channel No.:52



U-NII-2A, 802.11n HT40, Channel No.: 62

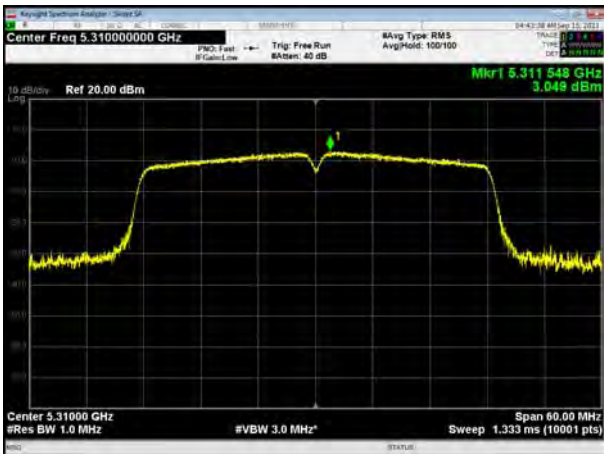

U-NII-2A, 802.11ac VHT20, Channel No.: 60

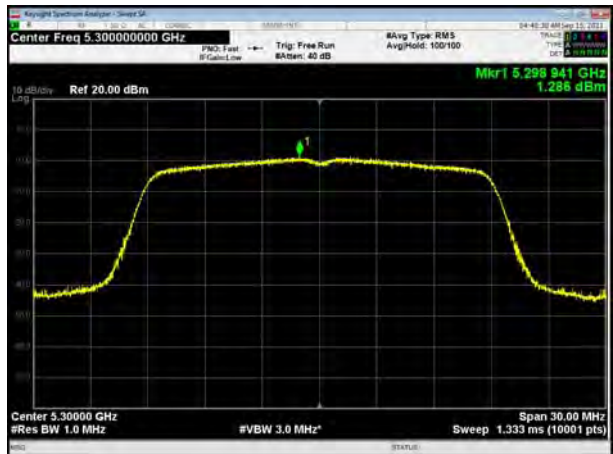



U-NII-2A, 802.11ac VHT40, Channel No.: 54

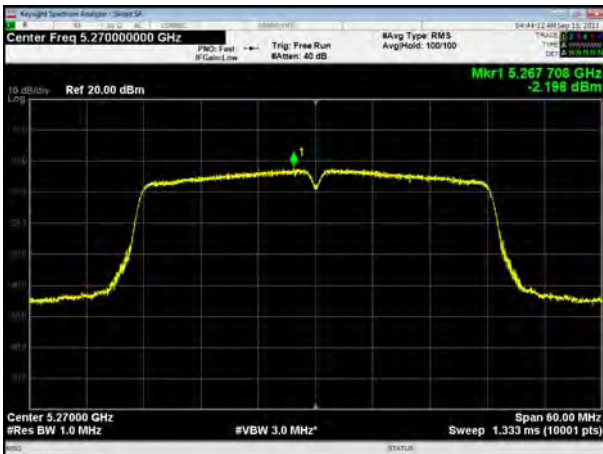

U-NII-2A, 802.11ac VHT20, Channel No.: 64

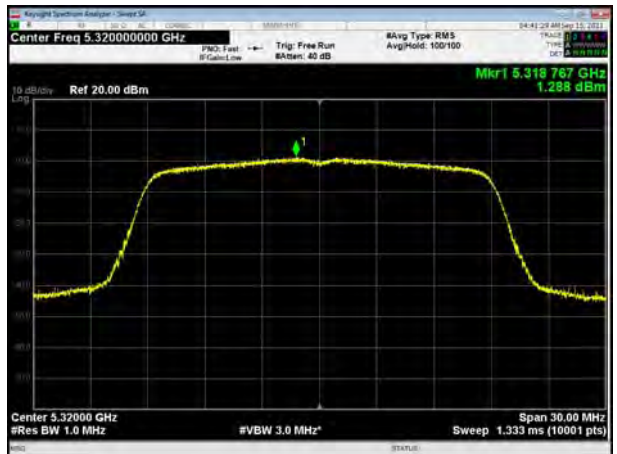

U-NII-2A, 802.11ac VHT40, Channel No.: 62

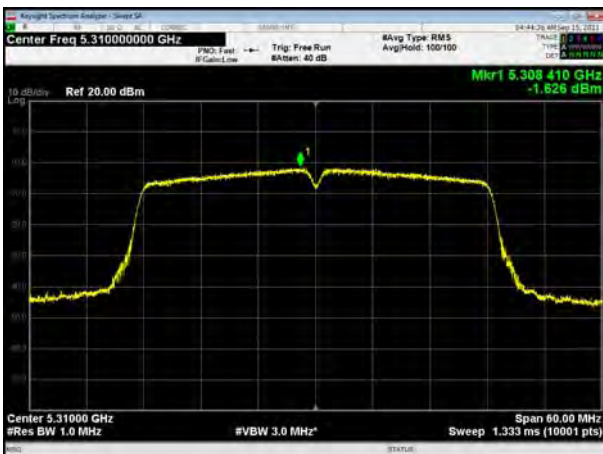

U-NII-2A, 802.11ac VHT80, Channel No.: 58

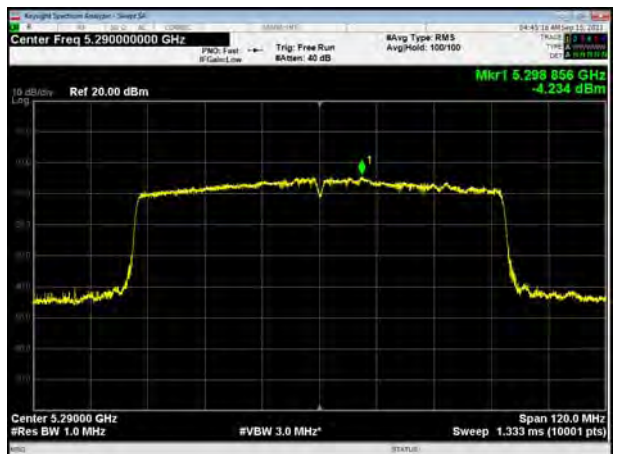

U-NII-2C, 802.11a, Channel No.: 100

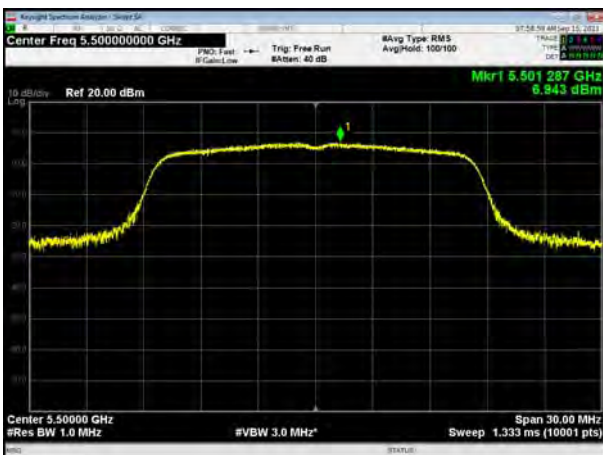

U-NII-2C, 802.11n HT20, Channel No.: 100



U-NII-2C, 802.11a, Channel No.: 116

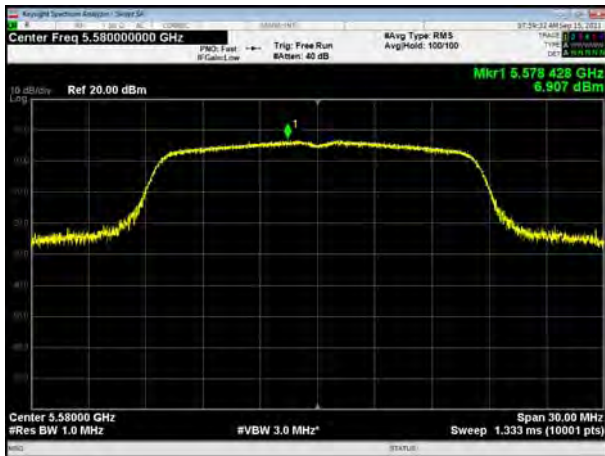

U-NII-2C, 802.11n HT20, Channel No.: 116

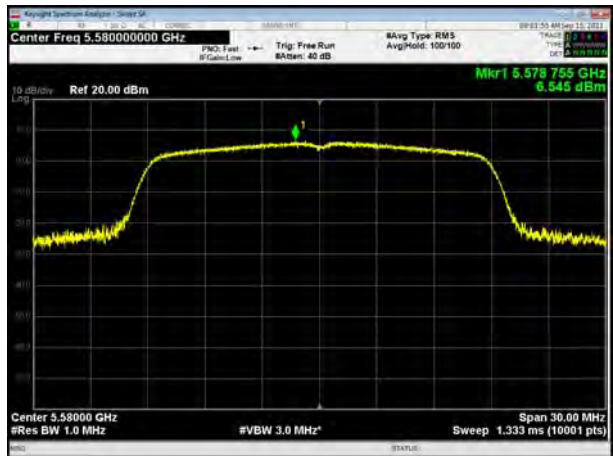

U-NII-2C, 802.11a, Channel No.: 140

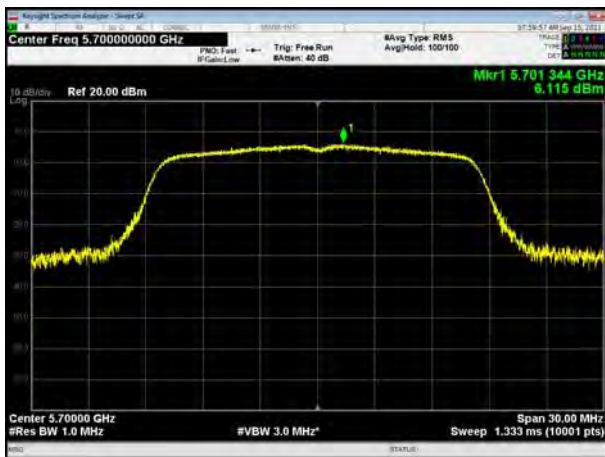

U-NII-2C, 802.11n HT20, Channel No.: 140

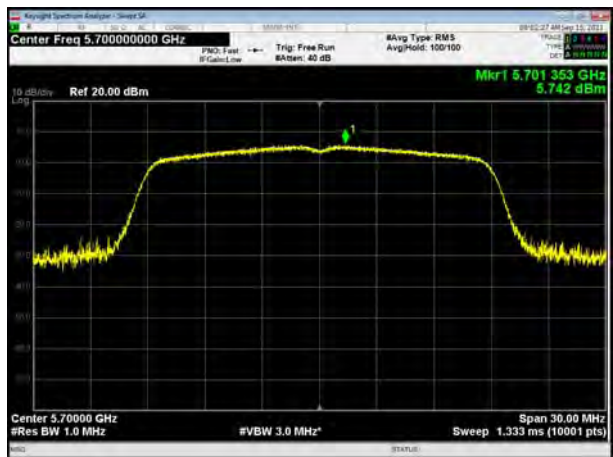

U-NII-2C, 802.11a, Channel No.: 144



U-NII-2C, 802.11n HT20, Channel No.: 144



U-NII-2C, 802.11n HT40, Channel No.: 102

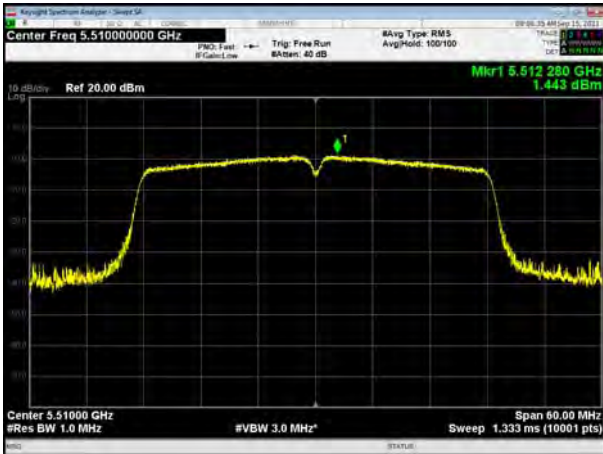

U-NII-2C, 802.11ac VHT20, Channel No.: 100

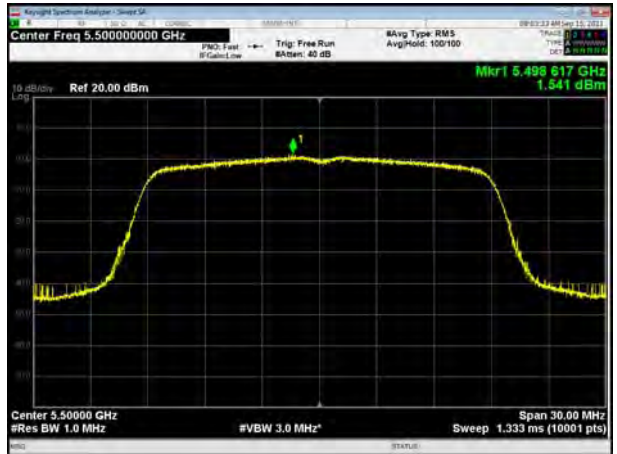

U-NII-2C, 802.11n HT40, Channel No.: 110



U-NII-2C, 802.11ac VHT20, Channel No.: 116

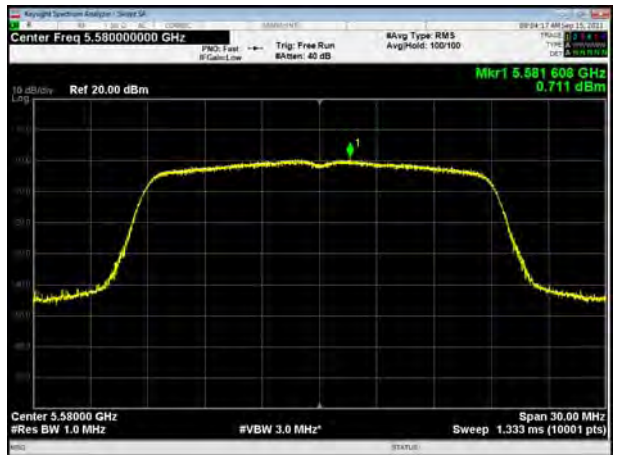

U-NII-2C, 802.11n HT40, Channel No.: 134

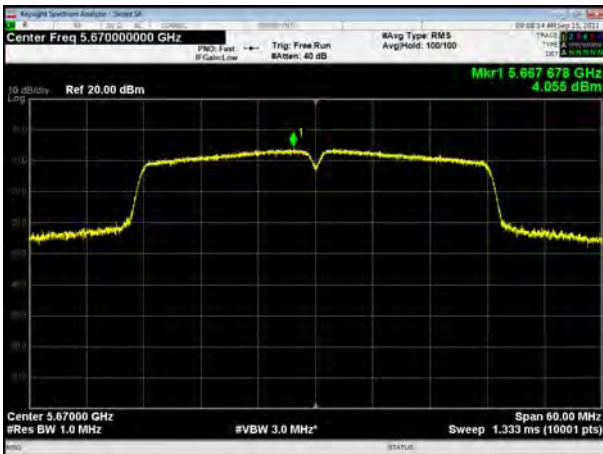

U-NII-2C, 802.11ac VHT20, Channel No.: 140

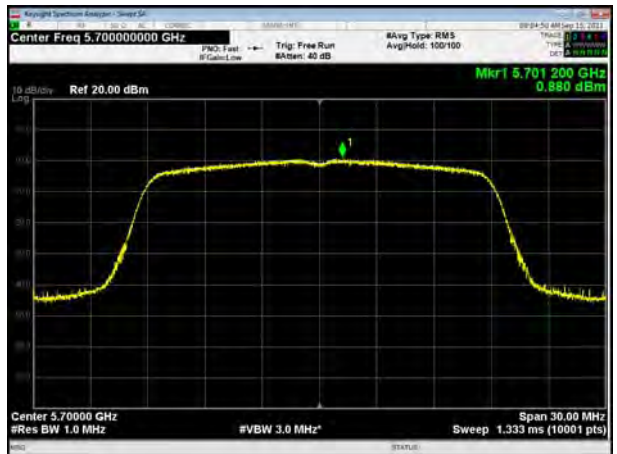

U-NII-2C, 802.11n HT40, Channel No.: 138



U-NII-2C, 802.11ac VHT20, Channel No.: 144

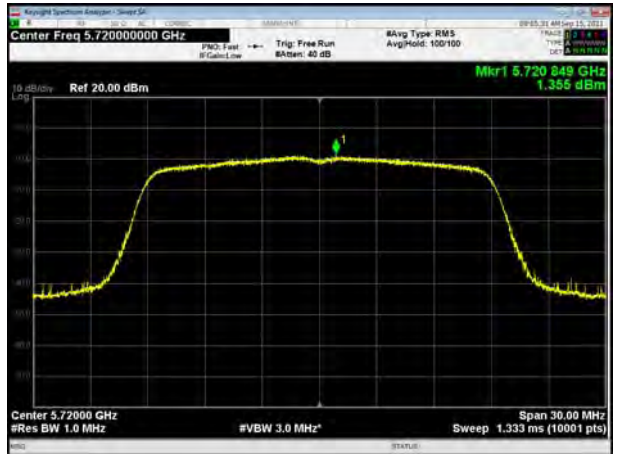

U-NII-2C, 802.11ac VHT40, Channel No.: 102

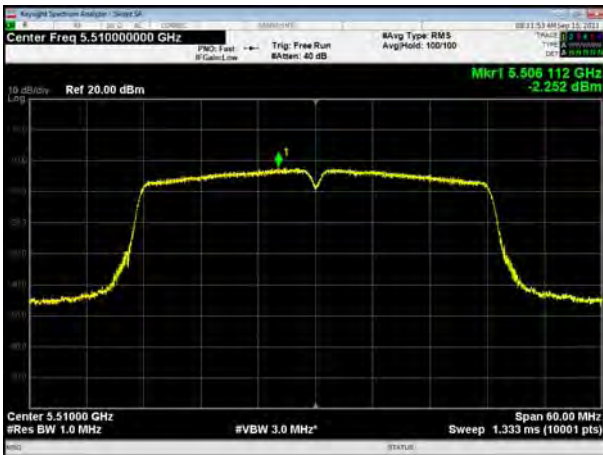

U-NII-2C, 802.11ac VHT40, Channel No.: 110

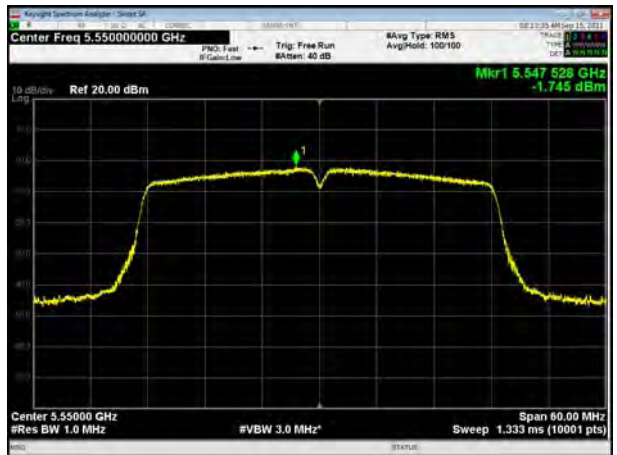

U-NII-2C, 802.11ac VHT40, Channel No.: 134

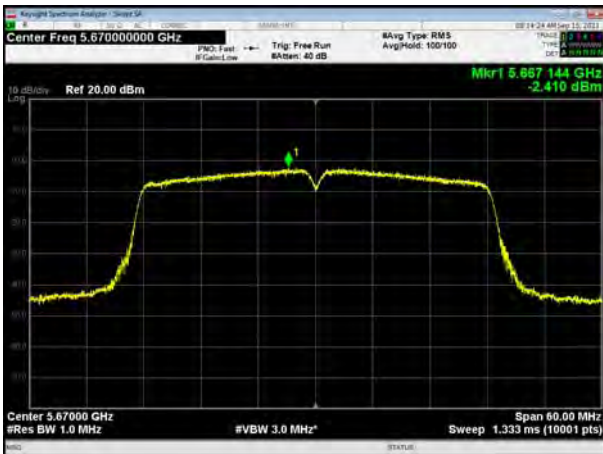

U-NII-2C, 802.11ac VHT40, Channel No.: 142

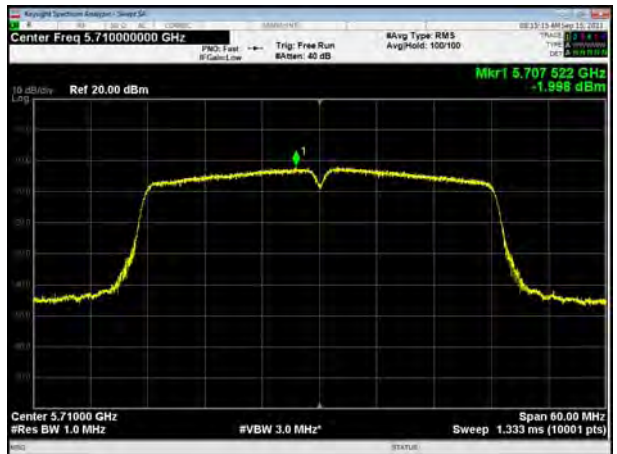

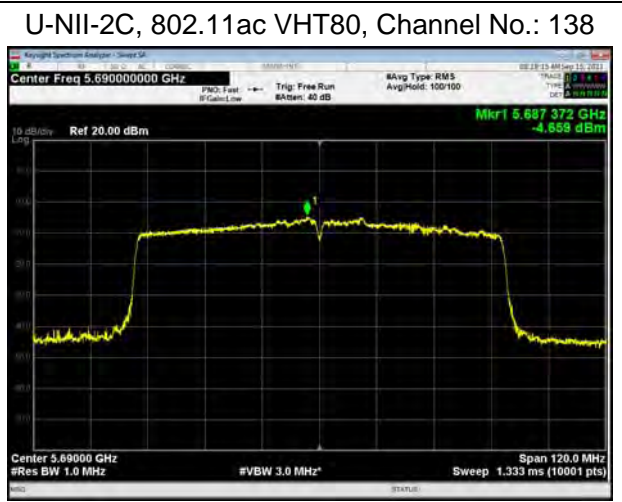

5.5. Unwanted Emission

Ambient condition

Temperature	Relative humidity	Pressure
23°C ~25°C	45%~50%	101.5kPa

Method of Measurement

The test set-up was made in accordance to the general provisions of ANSI C63.10. The Equipment Under Test (EUT) was set up on a non-conductive table in the semi-anechoic chamber. The test was performed at the distance of 3 m between the EUT and the receiving antenna. The radiated emissions measurements were made in a typical installation configuration.

Sweep the whole frequency band range from 9kHz to the 10th harmonic of the carrier, and the emissions less than 20 dB below the permissible value are reported.

During the test, the height of receive antenna shall be moved from 1 to 4 meters, and the antenna shall be performed under horizontal and vertical polarization. The turntable shall be rotated from 0 to 360 degrees for detecting the maximum of radiated spurious signal level. The measurements shall be repeated with orthogonal polarization of the test antenna. The data of cable loss and antenna factor has been calibrated in full testing frequency range before the testing.

Set the spectrum analyzer in the following:

9kHz~150 kHz

RBW=200Hz, VBW=1kHz/ Sweep=AUTO

150 kHz~30MHz

RBW=9KHz, VBW=30KHz,/ Sweep=AUTO

Below 1GHz

RBW=100kHz / VBW=300kHz / Sweep=AUTO

a) Peak emission levels are measured by setting the instrument as follows:

Above 1GHz

PEAK: RBW=1MHz VBW=3MHz/ Sweep=AUTO

b) Average emission levels are measured by setting the instrument as follows:

Above 1GHz

AVERAGE: RBW=1MHz / VBW=3MHz / Sweep=AUTO

c) Detector: The measurements employing a CISPR quasi-peak detector except for the frequency bands 9-90 kHz, 110-490 kHz and above 1000 MHz. Radiated emission limits in these three bands are based on measurements employing an average detector.

d) Averaging type = power (i.e., rms) (As an alternative, the detector and averaging type may be set for linear voltage averaging. Some instruments require linear display mode to use linear voltage averaging. Log or dB averaging shall not be used.)

e) Sweep time = auto.

f) Perform a trace average of at least 100 traces if the transmission is continuous. If the transmission is not continuous, then the number of traces shall be increased by a factor of $1 / D$, where D is the duty cycle. For example, with 50% duty cycle, at least 200 traces shall be averaged. (If a specific



emission is demonstrated to be continuous—i.e., 100% duty cycle—then rather than turning ON and OFF with the transmit cycle, at least 100 traces shall be averaged.)

g) If tests are performed with the EUT transmitting at a duty cycle less than 98%, then a correction factor shall be added to the measurement results prior to comparing with the emission limit, to compute the emission level that would have been measured had the test been performed at 100% duty cycle. The correction factor is computed as follows:

1) If power averaging (rms) mode was used in the preceding step e), then the correction factor is $[10 \log (1 / D)]$, where D is the duty cycle. For example, if the transmit duty cycle was 50%, then 3 dB shall be added to the measured emission levels.

2) If linear voltage averaging mode was used in the preceding step e), then the correction factor is $[20 \log (1 / D)]$, where D is the duty cycle. For example, if the transmit duty cycle was 50%, then 6 dB shall be added to the measured emission levels.

3) If a specific emission is demonstrated to be continuous (100% duty cycle) rather than turning ON and OFF with the transmit cycle, then no duty cycle correction is required for that emission.

Reduce the video bandwidth until no significant variations in the displayed signal are observed in subsequent traces, provided the video bandwidth is no less than 1 Hz. For regulatory requirements that specify averaging only over the transmit duration (e.g., digital transmission system [DTS] and Unlicensed National Information Infrastructure [U-NII]), the video bandwidth shall be greater than $[1 / (\text{minimum transmitter on time})]$ and no less than 1 Hz.

The field strength of spurious emission was measured in the following position: EUT stand-up position (Z axis), lie-down position (X, Y axis). The worst emission was found in stand-up position (Z axis) and the loop antenna is vertical, others antenna are vertical and horizontal.

The test is in transmitting mode.

9KHz~~~30MHz

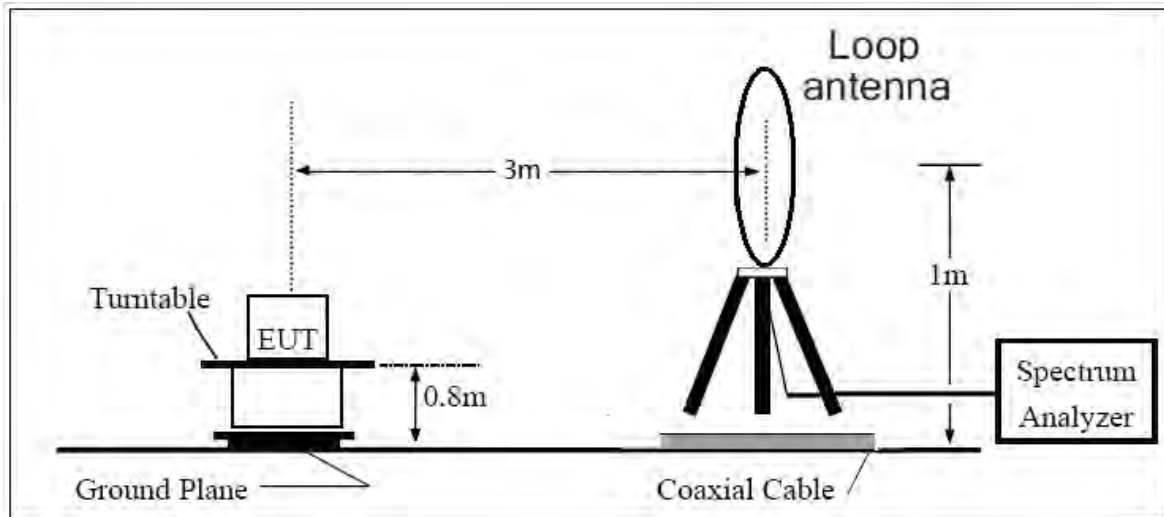

30MHz~~~ 1GHz

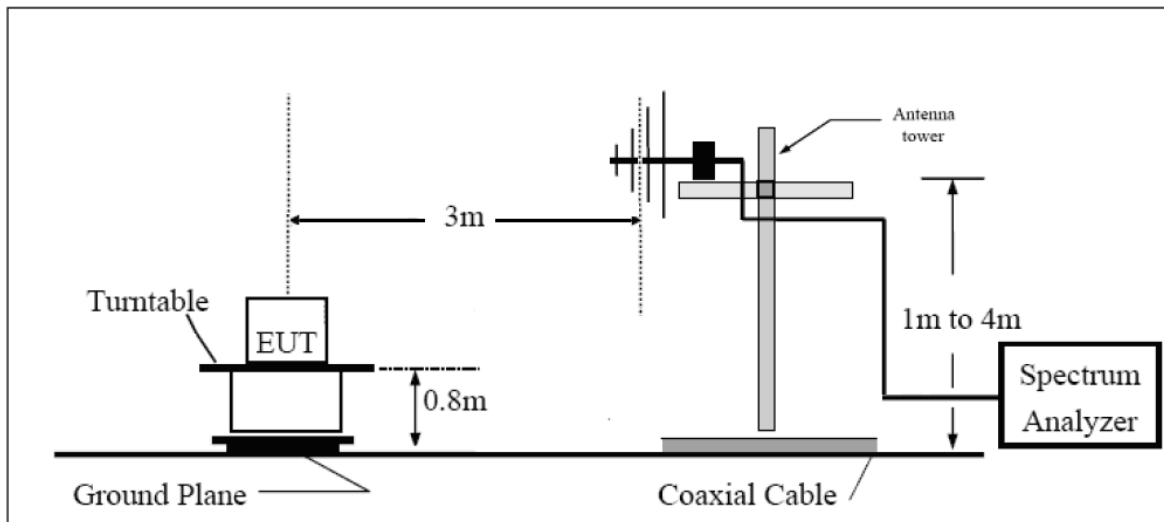

Above 1GHz

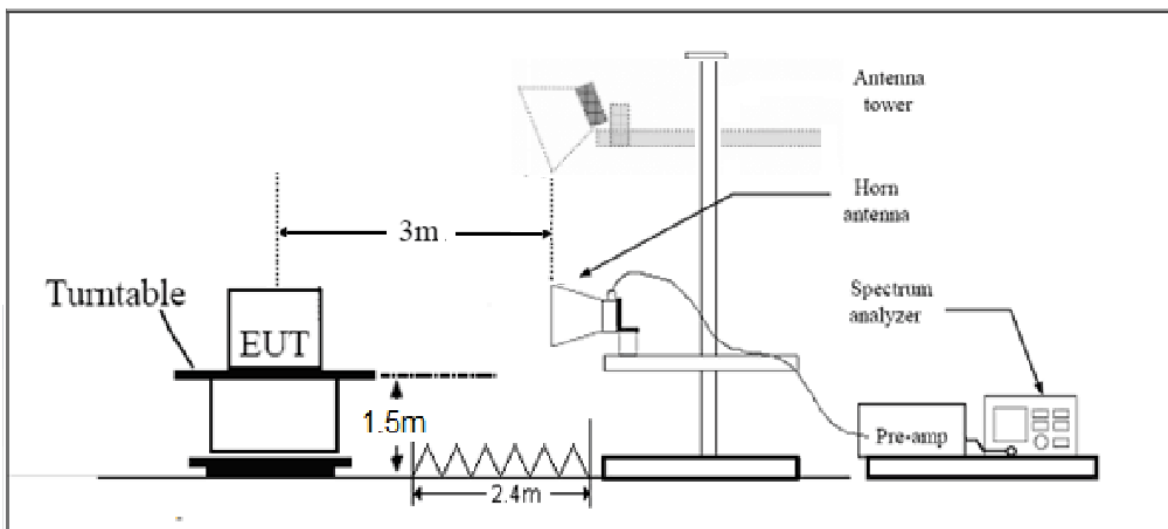

Note: Area side:2.4mX3.6m

**Limits**

- (1) For transmitters operating in the 5725-5850 MHz band: All emissions shall be limited to a level of -27 dBm/MHz at 75 MHz or more above or below the band edge increasing linearly to 10 dBm/MHz at 25 MHz above or below the band edge, and from 25 MHz above or below the band edge increasing linearly to a level of 15.6 dBm/MHz at 5 MHz above or below the band edge, and from 5 MHz above or below the band edge increasing linearly to a level of 27 dBm/MHz at the band edge.
- (2) For transmitters operating in the 5.15-5.25 GHz band: All emissions outside of the 5.15-5.35 GHz band shall not exceed an e.i.r.p. of -27 dBm/MHz(68.2dBμV/m).
- (3) For transmitters operating in the 5.25-5.35 GHz band: All emissions outside of the 5.15-5.35 GHz band shall not exceed an e.i.r.p. of -27 dBm/MHz(68.2dBμV/m).
- (4) For transmitters operating in the 5.47-5.725 GHz band: All emissions outside of the 5.47-5.725 GHz band shall not exceed an e.i.r.p. of -27 dBm/MHz(68.2dBμV/m).

Note: the following formula is used to convert the EIRP to field strength

§1、 $E[\text{dB}\mu\text{V}/\text{m}] = \text{EIRP}[\text{dBm}] - 20 \log(d[\text{meters}]) + 104.77$, where E = field strength and

d = distance at which field strength limit is specified in the rules;

§2、 $E[\text{dB}\mu\text{V}/\text{m}] = \text{EIRP}[\text{dBm}] + 95.2$, for d = 3 meters

- (5) Unwanted spurious emissions fallen in restricted bands per FCC Part15.205 shall comply with the general field strength limits set forth in § 15.209 as below table.

Frequency of emission (MHz)	Field strength(uV/m)	Field strength(dBuV/m)
0.009–0.490	2400/F(kHz)	/
0.490–1.705	24000/F(kHz)	/
1.705–30.0	30	/
30-88	100	40
88-216	150	43.5
216-960	200	46
Above960	500	54



MHz	MHz	MHz	GHz
0.090 - 0.110	16.42 - 16.423	399.9 - 410	4.5 - 5.15
0.495 - 0.505	16.69475 - 16.69525	608 - 614	5.35 - 5.46
2.1735 - 2.1905	16.80425 - 16.80475	960 - 1240	7.25 - 7.75
4.125 - 4.128	25.5 - 25.67	1300 - 1427	8.025 - 8.5
4.17725 - 4.17775	37.5 - 38.25	1435 - 1626.5	9.0 - 9.2
4.20725 - 4.20775	73 - 74.6	1645.5 - 1646.5	9.3 - 9.5
6.215 - 6.218	74.8 - 75.2	1660 - 1710	10.6 - 12.7
6.26775 - 6.26825	108 - 121.94	1718.8 - 1722.2	13.25 - 13.4
6.31175 - 6.31225	123 - 138	2200 - 2300	14.47 - 14.5
8.291 - 8.294	149.9 - 150.05	2310 - 2390	15.35 - 16.2
8.362 - 8.366	156.52475 - 156.52525	2483.5 - 2500	17.7 - 21.4
8.37625 - 8.38675	156.7 - 156.9	2690 - 2900	22.01 - 23.12
8.41425 - 8.41475	162.0125 - 167.17	3260 - 3267	23.6 - 24.0
12.29 - 12.293	167.72 - 173.2	3332 - 3339	31.2 - 31.8
12.51975 - 12.52025	240 - 285	3345.8 - 3358	36.43 - 36.5
12.57675 - 12.57725	322 - 335.4	3600 - 4400	(²)
13.36 - 13.41			

Measurement Uncertainty

The assessed measurement uncertainty to ensure 95% confidence level for the normal distribution is with the coverage factor $k = 1.96$.

Frequency	Uncertainty
9KHz-30MHz	3.55 dB
30MHz-200MHz	4.17 dB
200MHz-1GHz	4.84 dB
1-18GHz	4.35 dB
18-26.5GHz	5.90 dB
26.5GHz~40GHz	5.92 dB



Test Results:

The modulation and bandwidth are similar for 802.11n mode for 20MHz/40MHz and 802.11ac mode for V20MHz/V40MHz, therefore investigated worst case to representative mode in test report.

The signal beyond the limit is carrier.

A font (dB 磁/m) in the test plot =(dB μ V/m)

A font (dB V/) in the test plot =(dB μ V/m)

U-NII-1

802.11a-Channel 36: Peak + Average

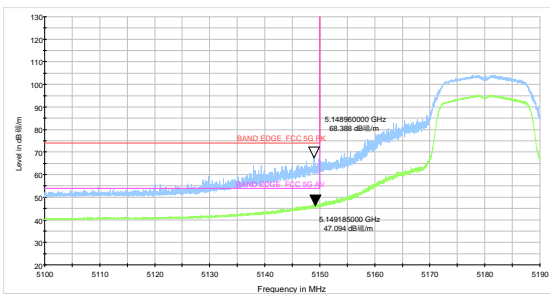

802.11a-Channel 48: Peak + Average

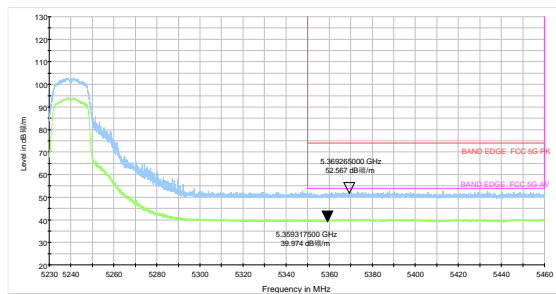

802.11n HT20-Channel 36: Peak + Average

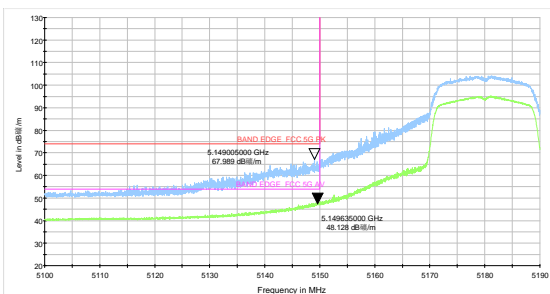

802.11n HT20-Channel 48: Peak + Average

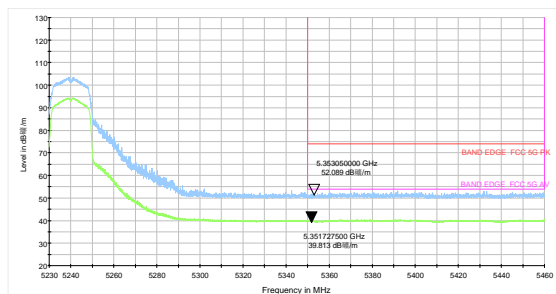

802.11n HT40-Channel 38: Peak + Average

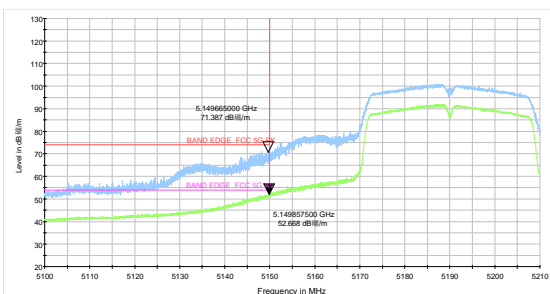

802.11n HT40-Channel 46: Peak + Average

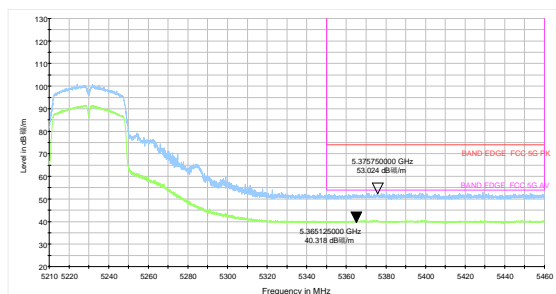

802.11ac VHT20 -Channel 36: Peak + Average

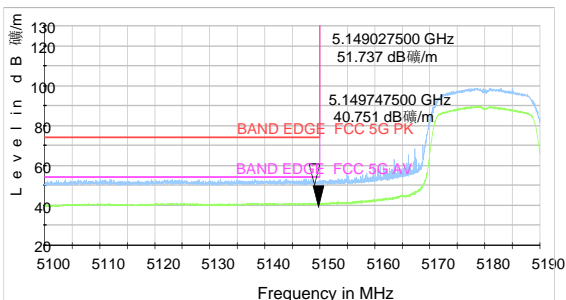

802.11ac VHT20 -Channel 48: Peak + Average

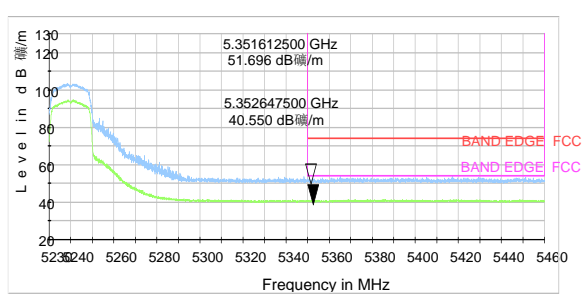



802.11ac VHT40-Channel 38: Peak + Average

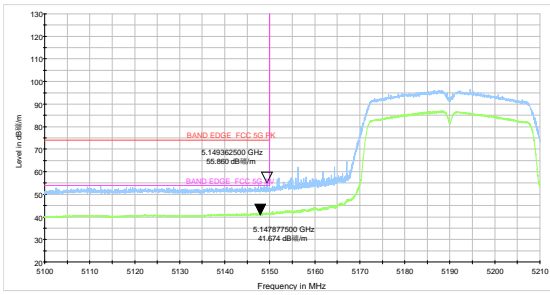

802.11ac VHT40-Channel 46: Peak + Average

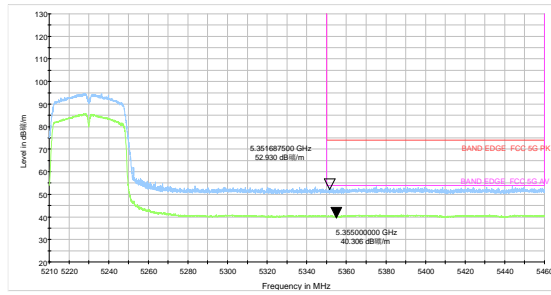

802.11ac VHT80 -Channel 42: Peak + Average

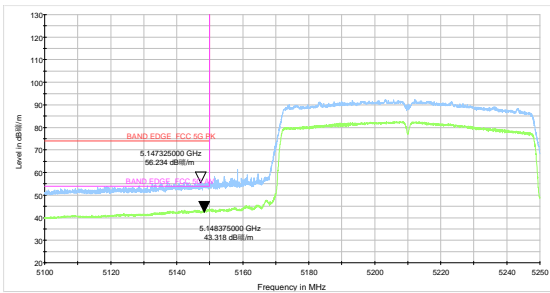



U-NII-2A

802.11a-Channel 52: Peak + Average

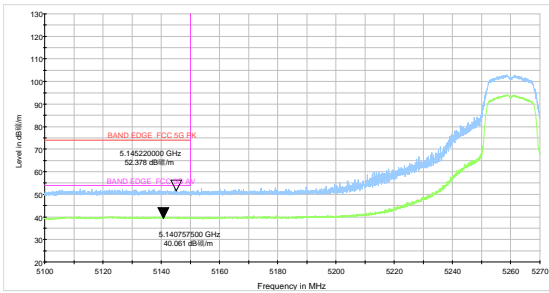

802.11a-Channel 64: Peak + Average

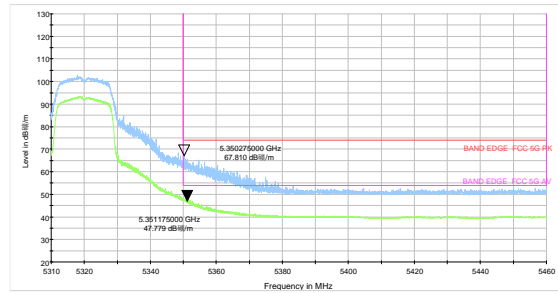

802.11n HT20-Channel 52: Peak + Average

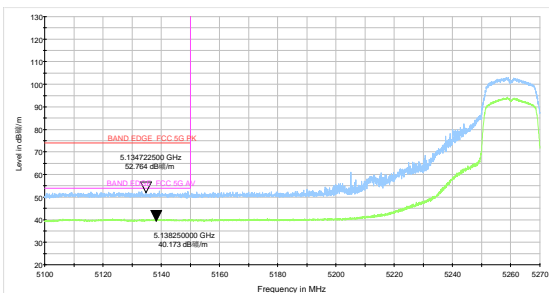

802.11n HT20-Channel 64: Peak + Average

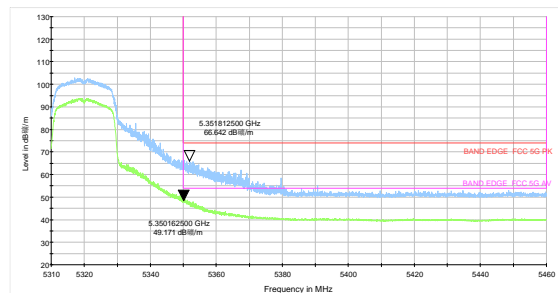

802.11n HT40-Channel 54: Peak + Average

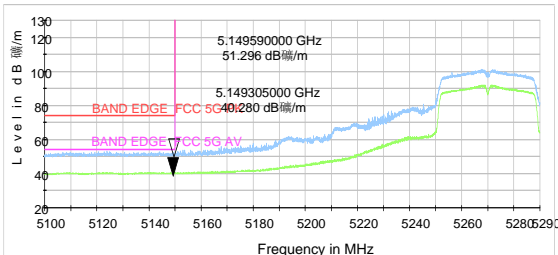

802.11n HT40-Channel 62: Peak + Average

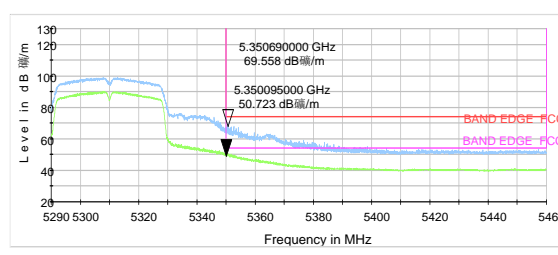

802.11ac VHT20 -Channel 52: Peak + Average

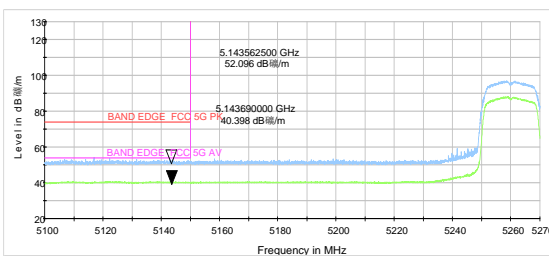

802.11ac VHT20 -Channel 64: Peak + Average

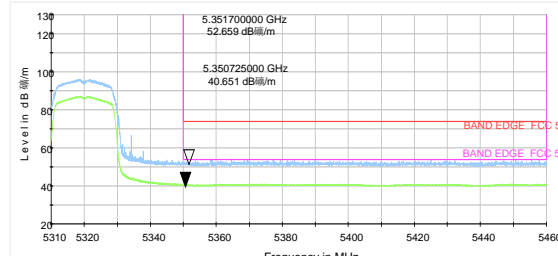

802.11ac VHT40-Channel 54: Peak + Average

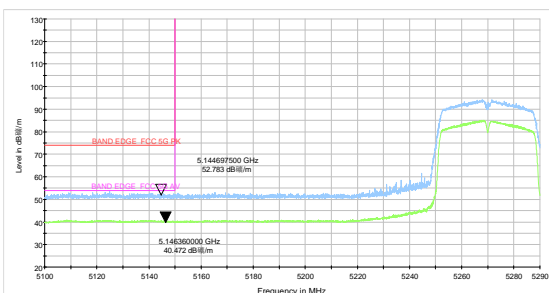

802.11ac VHT40-Channel 62: Peak + Average

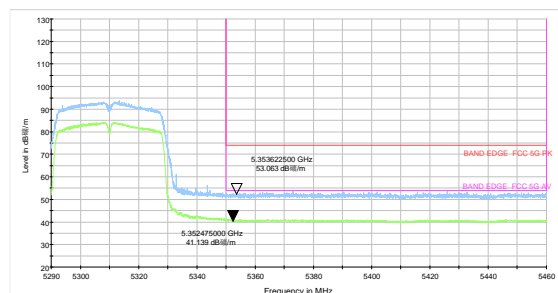



802.11ac VHT80 –Channel 58: Peak + Average

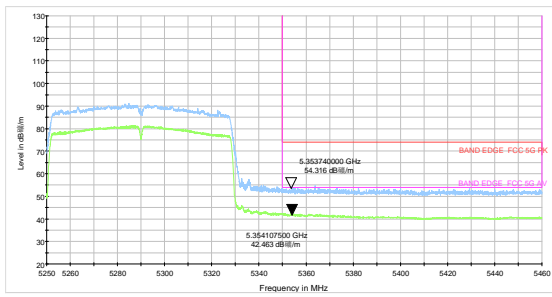



U-NII-2C

802.11a-Channel 100: Peak + Average

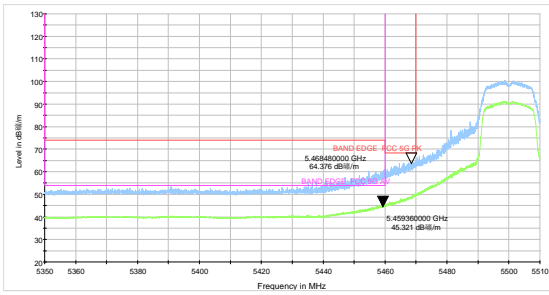

802.11n HT20-Channel 100: Peak + Average

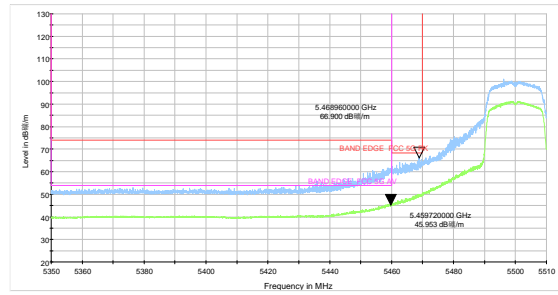

802.11a-Channel 140: Peak

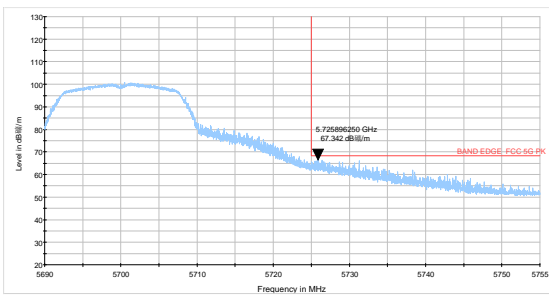

802.11n HT20-Channel 140: Peak

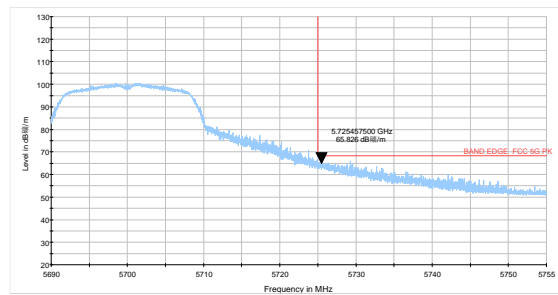

802.11a-Channel 144: Peak

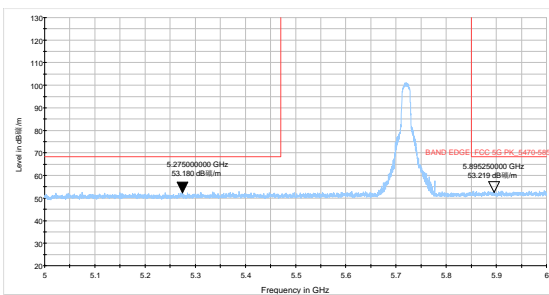

802.11n HT20-Channel 144: Peak

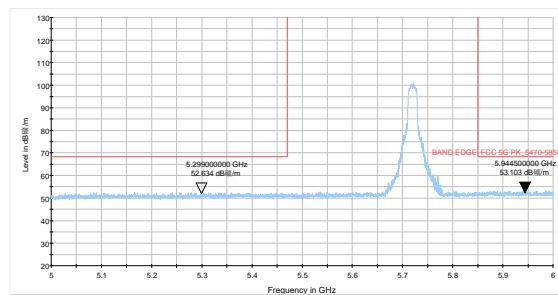



802.11n HT40-Channel 102: Peak + Average

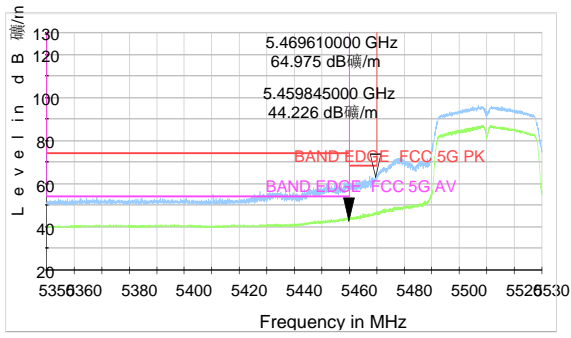

802.11ac VHT20 -Channel 100: Peak + Average

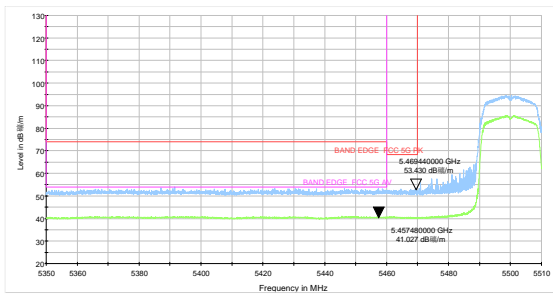

802.11n HT40-Channel 134: Peak

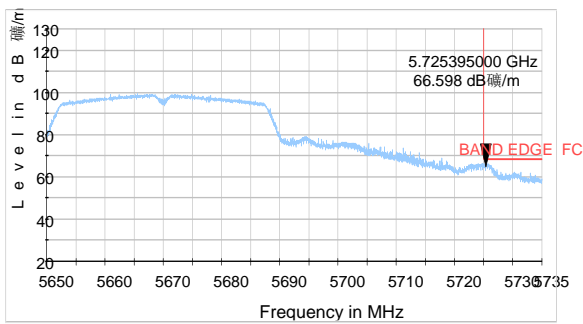

802.11ac VHT20 -Channel 140: Peak

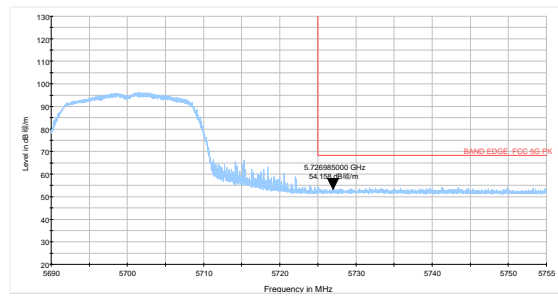

802.11n HT40-Channel 142: Peak

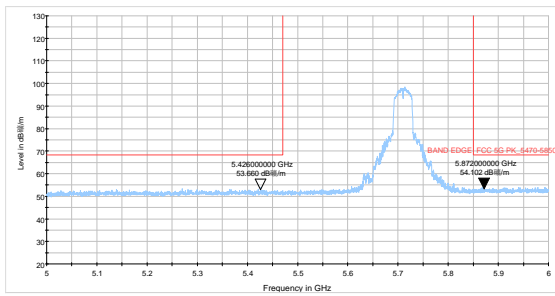

802.11ac VHT20 -Channel 144: Peak

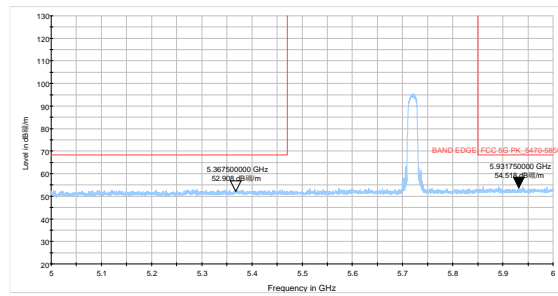

802.11ac VHT40 -Channel 102: Peak + Average

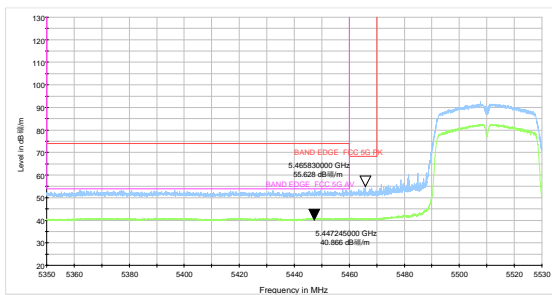

802.11ac VHT80 -Channel 106: Peak + Average

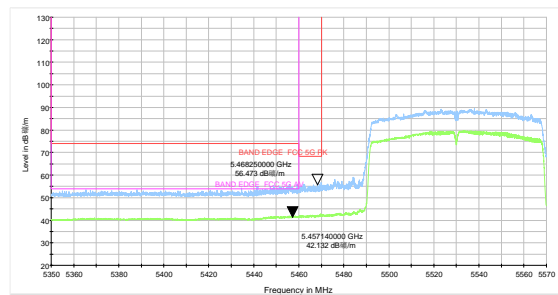



802.11ac VHT40 -Channel 134: Peak

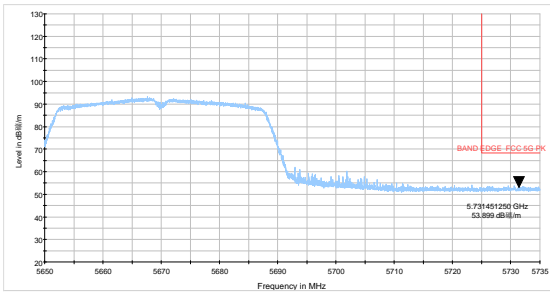

802.11ac VHT80- Channel 122: Peak

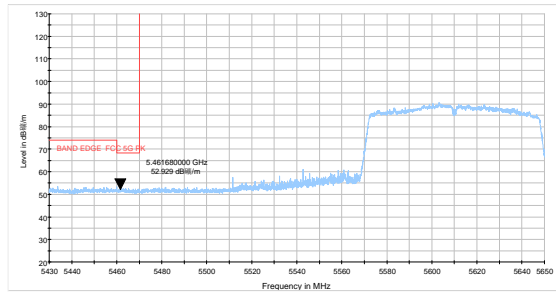

802.11ac VHT40 -Channel 142 Peak

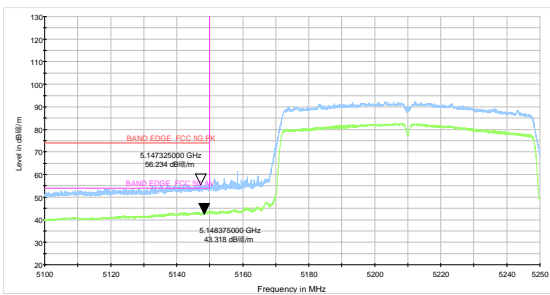

802.11ac VHT80- Channel 138: Peak

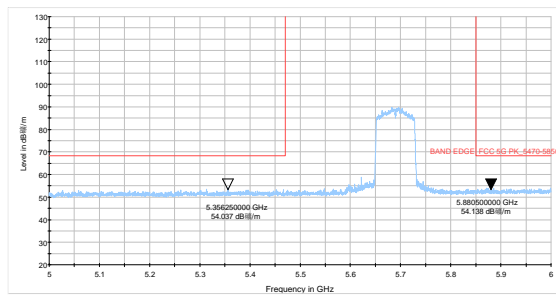



Result of RE

Test result

Sweep the whole frequency band through the range from 9kHz to the 10th harmonic of the carrier, the Emissions in the frequency band 9kHz-30MHz and 26.5GHz-40GHz are more than 20dB below the limit are not reported.

During the test, the Radiates Emission from 30MHz to 1GHz was performed in all modes with all channels, 802.11ac (VHT20), Channel 52 are selected as the worst condition. The test data of the worst-case condition was recorded in this report.

Continuous TX mode:

FCC RE 9K-90KHz AV

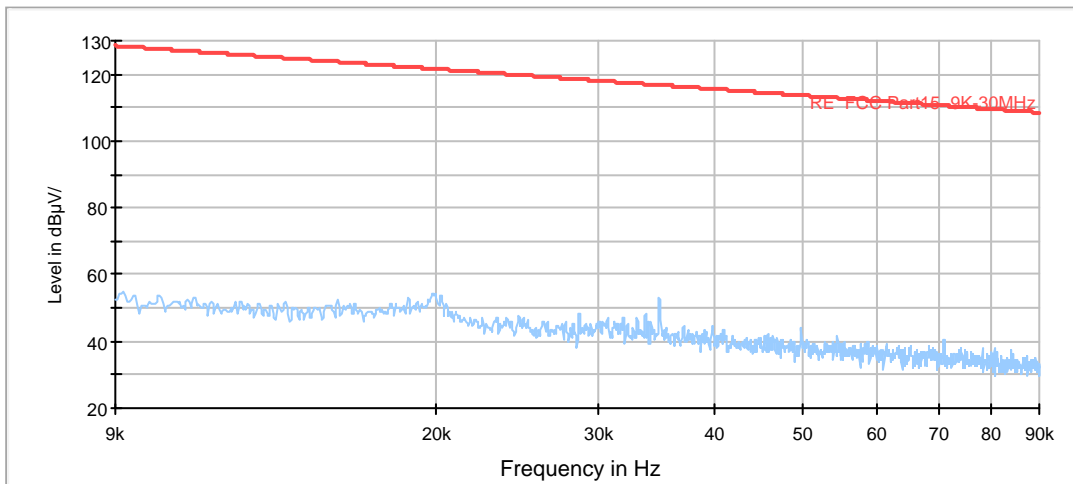

Radiates Emission from 9KHz to 90KHz

FCC RE 90K-110KHz QP

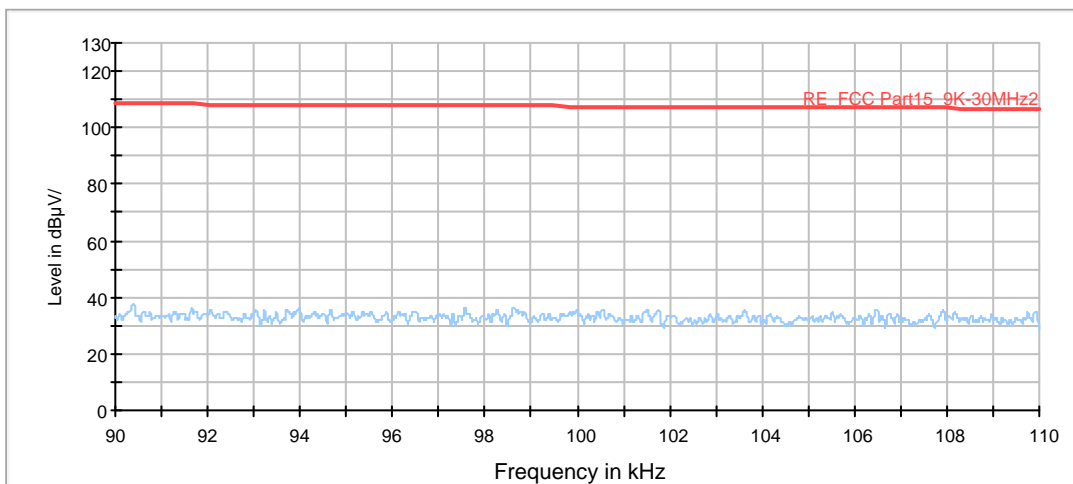

Radiates Emission from 90KHz to 110KHz



FCC RE 110K-490KHz AV

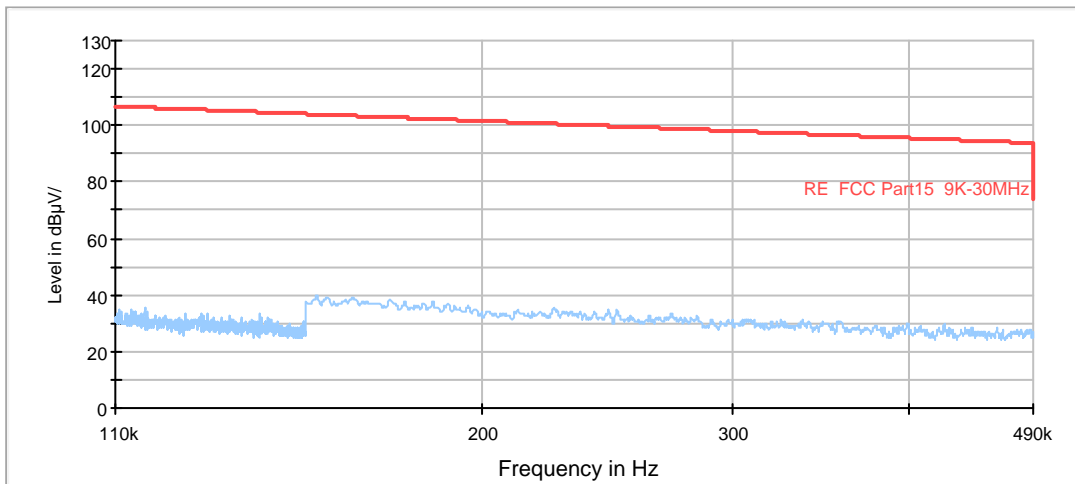

Radiates Emission from 110KHz to 490KHz

FCC RE 490K-30MHz QP

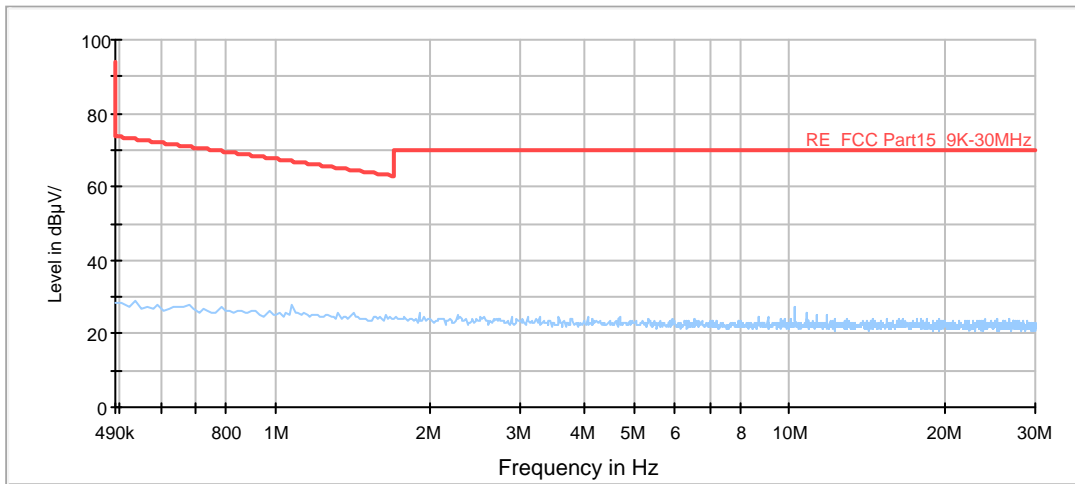

Radiates Emission from 490KHz to 30MHz

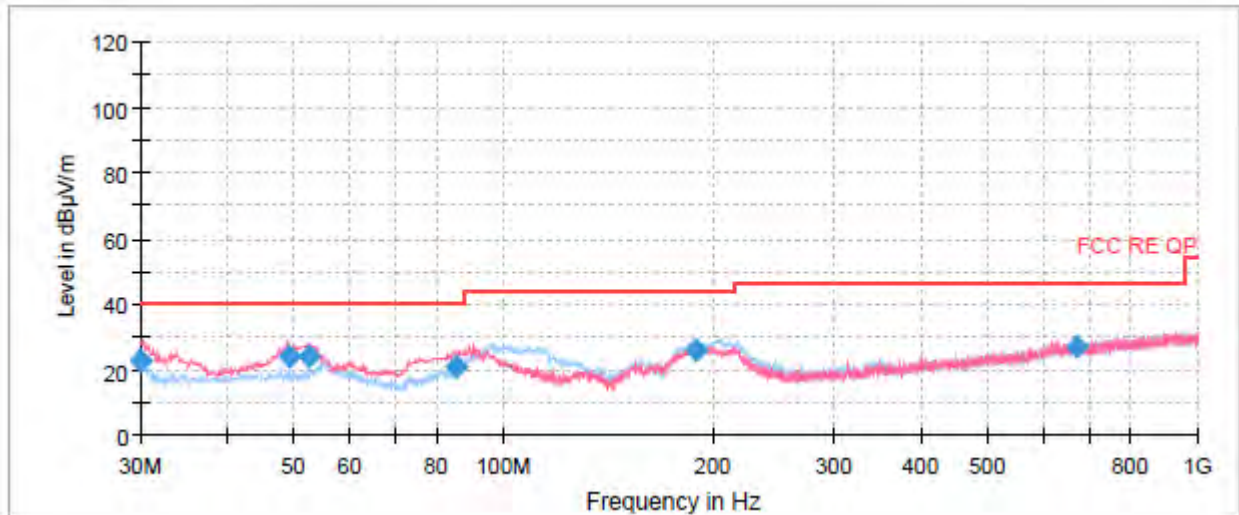

Radiates Emission from 30MHz to 1GHz

Frequency (MHz)	Quasi-Peak (dBuV/m)	Height (cm)	Polarization	Azimuth (deg)	Correct Factor (dB)	Margin (dB)	Limit (dBuV/m)
30.000000	22.58	199.0	V	0.0	12.2	17.42	40.00
49.273750	24.25	105.0	V	148.0	14.1	15.75	40.00
52.506250	24.29	105.0	V	194.0	13.5	15.71	40.00
85.527500	21.05	125.0	V	333.0	9.5	18.95	40.00
189.363750	25.74	125.0	H	92.0	12.3	17.76	43.50
671.173750	27.07	225.0	V	120.0	22.0	18.93	46.00

Remark: 1. Correction Factor = Antenna factor+ Insertion loss(cable loss+amplifier gain)

2. Margin = Limit – Quasi-Peak

802.11a CH36

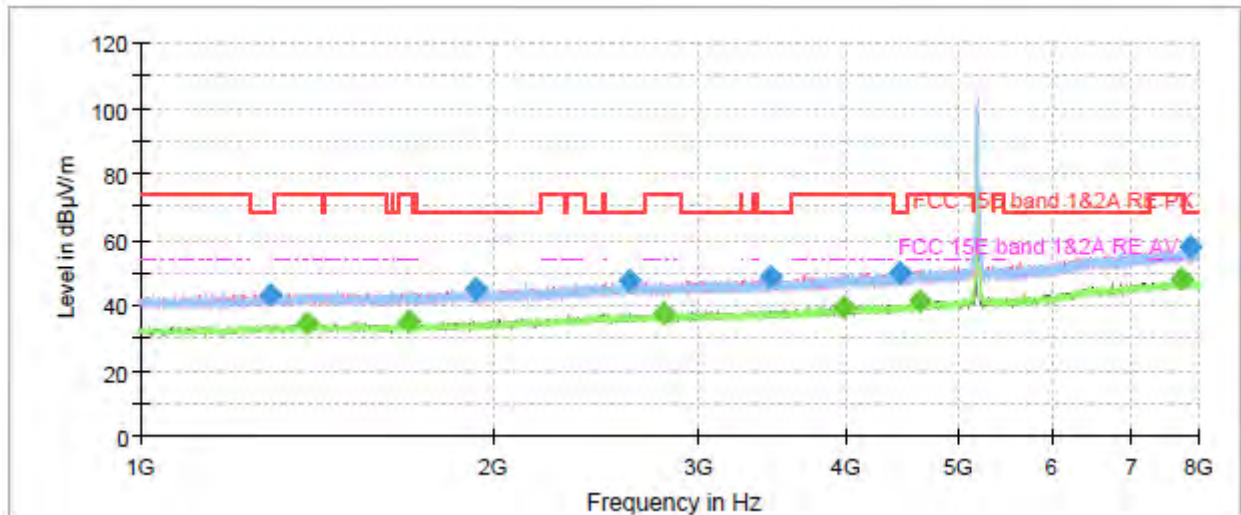

Radiates Emission from 1GHz to 8GHz
 Note: The signal beyond the limit is carrier.

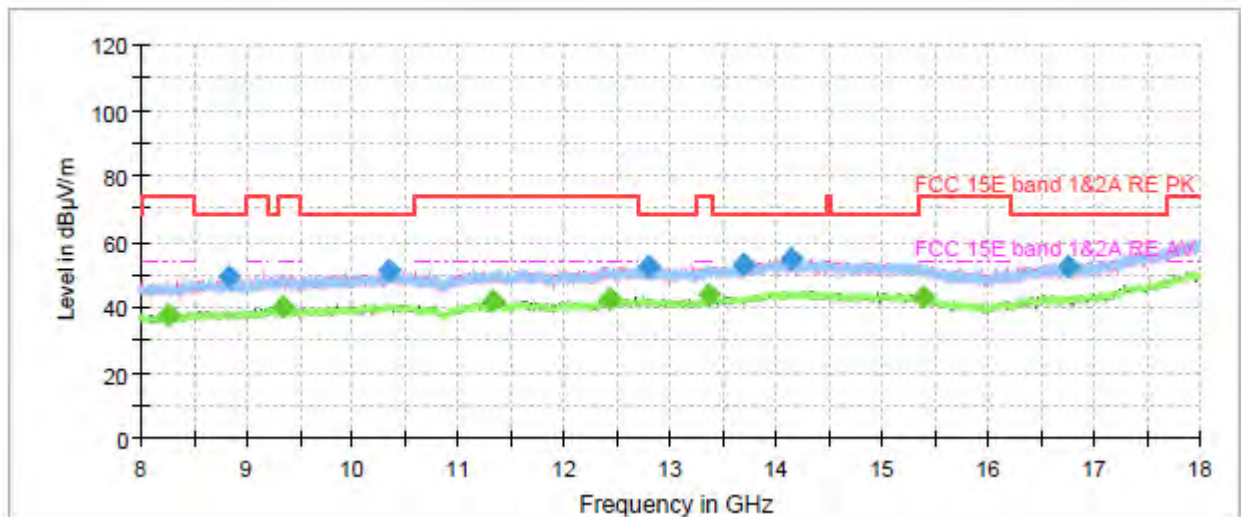

Radiates Emission from 8GHz to 18GHz



Frequency (MHz)	Peak (dBuV/m)	Average (dBuV/m)	Limit (dBuV/m)	Margin (dB)	Height (cm)	Polarization	Azimuth (deg)	Correct Factor (dB)
1291.433333	43.26	---	68.20	24.94	100.0	V	115.0	-9.9
1385.466667	---	34.40	54.00	19.60	200.0	V	161.0	-9.4
1692.066667	---	34.82	54.00	19.18	200.0	H	2.0	-8.9
1930.533333	44.75	---	68.20	23.45	100.0	H	1.0	-8.2
2613.500000	47.54	---	68.20	20.66	200.0	V	51.0	-6.1
2798.533333	---	37.37	54.00	16.63	200.0	V	217.0	-6.0
3450.233333	48.55	---	68.20	19.65	200.0	H	230.0	-4.9
3986.200000	---	39.64	54.00	14.36	100.0	V	230.0	-3.0
4449.133333	50.14	---	68.20	18.06	200.0	H	359.0	-1.6
4617.600000	---	41.15	54.00	12.85	200.0	V	175.0	-0.7
7744.033333	---	47.90	54.00	6.10	100.0	V	357.0	7.0
7857.200000	57.92	---	68.20	10.28	100.0	H	246.0	7.1

Remark: 1. Correction Factor = Antenna factor+ Insertion loss (cable loss + amplifier gain)

802.11a CH40

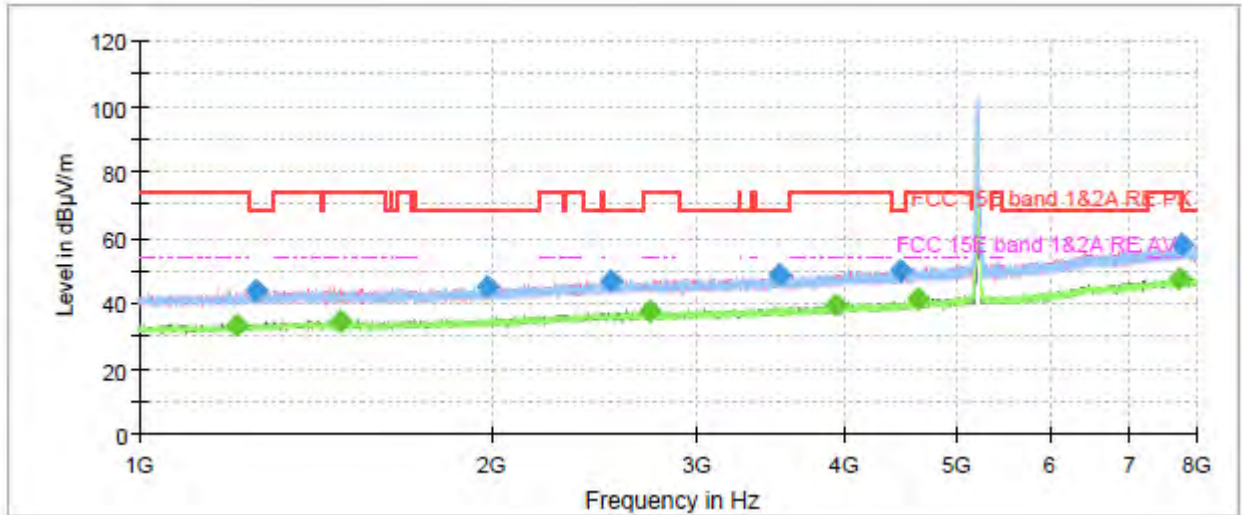

Radiates Emission from 1GHz to 8GHz
 Note: The signal beyond the limit is carrier.

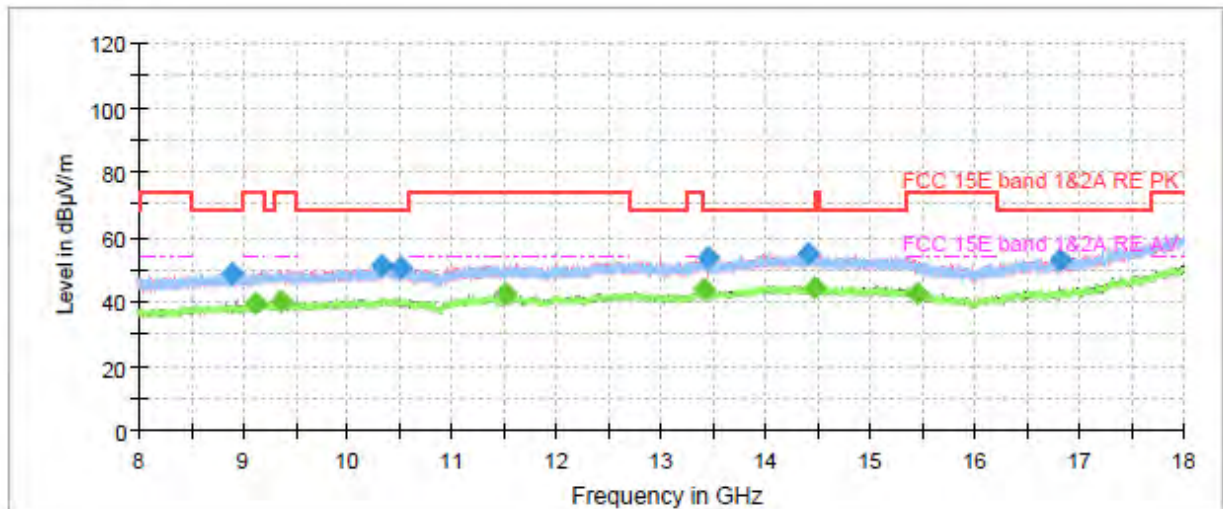

Radiates Emission from 8GHz to 18GHz



Frequency (MHz)	Peak (dBuV/m)	Average (dBuV/m)	Limit (dBuV/m)	Margin (dB)	Height (cm)	Polarization	Azimuth (deg)	Correct Factor (dB)
1211.400000	---	33.46	54.00	20.54	200.0	V	9.0	-10.6
1256.666667	43.64	---	68.20	24.56	200.0	H	218.0	-10.2
1486.033333	---	34.64	54.00	19.36	100.0	V	343.0	-9.2
1985.833333	44.65	---	68.20	23.55	200.0	V	274.0	-8.0
2527.166667	46.96	---	68.20	21.24	200.0	H	134.0	-6.3
2731.566667	---	37.42	54.00	16.58	200.0	V	1.0	-6.1
3518.366667	48.75	---	68.20	19.45	200.0	H	351.0	-4.7
3938.600000	---	39.58	54.00	14.42	100.0	H	15.0	-3.3
4458.700000	49.71	---	68.20	18.49	100.0	H	147.0	-1.5
4620.400000	---	40.98	54.00	13.02	100.0	V	356.0	-0.7
7737.733333	---	47.63	54.00	6.37	200.0	V	94.0	7.0
7773.900000	57.75	---	68.20	10.45	200.0	H	355.0	7.0

Remark: 1. Correction Factor = Antenna factor+ Insertion loss (cable loss + amplifier gain)

802.11a CH48

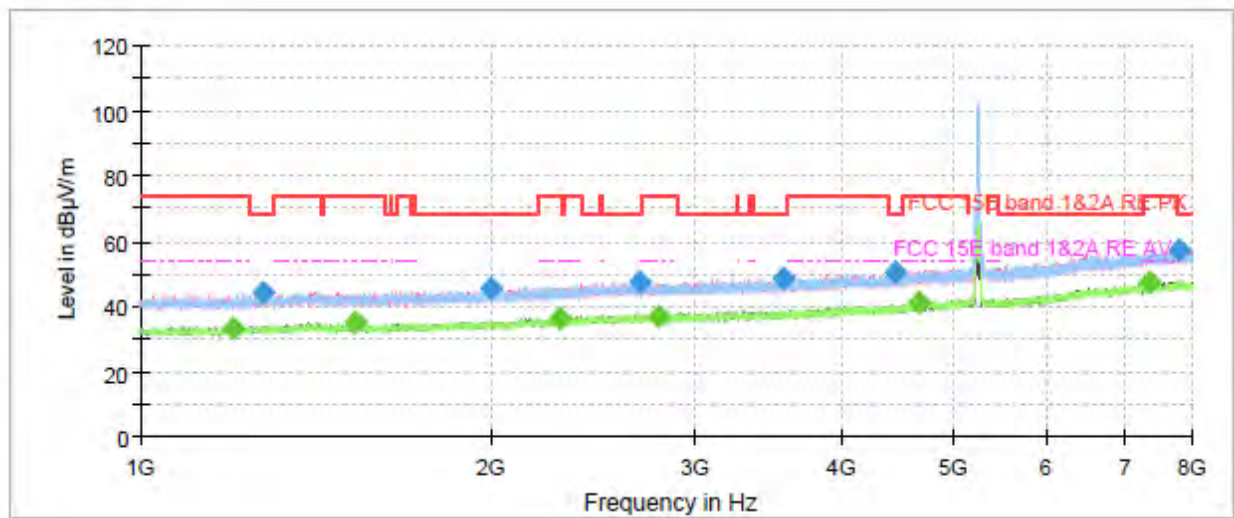

Radiates Emission from 1GHz to 8GHz
 Note: The signal beyond the limit is carrier.

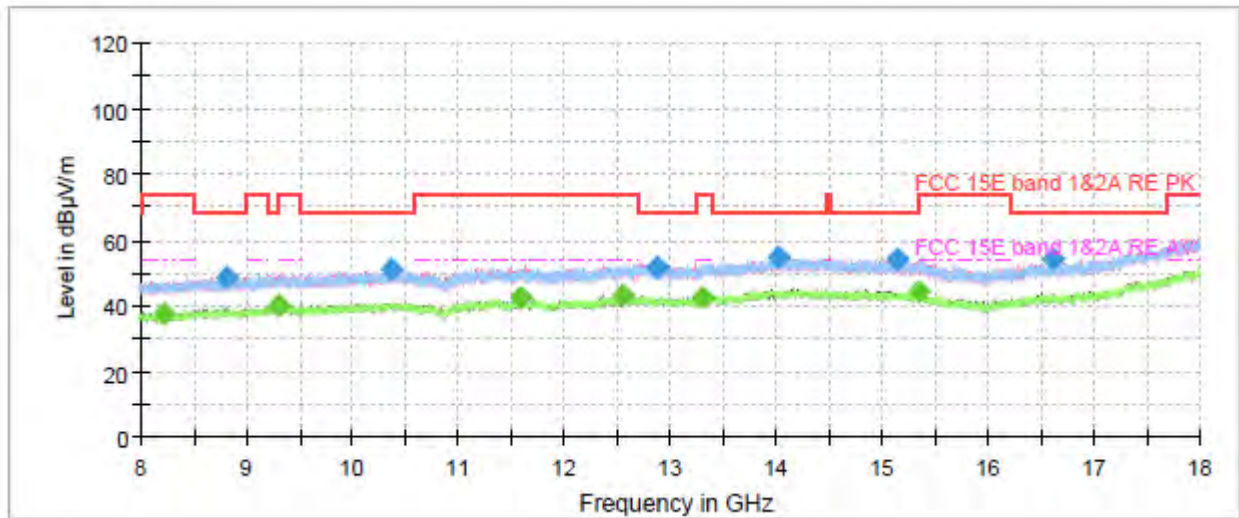

Radiates Emission from 8GHz to 18GHz



Frequency (MHz)	Peak (dBuV/m)	Average (dBuV/m)	Limit (dBuV/m)	Margin (dB)	Height (cm)	Polarization	Azimuth (deg)	Correct Factor (dB)
1201.366667	---	33.22	54.00	20.78	200.0	V	216.0	-10.7
1272.766667	44.44	---	68.20	23.76	200.0	H	158.0	-10.1
1527.566667	---	34.90	54.00	19.10	100.0	H	89.0	-9.1
1999.133333	45.43	---	68.20	22.77	100.0	V	332.0	-7.9
2286.833333	---	36.38	54.00	17.62	100.0	V	356.0	-6.9
2685.133333	47.18	---	68.20	21.02	200.0	V	0.0	-6.0
2781.500000	---	37.14	54.00	16.86	100.0	V	307.0	-6.1
3567.133333	48.50	---	68.20	19.70	200.0	H	359.0	-4.6
4444.700000	50.36	---	68.20	17.84	200.0	H	357.0	-1.6
4667.533333	---	41.33	54.00	12.67	100.0	V	143.0	-0.5
7352.966667	---	47.49	54.00	6.51	100.0	H	333.0	6.6
7792.566667	57.27	---	68.20	10.93	200.0	H	226.0	7.0

Remark: 1. Correction Factor = Antenna factor+ Insertion loss (cable loss + amplifier gain)

802.11a CH52

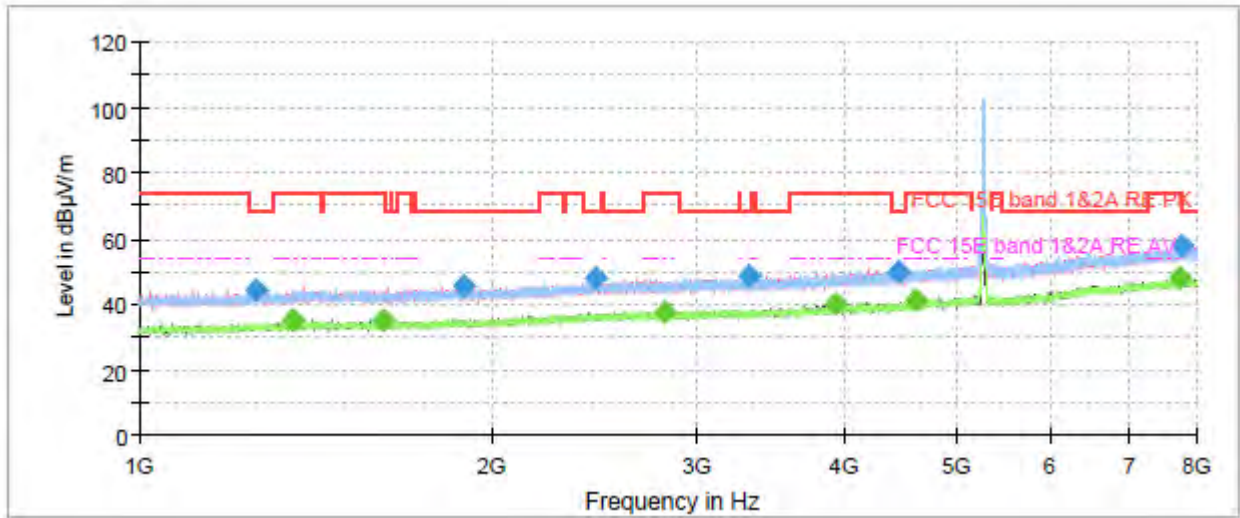

Radiates Emission from 1GHz to 8GHz
 Note: The signal beyond the limit is carrier.

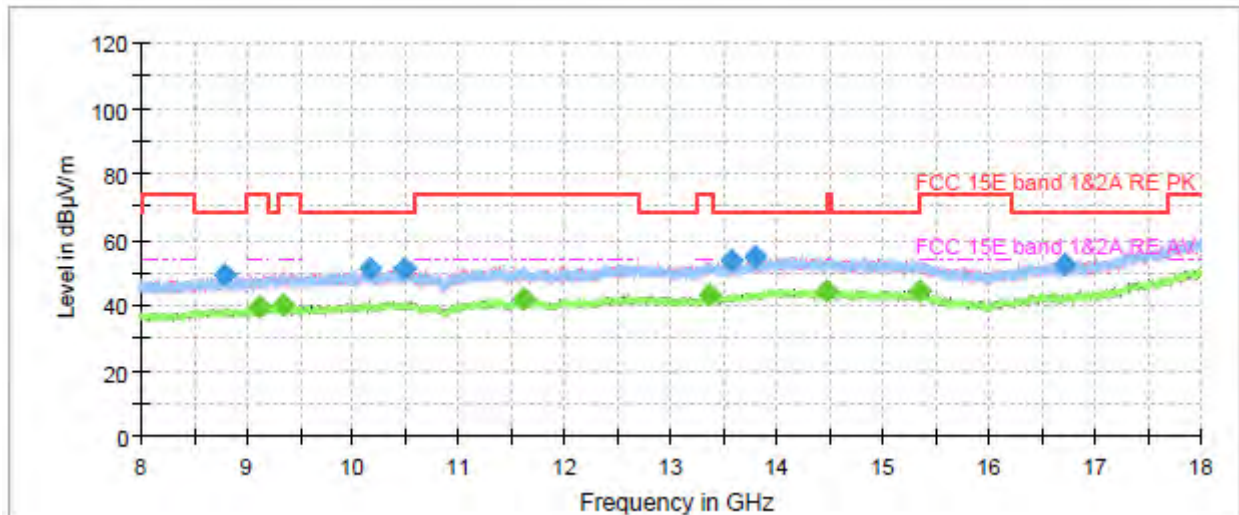

Radiates Emission from 8GHz to 18GHz



Frequency (MHz)	Peak (dBuV/m)	Average (dBuV/m)	Limit (dBuV/m)	Margin (dB)	Height (cm)	Polarization	Azimuth (deg)	Correct Factor (dB)
1258.533333	44.12	---	68.20	24.08	200.0	V	117.0	-10.2
1354.666667	---	34.80	54.00	19.20	100.0	H	155.0	-9.5
1618.100000	---	34.80	54.00	19.20	100.0	H	22.0	-9.1
1894.133333	45.74	---	68.20	22.46	200.0	V	349.0	-8.4
2448.300000	47.73	---	68.20	20.47	100.0	H	86.0	-6.4
2807.166667	---	37.62	54.00	16.38	200.0	H	332.0	-6.0
3317.933333	48.54	---	68.20	19.66	100.0	H	155.0	-5.2
3932.766667	---	39.77	54.00	14.23	100.0	V	130.0	-3.3
4448.666667	49.64	---	68.20	18.56	200.0	H	356.0	-1.6
4602.200000	---	40.97	54.00	13.03	100.0	V	157.0	-0.8
7746.133333	---	47.71	54.00	6.29	100.0	V	254.0	7.0
7766.200000	57.61	---	68.20	10.59	200.0	H	226.0	7.0

Remark: 1. Correction Factor = Antenna factor+ Insertion loss (cable loss + amplifier gain)

802.11a CH60

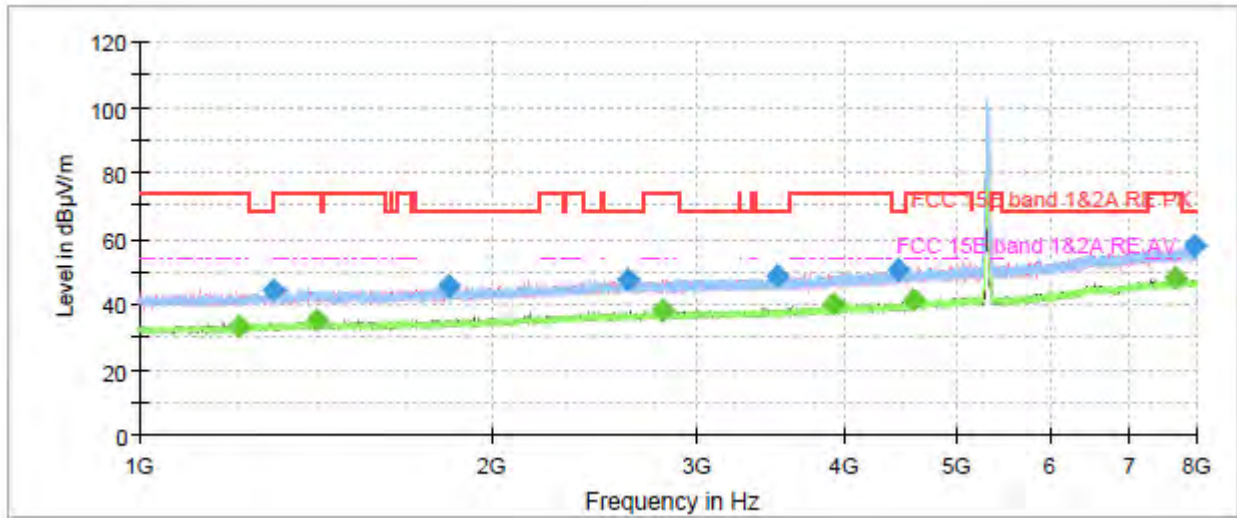

Radiates Emission from 1GHz to 8GHz
 Note: The signal beyond the limit is carrier.

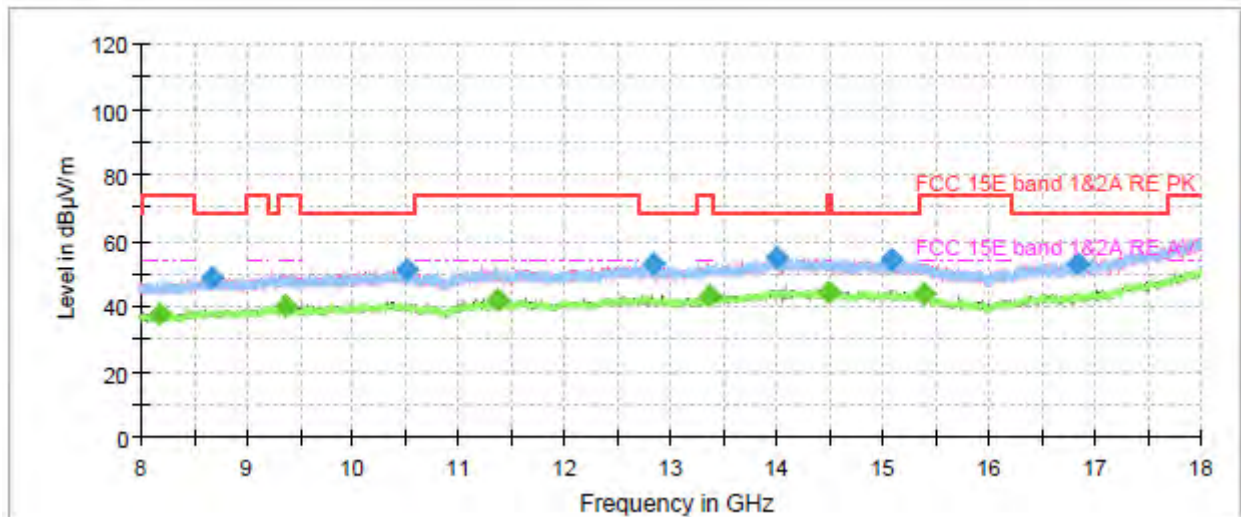

Radiates Emission from 8GHz to 18GHz



Frequency (MHz)	Peak (dBuV/m)	Average (dBuV/m)	Limit (dBuV/m)	Margin (dB)	Height (cm)	Polarization	Azimuth (deg)	Correct Factor (dB)
1217.000000	---	33.51	54.00	20.49	100.0	V	189.0	-10.6
1299.133333	44.32	---	68.20	23.88	100.0	H	9.0	-9.9
1419.066667	---	35.06	54.00	18.94	200.0	V	4.0	-9.2
1835.100000	45.64	---	68.20	22.56	100.0	V	326.0	-8.6
2612.333333	47.69	---	68.20	20.51	200.0	V	39.0	-6.1
2798.066667	---	37.87	54.00	16.13	100.0	V	189.0	-6.0
3500.866667	48.52	---	68.20	19.68	100.0	V	355.0	-4.8
3919.466667	---	39.70	54.00	14.30	200.0	V	318.0	-3.3
4452.866667	50.48	---	68.20	17.72	200.0	V	6.0	-1.6
4575.366667	---	41.52	54.00	12.48	200.0	V	26.0	-1.0
7680.800000	---	47.89	54.00	6.11	200.0	H	171.0	7.0
7977.833333	57.95	---	68.20	10.25	200.0	V	1.0	7.6

Remark: 1. Correction Factor = Antenna factor+ Insertion loss (cable loss + amplifier gain)

802.11a CH64

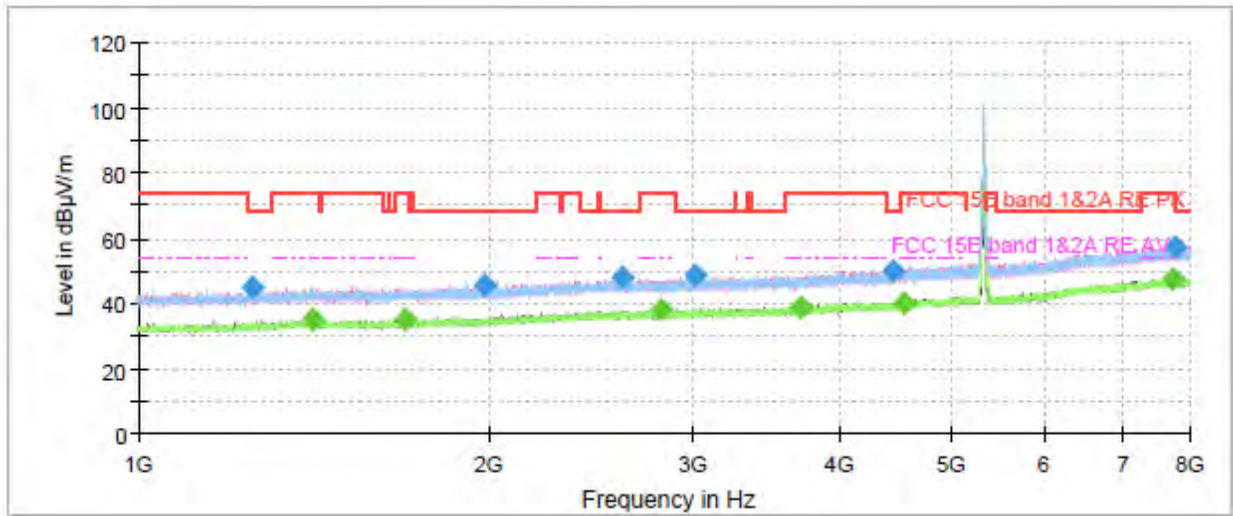

Radiates Emission from 1GHz to 8GHz
 Note: The signal beyond the limit is carrier.

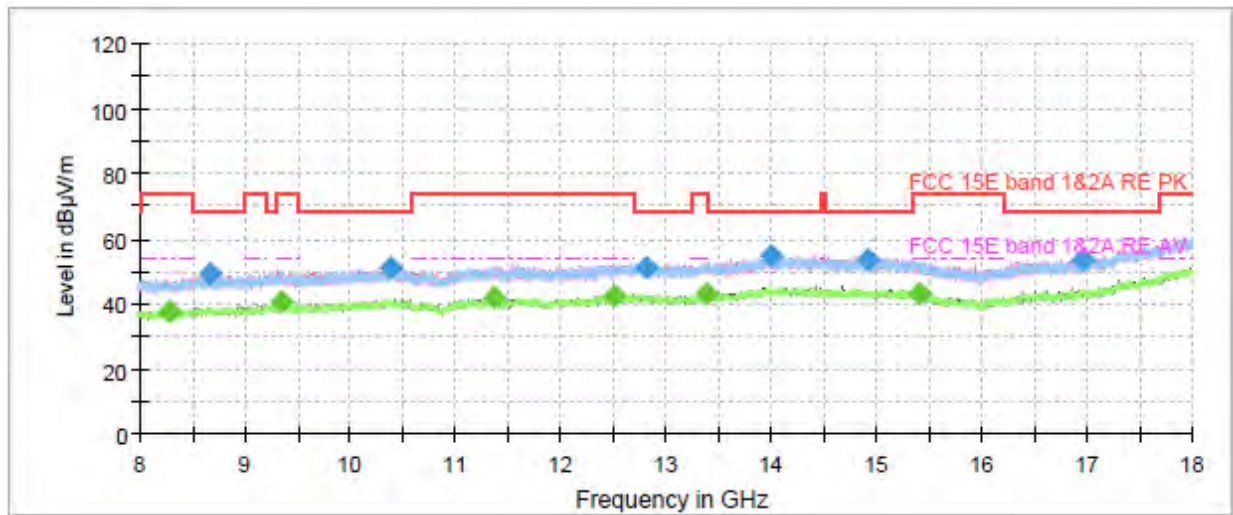

Radiates Emission from 8GHz to 18GHz



Frequency (MHz)	Peak (dBuV/m)	Average (dBuV/m)	Limit (dBuV/m)	Margin (dB)	Height (cm)	Polarization	Azimuth (deg)	Correct Factor (dB)
1253.633333	45.05	---	68.20	23.15	200.0	V	132.0	-10.2
1408.333333	---	35.09	54.00	18.91	200.0	H	358.0	-9.3
1693.000000	---	34.94	54.00	19.06	100.0	V	287.0	-8.9
1980.000000	45.44	---	68.20	22.76	100.0	V	260.0	-8.0
2606.966667	47.81	---	68.20	20.39	200.0	H	342.0	-6.1
2808.800000	---	37.89	54.00	16.11	100.0	H	126.0	-6.0
3014.366667	48.51	---	68.20	19.69	100.0	V	0.0	-5.6
3700.133333	---	38.82	54.00	15.18	200.0	V	0.0	-4.2
4439.800000	50.05	---	68.20	18.15	100.0	V	314.0	-1.6
4544.566667	---	40.07	54.00	13.93	200.0	H	294.0	-1.1
7734.933333	---	47.49	54.00	6.51	200.0	H	185.0	7.0
7756.400000	57.38	---	68.20	10.82	200.0	H	58.0	7.0

Remark: 1. Correction Factor = Antenna factor+ Insertion loss (cable loss + amplifier gain)

802.11a CH100

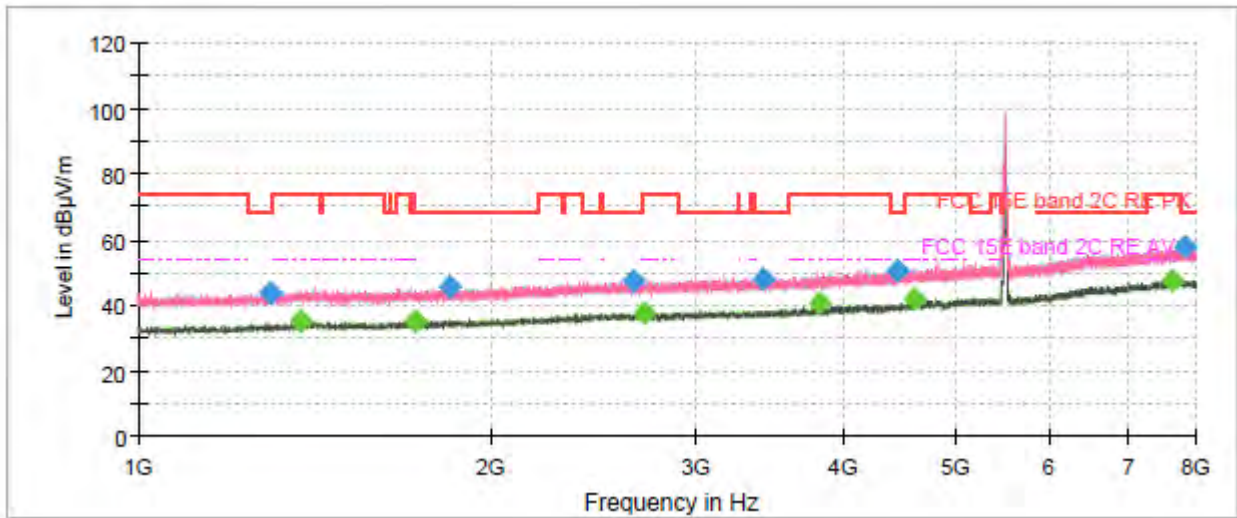

Radiates Emission from 1GHz to 8GHz
 Note: The signal beyond the limit is carrier.

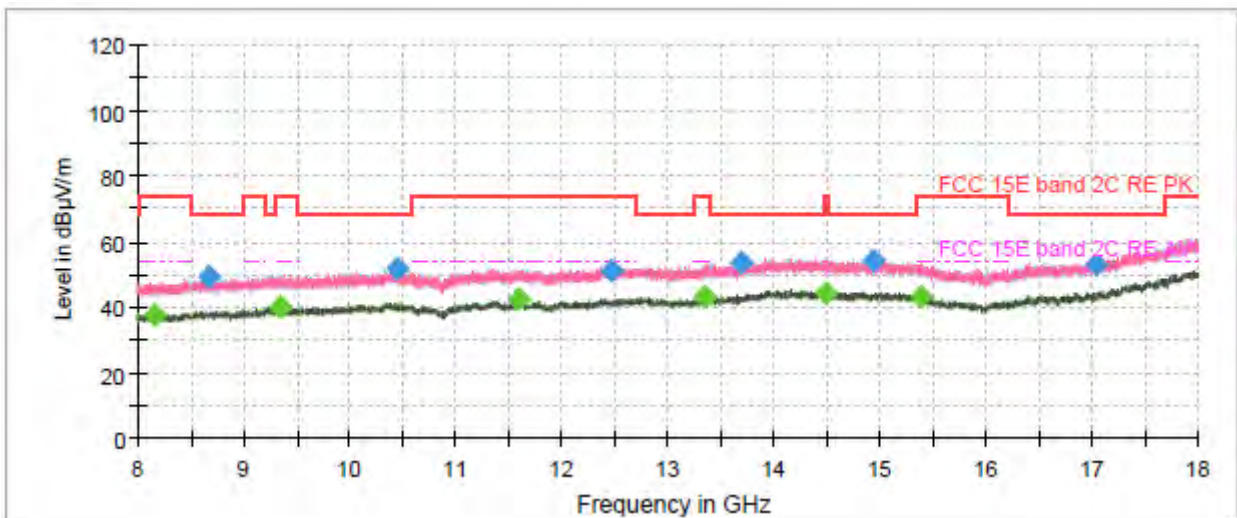

Radiates Emission from 8GHz to 18GHz



Frequency (MHz)	Peak (dBuV/m)	Average (dBuV/m)	Limit (dBuV/m)	Margin (dB)	Height (cm)	Polarization	Azimuth (deg)	Correct Factor (dB)
1297.266667	43.55	---	68.20	24.65	100.0	H	184.0	-9.9
1378.233333	---	34.82	54.00	19.18	200.0	H	36.0	-9.5
1720.066667	---	35.08	54.00	18.92	200.0	H	228.0	-8.9
1841.866667	45.55	---	68.20	22.65	200.0	V	0.0	-8.6
2652.233333	47.37	---	68.20	20.83	200.0	V	214.0	-6.0
2700.066667	---	37.58	54.00	16.42	200.0	H	36.0	-6.1
3411.266667	48.27	---	68.20	19.93	200.0	H	118.0	-4.9
3819.600000	---	40.31	54.00	13.69	200.0	V	336.0	-3.8
4449.366667	50.22	---	68.20	17.98	200.0	V	172.0	-1.6
4605.466667	---	41.58	54.00	12.42	100.0	V	287.0	-0.8
7638.100000	---	47.59	54.00	6.41	200.0	V	0.0	7.0
7842.266667	57.62	---	68.20	10.58	100.0	V	16.0	7.1

Remark: 1. Correction Factor = Antenna factor+ Insertion loss (cable loss + amplifier gain)

802.11a CH116

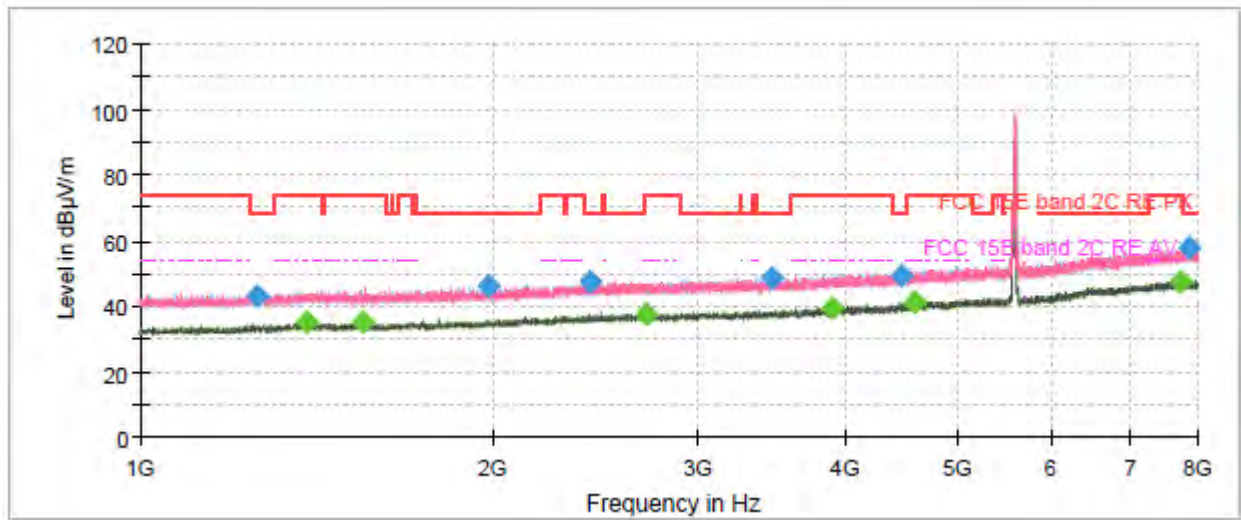

Radiates Emission from 1GHz to 8GHz
 Note: The signal beyond the limit is carrier.

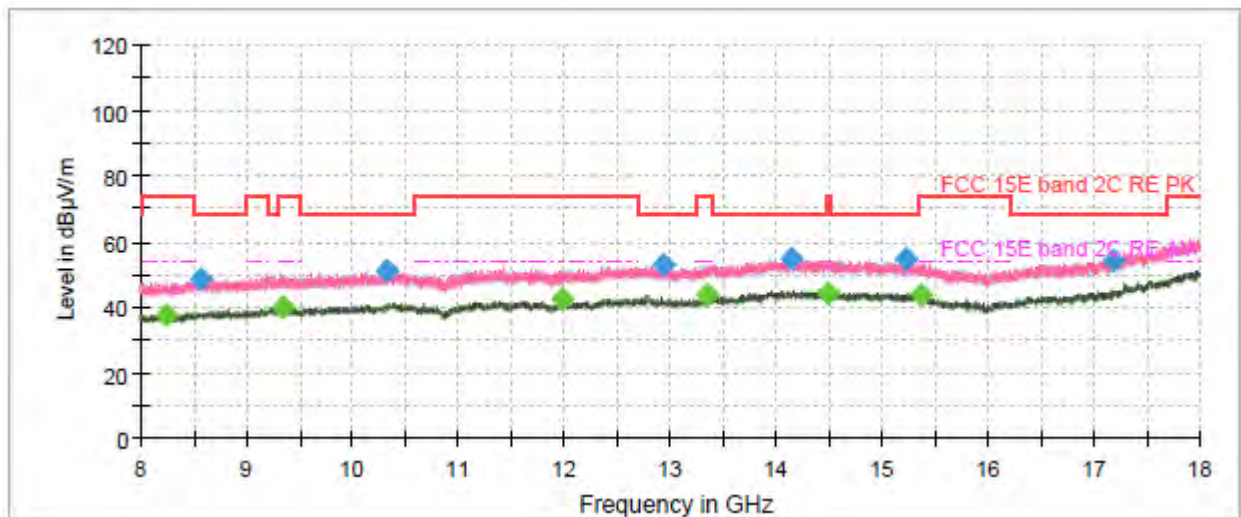

Radiates Emission from 8GHz to 18GHz



Frequency (MHz)	Peak (dBuV/m)	Average (dBuV/m)	Limit (dBuV/m)	Margin (dB)	Height (cm)	Polarization	Azimuth (deg)	Correct Factor (dB)
1259.466667	43.17	---	68.20	25.03	100.0	V	147.0	-10.2
1385.000000	---	34.96	54.00	19.04	100.0	H	296.0	-9.4
1551.366667	---	35.26	54.00	18.74	200.0	V	0.0	-9.1
1982.333333	45.99	---	68.20	22.21	200.0	V	359.0	-8.0
2421.933333	47.39	---	68.20	20.81	100.0	H	322.0	-6.5
2702.400000	---	37.83	54.00	16.17	100.0	V	0.0	-6.1
3462.833333	48.61	---	68.20	19.59	200.0	H	0.0	-4.9
3898.000000	---	39.56	54.00	14.44	100.0	V	0.0	-3.4
4465.933333	49.43	---	68.20	18.77	200.0	H	146.0	-1.5
4592.633333	---	41.04	54.00	12.96	200.0	V	116.0	-0.9
7731.666667	---	47.56	54.00	6.44	100.0	V	274.0	7.0
7857.900000	57.61	---	68.20	10.59	200.0	H	15.0	7.1

Remark: 1. Correction Factor = Antenna factor+ Insertion loss (cable loss + amplifier gain)

802.11a CH140

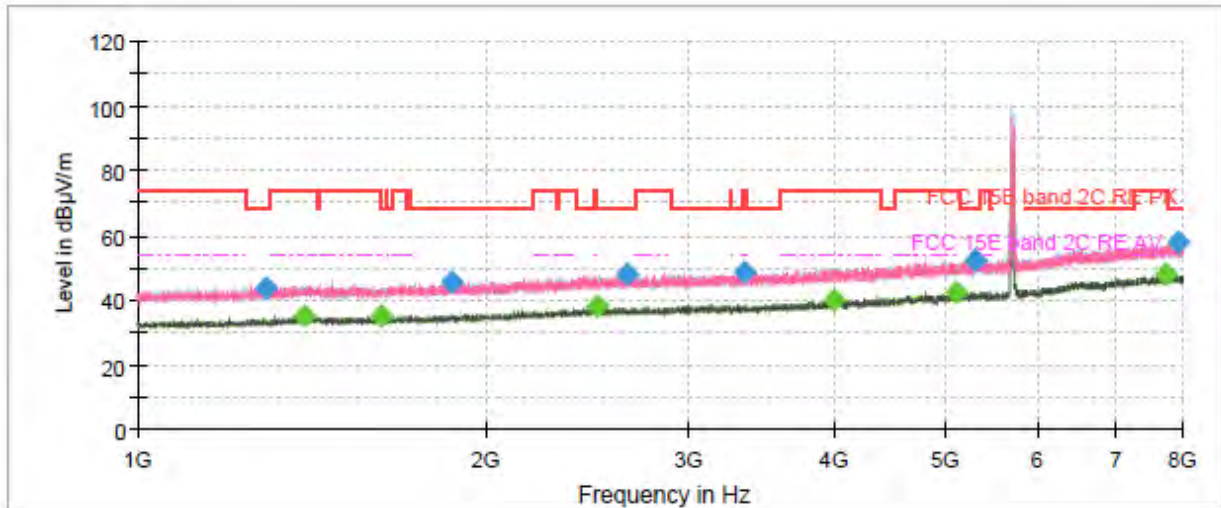

Radiates Emission from 1GHz to 8GHz
 Note: The signal beyond the limit is carrier.

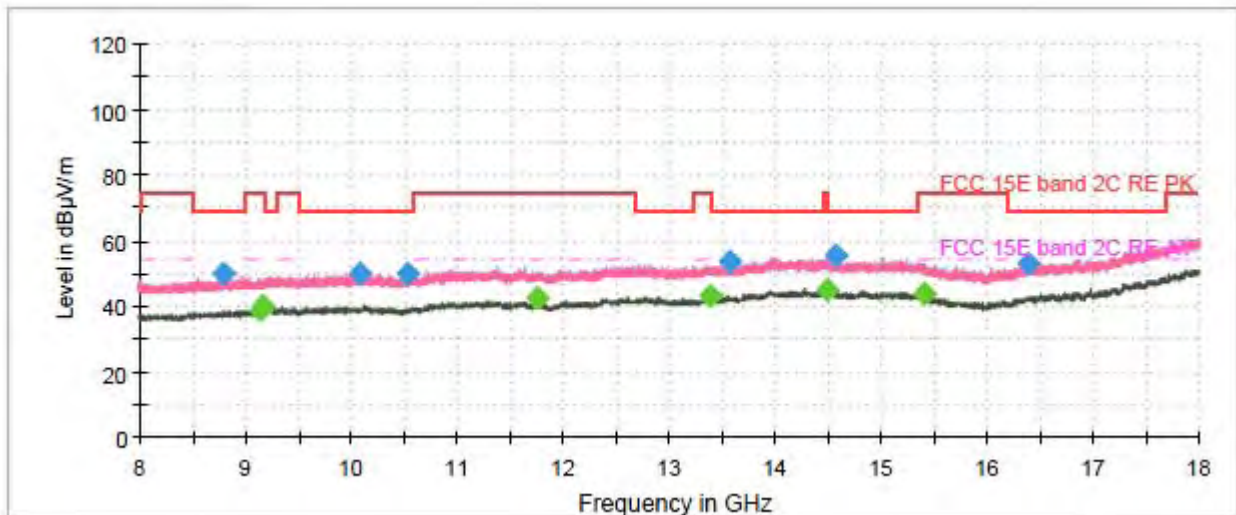

Radiates Emission from 8GHz to 18GHz



Frequency (MHz)	Peak (dBuV/m)	Average (dBuV/m)	Limit (dBuV/m)	Margin (dB)	Height (cm)	Polarization	Azimuth (deg)	Correct Factor (dB)
1290.500000	43.98	---	68.20	24.22	200.0	H	6.0	-9.9
1394.100000	---	35.32	54.00	18.68	200.0	H	259.0	-9.4
1624.400000	---	35.38	54.00	18.62	200.0	H	274.0	-9.0
1864.733333	45.64	---	68.20	22.56	100.0	H	333.0	-8.5
2491.700000	---	38.04	54.00	15.96	100.0	H	266.0	-6.3
2644.766667	47.70	---	68.20	20.50	200.0	V	355.0	-6.1
3342.200000	48.31	---	68.20	19.89	200.0	H	3.0	-5.1
3995.766667	---	39.98	54.00	14.02	200.0	V	76.0	-2.9
5092.200000	---	42.77	54.00	11.23	100.0	V	31.0	0.8
5305.233333	52.47	---	68.20	15.73	200.0	H	6.0	1.2
7746.833333	---	47.93	54.00	6.07	100.0	V	7.0	7.0
7929.066667	57.80	---	68.20	10.40	200.0	V	230.0	7.5

Remark: 1. Correction Factor = Antenna factor+ Insertion loss (cable loss + amplifier gain)

802.11a CH144

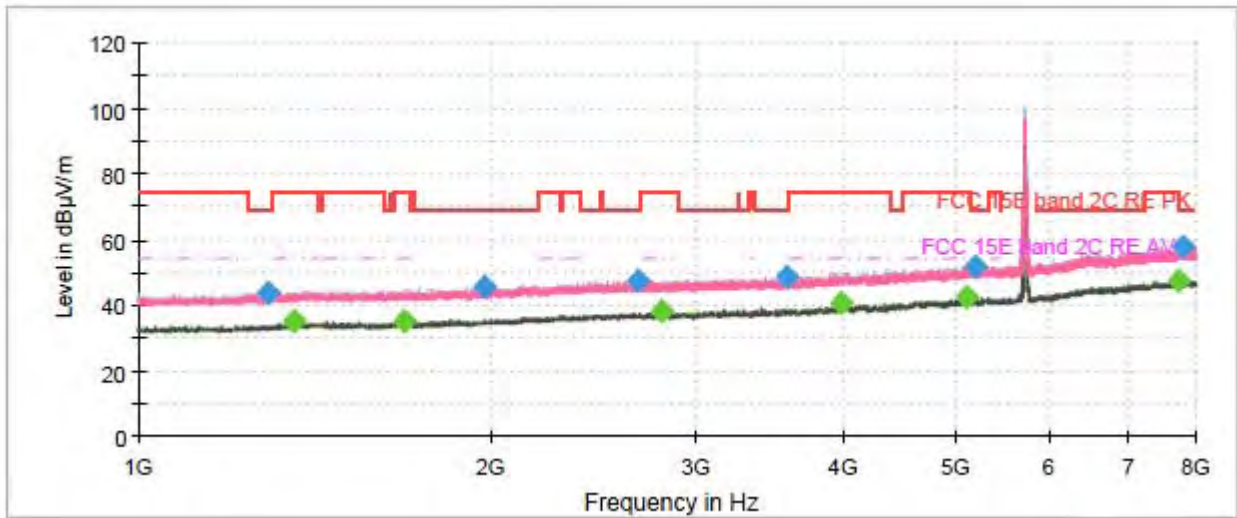

Radiates Emission from 1GHz to 8GHz
 Note: The signal beyond the limit is carrier.

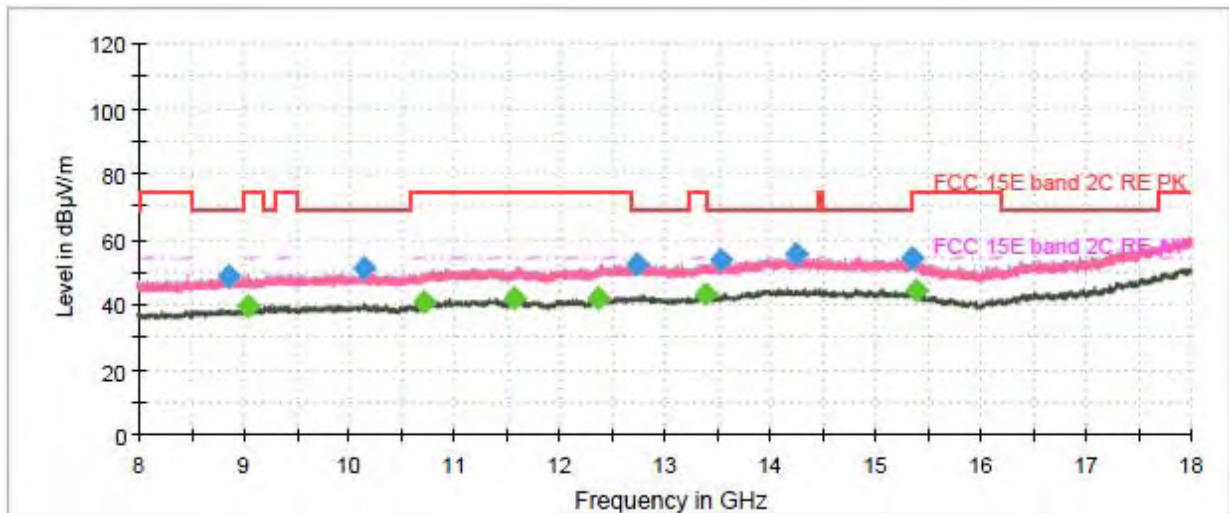

Radiates Emission from 8GHz to 18GHz



Frequency (MHz)	Peak (dBuV/m)	Average (dBuV/m)	Limit (dBuV/m)	Margin (dB)	Height (cm)	Polarization	Azimuth (deg)	Correct Factor (dB)
1288.866667	43.83	---	68.20	24.37	100.0	H	183.0	-9.9
1355.833333	---	35.24	54.00	18.76	200.0	V	104.0	-9.5
1690.666667	---	35.30	54.00	18.70	100.0	H	183.0	-8.9
1971.600000	45.81	---	68.20	22.39	200.0	V	357.0	-8.1
2666.000000	47.44	---	68.20	20.76	100.0	H	42.0	-6.0
2799.466667	---	37.88	54.00	16.12	100.0	H	342.0	-6.0
3575.300000	48.49	---	68.20	19.71	200.0	V	352.0	-4.6
3979.666667	---	40.32	54.00	13.68	100.0	V	334.0	-3.0
5091.266667	---	42.30	54.00	11.70	100.0	V	101.0	0.8
5180.400000	51.84	---	68.20	16.36	200.0	V	27.0	0.9
7746.600000	---	47.57	54.00	6.43	100.0	V	73.0	7.0
7785.566667	57.94	---	68.20	10.26	100.0	V	13.0	7.0

Remark: 1. Correction Factor = Antenna factor+ Insertion loss (cable loss + amplifier gain)

802.11n (HT20) CH36

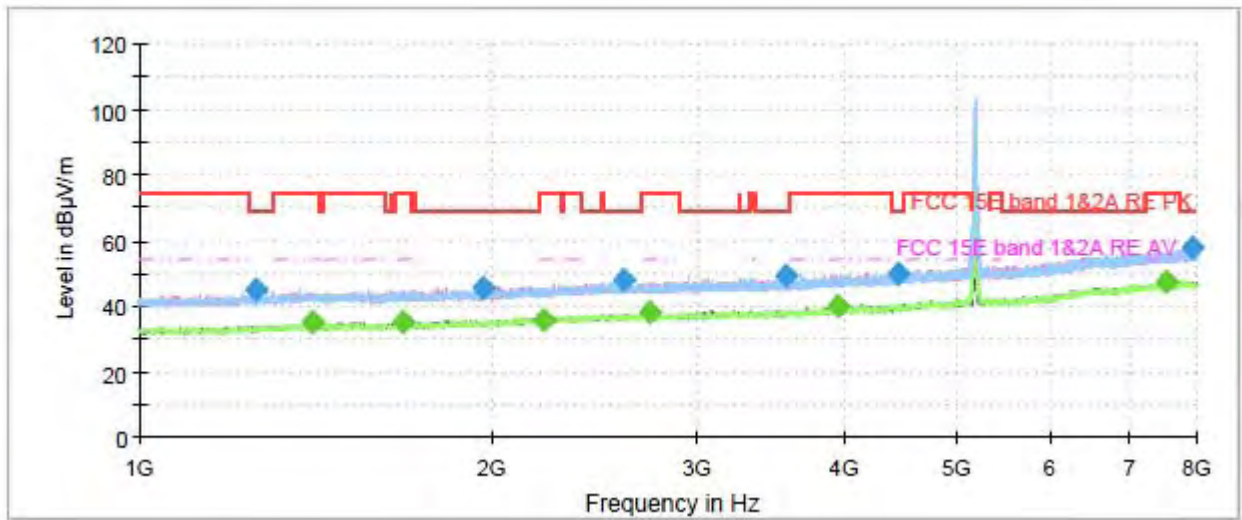

Radiates Emission from 1GHz to 8GHz
 Note: The signal beyond the limit is carrier.

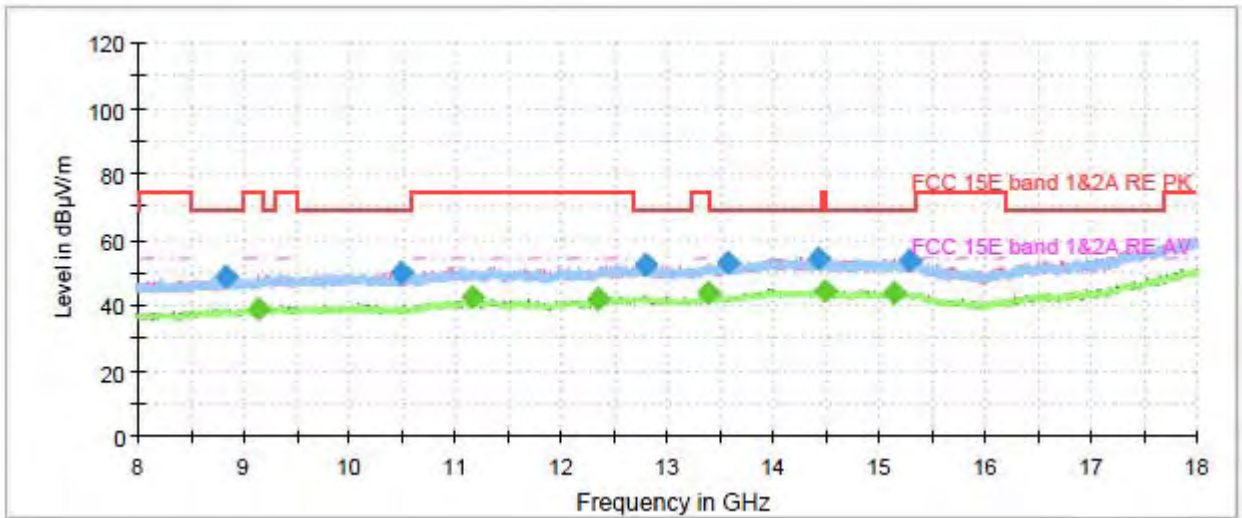

Radiates Emission from 8GHz to 18GHz



Frequency (MHz)	Peak (dBuV/m)	Average (dBuV/m)	Limit (dBuV/m)	Margin (dB)	Height (cm)	Polarization	Azimuth (deg)	Correct Factor (dB)
1258.533333	44.86	---	68.20	23.34	200.0	V	0.0	-10.2
1408.100000	---	35.15	54.00	18.85	100.0	V	310.0	-9.3
1677.833333	---	35.08	54.00	18.92	200.0	H	343.0	-9.0
1964.366667	45.81	---	68.20	22.39	200.0	V	118.0	-8.2
2218.233333	---	35.68	54.00	18.32	100.0	V	0.0	-7.2
2592.733333	48.08	---	68.20	20.12	200.0	H	356.0	-6.1
2725.966667	---	38.16	54.00	15.84	100.0	V	0.0	-6.1
3565.266667	49.08	---	68.20	19.12	200.0	V	214.0	-4.6
3950.966667	---	39.75	54.00	14.25	200.0	V	172.0	-3.2
4454.966667	49.74	---	68.20	18.46	100.0	H	3.0	-1.5
7552.933333	---	47.56	54.00	6.44	100.0	V	242.0	7.0
7920.900000	57.68	---	68.20	10.52	200.0	H	26.0	7.4

Remark: 1. Correction Factor = Antenna factor+ Insertion loss (cable loss + amplifier gain)

802.11n (HT20) CH40

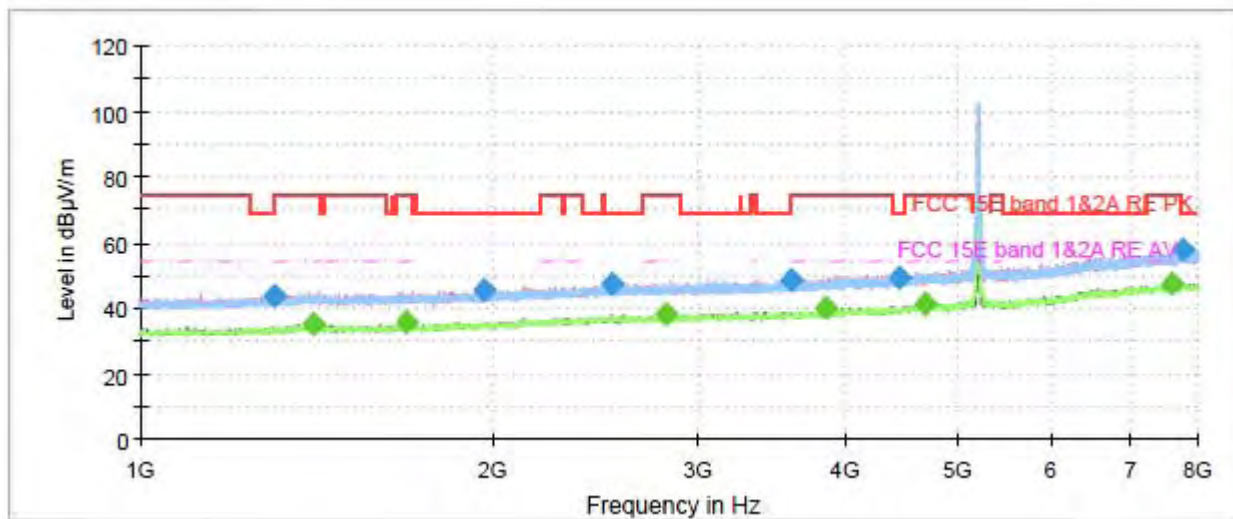

Radiates Emission from 1GHz to 8GHz
 Note: The signal beyond the limit is carrier.

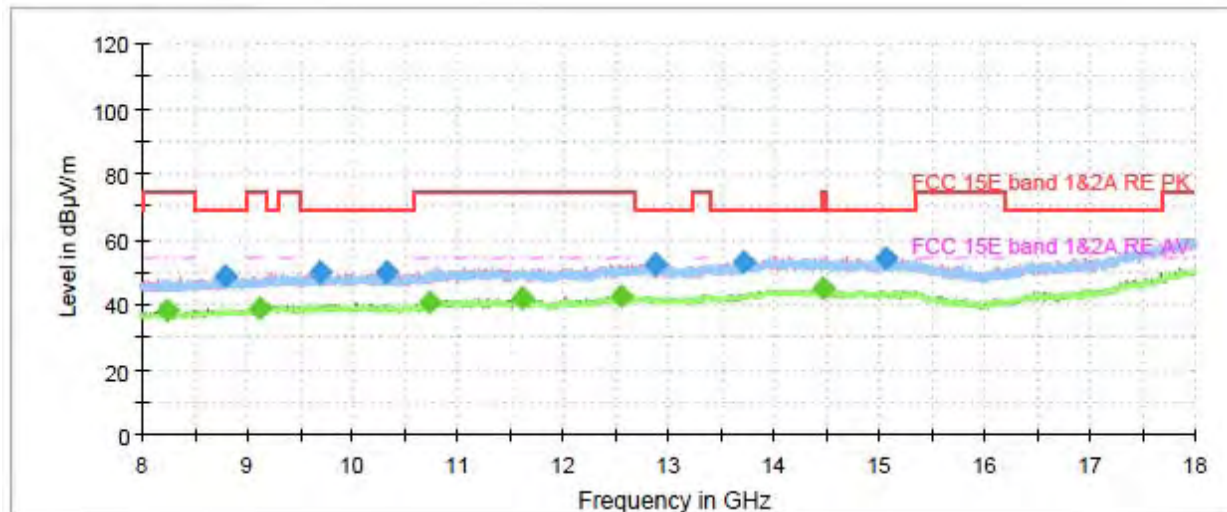

Radiates Emission from 8GHz to 18GHz



Frequency (MHz)	Peak (dBuV/m)	Average (dBuV/m)	Limit (dBuV/m)	Margin (dB)	Height (cm)	Polarization	Azimuth (deg)	Correct Factor (dB)
1299.600000	43.68	---	68.20	24.52	200.0	V	120.0	-9.9
1406.000000	---	34.99	54.00	19.01	200.0	H	176.0	-9.3
1687.166667	---	35.72	54.00	18.28	100.0	H	145.0	-8.9
1968.100000	45.70	---	68.20	22.50	200.0	H	44.0	-8.1
2526.466667	47.53	---	68.20	20.67	200.0	H	231.0	-6.3
2807.633333	---	37.89	54.00	16.11	100.0	V	314.0	-6.0
3599.333333	48.57	---	68.20	19.63	200.0	H	351.0	-4.5
3842.000000	---	40.04	54.00	13.97	200.0	H	231.0	-3.7
4442.133333	49.48	---	68.20	18.72	100.0	V	149.0	-1.6
4672.900000	---	40.98	54.00	13.02	200.0	V	93.0	-0.5
7616.166667	---	47.46	54.00	6.54	200.0	H	0.0	7.0
7770.400000	57.67	---	68.20	10.53	200.0	H	359.0	7.0

Remark: 1. Correction Factor = Antenna factor+ Insertion loss (cable loss + amplifier gain)

802.11n (HT20) CH48

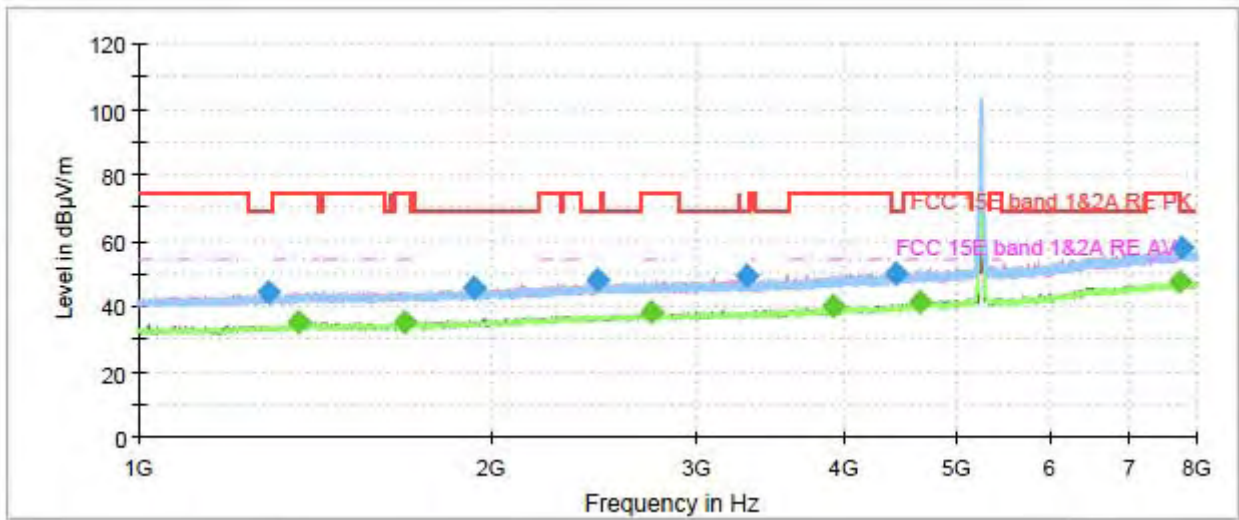

Radiates Emission from 1GHz to 8GHz
 Note: The signal beyond the limit is carrier.

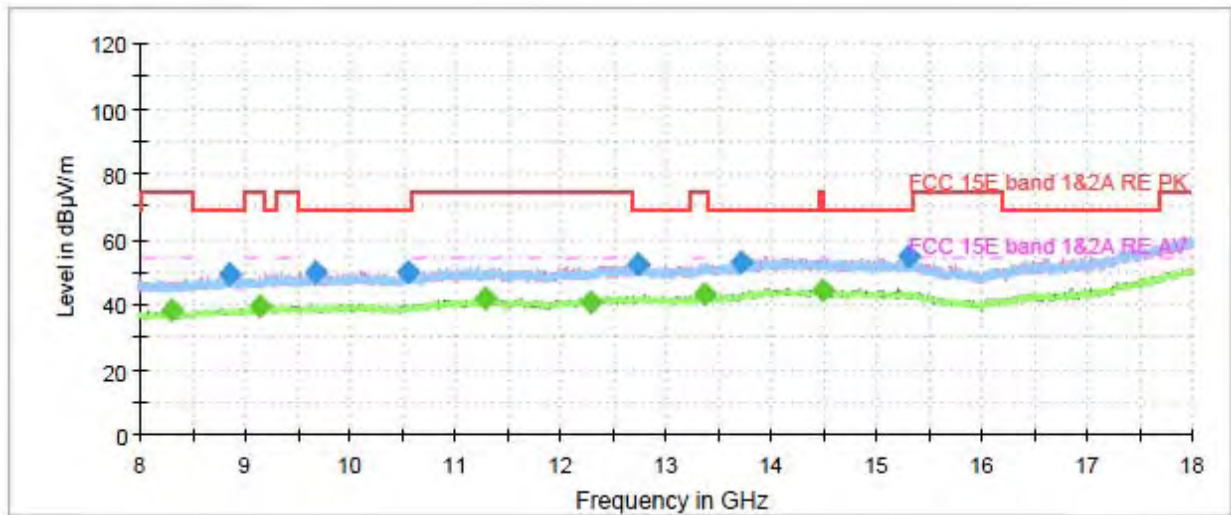

Radiates Emission from 8GHz to 18GHz



Frequency (MHz)	Peak (dBuV/m)	Average (dBuV/m)	Limit (dBuV/m)	Margin (dB)	Height (cm)	Polarization	Azimuth (deg)	Correct Factor (dB)
1288.400000	44.10	---	68.20	24.10	200.0	V	0.0	-10.0
1369.133333	---	35.25	54.00	18.75	200.0	H	57.0	-9.5
1687.866667	---	35.10	54.00	18.90	200.0	H	354.0	-8.9
1931.000000	45.80	---	68.20	22.40	200.0	H	268.0	-8.2
2461.600000	48.01	---	68.20	20.19	100.0	H	126.0	-6.3
2737.866667	---	38.19	54.00	15.81	200.0	V	9.0	-6.1
3306.266667	49.23	---	68.20	18.97	200.0	H	116.0	-5.2
3920.166667	---	40.02	54.00	13.98	100.0	V	157.0	-3.3
4434.900000	49.70	---	68.20	18.50	200.0	V	23.0	-1.6
4650.033333	---	41.27	54.00	12.73	200.0	V	0.0	-0.6
7722.566667	---	47.53	54.00	6.47	200.0	H	357.0	7.0
7767.366667	57.90	---	68.20	10.30	200.0	H	358.0	7.0

Remark: 1. Correction Factor = Antenna factor+ Insertion loss (cable loss + amplifier gain)

802.11n (HT20) CH52

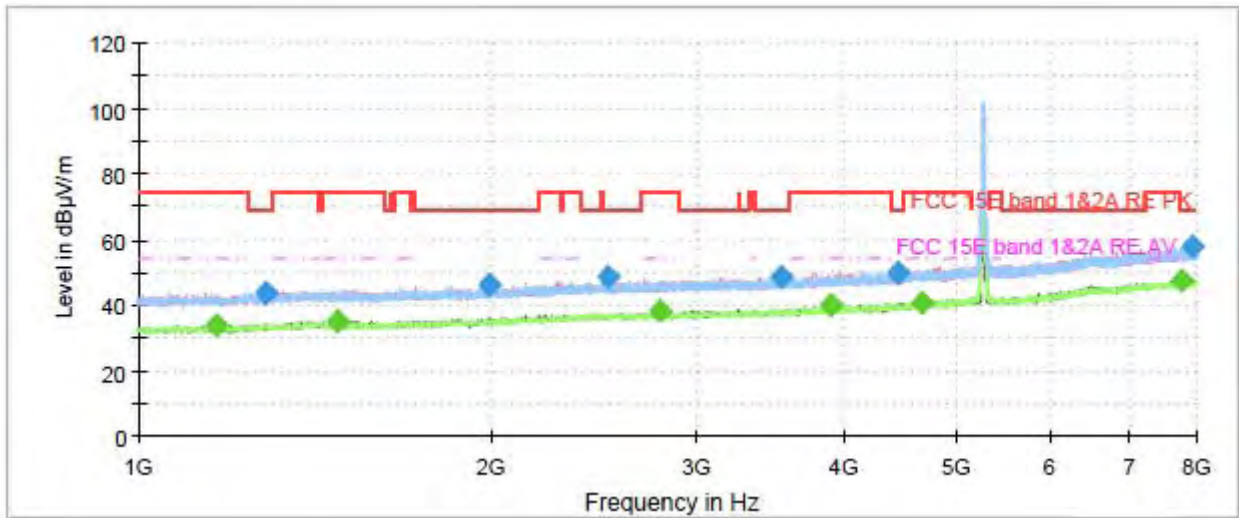

Radiates Emission from 1GHz to 8GHz
 Note: The signal beyond the limit is carrier.

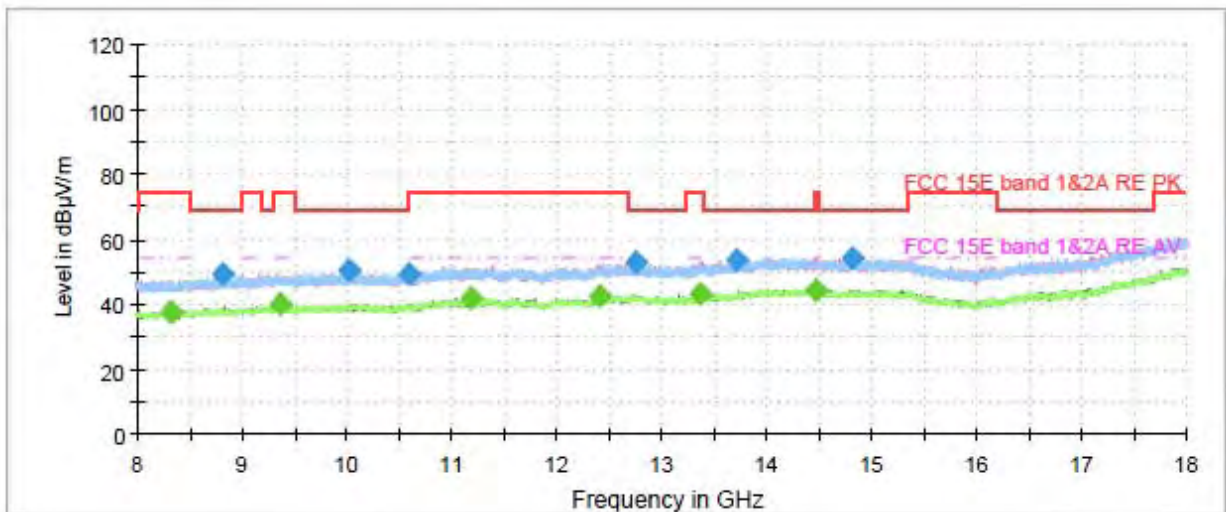

Radiates Emission from 8GHz to 18GHz



Frequency (MHz)	Peak (dBuV/m)	Average (dBuV/m)	Limit (dBuV/m)	Margin (dB)	Height (cm)	Polarization	Azimuth (deg)	Correct Factor (dB)
1167.066667	---	33.59	54.00	20.41	100.0	V	281.0	-10.7
1285.600000	43.99	---	68.20	24.21	100.0	V	322.0	-10.0
1476.933333	---	35.28	54.00	18.72	100.0	V	322.0	-9.2
1994.933333	46.15	---	68.20	22.05	100.0	V	228.0	-7.9
2521.100000	48.61	---	68.20	19.59	100.0	V	356.0	-6.3
2781.266667	---	37.87	54.00	16.13	100.0	H	1.0	-6.1
3529.100000	48.92	---	68.20	19.28	100.0	H	302.0	-4.6
3897.300000	---	39.79	54.00	14.21	100.0	V	87.0	-3.4
4446.100000	49.77	---	68.20	18.43	200.0	V	215.0	-1.6
4662.866667	---	40.39	54.00	13.61	100.0	H	50.0	-0.5
7749.166667	---	47.66	54.00	6.34	200.0	H	355.0	7.0
7921.833333	57.97	---	68.20	10.23	100.0	H	0.0	7.5

Remark: 1. Correction Factor = Antenna factor+ Insertion loss (cable loss + amplifier gain)

802.11n (HT20) CH60

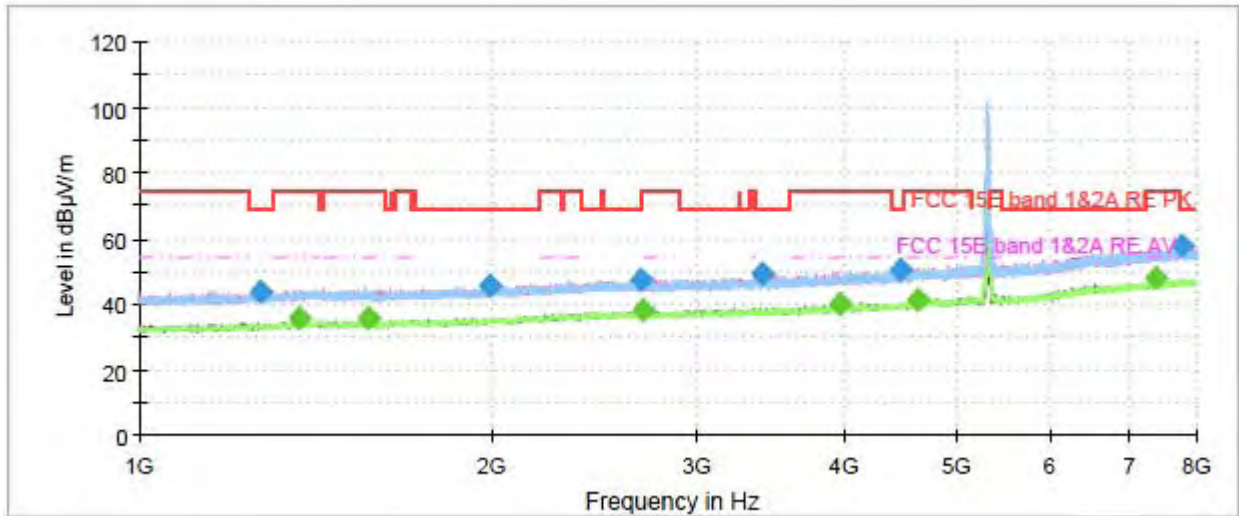

Radiates Emission from 1GHz to 8GHz
 Note: The signal beyond the limit is carrier.

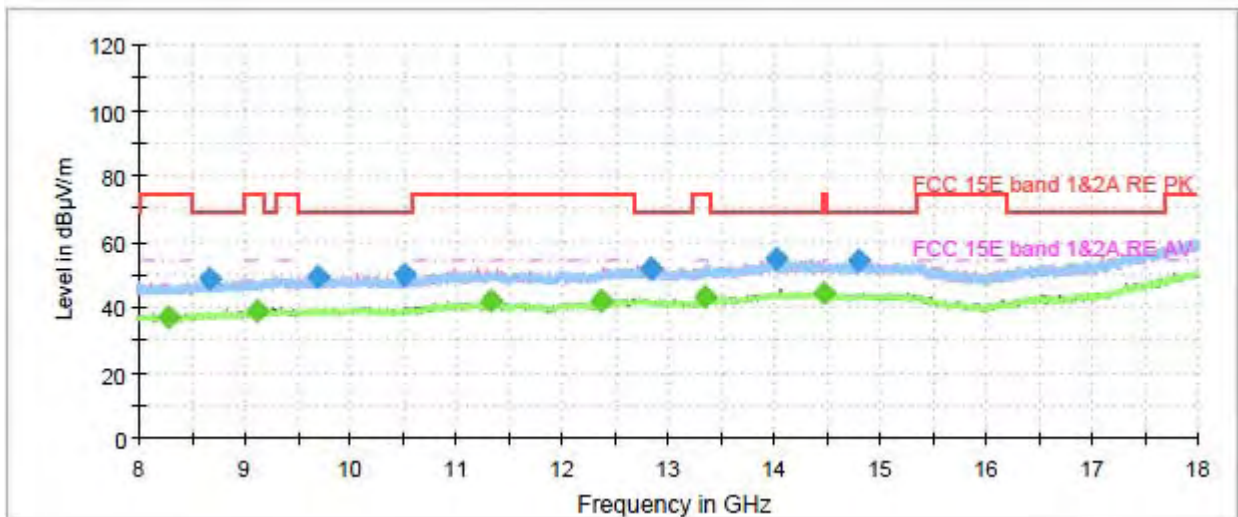

Radiates Emission from 8GHz to 18GHz



Frequency (MHz)	Peak (dBuV/m)	Average (dBuV/m)	Limit (dBuV/m)	Margin (dB)	Height (cm)	Polarization	Azimuth (deg)	Correct Factor (dB)
1271.133333	43.99	---	68.20	24.21	100.0	V	344.0	-10.1
1367.733333	---	35.39	54.00	18.61	200.0	V	16.0	-9.5
1572.366667	---	35.54	54.00	18.46	200.0	V	0.0	-9.0
1992.366667	45.50	---	68.20	22.70	200.0	H	347.0	-7.9
2680.466667	47.47	---	68.20	20.73	200.0	H	129.0	-6.0
2695.866667	---	37.95	54.00	16.05	200.0	V	189.0	-6.1
3404.500000	49.33	---	68.20	18.87	100.0	H	201.0	-5.0
3957.966667	---	40.05	54.00	13.95	100.0	V	359.0	-3.2
4466.866667	50.19	---	68.20	18.01	200.0	V	120.0	-1.5
4632.066667	---	41.48	54.00	12.52	200.0	H	2.0	-0.7
7376.766667	---	47.73	54.00	6.27	200.0	V	359.0	6.7
7750.800000	57.55	---	68.20	10.65	100.0	H	104.0	7.0

Remark: 1. Correction Factor = Antenna factor+ Insertion loss (cable loss + amplifier gain)

802.11n (HT20) CH64

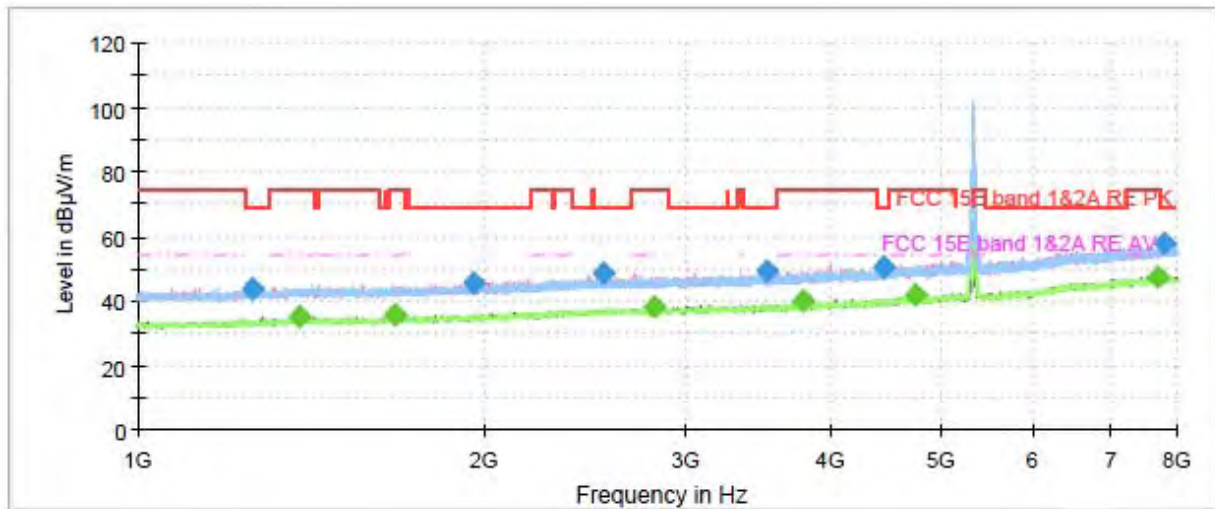

Radiates Emission from 1GHz to 8GHz
 Note: The signal beyond the limit is carrier.

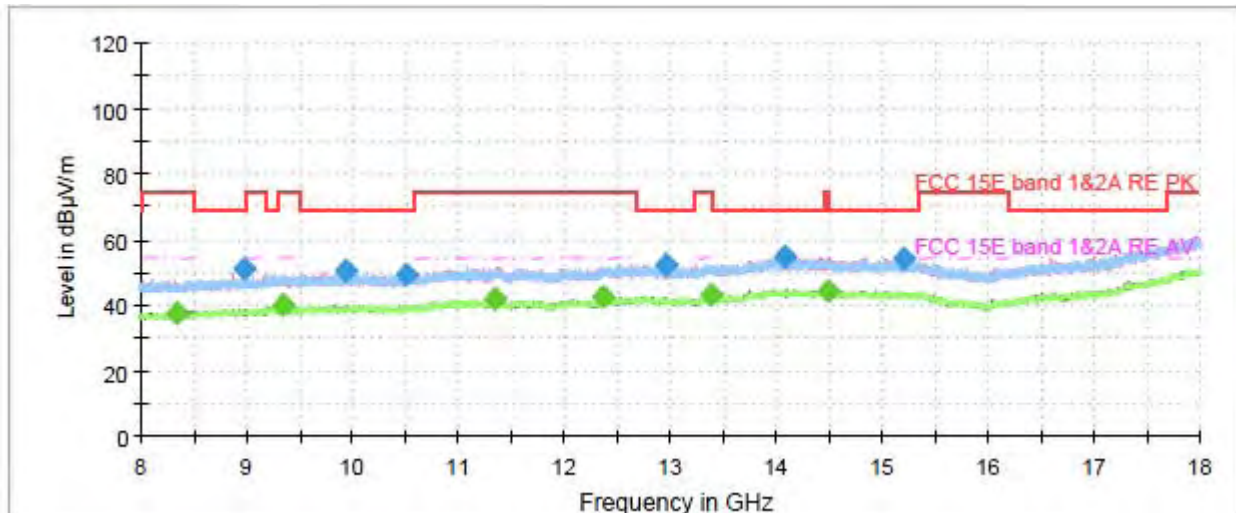

Radiates Emission from 8GHz to 18GHz



Frequency (MHz)	Peak (dBuV/m)	Average (dBuV/m)	Limit (dBuV/m)	Margin (dB)	Height (cm)	Polarization	Azimuth (deg)	Correct Factor (dB)
1260.400000	43.69	---	68.20	24.51	200.0	V	38.0	-10.2
1382.433333	---	34.83	54.00	19.17	200.0	V	91.0	-9.5
1672.466667	---	35.57	54.00	18.43	200.0	H	117.0	-9.0
1956.200000	45.52	---	68.20	22.68	200.0	V	3.0	-8.2
2542.566667	48.49	---	68.20	19.71	100.0	V	338.0	-6.2
2810.666667	---	37.92	54.00	16.08	200.0	V	26.0	-6.0
3514.866667	48.95	---	68.20	19.25	100.0	H	258.0	-4.7
3779.233333	---	39.96	54.00	14.04	200.0	V	174.0	-4.0
4448.900000	50.36	---	68.20	17.84	200.0	V	26.0	-1.6
4734.966667	---	41.84	54.00	12.16	100.0	H	135.0	-0.4
7710.200000	---	47.68	54.00	6.32	100.0	H	0.0	7.0
7813.100000	57.92	---	68.20	10.28	200.0	V	242.0	7.0

Remark: 1. Correction Factor = Antenna factor+ Insertion loss (cable loss + amplifier gain)

802.11n (HT20) CH100

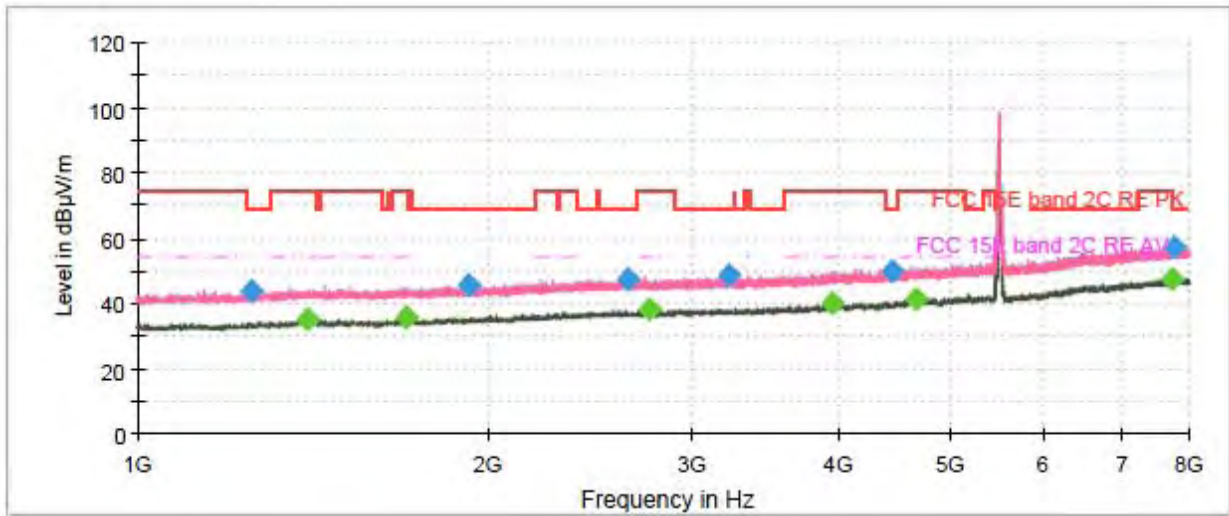

Radiates Emission from 1GHz to 8GHz
 Note: The signal beyond the limit is carrier.

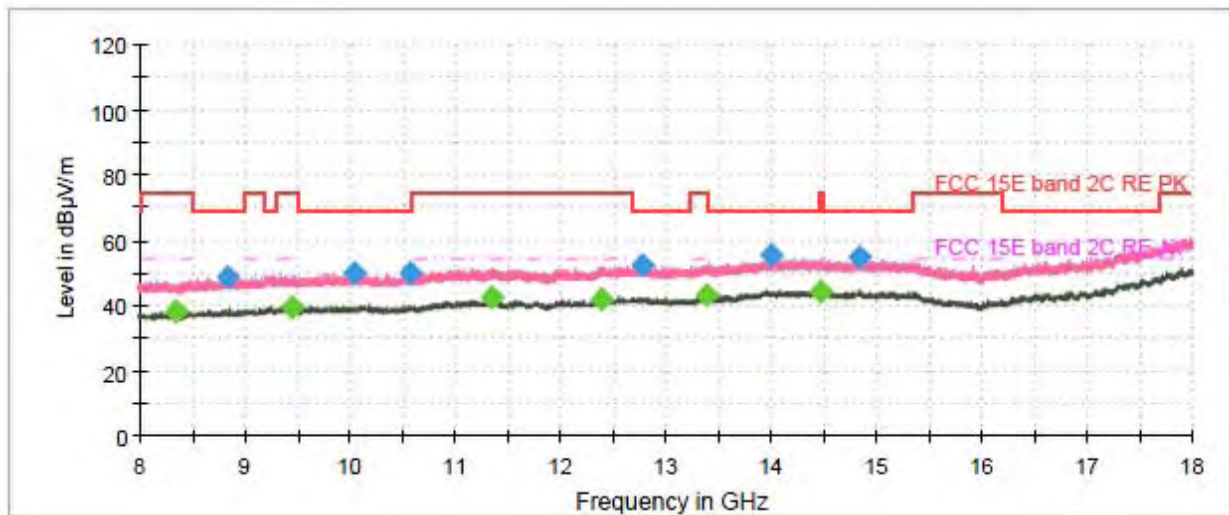

Radiates Emission from 8GHz to 18GHz



Frequency (MHz)	Peak (dBuV/m)	Average (dBuV/m)	Limit (dBuV/m)	Margin (dB)	Height (cm)	Polarization	Azimuth (deg)	Correct Factor (dB)
1250.600000	43.93	---	68.20	24.27	200.0	V	359.0	-10.2
1401.333333	---	35.21	54.00	18.79	100.0	V	128.0	-9.3
1704.666667	---	35.72	54.00	18.28	200.0	H	349.0	-8.8
1920.966667	45.79	---	68.20	22.41	100.0	H	254.0	-8.3
2637.066667	47.52	---	68.20	20.68	200.0	V	0.0	-6.1
2750.933333	---	38.16	54.00	15.84	200.0	H	183.0	-6.1
3220.400000	48.90	---	68.20	19.30	100.0	V	245.0	-5.1
3957.033333	---	40.27	54.00	13.73	200.0	V	0.0	-3.2
4451.466667	49.64	---	68.20	18.56	200.0	V	268.0	-1.6
4657.266667	---	41.14	54.00	12.86	200.0	V	268.0	-0.5
7748.000000	---	47.69	54.00	6.31	100.0	V	170.0	7.0
7768.766667	57.18	---	68.20	11.02	200.0	H	215.0	7.0

Remark: 1. Correction Factor = Antenna factor+ Insertion loss (cable loss + amplifier gain)

802.11n (HT20) CH116

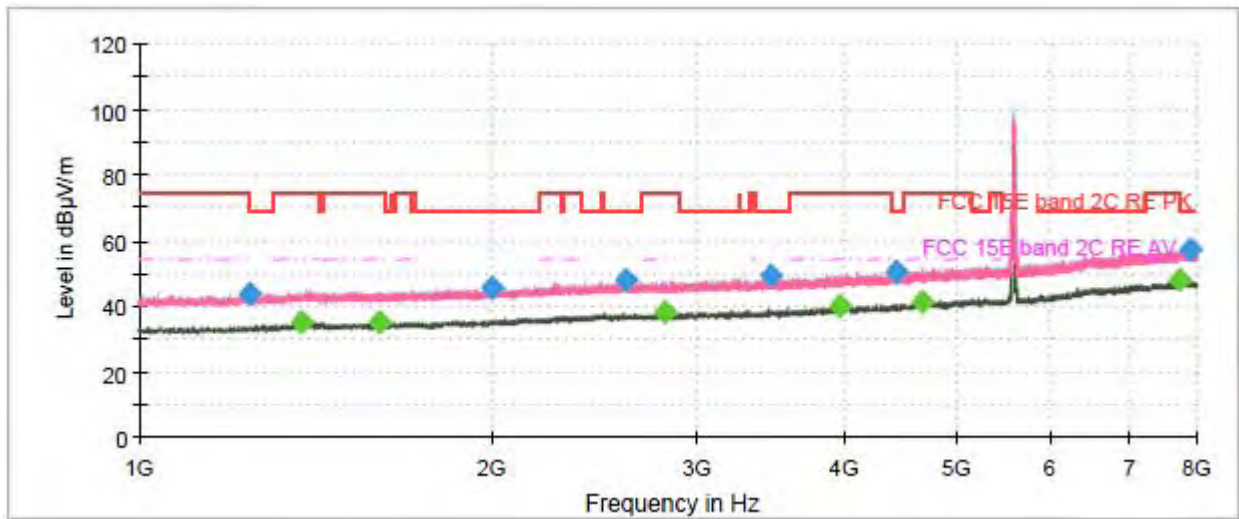

Radiates Emission from 1GHz to 8GHz
 Note: The signal beyond the limit is carrier.

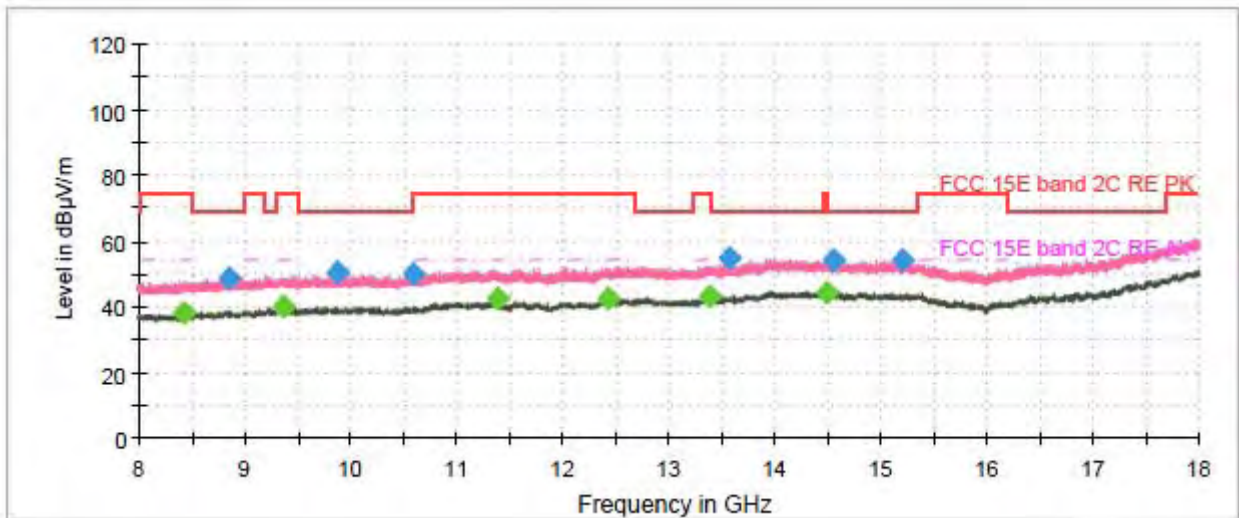

Radiates Emission from 8GHz to 18GHz



Frequency (MHz)	Peak (dBuV/m)	Average (dBuV/m)	Limit (dBuV/m)	Margin (dB)	Height (cm)	Polarization	Azimuth (deg)	Correct Factor (dB)
1241.266667	43.95	---	68.20	24.25	100.0	V	243.0	-10.2
1372.866667	---	35.15	54.00	18.85	200.0	H	128.0	-9.5
1600.600000	---	35.34	54.00	18.67	100.0	H	281.0	-9.2
1997.733333	45.62	---	68.20	22.58	100.0	H	160.0	-7.9
2603.233333	47.83	---	68.20	20.37	200.0	V	255.0	-6.1
2808.100000	---	37.97	54.00	16.03	200.0	V	198.0	-6.0
3465.866667	48.96	---	68.20	19.24	100.0	V	126.0	-4.9
3966.366667	---	39.95	54.00	14.05	100.0	V	0.0	-3.1
4424.633333	50.75	---	68.20	17.45	200.0	V	357.0	-1.7
4656.566667	---	41.08	54.00	12.92	200.0	V	335.0	-0.5
7743.333333	---	48.17	54.00	5.83	100.0	H	0.0	7.0
7906.900000	57.53	---	68.20	10.67	100.0	V	0.0	7.4

Remark: 1. Correction Factor = Antenna factor+ Insertion loss (cable loss + amplifier gain)

802.11n (HT20) CH140

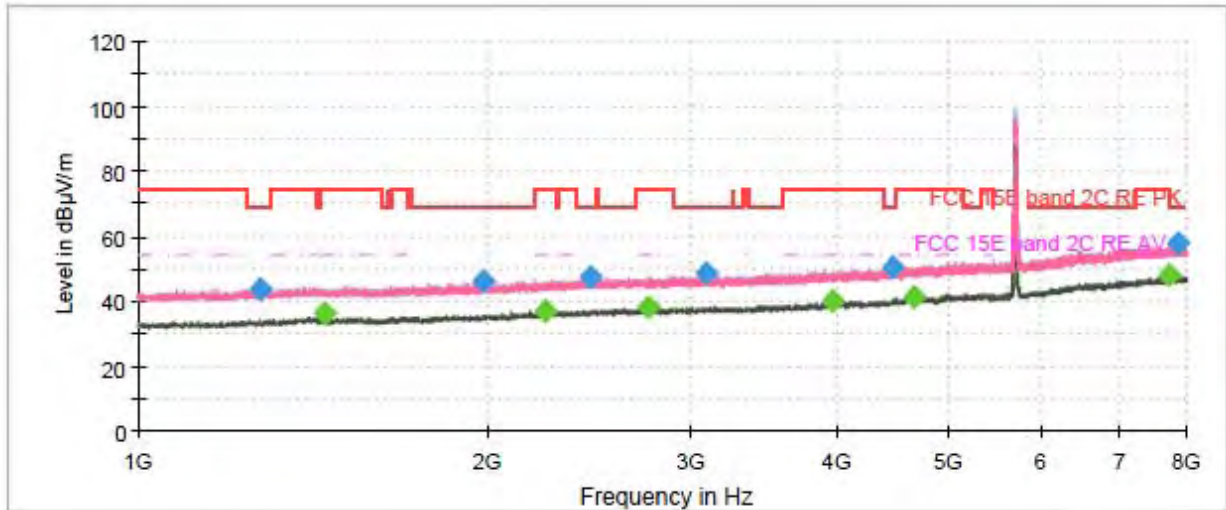

Radiates Emission from 1GHz to 8GHz
 Note: The signal beyond the limit is carrier.

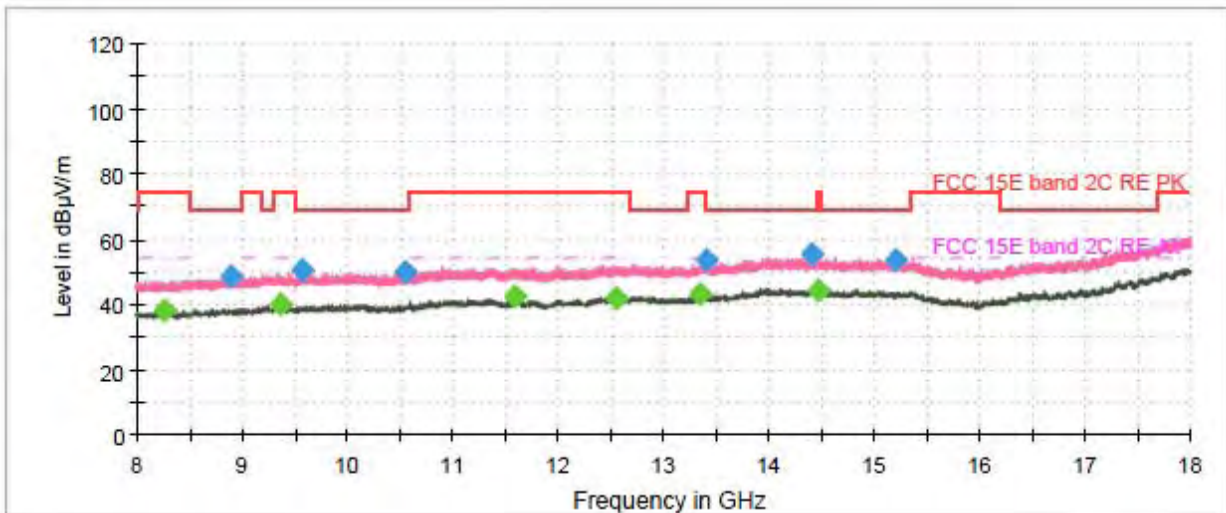

Radiates Emission from 8GHz to 18GHz



Frequency (MHz)	Peak (dBuV/m)	Average (dBuV/m)	Limit (dBuV/m)	Margin (dB)	Height (cm)	Polarization	Azimuth (deg)	Correct Factor (dB)
1271.833333	43.83	---	68.20	24.37	100.0	H	72.0	-10.1
1448.466667	---	36.15	54.00	17.85	200.0	H	188.0	-9.3
1983.033333	46.14	---	68.20	22.06	200.0	V	143.0	-8.0
2246.700000	---	36.67	54.00	17.33	100.0	V	90.0	-7.1
2457.400000	47.49	---	68.20	20.71	100.0	H	212.0	-6.4
2751.400000	---	38.13	54.00	15.87	200.0	H	0.0	-6.1
3089.733333	48.70	---	68.20	19.50	100.0	H	258.0	-5.5
3965.666667	---	40.00	54.00	14.00	100.0	V	75.0	-3.1
4461.266667	50.56	---	68.20	17.64	200.0	V	324.0	-1.5
4659.600000	---	40.94	54.00	13.06	200.0	V	359.0	-0.5
7737.966667	---	47.84	54.00	6.17	100.0	V	271.0	7.0
7860.233333	57.66	---	68.20	10.54	200.0	V	0.0	7.2

Remark: 1. Correction Factor = Antenna factor+ Insertion loss (cable loss + amplifier gain)

802.11n (HT20) CH144

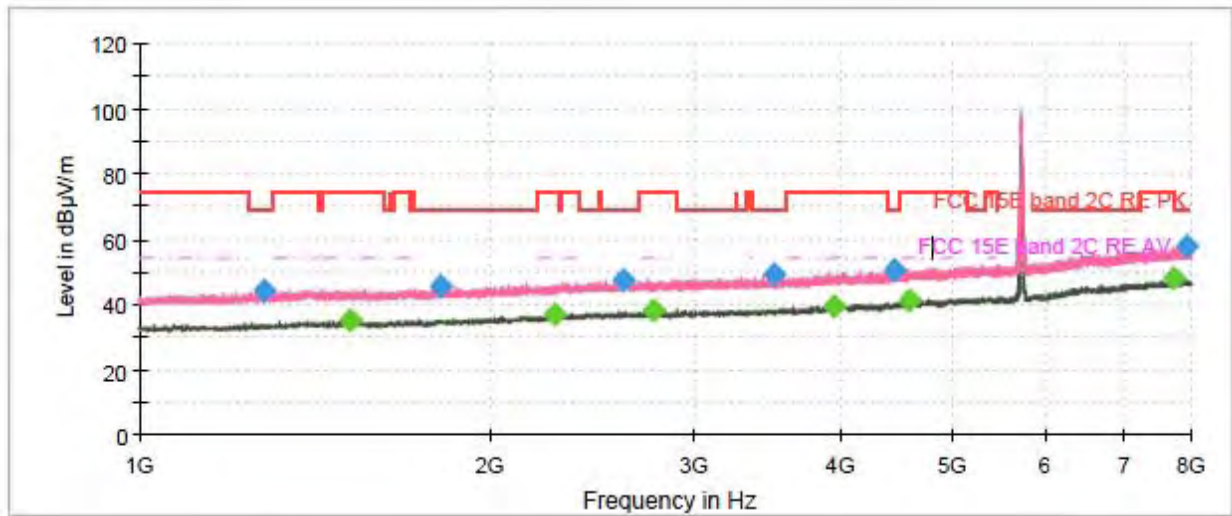

Radiates Emission from 1GHz to 8GHz
 Note: The signal beyond the limit is carrier.

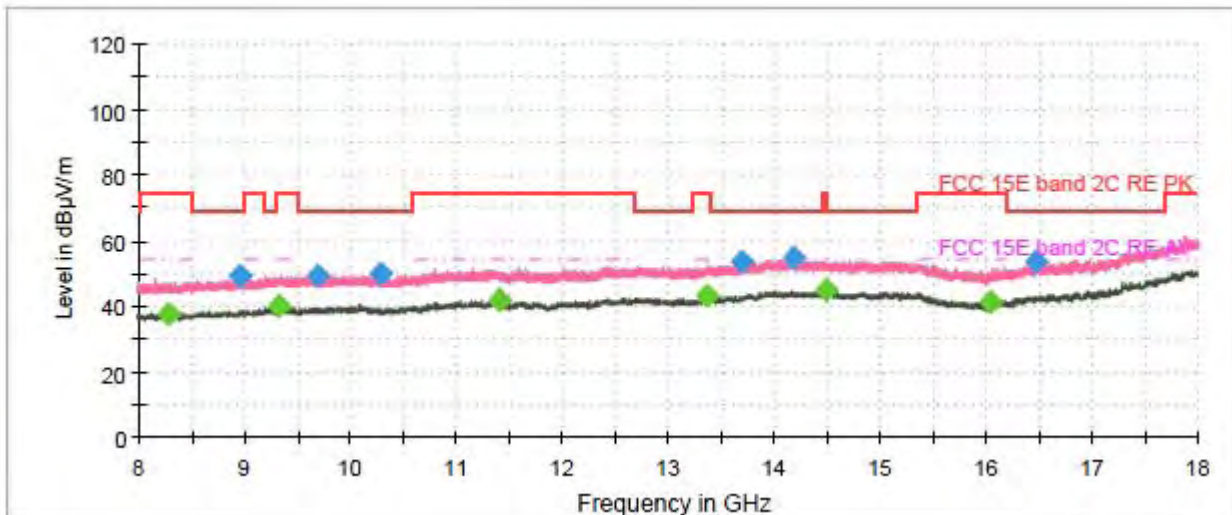

Radiates Emission from 8GHz to 18GHz



Frequency (MHz)	Peak (dBuV/m)	Average (dBuV/m)	Limit (dBuV/m)	Margin (dB)	Height (cm)	Polarization	Azimuth (deg)	Correct Factor (dB)
1277.433333	44.10	---	68.20	24.10	100.0	H	0.0	-10.1
1514.500000	---	35.36	54.00	18.64	200.0	H	0.0	-9.1
1811.066667	45.80	---	68.20	22.40	100.0	V	12.0	-8.8
2270.266667	---	37.09	54.00	16.91	200.0	V	212.0	-7.0
2600.200000	47.68	---	68.20	20.52	100.0	V	21.0	-6.1
2766.800000	---	38.22	54.00	15.78	200.0	V	335.0	-6.1
3500.400000	49.37	---	68.20	18.83	100.0	H	282.0	-4.8
3953.300000	---	39.67	54.00	14.33	100.0	H	0.0	-3.2
4444.700000	50.22	---	68.20	17.98	200.0	V	0.0	-1.6
4574.200000	---	41.02	54.00	12.98	200.0	V	335.0	-1.0
7718.133333	---	48.19	54.00	5.81	200.0	V	142.0	7.0
7933.266667	57.58	---	68.20	10.62	100.0	H	359.0	7.5

Remark: 1. Correction Factor = Antenna factor+ Insertion loss (cable loss + amplifier gain)

802.11n (HT40) CH38

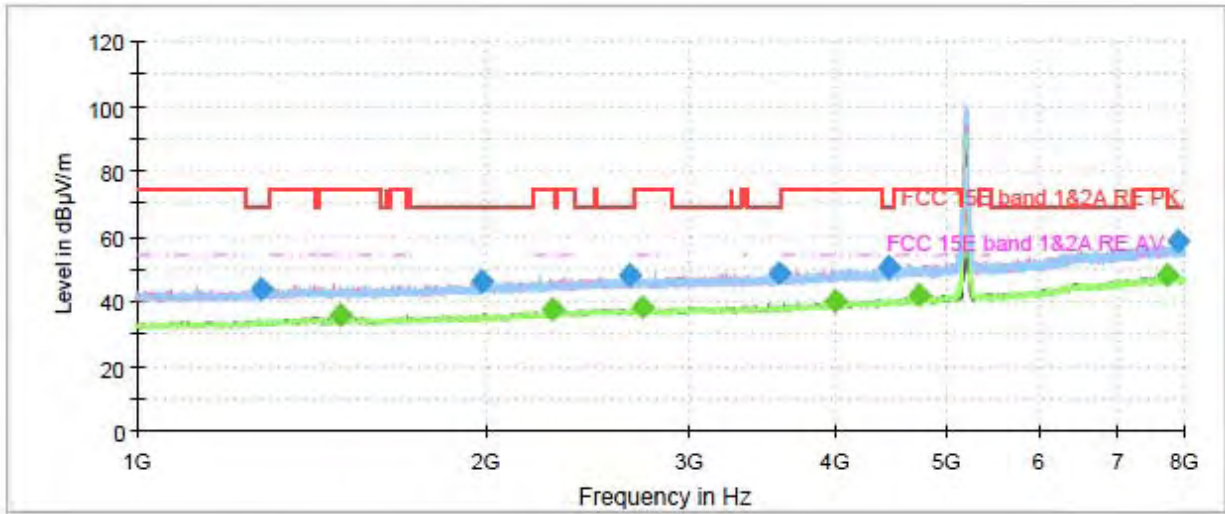

Radiates Emission from 1GHz to 8GHz
 Note: The signal beyond the limit is carrier.

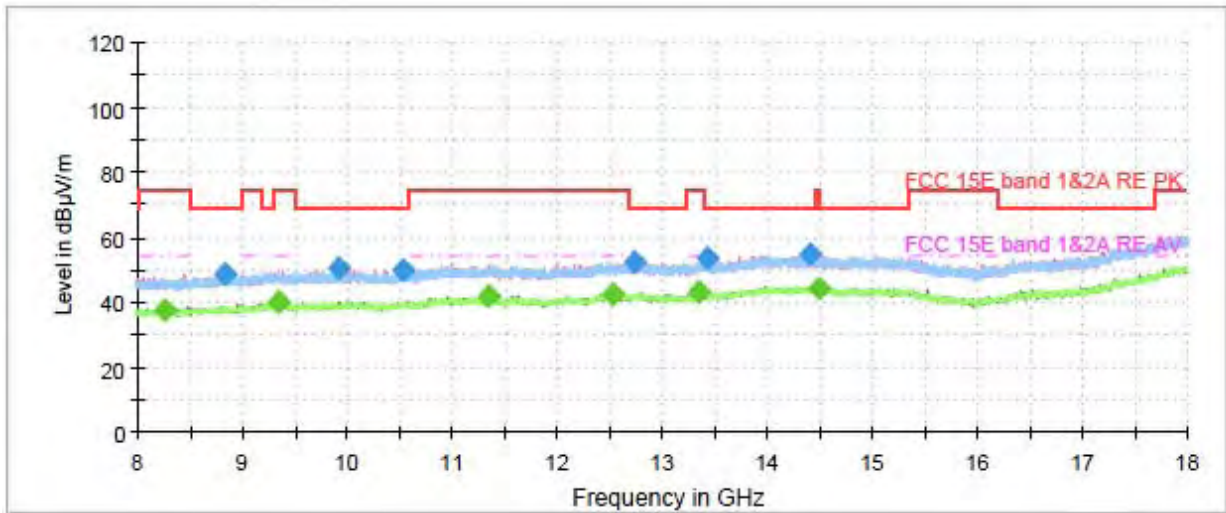

Radiates Emission from 8GHz to 18GHz



Frequency (MHz)	Peak (dBuV/m)	Average (dBuV/m)	Limit (dBuV/m)	Margin (dB)	Height (cm)	Polarization	Azimuth (deg)	Correct Factor (dB)
1279.766667	43.96	---	68.20	24.24	200.0	V	0.0	-10.0
1498.866667	---	35.46	54.00	18.54	200.0	H	231.0	-9.2
1985.366667	45.86	---	68.20	22.34	200.0	V	0.0	-8.0
2284.033333	---	37.51	54.00	16.50	100.0	V	310.0	-6.9
2659.933333	47.72	---	68.20	20.48	100.0	H	190.0	-6.0
2728.066667	---	38.09	54.00	15.91	100.0	V	357.0	-6.1
3573.900000	48.64	---	68.20	19.56	100.0	V	323.0	-4.6
3998.800000	---	39.91	54.00	14.09	200.0	H	218.0	-2.9
4458.000000	50.44	---	68.20	17.76	200.0	H	346.0	-1.5
4726.800000	---	41.96	54.00	12.04	200.0	V	49.0	-0.4
7747.300000	---	48.05	54.00	5.95	100.0	H	22.0	7.0
7901.066667	58.22	---	68.20	9.98	100.0	V	296.0	7.4

Remark: 1. Correction Factor = Antenna factor+ Insertion loss (cable loss + amplifier gain)

802.11n (HT40) CH46

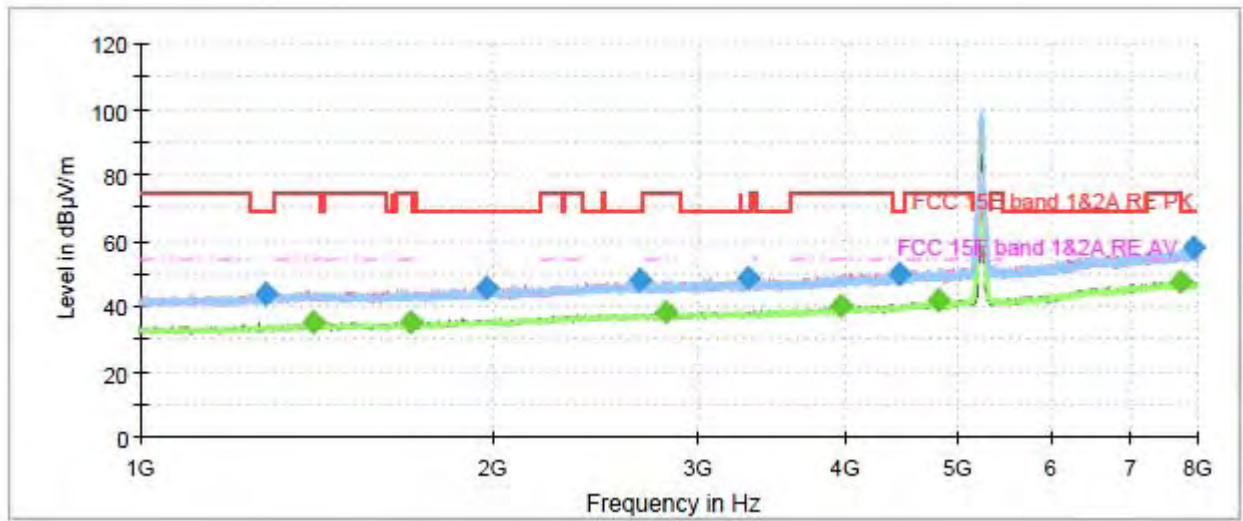

Radiates Emission from 1GHz to 8GHz
 Note: The signal beyond the limit is carrier.

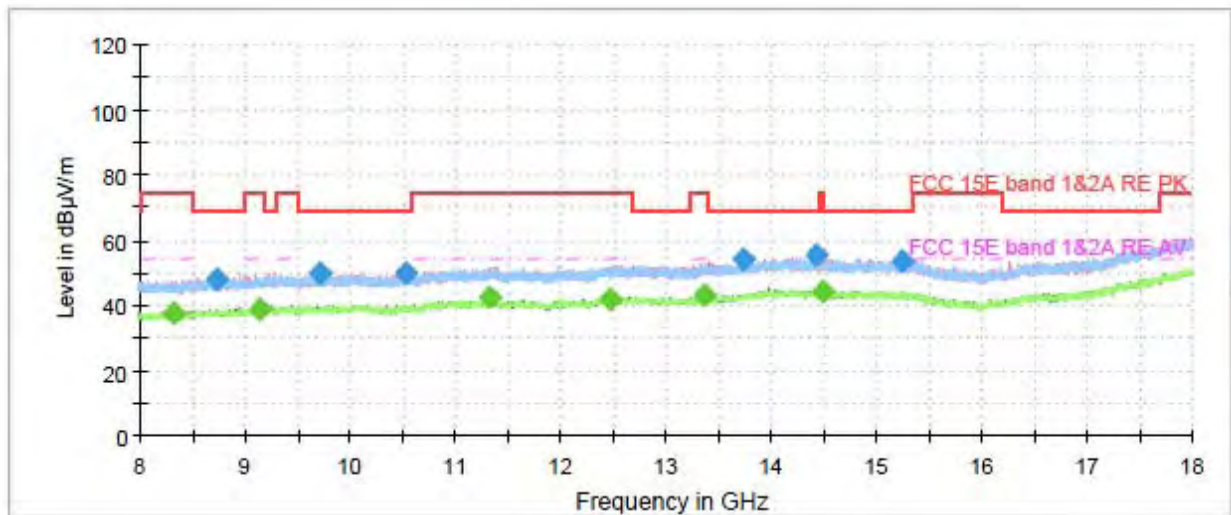

Radiates Emission from 8GHz to 18GHz



Frequency (MHz)	Peak (dBuV/m)	Average (dBuV/m)	Limit (dBuV/m)	Margin (dB)	Height (cm)	Polarization	Azimuth (deg)	Correct Factor (dB)
1278.133333	43.78	---	68.20	24.42	200.0	H	268.0	-10.1
1404.366667	---	35.22	54.00	18.78	100.0	V	326.0	-9.3
1700.933333	---	35.15	54.00	18.85	200.0	H	344.0	-8.8
1975.800000	45.63	---	68.20	22.57	100.0	H	8.0	-8.1
2665.066667	48.09	---	68.20	20.11	100.0	V	134.0	-6.0
2810.900000	---	38.21	54.00	15.79	200.0	V	217.0	-6.0
3298.800000	48.90	---	68.20	19.30	200.0	H	131.0	-5.1
3968.933333	---	39.77	54.00	14.23	200.0	H	12.0	-3.1
4452.166667	49.68	---	68.20	18.52	200.0	H	309.0	-1.6
4797.266667	---	41.82	54.00	12.18	200.0	V	106.0	-0.3
7740.066667	---	47.67	54.00	6.33	200.0	V	318.0	7.0
7919.033333	58.02	---	68.20	10.18	200.0	V	189.0	7.4

Remark: 1. Correction Factor = Antenna factor+ Insertion loss (cable loss + amplifier gain)

802.11n (HT40) CH54

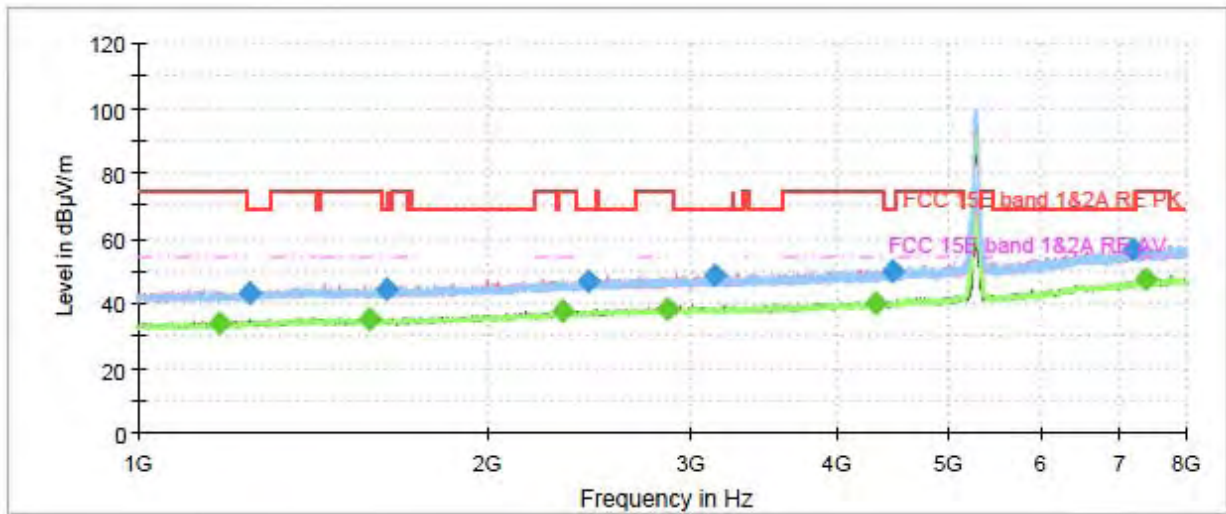

Radiates Emission from 1GHz to 8GHz
Note: The signal beyond the limit is carrier.

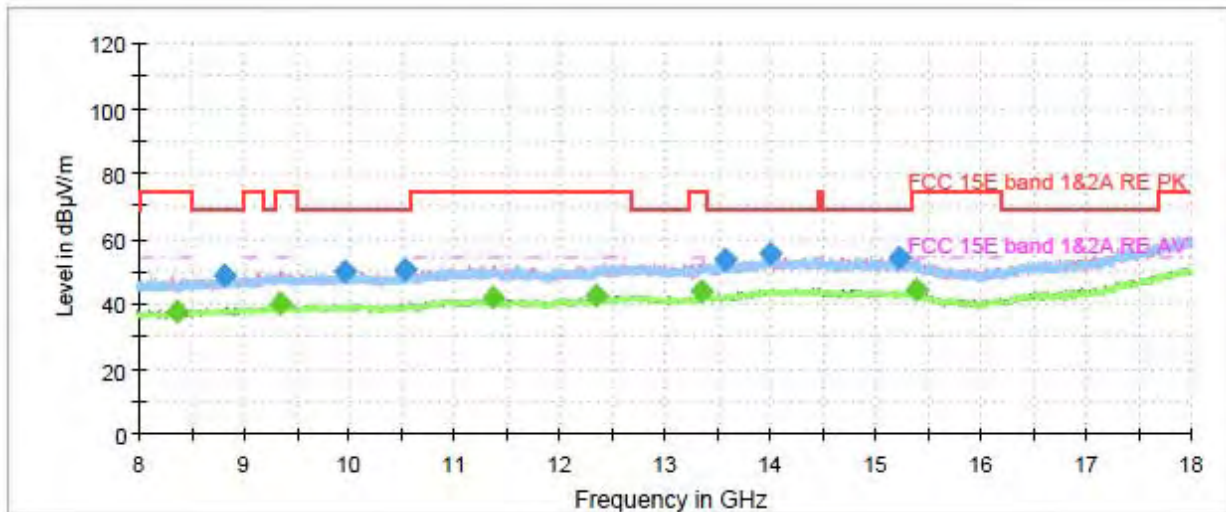

Radiates Emission from 8GHz to 18GHz



Frequency (MHz)	Peak (dBuV/m)	Average (dBuV/m)	Limit (dBuV/m)	Margin (dB)	Height (cm)	Polarization	Azimuth (deg)	Correct Factor (dB)
1176.166667	---	33.64	54.00	20.36	100.0	V	268.0	-10.7
1246.866667	43.02	---	68.20	25.18	200.0	V	1.0	-10.2
1583.333333	---	35.16	54.00	18.84	100.0	V	324.0	-9.1
1637.466667	44.20	---	68.20	24.00	100.0	V	359.0	-9.0
2324.400000	---	37.43	54.00	16.57	100.0	H	60.0	-6.8
2443.400000	46.74	---	68.20	21.46	200.0	V	0.0	-6.5
2859.433333	---	37.89	54.00	16.11	100.0	V	355.0	-6.0
3135.466667	48.53	---	68.20	19.67	100.0	H	8.0	-5.5
4323.366667	---	40.11	54.00	13.89	200.0	V	244.0	-2.2
4460.800000	49.78	---	68.20	18.42	200.0	V	115.0	-1.5
7206.433333	56.48	---	68.20	11.72	200.0	V	88.0	6.3
7378.400000	---	47.36	54.00	6.64	200.0	V	5.0	6.7

Remark: 1. Correction Factor = Antenna factor+ Insertion loss (cable loss + amplifier gain)

802.11n (HT40) CH2

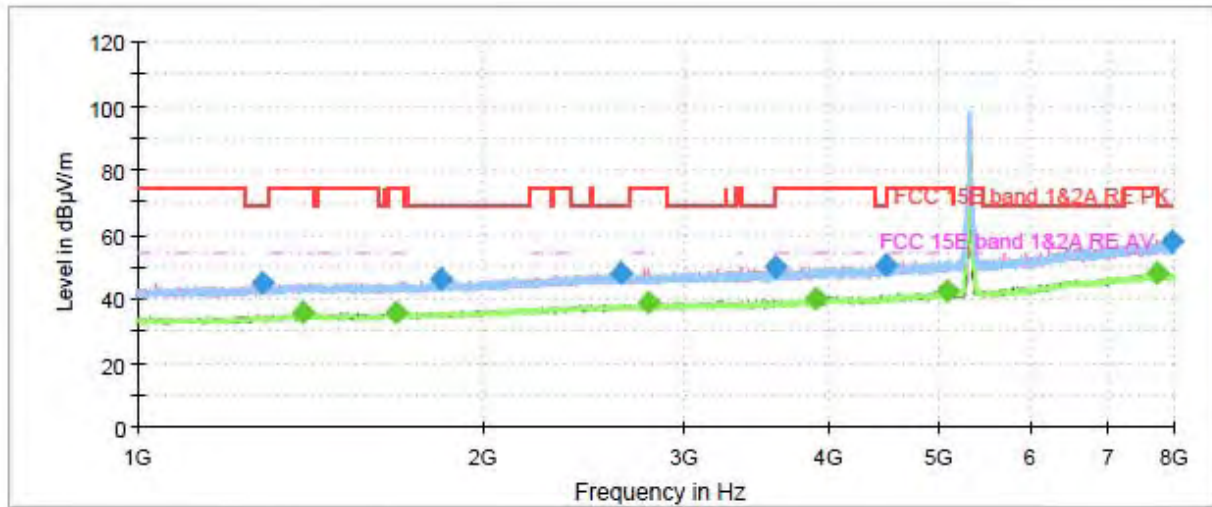

Radiates Emission from 1GHz to 8GHz
 Note: The signal beyond the limit is carrier.

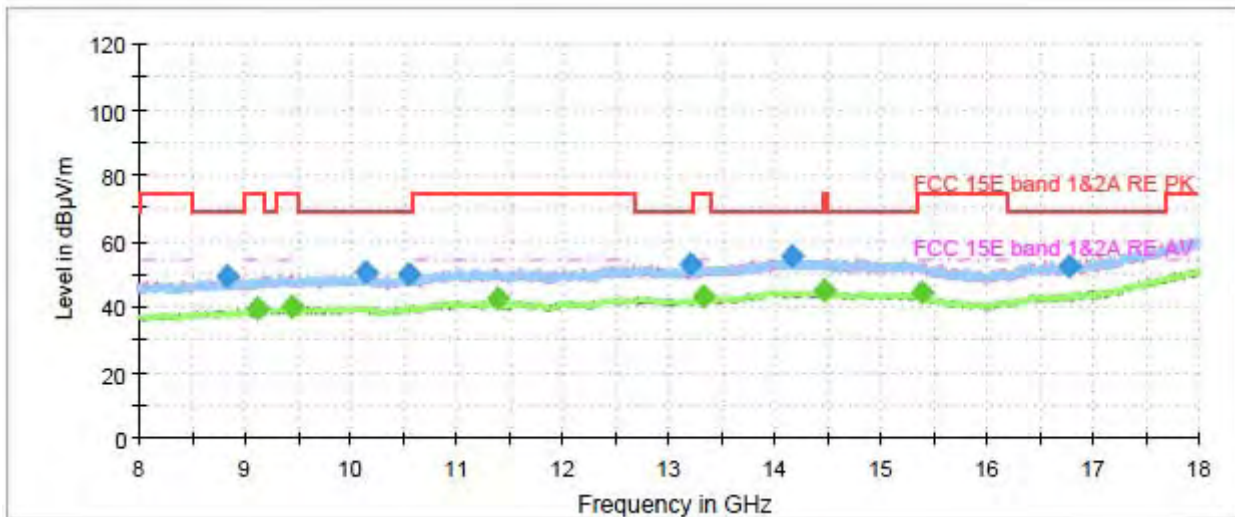

Radiates Emission from 8GHz to 18GHz



Frequency (MHz)	Peak (dBuV/m)	Average (dBuV/m)	Limit (dBuV/m)	Margin (dB)	Height (cm)	Polarization	Azimuth (deg)	Correct Factor (dB)
1285.600000	44.87	---	68.20	23.33	100.0	V	325.0	-10.0
1391.766667	---	35.55	54.00	18.45	100.0	H	349.0	-9.4
1682.966667	---	35.91	54.00	18.09	200.0	H	312.0	-8.9
1839.300000	46.38	---	68.20	21.82	100.0	V	0.0	-8.6
2635.666667	48.18	---	68.20	20.02	200.0	H	257.0	-6.1
2782.900000	---	38.66	54.00	15.34	100.0	H	99.0	-6.1
3590.466667	49.57	---	68.20	18.63	200.0	H	28.0	-4.5
3905.700000	---	40.14	54.00	13.86	200.0	H	146.0	-3.4
4488.800000	50.63	---	68.20	17.57	200.0	V	213.0	-1.4
5079.833333	---	42.57	54.00	11.43	200.0	H	2.0	0.7
7734.000000	---	48.06	54.00	5.94	200.0	H	358.0	7.0
7952.633333	57.85	---	68.20	10.35	100.0	H	20.0	7.6

Remark: 1. Correction Factor = Antenna factor+ Insertion loss (cable loss + amplifier gain)

802.11n (HT40) CH102

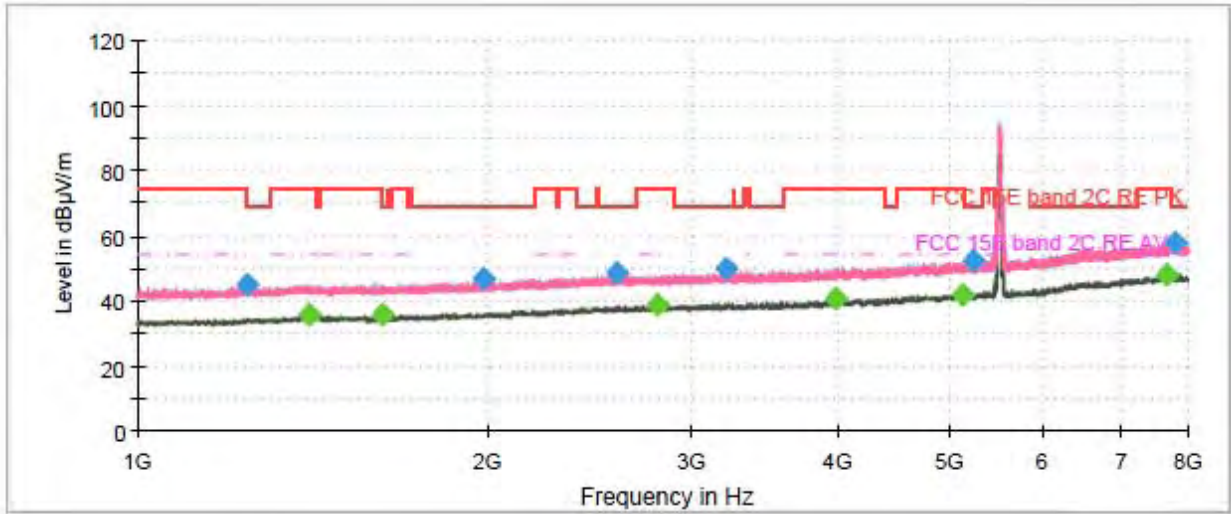

Radiates Emission from 1GHz to 8GHz
 Note: The signal beyond the limit is carrier.

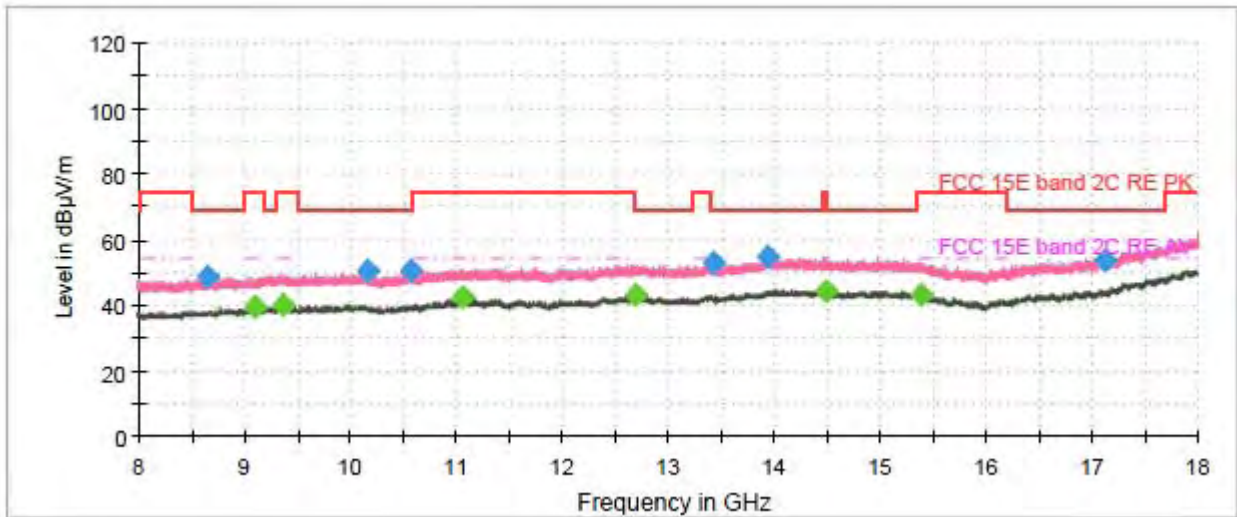

Radiates Emission from 8GHz to 18GHz



Frequency (MHz)	Peak (dBuV/m)	Average (dBuV/m)	Limit (dBuV/m)	Margin (dB)	Height (cm)	Polarization	Azimuth (deg)	Correct Factor (dB)
1242.200000	45.19	---	68.20	23.01	200.0	H	188.0	-10.2
1408.100000	---	35.70	54.00	18.30	100.0	H	0.0	-9.3
1624.866667	---	35.75	54.00	18.25	200.0	H	0.0	-9.0
1986.300000	46.66	---	68.20	21.54	200.0	V	312.0	-8.0
2576.633333	48.84	---	68.20	19.36	200.0	H	244.0	-6.1
2804.366667	---	38.71	54.00	15.29	200.0	H	174.0	-6.0
3212.233333	49.81	---	68.20	18.39	100.0	H	352.0	-5.2
3988.066667	---	40.39	54.00	13.61	100.0	H	0.0	-3.0
5114.833333	---	41.89	54.00	12.11	200.0	V	355.0	0.8
5226.833333	52.33	---	68.20	15.87	200.0	V	215.0	1.0
7679.633333	---	48.11	54.00	5.89	100.0	H	245.0	7.0
7800.033333	57.70	---	68.20	10.50	100.0	H	273.0	7.0

Remark: 1. Correction Factor = Antenna factor+ Insertion loss (cable loss + amplifier gain)

802.11n (HT40) CH118

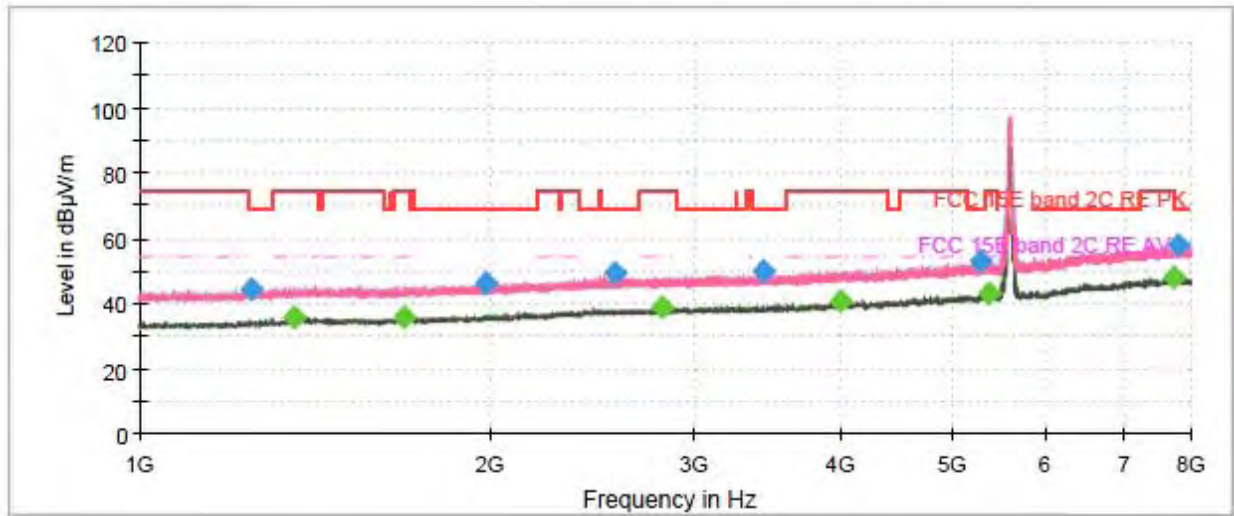

Radiates Emission from 1GHz to 8GHz
 Note: The signal beyond the limit is carrier.

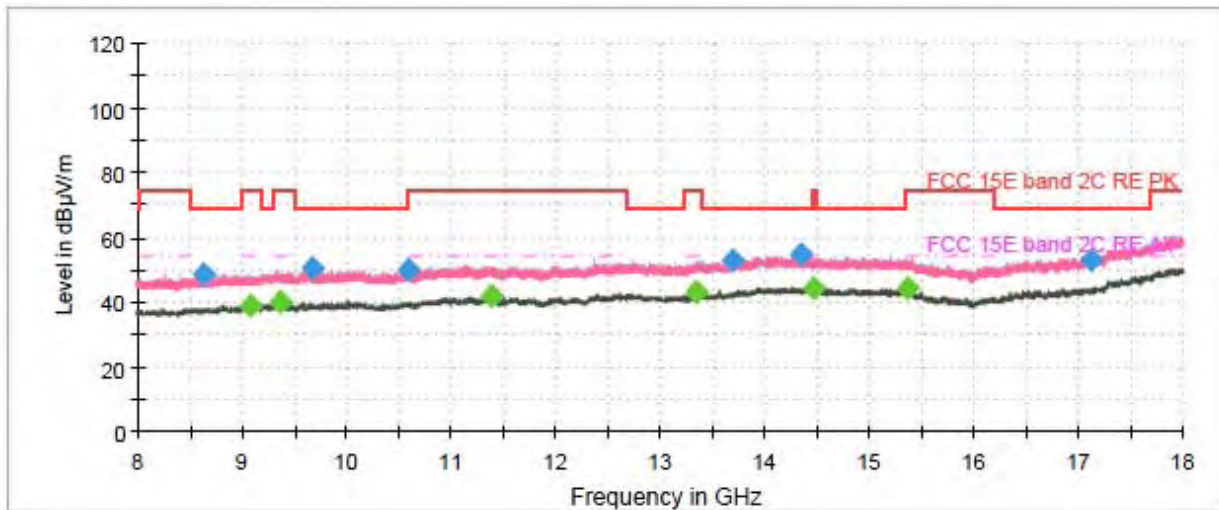

Radiates Emission from 8GHz to 18GHz



Frequency (MHz)	Peak (dBuV/m)	Average (dBuV/m)	Limit (dBuV/m)	Margin (dB)	Height (cm)	Polarization	Azimuth (deg)	Correct Factor (dB)
1247.566667	44.48	---	68.20	23.72	200.0	H	4.0	-10.2
1356.533333	---	35.87	54.00	18.13	100.0	H	241.0	-9.5
1689.733333	---	35.93	54.00	18.07	100.0	H	0.0	-8.9
1982.800000	46.13	---	68.20	22.07	200.0	H	4.0	-8.0
2557.500000	49.10	---	68.20	19.10	100.0	V	5.0	-6.2
2811.133333	---	38.91	54.00	15.09	200.0	V	356.0	-6.0
3430.633333	50.07	---	68.20	18.13	200.0	H	118.0	-4.9
3996.233333	---	40.77	54.00	13.23	200.0	V	347.0	-2.9
5273.733333	52.73	---	68.20	15.47	200.0	H	161.0	1.1
5372.200000	---	43.25	54.00	10.75	200.0	V	204.0	1.4
7733.766667	---	47.86	54.00	6.14	200.0	V	327.0	7.0
7810.533333	57.89	---	68.20	10.31	200.0	V	273.0	7.0

Remark: 1. Correction Factor = Antenna factor+ Insertion loss (cable loss + amplifier gain)

802.11n (HT40) CH134

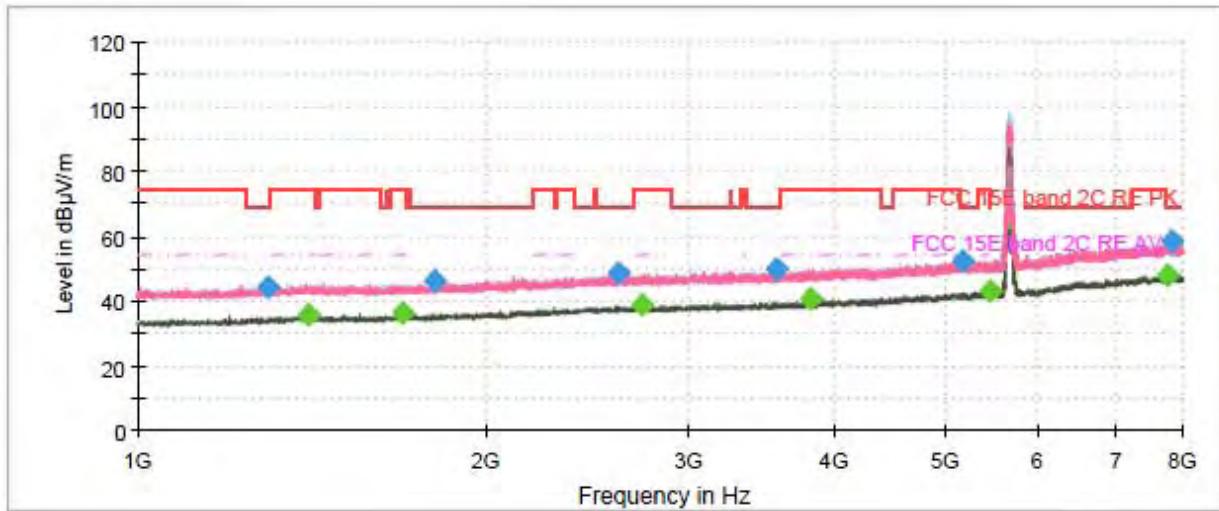

Radiates Emission from 1GHz to 8GHz
 Note: The signal beyond the limit is carrier.

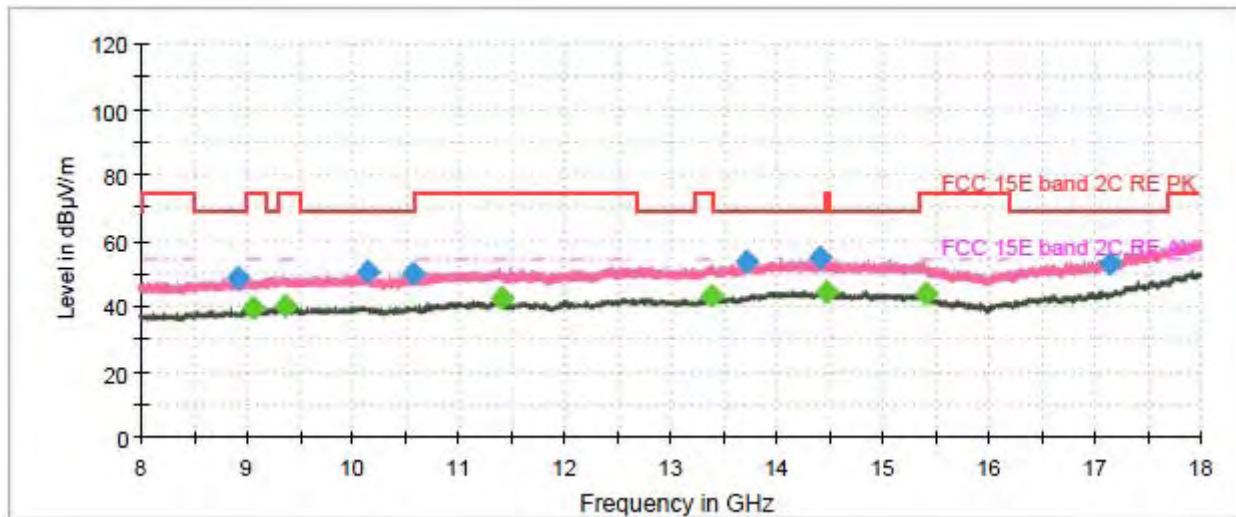

Radiates Emission from 8GHz to 18GHz



Frequency (MHz)	Peak (dBuV/m)	Average (dBuV/m)	Limit (dBuV/m)	Margin (dB)	Height (cm)	Polarization	Azimuth (deg)	Correct Factor (dB)
1296.333333	44.55	---	68.20	23.65	100.0	V	102.0	-9.9
1404.600000	---	35.71	54.00	18.29	200.0	V	256.0	-9.3
1691.133333	---	36.16	54.00	17.84	100.0	V	5.0	-8.9
1804.066667	45.98	---	68.20	22.22	100.0	H	309.0	-8.8
2606.966667	48.48	---	68.20	19.72	100.0	V	5.0	-6.1
2733.200000	---	38.92	54.00	15.08	100.0	V	243.0	-6.1
3568.533333	49.67	---	68.20	18.53	200.0	V	298.0	-4.6
3821.933333	---	40.82	54.00	13.18	100.0	H	73.0	-3.8
5157.066667	52.50	---	68.20	15.70	100.0	V	214.0	0.9
5454.333333	---	42.79	54.00	11.21	100.0	H	268.0	1.4
7749.866667	---	47.95	54.00	6.05	200.0	V	242.0	7.0
7824.766667	58.29	---	68.20	9.91	100.0	V	0.0	7.0

Remark: 1. Correction Factor = Antenna factor+ Insertion loss (cable loss + amplifier gain)

802.11n (HT40) CH142

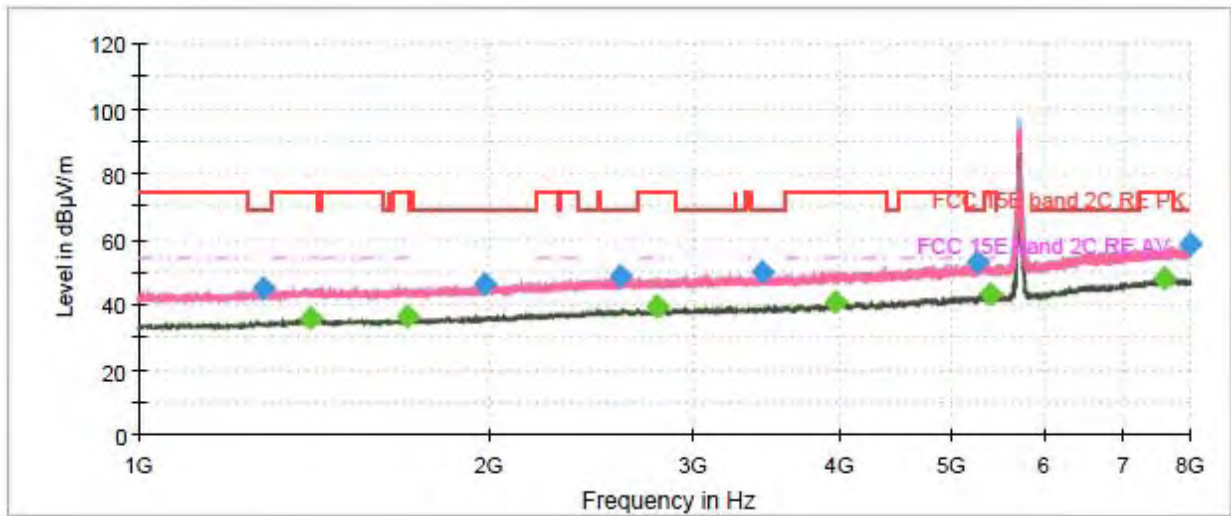

Radiates Emission from 1GHz to 8GHz
 Note: The signal beyond the limit is carrier.

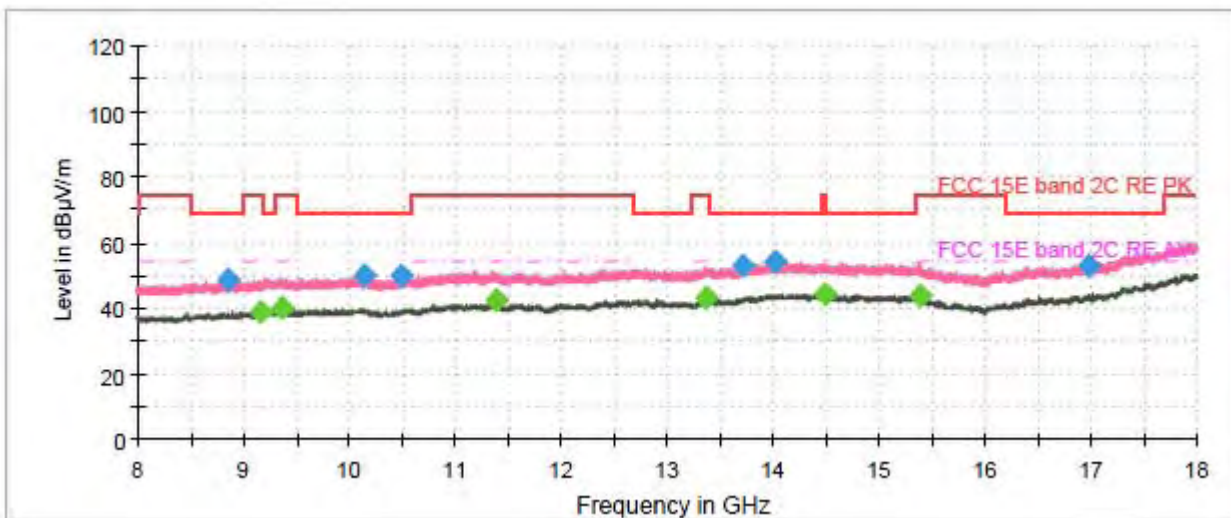

Radiates Emission from 8GHz to 18GHz



Frequency (MHz)	Peak (dBuV/m)	Average (dBuV/m)	Limit (dBuV/m)	Margin (dB)	Height (cm)	Polarization	Azimuth (deg)	Correct Factor (dB)
1281.866667	45.17	---	68.20	23.03	100.0	V	287.0	-10.0
1404.133333	---	35.70	54.00	18.30	100.0	V	5.0	-9.3
1704.200000	---	36.07	54.00	17.93	100.0	V	1.0	-8.8
1981.400000	45.94	---	68.20	22.26	200.0	V	132.0	-8.0
2589.700000	48.33	---	68.20	19.87	100.0	V	201.0	-6.1
2784.300000	---	39.35	54.00	14.65	200.0	H	171.0	-6.0
3436.233333	49.72	---	68.20	18.48	200.0	H	286.0	-4.9
3966.600000	---	40.45	54.00	13.55	200.0	V	276.0	-3.1
5253.433333	52.81	---	68.20	15.39	200.0	V	174.0	1.0
5392.266667	---	42.77	54.00	11.23	100.0	H	342.0	1.4
7596.333333	---	48.15	54.00	5.85	200.0	H	184.0	7.0
7994.400000	58.34	---	68.20	9.86	200.0	V	354.0	7.6

Remark: 1. Correction Factor = Antenna factor+ Insertion loss (cable loss + amplifier gain)

802.11ac (VHT20) CH36

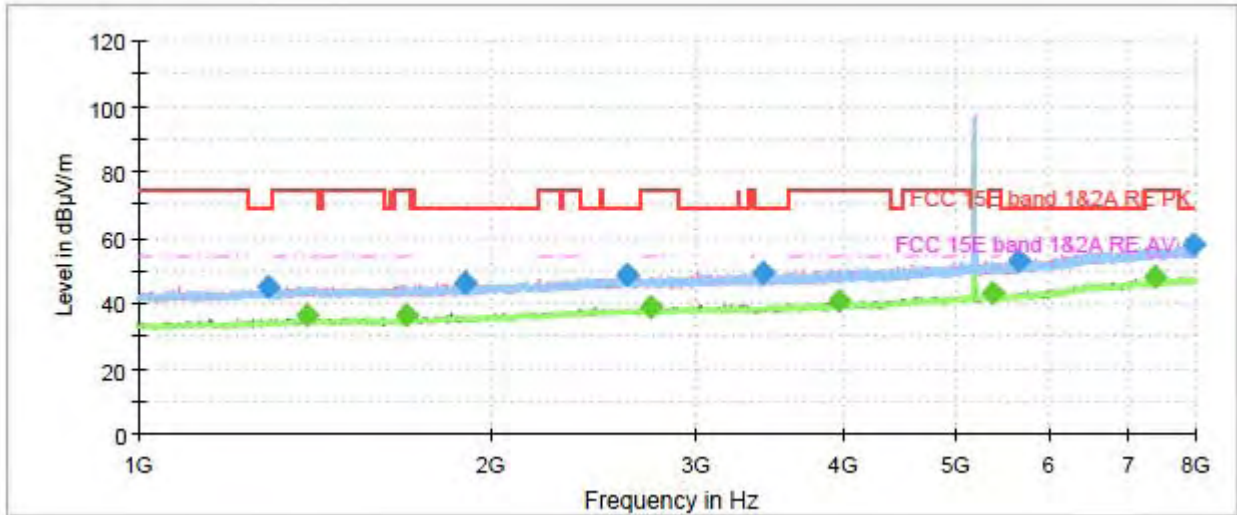

Radiates Emission from 1GHz to 8GHz
 Note: The signal beyond the limit is carrier.

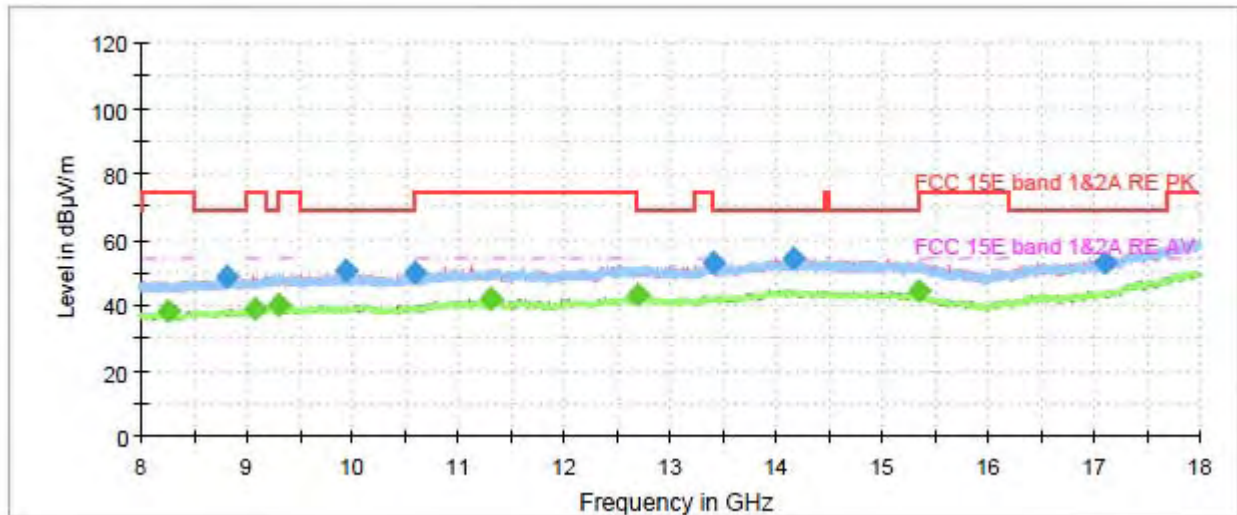

Radiates Emission from 8GHz to 18GHz



Frequency (MHz)	Peak (dBuV/m)	Average (dBuV/m)	Limit (dBuV/m)	Margin (dB)	Height (cm)	Polarization	Azimuth (deg)	Correct Factor (dB)
1288.166667	45.03	---	68.20	23.17	100.0	H	47.0	-10.0
1396.200000	---	36.35	54.00	17.65	200.0	V	86.0	-9.4
1692.533333	---	36.08	54.00	17.92	200.0	H	144.0	-8.9
1898.566667	46.36	---	68.20	21.84	100.0	H	34.0	-8.4
2619.100000	48.64	---	68.20	19.56	100.0	H	118.0	-6.1
2735.066667	---	38.66	54.00	15.34	200.0	H	214.0	-6.1
3419.200000	49.40	---	68.20	18.80	100.0	H	90.0	-4.9
3965.200000	---	40.52	54.00	13.48	100.0	H	90.0	-3.1
5360.533333	---	42.86	54.00	11.14	200.0	H	301.0	1.4
5654.766667	52.69	---	68.20	15.51	200.0	V	349.0	2.0
7373.500000	---	47.95	54.00	6.05	200.0	V	72.0	6.7
7958.700000	57.66	---	68.20	10.54	200.0	V	142.0	7.6

Remark: 1. Correction Factor = Antenna factor+ Insertion loss (cable loss + amplifier gain)

802.11ac (VHT20) CH40

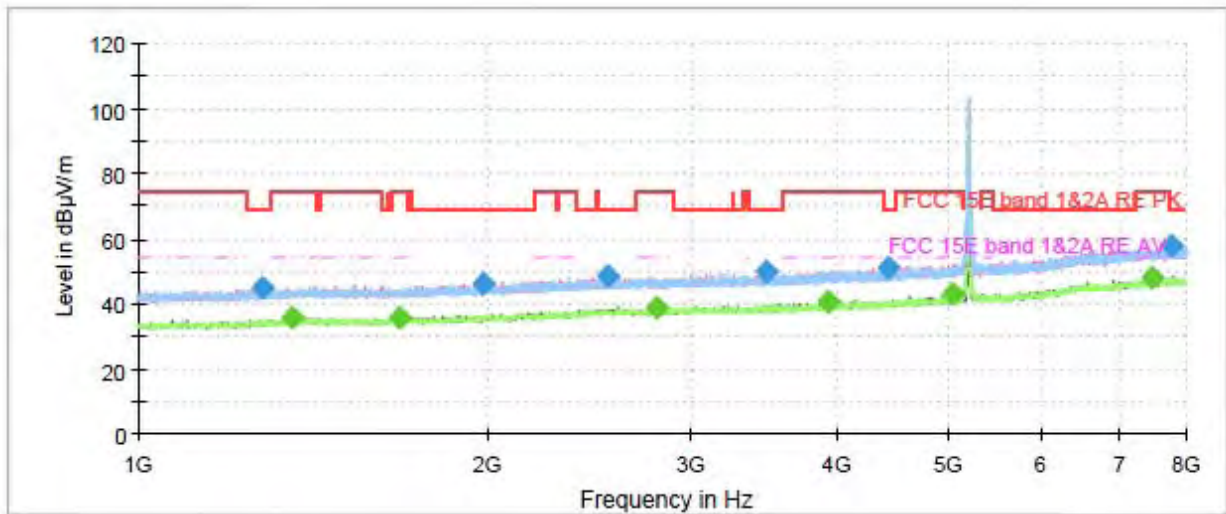

Radiates Emission from 1GHz to 8GHz
 Note: The signal beyond the limit is carrier.

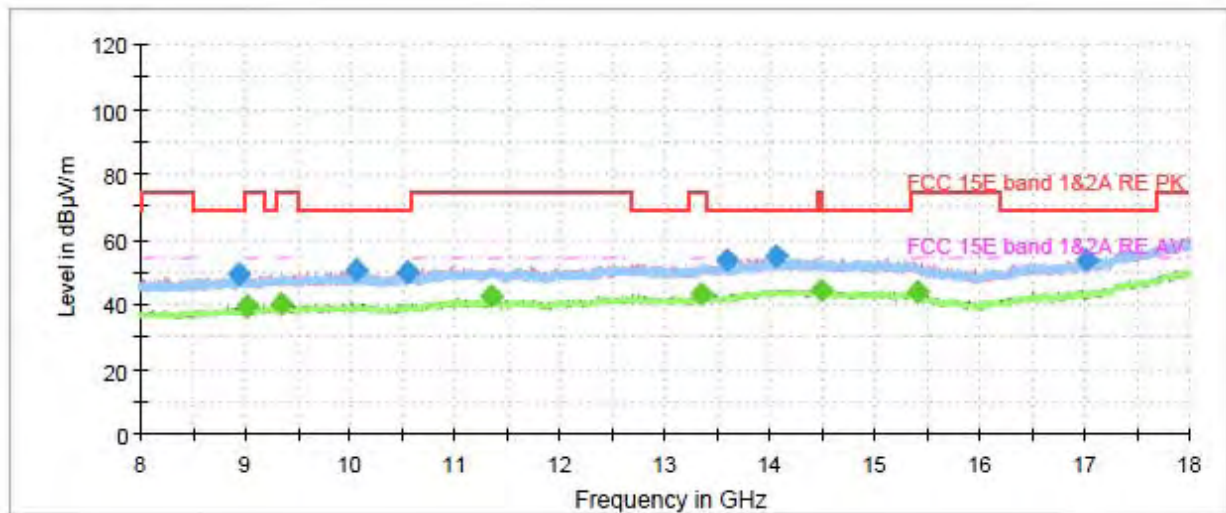

Radiates Emission from 8GHz to 18GHz



Frequency (MHz)	Peak (dBuV/m)	Average (dBuV/m)	Limit (dBuV/m)	Margin (dB)	Height (cm)	Polarization	Azimuth (deg)	Correct Factor (dB)
1282.100000	44.76	---	68.20	23.44	200.0	V	3.0	-10.0
1360.033333	---	35.86	54.00	18.14	100.0	V	192.0	-9.5
1678.066667	---	35.80	54.00	18.20	200.0	H	206.0	-9.0
1981.633333	46.45	---	68.20	21.75	200.0	V	15.0	-8.0
2536.033333	48.76	---	68.20	19.44	200.0	V	334.0	-6.2
2799.466667	---	38.66	54.00	15.34	100.0	H	5.0	-6.0
3470.533333	49.91	---	68.20	18.29	200.0	V	302.0	-4.9
3924.833333	---	40.52	54.00	13.48	200.0	V	244.0	-3.3
4428.366667	50.83	---	68.20	17.37	100.0	V	192.0	-1.7
5029.666667	---	43.03	54.00	10.97	200.0	V	349.0	0.5
7461.000000	---	48.21	54.00	5.79	100.0	V	248.0	6.9
7779.500000	57.79	---	68.20	10.41	100.0	V	330.0	7.0

Remark: 1. Correction Factor = Antenna factor+ Insertion loss (cable loss + amplifier gain)

802.11ac (VHT20) CH48

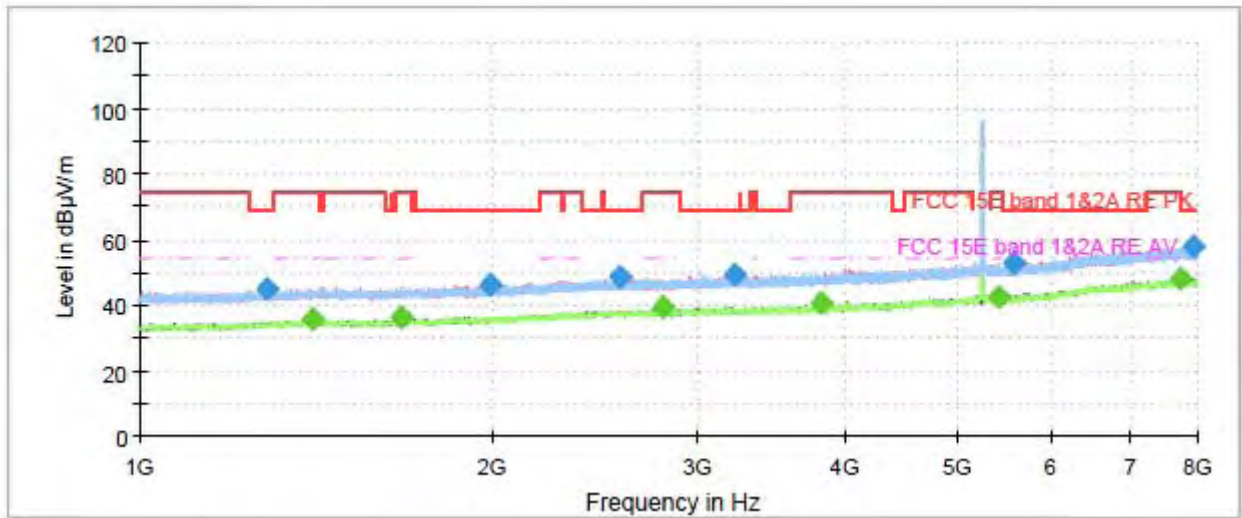

Radiates Emission from 1GHz to 8GHz
 Note: The signal beyond the limit is carrier.

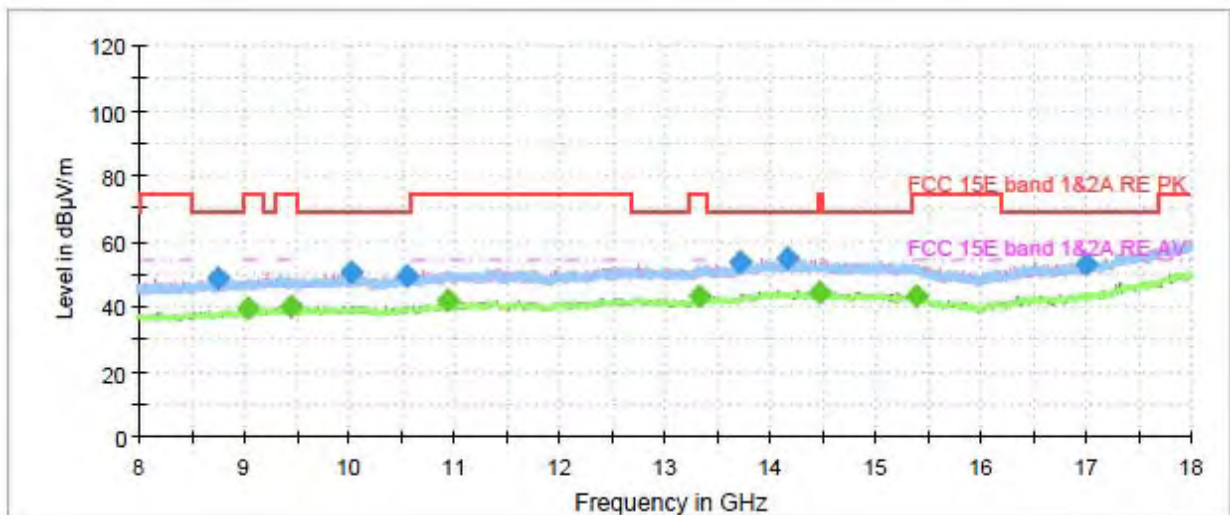

Radiates Emission from 8GHz to 18GHz



Frequency (MHz)	Peak (dBuV/m)	Average (dBuV/m)	Limit (dBuV/m)	Margin (dB)	Height (cm)	Polarization	Azimuth (deg)	Correct Factor (dB)
1284.900000	44.81	---	68.20	23.39	200.0	H	111.0	-10.0
1405.533333	---	35.84	54.00	18.16	100.0	H	273.0	-9.3
1674.800000	---	36.07	54.00	17.93	200.0	H	4.0	-9.0
1988.866667	46.23	---	68.20	21.97	200.0	H	0.0	-8.0
2567.300000	48.84	---	68.20	19.36	100.0	V	0.0	-6.2
2800.400000	---	39.25	54.00	14.75	100.0	V	230.0	-6.0
3218.066667	49.41	---	68.20	18.79	200.0	H	154.0	-5.1
3814.000000	---	40.51	54.00	13.49	200.0	V	355.0	-3.8
5419.333333	---	42.64	54.00	11.36	200.0	V	129.0	1.4
5562.600000	53.03	---	68.20	15.17	100.0	V	24.0	1.7
7743.566667	---	48.05	54.00	5.95	200.0	H	154.0	7.0
7925.100000	58.01	---	68.20	10.19	100.0	H	314.0	7.5

Remark: 1. Correction Factor = Antenna factor+ Insertion loss (cable loss + amplifier gain)

802.11ac (VHT20) CH52

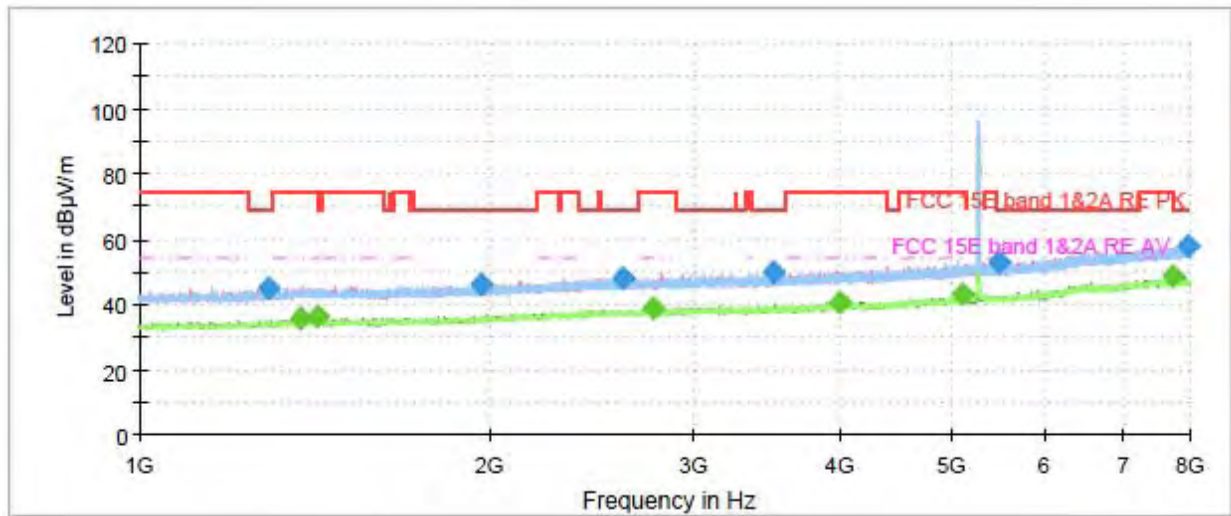

Radiates Emission from 1GHz to 8GHz
 Note: The signal beyond the limit is carrier.

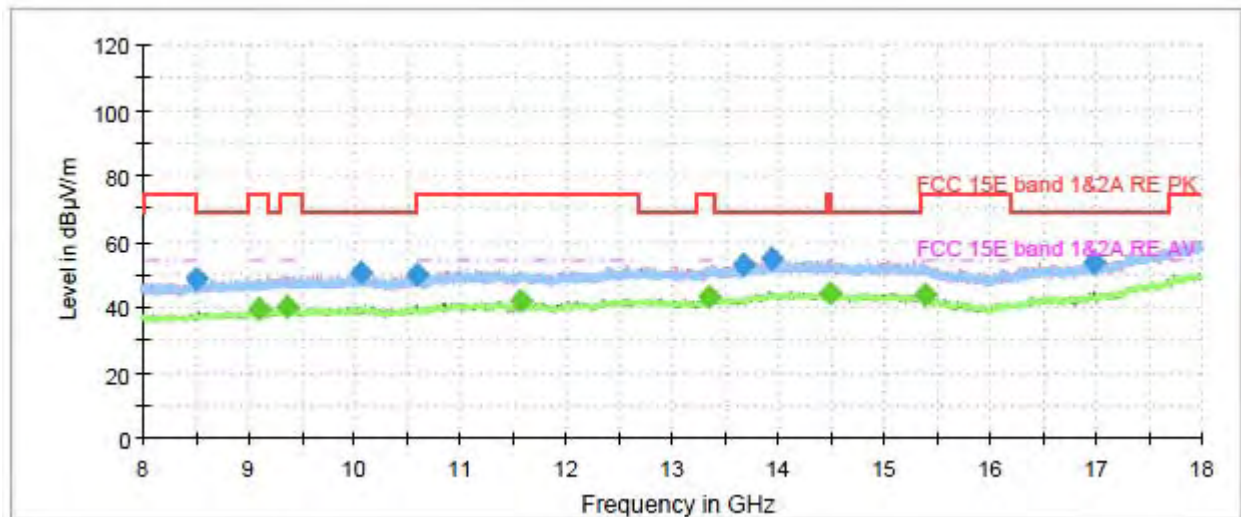

Radiates Emission from 8GHz to 18GHz



Frequency (MHz)	Peak (dBuV/m)	Average (dBuV/m)	Limit (dBuV/m)	Margin (dB)	Height (cm)	Polarization	Azimuth (deg)	Correct Factor (dB)
1288.866667	44.68	---	68.20	23.52	200.0	H	127.0	-9.9
1378.000000	---	35.94	54.00	18.06	200.0	H	169.0	-9.5
1425.600000	---	36.26	54.00	17.74	200.0	V	173.0	-9.1
1964.366667	46.23	---	68.20	21.97	200.0	V	310.0	-8.2
2603.933333	48.23	---	68.20	19.97	100.0	V	198.0	-6.1
2765.400000	---	38.89	54.00	15.11	100.0	V	4.0	-6.1
3502.500000	49.67	---	68.20	18.53	100.0	V	12.0	-4.8
3999.733333	---	40.64	54.00	13.36	200.0	V	144.0	-2.9
5093.366667	---	42.79	54.00	11.21	200.0	H	303.0	0.8
5473.466667	52.99	---	68.20	15.21	100.0	V	141.0	1.4
7744.266667	---	48.70	54.00	5.30	200.0	V	336.0	7.0
7955.433333	57.89	---	68.20	10.32	100.0	H	340.0	7.6

Remark: 1. Correction Factor = Antenna factor+ Insertion loss (cable loss + amplifier gain)

802.11ac (HT20) CH60

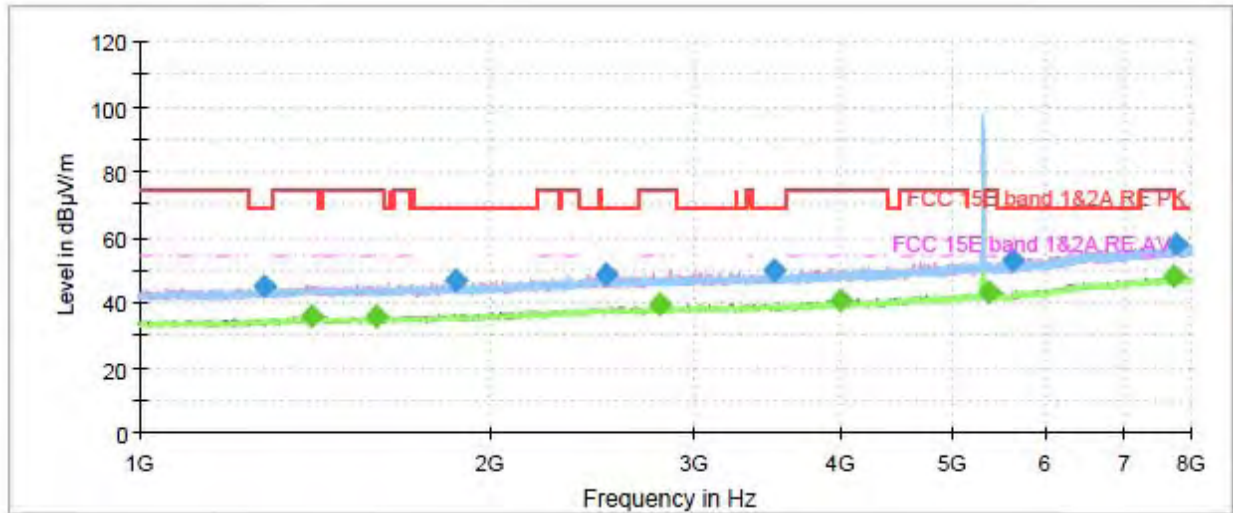

Radiates Emission from 1GHz to 8GHz
 Note: The signal beyond the limit is carrier.

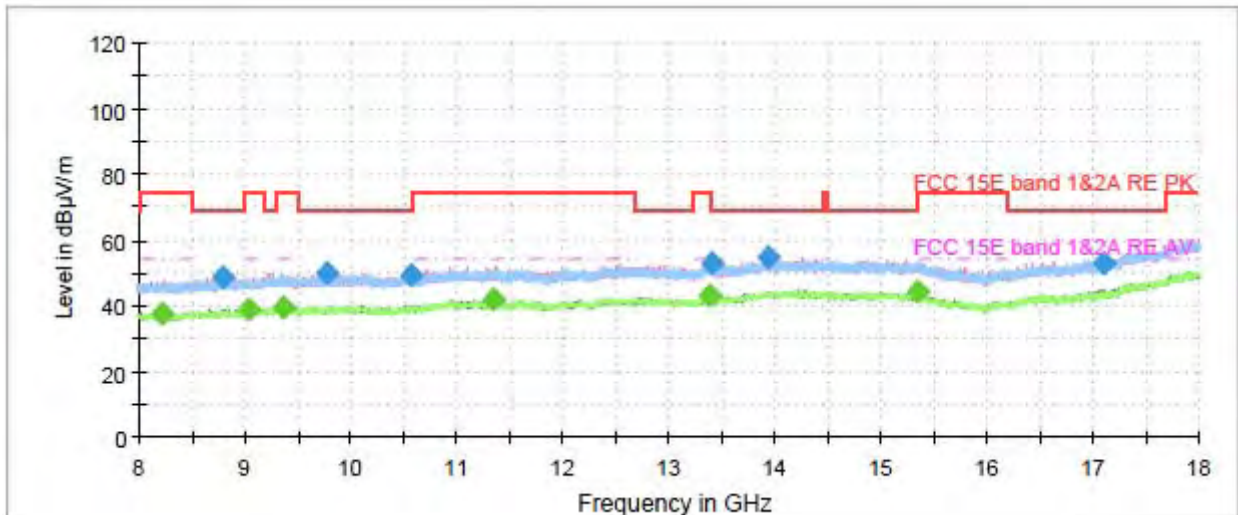

Radiates Emission from 8GHz to 18GHz



Frequency (MHz)	Peak (dBuV/m)	Average (dBuV/m)	Limit (dBuV/m)	Margin (dB)	Height (cm)	Polarization	Azimuth (deg)	Correct Factor (dB)
1280.700000	45.19	---	68.20	23.01	500.0	V	302.0	-10.0
1405.300000	---	35.86	54.00	18.14	500.0	V	88.0	-9.3
1595.000000	---	35.93	54.00	18.07	500.0	V	116.0	-9.1
1870.800000	46.53	---	68.20	21.67	500.0	V	13.0	-8.5
2518.533333	48.49	---	68.20	19.71	500.0	V	116.0	-6.3
2795.266667	---	39.14	54.00	14.86	500.0	V	186.0	-6.0
3506.000000	50.07	---	68.20	18.13	500.0	V	158.0	-4.8
3999.733333	---	40.54	54.00	13.46	500.0	V	0.0	-2.9
5372.900000	---	43.17	54.00	10.83	500.0	H	216.0	1.4
5615.566667	53.12	---	68.20	15.08	500.0	V	46.0	1.9
7735.633333	---	48.24	54.00	5.76	500.0	H	130.0	7.0
7774.833333	57.97	---	68.20	10.23	500.0	V	21.0	7.0

Remark: 1. Correction Factor = Antenna factor+ Insertion loss (cable loss + amplifier gain)

802.11ac (VHT20) CH64

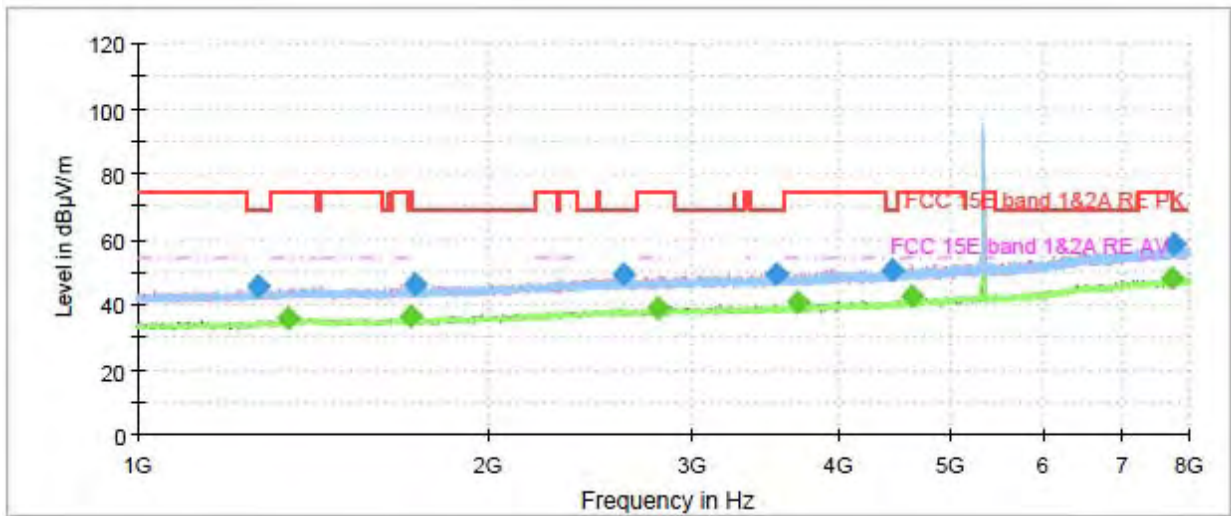

Radiates Emission from 1GHz to 8GHz
 Note: The signal beyond the limit is carrier.

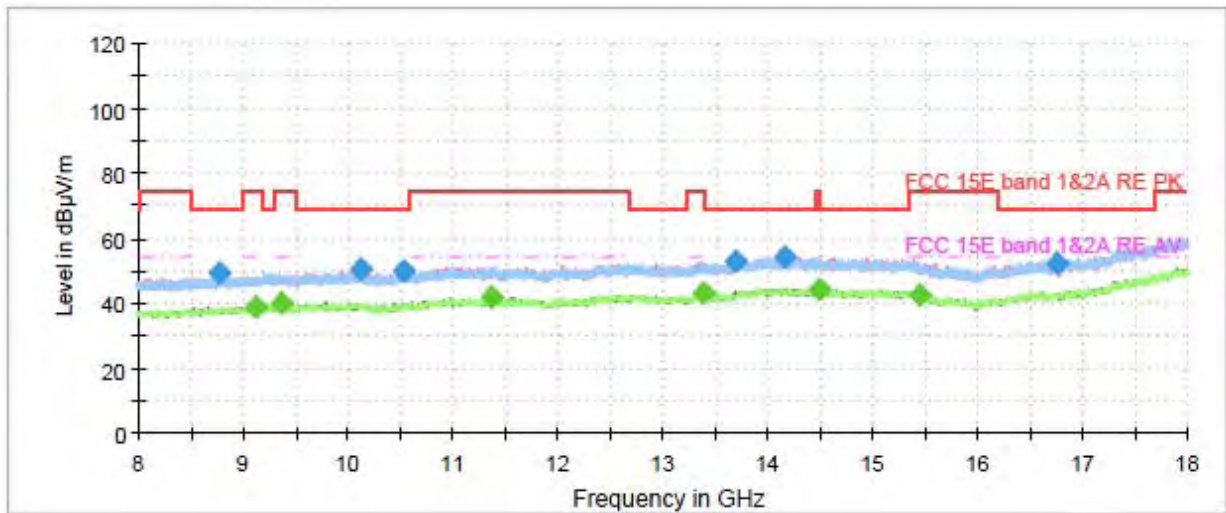

Radiates Emission from 8GHz to 18GHz



Frequency (MHz)	Peak (dBuV/m)	Average (dBuV/m)	Limit (dBuV/m)	Margin (dB)	Height (cm)	Polarization	Azimuth (deg)	Correct Factor (dB)
1270.900000	45.27	---	68.20	22.93	100.0	V	2.0	-10.1
1346.033333	---	35.68	54.00	18.32	100.0	V	287.0	-9.6
1719.366667	---	36.18	54.00	17.82	200.0	V	0.0	-8.9
1734.066667	46.26	---	68.20	21.94	100.0	H	330.0	-8.9
2616.300000	49.25	---	68.20	18.95	200.0	H	358.0	-6.1
2797.133333	---	38.77	54.00	15.23	100.0	V	8.0	-6.0
3530.966667	49.54	---	68.20	18.66	100.0	V	116.0	-4.6
3683.800000	---	40.81	54.00	13.19	100.0	V	244.0	-4.3
4454.733333	50.18	---	68.20	18.02	100.0	H	261.0	-1.5
4617.133333	---	42.23	54.00	11.77	100.0	V	0.0	-0.7
7727.466667	---	48.22	54.00	5.78	200.0	H	15.0	7.0
7759.666667	58.49	---	68.20	9.71	200.0	H	36.0	7.0

Remark: 1. Correction Factor = Antenna factor+ Insertion loss (cable loss + amplifier gain)

802.11ac (VHT20) CH100

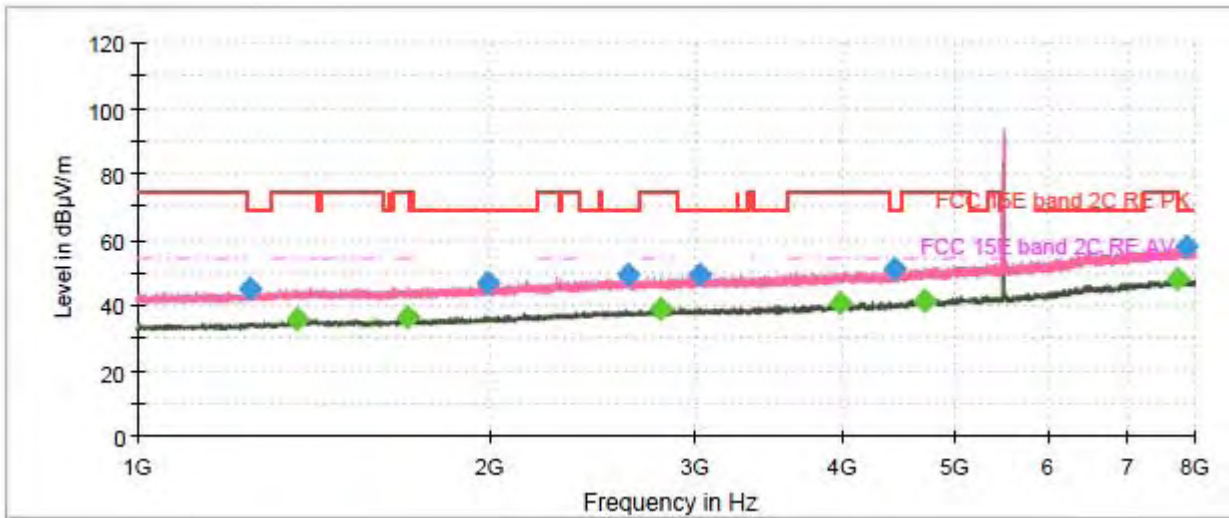

Radiates Emission from 1GHz to 8GHz
 Note: The signal beyond the limit is carrier.

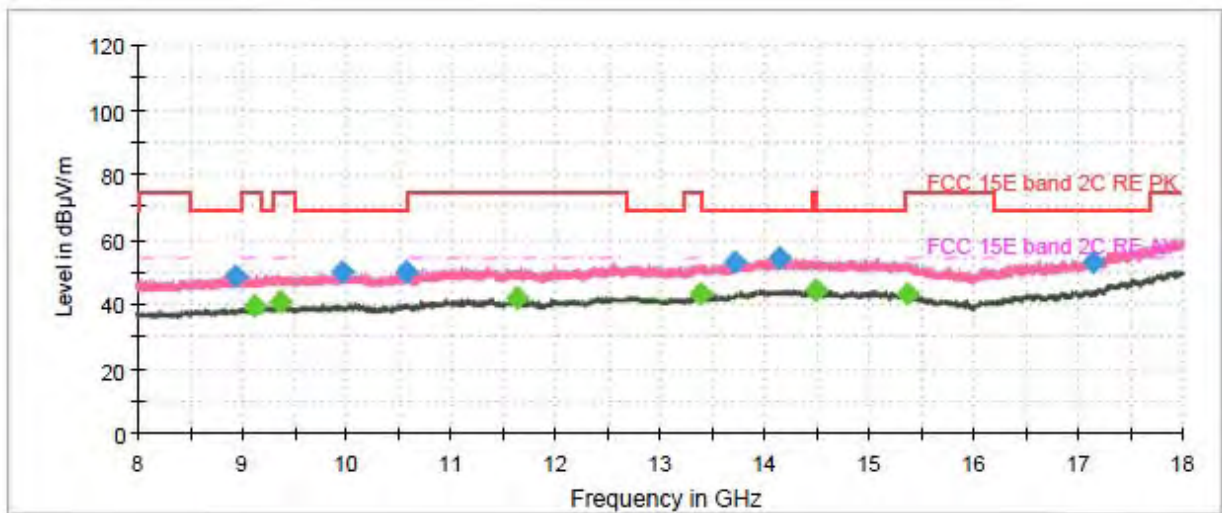

Radiates Emission from 8GHz to 18GHz



Frequency (MHz)	Peak (dBuV/m)	Average (dBuV/m)	Limit (dBuV/m)	Margin (dB)	Height (cm)	Polarization	Azimuth (deg)	Correct Factor (dB)
1245.233333	44.84	---	68.20	23.36	100.0	V	163.0	-10.2
1367.500000	---	35.80	54.00	18.20	100.0	V	359.0	-9.5
1702.800000	---	36.59	54.00	17.41	100.0	H	172.0	-8.8
1993.766667	46.52	---	68.20	21.68	200.0	H	11.0	-7.9
2629.366667	49.31	---	68.20	18.89	200.0	H	87.0	-6.1
2794.100000	---	38.78	54.00	15.22	100.0	V	0.0	-6.0
3015.766667	49.48	---	68.20	18.72	100.0	H	1.0	-5.6
3989.000000	---	40.64	54.00	13.36	100.0	H	359.0	-3.0
4431.866667	50.85	---	68.20	17.35	100.0	H	0.0	-1.7
4703.933333	---	41.38	54.00	12.62	100.0	V	329.0	-0.5
7741.233333	---	48.03	54.00	5.97	100.0	V	219.0	7.0
7859.066667	58.05	---	68.20	10.15	100.0	H	3.0	7.2

Remark: 1. Correction Factor = Antenna factor+ Insertion loss (cable loss + amplifier gain)

802.11ac (HT20) CH116

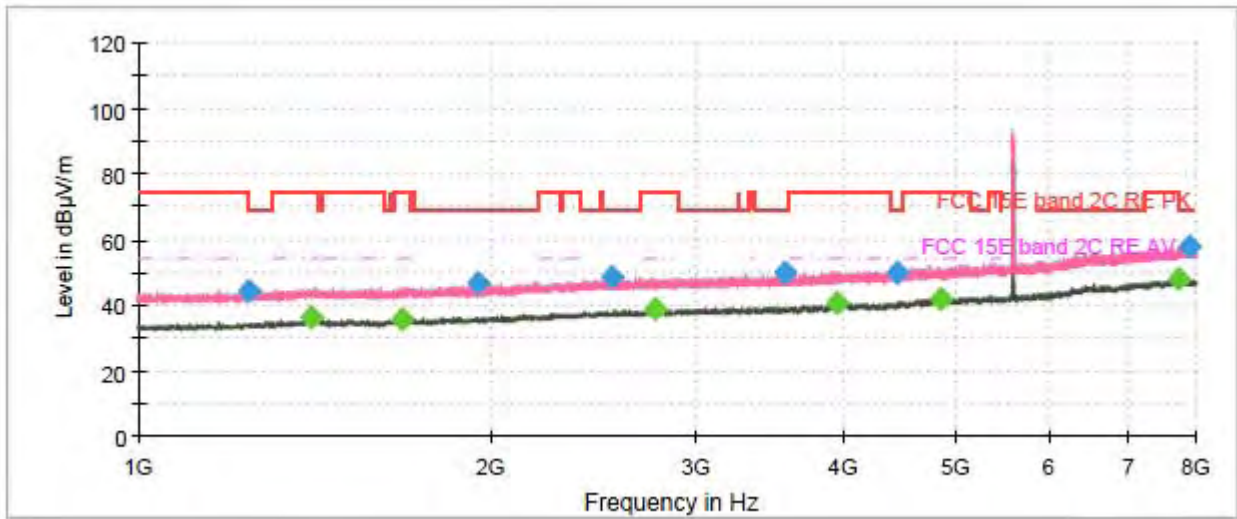

Radiates Emission from 1GHz to 8GHz
 Note: The signal beyond the limit is carrier.

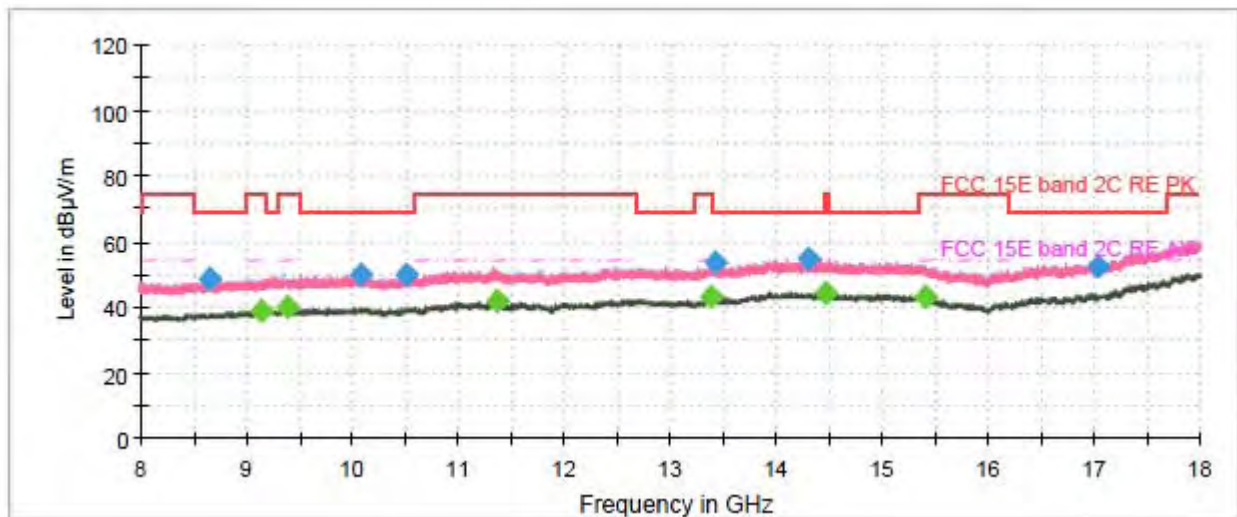

Radiates Emission from 8GHz to 18GHz



Frequency (MHz)	Peak (dBuV/m)	Average (dBuV/m)	Limit (dBuV/m)	Margin (dB)	Height (cm)	Polarization	Azimuth (deg)	Correct Factor (dB)
1244.766667	44.32	---	68.20	23.88	200.0	H	0.0	-10.2
1406.233333	---	36.08	54.00	17.92	200.0	V	2.0	-9.3
1679.700000	---	35.83	54.00	18.17	100.0	H	22.0	-9.0
1951.766667	46.49	---	68.20	21.71	100.0	H	228.0	-8.2
2533.466667	48.58	---	68.20	19.63	100.0	H	172.0	-6.3
2766.100000	---	38.80	54.00	15.20	100.0	H	228.0	-6.1
3567.600000	49.92	---	68.20	18.28	100.0	V	0.0	-4.6
3941.866667	---	40.34	54.00	13.66	200.0	H	42.0	-3.3
4447.966667	50.14	---	68.20	18.06	200.0	V	0.0	-1.6
4841.133333	---	42.03	54.00	11.97	200.0	V	8.0	-0.3
7729.566667	---	48.13	54.00	5.87	100.0	H	22.0	7.0
7903.866667	57.67	---	68.20	10.53	200.0	V	75.0	7.4

Remark: 1. Correction Factor = Antenna factor+ Insertion loss (cable loss + amplifier gain)

802.11ac (VHT20) CH140

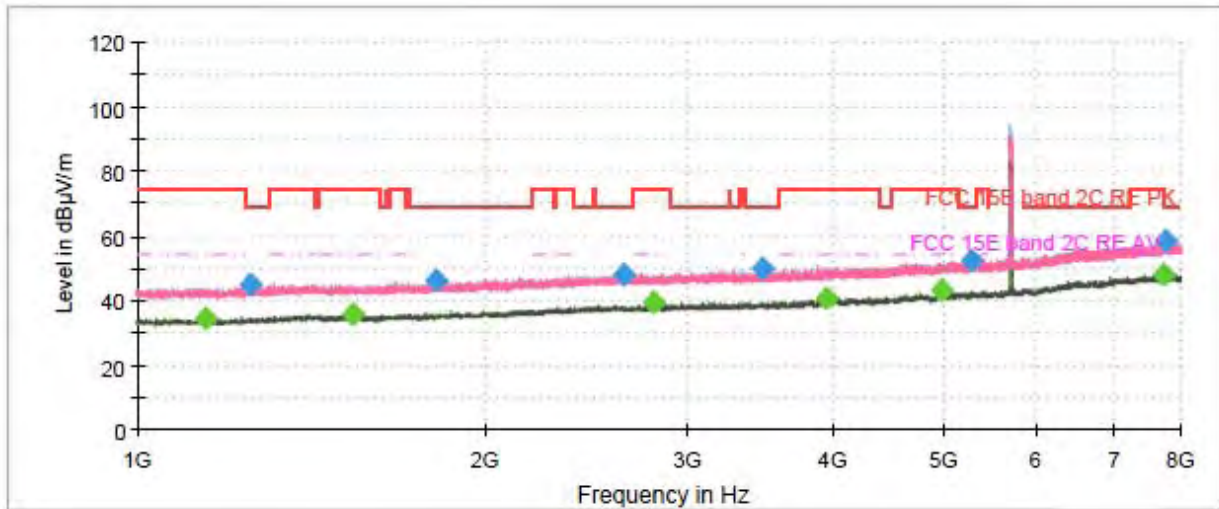

Radiates Emission from 1GHz to 8GHz
 Note: The signal beyond the limit is carrier.

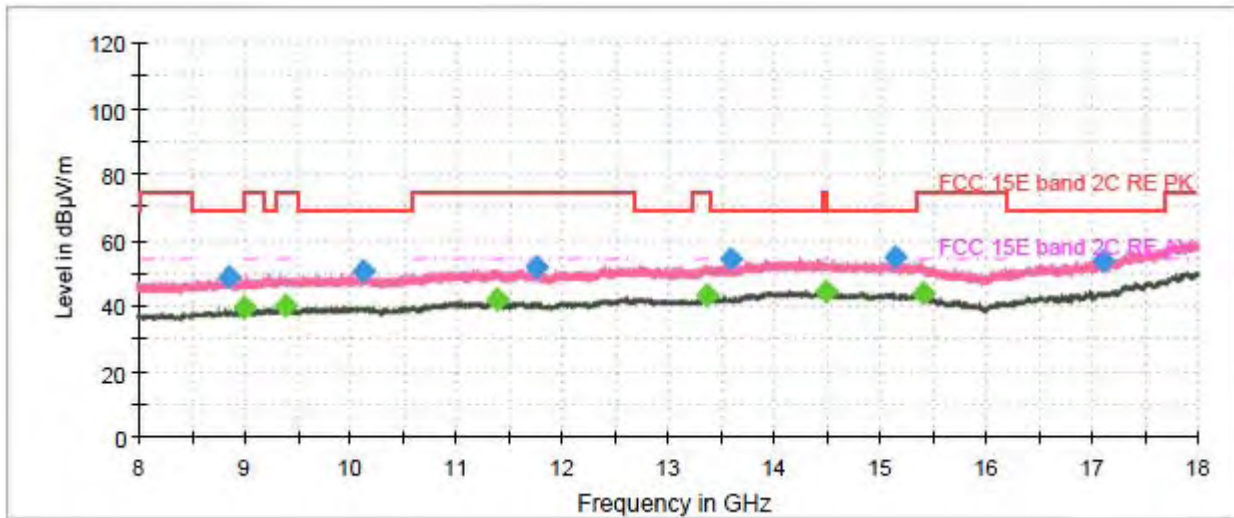

Radiates Emission from 8GHz to 18GHz



Frequency (MHz)	Peak (dBuV/m)	Average (dBuV/m)	Limit (dBuV/m)	Margin (dB)	Height (cm)	Polarization	Azimuth (deg)	Correct Factor (dB)
1144.666667	---	34.64	54.00	19.36	100.0	V	26.0	-10.8
1252.233333	44.80	---	68.20	23.40	100.0	V	87.0	-10.2
1539.466667	---	35.77	54.00	18.23	100.0	H	2.0	-9.1
1815.266667	46.40	---	68.20	21.80	100.0	V	129.0	-8.7
2641.500000	48.22	---	68.20	19.98	200.0	H	352.0	-6.1
2799.233333	---	39.08	54.00	14.92	200.0	V	46.0	-6.0
3476.133333	49.70	---	68.20	18.50	100.0	H	105.0	-4.9
3957.033333	---	40.92	54.00	13.08	100.0	V	170.0	-3.2
4968.300000	---	43.14	54.00	10.86	200.0	V	160.0	0.1
5281.900000	52.26	---	68.20	15.94	200.0	H	313.0	1.1
7718.133333	---	48.24	54.00	5.76	200.0	H	272.0	7.0
7778.800000	58.42	---	68.20	9.78	200.0	H	300.0	7.0

Remark: 1. Correction Factor = Antenna factor+ Insertion loss (cable loss + amplifier gain)

802.11ac (VHT20) CH144

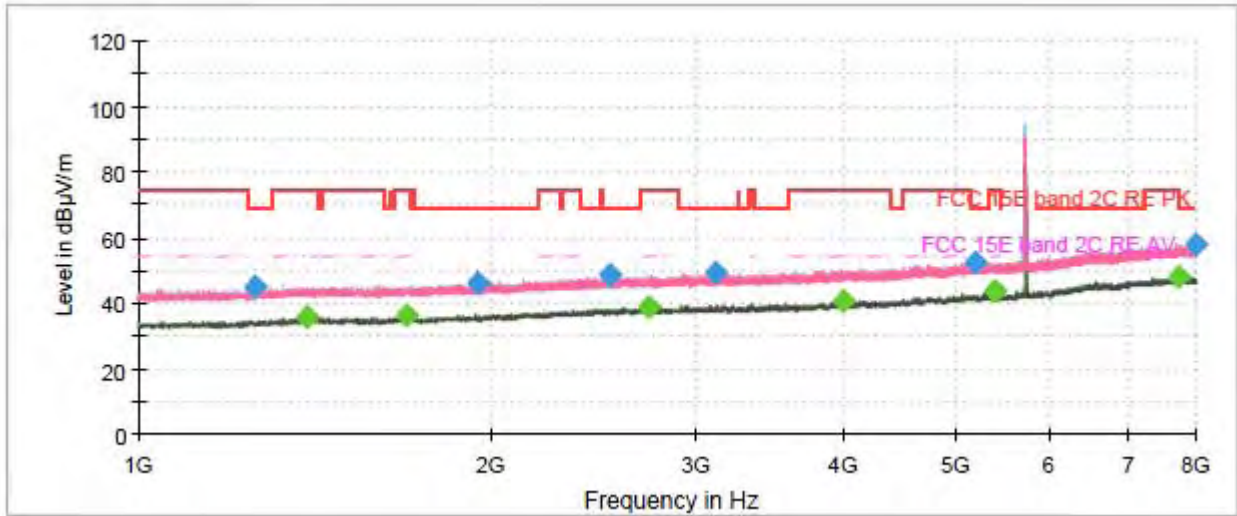

Radiates Emission from 1GHz to 8GHz
Note: The signal beyond the limit is carrier.

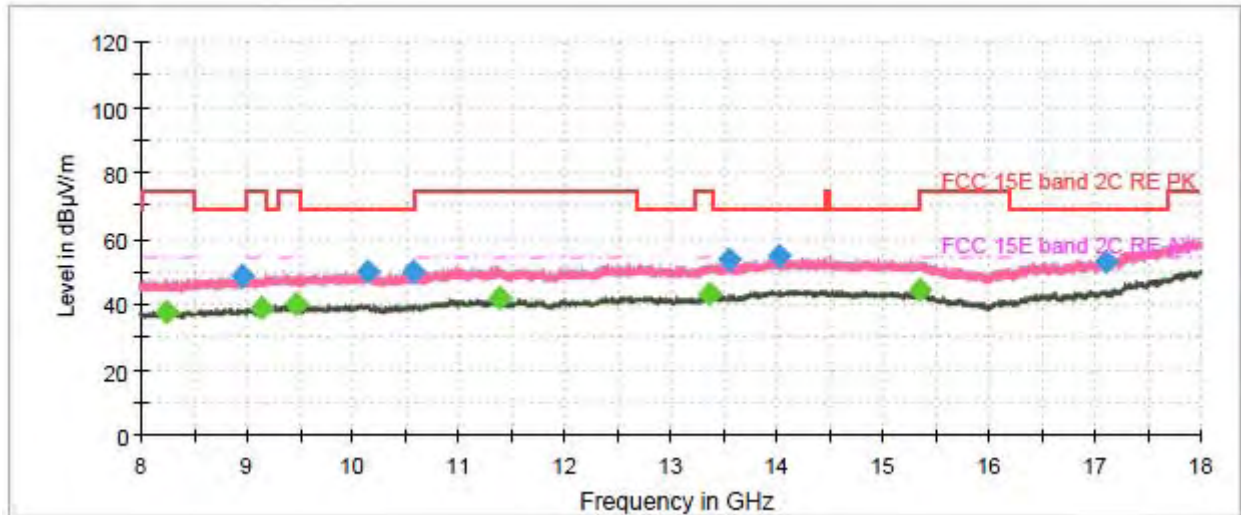

Radiates Emission from 8GHz to 18GHz



Frequency (MHz)	Peak (dBuV/m)	Average (dBuV/m)	Limit (dBuV/m)	Margin (dB)	Height (cm)	Polarization	Azimuth (deg)	Correct Factor (dB)
1255.966667	44.98	---	68.20	23.22	200.0	H	218.0	-10.2
1392.233333	---	35.84	54.00	18.16	100.0	V	146.0	-9.4
1692.533333	---	36.19	54.00	17.81	100.0	H	212.0	-8.9
1953.633333	45.91	---	68.20	22.30	200.0	H	232.0	-8.2
2525.066667	48.31	---	68.20	19.89	100.0	V	203.0	-6.3
2731.800000	---	38.67	54.00	15.33	100.0	V	352.0	-6.1
3106.533333	49.43	---	68.20	18.77	100.0	V	160.0	-5.5
3999.266667	---	40.46	54.00	13.54	200.0	V	58.0	-2.9
5189.033333	52.55	---	68.20	15.65	100.0	V	346.0	0.9
5380.133333	---	43.43	54.00	10.57	100.0	V	299.0	1.4
7735.633333	---	47.88	54.00	6.12	200.0	V	273.0	7.0
7985.766667	57.80	---	68.20	10.40	200.0	V	287.0	7.6

Remark: 1. Correction Factor = Antenna factor+ Insertion loss (cable loss + amplifier gain)

802.11ac (VHT40) CH38

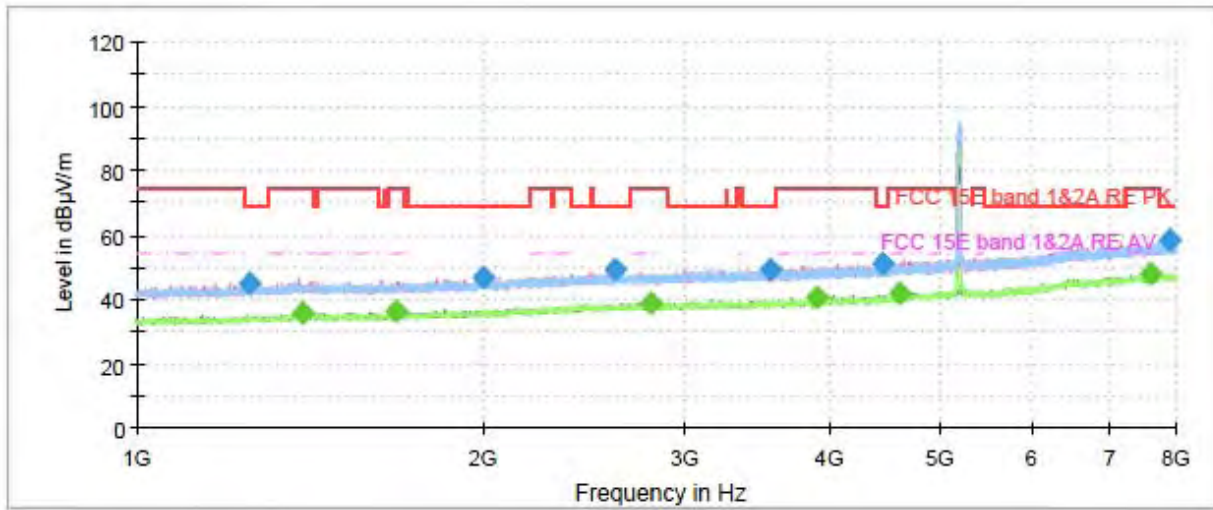

Radiates Emission from 1GHz to 8GHz
 Note: The signal beyond the limit is carrier.

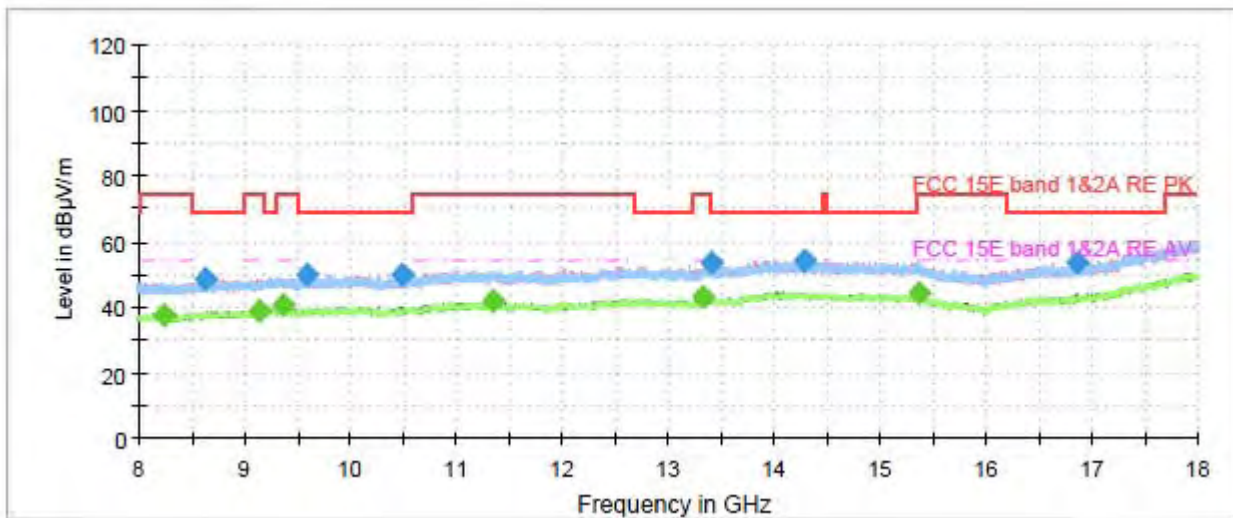

Radiates Emission from 8GHz to 18GHz



Frequency (MHz)	Peak (dBuV/m)	Average (dBuV/m)	Limit (dBuV/m)	Margin (dB)	Height (cm)	Polarization	Azimuth (deg)	Correct Factor (dB)
1251.300000	45.02	---	68.20	23.18	200.0	V	244.0	-10.2
1393.866667	---	35.71	54.00	18.29	200.0	V	116.0	-9.4
1680.166667	---	36.05	54.00	17.95	200.0	H	0.0	-9.0
1998.433333	46.67	---	68.20	21.53	200.0	V	347.0	-7.9
2606.500000	49.21	---	68.20	18.99	200.0	H	0.0	-6.1
2803.666667	---	39.00	54.00	15.00	200.0	H	359.0	-6.0
3554.066667	49.47	---	68.20	18.73	200.0	H	31.0	-4.6
3895.666667	---	40.81	54.00	13.19	200.0	H	0.0	-3.4
4448.666667	50.94	---	68.20	17.26	200.0	H	2.0	-1.6
4611.766667	---	42.09	54.00	11.91	100.0	V	5.0	-0.8
7587.233333	---	47.97	54.00	6.03	100.0	V	61.0	7.0
7889.633333	58.63	---	68.20	9.57	200.0	V	244.0	7.3

Remark: 1. Correction Factor = Antenna factor+ Insertion loss (cable loss + amplifier gain)

802.11ac (VHT40) CH46

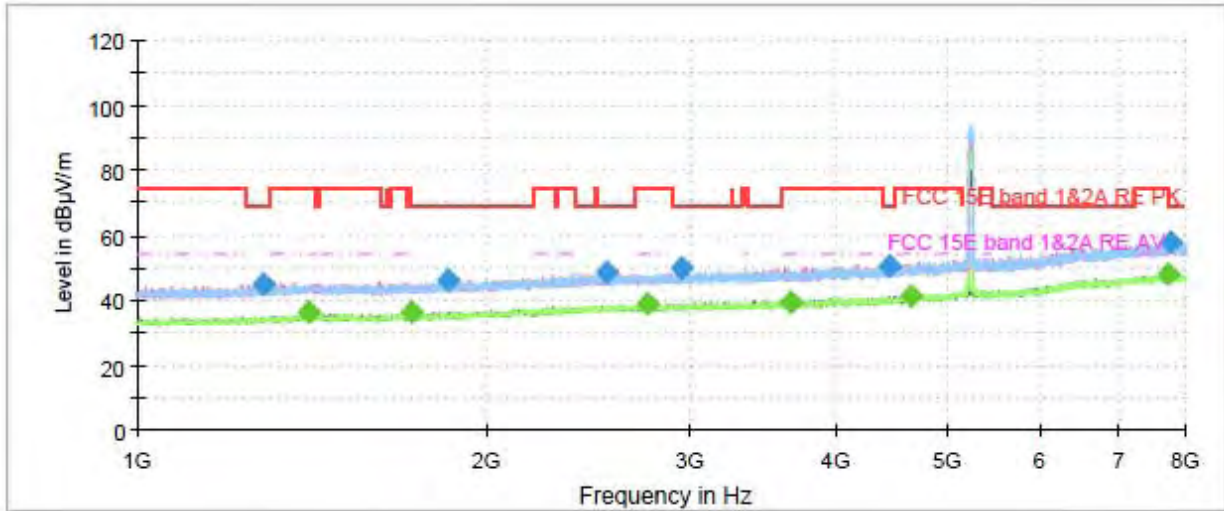

Radiates Emission from 1GHz to 8GHz
 Note: The signal beyond the limit is carrier.

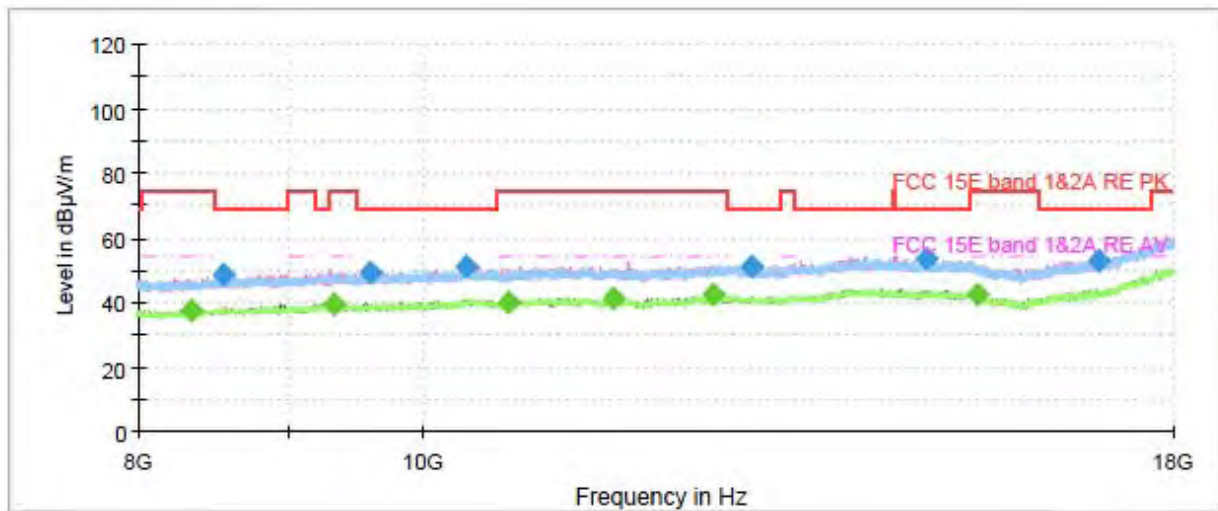

Radiates Emission from 8GHz to 18GHz



Frequency (MHz)	Peak (dBuV/m)	Average (dBuV/m)	Limit (dBuV/m)	Margin (dB)	Height (cm)	Polarization	Azimuth (deg)	Correct Factor (dB)
1284.900000	45.13	---	68.20	23.07	200.0	H	101.0	-10.0
1404.600000	---	36.00	54.00	18.00	200.0	H	274.0	-9.3
1720.066667	---	36.30	54.00	17.70	100.0	H	144.0	-8.9
1850.966667	46.31	---	68.20	21.89	200.0	H	169.0	-8.6
2537.666667	48.36	---	68.20	19.84	200.0	V	173.0	-6.2
2752.566667	---	38.78	54.00	15.22	100.0	V	4.0	-6.1
2943.200000	49.93	---	68.20	18.27	200.0	V	352.0	-5.8
3658.133333	---	39.40	54.00	14.60	200.0	V	73.0	-4.5
4447.500000	50.16	---	68.20	18.04	200.0	V	297.0	-1.6
4642.566667	---	41.41	54.00	12.59	100.0	V	0.0	-0.6
7746.600000	---	47.89	54.00	6.11	100.0	H	144.0	7.0
7779.266667	57.91	---	68.20	10.29	200.0	V	173.0	7.0

Remark: 1. Correction Factor = Antenna factor+ Insertion loss (cable loss + amplifier gain)

802.11ac (VHT40) CH54

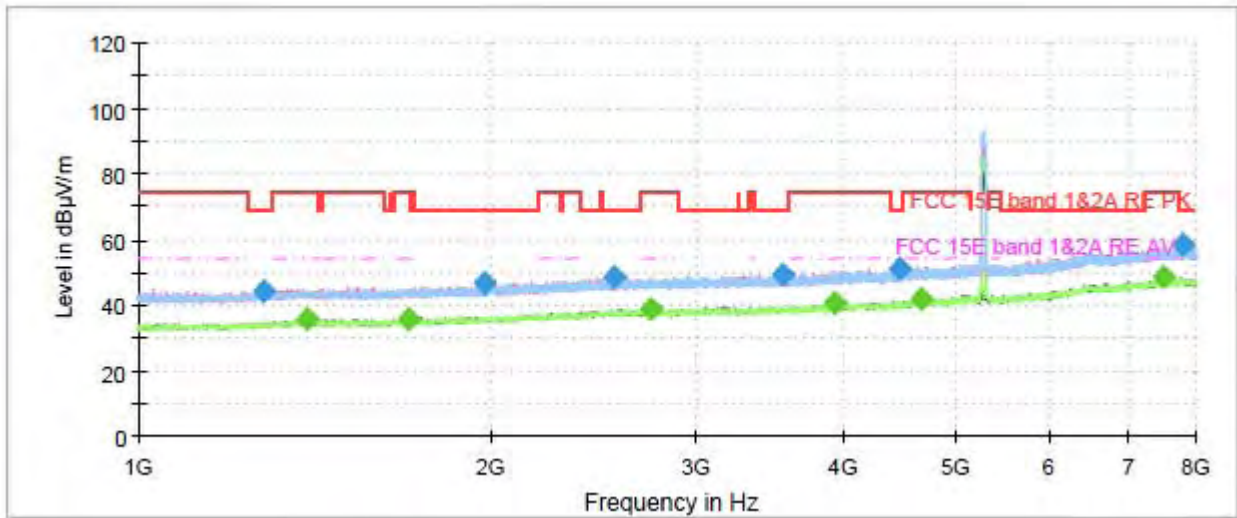

Radiates Emission from 1GHz to 8GHz
 Note: The signal beyond the limit is carrier.

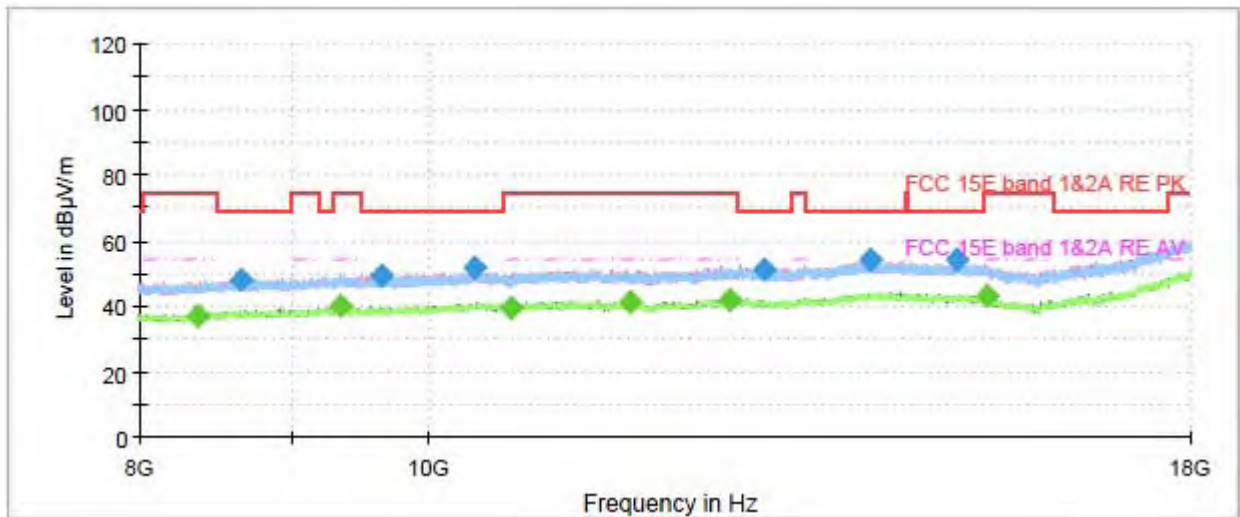

Radiates Emission from 8GHz to 18GHz



Frequency (MHz)	Peak (dBuV/m)	Average (dBuV/m)	Limit (dBuV/m)	Margin (dB)	Height (cm)	Polarization	Azimuth (deg)	Correct Factor (dB)
1281.400000	44.53	---	68.20	23.67	200.0	V	0.0	-10.0
1390.600000	---	35.97	54.00	18.03	200.0	V	261.0	-9.4
1698.833333	---	35.91	54.00	18.09	200.0	V	358.0	-8.9
1976.733333	46.55	---	68.20	21.65	100.0	V	0.0	-8.1
2544.900000	48.49	---	68.20	19.71	100.0	H	337.0	-6.2
2740.900000	---	38.76	54.00	15.24	100.0	V	128.0	-6.1
3553.600000	49.46	---	68.20	18.74	100.0	H	256.0	-4.6
3926.000000	---	40.32	54.00	13.68	200.0	H	172.0	-3.3
4468.266667	50.96	---	68.20	17.24	200.0	V	247.0	-1.5
4659.833333	---	41.57	54.00	12.43	200.0	V	131.0	-0.5
7498.566667	---	48.62	54.00	5.38	100.0	V	199.0	6.9
7809.133333	58.67	---	68.20	9.53	200.0	H	158.0	7.0

Remark: 1. Correction Factor = Antenna factor+ Insertion loss (cable loss + amplifier gain)

802.11ac (VHT40) CH62

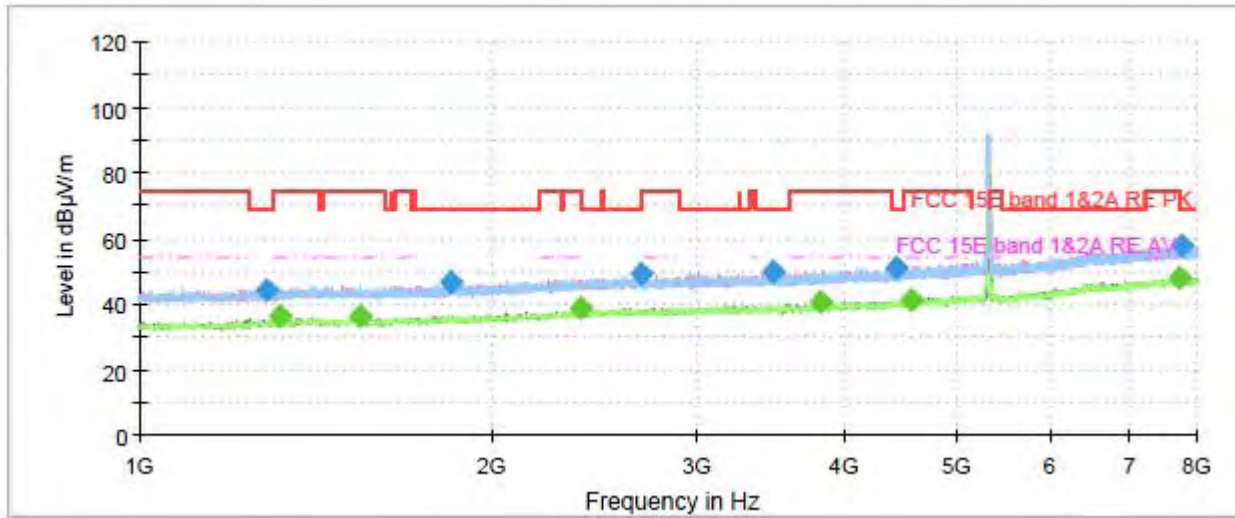

Radiates Emission from 1GHz to 8GHz
 Note: The signal beyond the limit is carrier.

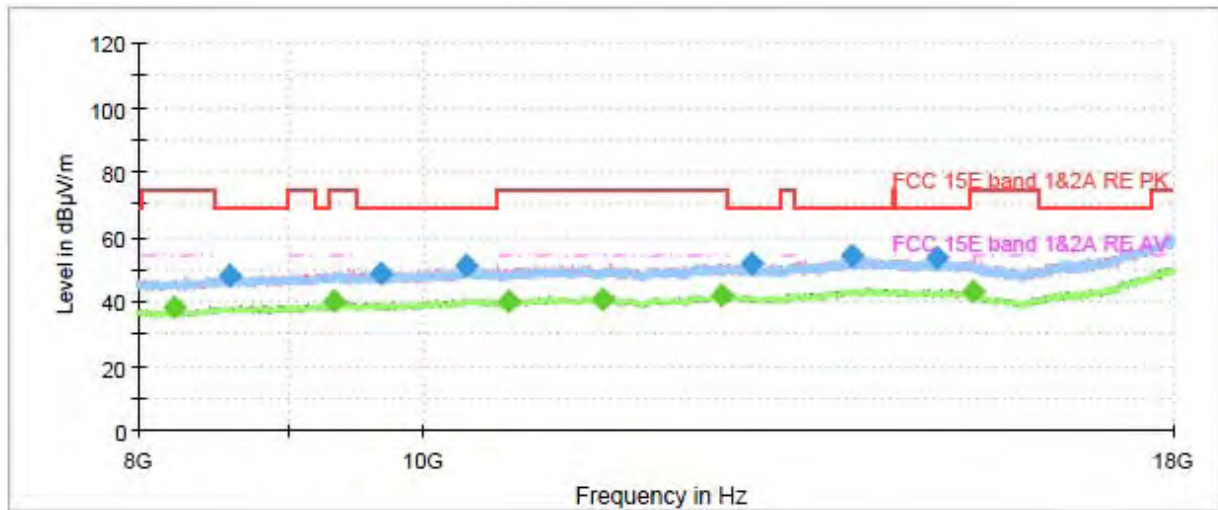

Radiates Emission from 8GHz to 18GHz



Frequency (MHz)	Peak (dBuV/m)	Average (dBuV/m)	Limit (dBuV/m)	Margin (dB)	Height (cm)	Polarization	Azimuth (deg)	Correct Factor (dB)
1286.066667	44.27	---	68.20	23.93	200.0	H	42.0	-10.0
1315.933333	---	36.01	54.00	17.99	100.0	H	2.0	-9.8
1543.666667	---	36.03	54.00	17.97	200.0	V	302.0	-9.1
1845.833333	46.73	---	68.20	21.47	200.0	V	340.0	-8.6
2380.400000	---	38.74	54.00	15.26	100.0	H	161.0	-6.5
2686.066667	49.05	---	68.20	19.15	200.0	H	286.0	-6.0
3477.300000	49.54	---	68.20	18.66	200.0	H	30.0	-4.9
3810.500000	---	40.33	54.00	13.67	200.0	V	358.0	-3.8
4434.900000	50.86	---	68.20	17.34	200.0	V	15.0	-1.6
4557.166667	---	41.11	54.00	12.89	100.0	V	3.0	-1.1
7746.600000	---	47.89	54.00	6.11	200.0	V	0.0	7.0
7754.066667	58.08	---	68.20	10.12	200.0	H	56.0	7.0

Remark: 1. Correction Factor = Antenna factor+ Insertion loss (cable loss + amplifier gain)

802.11ac (VHT40) CH102

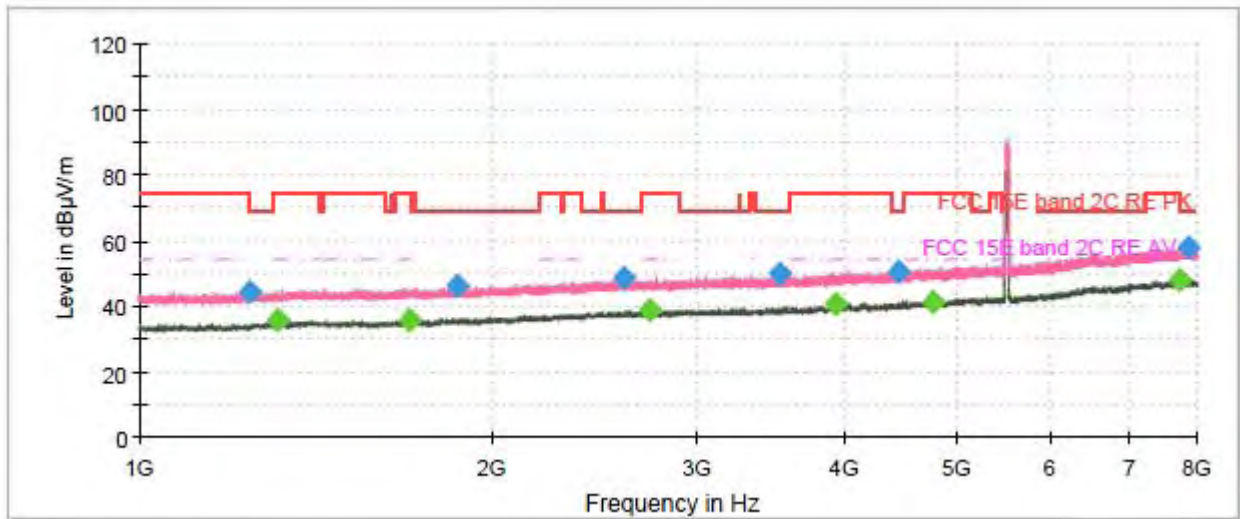

Radiates Emission from 1GHz to 8GHz
 Note: The signal beyond the limit is carrier.

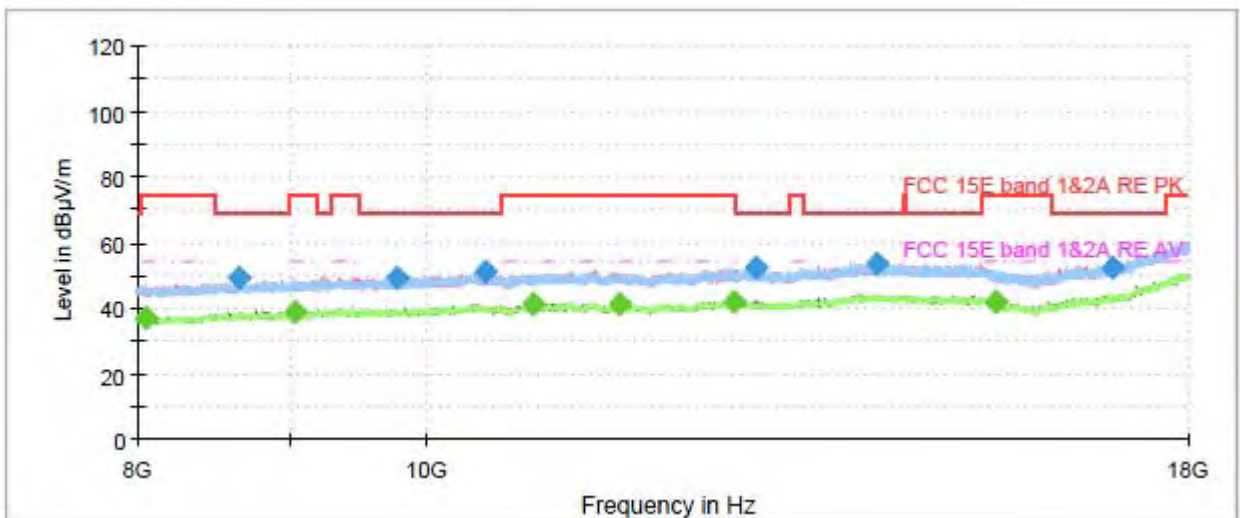

Radiates Emission from 8GHz to 18GHz



Frequency (MHz)	Peak (dBuV/m)	Average (dBuV/m)	Limit (dBuV/m)	Margin (dB)	Height (cm)	Polarization	Azimuth (deg)	Correct Factor (dB)
1243.833333	44.35	---	68.20	23.85	100.0	H	242.0	-10.2
1314.300000	---	35.85	54.00	18.15	100.0	V	0.0	-9.8
1702.100000	---	35.90	54.00	18.10	100.0	H	287.0	-8.8
1871.266667	46.11	---	68.20	22.09	100.0	V	231.0	-8.5
2590.866667	48.39	---	68.20	19.81	200.0	V	101.0	-6.1
2724.100000	---	38.80	54.00	15.20	100.0	V	358.0	-6.1
3521.866667	49.72	---	68.20	18.48	100.0	V	352.0	-4.7
3935.333333	---	40.57	54.00	13.43	200.0	V	241.0	-3.3
4453.333333	50.49	---	68.20	17.71	200.0	V	184.0	-1.6
4753.866667	---	41.38	54.00	12.62	200.0	V	12.0	-0.3
7721.633333	---	48.02	54.00	5.98	100.0	H	20.0	7.0
7856.500000	57.94	---	68.20	10.26	100.0	H	85.0	7.1

Remark: 1. Correction Factor = Antenna factor+ Insertion loss (cable loss + amplifier gain)

802.11ac (VHT40) CH118

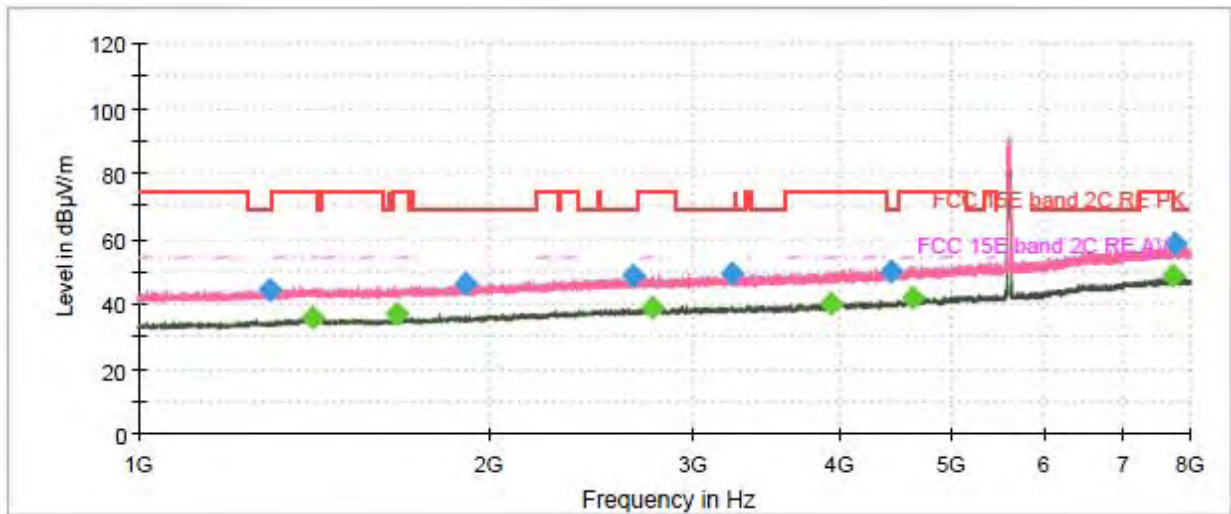

Radiates Emission from 1GHz to 8GHz
 Note: The signal beyond the limit is carrier.

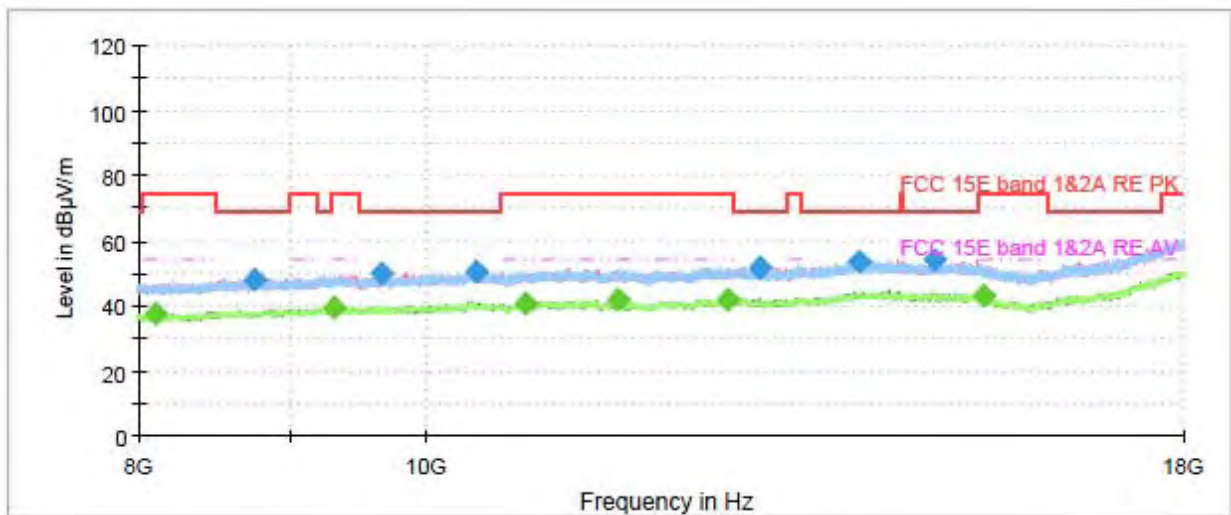

Radiates Emission from 8GHz to 18GHz



Frequency (MHz)	Peak (dBuV/m)	Average (dBuV/m)	Limit (dBuV/m)	Margin (dB)	Height (cm)	Polarization	Azimuth (deg)	Correct Factor (dB)
1297.266667	44.50	---	68.20	23.70	100.0	H	56.0	-9.9
1410.433333	---	35.66	54.00	18.34	200.0	H	120.0	-9.2
1662.666667	---	36.63	54.00	17.37	200.0	V	70.0	-9.0
1907.200000	46.32	---	68.20	21.88	200.0	H	328.0	-8.3
2660.633333	48.38	---	68.20	19.82	100.0	V	285.0	-6.0
2761.666667	---	38.84	54.00	15.16	100.0	V	359.0	-6.1
3235.566667	49.52	---	68.20	18.68	100.0	H	243.0	-5.2
3932.766667	---	40.23	54.00	13.77	100.0	V	347.0	-3.3
4423.466667	50.07	---	68.20	18.13	200.0	H	77.0	-1.7
4620.866667	---	42.01	54.00	11.99	100.0	V	285.0	-0.7
7743.333333	---	48.53	54.00	5.47	200.0	H	314.0	7.0
7753.133333	58.64	---	68.20	9.56	200.0	V	86.0	7.0

Remark: 1. Correction Factor = Antenna factor+ Insertion loss (cable loss + amplifier gain)

802.11ac (VHT40) CH134

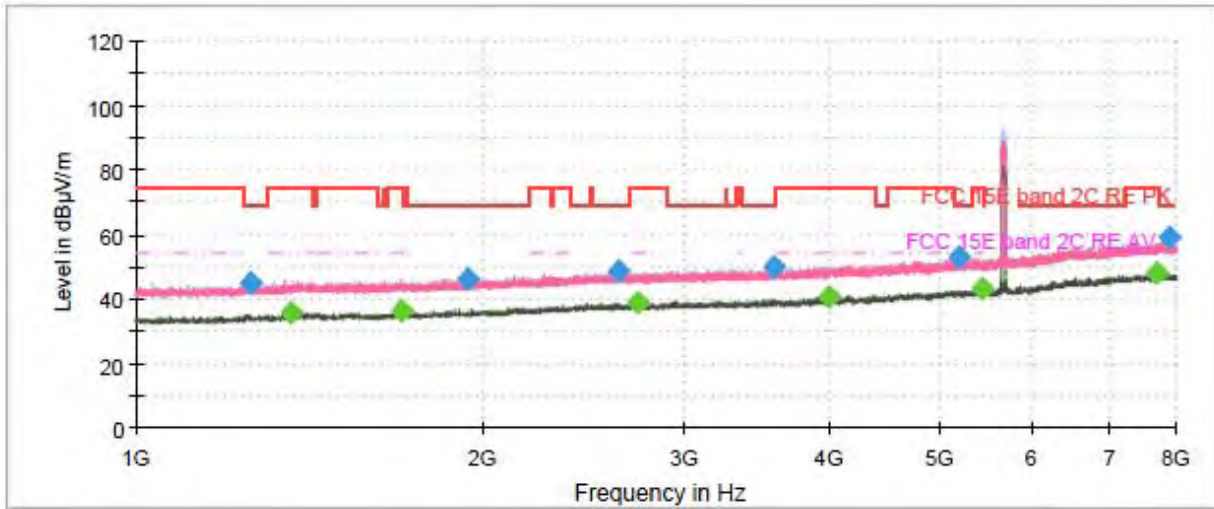

Radiates Emission from 1GHz to 8GHz
 Note: The signal beyond the limit is carrier.

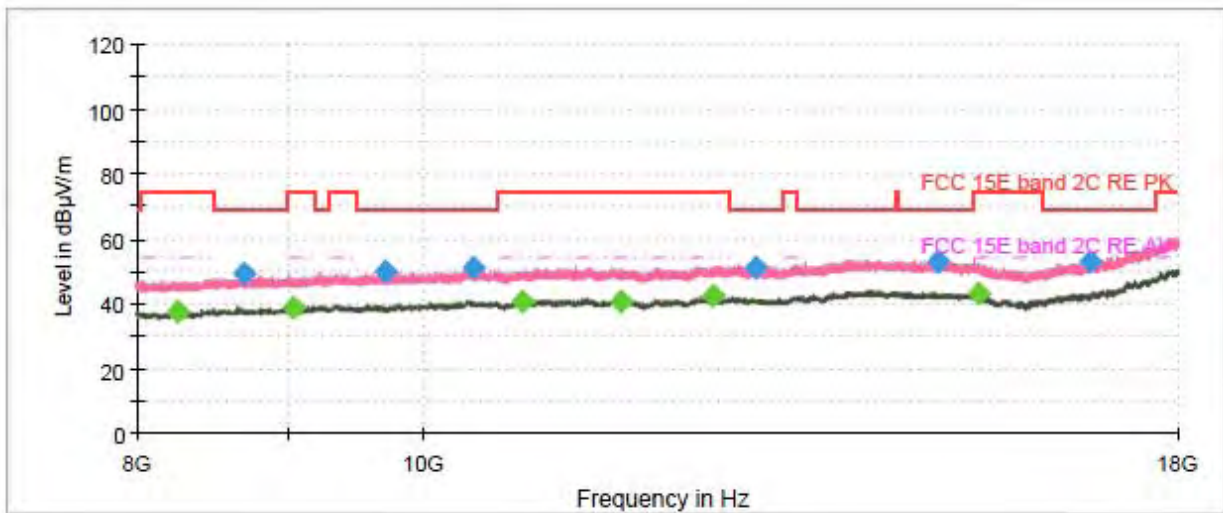

Radiates Emission from 8GHz to 18GHz



Frequency (MHz)	Peak (dBuV/m)	Average (dBuV/m)	Limit (dBuV/m)	Margin (dB)	Height (cm)	Polarization	Azimuth (deg)	Correct Factor (dB)
1257.366667	44.74	---	68.20	23.46	200.0	H	0.0	-10.2
1366.100000	---	35.96	54.00	18.04	200.0	H	0.0	-9.5
1703.033333	---	36.06	54.00	17.94	100.0	H	273.0	-8.8
1942.433333	46.45	---	68.20	21.75	200.0	V	1.0	-8.2
2620.500000	48.61	---	68.20	19.59	100.0	V	145.0	-6.1
2726.900000	---	38.82	54.00	15.18	100.0	V	216.0	-6.1
3576.233333	49.65	---	68.20	18.55	200.0	H	0.0	-4.6
3996.000000	---	40.51	54.00	13.49	200.0	H	290.0	-2.9
5192.300000	52.90	---	68.20	15.30	200.0	H	194.0	0.9
5429.133333	---	42.84	54.00	11.16	200.0	H	354.0	1.4
7707.633333	---	48.04	54.00	5.96	200.0	V	302.0	7.0
7897.566667	58.82	---	68.20	9.38	200.0	H	304.0	7.4

Remark: 1. Correction Factor = Antenna factor+ Insertion loss (cable loss + amplifier gain)

802.11ac (VHT40) CH142

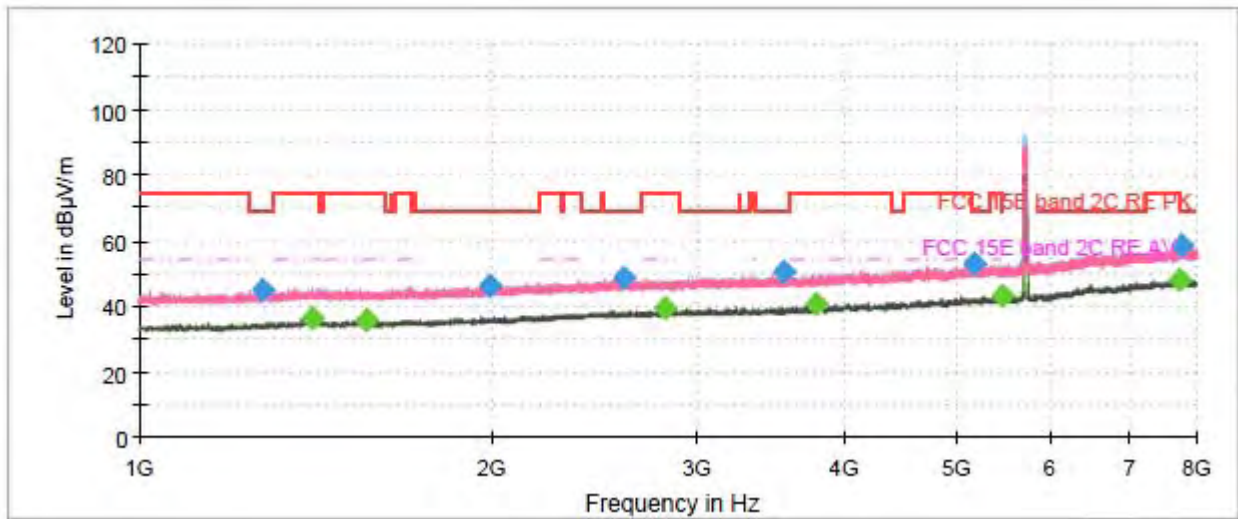

Radiates Emission from 1GHz to 8GHz
 Note: The signal beyond the limit is carrier.

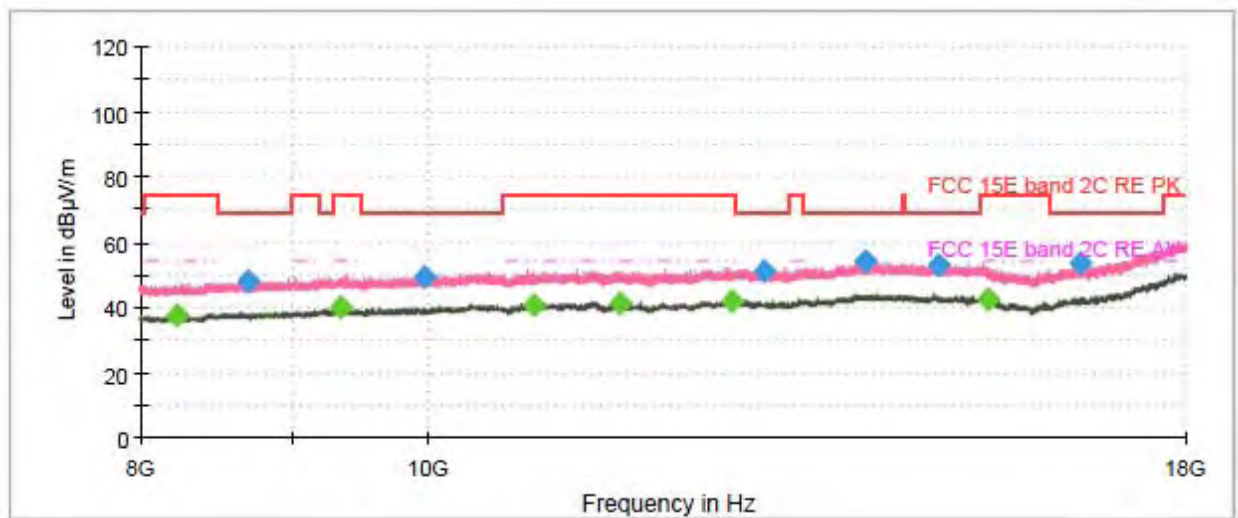

Radiates Emission from 8GHz to 18GHz



Frequency (MHz)	Peak (dBuV/m)	Average (dBuV/m)	Limit (dBuV/m)	Margin (dB)	Height (cm)	Polarization	Azimuth (deg)	Correct Factor (dB)
1272.300000	44.96	---	68.20	23.24	100.0	V	215.0	-10.1
1404.366667	---	36.32	54.00	17.68	200.0	V	0.0	-9.3
1559.533333	---	35.99	54.00	18.01	200.0	H	0.0	-9.1
1988.866667	46.13	---	68.20	22.07	200.0	H	172.0	-8.0
2595.766667	48.64	---	68.20	19.56	200.0	V	115.0	-6.1
2811.833333	---	39.11	54.00	14.89	100.0	V	48.0	-6.0
3553.600000	50.47	---	68.20	17.73	100.0	V	173.0	-4.6
3788.566667	---	40.86	54.00	13.14	200.0	V	144.0	-3.9
5167.800000	52.83	---	68.20	15.37	100.0	V	89.0	1.0
5454.333333	---	43.08	54.00	10.92	200.0	H	257.0	1.4
7748.000000	---	48.09	54.00	5.91	200.0	H	88.0	7.0
7768.533333	58.20	---	68.20	10.00	200.0	H	229.0	7.0

Remark: 1. Correction Factor = Antenna factor+ Insertion loss (cable loss + amplifier gain)

802.11ac (VHT80) CH42

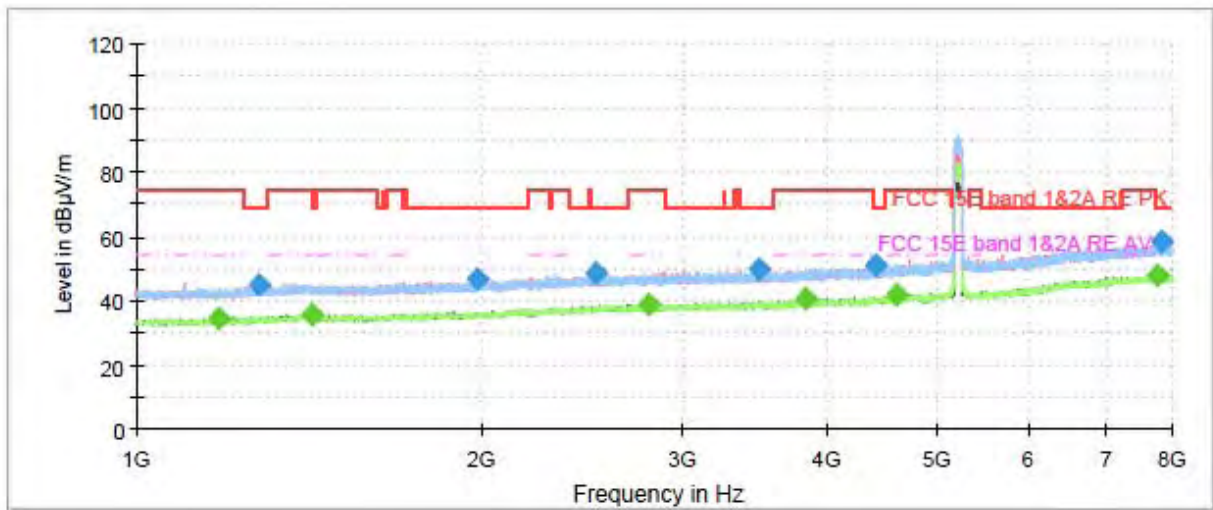

Radiates Emission from 1GHz to 8GHz
 Note: The signal beyond the limit is carrier.

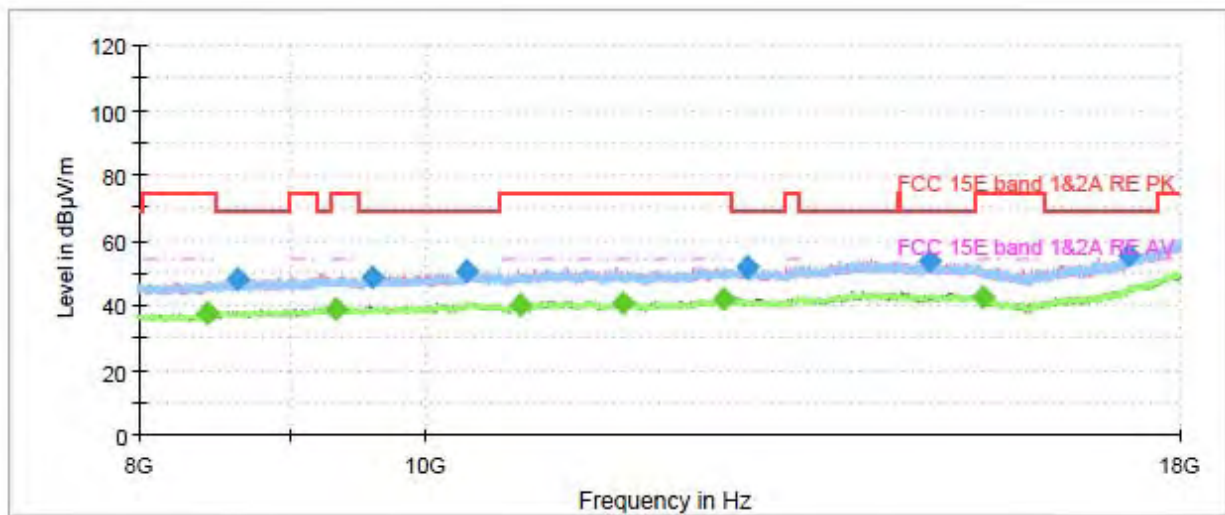

Radiates Emission from 8GHz to 18GHz



Frequency (MHz)	Peak (dBuV/m)	Average (dBuV/m)	Limit (dBuV/m)	Margin (dB)	Height (cm)	Polarization	Azimuth (deg)	Correct Factor (dB)
1182.000000	---	34.77	54.00	19.23	200.0	V	0.0	-10.7
1277.200000	44.68	---	68.20	23.52	100.0	V	300.0	-10.1
1420.700000	---	35.99	54.00	18.01	100.0	H	304.0	-9.2
1987.000000	46.50	---	68.20	21.70	200.0	V	0.0	-8.0
2516.666667	48.79	---	68.20	19.41	200.0	V	12.0	-6.3
2796.666667	---	39.07	54.00	14.93	100.0	H	1.0	-6.0
3497.600000	50.05	---	68.20	18.15	100.0	V	160.0	-4.8
3835.933333	---	40.72	54.00	13.28	200.0	H	73.0	-3.8
4420.200000	51.01	---	68.20	17.19	100.0	V	353.0	-1.7
4601.500000	---	41.63	54.00	12.37	200.0	V	2.0	-0.8
7749.633333	---	48.12	54.00	5.89	200.0	H	286.0	7.0
7841.100000	58.33	---	68.20	9.87	200.0	V	197.0	7.0

Remark: 1. Correction Factor = Antenna factor+ Insertion loss (cable loss + amplifier gain)

802.11ac (VHT80) CH58

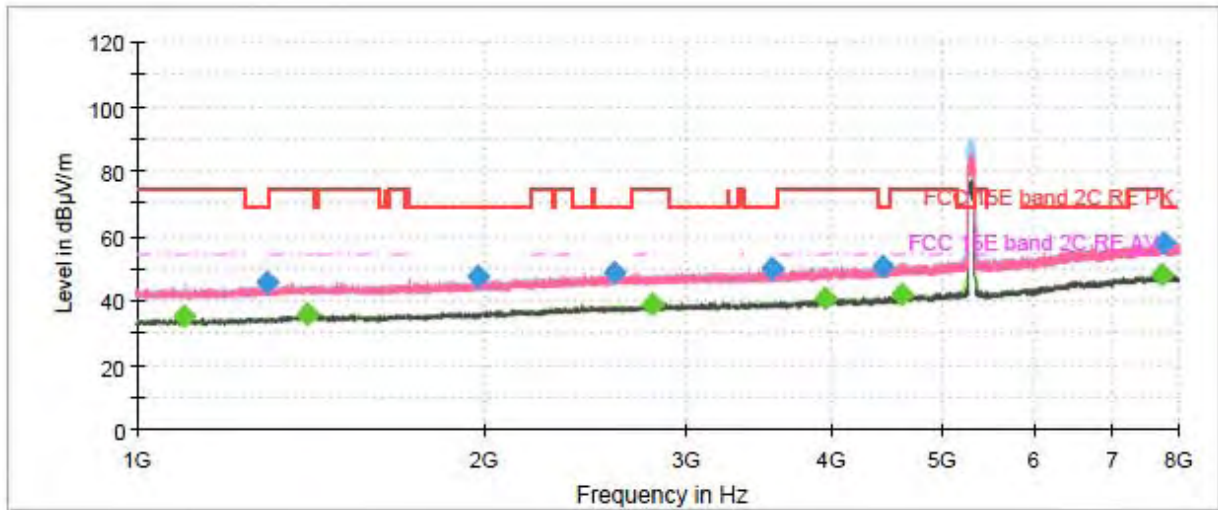

Radiates Emission from 1GHz to 8GHz
 Note: The signal beyond the limit is carrier.

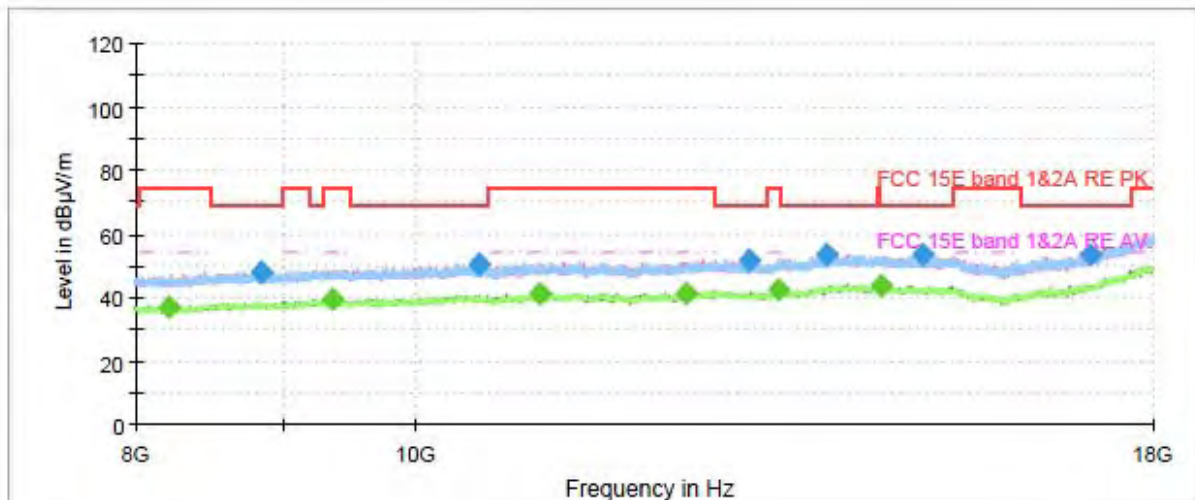

Radiates Emission from 8GHz to 18GHz



Frequency (MHz)	Peak (dBuV/m)	Average (dBuV/m)	Limit (dBuV/m)	Margin (dB)	Height (cm)	Polarization	Azimuth (deg)	Correct Factor (dB)
1096.600000	---	34.83	54.00	19.17	200.0	V	117.0	-11.0
1296.800000	45.59	---	68.20	22.61	100.0	V	1.0	-9.9
1407.400000	---	35.67	54.00	18.33	100.0	H	327.0	-9.3
1973.700000	47.48	---	68.20	20.72	200.0	H	111.0	-8.1
2593.433333	48.45	---	68.20	19.75	200.0	V	245.0	-6.1
2795.500000	---	38.94	54.00	15.06	200.0	H	125.0	-6.0
3547.766667	49.59	---	68.20	18.61	200.0	V	356.0	-4.6
3952.366667	---	40.78	54.00	13.22	200.0	V	0.0	-3.2
4430.933333	50.74	---	68.20	17.46	100.0	V	1.0	-1.7
4610.600000	---	42.03	54.00	11.97	200.0	V	258.0	-0.8
7729.800000	---	48.00	54.00	6.00	100.0	H	358.0	7.0
7770.400000	58.12	---	68.20	10.08	100.0	V	130.0	7.0

Remark: 1. Correction Factor = Antenna factor+ Insertion loss (cable loss + amplifier gain)

802.11ac (VHT80) CH106

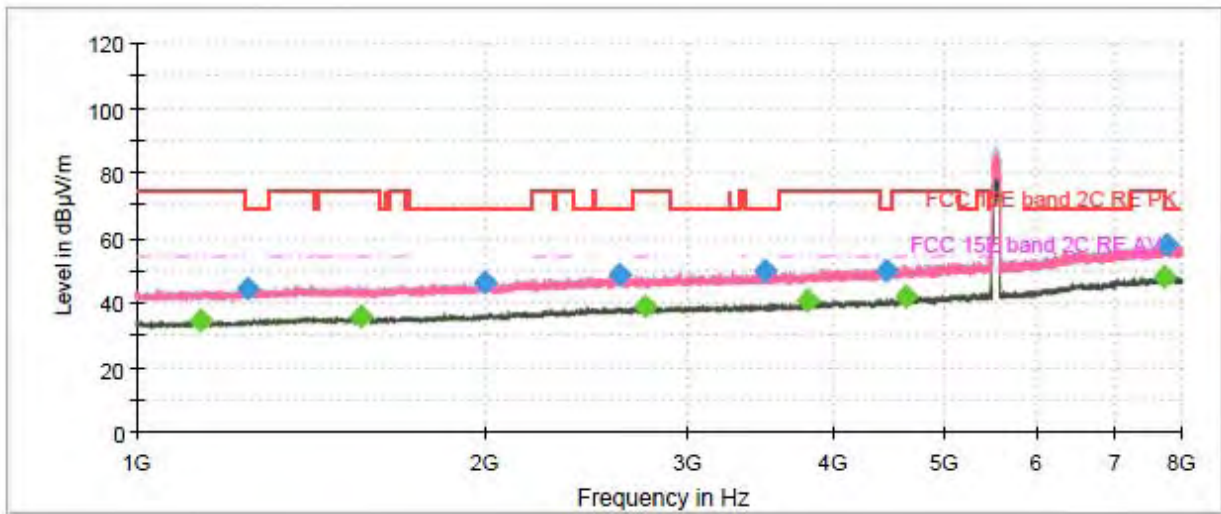

Radiates Emission from 1GHz to 8GHz
 Note: The signal beyond the limit is carrier.

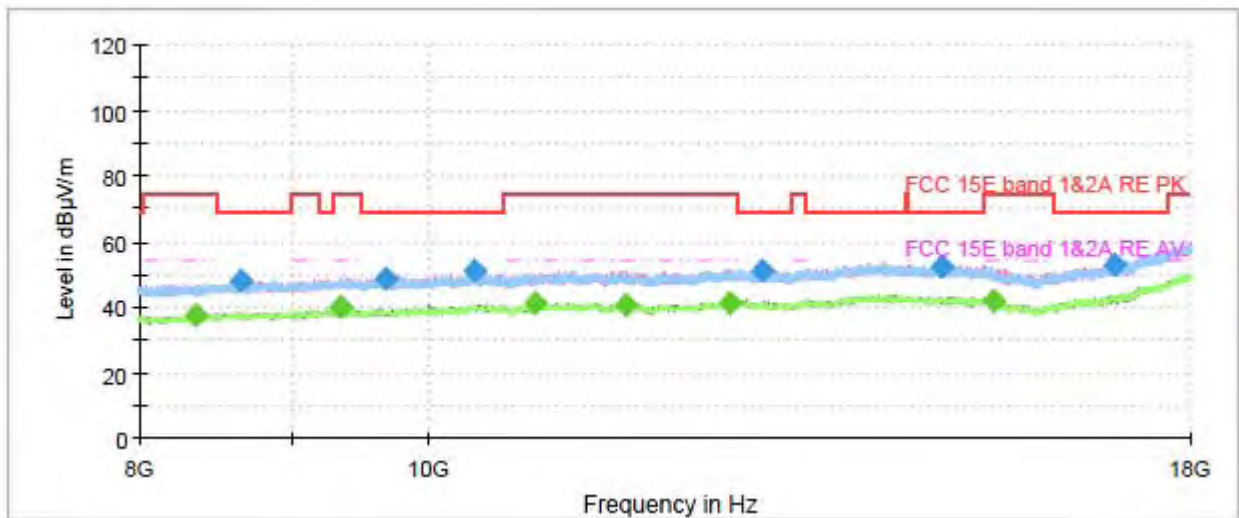

Radiates Emission from 8GHz to 18GHz



Frequency (MHz)	Peak (dBuV/m)	Average (dBuV/m)	Limit (dBuV/m)	Margin (dB)	Height (cm)	Polarization	Azimuth (deg)	Correct Factor (dB)
1136.966667	---	34.37	54.00	19.63	200.0	H	159.0	-10.9
1249.900000	44.47	---	68.20	23.73	100.0	H	303.0	-10.2
1565.366667	---	35.84	54.00	18.16	100.0	V	0.0	-9.1
1998.666667	46.24	---	68.20	21.96	200.0	H	21.0	-7.9
2609.533333	48.67	---	68.20	19.53	200.0	V	352.0	-6.1
2754.666667	---	38.94	54.00	15.06	100.0	H	358.0	-6.1
3493.166667	49.91	---	68.20	18.29	200.0	V	352.0	-4.8
3805.133333	---	40.50	54.00	13.50	100.0	H	356.0	-3.9
4453.100000	49.96	---	68.20	18.24	100.0	V	333.0	-1.6
4630.900000	---	41.86	54.00	12.14	100.0	V	143.0	-0.7
7720.700000	---	48.07	54.00	5.93	100.0	H	353.0	7.0
7764.333333	57.69	---	68.20	10.51	100.0	H	162.0	7.0

Remark: 1. Correction Factor = Antenna factor+ Insertion loss (cable loss + amplifier gain)

802.11ac (VHT80) CH122

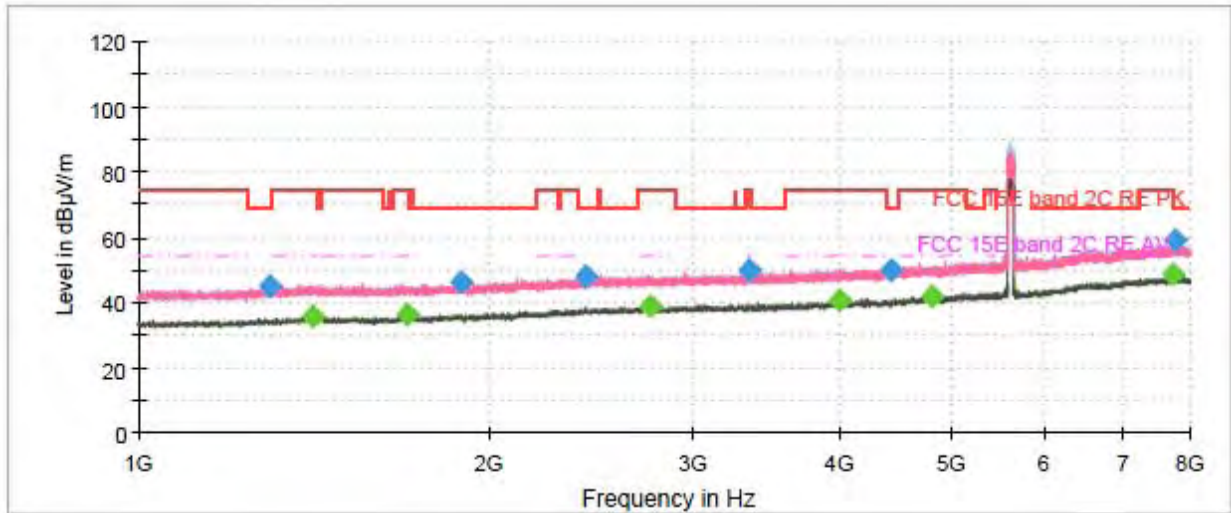

Radiates Emission from 1GHz to 8GHz
 Note: The signal beyond the limit is carrier.

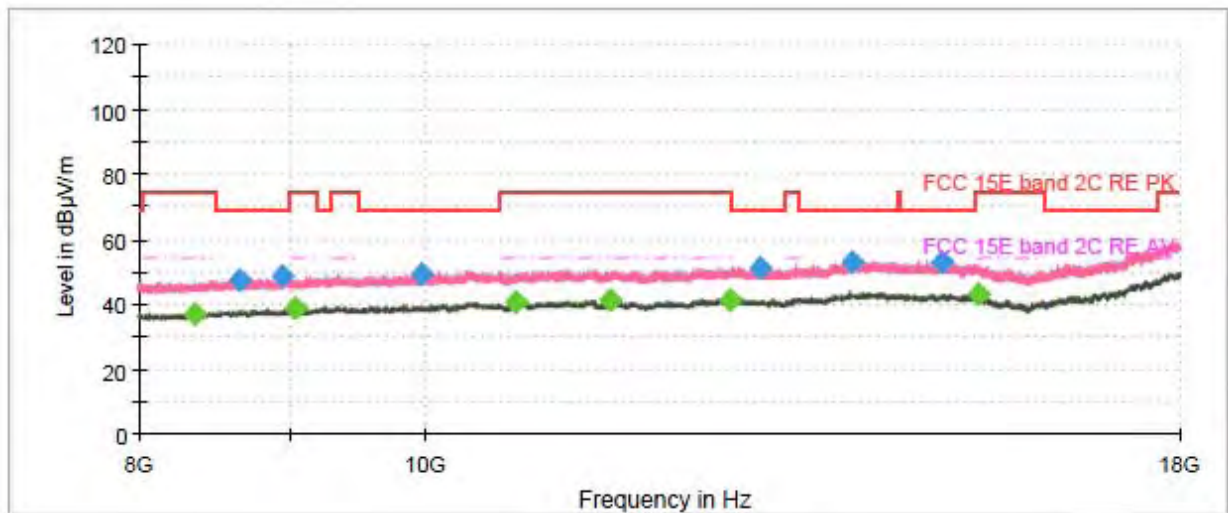

Radiates Emission from 8GHz to 18GHz



Frequency (MHz)	Peak (dBuV/m)	Average (dBuV/m)	Limit (dBuV/m)	Margin (dB)	Height (cm)	Polarization	Azimuth (deg)	Correct Factor (dB)
1296.566667	44.69	---	68.20	23.51	200.0	V	173.0	-9.9
1409.033333	---	35.98	54.00	18.02	200.0	H	29.0	-9.3
1699.533333	---	36.40	54.00	17.60	100.0	V	12.0	-8.9
1889.700000	46.42	---	68.20	21.78	100.0	V	0.0	-8.4
2423.100000	48.15	---	68.20	20.05	200.0	H	152.0	-6.5
2750.000000	---	38.83	54.00	15.17	100.0	V	0.0	-6.1
3344.533333	49.55	---	68.20	18.65	200.0	V	102.0	-5.1
3999.500000	---	40.69	54.00	13.31	100.0	H	346.0	-2.9
4431.633333	49.97	---	68.20	18.23	100.0	V	7.0	-1.7
4793.766667	---	41.72	54.00	12.28	200.0	V	229.0	-0.3
7745.200000	---	48.36	54.00	5.64	100.0	V	0.0	7.0
7752.666667	59.14	---	68.20	9.06	100.0	V	153.0	7.0

Remark: 1. Correction Factor = Antenna factor+ Insertion loss (cable loss + amplifier gain)

802.11ac (VHT80) CH138

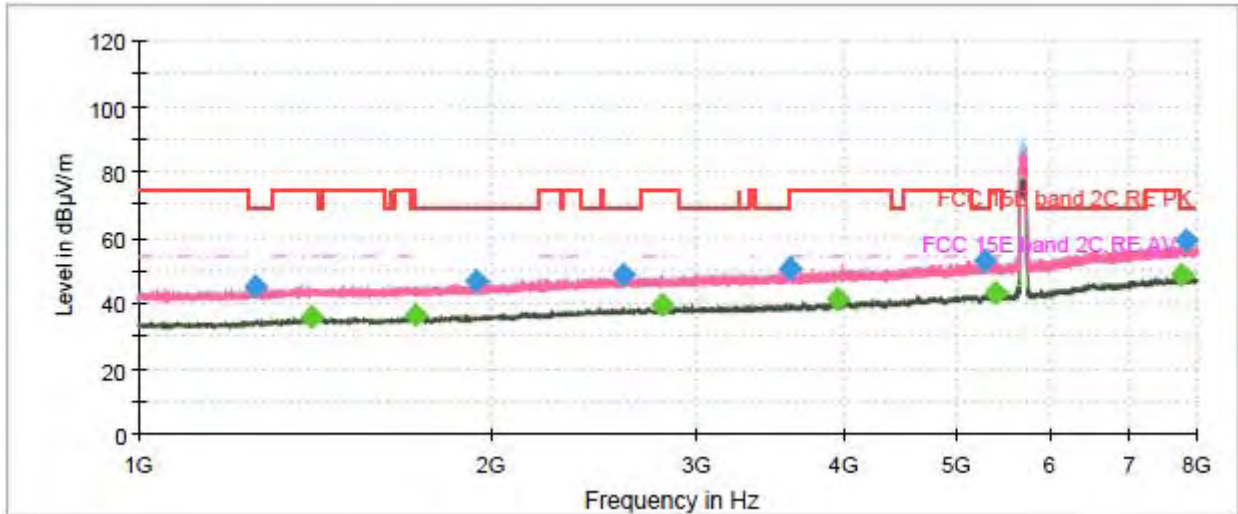

Radiates Emission from 1GHz to 8GHz
 Note: The signal beyond the limit is carrier.

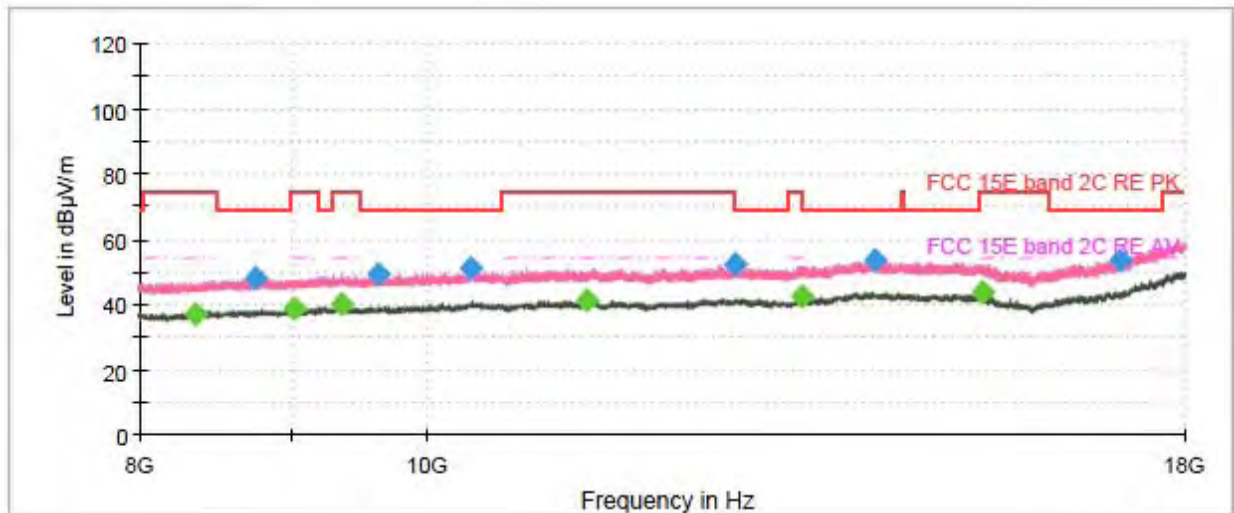

Radiates Emission from 8GHz to 18GHz



Frequency (MHz)	Peak (dBuV/m)	Average (dBuV/m)	Limit (dBuV/m)	Margin (dB)	Height (cm)	Polarization	Azimuth (deg)	Correct Factor (dB)
1257.833333	45.12	---	68.20	23.08	200.0	V	338.0	-10.2
1405.766667	---	35.95	54.00	18.05	200.0	V	338.0	-9.3
1721.933333	---	36.04	54.00	17.96	100.0	H	0.0	-8.9
1944.766667	46.64	---	68.20	21.56	100.0	V	83.0	-8.2
2590.866667	48.87	---	68.20	19.33	100.0	V	238.0	-6.1
2793.633333	---	39.19	54.00	14.81	200.0	H	2.0	-6.0
3590.700000	50.23	---	68.20	17.97	100.0	H	0.0	-4.5
3954.933333	---	41.23	54.00	12.77	100.0	V	195.0	-3.2
5268.833333	52.66	---	68.20	15.54	200.0	V	286.0	1.0
5390.633333	---	43.10	54.00	10.90	100.0	H	58.0	1.4
7749.633333	---	48.56	54.00	5.44	100.0	V	316.0	7.0
7821.033333	59.18	---	68.20	9.02	100.0	V	0.0	7.0

Remark: 1. Correction Factor = Antenna factor+ Insertion loss (cable loss + amplifier gain)



During the test, the Radiates Emission from 18GHz to 40GHz was performed in all modes with all channels, 802.11ac (VHT20), Channel 52 are selected as the worst condition. The test data of the worst-case condition was recorded in this report.

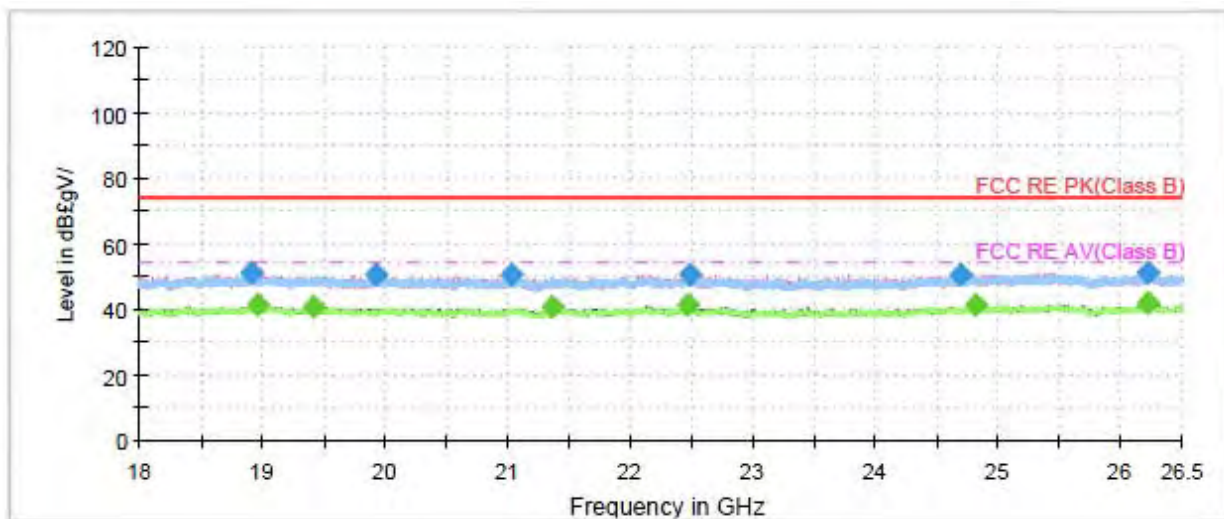

Radiates Emission from 18GHz to 26.5GHz

Frequency (MHz)	Peak (dBuV/m)	Average (dBuV/m)	Limit (dBuV/m)	Margin (dB)	Height (cm)	Polarization	Azimuth (deg)	Correct Factor (dB)
18914.033333	51.01	---	74.00	22.99	100.0	H	22.0	-2
18955.400000	---	41.25	54.00	12.75	100.0	V	323.0	-1
19417.233333	---	40.66	54.00	13.34	100.0	V	123.0	-1
19932.050000	50.31	---	74.00	23.69	200.0	H	359.0	-1
21026.283333	50.55	---	74.00	23.45	200.0	H	359.0	0
21370.816667	---	40.69	54.00	13.31	200.0	H	210.0	0
22474.116667	---	41.02	54.00	12.98	100.0	H	186.0	2
22484.883333	50.59	---	74.00	23.41	200.0	H	278.0	2
24697.433333	50.48	---	74.00	23.52	100.0	H	139.0	3
24809.066667	---	40.94	54.00	13.06	100.0	H	29.0	3
26225.166667	---	41.76	54.00	12.24	100.0	H	22.0	3
26225.450000	51.24	---	74.00	22.76	100.0	H	132.0	3

Remark: 1. Correction Factor = Antenna factor+ Insertion loss (cable loss + amplifier gain)

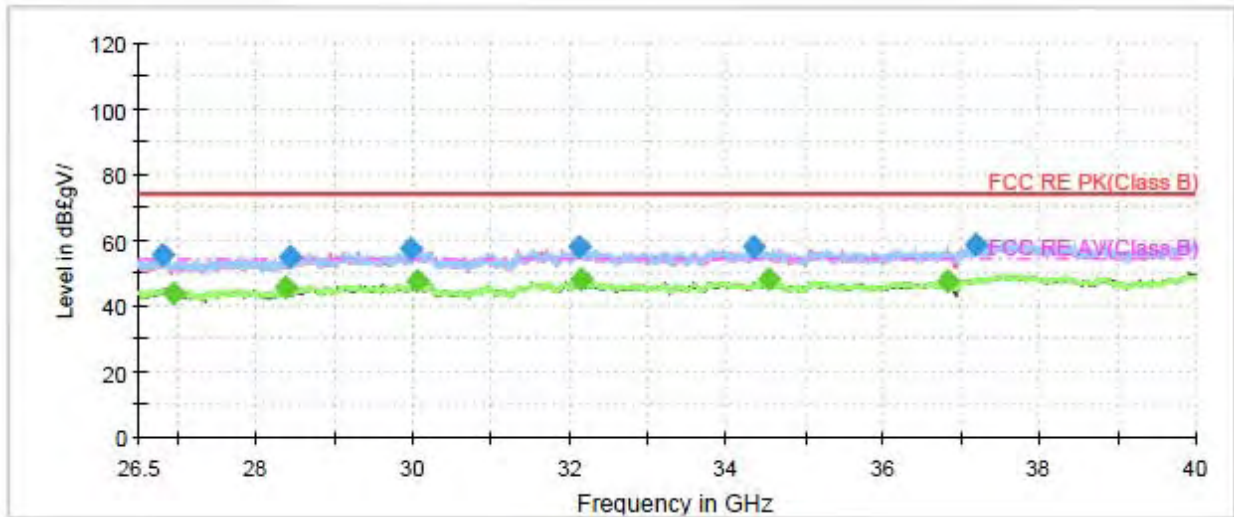

Radiates Emission from 26.5GHz to 40GHz

Frequency (MHz)	Peak (dBuV/m)	Average (dBuV/m)	Limit (dBuV/m)	Margin (dB)	Height (cm)	Polarization	Azimuth (deg)	Correct Factor (dB)
26800.150000	55.24	---	74.00	18.76	100.0	H	152.0	8
26943.250000	---	43.67	54.00	10.33	200.0	H	350.0	7
28373.350000	---	45.63	54.00	8.37	200.0	V	243.0	7
28419.700000	54.57	---	74.00	19.43	100.0	H	0.0	7
29969.500000	57.41	---	74.00	16.59	200.0	H	0.0	7
30061.300000	---	47.57	54.00	6.43	200.0	V	301.0	7
32131.750000	57.64	---	74.00	16.36	200.0	H	302.0	8
32136.250000	---	48.29	54.00	5.71	100.0	V	193.0	8
34361.050000	57.55	---	74.00	16.45	100.0	H	251.0	8
34558.600000	---	47.72	54.00	6.28	200.0	H	253.0	8
36823.450000	---	47.40	54.00	6.60	200.0	V	0.0	9
37183.450000	58.52	---	74.00	15.48	200.0	H	81.0	10

Remark: 1. Correction Factor = Antenna factor+ Insertion loss (cable loss + amplifier gain)

5.6. Conducted Emission

Ambient condition

Temperature	Relative humidity	Pressure
23°C ~25°C	45%~50%	101.5kPa

Methods of Measurement

The EUT IS placed on a non-metallic table of 80cm height above the horizontal metal reference ground plane. During the test, the EUT was operating in its typical mode. The test method is according to ANSI C63.10. Connect the AC power line of the EUT to the LISN Use EMI receiver to detect the average and Quasi-peak value. RBW is set to 9kHz, VBW is set to 30kHz The measurement result should include both L line and N line.

The test is in transmitting mode.

Test Setup

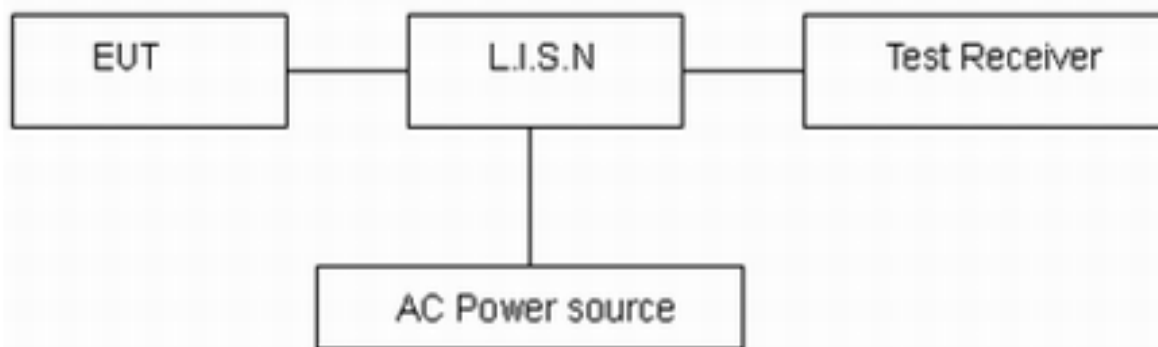

Note: AC Power source is used to change the voltage 110V/60Hz.

Limits

Frequency (MHz)	Conducted Limits(dBμV)	
	Quasi-peak	Average
0.15 - 0.5	66 to 56 *	56 to 46 *
0.5 - 5	56	46
5 - 30	60	50

*: Decreases with the logarithm of the frequency.

Measurement Uncertainty

The assessed measurement uncertainty to ensure 95% confidence level for the normal distribution is with the coverage factor $k = 1.96$, $U = 2.69$ dB.

Test Results:

Following plots, Blue trace uses the peak detection and Green trace uses the average detection. During the test, the Conducted Emission was performed in all modes with all channels, 802.11ac (VHT20), Channel 52 is selected as the worst condition. The test data of the worst-case condition was recorded in this report.

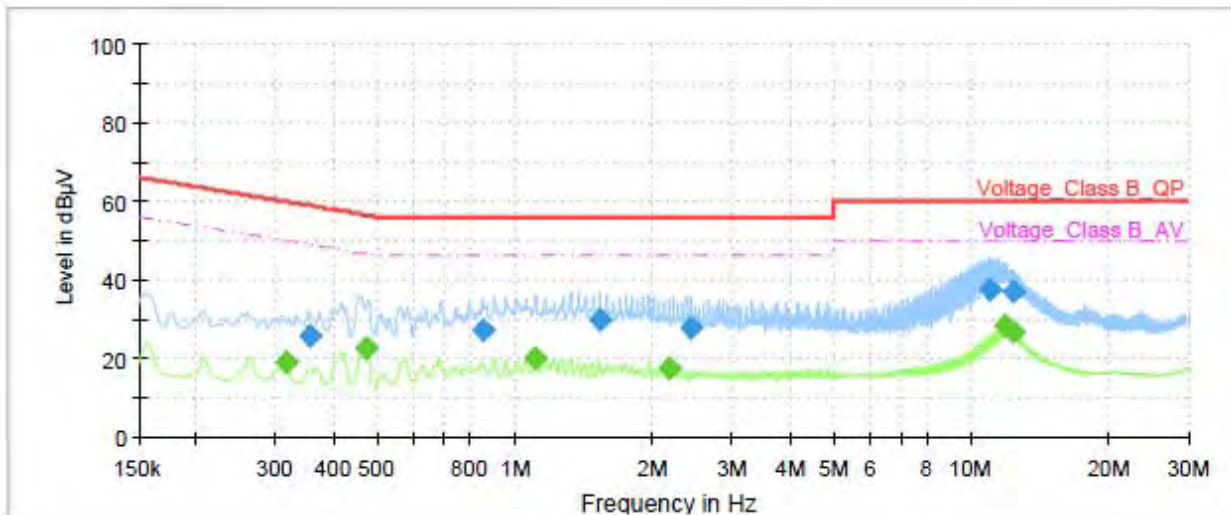

Frequency (MHz)	QuasiPeak (dBµV)	Average (dBµV)	Limit (dBµV)	Margin (dB)	Meas. Time (ms)	Bandwidth (kHz)	Line	Filter	Corr. (dB)
0.31	---	19.15	49.86	30.71	70.0	9.000	L1	ON	21
0.35	25.55	---	58.85	33.30	70.0	9.000	L1	ON	21
0.47	---	22.49	46.44	23.95	70.0	9.000	L1	ON	20
0.85	27.33	---	56.00	28.67	70.0	9.000	L1	ON	20
1.11	---	19.80	46.00	26.20	70.0	9.000	L1	ON	20
1.54	29.59	---	56.00	26.41	70.0	9.000	L1	ON	20
2.17	---	17.61	46.00	28.39	70.0	9.000	L1	ON	20
2.44	27.84	---	56.00	28.16	70.0	9.000	L1	ON	19
11.04	37.28	---	60.00	22.72	70.0	9.000	L1	ON	20
11.88	---	27.99	50.00	22.01	70.0	9.000	L1	ON	20
12.44	37.17	---	60.00	22.83	70.0	9.000	L1	ON	20
12.44	---	26.56	50.00	23.44	70.0	9.000	L1	ON	20

Remark: Correct factor=cable loss + LISN factor

L line Conducted Emission from 150 KHz to 30 MHz

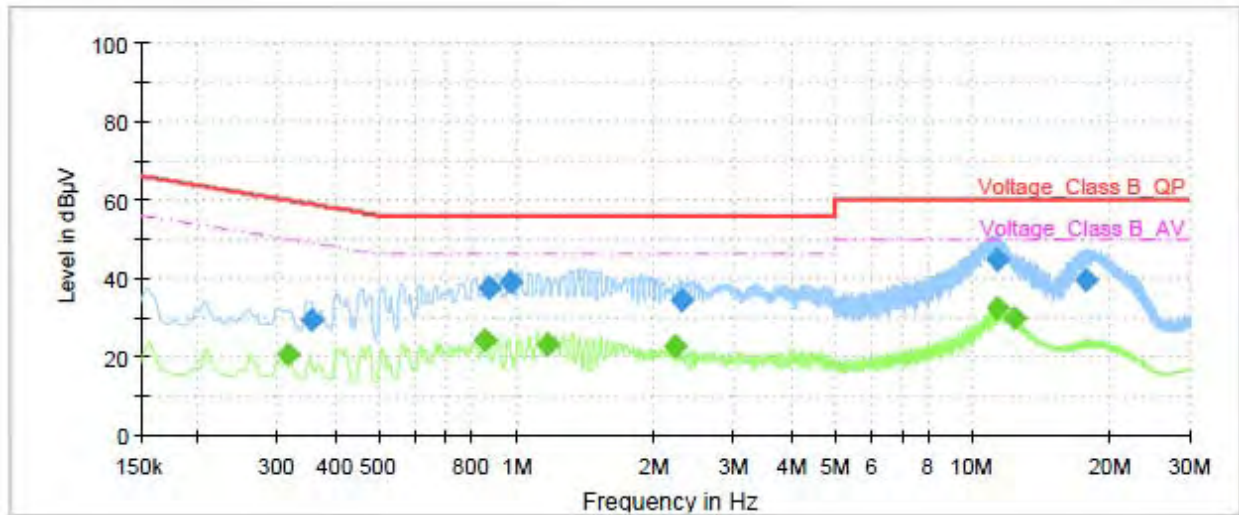

Frequency (MHz)	QuasiPeak (dBµV)	Average (dBµV)	Limit (dBµV)	Margin (dB)	Meas. Time (ms)	Bandwidth (kHz)	Line	Filter	Corr. (dB)
0.31	---	20.61	49.86	29.25	70.0	9.000	N	ON	21
0.35	29.47	---	58.85	29.38	70.0	9.000	N	ON	21
0.85	---	24.26	46.00	21.74	70.0	9.000	N	ON	20
0.87	37.27	---	56.00	18.73	70.0	9.000	N	ON	20
0.97	38.77	---	56.00	17.23	70.0	9.000	N	ON	20
1.17	---	22.90	46.00	23.10	70.0	9.000	N	ON	20
2.23	---	22.68	46.00	23.32	70.0	9.000	N	ON	20
2.30	34.20	---	56.00	21.80	70.0	9.000	N	ON	20
11.31	---	32.27	50.00	17.73	70.0	9.000	N	ON	20
11.32	44.79	---	60.00	15.21	70.0	9.000	N	ON	20
12.44	---	29.53	50.00	20.47	70.0	9.000	N	ON	20
17.70	39.60	---	60.00	20.40	70.0	9.000	N	ON	20

Remark: Correct factor=cable loss + LISN factor

N line Conducted Emission from 150 KHz to 30 MHz



6. Main Test Instruments

Name	Manufacturer	Type	Serial Number	Calibration Date	Expiration Date
Spectrum Analyzer	R&S	FSV40	15195-01-00	2021-05-15	2022-05-14
EMI Test Receiver	R&S	ESCI	100948	2021-05-15	2022-05-14
Loop Antenna	SCHWARZBECK	FMZB1519	1519-047	2020-04-02	2023-04-01
TRILOG Broadband Antenna	SCHWARZBECK	VULB 9163	391	2019-12-16	2022-12-15
Horn Antenna	R&S	HF907	102723	2020-08-11	2023-08-10
Horn Antenna	ETS-Lindgren	3160-09	00102643	2018-06-20	2023-06-19
Standard Gain Horn	STEATITE	QSH-SL-26-40 -K-15	16779	2019-12-24	2022-12-23
Broadband Horn Antenna	SCHWARZBECK	BBHA 9120D	430	2018-07-07	2023-07-06
EMI Test Receiver	R&S	ESR	101667	2021-05-16	2022-05-15
LISN	R&S	ENV216	101171	2018-12-15	2021-12-14
RF Cable	Agilent	SMA 15cm	0001	2021-06-09	2021-12-08
TEMPERATURE CHAMBER	WEISS	VT4002	582261194500 10	2020-12-13	2021-12-12
WLAN AP	Cisco	Air-AP1262N- A-K9	LDK102073 (FCC ID)	/	/
Power Sensor	R&S	NRP18S	101955	2021-05-15	2022-05-14
DC Power Supply	GWINSTEK	GPS-3030D	GEP882653	2021-05-15	2022-05-14
Software	R&S	EMC32	9.26.0	/	/

*****END OF REPORT *****



ANNEX A: The EUT Appearance

The EUT Appearance are submitted separately.



ANNEX B: Test Setup Photos

The Test Setup Photos are submitted separately.