

<b>Prüfbericht-Nr.:</b> <i>Test report no.:</i>	<b>60443733 001</b>	<b>Auftrags-Nr.:</b> <i>Order no.:</i>	168266574	Seite 1 von 21 <i>Page 1 of 21</i>	
<b>Kunden-Referenz-Nr.:</b> <i>Client reference no.:</i>	N/A	<b>Auftragsdatum:</b> <i>Order date:</i>	2020-05-15		
<b>Auftraggeber:</b> <i>Client:</i>	<b>Sensitech Inc.</b> 800 Cummings Center Suite 258X, Beverly MA 01915-6197 USA				
<b>Prüfgegenstand:</b> <i>Test item:</i>	Sensor				
<b>Bezeichnung / Typ-Nr.:</b> <i>Identification / Type no.:</i>	T11012920				
<b>Auftrags-Inhalt:</b> <i>Order content:</i>	FCC Test Report				
<b>Prüfgrundlage:</b> <i>Test specification:</i>	CFR47 FCC Part 15: Subpart C Section 15.247 CFR47 FCC Part 15: Subpart C Section 15.207 CFR47 FCC Part 15: Subpart C Section 15.209 CFR47 FCC Part 2: Section 2.1093				
<b>Wareneingangsdatum:</b> <i>Date of sample receipt:</i>	2020-05-15	Please refer to photo documents			
<b>Prüfmuster-Nr.:</b> <i>Test sample no.:</i>	A002920612-006				
<b>Prüfzeitraum:</b> <i>Testing period:</i>	2020-11-02 - 2021-07-01				
<b>Ort der Prüfung:</b> <i>Place of testing:</i>	TÜV Rheinland (Shenzhen) Co., Ltd.				
<b>Prüflaboratorium:</b> <i>Testing laboratory:</i>	TÜV Rheinland (Shenzhen) Co., Ltd.				
<b>Prüfergebnis*:</b> <i>Test result*:</i>	Pass				
<b>geprüft von:</b> <i>tested by:</i>	<b>genehmigt von:</b> <i>authorized by:</i>				
<b>Datum:</b> <i>Date:</i> 2022-06-29	<b>Ausstellungsdatum:</b> <i>Issue date:</i> 2022-06-30				
<b>Stellung / Position</b>	Project Manager	<b>Stellung / Position</b>	Review er		
<b>Sonstiges / Other:</b>	FCC ID: SRMT11012920				
<b>Zustand des Prüfgegenstandes bei Anlieferung:</b> <i>Condition of the test item at delivery:</i>	Prüfmuster vollständig und unbeschädigt <i>Test item complete and undamaged:</i>				
<b>Legende:</b> <i>Legend:</i>	1 = sehr gut P(ass) = entspricht o.g. Prüfgrundlage(n)	2 = gut 2 = good	3 = befriedigend 3 = satisfactory F(ail) = entspricht nicht o.g. Prüfgrundlage(n)	4 = ausreichend 4 = sufficient N/A = nicht anwendbar	5 = mangelhaft 5 = poor N/T = nicht getestet
	P(ass) = passed a.m. test specifications(s)		F(ail) = failed a.m. test specifications(s)	N/A = not applicable N/T = not tested	
<p><b>Dieser Prüfbericht bezieht sich nur auf das o.g. Prüfmuster und darf ohne Genehmigung der Prüfstelle nicht auszugsweise vervielfältigt werden. Dieser Bericht berechtigt nicht zur Verwendung eines Prüfzeichens.</b></p> <p><i>This test report only relates to the a. m. test sample. Without permission of the test center this test report is not permitted to be duplicated in extracts. This test report does not entitle to carry any test mark.</i></p>					

## **Test Summary**

**5.1.1 ANTENNA REQUIREMENT***RESULT: Pass***5.1.2 MAXIMUM PEAK CONDUCTED OUTPUT POWER***RESULT: Pass***5.1.3 20dB&99% BANDWIDTH***RESULT: Pass***5.1.4 CONDUCTED SPURIOUS EMISSIONS MEASURED IN 100 KHz BANDWIDTH***RESULT: Pass***5.1.5 RADIATED SPURIOUS EMISSION***RESULT: Pass***5.1.6 CARRIER FREQUENCY SEPARATION***RESULT: Pass***5.1.7 NUMBER OF HOPPING FREQUENCY***RESULT: Pass***5.1.8 TIME OF OCCUPANCY***RESULT: Pass***6.1.1 ELECTROMAGNETIC FIELDS***RESULT: Pass*

## Contents

<b>1</b>	<b>GENERAL REMARKS</b> .....	<b>4</b>
<b>1.1</b>	<b>COMPLEMENTARY MATERIALS</b> .....	<b>4</b>
<b>2</b>	<b>TEST SITES</b> .....	<b>4</b>
<b>2.1</b>	<b>TEST FACILITIES</b> .....	<b>4</b>
<b>2.2</b>	<b>LIST OF TEST AND MEASUREMENT INSTRUMENTS</b> .....	<b>5</b>
<b>2.3</b>	<b>TRACEABILITY</b> .....	<b>6</b>
<b>2.4</b>	<b>CALIBRATION</b> .....	<b>6</b>
<b>2.5</b>	<b>MEASUREMENT UNCERTAINTY</b> .....	<b>6</b>
<b>2.6</b>	<b>LOCATION OF ORIGINAL DATA</b> .....	<b>6</b>
<b>2.7</b>	<b>STATUS OF FACILITY USED FOR TESTING</b> .....	<b>6</b>
<b>3</b>	<b>GENERAL PRODUCT INFORMATION</b> .....	<b>7</b>
<b>3.1</b>	<b>PRODUCT FUNCTION AND INTENDED USE</b> .....	<b>7</b>
<b>3.2</b>	<b>RATINGS AND SYSTEM DETAILS</b> .....	<b>7</b>
<b>3.3</b>	<b>INDEPENDENT OPERATION MODES</b> .....	<b>8</b>
<b>3.4</b>	<b>NOISE GENERATING AND NOISE SUPPRESSING PARTS</b> .....	<b>8</b>
<b>3.5</b>	<b>SUBMITTED DOCUMENTS</b> .....	<b>8</b>
<b>4</b>	<b>TEST SET-UP AND OPERATION MODES</b> .....	<b>9</b>
<b>4.1</b>	<b>PRINCIPLE OF CONFIGURATION SELECTION</b> .....	<b>9</b>
<b>4.2</b>	<b>TEST OPERATION AND TEST SOFTWARE</b> .....	<b>9</b>
<b>4.3</b>	<b>SPECIAL ACCESSORIES AND AUXILIARY EQUIPMENT</b> .....	<b>9</b>
<b>4.4</b>	<b>COUNTERMEASURES TO ACHIEVE EMC COMPLIANCE</b> .....	<b>9</b>
<b>4.5</b>	<b>TEST SETUP DIAGRAM</b> .....	<b>10</b>
<b>5</b>	<b>TEST RESULTS</b> .....	<b>12</b>
<b>5.1</b>	<b>TRANSMITTER REQUIREMENT &amp; TEST SUITES</b> .....	<b>12</b>
<b>5.1.1</b>	<i>Antenna Requirement</i> .....	<b>12</b>
<b>5.1.2</b>	<i>Maximum Peak Conducted Output Power</i> .....	<b>13</b>
<b>5.1.3</b>	<i>20dB Bandwidth</i> .....	<b>14</b>
<b>5.1.4</b>	<i>Conducted Spurious Emissions Measured in 100 kHz Bandwidth</i> .....	<b>15</b>
<b>5.1.5</b>	<i>Radiated Spurious Emission</i> .....	<b>16</b>
<b>5.1.6</b>	<i>Carrier Frequency Separation</i> .....	<b>17</b>
<b>5.1.7</b>	<i>Number of Hopping Frequency</i> .....	<b>18</b>
<b>5.1.8</b>	<i>Time of Occupancy</i> .....	<b>19</b>
<b>5.1.9</b>	<i>Conducted Emission on AC Mains</i> .....	<b>Error! Bookmark not defined.</b>
<b>6</b>	<b>SAFETY HUMAN EXPOSURE</b> .....	<b>20</b>
<b>6.1</b>	<b>RADIO FREQUENCY EXPOSURE COMPLIANCE</b> .....	<b>20</b>
<b>6.1.1</b>	<i>Electromagnetic Fields</i> .....	<b>20</b>
<b>7</b>	<b>PHOTOGRAPHS OF THE TEST SET-UP</b> .....	<b>21</b>
<b>8</b>	<b>LIST OF TABLES</b> .....	<b>21</b>

# 1 General Remarks

## 1.1 Complementary Materials

All attachments are integral parts of this test report. This applies especially to the following appendix:

Appendix A: Photographs of the Test Set-up

Appendix B: Test Results.

# 2 Test Sites

## 2.1 Test Facilities

**TÜV Rheinland (Shenzhen) Co., Ltd.**

362 Huanguan Road Middle Longhua District, Shenzhen 518110 People's Republic of China

FCC Registration No.: 694916

## 2.2 List of Test and Measurement Instruments

**Table 1: List of Test and Measurement Equipment**

TÜV Rheinland (Shenzhen) Co., Ltd.

<b>Radio Spectrum Testing (TS8997) (TÜVR)</b>				
<b>Equipment</b>	<b>Manufacturer</b>	<b>Model</b>	<b>Serial No.</b>	<b>Cal. until</b>
Signal Analyzer	R&S	FSV 40	101441	10.08.2021
OSP	R&S	OSP 150	101017	10.12.2021
Control PC	DELL	OptiPlex 7050	FTJZ9P2	N/A
Test Software	R&S	WMS32 (V11.00.00)	N/A	N/A
Power Meter	R&S	NRP2	107105	10.12.2021
Power Sensor	R&S	NRP-Z81	105677	10.09.2021
Shielding Room 8#	Albatross	SR8	APC17151-SR8	23.07.2021
<b>Unwanted Emission Testing (TS9975) (TÜVR)</b>				
<b>Equipment</b>	<b>Manufacturer</b>	<b>Model</b>	<b>Serial No.</b>	<b>Cal. until</b>
EMI Test Receiver	R&S	ESR 7	102021	11.08.2021
Signal Analyzer	R&S	FSV 40	101439	10.08.2021
System Controller Interface	R&S	SCI-100	S10010038	N/A
Filterbank	R&S	Wlan	100759	10.08.2021
OSP	R&S	OSP 120	102040	N/A
Pre-amplifier	R&S	SCU08F1	08320031	10.08.2021
Amplifier	R&S	SCU-18F	180070	10.08.2021
Amplifier	R&S	SCU40A	100475	10.09.2021
Trilog Broadband Antenna (30 MHz - 7 GHz)	Schwarzbeck	VULB 9162	193	08.08.2022
Double-Ridged Antenna (1 -18 GHz)	ETS-LINDGREN	3117	00218717	08.08.2022
Wideband Ridged Horn Antenna (18-40 GHz)	Steatite	QMS-00880	19067	08.08.2022
Active Loop Antenna	Schwarzbeck	FMZB 1513	302	13.09.2022
Wideband Ridged Horn Antenna (12-18 GHz)	Steatite	QMS-00208	18313	02.09.2021
Test software	R&S	EMC32 (V10.60.10)	N/A	N/A
Control PC	Dell	OptiPlex 7050	36NV9P2	N/A

## 2.3 Traceability

All measurement equipment calibrations are traceable to NIM (National Institute of Metrology) or where calibration is performed in other countries, to equivalent nationally recognized standards organizations.

## 2.4 Calibration

Equipment requiring calibration is calibrated periodically by the manufacturer or according to manufacturer's specifications. Additionally all equipment is verified for proper performance on a regular basis using in house standards or comparisons.

## 2.5 Measurement Uncertainty

The estimated combined standard uncertainty for radiated emissions and conducted emissions measurements as below table.

Parameter	Uncertainty
Radio Frequency	$\pm 1 \times 10^{-7}$
RF Power (conducted)	$\pm 2.5$ dB
Radiated Emission of Transmitter, valid up to 26.5 GHz	$\pm 6$ dB
Radiated Emission of Receiver, valid up to 26.5 GHz	$\pm 6$ dB
Conducted Emission, (9kHz to 150kHz)/(150kHz to 30MHz)	$\pm 3.2$ dB / $\pm 2.7$ dB
Radiated Emission (3m SAC), 30MHz to 1000MHz	$\pm 4.52$ dB
Radiated Emission (3m SAC), above 1000MHz	$\pm 4.37$ dB
Temperature	$\pm 1$ °C
Humidity	$\pm 5$ %
Voltage (DC)	$\pm 1$ %
Voltage (AC, <10kHz)	$\pm 2$ %

## 2.6 Location of Original Data

The original copies of all test data taken during actual testing were attached at Appendix A & B of this report and delivered to the applicant. A copy has been retained in the TÜV Rheinland (Shenzhen) Co., Ltd. file for certification follow-up purposes.

## 2.7 Status of Facility Used for Testing

The TÜV Rheinland (Shenzhen) Co., Ltd. Test facility located at 362 Huanguan Road Middle Longhua District, Shenzhen 518110 People's Republic of China is listed on the US Federal Communications Commission list of facilities approved to perform measurements.

### 3 General Product Information

#### 3.1 Product Function and Intended Use

The T11012860 (sensor) support the 915MHz wireless technology to communicate with the Gateway.

For details refer to the User Manual, Technical Description and Circuit Diagram.

#### 3.2 Ratings and System Details

Table 2: Technical Specification of EUT

General Information of EUT	Value
Kind of Equipment	Sensor
Type Designation	T11012920
FCC ID	SRMT11012920
Operating Voltage	Non-rechargeable Battery Pack, 3.0V
Testing Voltage	Battery (Full of electricity)
Antenna Type	Integral Antenna
Antenna Gain	0 dBi (Max)

Technical Specification of FHSS	
Frequency Range	902.306 - 922.396MHz
Type of Modulation	GFSK
Data Rate	Up to 250Kbps
Channel Number	50 channels
Channel Separation	410 KHz

**Table 3: RF Channel and Frequency of Lora FHSS**

RF Channel	Frequency (MHz)	RF Channel	Frequency (MHz)	RF Channel	Frequency (MHz)	RF Channel	Frequency (MHz)
1	<b>902.306</b>	17	908.866	33	915.426	49	921.986
2	902.716	18	909.276	34	915.836	<b>50</b>	<b>922.396</b>
3	903.126	19	909.686	35	916.246		
4	903.536	20	910.096	36	916.656		
5	903.946	21	910.506	37	917.066		
6	904.356	22	910.916	38	917.476		
7	904.766	23	911.326	39	917.886		
8	905.176	24	911.736	40	918.296		
9	905.586	<b>25</b>	912.146	41	918.706		
10	905.996	26	912.556	42	919.116		
11	906.406	27	912.966	43	919.526		
12	906.816	28	913.376	44	919.936		
13	907.226	29	913.786	45	920.346		
14	907.636	30	914.196	46	920.756		
15	908.046	31	914.606	47	921.166		
16	908.456	32	915.016	48	921.576		

### 3.3 Independent Operation Modes

The basic operation modes are:

- A. On, transmitting mode
  - 1) Low Channel
  - 2) Middle Channel
  - 3) High Channel
- B. On, Transmitting on Hopping channel
- C. On, Normal Operation (Radio Link)
- D. Off

### 3.4 Noise Generating and Noise Suppressing Parts

Refer to Circuit Diagram for further details.

### 3.5 Submitted Documents

- ID Label and Location Info

- User Manual



## 4 Test Set-up and Operation Modes

### 4.1 Principle of Configuration Selection

**Radio Spectrum:** The equipment under test (EUT) was configured at its highest power output in order to measure its highest possible radiation and conducted level. The test modes were adapted accordingly in reference to the instructions for use.

**Emission:** The equipment under test (EUT) was configured to measure its highest possible radiation level. The test modes were adapted accordingly in reference to the instructions for use.

### 4.2 Test Operation and Test Software

Test operation refers to test setup in chapter 5. All tests were performed according to the procedures in ANSI C63.10: 2013.

### 4.3 Special Accessories and Auxiliary Equipment

Table 4: Auxiliary Equipment Used during Test

Description	Manufacturer	Model	S/N	Rating
Sensor	Sensitech Inc.	T11012860	N/A	

### 4.4 Countermeasures to Achieve EMC Compliance

The test sample which has been tested contained the noise suppression parts as described in the Technical Construction File (TCF).

No additional measures were employed to achieve compliance.

## 4.5 Test Setup Diagram

Diagram of Measurement Configuration for Radiation Test (Below 30MHz)

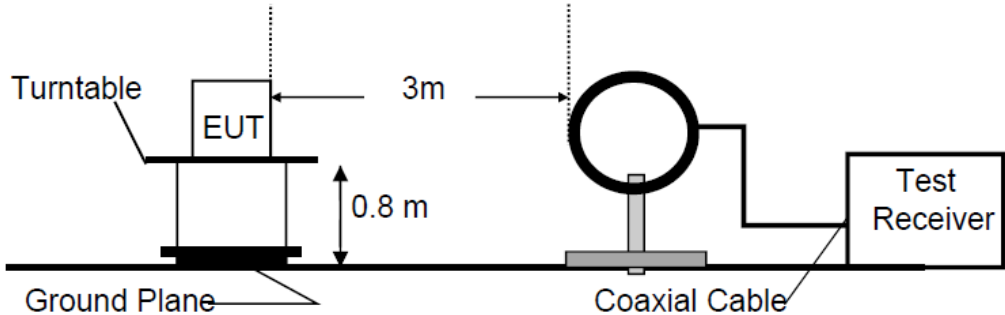

Diagram of Measurement Configuration for Radiation Test (Below 1GHz)

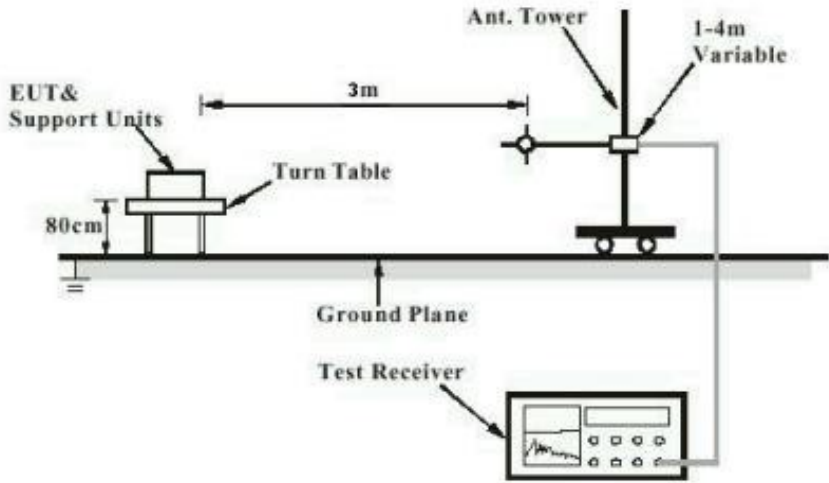

Diagram of Measurement Configuration for Radiation Test (Above 1GHz)

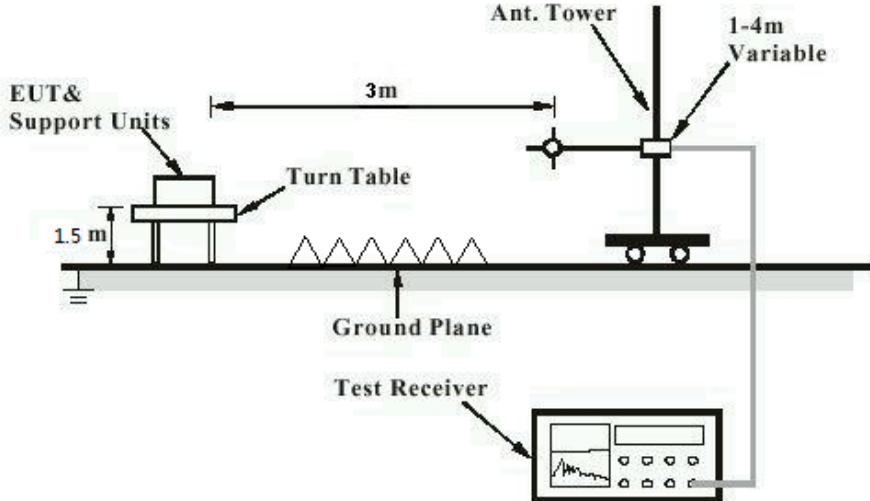
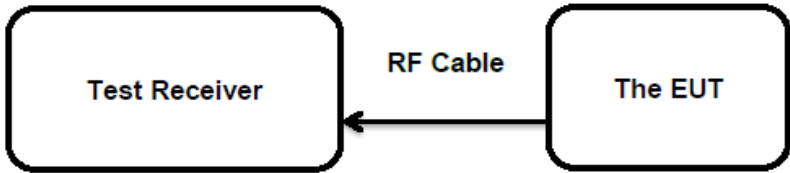

Diagram of Measurement Configuration for Conducted Transmitter Measurement



## 5 Test Results

### 5.1 Transmitter Requirement & Test Suites

#### 5.1.1 Antenna Requirement

**RESULT:****Pass****Test Specification**

Test standard : FCC Part 15.247(b)(4) and Part 15.203  
RSS-Gen Clause 6.8

According to the manufacturer declared, the EUT has an integral antenna, the directional gain of antenna is 0 dBi, and the antenna connector is designed with permanent attachment and no consideration of replacement. Therefore the EUT is considered sufficient to comply with the provision.

Refer to EUT Photo for further details.

### 5.1.2 Maximum Peak Conducted Output Power

**RESULT:**
**Pass**
**Test Specification**

Test standard : FCC Part 15.247(b)(2)  
 Basic standard : ANSI C63.10: 2013  
 Limits : Not more than 1Watt(30dBm) for FHSS with at least 50 hopping channels in the band 902-928MHz  
 Kind of test site : Shielded Room

**Test Setup**

Date of testing : 2020-11-02 -2021-07-01  
 Input voltage : Fully charged battery  
 Operation mode : A  
 Test channel : Low / Middle / High  
 Ambient temperature : 25 °C  
 Relative humidity : 56 %  
 Atmospheric pressure : 101 kPa

Note: This test was carried out on right earphone only.

**Table 5: Test Result of Maximum Peak Conducted Output Power, Lora FHSS**

Test Mode	Test Channel (MHz)	Measured Peak Power		Limit (W)
		(dBm)	(W)	
A	902.306	18.55	0.0716	< 1W
	912.146	18.20	0.0661	
	922.396	18.49	0.0706	
<b>Max. Measured Value</b>		18.55	0.0716	

Note:

- 1) The cable loss is taken into account in results.
- 2) Antenna gain(G) : 0 dBi,

### 5.1.3 20dB&99% Bandwidth

**RESULT:**
**Pass**
**Test Specification**

Test standard : FCC Part 15.247(a)(1) (i)  
 Basic standard : ANSI C63.10: 2013  
 Limits : < 250KHz for at least 50 hopping frequencies  
           : >=250KHz for at least 25 hopping frequencies  
 Kind of test site : Shielded Room

**Test Setup**

Date of testing : 2020-11-02 -2021-07-01  
 Input voltage : Fully charged battery  
 Operation mode : A  
 Test channel : Low / Middle / High  
 Ambient temperature : 25 °C  
 Relative humidity : 56 %  
 Atmospheric pressure : 101 kPa

Note: This test was carried out on right earphone only.

For the measurement records, refer to the appendix B.

**Table 6: Test Result of 20dB Bandwidth**

Test Mode	Channel Frequency (MHz)	20dB Bandwidth (kHz)	Limit (MHz)
A	902.306	< 126KHz	<250KHz
	912.146	<180KHz	
	922.396	<126KHz	

### 5.1.4 Conducted Spurious Emissions Measured in 100 kHz Bandwidth

**RESULT:****Pass****Test Specification**

Test standard	: FCC Part 15.247(d)
Basic standard	: ANSI C63.10: 2013
Limits	: 20dB (below that in the 100kHz bandwidth within the band that contains the highest level of the desired power); In addition, radiated emissions which fall in the restricted bands, must also comply with the radiated emission limits specified in 15.209(a)
Kind of test site	: Shielded Room

**Test Setup**

Date of testing	: 2020-11-02 -2021-07-01
Input voltage	: Fully charged battery
Operation mode	: A
Test channel	: Low / Middle / High
Ambient temperature	: 25 °C
Relative humidity	: 56 %
Atmospheric pressure	: 101 kPa

Test results of 100kHz Bandwidth of Frequency Band Edge by Conducted method refer to test plots, and compliance is achieved as well. The worst case plots were recorded.

Note: This test was carried out on right earphone only.

For the measurement records, refer to the appendix B.

**Prüfbericht - Nr.: 60443733 001**  
Test Report No.Seite 16 von 21  
Page 16 of 21

## 5.1.5 Radiated Spurious Emission

**RESULT:****Pass****Test Specification**

Test standard : FCC Part 15.247(d) & FCC Part 15.205  
Basic standard : ANSI C63.10: 2013  
Limits : Refer to 15.209(a) of FCC part 15.247(d)  
Kind of test site : 3m Semi-anechoic Chamber

**Test Setup**

Date of testing : 2020-11-02 -2021-07-01  
Input voltage : Fully charged battery  
Operation mode : A, B  
Test channel : Low / Middle / High  
Ambient temperature : Refer to test result  
Relative humidity : Refer to test result  
Atmospheric pressure : 101 kPa

**Remark:**

Testing was carried out within frequency range 9kHz to the tenth harmonics. Only the worst case spurious emissions configuration of the each mode were reported.

For the measurement records, refer to the appendix B.



## 5.1.6 Carrier Frequency Separation

**RESULT:**
**Pass**
**Test Specification**

Test standard	: FCC Part 15.247(a)(1)
Basic standard	: ANSI C63.10: 2013
Limits	: $\geq 25\text{kHz}$ or 20dB bandwidth, whichever is greater
Kind of test site	: Shielded Room

**Test Setup**

Date of testing	: 2020-11-02 -2021-07-01
Input voltage	: Fully charged battery
Operation mode	: B
Test channel	: Low / Middle / High
Ambient temperature	: 25 °C
Relative humidity	: 56 %
Atmospheric pressure	: 101 kPa

Note: This test was carried out on right earphone only.

For the measurement records, refer to the appendix B.

**Table 7: Test Result of Carrier Frequency Separation**

Test Mode	Channel	Channel Frequency (MHz)	Measured Channel Separation (KHz)	Limit (kHz)	Result
Hopping	Low Channel	902.306	411	$\geq 20\text{dB}$ bandwidth	Pass
	Adjacency Channel	902.716			
	Middle Channel	912.146	411		Pass
	Adjacency Channel	912.556			
	High Channel	921.986	411		Pass
	Adjacency Channel	922.396			

Note:

The limit is maximum 2/3 of the 20 dB bandwidth: 72.36 KHz.

### 5.1.7 Number of Hopping Frequency

**RESULT:**
**Pass**
**Test Specification**

Test standard : FCC part 15.247(a)(1)(iii)  
 Basic standard : ANSI C63.10: 2013  
 Limits :  $\geq 50$  non-overlapping channels  
 Kind of test site : Shielded Room

**Test Setup**

Date of testing : 2020-11-02 -2021-07-01  
 Input voltage : Fully charged battery  
 Operation mode : B  
 Ambient temperature : 25 °C  
 Relative humidity : 56 %  
 Atmospheric pressure : 101 kPa

Note: This test was carried out on right earphone only.

For the measurement records, refer to the appendix B.

**Table 8: Test result of hopping channel number**

Test Mode	20dB Bandwidth(kHz)	Hopping frequencies	Limit
Hopping	20dB Bandwidth < 250	50	$\geq 50$

## 5.1.8 Time of Occupancy

**RESULT:**
**Pass**
**Test Specification**

Test standard : FCC part 15.247(a)(1)(iii)  
 Basic standard : ANSI C63.10: 2013  
 Limits : < 0.4s  
 Kind of test site : Shielded Room

**Test Setup**

Date of testing : 2020-11-02 -2021-07-01  
 Input voltage : Fully charged battery  
 Operation mode : B  
 Test channel : Low / Middle / High  
 Ambient temperature : 25 °C  
 Relative humidity : 56 %  
 Atmospheric pressure : 101 kPa

Note: This test was carried out on right earphone only.

For the measurement records, refer to the appendix B.

**Table 9: Test result of Channel Occupancy**

Test Mode	20dB Bandwidth(kHz)	Period (s)	Channel Occupancy Time (ms)	Limit (ms)
Hopping	20dB Bandwidth < 250	20	18	400

## 6 Safety Human Exposure

### 6.1 Radio Frequency Exposure Compliance

#### 6.1.1 Electromagnetic Fields

RESULT:

Pass

**Test Specification**

Test standard : CFR47 FCC Part 2: Section 2.1091  
CFR47 FCC Part 1: Section 1.1310  
FCC KDB Publication 447498 v06  
FCC KDB Publication 865664 D02 v01r02  
OET Bulletin 65 (Edition 97-01)

**FCC requirement:** Systems operating under the provisions of this section shall be operated in a manner that ensures that the public is not exposed to radio frequency energy level in excess limit for maximum permissible exposure. In accordance with 47 CFR FCC Part 2 Subpart J, section 2.1091 this device has been defined as a mobile device whereby a distance of 20cm normally can be maintained between the user and the device.

**MPE Calculation Method according to OET Bulletin 65**

Power Density:  $S_{(mW/cm^2)} = PG/4\pi R^2$  or  $EIRP/4\pi R^2$

Where:

S = power density (mW/cm<sup>2</sup>)

P = power input to the antenna (mW)

G = power gain of the antenna in the direction of interest relative to an isotropic radiator

R = distance to the center of radiation of the antenna (cm)

**The nominal maximum conducted output power specified:**

20.00 dBm

From the peak RF output power, the minimum mobile separation distance, d=20 cm, as well as the antenna gain (0.0 dBi), the RF power density can be calculated as below:

**Maximum Permissible Exposure (MPE):**  $S_{(mW/cm^2)} = PG/4\pi R^2 = 0.02 \text{ mW/cm}^2$

**Limits for Maximum Permissible Exposure (MPE) according to FCC Part 1.1310:** 1.0 mW/cm<sup>2</sup>

**“RF Radiation Exposure Statement Caution: This Transmitter must be installed to provide a separation distance of at least 20 cm from all persons.”**

## 7 Photographs of the Test Set-Up

For photographs of the test set-up, refer to the appendix A.

## 8 List of Tables

Table 1: List of Test and Measurement Equipment .....	5
Table 2: Technical Specification of EUT .....	7
Table 3: RF Channel and Frequency of Lora FHSS .....	8
Table 4: Auxiliary Equipment Used during Test.....	9
Table 5: Test Result of Maximum Peak Conducted Output Power, Lora FHSS .....	13
Table 6: Test Result of 20dB Bandwidth .....	14
Table 7: Test Result of Carrier Frequency Separation.....	17
Table 8: Test result of hopping channel number.....	18
Table 9: Test result of Channel Occupancy .....	19

## **Appendix B: Test Results**

<b>APPENDIX B: TEST RESULTS.....</b>	<b>1</b>
<b>APPENDIX B.1: 20dB &amp; 99% BANDWIDTH.....</b>	<b>2</b>
<b>APPENDIX B.2: CONDUCTED SPURIOUS EMISSIONS MEASURED IN 100 kHz BANDWIDTH .....</b>	<b>5</b>
<b>APPENDIX B.3: CARRIER FREQUENCY SEPARATION.....</b>	<b>9</b>
<b>APPENDIX B.4: NUMBER OF HOPPING FREQUENCY.....</b>	<b>11</b>
<b>APPENDIX B.5: TEST RESULTS OF RADIATED SPURIOUS EMISSIONS .....</b>	<b>13</b>

### Appendix B.1: 20dB & 99% Bandwidth

Low Channel

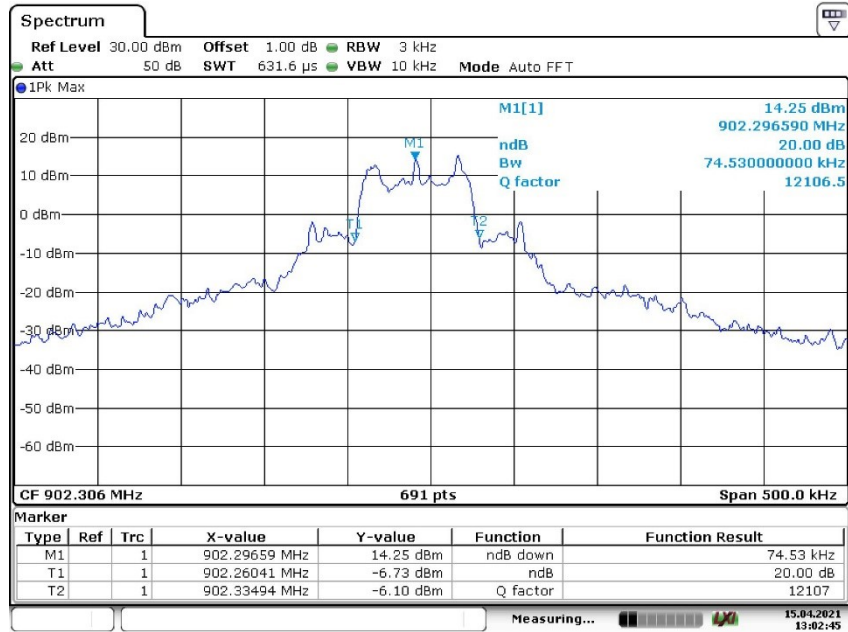

Date: 15.APR.2021 13:02:46

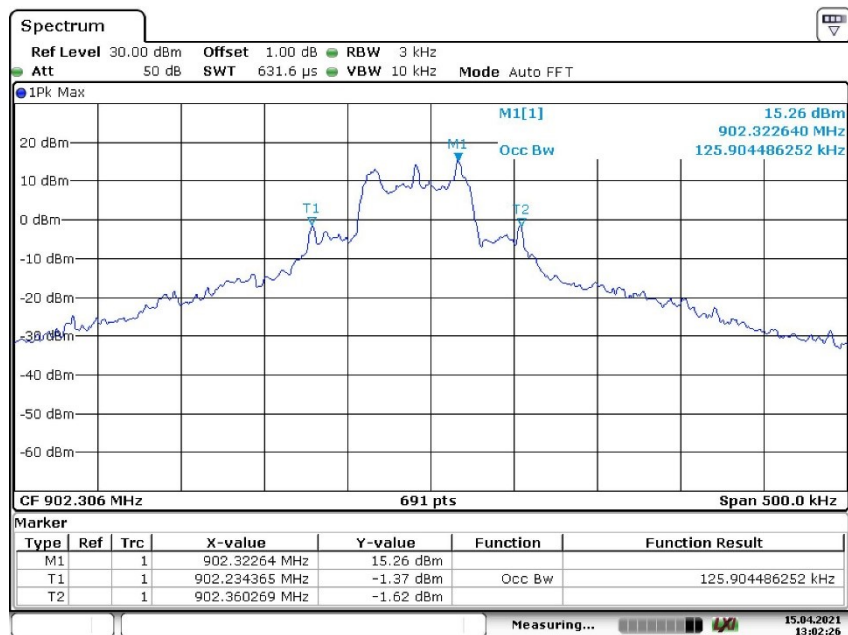

Date: 15.APR.2021 13:02:27

Prüfbericht - Produkte

Test Report - Products

Middle Channel

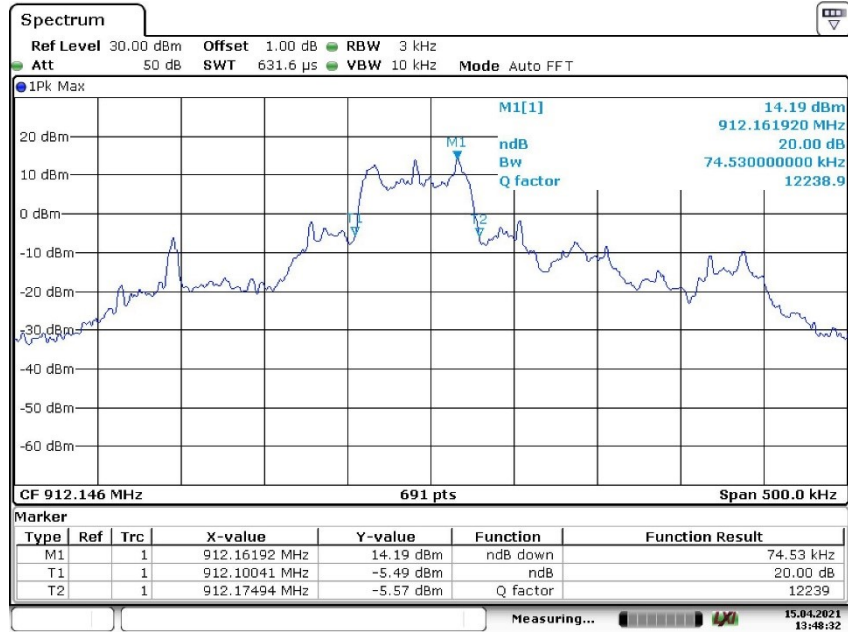

Date: 15.APR.2021 13:48:32

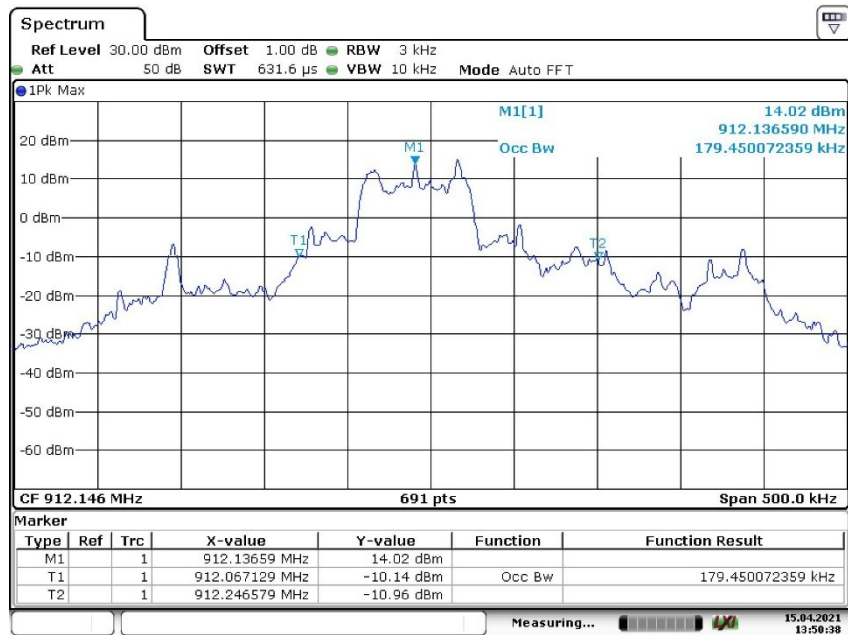

Date: 15.APR.2021 13:50:38



High Channel

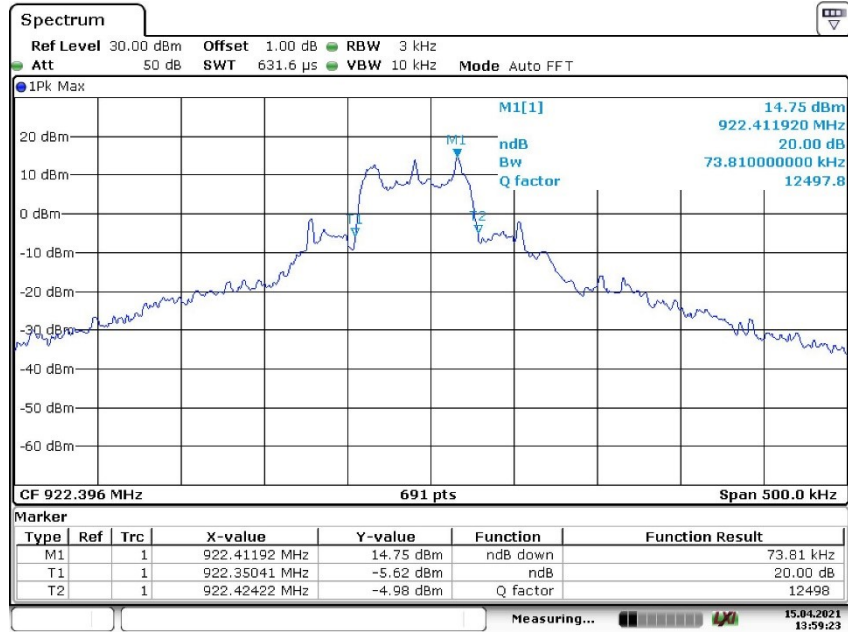

Date: 15.APR.2021 13:59:24

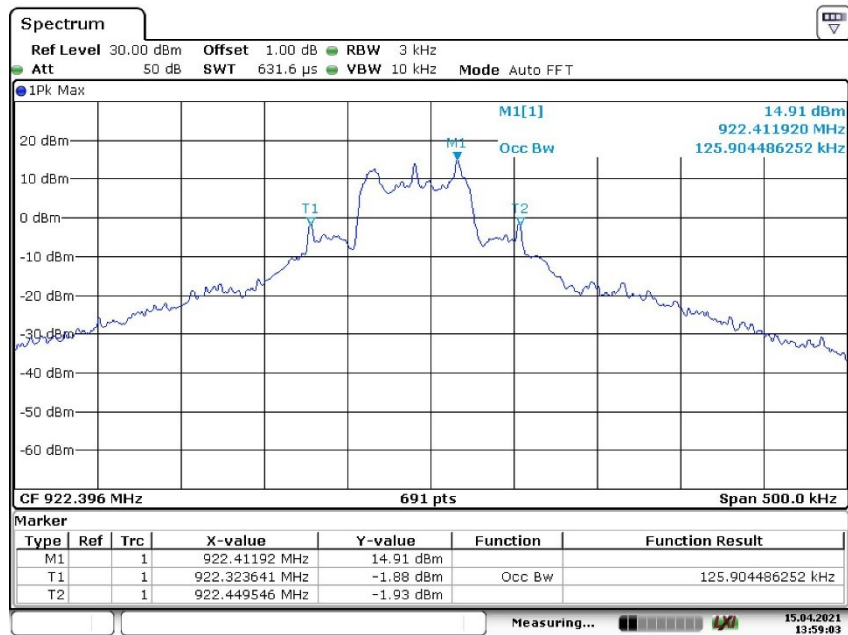

Date: 15.APR.2021 13:59:03

### Appendix B.2: Conducted Spurious Emissions Measured in 100 kHz Bandwidth

Low Channel

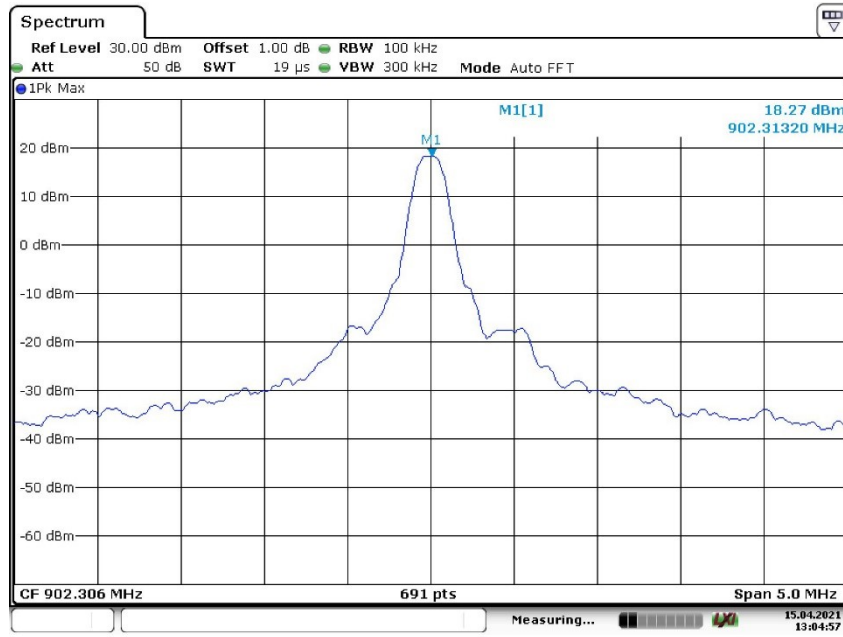

Date: 15.APR.2021 13:04:57

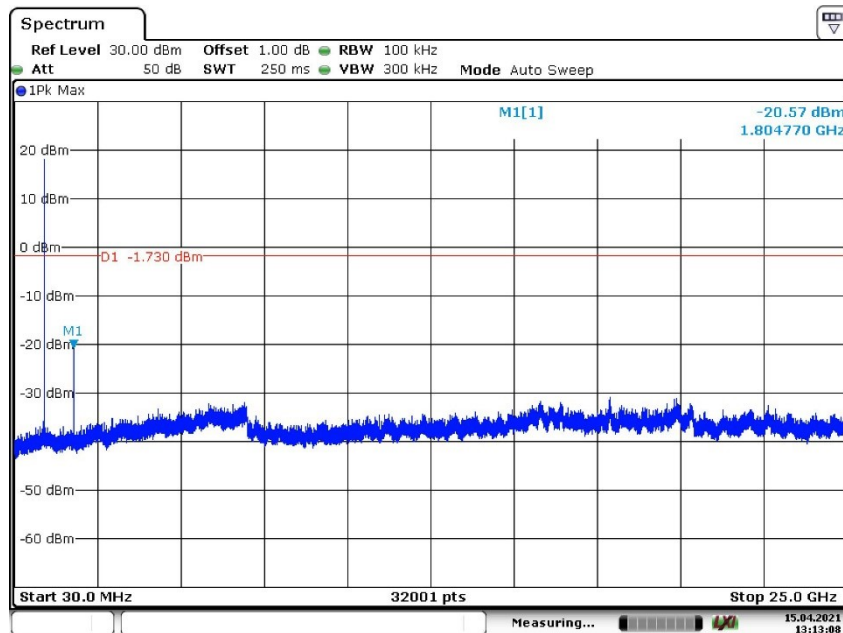

Date: 15.APR.2021 13:13:08

Middle Channel

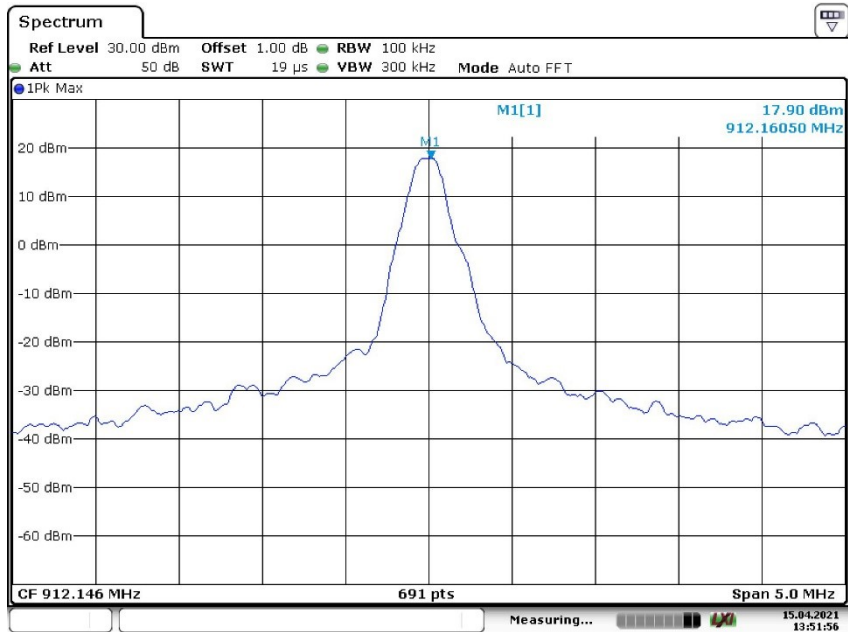

Date: 15.APR.2021 13:51:56

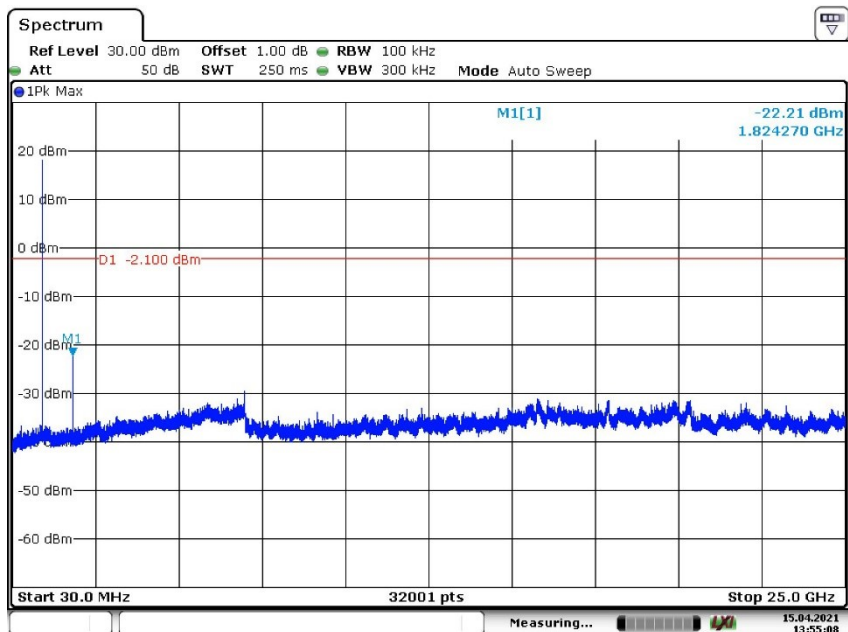

Date: 15.APR.2021 13:55:08

High Channel

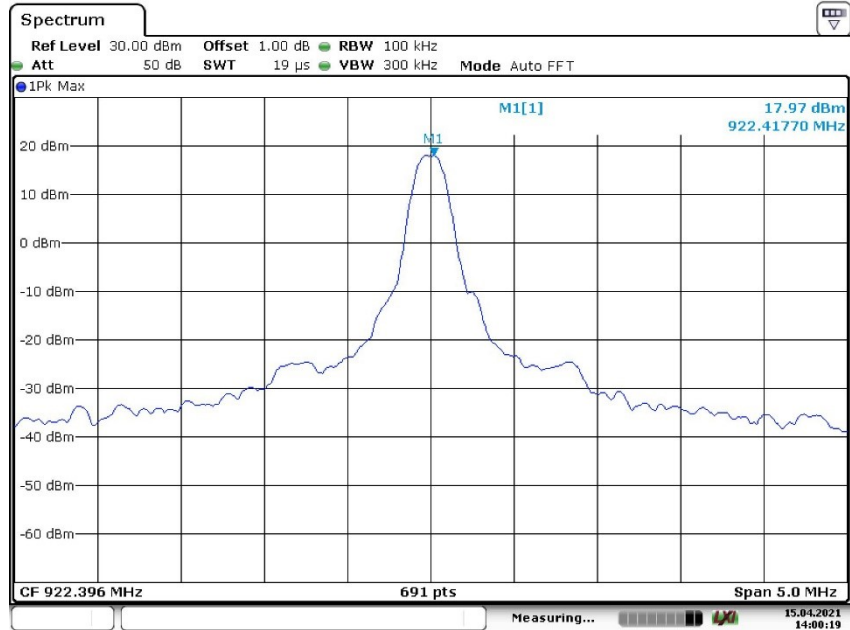

Date: 15.APR.2021 14:00:19

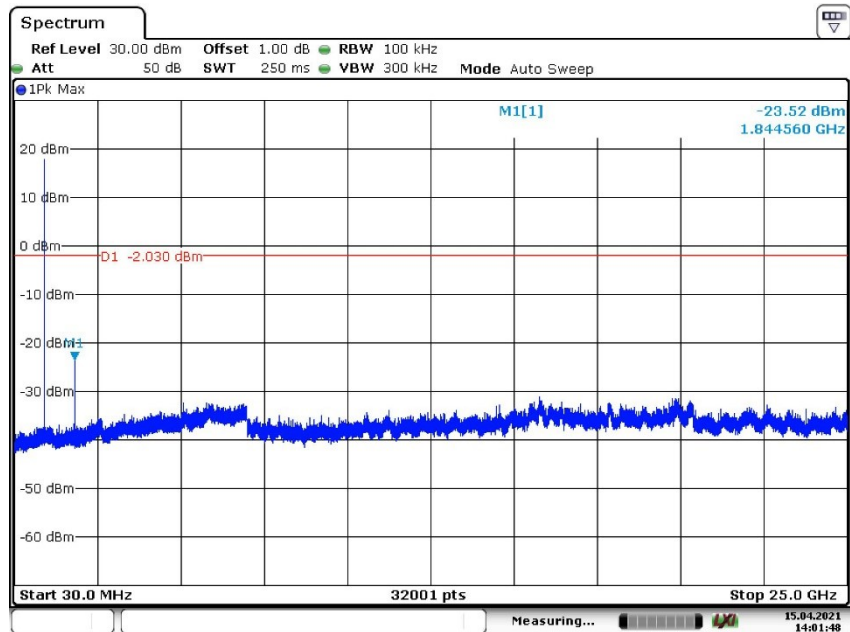

Date: 15.APR.2021 14:01:48

### Band Edge Low Channel

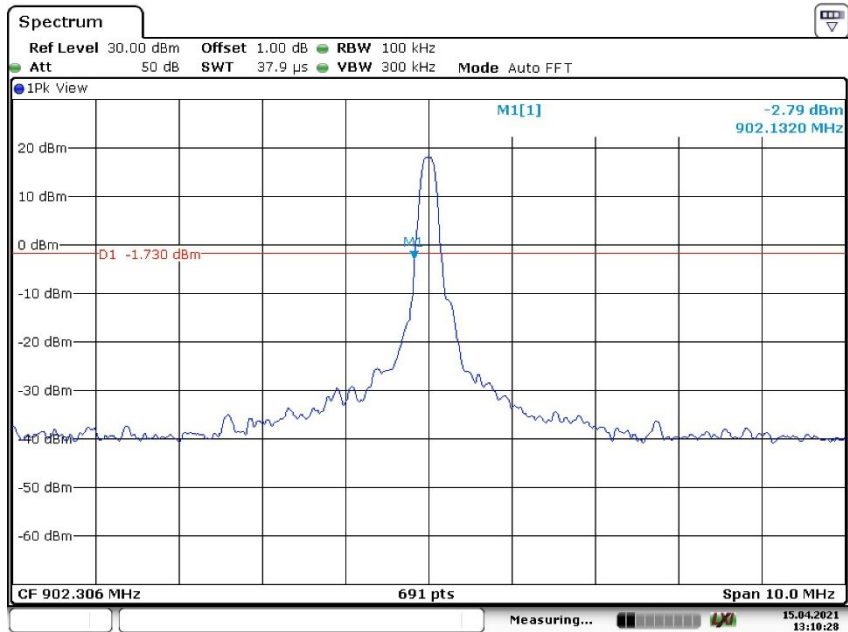

Date: 15.APR.2021 13:10:28

### High Channel

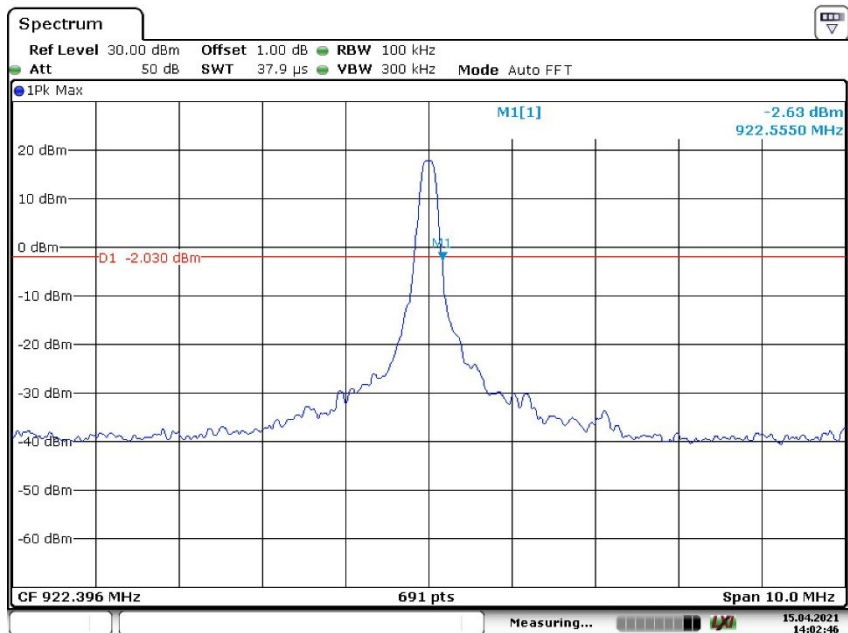

Date: 15.APR.2021 14:02:47

### Appendix B.3: Carrier Frequency Separation

#### Low Channel

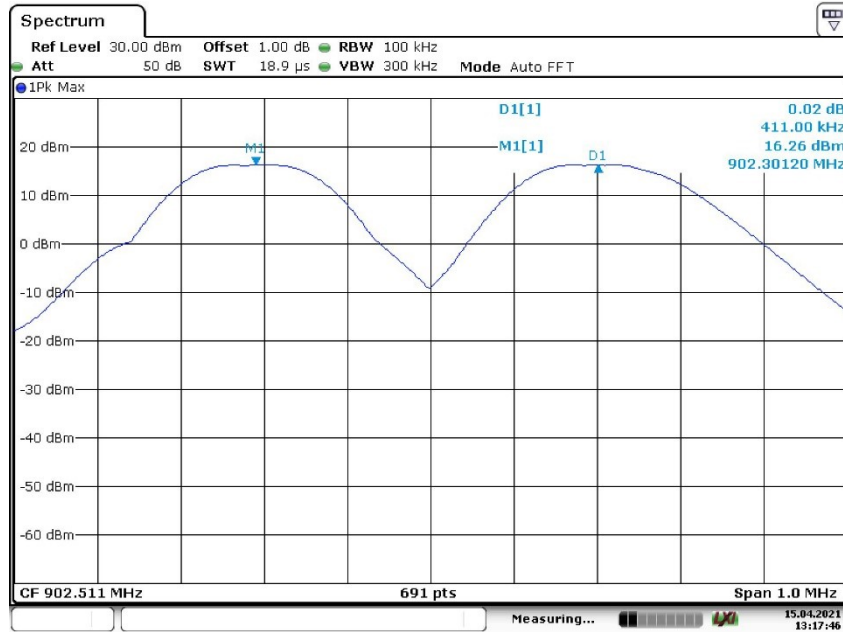

Date: 15.APR.2021 13:17:46

#### Middle Channel

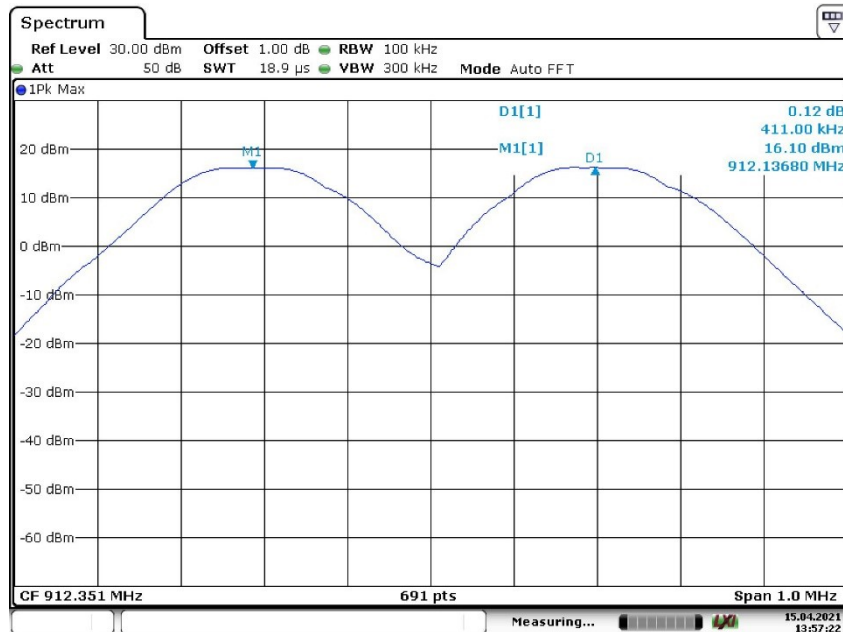

Date: 15.APR.2021 13:57:22

High Channel

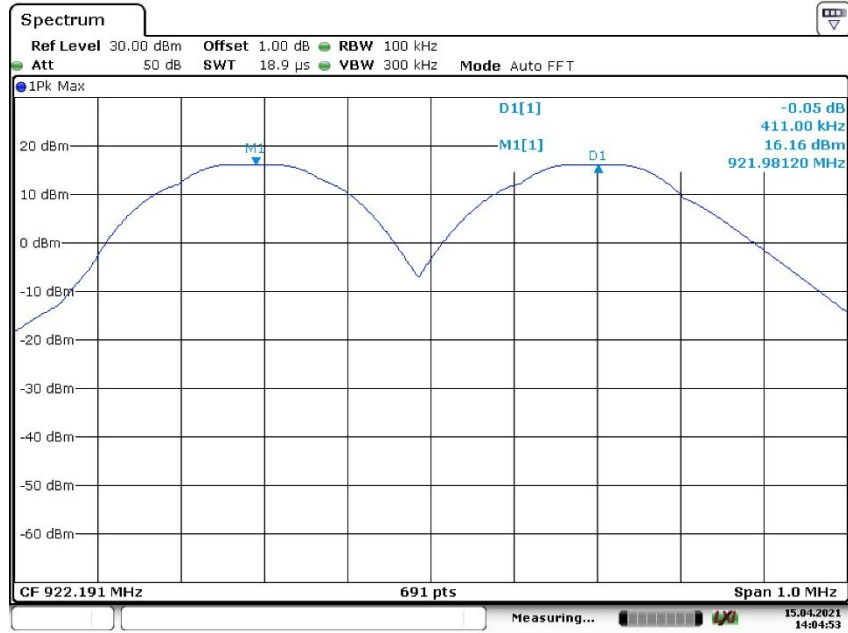

Date: 15.APR.2021 14:04:54

### Appendix B.4: Number of Hopping Frequency

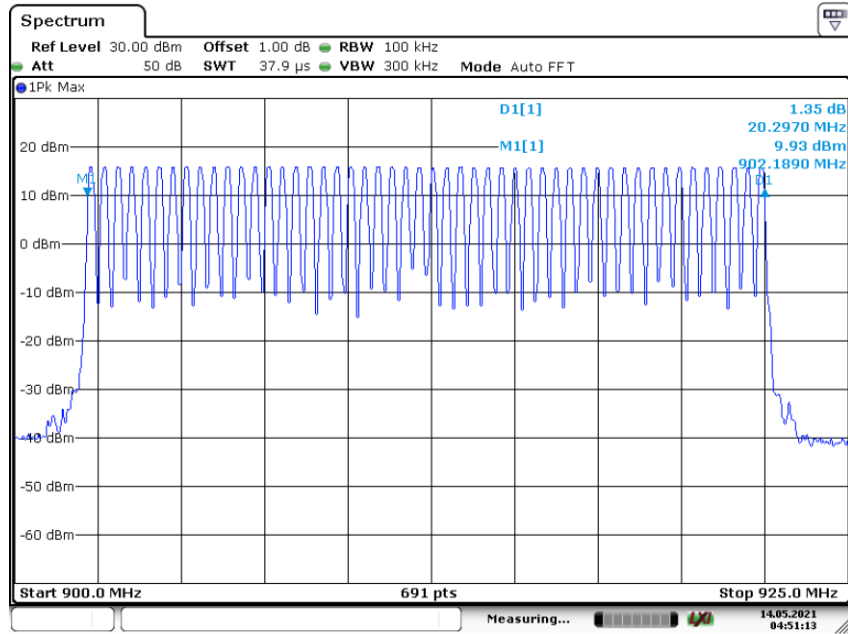

Date: 14.MAY.2021 04:51:14



### Appendix B.5: Time of Occupancy

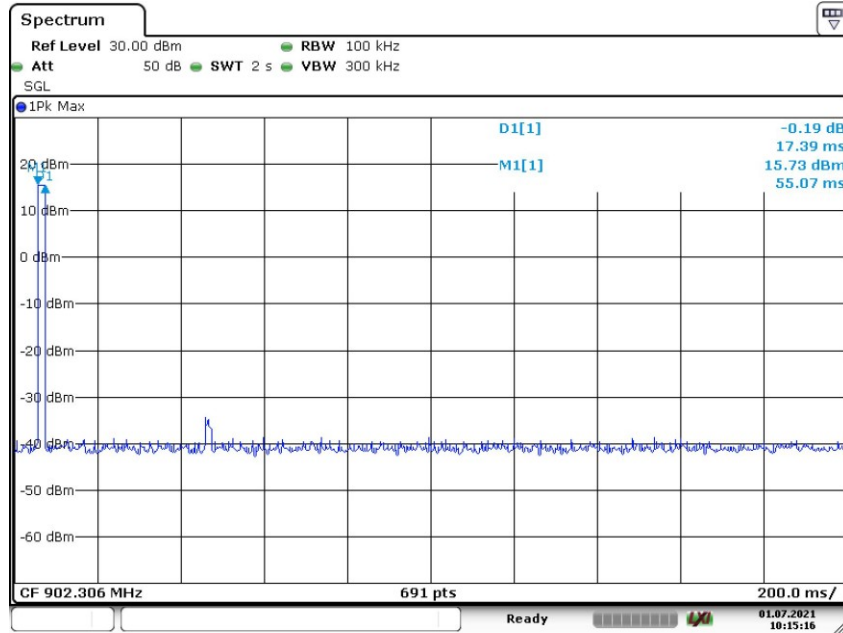

Date: 1.JUL.2021 10:15:16

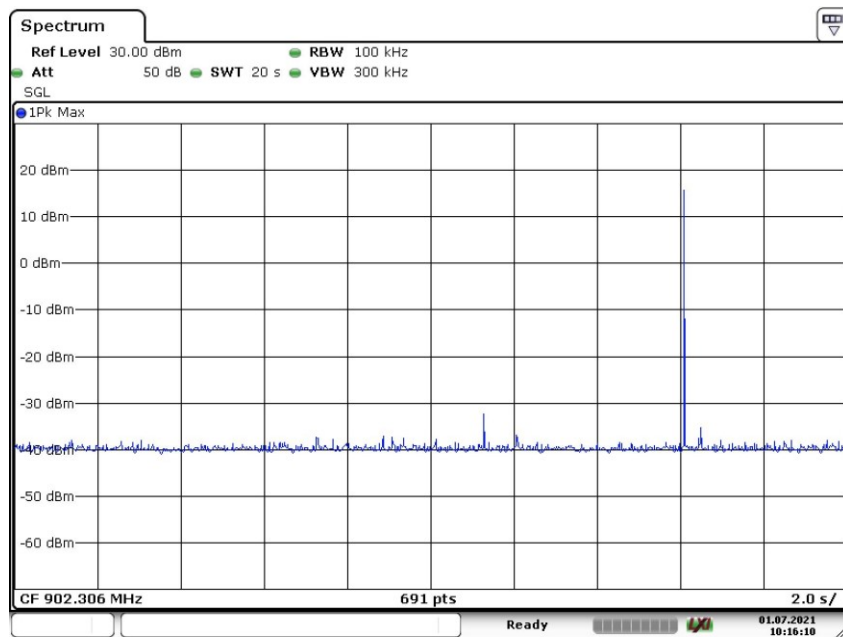

Date: 1.JUL.2021 10:16:11

Note 1: Testing was carried out within frequency range 9 kHz to the tenth harmonics. The measurement results below 30MHz were greater than 20dB below the limit, so only the radiated spurious emissions from 30MHz to 10GHz were reported.

## Appendix B.6: Test Results of Radiated Spurious Emissions

### 30MHz - 1GHz

### EUT Information

EUT Name:	Sensor
Model:	T11012920
Test Mode:	TX_Low CH
Test Voltage::	Battery
Remark:	Temp 23 Humi:47%
Test Standard:	FCC 15.247
Tested By:	Kei Zhang
Reviewed By:	Terry Yin

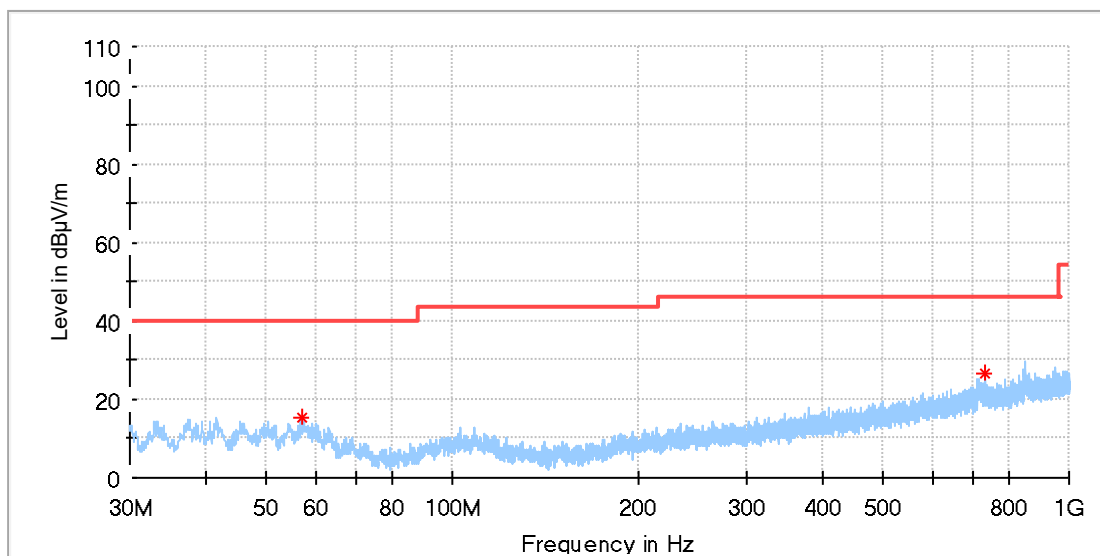

### Critical Freqs

Frequency (MHz)	MaxPeak (dBµV/m)	Average (dBµV/m)	Limit (dBµV/m)	Margin (dB)	Height (cm)	Pol	Azimuth (deg)	Corr. (dB/m)
56.869000	15.21	--	40.00	24.79	100.0	H	40.0	-18.9
729.418500	26.67	--	46.00	19.33	100.0	H	220.0	-7.9

## EUT Information

EUT Name:	Sensor
Model:	T11012920
Test Mode:	TX_Low CH
Test Voltage:	Battery
Remark:	Temp 23 Humi:47%
Test Standard:	FCC 15.247
Tested By:	Kei Zhang
Reviewed By:	Terry Yin

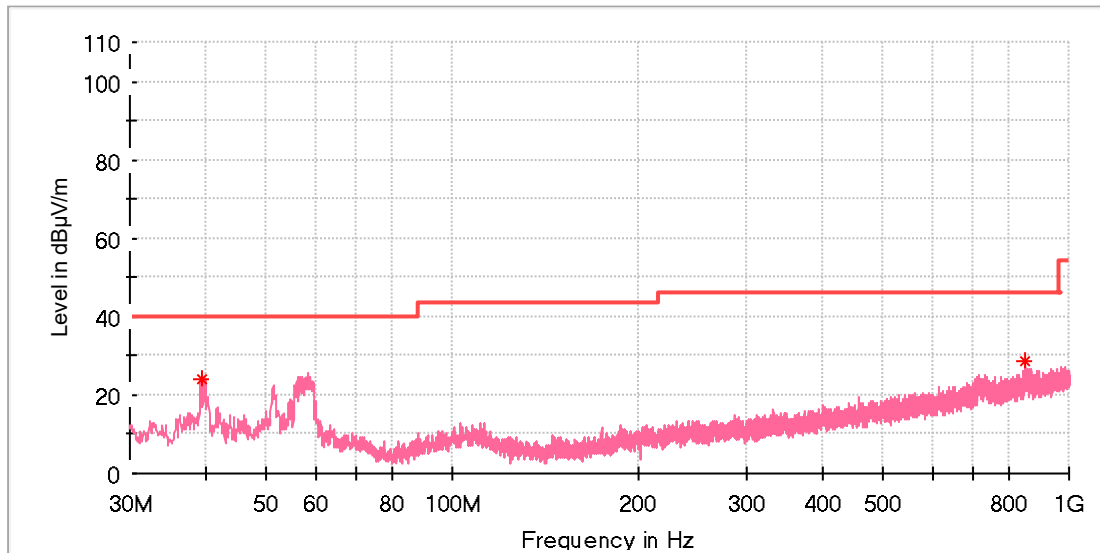

## Critical Freqs

Frequency (MHz)	MaxPeak (dBµV/m)	Average (dBµV/m)	Limit (dBµV/m)	Margin (dB)	Height (cm)	Pol	Azimuth (deg)	Corr. (dB/m)
39.215000	24.00	--	40.00	16.00	100.0	V	305.0	-20.7
845.527500	28.52	--	46.00	17.48	100.0	V	206.0	-6.0

### EUT Information

EUT Name:	Sensor
Model:	T11012920
TestMode:	TX_High CH
Test Voltage::	Battery
Remark:	Temp 23 Humi:47%
Test Standard:	FCC 15.247
Tested By:	Kei Zhang
Reviewed By:	Terry Yin

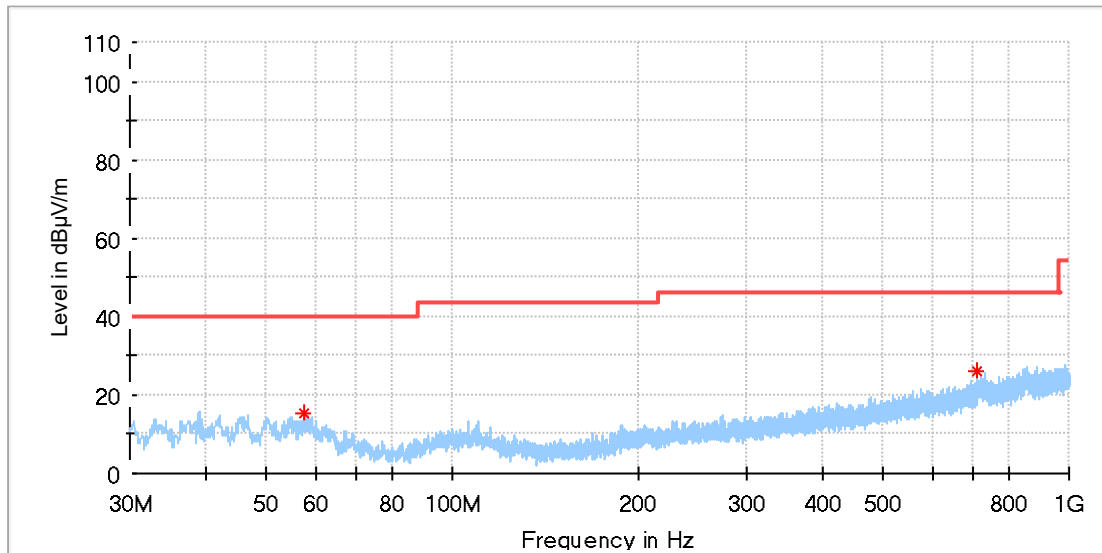

### Critical Freqs

Frequency (MHz)	MaxPeak (dBµV/m)	Average (dBµV/m)	Limit (dBµV/m)	Margin (dB)	Height (cm)	Pol	Azimuth (deg)	Corr. (dB/m)
57.645000	15.30	--	40.00	24.70	100.0	H	273.0	-19.0
709.485000	26.23	--	46.00	19.77	100.0	H	0.0	-8.3

### EUT Information

EUT Name:	Sensor
Model:	T11012920
TestMode:	TX_High CH
Test Voltage::	Battery
Remark:	Temp 23 Humi:47%
Test Standard:	FCC 15.247
Tested By:	Kei Zhang
Reviewed By:	Terry Yin

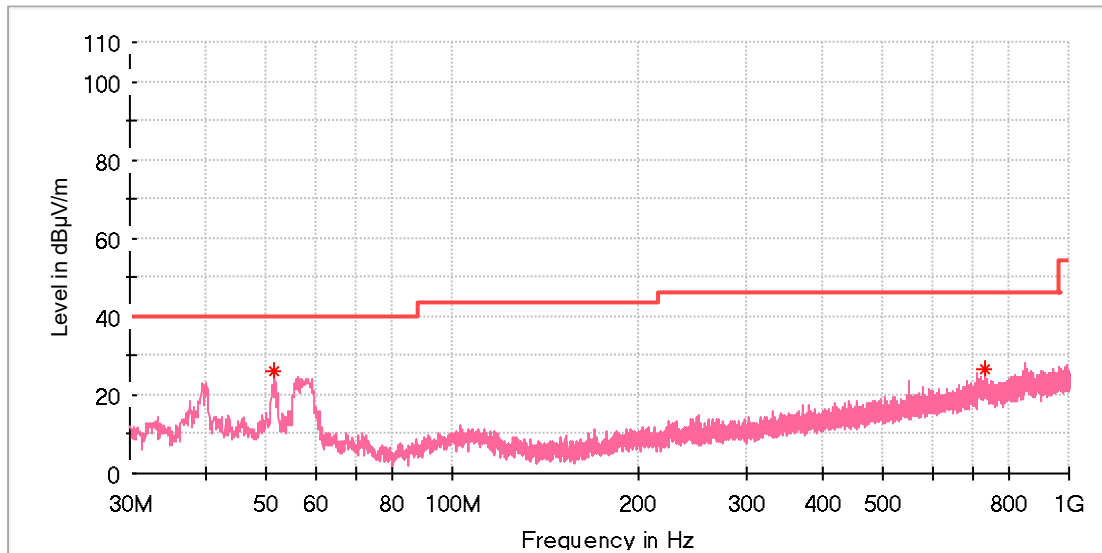

### Critical Freqs

Frequency (MHz)	MaxPeak (dBµV/m)	Average (dBµV/m)	Limit (dBµV/m)	Margin (dB)	Height (cm)	Pol	Azimuth (deg)	Corr. (dB/m)
51.437000	26.27	--	40.00	13.73	100.0	V	341.0	-18.6
732.765000	26.39	--	46.00	19.61	100.0	V	63.0	-7.9

**1GHz - 10GHz****EUT Information**

EUT Name: Quarterback Sensor  
 Model: T11012920  
 Test Mode: 902.306MHz  
 Test Voltage: Battery  
 Remark: Temp 24 Humi:47%  
 Test Standard: FCC 15.247  
 Tested By: Kei Zhang  
 Reviewed By: Terry Yin

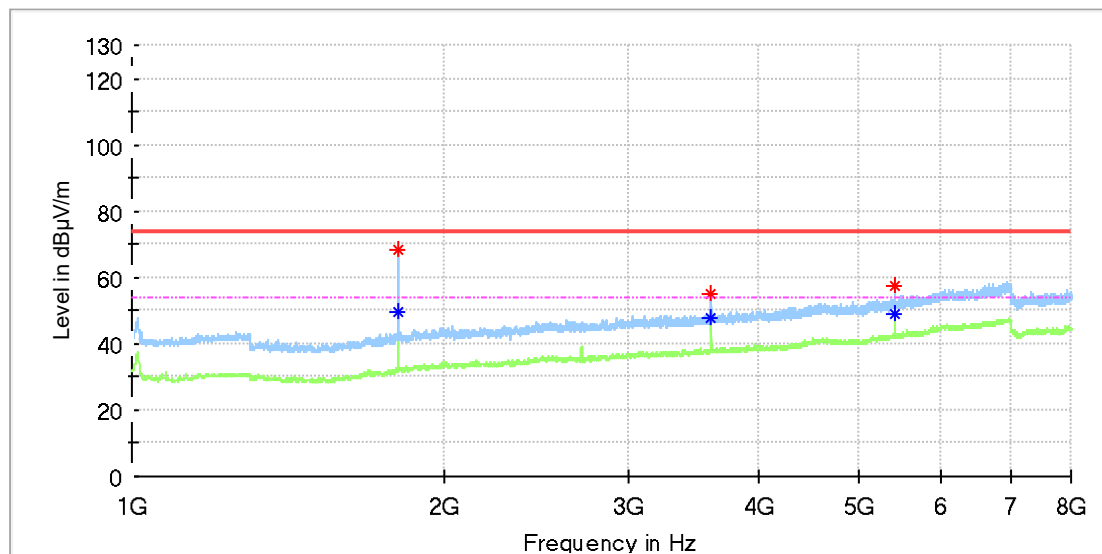
**Critical Freqs**

Frequency (MHz)	MaxPeak (dBµV/m)	Average (dBµV/m)	Limit (dBµV/m)	Margin (dB)	Height (cm)	Pol	Azimuth (deg)	Corr. (dB/m)
1804.175000	68.43	---	74.00	5.57	100.0	H	128.0	4.7
1805.012500	---	49.37	54.00	4.63	100.0	H	128.0	4.8
3607.312500	55.19	---	74.00	18.81	100.0	H	96.0	9.4
3607.312500	---	47.54	54.00	6.46	100.0	H	96.0	9.4
5412.125000	57.31	---	74.00	16.69	100.0	H	173.0	13.5
5412.962500	---	48.86	54.00	5.14	100.0	H	173.0	13.5

### EUT Information

EUT Name: Quarterback Sensor  
 Model: T11012920  
 Test Mode: 902.306MHz  
 Test Voltage: Battery  
 Remark: Temp 24 Humi:47%  
 Test Standard: FCC 15.247  
 Tested By: Kei Zhang  
 Reviewed By: Terry Yin

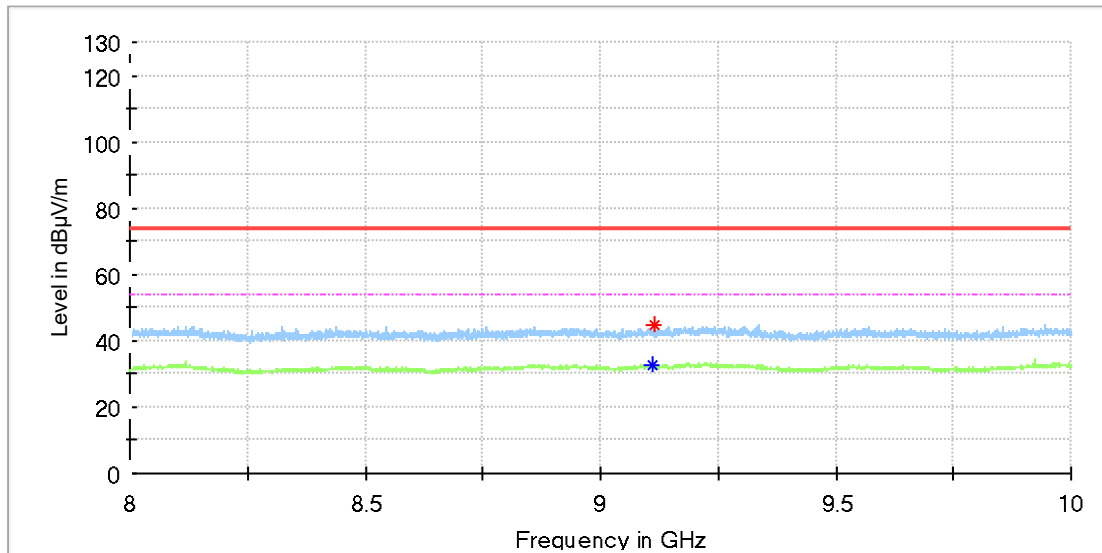

### Critical Freqs

Frequency (MHz)	MaxPeak (dBµV/m)	Average (dBµV/m)	Limit (dBµV/m)	Margin (dB)	Height (cm)	Pol	Azimuth (deg)	Corr. (dB/m)
9111.500000	--	32.52	54.00	21.48	100.0	H	275.0	9.8
9113.000000	44.65	--	74.00	29.35	100.0	H	188.0	9.8

## EUT Information

EUT Name: Quarterback Sensor  
 Model: T11012920  
 Test Mode: 902.306MHz  
 Test Voltage: Battery  
 Remark: Temp 24 Humi:47%  
 Test Standard: FCC 15.247  
 Tested By: Kei Zhang  
 Reviewed By: Terry Yin

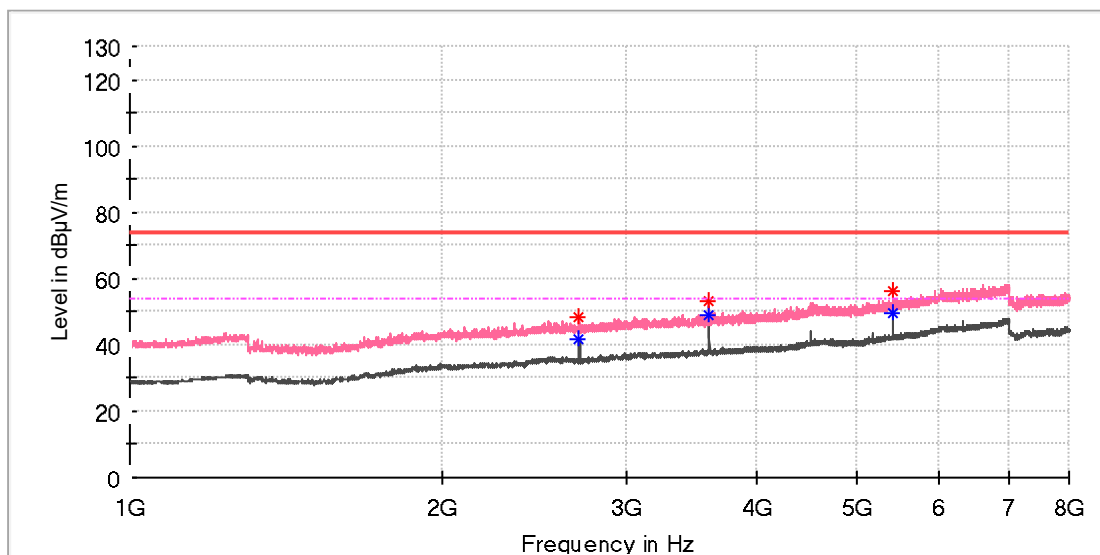

## Critical Freqs

Frequency (MHz)	MaxPeak (dBµV/m)	Average (dBµV/m)	Limit (dBµV/m)	Margin (dB)	Height (cm)	Pol	Azimuth (deg)	Corr. (dB/m)
2705.325000	---	41.54	54.00	12.46	100.0	V	125.0	7.5
2705.325000	48.09	---	74.00	25.91	100.0	V	125.0	7.5
3608.150000	53.36	---	74.00	20.64	100.0	V	342.0	9.4
3608.150000	---	48.71	54.00	5.29	100.0	V	342.0	9.4
5412.125000	---	49.43	54.00	4.57	100.0	V	24.0	13.5
5412.962500	56.10	---	74.00	17.90	100.0	V	24.0	13.5



### EUT Information

EUT Name: Quarterback Sensor  
 Model: T11012920  
 Test Mode: 902.306MHz  
 Test Voltage: Battery  
 Remark: Temp 24 Humi:47%  
 Test Standard: FCC 15.247  
 Tested By: Kei Zhang  
 Reviewed By: Terry Yin

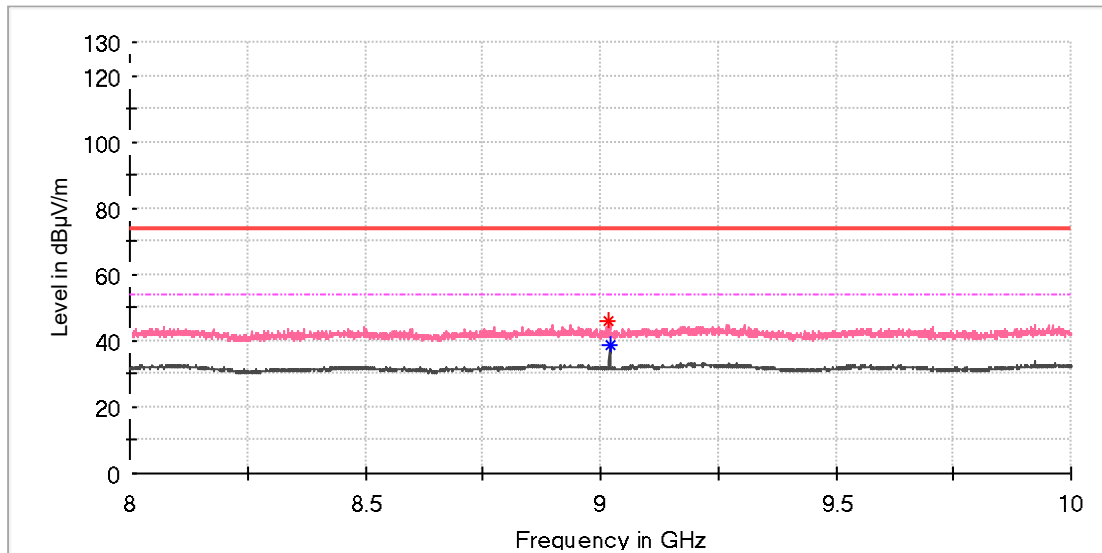

### Critical Freqs

Frequency (MHz)	MaxPeak (dBµV/m)	Average (dBµV/m)	Limit (dBµV/m)	Margin (dB)	Height (cm)	Pol	Azimuth (deg)	Corr. (dB/m)
9019.000000	45.88	--	74.00	28.12	100.0	V	51.0	8.8
9019.500000	--	38.47	54.00	15.53	100.0	V	31.0	8.8

### EUT Information

EUT Name: Quarterback Sensor  
 Model: T11012920  
 Test Mode: 912.146MHz  
 Test Voltage: Battery  
 Remark: Temp 24 Humi:47%  
 Test Standard: FCC 15.247  
 Tested By: Kei Zhang  
 Reviewed By: Terry Yin

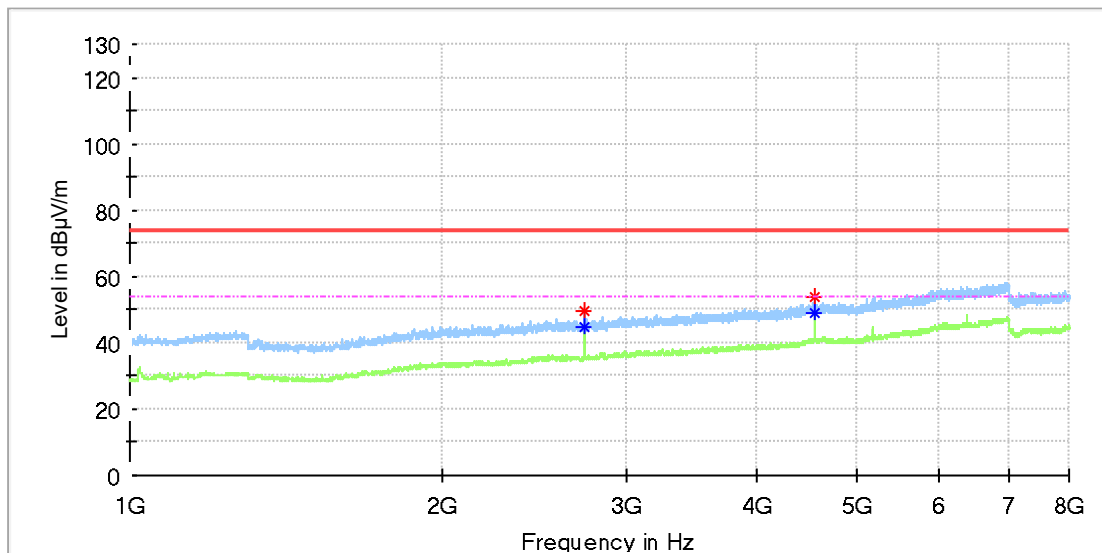

### Critical Freqs

Frequency (MHz)	MaxPeak (dBµV/m)	Average (dBµV/m)	Limit (dBµV/m)	Margin (dB)	Height (cm)	Pol	Azimuth (deg)	Corr. (dB/m)
2734.637500	49.39	--	74.00	24.61	100.0	H	91.0	7.7
2734.637500	--	44.45	54.00	9.55	100.0	H	91.0	7.7
4557.875000	53.98	--	74.00	20.02	100.0	H	285.0	11.9
4557.875000	--	48.72	54.00	5.28	100.0	H	285.0	11.9

### EUT Information

EUT Name:	Quarterback Sensor
Model:	T11012920
Test Mode:	912.146MHz
Test Voltage:	Battery
Remark:	Temp 24 Humi:47%
Test Standard:	FCC 15.247
Tested By:	Kei Zhang
Reviewed By:	Terry Yin

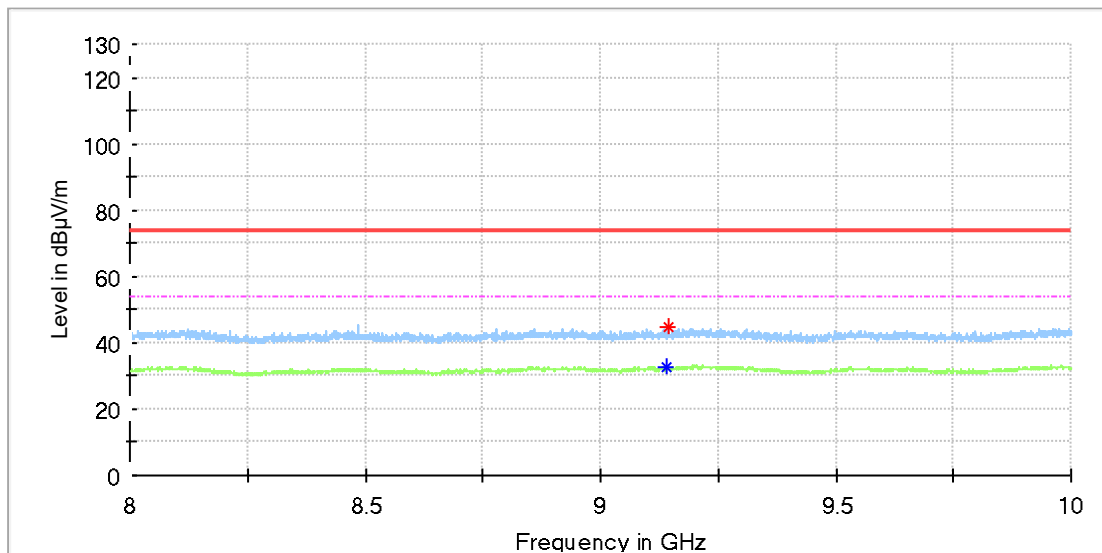

### Critical Freqs

Frequency (MHz)	MaxPeak (dBµV/m)	Average (dBµV/m)	Limit (dBµV/m)	Margin (dB)	Height (cm)	Pol	Azimuth (deg)	Corr. (dB/m)
9139.000000	--	32.51	54.00	21.49	100.0	H	0.0	10.0
9143.000000	44.76	--	74.00	29.24	100.0	H	114.0	10.1

## EUT Information

EUT Name: Quarterback Sensor  
 Model: T11012920  
 Test Mode: 912.146MHz  
 Test Voltage: Battery  
 Remark: Temp 24 Humi:47%  
 Test Standard: FCC 15.247  
 Tested By: Kei Zhang  
 Reviewed By: Terry Yin

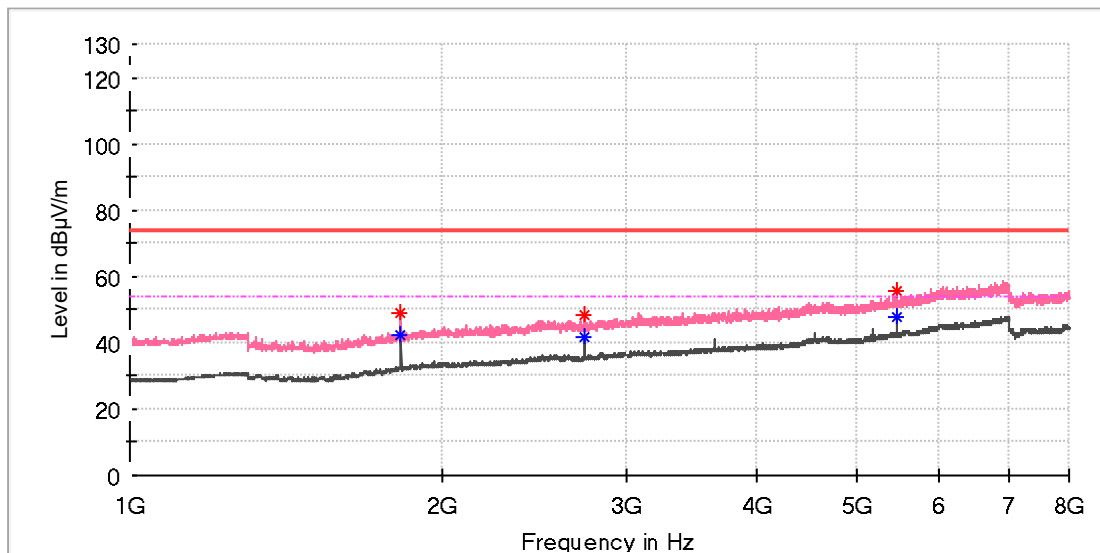

## Critical Freqs

Frequency (MHz)	MaxPeak (dBµV/m)	Average (dBµV/m)	Limit (dBµV/m)	Margin (dB)	Height (cm)	Pol	Azimuth (deg)	Corr. (dB/m)
1822.600000	49.08	--	74.00	24.92	100.0	V	160.0	4.8
1823.437500	--	42.11	54.00	11.89	100.0	V	160.0	4.8
2734.637500	--	41.92	54.00	12.08	100.0	V	355.0	7.7
2734.637500	48.66	--	74.00	25.34	100.0	V	355.0	7.7
5469.075000	55.78	--	74.00	18.22	100.0	V	101.0	13.6
5469.912500	--	48.02	54.00	5.98	100.0	V	101.0	13.6

### EUT Information

EUT Name: Quarterback Sensor  
 Model: T11012920  
 Test Mode: 912.146MHz  
 Test Voltage: Battery  
 Remark: Temp 24 Humi:47%  
 Test Standard: FCC 15.247  
 Tested By: Kei Zhang  
 Reviewed By: Terry Yin

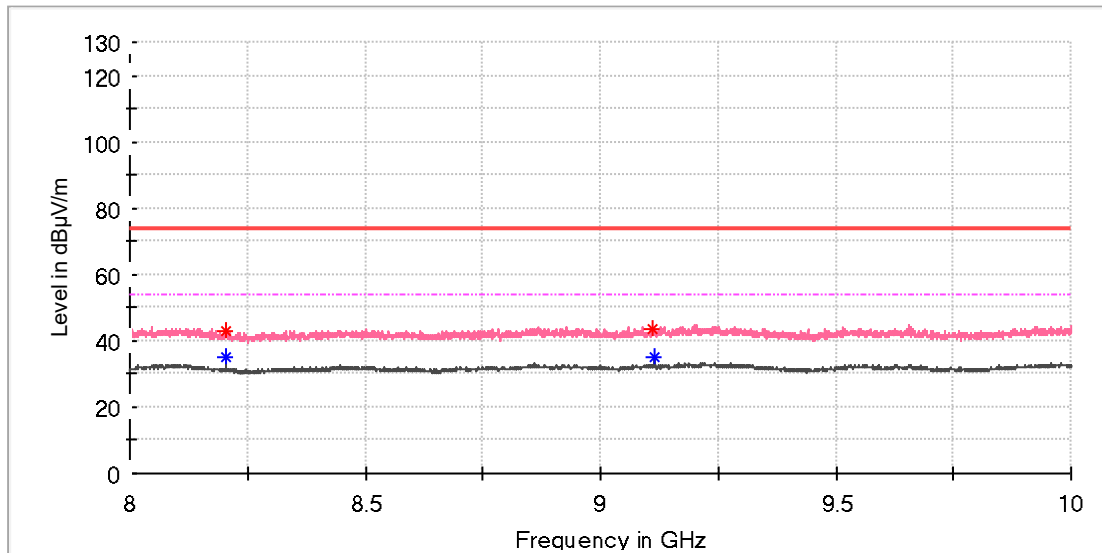

### Critical Freqs

Frequency (MHz)	MaxPeak (dBµV/m)	Average (dBµV/m)	Limit (dBµV/m)	Margin (dB)	Height (cm)	Pol	Azimuth (deg)	Corr. (dB/m)
8204.000000	---	35.35	54.00	18.65	100.0	V	358.0	8.5
8205.000000	43.13	---	74.00	30.87	100.0	V	358.0	8.5
9111.000000	43.40	---	74.00	30.60	100.0	V	353.0	9.8
9116.500000	---	35.25	54.00	18.75	100.0	V	172.0	9.9

### EUT Information

EUT Name:	Quarterback Sensor
Model:	T11012920
Test Mode:	922.396MHz
Test Voltage:	Battery
Remark:	Temp 24 Humi:47%
Test Standard:	FCC 15.247
Tested By:	Kei Zhang
Reviewed By:	Terry Yin

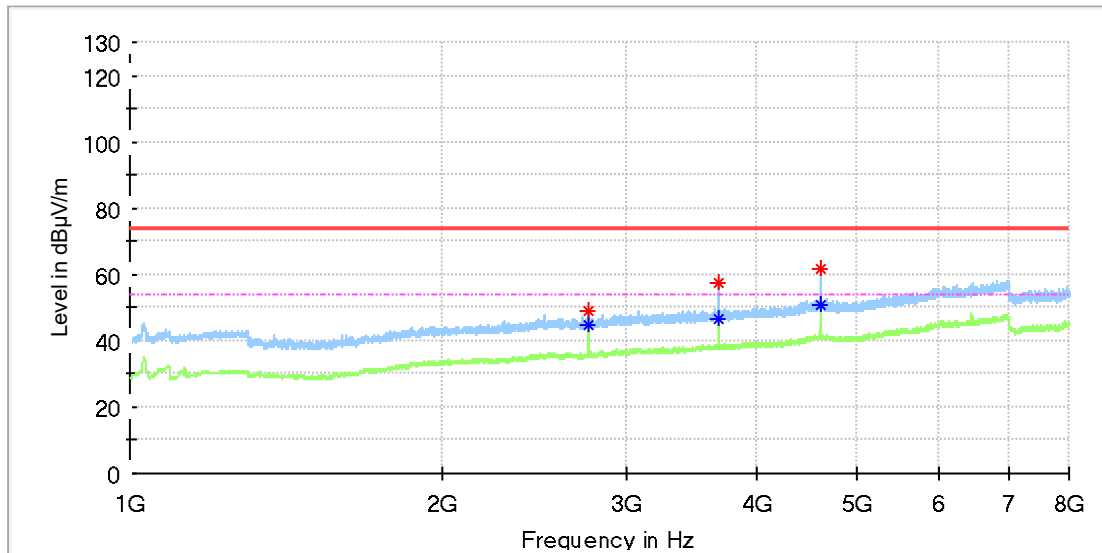

### Critical Freqs

Frequency (MHz)	MaxPeak (dBµV/m)	Average (dBµV/m)	Limit (dBµV/m)	Margin (dB)	Height (cm)	Pol	Azimuth (deg)	Corr. (dB/m)
2763.950000	49.28	---	74.00	24.72	100.0	H	309.0	7.9
2764.787500	---	44.64	54.00	9.36	100.0	H	309.0	7.9
3685.200000	---	46.54	54.00	7.46	100.0	H	162.0	9.5
3686.875000	57.54	---	74.00	16.46	100.0	H	59.0	9.5
4608.125000	61.97	---	74.00	12.03	100.0	H	286.0	12.0
4608.962500	---	50.54	54.00	3.46	100.0	H	331.0	12.0

### EUT Information

EUT Name:	Quarterback Sensor
Model:	T11012920
Test Mode:	922.396MHz
Test Voltage:	Battery
Remark:	Temp 24 Humi:47%
Test Standard:	FCC 15.247
Tested By:	Kei Zhang
Reviewed By:	Terry Yin

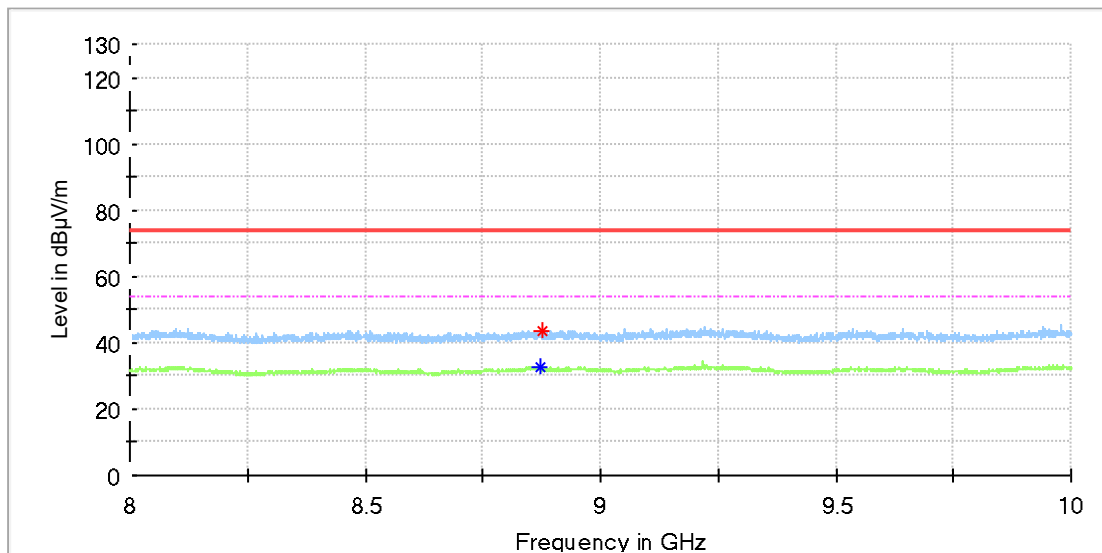

### Critical Freqs

Frequency (MHz)	MaxPeak (dBµV/m)	Average (dBµV/m)	Limit (dBµV/m)	Margin (dB)	Height (cm)	Pol	Azimuth (deg)	Corr. (dB/m)
8873.000000	---	32.47	54.00	21.53	100.0	H	280.0	9.5
8876.000000	43.42	---	74.00	30.58	100.0	H	128.0	9.5

### EUT Information

EUT Name:	Quarterback Sensor
Model:	T11012920
Test Mode:	922.396MHz
Test Voltage:	Battery
Remark:	Temp 24 Humi:47%
Test Standard:	FCC 15.247
Tested By:	Kei Zhang
Reviewed By:	Terry Yin

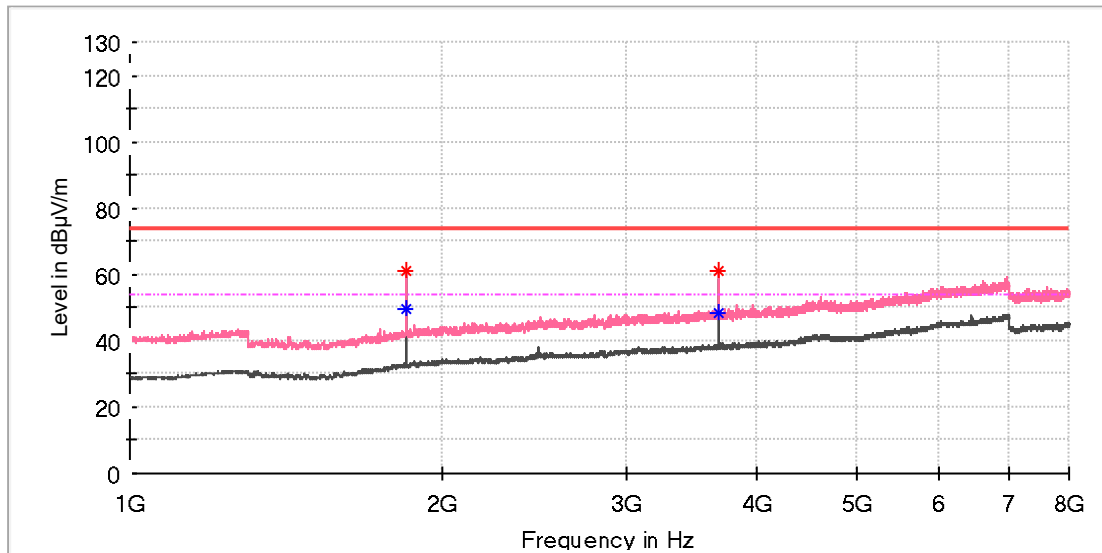

### Critical Freqs

Frequency (MHz)	MaxPeak (dBµV/m)	Average (dBµV/m)	Limit (dBµV/m)	Margin (dB)	Height (cm)	Pol	Azimuth (deg)	Corr. (dB/m)
1841.862500	--	49.73	54.00	4.27	100.0	V	89.0	4.9
1842.700000	60.78	--	74.00	13.22	100.0	V	89.0	4.9
3685.200000	--	48.36	54.00	5.64	100.0	V	101.0	9.5
3686.037500	61.24	--	74.00	12.76	100.0	V	101.0	9.5



### EUT Information

EUT Name: Quarterback Sensor  
 Model: T11012920  
 Test Mode: 922.396MHz  
 Test Voltage: Battery  
 Remark: Temp 24 Humi:47%  
 Test Standard: FCC 15.247  
 Tested By: Kei Zhang  
 Reviewed By: Terry Yin

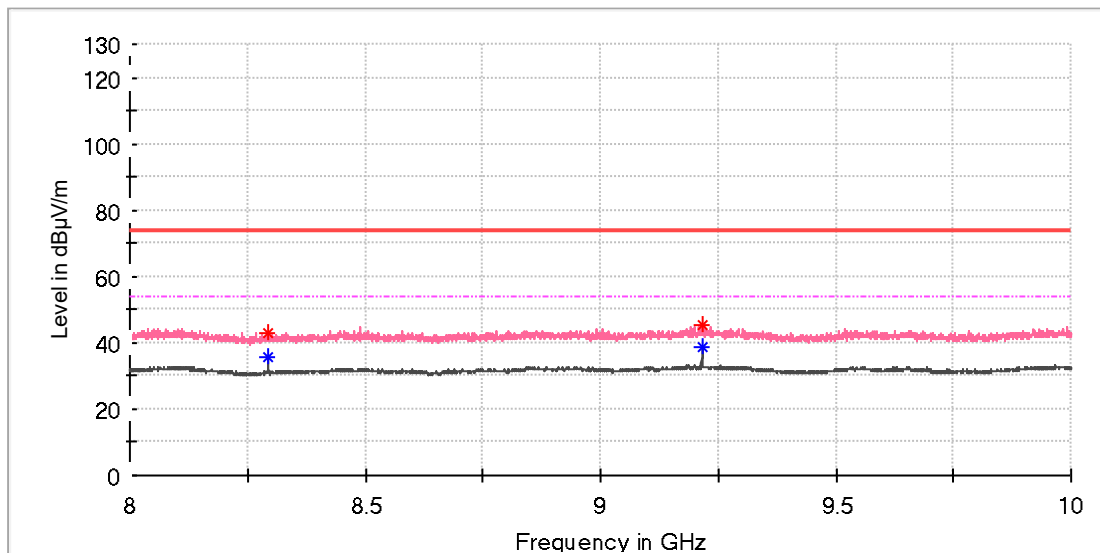

### Critical Freqs

Frequency (MHz)	MaxPeak (dBµV/m)	Average (dBµV/m)	Limit (dBµV/m)	Margin (dB)	Height (cm)	Pol	Azimuth (deg)	Corr. (dB/m)
8294.000000	---	35.49	54.00	18.51	100.0	V	7.0	8.3
8294.500000	43.09	---	74.00	30.91	100.0	V	7.0	8.3
9216.000000	45.55	---	74.00	28.45	100.0	V	77.0	10.3
9216.500000	---	38.52	54.00	15.48	100.0	V	179.0	10.3