

# TEST REPORT

For

## Mobile Base Station

In conformity with

### FCC Part22H (01 Oct, 2009) IC RSS-132 Issue2

**Model:** RTR-500GSM

**FCC ID:** SRD10010

**IC Certification No:** 5558A-10010

**Test Item:** Mobile Base Station

**Report No:** RY1005P06R2

**Issue Date:** 06 May, 2010

**Prepared for**

T&D CORPORATION  
817-1, Shimadachi, Matsumoto, Nagano, Japan, 390-0852

**Prepared by**

RF Technologies Ltd.  
472, Nippa-cho, Kohoku-ku, Yokohama, 223-0057, Japan  
Telephone: +81+(0)45- 534-0645  
FAX: +81+(0)45- 534-0646

**This report shall not be reproduced, except in full, without the written permission of RF Technologies Ltd. The test results in this report apply only to the sample(s) tested. RF Technologies Ltd. is managed to ISO17025 and has the necessary knowledge and test facilities for testing according to the referenced standards.**

## Table of Contents

<b>1</b>	<b>General information .....</b>	<b>3</b>
1.1	Product description .....	3
1.2	Test(s) performed/ Summary of test result .....	3
1.3	Test facility .....	4
1.4	Measurement uncertainty .....	4
1.5	Description of essential requirements and test results.....	5
1.5.1	Transmitter requirements .....	5
1.5.2	Receiver requirements.....	5
1.5.3	AC Power Line Parameters.....	5
1.5.4	Normal test conditions .....	5
1.5.5	Extreme test conditions.....	5
1.6	Setup of equipment under test (EUT) .....	6
1.6.1	Test configuration of EUT .....	6
1.6.2	Operating condition: .....	6
1.6.3	Setup diagram of tested system:.....	7
1.7	Equipment modifications .....	7
1.8	Deviation from the standard.....	7
<b>2</b>	<b>Test procedure and result.....</b>	<b>8</b>
2.1	Transmitter Requirement .....	8
2.1.1	Carrier Output Power (Conducted).....	8
2.1.2	Carrier Output Power (Radiated) .....	9
2.1.3	Frequency Stability (Temperature) .....	12
2.1.4	Frequency Stability (Voltage).....	14
2.1.5	Occupied Bandwidth.....	15
2.1.6	Transmitter Out of Band Spurious Emissions (Conducted).....	16
2.1.7	Transmitter Out of Band Spurious Emissions (Radiated).....	19
2.1.8	Band Edge Emissions.....	23
2.1.9	Transmitter AC Power Line Emission requirement.....	25
2.2	Receiver requirement .....	27
2.2.1	Receiver Spurious Emissions (Radiated).....	27
2.2.2	Receiver AC Power Line Emission requirement .....	30
2.3	Maximum Permissible Exposure (Exposure of Humans to RF Fields) .....	32
<b>3</b>	<b>Test setup photographs.....</b>	<b>33</b>
<b>4</b>	<b>List of utilized test equipment/ calibration .....</b>	<b>34</b>

## History

Report No.	Issue Date	Revision Contents	Issued by
RY1005P06R2	06 May, 2010	Initial Issue	T.Kato

## 1 General information

### 1.1 Product description

Test item : Mobile Base Station  
Manufacturer : T&D CORPORATION  
Address : 817-1, Shimadachi, Matsumoto, Nagano, Japan 390-0852  
Model : RTR-500GSM  
FCC ID : SRD10010  
IC Certification No : 5558A-10010  
Operating frequency range : TX 824.2-848.8 MHz (GSM850)  
: RX 869.2-893.8 MHz (GSM850)  
Type of Modulation : GMSK  
Receipt date of EUT : 07 Apr, 2010  
Nominal power voltages : 120 Vac (AC adaptor)  
Power Class : 4 (Maximum power +33dBm nominal)  
Antenna Type : Dipole antenna (Reverse SMA connector)  
Serial numbers : 329E000B (for Receiver test)  
: 329E000D (for Transmitter test)

### 1.2 Test(s) performed/ Summary of test result

Applicable Standard(s) : FCC Part22H (01 Oct, 2009)  
: IC RSS-132 Issue2  
Test(s) started : 09 Apr, 2010  
Test(s) completed : 15 Apr, 2010  
Purpose of test(s) : Certification of FCC / IC  
Summary of test result : Complied (Radiated item only)

Note: The above judgment is only based on the measurement data and it does not include the measurement uncertainty. Accordingly, the statement below is applied to the test result. The EUT complies with the limit required in the standard in case that the margin is not less than the measurement uncertainty in the Laboratory. Compliance of the EUT is more probable than non-compliance is case that the margin is less than the measurement uncertainty in the Laboratory.

Test engineer :   
T. Kato (Engineer, EMC testing department)

Reviewer :   
K. Ohnishi (Manager, EMC testing department)

### 1.3 Test facility

The Federal Communications Commission has reviewed the technical characteristics of the test facilities at RF Technologies Ltd., located in 472, Nippa-cho, Kohoku-ku, Yokohama, 223-0057, Japan, and has found these test facilities to be in compliance with the requirements of 47 CFR Part 15, section 2.948, per 01 October, 2009.

The description of the test facilities has been filed under registration number 319924 at the Office of the Federal Communications Commission. The facility has been added to the list of laboratories performing these test services for the public on a fee basis.

The list of all public test facilities is available on the Internet at <http://www.fcc.gov>.

Registered by Voluntary Control Council for Interference by Information Technology Equipment (VCCI).

Each registered facility number is as follows;

Test site (Semi-anechoic chamber 3m) R-2393

Test site (Shielded room) C-2617

Registered by Industry Canada (IC). The registered facility number is as follows;

Test site No.1(Semi-anechoic chamber 3m) : 6974A-1

Accredited by **National Voluntary Laboratory Accreditation Program** (NVLAP) for the emission tests stated in the scope of the certificate under Certificate Number 200780-0

This report must not be used by the client to claim product certification, approval, or endorsement by NVLAP, NIST, or any agency of the Federal Government.



NVLAP LAB CODE 200780-0

### 1.4 Measurement uncertainty

The treatment of uncertainty is based on the general matters on the definition of uncertainty in “Guide to the expression of uncertainty in measurement (GUM)” published by ISO. The Lab’s uncertainty is determined by referring UKAS Publication LAB34: 2002 “The Expression of Uncertainty in EMC Testing” and CISPR16-4-2: 2003 “Uncertainty in EMC Measurements”.

The uncertainty of the measurement result in the level of confidence of approximately 95% (k=2) is as follows;

RF frequency:  $\pm 1 \times 10^{-7}$

RF power conducted:  $\pm 1.0$  dB

AC Power line emission:  $\pm 1.9$  dB

Radiated emission (30MHz - 1000MHz):  $\pm 5.7$  dB

Radiated emission (1GHz - 20GHz):  $\pm 5.8$  dB

Temperature:  $\pm 1$  degree

Humidity:  $\pm 5$  %

## 1.5 Description of essential requirements and test results

An overview of radio requirements, as laid out in FCC Part22 / IC RSS-132 are given below.

Only radiated items were tested in this report. (Manufacture request)

### 1.5.1 Transmitter requirements

Test Description	Section in this report	Applicable	Result
Carrier Output Power (Conducted)	2.1.1	Yes	Not tested
Carrier Output Power (Radiated)	2.1.2	Yes	Passed
Frequency Stability (Temperature Variation)	2.1.3	Yes	Not tested
Frequency Stability (Voltage Variation)	2.1.4	Yes	Not tested
Occupied Bandwidth	2.1.5	Yes	Not tested
Out of Band Emissions (Conducted)	2.1.6	Yes	Not tested
Out of Band Emissions (Radiated)	2.1.7	Yes	Passed
Band Edge Emissions	2.1.8	Yes	Not tested

### 1.5.2 Receiver requirements

Test Description	Section in this report	Applicable	Result
Spurious Emissions (Radiated)	2.2.1	Yes	Passed

### 1.5.3 AC Power Line Parameters

Test Description	Section in this report	Applicable	Result
AC power line Spurious Emissions (Traffic mode)	2.1.9	Yes	Not tested
AC power line Spurious Emissions (Idle mode)	2.2.2	Yes	Not tested

### 1.5.4 Normal test conditions

Temperature(\*) : +15 degC to +35 degC  
 Relative humidity(\*) : 20 % to 75 %  
 Supply voltage : 120 Vac (AC adaptor)  
 Measurement Frequency : 824.2 MHz(128ch), 836.4 MHz(189ch), 848.8 MHz(251ch)

\* When it is impracticable to carry out tests under these conditions, a note to this effect, stating the ambient temperature and relative humidity during the tests, must be stated separately.

### 1.5.5 Extreme test conditions

This test condition was not used in this report.

## 1.6 Setup of equipment under test (EUT)

### 1.6.1 Test configuration of EUT

#### Equipment(s) under test:

	Item	Manufacturer	Model No.	Serial No.	FCC ID /IC Cert. No
A	Mobile Base Station (for RX test)	T&D CORPORATION	RTR-500GSM	329E000B	SRD10010/ 5558A-10010
A'	Mobile Base Station (for TX test)	T&D CORPORATION	RTR-500GSM	329E000D	SRD10010/ 5558A-10010
B	Alkaline Battery	TOSHIBA	-	-	N/A

#### Support Equipment(s):

	Item	Manufacturer	Model No.	Serial No.	FCC ID /IC Cert.No
C	AC adaptor	T&D CORPORATION	AD-0605	-	N/A

#### Connected cable(s):

No.	Item	Identification (Manu.e.t.c)	Shielded Yes / No	Ferrite Core Yes / No	Connector Type Shielded Yes / No	Length (m)
1	DC power cable	T&D CORPORATION	No	No	No	1.85

### 1.6.2 Operating condition:

- Traffic mode : EUT is connected with RF tester in Max power level. (Normal and GPRS mode)  
Idle mode : EUT is under idle mode, no output power is transmitted.

### 1.6.3 Setup diagram of tested system:

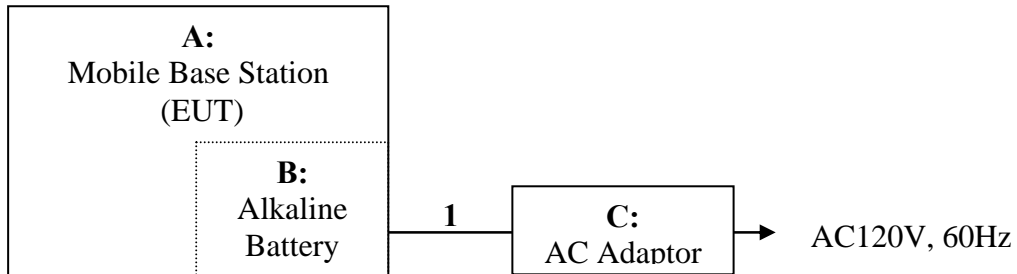

### 1.7 *Equipment modifications*

No modifications have been made to the equipment in order to achieve compliance with the applicable standards described in clause 1.2.

### 1.8 *Deviation from the standard*

No deviations from the standards described in clause 1.2.

## 2 Test procedure and result

### 2.1 Transmitter Requirement

#### 2.1.1 Carrier Output Power (Conducted)

##### Reference Standard

FCC : Part22.913, 2.1046

IC : RSS-132 Issue2 Sec4.4, SRSP Issue7 Sec.5.1.3

##### Test Conditions

Date:

Ambient Temperature:

Relative humidity:

Test Voltage:

##### Test Method

- a) EUT is connected to RF tester with pseudo random data modulation and set to maximum output power level.
- b) The output power is measured with RF tester (CMU200 etc.).

##### Test Setup

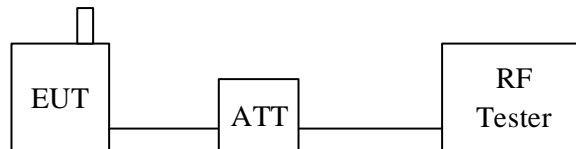

##### Test Results

Channel	Frequency [MHz]	Output Power [dBm]		Limit [dBm]	Result
		Normal	GPRS		
Bottom (128ch)	824.2				
Middle (189ch)	836.4				
Top (251ch)	848.8				

##### Test Equipment Used

Equipment name	RFT ID No.
RF tester	
RF cable	

##### Final Result

This item was not tested.



## 2.1.2 Carrier Output Power (Radiated)

### Reference Standard

FCC : Part22.913, 2.1046

IC : RSS-132 Issue2 Sec4.4, SRSP Issue7 Sec.5.1.3

### Tested sample

Sample A' (in Sec 1.6.1)

### Test Conditions

Date: 12 Apr, 2010

Ambient Temperature: 20 degC

Relative humidity: 47 %

Test Voltage: 120 Vac

### Test Method

Substitution method is used for this test.

a) EUT is set on non-conducting table and the output power is set to the maximum level.

b) As a receive antenna, Horn antenna is used.

c) Maximum power is measured by a spectrum analyzer (SA) in below conditions.

Turntable is rotated 360 degrees.

The height of receive antenna is changed from 1m to 4m.

Receive antenna polarization is set to vertical and horizontal.

This maximum power is recorded.

During this measurement, receive antenna is adjusted the direction to keep the EUT within the beamwidth of receive antenna.

d) Reference antenna is replaced with EUT, and connected with signal generator (SG).

SG output power is adjusted to get same level as the recorded maximum radiated EUT power by SA.

e) Radiated output power (Pout) is calculated with adjusted SG output (Psg) [dBm], reference antenna gain (Gref) [dBd] and cable loss between SG and reference antenna (Lcab) [dB].

$$P_{out} [\text{dBm e.r.p}] = P_{sg} + G_{ref} + L_{cab}$$

## Test Setup

[Measurement]

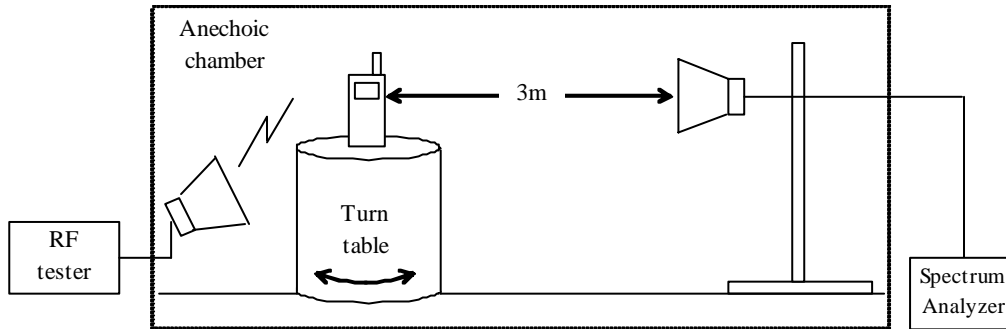

[Substitution]

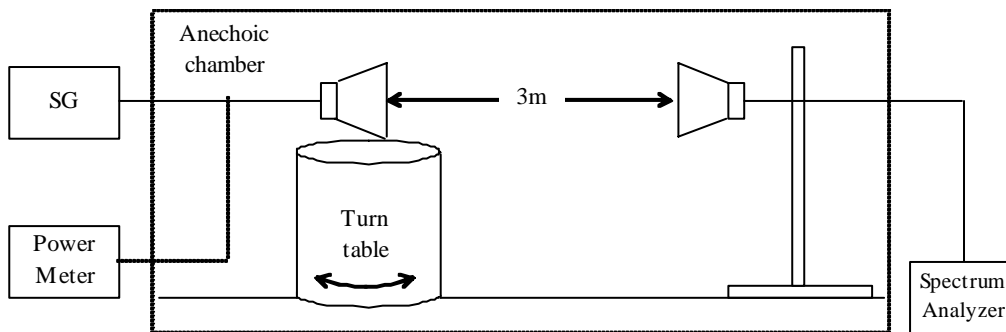

## Test Results

Channel	Frequency [MHz]	Output Power [dBm]		Limit [dBm e.r.p]	Result
		Normal	GPRS		
Bottom (128ch)	824.2	23.4	23.4	38.4	Pass
Middle (189ch)	836.4	23.8	23.8	38.4	Pass
Top (251ch)	848.8	25.1	25.1	38.4	Pass

## Test Equipment Used

Equipment name	RFT ID No.
Spectrum Analyzer	TR06
Receive Antenna	DH02
Reference Antenna	LA02
Signal Generator	SG05
Power Meter	PM03
Power sensor	PU03
RF tester	RC03
RF cable	CL24

## Final Result

The EUT met the requirements of the standard for this test.

## 2.1.3 Frequency Stability (Temperature)

### Reference Standard

FCC : Part22.355, 2.1055

IC : RSS-132 Issue2 Sec4.3

### Test Conditions

Date:

Ambient Temperature:

Relative humidity:

Test Voltage:

### Test Method

To measure the carrier frequency, “Frequency error measurement” function of RF tester is used.

- a) EUT is hold about 30 minutes under measurement temperature condition.
- b) EUT is powered on with nominal voltage.
- c) EUT is connected to RF tester with Max transmit power level.
- d) Frequency error is measured by RF tester for 10 minutes.
- e) Process a) to d) is repeated at 10deg increments from -30 to +50degC.

### Test Setup

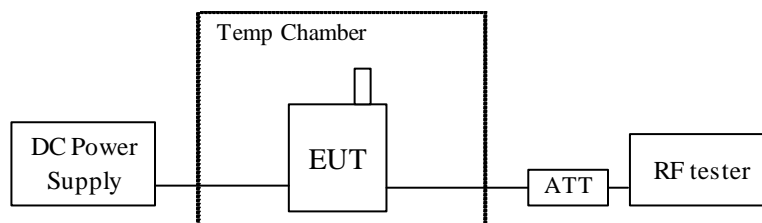

**Test Results****Middle Channel (189ch, Nominal Freq.:836.4MHz)**

Temperature [deg C]	Frequency Error [Hz]	Frequency Error [ppm]	Limit [ppm]	Result
-30			± 2.5	
-20			± 2.5	
-10			± 2.5	
0			± 2.5	
10			± 2.5	
20			± 2.5	
30			± 2.5	
40			± 2.5	
50			± 2.5	

**Test Equipment Used**

Equipment name	RFT ID No.
RF tester	
Temp Chamber	

**Final Result**

This item was not tested.

## 2.1.4 Frequency Stability (Voltage)

### Reference Standard

FCC : Part22.355, 2.1055  
 IC : RSS-132 Issue2 Sec4.3

### Test Conditions

Date:  
 Ambient Temperature:  
 Relative humidity:  
 Test Voltage:

### Test Method

To measure the carrier frequency, “Frequency error measurement” function of RF tester is used.  
 a) EUT is powered on with nominal voltage. Temperature is 20degC.  
 b) EUT is connected to RF tester with Max transmitter power level.  
 c) Frequency error is measured by RF tester for 10 minutes.  
 d) Process a) to c) is repeated at minimum and maximum voltage condition.

### Test Setup

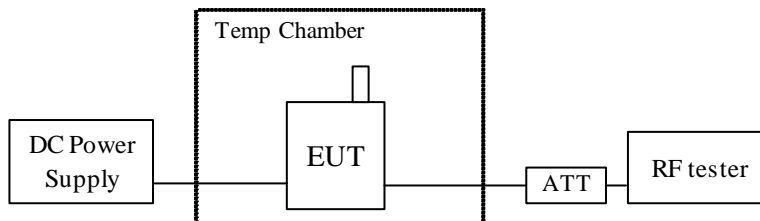

### Test Results

#### Middle Channel (189ch, Nominal Freq.:836.4MHz)

Voltage [V]	Frequency Error [Hz]	Frequency Error [ppm]	Limit [ppm]	Result
			± 2.5	
			± 2.5	
			± 2.5	

### Test Equipment Used

Equipment name	RFT ID No.
RF tester	
Temp chamber	

### Final Result

This item was not tested.

## 2.1.5 Occupied Bandwidth

### Reference Standard

FCC : Part2.1049

IC : RSS-Gen Issue2 Sec4.6.1

### Test Conditions

Date:

Ambient Temperature:

Relative humidity:

Test Voltage:

### Test Method

- a) EUT is connected to RF tester with Max transmitter power level.
- b) 26dB bandwidth is measured by Spectrum Analyzer.
- c) 99% occupied bandwidth of transmitter spectrum is measured by Spectrum Analyzer.

### Test Setup

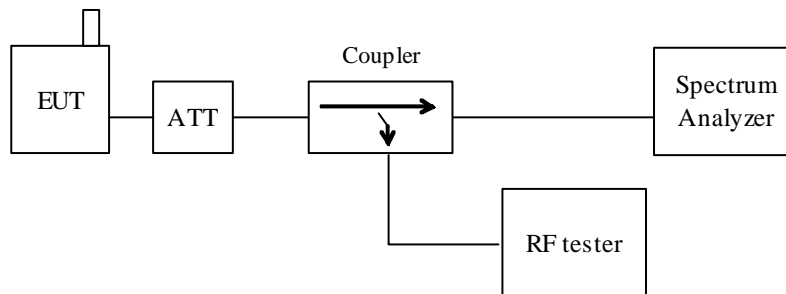

### Test Results

Channel	Frequency [MHz]	26dB Bandwidth [kHz]	99% Bandwidth [kHz]
Bottom (128ch)	824.2		
Middle (189ch)	836.4		
Top (251ch)	848.8		

### Test Equipment Used

Equipment name	RFT ID No.
Spectrum Analyzer	
RF tester	
RF cable	
Directional coupler	

This item was not tested.

## 2.1.6 Transmitter Out of Band Spurious Emissions (Conducted)

### Reference Standard

FCC : Part22.917

IC : RSS-132 Issue2 Sec4.5

### Test Conditions

Date:

Ambient Temperature:

Relative humidity:

Test Voltage:

### Test Method

- EUT is connected to RF tester with Max transmitter power level.
- Out of band Spurious is measured by Spectrum Analyzer.
- Resolution band width of spectrum analyzer is set to 1MHz (above 1GHz) or 100kHz (below 1GHz).

### Test Setup

30MHz to 1500MHz

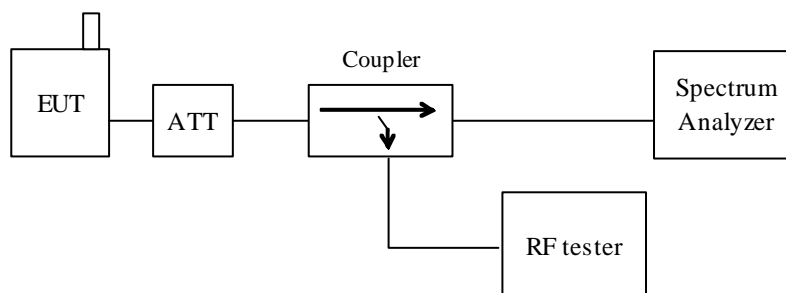

above 1500MHz

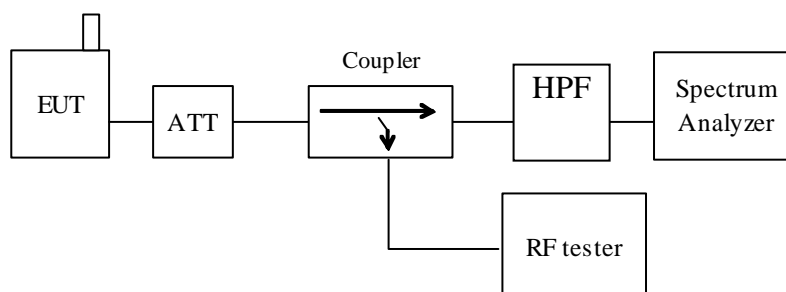



## Test Results

### Bottom Channel (128ch, Nominal Freq.:824.2MHz)

Measurement Frequency [MHz]	Measurement Bandwidth [MHz]	Emission Level [dBm]	Limit [dBm]	Result Pass/Fail
1648.4	1		-13.0	
2472.6	1		-13.0	
3296.8	1		-13.0	
4121.0	1		-13.0	
4945.2	1		-13.0	
5769.4	1		-13.0	
6593.6	1		-13.0	
7417.8	1		-13.0	
8242.0	1		-13.0	
others		-	-13.0	

### Middle Channel (189ch, Nominal Freq.:836.4MHz)

Measurement Frequency [MHz]	Measurement Bandwidth [MHz]	Emission Level [dBm]	Limit [dBm]	Result Pass/Fail
1672.8	1		-13.0	
2509.2	1		-13.0	
3345.6	1		-13.0	
4182.0	1		-13.0	
5018.4	1		-13.0	
5854.8	1		-13.0	
6691.2	1		-13.0	
7527.6	1		-13.0	
8364.0	1		-13.0	
others		-	-13.0	

**Top Channel (251ch, Nominal Freq.:848.8MHz)**

Measurement Frequency [MHz]	Measurement Bandwidth [MHz]	Emission Level [dBm]	Limit [dBm]	Result Pass/Fail
1697.6	1		-13.0	
2546.4	1		-13.0	
3395.2	1		-13.0	
4244.0	1		-13.0	
5092.8	1		-13.0	
5941.6	1		-13.0	
6790.4	1		-13.0	
7639.2	1		-13.0	
8488.0	1		-13.0	
others		-	-13.0	

**Graphical Data (189ch, Pre-scan)****Test Equipment Used**

Equipment name	RFT ID No.
Spectrum Analyzer	
RF tester	
RF cable	
Directional coupler	
High pass filter	

**Final Result**

This item was not tested.

## 2.1.7 Transmitter Out of Band Spurious Emissions (Radiated)

### Reference Standard

FCC : Part22.917

IC : RSS-132 Issue2 Sec4.5

### Tested sample

Sample A' (in Sec 1.6.1)

### Test Conditions

Date: 14 Apr, 2010 (Above 1GHz), 15 Apr, 2010 (Below 1GHz)  
Ambient Temperature: 20degC (14 Apr), 19degC (15 Apr)  
Relative humidity: 41 % (14 Apr), 38 % (15 Apr)  
Test Voltage: 120 Vac

### Test Method

Substitution method is used for this test.

- a) EUT is set on non-conducting table and the output power is set to the maximum level.
- b) As a receive antenna, Horn antenna is used for high frequency range (above 1GHz), and Biological antenna is used for low frequency range (30MHz to 1GHz).
- c) The maximum level of each spurious emission is measured by a spectrum analyzer (SA) in below conditions.

Turntable is rotated 360 degrees.

The height of receive antenna is changed from 1m to 4m.

Receive antenna polarization is set to vertical and horizontal.

EUT was placed at three different orientations (X, Y and Z axis) in order to find the worst orientation.

This emission level is recorded.

During this measurement, receive antenna is adjusted the direction to keep the EUT within the beamwidth of receive antenna.

- d) Reference antenna is replaced with EUT, and connected with signal generator (SG).  
SG output power is adjusted to get same level as the recorded maximum radiated EUT power by SA.
- e) Radiated output power (Pout) is calculated with adjusted SG output (Psg) [dBm], reference antenna gain (Gref) [dBd] and cable loss between SG and reference antenna (Lcab) [dB].

$$Pout \text{ [dBm e.r.p]} = Psg + Gref + Lcab$$

## Test Setup

### [Measurement]

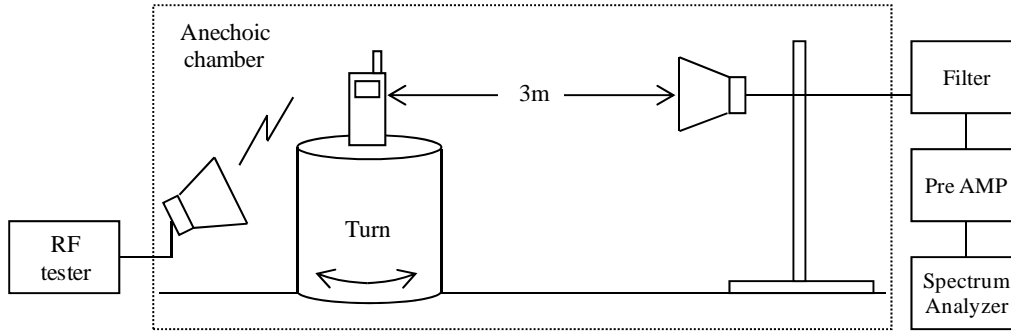

### [Substitution]

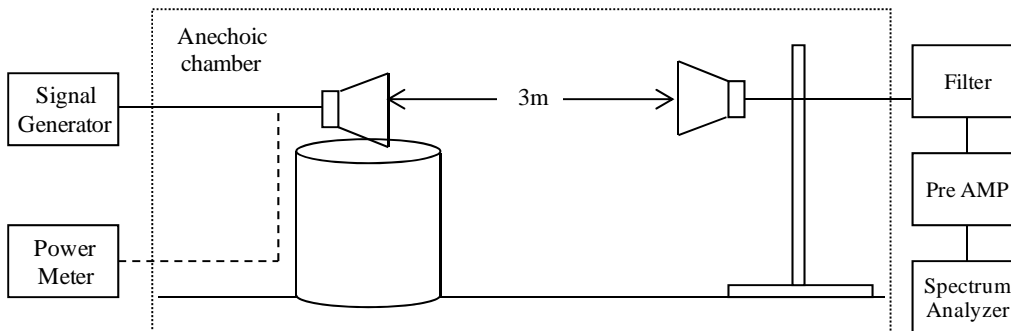

## Test Results

### Bottom Channel (128ch, Nominal Freq.:824.2MHz)

Measurement Frequency [MHz]	Measurement Bandwidth [MHz]	Emission Level [dBm]		Limit [dBm]	Result Pass/Fail
		Vertical	Horizontal		
1648.4	1	-34.8	-35.3	-13.0	Pass
2472.6	1	-48.0	-45.1	-13.0	Pass
3296.8	1	-51.8	-51.8	-13.0	Pass
4121.0	1	-51.0	-50.6	-13.0	Pass
4945.2	1	-50.2	-45.5	-13.0	Pass
5769.4	1	< -49.8	< -49.8	-13.0	Pass
6593.6	1	-44.1	-41.8	-13.0	Pass
7417.8	1	-45.0	-43.4	-13.0	Pass
8242.0	1	-41.1	-42.4	-13.0	Pass
1098.94	1	-54.0	-53.2	-13.0	Pass

### Middle Channel (189ch, Nominal Freq.:836.4MHz)

Measurement Frequency [MHz]	Measurement Bandwidth [MHz]	Emission Level [dBm]		Limit [dBm]	Result Pass/Fail
		Vertical	Horizontal		
1672.8	1	-38.4	-36.8	-13.0	Pass
2509.2	1	-46.5	-44.2	-13.0	Pass
3345.6	1	-52.3	-50.6	-13.0	Pass
4182.0	1	-50.6	-50.0	-13.0	Pass
5018.4	1	-50.4	-47.8	-13.0	Pass
5854.8	1	< -49.1	< -48.9	-13.0	Pass
6691.2	1	-41.7	-40.1	-13.0	Pass
7527.6	1	< -46.7	-46.0	-13.0	Pass
8364.0	1	-41.1	-42.1	-13.0	Pass
1115.21	1	-57.1	-56.1	-13.0	Pass

## Top Channel (251ch, Nominal Freq.:848.8MHz)

Measurement Frequency [MHz]	Measurement Bandwidth [MHz]	Emission Level [dBm]		Limit [dBm]	Result Pass/Fail
		Vertical	Horizontal		
1697.6	1	-44.8	-42.0	-13.0	Pass
2546.4	1	-49.9	-46.4	-13.0	Pass
3395.2	1	-51.6	-51.6	-13.0	Pass
4244.0	1	-51.6	-52.0	-13.0	Pass
5092.8	1	-50.5	-48.9	-13.0	Pass
5941.6	1	< -48.5	-47.1	-13.0	Pass
6790.4	1	-39.2	-37.8	-13.0	Pass
7639.2	1	< -47.0	-46.0	-13.0	Pass
8488.0	1	-42.3	-42.7	-13.0	Pass
1131.75	1	-58.5	-57.2	-13.0	Pass

## Test Equipment Used

Equipment name	RFT ID No.
Spectrum Analyzer	TR06
Receive Antenna	DH02, BA04
Reference Antenna	DH01
Signal Generator	SG05
Power Meter	PM03
Power Sensor	PU03
RF tester	RC03
RF cable	CL11, CL23, CL24, CL27
Filter	BRF4, HPF2

## Final Result

The EUT met the requirements of the standard for this test.

## 2.1.8 Band Edge Emissions

### Reference Standard

FCC : Part22.917

IC : RSS-132 Issue2 Sec4.5

### Test Conditions

Date:

Ambient Temperature:

Relative humidity:

Test Voltage:

### Test Method

- a) EUT is connected to RF tester with Max transmitter power level.
- b) Lower band edge level is measured in bottom channel transmission.
- c) Higher band edge level is measured in top channel transmission.
- d) 1% of band width is used for resolution band width for spectrum analyzer.

### Test Setup

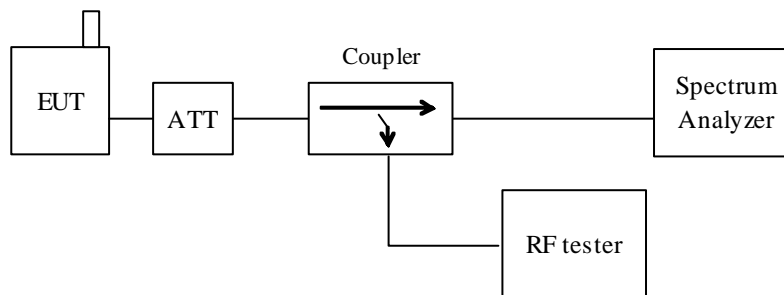

### Test Results

#### Bottom Band Edge

Measured Frequency [MHz]	Peak Level [dBm]	Limit [dBm]	Result
		-13.0	Passed

#### Top Band Edge

Measured Frequency [MHz]	Peak Level [dBm]	Limit [dBm]	Result
		-13.0	Passed

## Graphical Data

### Test Equipment Used

Equipment name	RFT ID No.
Spectrum Analyzer	
RF tester	
RF cable	
Directional coupler	

### Final Result

This item was not tested.



## 2.1.9 Transmitter AC Power Line Emission requirement

### Reference Standard

FCC : Part15.207

IC : RSS-Gen Issue2 Sec7.2

### Test Conditions

Date:

Ambient Temperature:

Relative humidity:

Test Voltage:

### Test Method

- a) EUT is connected to RF tester with Max transmitter power level.
- b) AC power is supplied to AC charger through LISN.
- c) AC charger is connected to EUT.
- d) AC Line conducted emission is measured by EMI receiver.  
 Both Va/Vb line are measured emission level.

### Test Setup

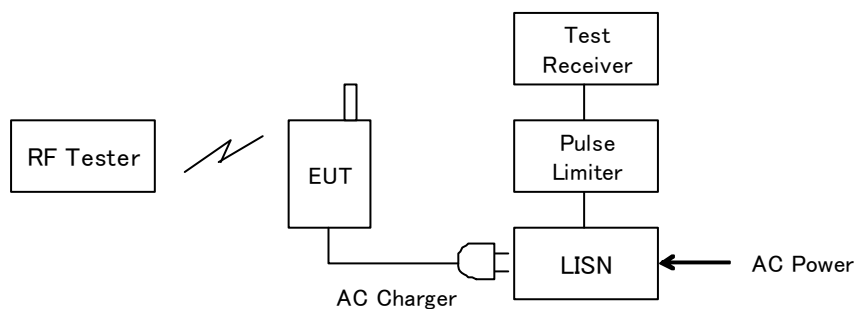

### Limit

Frequency [MHz]	Limit QP [dBμV]	Limit AVE [dBμV]
0.15 - 0.5	66 - 56	56 - 46
0.5 - 5	56	46
5 - 30	60	50

**Test Results**

Frequency [MHz]	Line (Va/Vb)	QP Reading [dB $\mu$ V]	AVE Reading [dB $\mu$ V]	Factor [dB]	QP Result [dB $\mu$ V]	AVE Result [dB $\mu$ V]	QP Limit [dB $\mu$ V]	AVE Limit [dB $\mu$ V]	Result

**Graphical Data****Test Equipment Used**

Equipment name	RFT ID No.
EMI Receiver	
LISN	
RF tester	
RF cable	

**Final Result**

This item was not tested.

## 2.2 Receiver requirement

### 2.2.1 Receiver Spurious Emissions (Radiated)

#### Reference Standard

FCC : Part15.109

IC : RSS-132 Issue2 Sec4.6

#### Tested sample

Sample A (in Sec 1.6.1)

#### Test Conditions

Date: 09 Apr, 2010

Ambient Temperature: 18 degC

Relative humidity: 35 %

Test Voltage: 120 Vac

#### Test Method

- EUT is connected to RF tester with idle mode.
- Radiated receiver spurious emission is received by receive antenna.
- Turn table is rotated 360deg.
- Maximum level of each spurious is measured by spectrum analyzer.
- RBW of spectrum analyzer is set to 100kHz for 30 - 1000MHz, 1MHz for above 1GHz.
- Level is measured with QP detect for 30 - 1000MHz, Average detect for above 1GHz.
- EUT was placed at three different orientations (X, Y and Z axis) in order to find the worst orientation.

#### Test Setup

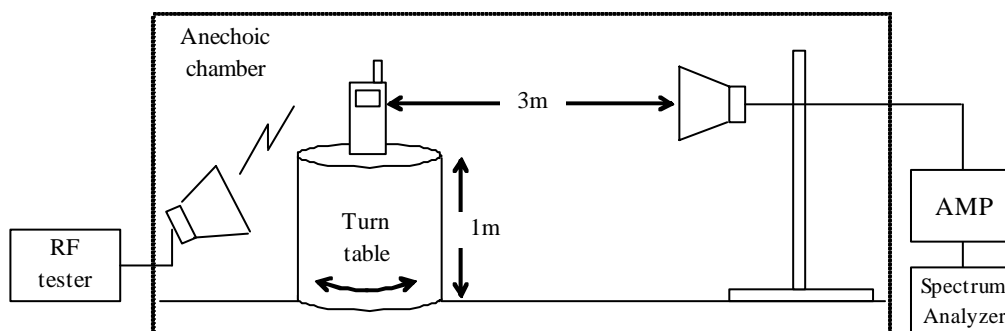

## Limit

Frequency [MHz]	Distance [m]	Field strength [ $\mu\text{V}/\text{m}$ ]	Field strength [ $\text{dB}\mu\text{V}/\text{m}$ ]
30 - 88	3	100	40.0
88 - 216	3	150	43.5
216 - 960	3	200	46.0
above 960	3	500	53.9

## Test Results [30 – 1000 MHz]

Frequency [MHz]	Antenna	Reading [ $\text{dB}\mu\text{V}$ ]	Factor [ $\text{dB}/\text{m}$ ]	Loss [dB]	Gain [dB]	Field strength [ $\text{dB}\mu\text{V}/\text{m}$ ]	Limit [ $\text{dB}\mu\text{V}/\text{m}$ ]	Result
48.574	Vert.	31.2	8.9	7.6	29.7	18.0	40.0	Passed
960.000	Vert.	21.0	21.1	14.4	28.4	28.1	46.0	Passed

There was no other spurious emission greater than noise floor.

## Graphical Data

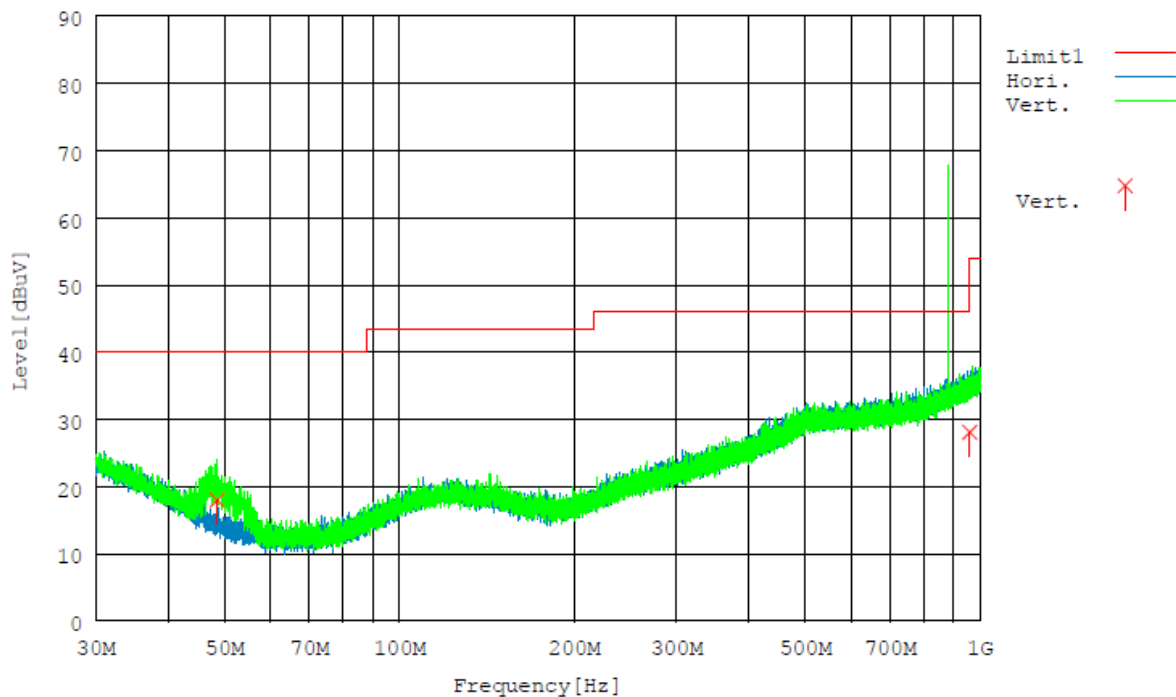

Note : A spectrum @881MHz is downlink signal from RF tester. This is used to set EUT in idle mode.  
 This is not a spurious emission from EUT.

## Test Results [1000 – 5000 MHz]

Freq. [MHz]	Ant.	Reading Peak [dBμV]	Reading Ave [dBμV]	C.Factor [dB]	Result Peak [dBμV/m]	Result Ave [dBμV/m]	Limit Peak [dBμV/m]	Limit Ave [dBμV/m]	Result
5000.000	Vert.	44.0	30.6	2.6	46.6	33.2	73.9	53.9	Passed

There was no other spurious emission greater than noise floor.

## Graphical Data

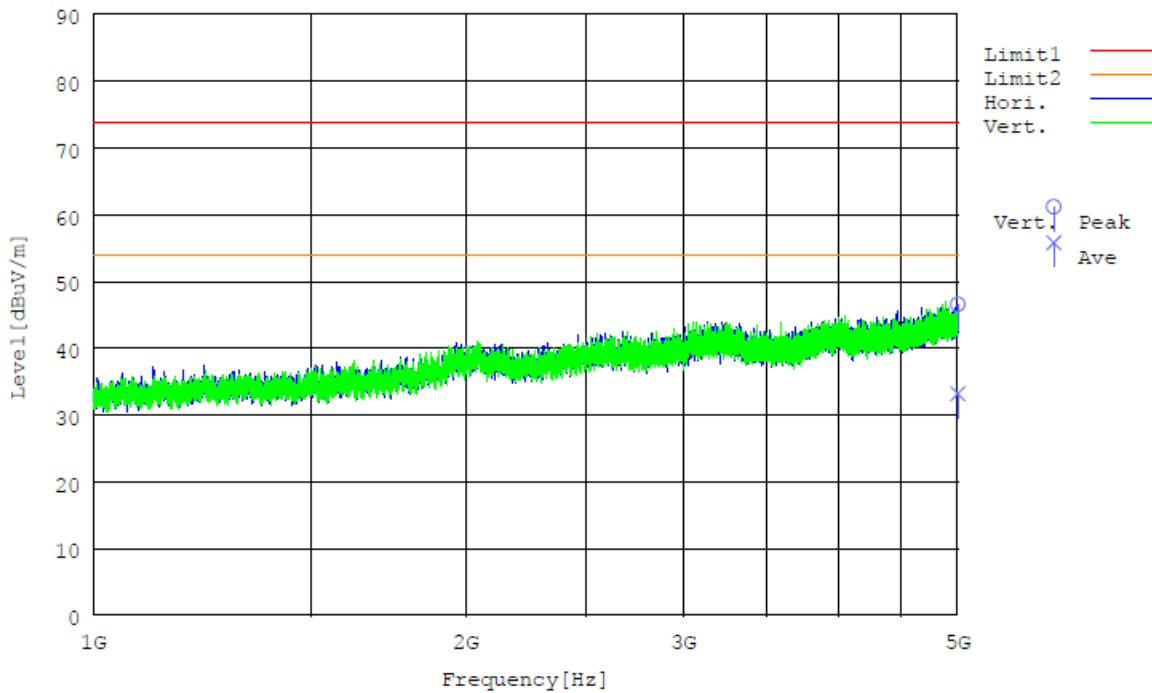

## Test Equipment Used

Equipment name	RFT ID No.
Spectrum Analyzer	TR06
Receive Antenna	DH02, BA04
Pre-AMP	PR12, PR03
RF tester	RC03
RF cable	CL11, CL23, CL24

## Final Result

The EUT met the requirements of the standard for this test.

## 2.2.2 Receiver AC Power Line Emission requirement

### Reference Standard

FCC : Part15.107

IC : RSS-Gen Issue2 Sec7.2

### Test Conditions

Date:

Ambient Temperature:

Relative humidity:

Test Voltage:

### Test Method

- a) EUT is connected to RF tester with idle mode.
- b) AC power is supplied to AC charger through LISN.
- c) AC charger is connected to EUT.
- d) AC Line conducted emission is measured by EMI receiver.
  - Both Va/Vb line are measured emission level.

### Test Setup

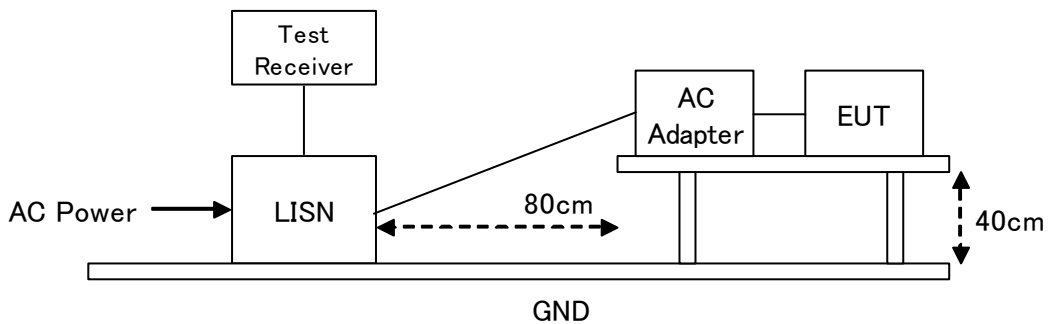

### Limit

Frequency [MHz]	Limit QP [dBμV]	Limit AVE [dBμV]
0.15 - 0.5	66 - 56	56 - 46
0.5 - 5	56	46
5 - 30	60	50

**Test Results**

Frequency [MHz]	Line [Va/Vb]	QP Reading [dB $\mu$ V]	AVE Reading [dB $\mu$ V]	Factor [dB]	QP Result [dB $\mu$ V]	AVE Result [dB $\mu$ V]	QP Limit [dB $\mu$ V]	AVE Limit [dB $\mu$ V]	Result

**Graphical Data****Test Equipment Used**

Equipment name	RFT ID No.
EMI Receiver	
LISN	
RF tester	
RF cable	

**Final Result**

This item was not tested.

## 2.3 Maximum Permissible Exposure (Exposure of Humans to RF Fields)

### Limitation

15.247(i) systems operating under the provisions of this section shall be operated in a manner that ensures that the public is not exposed to radio frequency energy levels in excess of the Commission's guidelines.

See 1.1307(b) (1) of this Chapter.

1.1310 The criteria of "General Population/ Uncontrolled Exposure" listed in the below table shall be used to evaluate the environmental impact of human exposure to radio-frequency radiation as specified in 1.1307(b), except in the case of portable devices which shall be evaluated according to the provisions of 2.1093 of this chapter.

### Limits for General Population/Uncontrolled Exposure

Frequency Range (MHz)	Electric Field Strength (E) (V/m)	Magnetic Field Strength (H) (A/m)	Power Density (S) (mW/cm <sup>2</sup> )	Averaging Time  E  <sup>2</sup> ,  H  <sup>2</sup> or S (minutes)
0.3-1.34	614	1.63	(100)*	30
1.34-30	824/f	2.19/f	(180/f <sup>2</sup> )*	30
30-300	27.5	0.073	0.2	30
300-1500	--	--	f/1500	30
1500-100,000	--	--	1.0	30

f = frequency in MHz

\*Plane-wave equivalent power density

NOTE 2: *General population/uncontrolled* exposures apply in situations in which the general public may be exposed, or in which persons that are exposed as a consequence of their employment may not be fully aware of the potential for exposure or can not exercise control over their exposure.

### The MPE distance calculations:

The Maximum Permissible Exposure (MPE) distance between the EUT's antenna and human body is calculated in accordance with FCC OET Bulletin 65 and Safety Code 6 of IC.

The MPE distance where the exposure level reaches the permitted exposure level can be calculated as below;

$$S = P * G / 4\pi R^2$$

Rearranging terms to calculate the MPE Distance

$$R = (P * G / 4\pi S)^{1/2}$$

Where:

**R = MPE Distance in cm**

**P \* G = Radiated Power in mW**

(25.1dBm = 323.6 mW @848.8 MHz in page 10 of this report)

**S = Power Density Limit in mW/cm<sup>2</sup>**

(0.56 mW/cm<sup>2</sup>, Max. permissible exposure limit above)

Then MPE Distance is 6.78 cm. (< 30cm)

**Test results - Complied with requirement.**



## 4 List of utilized test equipment/ calibration

RFT ID No.	Kind of Equipment and Precision	Manufacturer	Model No.	Serial Number	Calibration Date	Calibrated until
AC01(EM)	Anechoic Chamber (1st test room)	JSE	203397C	-	2010/4/10	2011/4/30
AC01(EG)	Anechoic Chamber (1st test room)	JSE	203397C	-	2009/11/14	2010/11/30
BA04	Biological Antenna	SCHAFFNER	CA2855	2903	2010/1/19	2011/1/31
BRF4	Band Reject Filter (WCDMA850)	M-City	BRF0835-01	RF0004	2009/4/8	2010/4/30
CL11	Antenna Cable for RE	RFT	-	-	2009/4/13	2010/4/30
CL18	Antenna Cable for CE	RFT	-	-	2009/5/21	2010/5/31
CL23	RF Cable 0.5m	SUCOFLEX	SF104PE	48773/4PE	2009/6/25	2010/6/30
CL24	RF Cable 5.0m	SUCOFLEX	SF104PE	48775/4PE	2009/6/25	2010/6/30
CL27	RF Cable 0.5m	SUCOFLEX	SF104	230286/4	2009/6/29	2010/6/30
HPF2	High Pass Filter (1500MHz)	M-City	HPF0900-01	RF0003-01	2009/6/25	2010/6/30
LA02	Logperiodic Antenna	SCHWARZBECK	USLP 9143	339	2009/7/22	2010/7/31
PM03	Power Meter	Anritsu	ML2438A	99070001	2009/7/21	2010/7/31
PR03	Pre. Amplifier	Anritsu	MH648A	M41984	2009/5/26	2010/5/31
PR08	Pre. Amplifier	Sonoma Instrument	315	263504	2010/1/25	2011/1/31
PR12	Pre. Amplifier (1-26G)	Agilent Technologies	8449B	3008A02513	2010/1/25	2011/1/31
PU03	Power Sensor	Anritsu	MA2472A	990103	2009/7/21	2010/7/31
TR06	Test Receiver (F/W : 3.93 SP2)	Rohde & Schwarz	ESU26	100002	2009/9/16	2010/9/30
DH01	DRG Horn Antenna	A.H. Systems	SAS-571	785	2010/1/20	2012/1/31
DH02	DRG Horn Antenna	A.H. Systems	SAS-200/571	239	2009/4/13	2011/4/30
RC03	Radio communication tester (F/W : 10.20 #005)	Anritsu	MT8820B	6200636657	2009/6/26	2010/6/30
SG05	Signal Generator	Rohde & Schwarz	SMR20	100905	2009/6/18	2010/6/30

The measuring equipment, which was utilized in performing the tests documented herein, has been calibrated in accordance with the manufacturer's recommendations for utilizing calibration equipment, which is traceable to recognized national standards.