

# Bluetooth SPP Module Operation Manual

**Rev.01**

JUN 6, 2012

Fujitsu Component Limited

CONFIDENTIAL

1. INTRODUCTION .....	3
2. COPYRIGHT NOTICE AND DISCLAIMER.....	3
3. NECESSARY ITEM.....	3
3.1 MBH-SAKURA2 CIRCUIT DIAGRAM.....	4
4. SET-UP FOR BLUETOOTH SPP CONNECTION.....	5
5. REQUIRED SOFTWARE.....	6
6. SETTING OF TERA TERM .....	6
7. OPERATING PROCEDURE FOR TX/RX MODE CONTROL.....	7
7.1 MODE CHANGE OF THE SPP BLUETOOTH MODULE .....	7
7.2 OPERATION OF TEST TOOL BY CSR .....	8
8. TEST COMMANDS .....	10
8.1 TX MODE COMMAND .....	10
8.1.1 Tx Unmodulated wave setting.....	10
8.1.2 Tx Modulated wave setting .....	10
8.1.3 Tx 79 channels frequency hopping setting.....	11
8.1.4 Tx AFH 20 channels AFH (Adaptive Frequency Hopping) setting.....	11
8.2 RX MODE COMMAND.....	12

CONFIDENTIAL

## 1. INTRODUCTION

This document describes the method of Tx/Rx mode control for Bluetooth SPP Module provided by FCL (Fujitsu Component Limited)

## 2. Copyright Notice and Disclaimer

Copyright © 2012 FUJITSU COMPONENT LIMITED. All rights reserved

BLUETOOTH, The Bluetooth Figure Mark, and the Bluetooth Combination Mark are registered trademarks owned by Bluetooth SIG, Inc.

Windows is a registered trademark of Microsoft Corporation in the United States and other countries.

Linux is a registered trademark of Mr. Linus Torvalds in Japan and other countries

Other third-party brands and names are the property of their respective owners.

This document is subject to change without any prior notice.

## 3. Necessary item

- MBH-SAKURA2: Bluetooth SPP Module Evaluation board
- USB Cable
- PC
- Bluetooth SPP Module with Daughter Board
  - MBH7BTZ42-DAUGHTER
  - MBH7BTZ52-DAUGHTER
- Or Bluetooth SPP Module with connector
  - MBH7BTZ40
  - MBH7BTZ43
  - MBH7BTZ50
  - MBH7BTZ53

### 3.1 MBH-SAKURA2 Circuit diagram

SAKURA2 SPP Module Evaluation Board

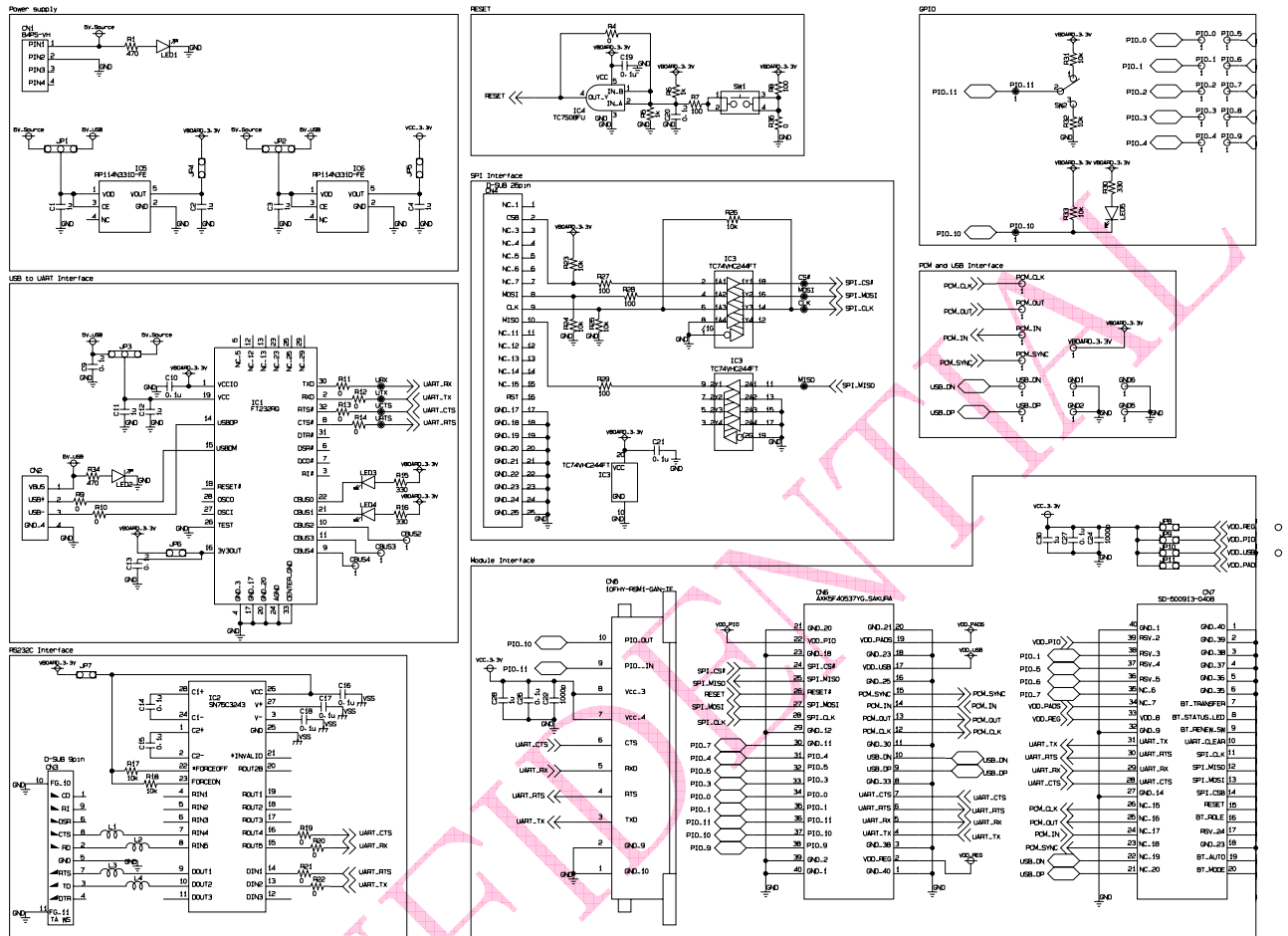

#### 4. SET-UP for Bluetooth SPP connection

Connect CN2 connector on MBH-SAKURA2 and the USB port on PC with USB cable to control Bluetooth SPP module (Figure 4-1).

To work with the USB serial port (UART over USB), first download the FTDI FT232R driver (D2XX and VCP) from:

<http://www.ftdichip.com/Drivers/VCP.htm>

Install the driver according to the installation guide available on the FTDI web site.

After the driver is installed, go to *My Computer->Properties->Hardware->Device Manager->Ports* to identify the COM port to which the USB serial port is assigned.

-The baud rate is set to 115.2kbps (Default setting)

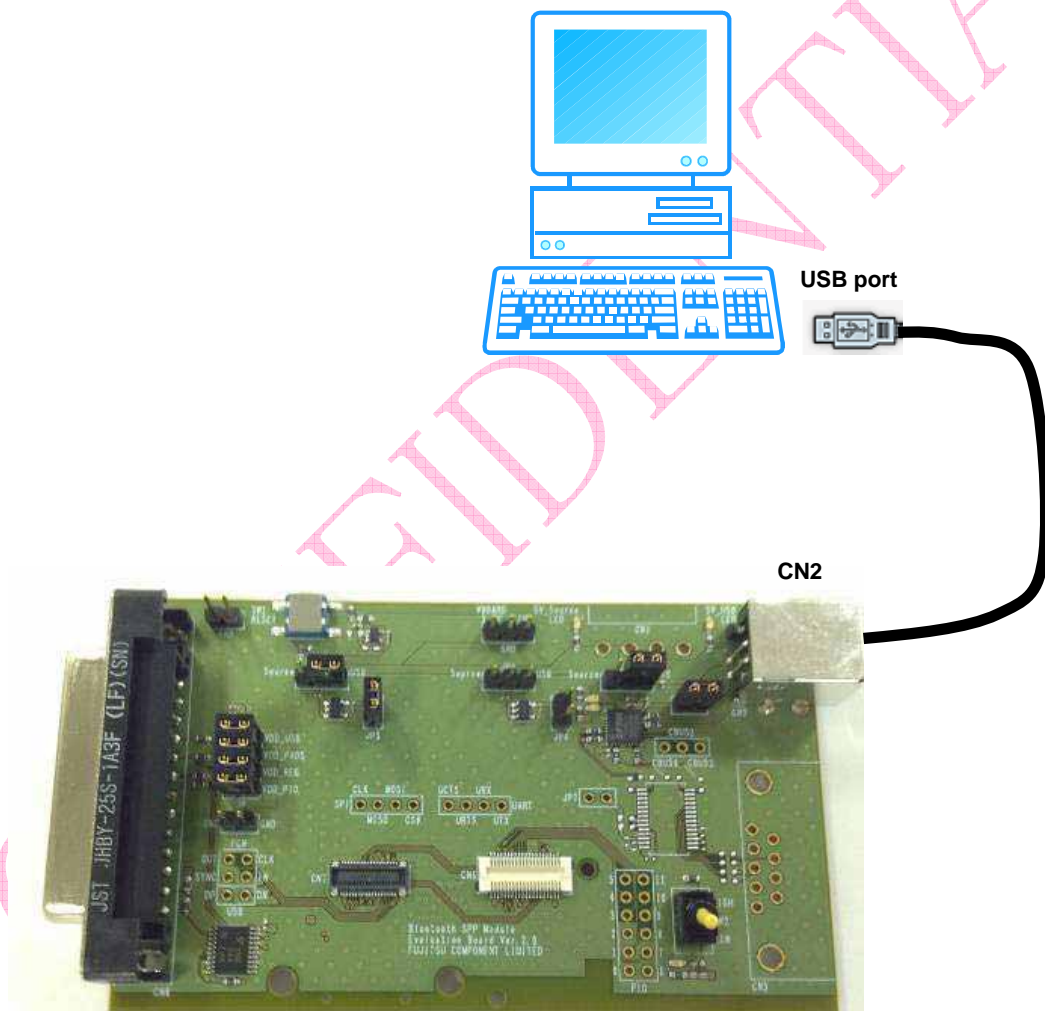

Figure 4-1: Hardware Setup

## 5. Required Software

“BlueSuite” test tool by CSR.

Account registration is required to download from the support website of CSR.

When there is no account, please contact your local sales.

“Tera Term” is terminal software to control Bluetooth SPP module.

Tera Term is downloadable from the following website.

<http://tssh2.sourceforge.jp/>

## 6. Setting of Tera Term

When you use Tera Term, please change the setting as below.

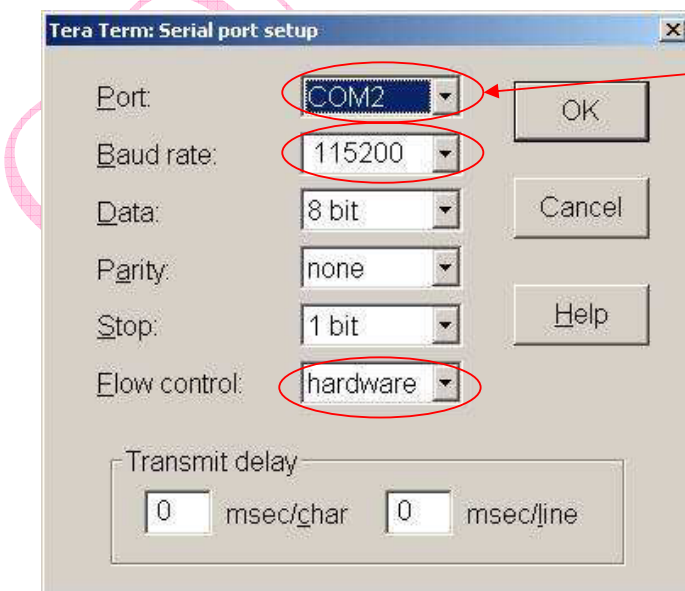
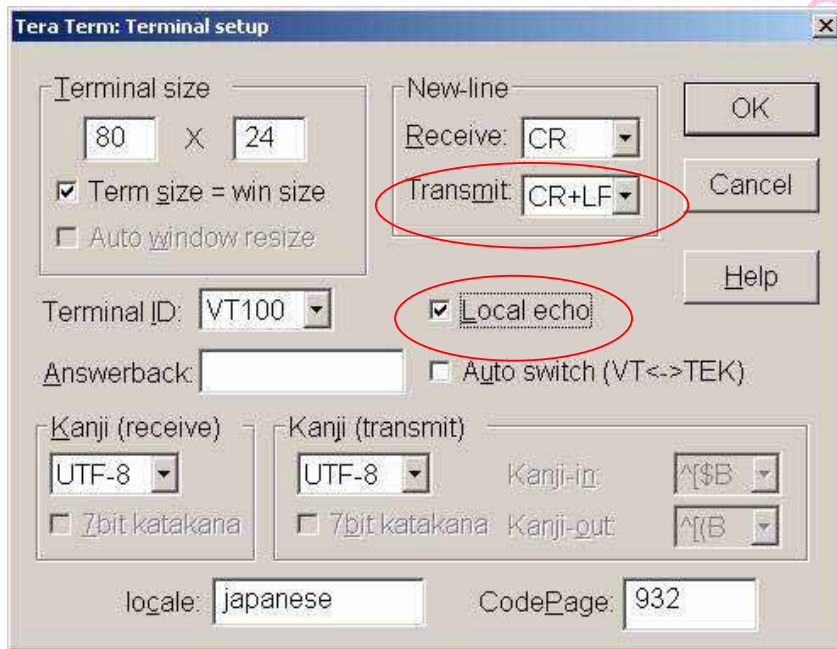

Select COM Port No which is assigned USB Serial port

## 7. Operating Procedure for Tx/Rx mode control

### 7.1 Mode change of the SPP Bluetooth module

Connect CN2 connector on MBH-SAKURA2 and the USB port on PC with a USB cable to control Bluetooth SPP Module.

And, launch the Tera Term.

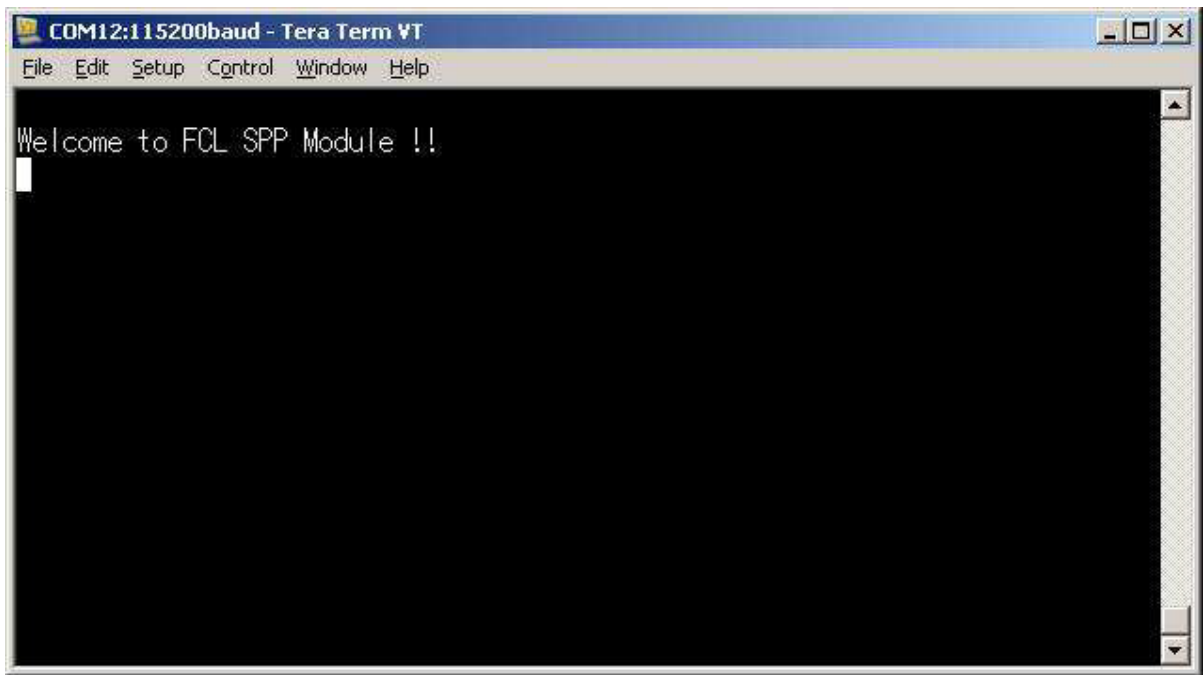

Input the BCSP\_MODE command to change from SPP mode to BCSP mode.

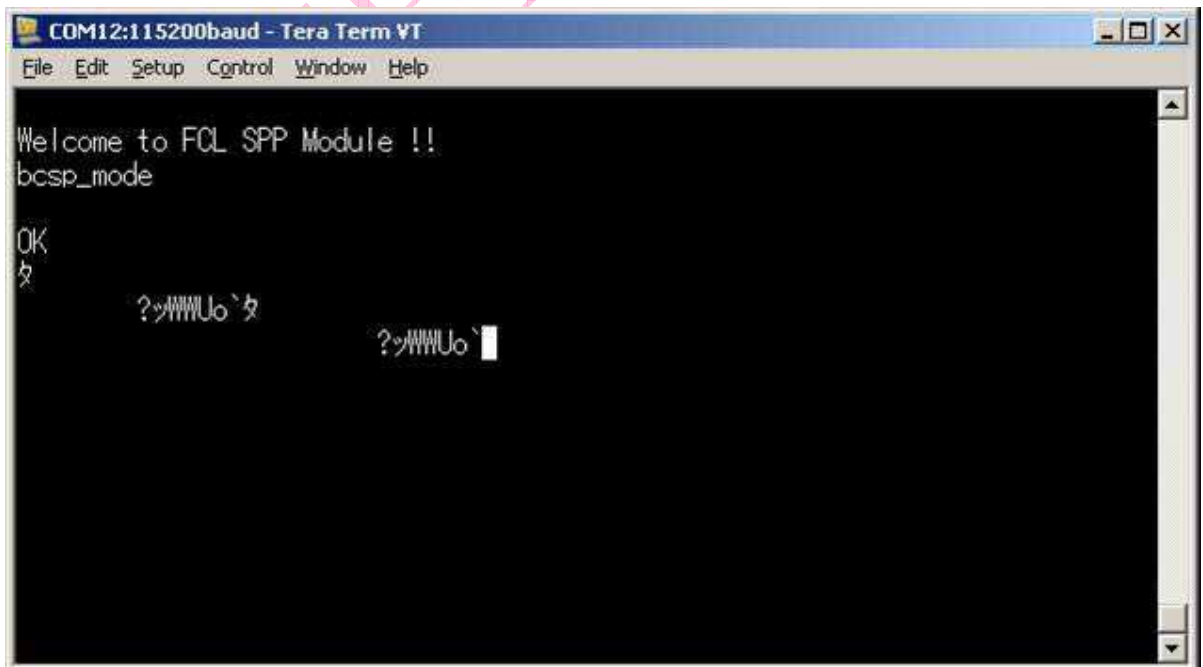

**\*Note: Since it is temporary, this module will operate SPP mode after reset (or power on).**



## 7.2 Operation of Test tool by CSR

Close Tera Term after changing SPP Bluetooth module to BCSP mode.  
And, execute "BtCLI" from Windows start menu.

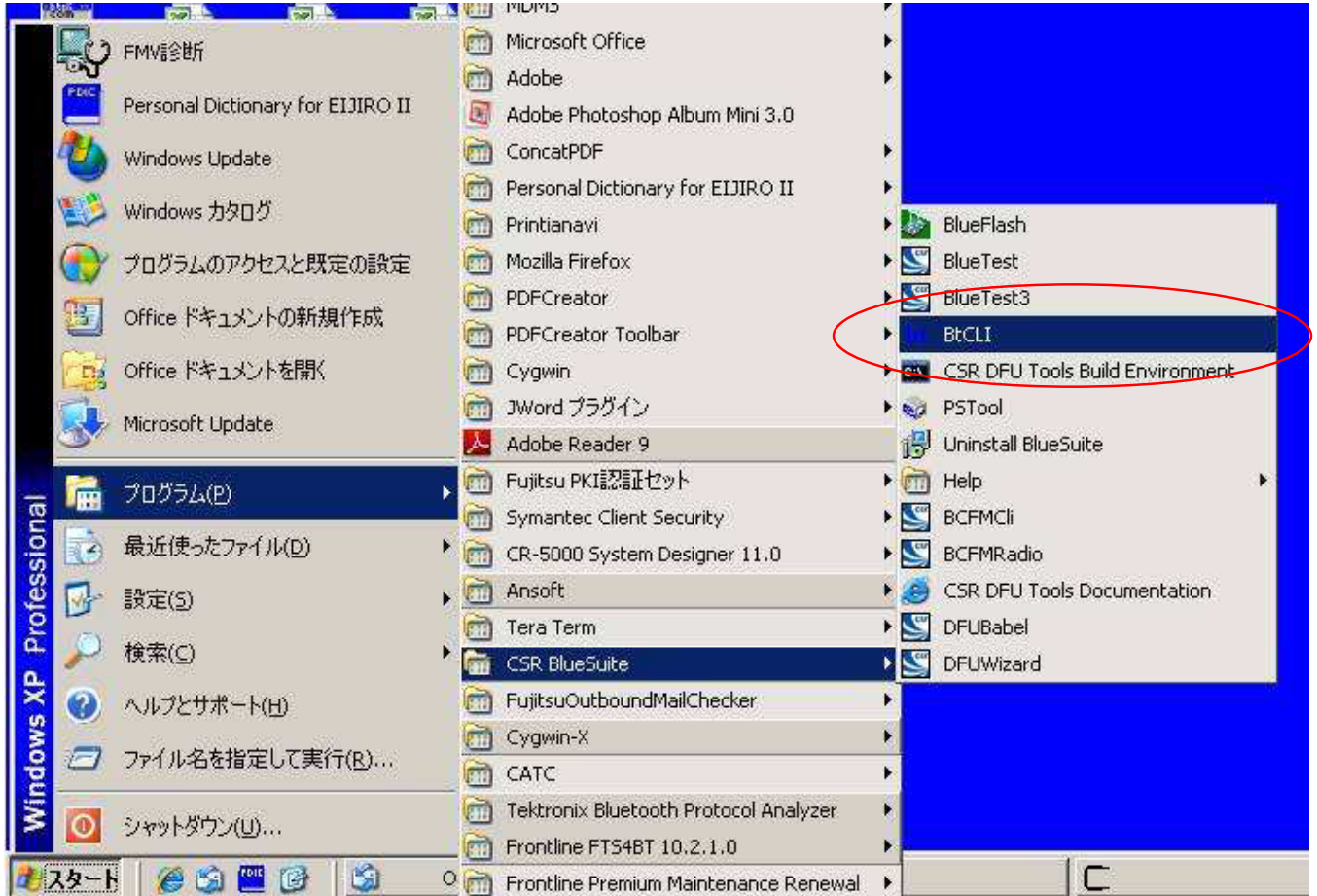

Set up as follows and click "OK".

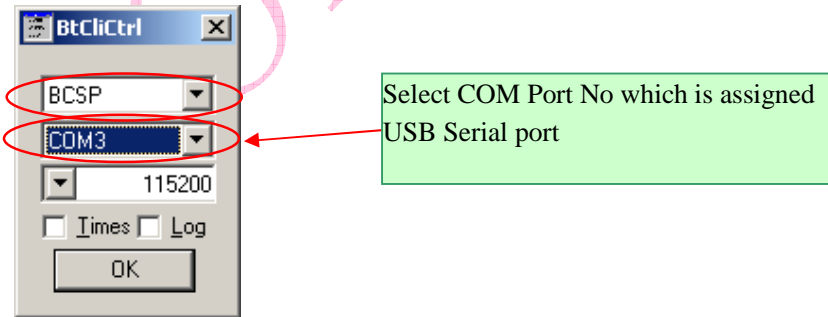



The command prompt window is opened as follows.

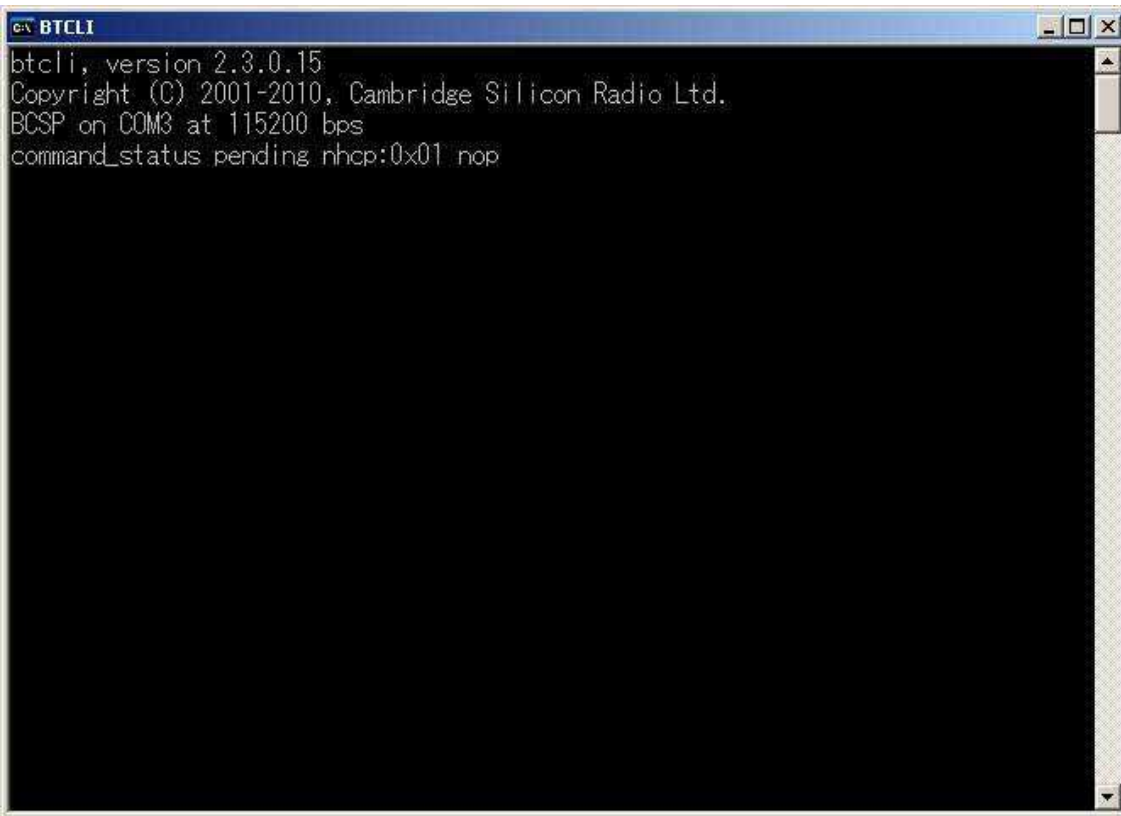

SPP Bluetooth module is controlled by command line interface. Refer to the following page for the details of a command. (The following is example for the setup of unmodulated, BasicRate, DH5 packet.)

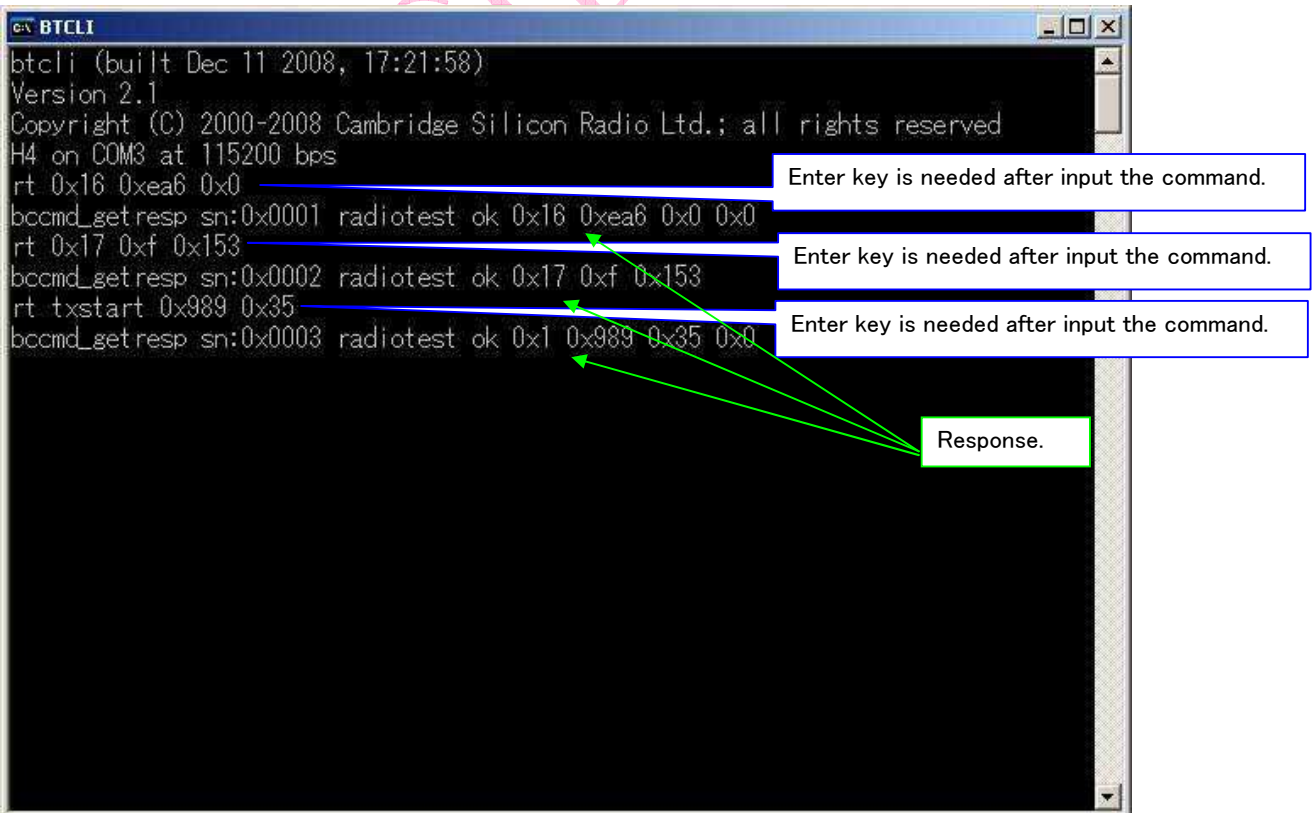

## 8. Test Commands

### 8.1 Tx mode command

#### 8.1.1 Tx Unmodulated wave setting

	Name/Setting item	Transfer rate	Packet type	Ch	The command to input
1	Select "TX/RX interval Value" using rt command <"cfg_frq">	-	DH1	-	rt_0x16_0x4e2_0x0
			DH3	-	rt_0x16_0x9c4_0x0
			DH5	-	rt_0x16_0xea6_0x0
2	Select "Packet Type" using rt command <"cfg_pkt">	Basic Rate	DH1	-	rt_0x17_0x4_0x1b
			DH3	-	rt_0x17_0xb_0xb7
			DH5	-	rt_0x17_0xf_0x153
		EDR 2M	DH1	-	rt_0x17_0x14_0x36
			DH3	-	rt_0x17_0x1a_0x16f
			DH5	-	rt_0x17_0x1e_0x2a7
		EDR 3M	DH1	-	rt_0x17_0x18_0x53
			DH3	-	rt_0x17_0x1b_0x228
			DH5	-	rt_0x17_0x1f_0x3fd
3	Select "Output Power" using rt command <"txstart">	Basic Rate	-	Ch0	rt_txstart_0x962_0x35
			-	Ch39	rt_txstart_0x989_0x35
			-	Ch78	rt_txstart_0x9b0_0x35
		EDR 2M/3M	-	Ch0	rt_txstart_0x962_0x5f
			-	Ch39	rt_txstart_0x989_0x5f
			-	Ch78	rt_txstart_0x9b0_0x5f

#### 8.1.2 Tx Modulated wave setting

	Name/Setting item	Transfer rate	Packet type	Ch	The command to input
1	Select "TX/RX interval Value" using rt command <"cfg_frq">	-	DH1	-	rt_0x16_0x4e2_0x0
			DH3	-	rt_0x16_0x9c4_0x0
			DH5	-	rt_0x16_0xea6_0x0
2	Select "Packet Type" using rt command <"cfg_pkt">	Basic Rate	DH1	-	rt_0x17_0x4_0x1b
			DH3	-	rt_0x17_0xb_0xb7
			DH5	-	rt_0x17_0xf_0x153
		EDR 2M	DH1	-	rt_0x17_0x14_0x36
			DH3	-	rt_0x17_0x1a_0x16f
			DH5	-	rt_0x17_0x1e_0x2a7
		EDR 3M	DH1	-	rt_0x17_0x18_0x53
			DH3	-	rt_0x17_0x1b_0x228
			DH5	-	rt_0x17_0x1f_0x3fd
3	Select "Output Power" using rt command <"txdata1">	Basic Rate	-	Ch0	rt_txdata1_0x962_0x35
			-	Ch39	rt_txdata1_0x989_0x35
			-	Ch78	rt_txdata1_0x9b0_0x35
		EDR 2M/3M	-	Ch0	rt_txdata1_0x962_0x5f
			-	Ch39	rt_txdata1_0x989_0x5f
			-	Ch78	rt_txdata1_0x9b0_0x5f

### 8.1.3 Tx 79 channels frequency hopping setting

	Name/Setting item	Transfer rate	Packet type	Ch	The command to input
1	Select "TX/RX interval Value" using rt command <"cfg_frq">	-	DH1	-	rt_0x16_0x4e2_0x0
			DH3	-	rt_0x16_0x9c4_0x0
			DH5	-	rt_0x16_0xea6_0x0
2	Select "Packet Type" using rt command <"cfg_pkt">	Basic Rate	DH1	-	rt_0x17_0x4_0x1b
			DH3	-	rt_0x17_0xb_0xb7
			DH5	-	rt_0x17_0xf_0x153
		EDR 2M	DH1	-	rt_0x17_0x14_0x36
			DH3	-	rt_0x17_0x1a_0x16f
			DH5	-	rt_0x17_0x1e_0x2a7
		EDR 3M	DH1	-	rt_0x17_0x18_0x53
			DH3	-	rt_0x17_0x1b_0x228
			DH5	-	rt_0x17_0x1f_0x3fd
3	Select "Output Power" using rt command <"txdata2">	Basic Rate	-	-	rt_txdata2_0x0_0x35
		EDR 2M/3M	-	-	rt_txdata2_0x0_0x5f

### 8.1.4 Tx AFH 20 channels AFH (Adaptive Frequency Hopping) setting

	Name/Setting item	Transfer rate	Packet type	Ch	The command to input
1	Select "TX/RX interval Value" using rt command <"cfg_frq">	-	DH1	-	rt_0x16_0x4e2_0x0
			DH3	-	rt_0x16_0x9c4_0x0
			DH5	-	rt_0x16_0xea6_0x0
2	Select "Packet Type" using rt command <"cfg_pkt">	Basic Rate	DH1	-	rt_0x17_0x4_0x1b
			DH3	-	rt_0x17_0xb_0xb7
			DH5	-	rt_0x17_0xf_0x153
		EDR 2M	DH1	-	rt_0x17_0x14_0x36
			DH3	-	rt_0x17_0x1a_0x16f
			DH5	-	rt_0x17_0x1e_0x2a7
		EDR 3M	DH1	-	rt_0x17_0x18_0x53
			DH3	-	rt_0x17_0x1b_0x228
			DH5	-	rt_0x17_0x1f_0x3fd
3	Select "Necessary frequency range of AFH" using rt command	Low (Ch 0-19)			rt_0x002d_0xffff_0x000f_0x0000_0x0000_0x0000
		Middle (Ch 28-47)			rt_0x002d_0x0000_0xf000_0xffff_0x0000_0x0000
		High (Ch 59-78)			rt_0x002d_0x0000_0x0000_0x0000_0xf800_0x7fff
4	Select "Output Power" using rt command <"txdata2">	Basic Rate	-	-	rt_txdata2_0x0_0x35
		EDR 2M/3M	-	-	rt_txdata2_0x0_0x5f

## 8.2 Rx mode command

	Name/Setting item	Transfer rate	Packet type	Ch	The command to input
1	Select "TX/RX interval Value" using rt command <"cfg_frq">	-	-	-	rt_0x16_0xea6_0x0
2	Select "Packet Type" using rt command <"cfg_pkt">	-	-	-	rt_0x17_0xf_0x153
3	Set rt command <"rxstart1">	-	-	Ch0	rt_rxstart1_0x962
				Ch39	rt_rxstart1_0x989
				Ch78	rt_rxstart1_0x9b0

CONFIDENTIAL



## **Note to users in the United States of America**

### **Notice:**

This equipment has been tested and found to comply with the limits for a Class B digital device, pursuant to Part 15 of the FCC Rules. These limits are designed to provide reasonable protection against harmful interference in a residential installation.

This equipment generates, uses and can radiate radio frequency energy and, if not installed and used in accordance with the instructions, may cause harmful interference to radio communications. However, there is no guarantee that interference will not occur in a particular installation. If this equipment does cause harmful interference to radio or television reception, which can be determined by turning the equipment off and on, the user is encouraged to try to correct the interference by one or more of the following measures:

Reorient or relocate the receiving antenna.

Increase the separation between the equipment and receiver.

Connect the equipment into an outlet on a circuit different from that to which the receiver is connected.

Consult the dealer or an experienced radio/TV technician for help.

### **Caution:**

Changes or modifications not expressly approved by the party responsible for compliance could void the user's authority to operate the equipment.



### **Declaration of Conformity**

Product Name: Bluetooth Module

Model Number: MBH7BTZ40

Responsible party: Fujitsu Components America, Inc.

Address: 250 E. Caribbean Drive, Sunnyvale, CA 94089 U.S.A.

Telephone number: 408-745-4900

This device complies with part 15 of FCC Rules.

Operation is subject to the following two conditions:

1. This device may not cause harmful interference, and
2. This device must accept any interference received, including interference that may cause undesired operation.



### **Note to users in Canada**

#### **Note:**

This Class B digital apparatus complies with Canadian ICES-003.

#### **Remarque concernant les utilisateurs au Canada Avertissement:**

Cet appareil numérique de la classe B est conforme à la norme NMB-003 du Canada.



### **Note to users**

It is strictly forbidden to use antenna except designated.

This equipment must not be co-located or operated in conjunction with any other antenna or transmitter.

This equipment complies with FCC/IC radiation exposure limits set forth for uncontrolled equipment and meets the FCC radio frequency (RF) Exposure Guidelines in Supplement C to OET65 and RSS-102 of the IC radio frequency (RF) Exposure rules.

This equipment should be installed and operated with at least 20cm more between the radiator and person's body(excluding extremities: hands, wrists, feet and ankles).

Cet équipement est conforme aux limites d'exposition aux rayonnements énoncées pour un environnement non contrôlé et respecte les règles d'exposition aux fréquences radioélectriques (RF) CNR-102 de l'IC. Cet équipement émet une énergie RF très faible qui est considérée conforme sans évaluation de l'exposition maximale autorisée.

Cependant, cet équipement doit être installé et utilisé en gardant une distance de 20 cm ou plus entre le dispositif rayonnant et le corps (à l'exception des extrémités : mains, poignets, pieds et chevilles).

### **Note to users in Canada**

This device complies with RSS-Gen of IC Rules.

Operation is subject to the following two conditions;

1. This device may not cause harmful interference, and
2. This device must accept any interference received, including interference that may cause undesired operation.

### **Remarque concernant les utilisateurs au Canada**

Ce dispositif est conforme à la norme CNR-Gen d'Industrie Canada.

L'utilisation de ce dispositif est autorisée seulement aux deux conditions suivantes: (1)il ne doit pas produire de brouillage et (2) l'utilisateur du dispositif doit être prêt à accepter tout brouillage radioélectrique reçu, même si ce brouillage est susceptible de compromettre le fonctionnement du dispositif.



## **Note to users in the United States of America**

### **Notice:**

This equipment has been tested and found to comply with the limits for a Class B digital device, pursuant to Part 15 of the FCC Rules. These limits are designed to provide reasonable protection against harmful interference in a residential installation.

This equipment generates, uses and can radiate radio frequency energy and, if not installed and used in accordance with the instructions, may cause harmful interference to radio communications. However, there is no guarantee that interference will not occur in a particular installation. If this equipment does cause harmful interference to radio or television reception, which can be determined by turning the equipment off and on, the user is encouraged to try to correct the interference by one or more of the following measures:

Reorient or relocate the receiving antenna.

Increase the separation between the equipment and receiver.

Connect the equipment into an outlet on a circuit different from that to which the receiver is connected.

Consult the dealer or an experienced radio/TV technician for help.

### **Caution:**

Changes or modifications not expressly approved by the party responsible for compliance could void the user's authority to operate the equipment.



### **Declaration of Conformity**

Product Name: Bluetooth Module

Model Number: MBH7BTZ42

Responsible party: Fujitsu Components America, Inc.

Address: 250 E. Caribbean Drive, Sunnyvale, CA 94089 U.S.A.

Telephone number: 408-745-4900

This device complies with part 15 of FCC Rules.

Operation is subject to the following two conditions:

1. This device may not cause harmful interference, and
2. This device must accept any interference received, including interference that may cause undesired operation.



### **Note to users in Canada**

#### **Note:**

This Class B digital apparatus complies with Canadian ICES-003.

#### **Remarque concernant les utilisateurs au Canada Avertissement:**

Cet appareil numérique de la classe B est conforme à la norme NMB-003 du Canada.







## Note to users

It is strictly forbidden to use antenna except designated.

This equipment must not be co-located or operated in conjunction with any other antenna or transmitter.

This equipment complies with FCC/IC radiation exposure limits set forth for uncontrolled equipment and meets the FCC radio frequency (RF) Exposure Guidelines in Supplement C to OET65 and RSS-102 of the IC radio frequency (RF) Exposure rules.

This equipment should be installed and operated with at least 20cm more between the radiator and person's body(excluding extremities: hands, wrists, feet and ankles).

Cet équipement est conforme aux limites d'exposition aux rayonnements énoncées pour un environnement non contrôlé et respecte les règles d'exposition aux fréquences radioélectriques (RF) CNR-102 de l'IC. Cet équipement émet une énergie RF très faible qui est considérée conforme sans évaluation de l'exposition maximale autorisée.

Cependant, cet équipement doit être installé et utilisé en gardant une distance de 20 cm ou plus entre le dispositif rayonnant et le corps (à l'exception des extrémités : mains, poignets, pieds et chevilles).



## Note to users in Canada

This device complies with RSS-Gen of IC Rules.



Operation is subject to the following two conditions;

1. This device may not cause harmful interference, and
2. This device must accept any interference received, including interference that may cause undesired operation.

## Remarque concernant les utilisateurs au Canada

Ce dispositif est conforme à la norme CNR-Gen d'Industrie Canada.

L'utilisation de ce dispositif est autorisée seulement aux deux conditions suivantes: (1)il ne doit pas produire de brouillage et (2) l'utilisateur du dispositif doit être prêt à accepter tout brouillage radioélectrique reçu, même si ce brouillage est susceptible de compromettre le fonctionnement du dispositif.





## Note to users in the United States of America

### Notice:

This equipment has been tested and found to comply with the limits for a Class B digital device, pursuant to Part 15 of the FCC Rules. These limits are designed to provide reasonable protection against harmful interference in a residential installation.

This equipment generates, uses and can radiate radio frequency energy and, if not installed and used in accordance with the instructions, may cause harmful interference to radio communications. However, there is no guarantee that interference will not occur in a particular installation. If this equipment does cause harmful interference to radio or television reception, which can be determined by turning the equipment off and on, the user is encouraged to try to correct the interference by one or more of the following measures:

Reorient or relocate the receiving antenna.

Increase the separation between the equipment and receiver.

Connect the equipment into an outlet on a circuit different from that to which the receiver is connected.

Consult the dealer or an experienced radio/TV technician for help.

### Caution:

Changes or modifications not expressly approved by the party responsible for compliance could void the user's authority to operate the equipment.



### Declaration of Conformity



Product Name: Bluetooth Module

Model Number: MBH7BTZ43

Responsible party: Fujitsu Components America, Inc.

Address: 250 E. Caribbean Drive, Sunnyvale, CA 94089 U.S.A.

Telephone number: 408-745-4900

This device complies with part 15 of FCC Rules.

Operation is subject to the following two conditions:

1. This device may not cause harmful interference, and
2. This device must accept any interference received, including interference that may cause undesired operation.



### Note to users in Canada

#### Note:

This Class B digital apparatus complies with Canadian ICES-003.

#### Remarque concernant les utilisateurs au Canada Avertissement:

Cet appareil numérique de la classe B est conforme à la norme NMB-003 du Canada.





## Note to users

It is strictly forbidden to use antenna except designated.

This equipment must not be co-located or operated in conjunction with any other antenna or transmitter.

This equipment complies with FCC/IC radiation exposure limits set forth for uncontrolled equipment and meets the FCC radio frequency (RF) Exposure Guidelines in Supplement C to OET65 and RSS-102 of the IC radio frequency (RF) Exposure rules.

This equipment should be installed and operated with at least 20cm more between the radiator and person's body(excluding extremities: hands, wrists, feet and ankles).

Cet équipement est conforme aux limites d'exposition aux rayonnements énoncées pour un environnement non contrôlé et respecte les règles d'exposition aux fréquences radioélectriques (RF) CNR-102 de l'IC. Cet équipement émet une énergie RF très faible qui est considérée conforme sans évaluation de l'exposition maximale autorisée.

Cependant, cet équipement doit être installé et utilisé en gardant une distance de 20 cm ou plus entre le dispositif rayonnant et le corps (à l'exception des extrémités : mains, poignets, pieds et chevilles).



## Note to users in Canada

This device complies with RSS-Gen of IC Rules.



Operation is subject to the following two conditions;

1. This device may not cause harmful interference, and
2. This device must accept any interference received, including interference that may cause undesired operation.

## Remarque concernant les utilisateurs au Canada

Ce dispositif est conforme à la norme CNR-Gen d'Industrie Canada.

L'utilisation de ce dispositif est autorisée seulement aux deux conditions suivantes: (1)il ne doit pas produire de brouillage et (2) l'utilisateur du dispositif doit être prêt à accepter tout brouillage radioélectrique reçu, même si ce brouillage est susceptible de compromettre le fonctionnement du dispositif.





## **Note to users in the United States of America**

### **Notice:**

This equipment has been tested and found to comply with the limits for a Class B digital device, pursuant to Part 15 of the FCC Rules. These limits are designed to provide reasonable protection against harmful interference in a residential installation.

This equipment generates, uses and can radiate radio frequency energy and, if not installed and used in accordance with the instructions, may cause harmful interference to radio communications. However, there is no guarantee that interference will not occur in a particular installation. If this equipment does cause harmful interference to radio or television reception, which can be determined by turning the equipment off and on, the user is encouraged to try to correct the interference by one or more of the following measures:

Reorient or relocate the receiving antenna.

Increase the separation between the equipment and receiver.

Connect the equipment into an outlet on a circuit different from that to which the receiver is connected.

Consult the dealer or an experienced radio/TV technician for help.

### **Caution:**

Changes or modifications not expressly approved by the party responsible for compliance could void the user's authority to operate the equipment.



### **Declaration of Conformity**

Product Name: Bluetooth Module

Model Number: MBH7BTZ52

Responsible party: Fujitsu Components America, Inc.

Address: 250 E. Caribbean Drive, Sunnyvale, CA 94089 U.S.A.

Telephone number: 408-745-4900

This device complies with part 15 of FCC Rules.

Operation is subject to the following two conditions:

1. This device may not cause harmful interference, and
2. This device must accept any interference received, including interference that may cause undesired operation.



### **Note to users in Canada**

#### **Note:**

This Class B digital apparatus complies with Canadian ICES-003.

#### **Remarque concernant les utilisateurs au Canada Avertissement:**

Cet appareil numérique de la classe B est conforme à la norme NMB-003 du Canada.





## Note to users

It is strictly forbidden to use antenna except designated.

This equipment must not be co-located or operated in conjunction with any other antenna or transmitter.

This equipment complies with FCC/IC radiation exposure limits set forth for uncontrolled equipment and meets the FCC radio frequency (RF) Exposure Guidelines in Supplement C to OET65 and RSS-102 of the IC radio frequency (RF) Exposure rules.

This equipment should be installed and operated with at least 20cm more between the radiator and person's body(excluding extremities: hands, wrists, feet and ankles).

Cet équipement est conforme aux limites d'exposition aux rayonnements énoncées pour un environnement non contrôlé et respecte les règles d'exposition aux fréquences radioélectriques (RF) CNR-102 de l'IC. Cet équipement émet une énergie RF très faible qui est considérée conforme sans évaluation de l'exposition maximale autorisée.

Cependant, cet équipement doit être installé et utilisé en gardant une distance de 20 cm ou plus entre le dispositif rayonnant et le corps (à l'exception des extrémités : mains, poignets, pieds et chevilles).



## Note to users in Canada

This device complies with RSS-Gen of IC Rules.



Operation is subject to the following two conditions;

1. This device may not cause harmful interference, and
2. This device must accept any interference received, including interference that may cause undesired operation.

## Remarque concernant les utilisateurs au Canada

Ce dispositif est conforme à la norme CNR-Gen d'Industrie Canada.

L'utilisation de ce dispositif est autorisée seulement aux deux conditions suivantes: (1)il ne doit pas produire de brouillage et (2) l'utilisateur du dispositif doit être prêt à accepter tout brouillage radioélectrique reçu, même si ce brouillage est susceptible de compromettre le fonctionnement du dispositif.





## Note to users in the United States of America

### Notice:

This equipment has been tested and found to comply with the limits for a Class B digital device, pursuant to Part 15 of the FCC Rules. These limits are designed to provide reasonable protection against harmful interference in a residential installation.

This equipment generates, uses and can radiate radio frequency energy and, if not installed and used in accordance with the instructions, may cause harmful interference to radio communications. However, there is no guarantee that interference will not occur in a particular installation. If this equipment does cause harmful interference to radio or television reception, which can be determined by turning the equipment off and on, the user is encouraged to try to correct the interference by one or more of the following measures:

Reorient or relocate the receiving antenna.

Increase the separation between the equipment and receiver.

Connect the equipment into an outlet on a circuit different from that to which the receiver is connected.

Consult the dealer or an experienced radio/TV technician for help.

### Caution:

Changes or modifications not expressly approved by the party responsible for compliance could void the user's authority to operate the equipment.



### Declaration of Conformity



Product Name: Bluetooth Module

Model Number: MBH7BTZ50

Responsible party: Fujitsu Components America, Inc.

Address: 250 E. Caribbean Drive, Sunnyvale, CA 94089 U.S.A.

Telephone number: 408-745-4900

This device complies with part 15 of FCC Rules.

Operation is subject to the following two conditions:

1. This device may not cause harmful interference, and
2. This device must accept any interference received, including interference that may cause undesired operation.



### Note to users in Canada

#### Note:

This Class B digital apparatus complies with Canadian ICES-003.

#### Remarque concernant les utilisateurs au Canada Avertissement:

Cet appareil numérique de la classe B est conforme à la norme NMB-003 du Canada.





## Note to users

It is strictly forbidden to use antenna except designated.

This equipment must not be co-located or operated in conjunction with any other antenna or transmitter.

This equipment complies with FCC/IC radiation exposure limits set forth for uncontrolled equipment and meets the FCC radio frequency (RF) Exposure Guidelines in Supplement C to OET65 and RSS-102 of the IC radio frequency (RF) Exposure rules.

This equipment should be installed and operated with at least 20cm more between the radiator and person's body(excluding extremities: hands, wrists, feet and ankles).

Cet équipement est conforme aux limites d'exposition aux rayonnements énoncées pour un environnement non contrôlé et respecte les règles d'exposition aux fréquences radioélectriques (RF) CNR-102 de l'IC. Cet équipement émet une énergie RF très faible qui est considérée conforme sans évaluation de l'exposition maximale autorisée.

Cependant, cet équipement doit être installé et utilisé en gardant une distance de 20 cm ou plus entre le dispositif rayonnant et le corps (à l'exception des extrémités : mains, poignets, pieds et chevilles).



## Note to users in Canada

This device complies with RSS-Gen of IC Rules.



Operation is subject to the following two conditions;

1. This device may not cause harmful interference, and
2. This device must accept any interference received, including interference that may cause undesired operation.

## Remarque concernant les utilisateurs au Canada

Ce dispositif est conforme à la norme CNR-Gen d'Industrie Canada.

L'utilisation de ce dispositif est autorisée seulement aux deux conditions suivantes: (1)il ne doit pas produire de brouillage et (2) l'utilisateur du dispositif doit être prêt à accepter tout brouillage radioélectrique reçu, même si ce brouillage est susceptible de compromettre le fonctionnement du dispositif.







## **Note to users in the United States of America**

### **Notice:**

This equipment has been tested and found to comply with the limits for a Class B digital device, pursuant to Part 15 of the FCC Rules. These limits are designed to provide reasonable protection against harmful interference in a residential installation.

This equipment generates, uses and can radiate radio frequency energy and, if not installed and used in accordance with the instructions, may cause harmful interference to radio communications. However, there is no guarantee that interference will not occur in a particular installation. If this equipment does cause harmful interference to radio or television reception, which can be determined by turning the equipment off and on, the user is encouraged to try to correct the interference by one or more of the following measures:

Reorient or relocate the receiving antenna.

Increase the separation between the equipment and receiver.

Connect the equipment into an outlet on a circuit different from that to which the receiver is connected.

Consult the dealer or an experienced radio/TV technician for help.

### **Caution:**

Changes or modifications not expressly approved by the party responsible for compliance could void the user's authority to operate the equipment.



### **Declaration of Conformity**

Product Name: Bluetooth Module

Model Number: MBH7BTZ53

Responsible party: Fujitsu Components America, Inc.

Address: 250 E. Caribbean Drive, Sunnyvale, CA 94089 U.S.A.

Telephone number: 408-745-4900

This device complies with part 15 of FCC Rules.

Operation is subject to the following two conditions:

1. This device may not cause harmful interference, and
2. This device must accept any interference received, including interference that may cause undesired operation.

### **Note to users in Canada**

#### **Note:**

This Class B digital apparatus complies with Canadian ICES-003.

#### **Remarque concernant les utilisateurs au Canada Avertissement:**

Cet appareil numérique de la classe B est conforme à la norme NMB-003 du Canada.





## Note to users

It is strictly forbidden to use antenna except designated.

This equipment must not be co-located or operated in conjunction with any other antenna or transmitter.

This equipment complies with FCC/IC radiation exposure limits set forth for uncontrolled equipment and meets the FCC radio frequency (RF) Exposure Guidelines in Supplement C to OET65 and RSS-102 of the IC radio frequency (RF) Exposure rules.

This equipment should be installed and operated with at least 20cm more between the radiator and person's body(excluding extremities: hands, wrists, feet and ankles).

Cet équipement est conforme aux limites d'exposition aux rayonnements énoncées pour un environnement non contrôlé et respecte les règles d'exposition aux fréquences radioélectriques (RF) CNR-102 de l'IC. Cet équipement émet une énergie RF très faible qui est considérée conforme sans évaluation de l'exposition maximale autorisée.

Cependant, cet équipement doit être installé et utilisé en gardant une distance de 20 cm ou plus entre le dispositif rayonnant et le corps (à l'exception des extrémités : mains, poignets, pieds et chevilles).



## Note to users in Canada

This device complies with RSS-Gen of IC Rules.

Operation is subject to the following two conditions;

1. This device may not cause harmful interference, and
2. This device must accept any interference received, including interference that may cause undesired operation.

## Remarque concernant les utilisateurs au Canada

Ce dispositif est conforme à la norme CNR-Gen d'Industrie Canada.

L'utilisation de ce dispositif est autorisée seulement aux deux conditions suivantes: (1)il ne doit pas produire de brouillage et (2) l'utilisateur du dispositif doit être prêt à accepter tout brouillage radioélectrique reçu, même si ce brouillage est susceptible de compromettre le fonctionnement du dispositif.

