



Mobile Printer

FTP-628WSL210 Series

User's Guide



FUJITSU COMPONENT LIMITED

Introduction

Thank you for purchasing the FTP-628WSL210 Series Mobile Printer (hereafter referred to as “this product”).

This User's Guide (hereafter referred to as “this guide”) contains precautions to use it safely and correctly.

Before using this product, please read the complete this guide. In addition, please keep this guide handy for future reference.

If you have any suggestions or comments about this guide, please do not hesitate to contact us.

Bluetooth[®] is registered trademark of Bluetooth SIG

Apple, iPod, iPhone and iPad are are trademarks of Apple Inc, registered in the U.S. and other countries.

Android is trademarks of Google Inc.

All other product names and service names are trademarks or registered trademarks of their respective companies.

All Rights Reserved, Copyright FUJITSU COMPONENT LIMITED 2012

Cautions

■ Change of content

The contents of this guide and this product are subject to change without prior notice.

■ Use in high safety applications

This product is designed, developed and manufactured for general use, such as standard industrial, general, personal and household use. This product is not designed, developed and manufactured for “high safety applications”, such as an application which requires extremely high safety, which may have a serious effect on society, expose individuals to serious danger (death, personal injury, severe physical damage or other loss), if extremely high safety is not assured (including, without limitation, nuclear reaction control in a nuclear facility, aircraft automatic flight control, air traffic control, transport control in a mass transport system, medical equipment for life support, missile launch control of a weapons system), or an application which requires extremely high reliability (including, without limitation, submarine relay, space satellite).

If you wish to use this product in an environment that requires high safety, please consult with our sales representatives.

■ Copyright

This product and this guide are copyrighted works of FUJITSU COMPONENT LIMITED.

This product and this manual must not be reproduced, duplicated, used, or modified, partially or in full, without permission.

■ Regulatory Compliance

For Customers in USA (FCC)

This device complies with Part 15 of the FCC Rules. Operation is subject to the following two conditions:

- 1) This device may not cause harmful interference, and
- 2) This device must accept any interference received, including interference that may cause undesired operation.

This equipment has been tested and found to comply with the limits for a Class B digital device, pursuant to Part 15 of the FCC Rules. These limits are designed to provide reasonable protection against harmful interference in a residential installation. This equipment generates, uses and can radiate radio frequency energy and if not installed and used in accordance with the instructions, may cause harmful interference to radio communications. However, there is no guarantee that interference will not occur in a particular installation. If this equipment does cause harmful interference to radio or television reception, which can be determined by turning the equipment off and on, the user is encouraged to try to correct the interference by one of the following measures:

- Reorient or relocate the receiving antenna.
- Increase the separation between the equipment and receiver.
- Connect the equipment into an outlet on a circuit different from that to which the receiver is connected.
- Consult the dealer or an experienced radio/TV technician for help.

To assure continued compliance, any changes or modifications not expressly approved by the party responsible for compliance could void the user's authority to operate this equipment. (Example- use only shielded interface cables when connecting to computer or peripheral devices).

For Customers in CANADA (Industry Canada)

This equipment complies with Industry Canada RSS210 rules.

Operation is subject to the following two conditions:

- 1) This device may not cause harmful interference, and
- 2) This device must accept any interference received, including interference that may cause undesired operation.

For Customers in EU (CE Marking)

This product is in conformance with the requirements of European Council Directive:

R&TTE Directive 1995/5/EC

Applied standards:

EN 60950-1

EN 300 328

EN 301 489-1

EN 301 489-17

■ **Export**

This device may contain commodities, technology or software subject to export laws and regulations from the US and other countries. Diversion contrary to the country law is prohibited.

■ **Warranty**

We shall not be responsible for any failure caused by wrong operation or usage in the wrong environment.

Moreover, we cannot be responsible for the loss, the passive damages or the claim by a third party, even if it is caused by use or failure of this product.







In addition, this product's range of failure will never exceed the amount of money paid for it.

Safety Cautions

■ Explanation of Symbols

The following symbols are used in this guide. Please read and understand the meaning of each symbol in this guide.

If this product should malfunction, immediately stop using it, and contact your sales representative.

 Danger	Indicates an imminent risk of causing severe personal injury or death if not used properly. This level is not described in this document.
 Warning	Indicates possibility of causing severe personal injury or death if not used properly.
 Caution	Indicates that a minor or some personal injury may occur or that the product itself or other user's property may be damaged.
	Indicates an action that must not be performed. Detailed description is on the side of this symbol.
	Indicates danger, warning and caution. Detailed description is on the side of this symbol.
	Indicates an action that must be performed. Detailed description is on the side of this symbol.
 Important	Indicates important points by using this product.

■ General Cautions

Warning



Break-down

- **Do not use in the environment with corrosive gas or salt wind is present.**

Failure to observe this may cause failure.



Modify

- **Do not modify or disassemble.**

Failure to observe this may cause fire, explosion or breakdown.



Fire

- **Do not burn or heat.**

Failure to observe this may cause smoke, fire or breakdown.



Fire

- **Do not pour water.**

This equipment is not waterproof. Failure to observe this may cause fire, explosion or breakdown.



Fire

- **Do not use or store the equipment in a hot environment.**

Failure to observe this may cause smoke, fire or breakdown.



Fire

- **Do not throw or drop.**

Failure to observe this may cause fire, explosion or breakdown.



Fire

- **Do not use with wet hands. Do not drip or drop liquid such as drinking water, clips or other foreign matter.**

Failure to observe this may cause fire or electric shock.



Fire

- **In the event of heat, unusual smells, smoke or excessive noise while using the product, please stop using it immediately. Unplug the power cable, remove the battery.**

Failure to observe this may cause fire.

 **Caution**



Injury

- **Do not use while driving a vehicle or walking.**

Failure to observe this may cause traffic accidents and injuries.



Break-down

- **Do not use the printer near the equipment that generates large radiation noise, such as a high voltage device and a large motor.**

Failure to observe this may cause malfunction or breakdown.



Fire

- **Do not use under direct sunlight or dusty environment that contains the oil and iron.**

Failure to observe this may cause heat, fire or failure.



Fire

- **If charging is not completed within the specified time, unplug the charger and stop charging.**

The battery may leak by overcharging.



Fire

- **Do not apply force to the cable.**

Failure to observe this may cause fire or electric shock.



Break-down

- **Keep the power line away from other devices which generate noise. (Large motor etc.)**

Failure to observe this may cause malfunction or breakdown.







Failure

- **Before using this product, be sure to read complete user's guide.**



It may cause the failure by incorrect use.

■ Printer

Warning

- | | |
|---|---|
| 
Accident | <p>- Do not use the printer in a location where radio wave generation is prohibited.
Might cause accidentally a malfunction of the instrument.</p> |
| 
Burn | <p>- During or immediately after operation, do not touch the print head, the support plate and the motor. Heat is not immediately discharged.
Failure to observe this may cause burn injury.</p> |
| 
Fire | <p>- Do not put metal objects or flammable objects into the gaps of the case.
Failure to observe this may cause fire or electric shock.</p> |
| 
Burn | <p>- Surely turn off the printer's power and confirm that the printer head is sufficiently cooled down before cleaning.
Failure to observe this may cause burn injury.</p> |

Caution

- | | |
|---|---|
| 
Injury | <p>- Never insert fingers or metal into the paper insertion and/or eject slots of the paper cutter.
Failure to observe this may cause equipment failure or injury.</p> |
| 
Injury | <p>- Be careful not to get a hand or hair caught in moving parts.
Failure to observe this may cause burn injury.</p> |

■ Battery

Warning



Break-down

- **Do not use the battery for other device or purpose.**
Failure to observe this may cause destruction.



Modify

- **Do not disassemble the battery.**
Failure to observe this may cause heat, fire or destruction.



Fire

- **Only use the specified battery.**
Failure to observe this may cause fire or electric shock.



Fire

- **Only charge the battery with the charger specified.**
Failure to observe this may cause fire or destruction.



Fire

- **Do not short-circuit the electrode of the battery.**
Failure to observe this may cause heat, fire or destruction.



Fire

- **Do not solder the terminal of battery.**
Failure to observe this may cause heat, fire or destruction.



Fire

- **Do not make impact or pressure on battery.**
Failure to observe this may cause heat, fire or destruction.

Caution



Break-down

- **Remove the battery if the printer is not expected to be used for long period.**
Failure to observe this may cause deterioration of the battery and over-discharge state.



Break-down

- **Turn off the power of the printer before removing the battery.**
Failure to observe this may cause destruction.

■ AC Adapter

Warning



Break-down

- **Do not use the AC adapter for any other devices or purposes.**

Failure to observe this may cause damage to the printer and/or battery.



Fire

- **Only connect the AC adapter to the specified voltage and/or frequency.**

Failure to observe this may cause fire or electric shock due to cable disconnection.



Fire

- **Only use the specified AC adapter.**

Failure to observe this may cause heat, fire or destruction.

Caution



Fire

- **Please connect or remove the AC adapter after the power is turned off.**

Failure to observe this may cause breakdown.



Break-down

- **If you do not use the AC adapter for a long time, please unplug the power cable.**

Failure to observe this may cause electric shock or fire due to dust and moisture.

■ Warning Label of Product

This product comes with the following warning label.
This label must not be peeled off or erased from the display.
Moreover, please contact the distributor when the label is difficult to see due to dirt, scratching etc.



Warning display	Content
HEAD ヘッド 	Do not touch the printer head and its support plate directly, because it becomes hot during printing.
GEAR & HOOK ギア・フック 	Pay attention that fingers and hair do not get caught in moving parts such as a gear or hook.
CAUTION 注意 	Please do not touch the cutter blade when you exchange the paper roll because it may cause an injury.

Table of Contents

1	Types of Product	13
2	Preparation to Print	14
2.1	Packaging	14
2.2	Optional Accessories.....	15
2.3	Getting to Know the Printer	16
2.4	Inserting the Battery	19
2.5	Connecting AC Adapter (Charging).....	20
2.6	Connecting AC Adapter (Operating).....	21
2.7	Inserting the Paper	22
2.8	Attaching the Belt Clip	23
3	Operating Procedures	24
3.1	Power On.....	24
3.2	Test Print	25
3.3	USB Communication.....	27
3.4	<i>Bluetooth</i> Communication	28
3.5	Printer Error	29
4	Indicator Lights.....	31
4.1	Normal Operation	31
4.2	Printer Error	32
4.3	Charging.....	33
4.4	Maintenance Mode	33
5	Maintenance.....	34
5.1	Thermal Head.....	34
5.2	Platen Roller.....	35
5.3	Paper Sensor	35
5.4	Paper Cover	36
5.5	POWER/FEED Switch	37
6	Troubleshooting	38
7	Specifications	42
7.1	Printer Specifications	42
7.2	Paper Specifications	43
8	Recycle	44
9	Appendix	45
9.1	<i>Bluetooth</i> Communication	45
10	Product Support	47

1 Types of Product

The following product types are available.

Please note that the printer may not support the function of the printer model, even if there is a description in this guide.

MODEL NAME

FTP-628WSL210#20-R

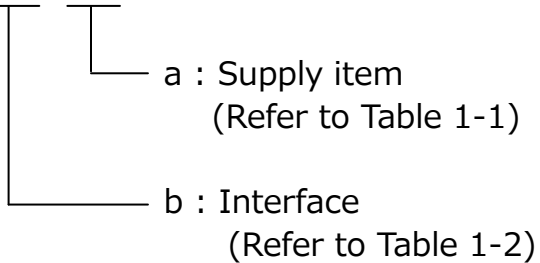

Table 1-1. Supply items

Content	Printer	Battery	AC Adapter
a			
20	Available	Available	Available

Table 1-2. Interface

Content	<i>Bluetooth</i>	<i>Bluetooth</i> (iOS supported)	USB
b			
10	Available	Available	Available
11	Available	Not available	Available
12	Not available	Not available	Available

2 Preparation to Print

2.1 Packaging

The following items are included.

If anything is missing, please contact the distributor.

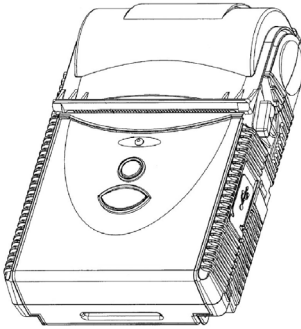

Printer

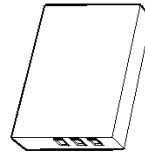

Battery

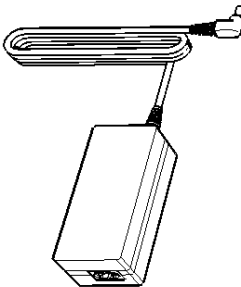

AC adapter



Safety Cautions

2.2 Optional Accessories

The following optional parts are available. Purchasing information for these accessories can be obtained from the place where you bought this printer.

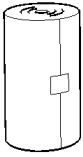

Paper

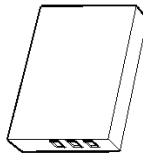

Battery

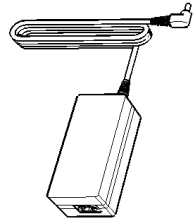

AC adapter



AC cable
(PSE or UL/CSA)



USB cable



Belt Clip

2.3 Getting to Know the Printer

■ Front Side (Cover Closed)

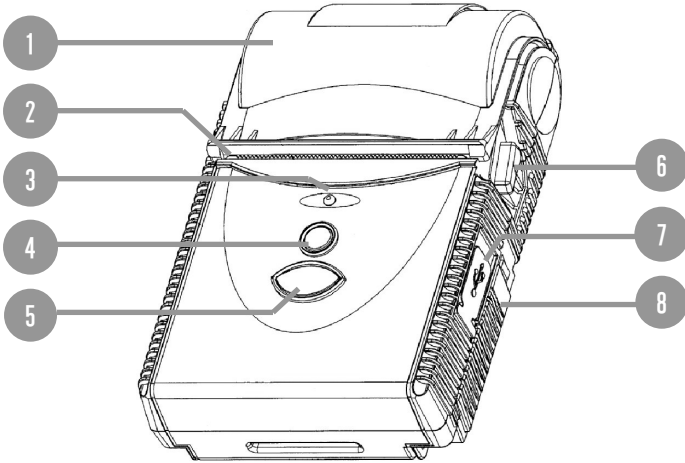

- | | | |
|---|-------------------------|---|
| 1 | Paper Cover | : Cover to open and load paper. |
| 2 | Paper Cutter | : To cut paper. |
| 3 | Status LED | : Displays status of the printer. |
| 4 | POWER Switch | : To turn the power supply ON or OFF. |
| 5 | FEED Switch | : To feed paper. |
| 6 | Cover Open Lever | : To open the cover. |
| 7 | USB Connector | : To connect to PC etc. |
| 8 | Battery Cover | : Cover to open and insert the battery. |

■ Front Side (Cover Open)

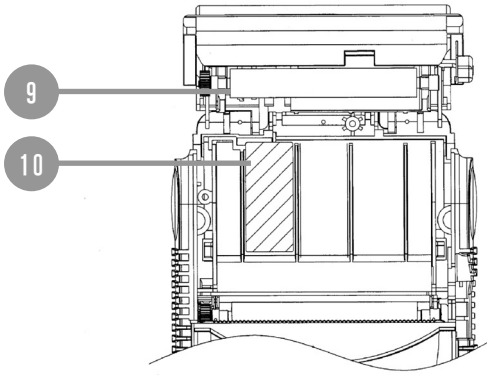

- 9 **Platen Roller** : To feed paper.
- 10 **Warning Label** : This shows warning when using printer.



- 11 **Thermal Head** : This applies heat to paper.
- 12 **Paper Sensor** : This sensor detects the status of paper.

■ Rear Side

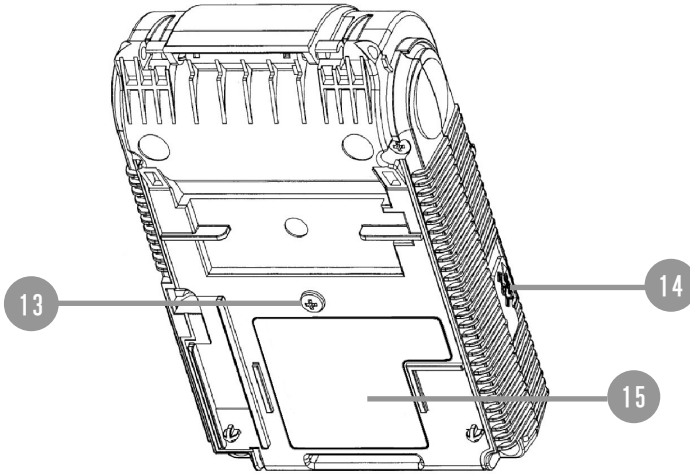

- 13 Screw for Belt Clip** : This attaches the Belt Clip.
- 14 AC Adapter Jack** : Open and connect AC adapter.
- 15 Product Label** : Displays printer type and other product information.

2.4 Inserting the Battery



Caution

Life of the battery is about 500 charges. (At the normal temperature)
If an old battery is used, not only the equipment malfunctions
and this might cause destruction.

1. Please push cover lock and lift the battery cover to open.

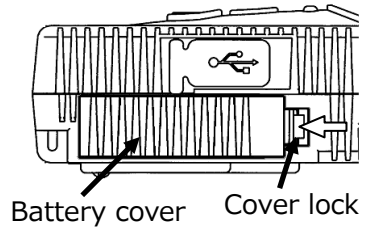

2. Please place the label surface of battery downward, insert the battery from its terminal side.

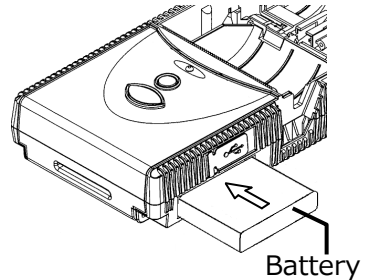

3. Please hook battery cover on the battery insertion area and push the battery cover to close.

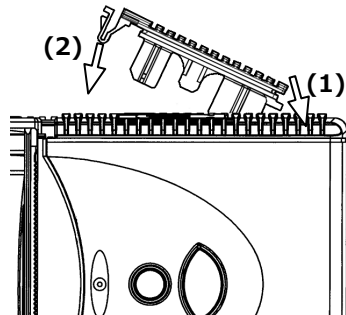

2.5 Connecting AC Adapter (Charging)

The battery is charged by the printer's built-in charger.



Caution

Please stop charging immediately if an abnormal charge is generated.

1. Please connect the AC cable with the AC adapter, and connect the AC plug to an outlet.

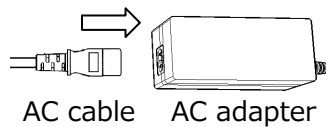

2. Please hook up the jack cover to open.
Insert DC output terminal of AC adapter into the AC adapter jack.

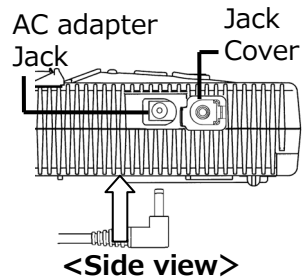

3. When the charge starts, the LED turns red, and when the battery is fully charged, the LED turns off. Please refer to chapter 4.3 for the LED display of charging status.
4. Please hang the hook of the jack cover to the hole of AC jack, and push center of the jack cover to close.

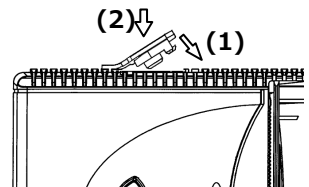

Important

When the printer power supply is turned on, it is not able to charge.

2.6 Connecting AC Adapter (Operating)

This product can also be operated with the AC adapter.

1. Please connect the AC cable with the AC adapter, and connect the AC plug with the outlet.

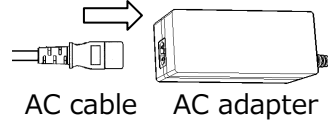

2. Please open the Jack Cover, and connect the DC output terminal of the AC adapter to the AC adapter Jack.

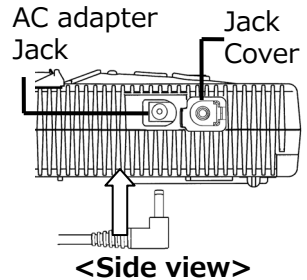

3. Please turn on the power supply of the printer. Please refer to chapter 3.1 for how to turn on the power supply.



Important

- The battery must be inserted in the printer though it operates with only the AC adapter.
- When the power supply is turned OFF, it is possible to charge it.
- When the power supply is turned ON, it is not possible to charge it.

2.7 Inserting the Paper

1. Please push up the cover open lever to open the paper cover.

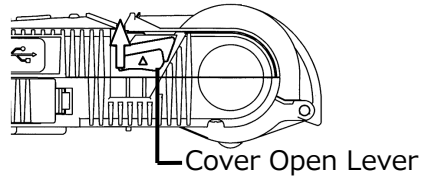

2. Please insert the paper in the printer.

Thermal Paper
(Thermosensitive Side)

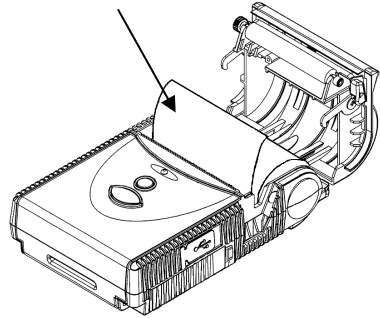

3. Please put out the edge of the paper and close the paper cover. Push center of the paper cover firmly when closing.

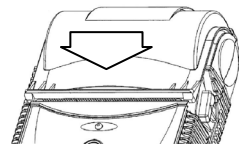
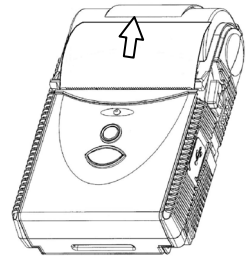

2.8 Attaching the Belt Clip

The printer can be attached to the waist belt with a Belt Clip.

Below are recommendations how to attach the Belt Clip:

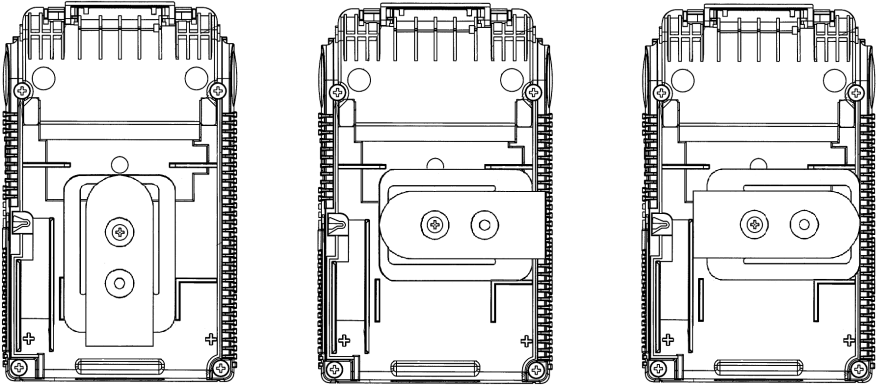

How to attach it

1. Please remove the screw for the Belt Clip on the back of the printer.
2. Please tighten the screw of the Belt Clip after setting it in the desired direction.



Important

- If the Belt Clip is misaligned, it cannot be installed correctly.
- There are two tapped holes in the Belt Clip. The hole which is used depends on the desired direction clip.

3 Operating Procedures

3.1 Power On

1. Please push the POWER Switch until the LED light turns green.
2. It is possible to turn the power off by pushing the POWER Switch until the LED turns off.

3.2 Test Print

This product has a test print function.

The setting of the printer can be confirmed by this test print.

1. Please turn the power off and push the FEED switch.
2. Please turn the power on while holding with the FEED switch down.
Then, the test print starts.
3. When the test print ends, the printer automatically turns off the power supply.
4. Please turn the power off when you want to stop the test print.
5. Please refer to the next page for a detailed description of the test print. (The content of the test print is different for each model)



Important

The test print fails if a printer error such as "Paper End" or "Paper Cover Open" etc. occurs.

Please retry after resolving the error.

Check pattern
The thermal head open circuit etc. can be confirmed.

Version
The firmware version can be confirmed.

Setting information etc
The setting information etc can be confirmed. This print example shows the following content.

- Printer serial number
- Printer ID
- Firmware sum value
- Auto power off transition duration
- Auto power down transition duration

Voltage and Temperature
The power voltage and temperature of thermal head can be confirmed.

Interface
Available interface and protocol can be confirmed.

Bluetooth information
The *Bluetooth* information can be confirmed.

Installing font
Installing font can be confirmed.

628AD Ver 1.00

Serial No : 22000001
Printer ID : 01
PrinterSUM : 00000001
Power OFF : 30 min
Power Down : 1.0 sec

HD VOLT: 5.0 V HD TEMP: 25 ° C

INTERFACE : Bluetooth/USB
HAND SHAKE : Non process

BT FIRM: 0000D1000000000437
BD ADDR: 00 11 22 33 44 55
BT NAME: 628WSL210_000001
BT LINK: 0 sec

! "#\$%&'()*+,-./0123456789:;<=>?
@ABCDEFGHIJKLMNopqrstuvwxyz[^\`~
'_abcdefghijklmnopqrstuvwxyz{|}~

! "#\$%&'()*+,-./0123456789:;<=>?@ABCDEFGHIJKLMNO
PQRSTUVWXYZ[^\`~_abcdefghijklmnopqrstuvwxyz{|}~

丑啞娃阿哀愛挨始逢葵茜穉惡握渥旭
葦芦鏻梓庄幹扱宛姐虻飴絢綾點或粟
裕安庵按暗案闇鞍杏以伊位依偉困夷
委威尉惟意慰易椅為畏異移維緯胃葵
衣謂違遺医井亥域育郁機一舌溢逸福
茨芋鱗允印咽員因姻引飲淫胤蔭院陰
隱頤吋右宇烏羽迂兩卯鶻窺丑雅臼渦
噓唄鬱蔚蔚鱧姥厥浦瓜閏噶云運雲在餌
觀營嬰影映曳榮永泳洩瑛盈穎穎英衛
詠銳液液益駝悅謁越閱穫厭圃園堰奄
宴延筵掩援沿演炎焔煙燕猿綠艷苑菌
遠鉛鴛盪於汚甥凹央奧往忪押旺橫歐
毆王翁襖鶯鷗黃岡冲荻億屋憶臆桶牡
乙俺卸恩温穩音下化假何伽媿佳加可
嘉夏嫁寡寡科暇果架歌河火珂禍禾稼

3.3 USB Communication

Explanation of how to communicate and print with a USB cable from a terminal such as a personal computer:

1. Please use the USB cable. The plug on the printer side (device side) is the mini B type.
2. Please open the USB connector cover and insert the USB connector.
3. Please connect the plug of host with the host terminal connector.
4. Please start the application in the host terminal (The communication port is opened).

Then, the Status LED display shows the USB connection.



Important

When other interfaces are used, it is not possible to connect it.

3.4 *Bluetooth* Communication

Explanation of how to communicate and print with a *Bluetooth* device from a terminal such as a personal computer:

1. Please turn the printer on.
2. Please find the *Bluetooth* device in the host terminal.
3. The device name of the connected printer is displayed.
Then, please select the device and connect it.
4. Please input "9999" when the PIN code is requested.
(This status is standard and set by the factory)
5. The LED display shows the status of the *Bluetooth* connection.



Important

- There is a product that does not support this communication. Please refer to the C.1 for the supporting product.
- Please refer to chapter 9.2 for the connection with a general tablet PC.
- When other interfaces are used, it is not possible to connect it.

3.5 Printer Error

The error occurs when the printer cannot print/work normally. The type of error is shown by the LED when the error is occurring.

Please reset the status when the error occurs.

The following example explains reasons and solutions for problems.

Error	Cause	Solution
Paper End	<ul style="list-style-type: none"> - There is no paper in the paper cover. - It is not correctly set though there is paper - Particles have collected on the paper sensor. 	<ul style="list-style-type: none"> - Please correctly set the paper, refer to chapter 2.7. - Please clean the paper sensor, refer to chapter 5.3.
Paper Cover Open	<ul style="list-style-type: none"> - The paper cover is open. 	<ul style="list-style-type: none"> - Please correctly close the paper cover, refer to chapter 2.7.
Thermal Head Temperature Error	<ul style="list-style-type: none"> - The thermal head is too hot. 	<ul style="list-style-type: none"> - Please do not print for a while. Once the thermal head cools down, the error disappears.



Important

- It is normal that the temperature goes up because this printer prints by heating the thermal head.
- The Thermal Head Temperature Error is generated easily by the high ambient temperature.

Error	Cause	Solution
Supply Voltage Error	<ul style="list-style-type: none"> - The battery charge is low. - The AC adapter is out of order. (At the AC adapter operation) 	<ul style="list-style-type: none"> - Please charge the battery. - Please exchange the AC adapter.
Mark Undetection	<ul style="list-style-type: none"> - The mark of paper is not correctly printed. - Particles have collected on the paper sensor. 	<ul style="list-style-type: none"> - Please use the paper on which the mark is correctly printed. - Please clean the paper sensor, refer to chapter 5.3.
Hardware Error MCU Operation Error RAM Error <i>Bluetooth Error</i>	<ul style="list-style-type: none"> - The printer is broken. 	<ul style="list-style-type: none"> - Please send this printer in for repair.
Charge Error	<ul style="list-style-type: none"> • The battery is broken. • The AC adapter used for the charge is broken. • The printer control board is broken. 	<ul style="list-style-type: none"> - Please exchange the battery. - Please exchange the AC adapter. - Please send this printer in for repair.



Important

The battery may need to be replaced when it has been fully recharged and the Supply Voltage Error or Low Battery sign appear.

Please stop using this battery, and exchange it for a new battery.

4 Indicator Lights

The LED displays printer error and the low battery status.



Important

It may be difficult to see the LED display in a bright place such as in direct sunshine etc.



4.1 Normal Operation

Printer Status	LED Indications (LED Symbol ○:Lighting, ●:Blinking)			Blink Cycle (Unit [msec])
	Green	Orange	Red	
Standby	● 1time			ON 125 OFF 1000 125
USB Connecting	● 2times			ON 125 125 OFF 250 1000
Bluetooth Connecting	● 3times			ON 125 125 125 OFF 250 250 1000
Power Off	○			ON 1000 OFF Power off
Low Battery	●		●	ON 500 500 500 500 OFF Green Red Green Red

4.2 Printer Error

Printer Status	LED Indications (LED Symbol ○:Lighting, ●:Blinking)			Blink Cycle (Unit [msec])
	Green	Orange	Red	
Paper End		● 1time		ON 125 OFF 1000
Paper Cover Open		● 2times		ON 125 125 OFF 250 1000
Thermal Head Temperature Error		● 3times		ON 125 125 125 OFF 250 250 1000
Supply Voltage Error		● 4times		ON 125 125 Blink 125 OFF 250 4 times 1000
Hardware Error		● 5times		ON 125 125 Blink 125 OFF 250 5 times 1000
Mark Undetection		● 6times		ON 125 125 Blink 125 OFF 250 6 times 1000
MCU Operation Error / RAM Error		● 7times		ON 125 125 Blink 125 OFF 250 7 times 1000
Bluetooth Error		● 8times		ON 125 125 Blink 125 OFF 250 8 times 1000

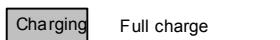
4.3 Charging

Printer Status	LED Indications (LED Symbol ○:Lighting, ●:Blinking)			Blink Cycle (Unit [msec])
	Green	Orange	Red	
Charging			○	ON  OFF
Full Charge				ON  OFF
Charge Error (Over charge, Over discharge, Over time)			●	ON  OFF

4.4 Maintenance Mode

Printer Status	LED Indications (LED Symbol ○:Lighting, ●:Blinking)			Blink Cycle (Unit [msec])
	Green	Orange	Red	
Printer Firmware Downloading		●	●	ON 125 1000 OFF  OFF

5 Maintenance

Please service this printer regularly.



Caution

- Do not service the printer while the battery is inserted or the AC adapter connected.
- Do not completely service, disassemble and repair any parts that are not explained in this chapter.

5.1 Thermal Head

Please service the thermal head once a month.

1. Please open the paper cover. (Refer to chapter 2.7)
2. Soak a cotton ball with some alcohol and wipe the thermal head gently until it is clean. Please use isopropyl alcohol.
3. With a soft cloth completely wipe off the thermal head and only close the paper cover when it is completely dry.

5.2 Platen Roller

Please service the platen roller once a month.

1. Please open the paper cover. (Refer to chapter 2.7)
2. Soak a cotton ball with some alcohol and wipe the platen roller gently until it is clean. Please use isopropyl alcohol.
3. With a soft cloth completely wipe off the platen roller and only close the cover when it is completely dry.

5.3 Paper Sensor

Please service the paper sensor once a month.

1. Please open the paper cover. (Refer to chapter 2.7)
2. Please remove the dust particles with a soft nylon brush etc.



Important

The paper sensor is an optical sensor. This lens might scratch if too much pressure is applied to it when cleaning. As a result the printer might not detect the paper correctly.

5.4 Paper Cover

If the paper cover comes off, please repair it according to the following instructions.

1. Please push the opening and closing fulcrum of the paper cover to the printer with the paper cover opened, and it connects the printer.

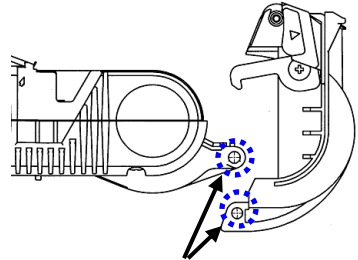

Opening and closing fulcrum
of paper cover

2. Please confirm the correct connection by opening and closing the paper cover 2-3 times.

5.5 POWER/FEED Switch

If the Power switch or the FEED switch falls off, please repair according to the following instructions.

1. Please push the power switch back into its round hole.
Please push the FEED switch back into its oval hole.

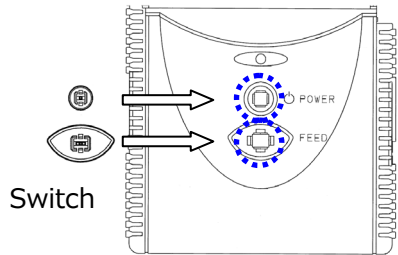

<Front view>

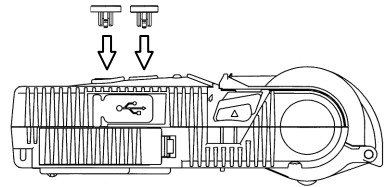

<Side view>

2. Please confirm that the repaired switch works correctly.

6 Troubleshooting

■ Power

Problem	Cause	Solution
Printer does not turn on	Is a battery inserted? or Is it inserted reversed?	Please insert the battery correctly. (C. 2.4)
	Is the battery fully charged?	Please charge the battery. (C. 2.5)
	Is the POWER Switch correctly pushed?	Please push the POWER Switch correctly. (C. 3.1)
	Is the battery old?	Please exchange it for a new battery.
Battery does not charge or Charging error occurs	Is a battery inserted? or Is it inserted reversed?	Please insert the battery correctly. (C. 2.4)
	Is the battery old?	Please exchange it for a new battery.
	Is the AC adapter correctly connected?	Please connect the AC adapter correctly. (C. 2.5)
	Has the battery already been fully charged?	The charge is unnecessary.
	Is the power not turned on? It is not possible to charge, when the power is turned on.	Please turn off the power. (C. 3.1)
	Is the printer used at an incorrect operating temperature?	Please charge it at a correct operating temperature. (C. 7.1)
Power supply cuts suddenly	Is the auto power off set? Please confirm the setting via test print. (C. 3.2)	It is normal operation by the auto power off function.
	Is the battery charge low?	Please charge the battery. (C. 2.5)
	Does an error occur? (C. 4.2)	Please troubleshoot the error. (C. 3.5)
Battery charge does not hold	Is the battery old?	Please exchange it for a new battery.

■ Communication

Problem	Cause	Solution
Printer does not communicate	Is the power turned off?	Please turn on the power. (C. 3.1)
	Is the application or the driver for this product used?	Please use the application or the driver for this product.
Printer does not communicate (with USB)	Is USB cable correctly connected?	Please connect the cable correctly. (C. 3.3)
	Is the USB cable broken?	Please use the cable without the breakdown.
	Is the <i>Bluetooth</i> connected?	Please use the USB cable after disconnecting the <i>Bluetooth</i> .
	Is USB COM driver correctly installed?	Please install the COM driver correctly.
Printer does not communicate (with <i>Bluetooth</i>)	Is the link correctly connected?	Please connect the link correctly. (C. 3.4)
	Is the USB cable connected?	Please connect <i>Bluetooth</i> after disconnecting the USB cable.
	Does the transmitter correspond with the SPP profile?	Please use the transmitter that corresponds with the SPP profile.
	Is equipment too close that it causes radio interference?	Please stop the device that causes the radio interference or keep the transmitter and the printer away from the device.
	Is there a shield between the transmitter and the printer that interferes with the radio?	Please use it in a place without the shield.

■ Print

Problem	Cause	Solution
Printer does not feed the paper or Paper jam occurs	Is the power turned off?	Please turn on the power. (C. 3.1)
	Is the paper correctly inserted?	Please insert the paper correctly. (C. 2.7)
	Is the paper cover closed?	Please close the paper cover firmly. (C. 2.7)
	Does a printer error occur? (C. 4.2)	Please correct the printer error. (C. 3.5)
	Is the platen roller dirty?	Please clean the platen roller. (C. 5.2)
Printer does not print	Is the power turned off?	Please turn on the power. (C. 3.1)
	Is the paper correctly inserted?	Please insert the paper correctly. (C. 2.7)
	Is the paper cover closed?	Please close the paper cover firmly. (C. 2.7)
	Does a printer error occur? (C. 4.2)	Please correct the printer error. (C. 3.5)
	Is the platen roller dirty?	Please clean the platen roller. (C. 5.1)
Print is too light or Print is smudging	Is the paper correctly inserted?	Please insert the paper correctly. (C. 3.1)
	Is the paper cover closed?	Please close the paper cover firmly. (C. 2.7)
	Is the platen roller dirty?	Please clean the platen roller. (C. 5.1)
	Is the correct paper used?	Please use the correct paper. (C. 7.2)
	Is the battery old?	Please exchange it for a new battery.

■ Others

Problem	Cause	Solution
Print starting location is incorrect	Does the mark detection operate correctly? (C. 4.2)	Please remove the reason for the mark detection error. (C. 3.5)
Printing is slow	Is the battery charge low?	Please charge the battery. (C. 2.5)
	Is the battery old?	Please exchange it for a new battery.
	Is too much black printed?	It is not a breakdown though the print slows when there is too much black printed.
	Isn't the ambient temperature low?	It is not a breakdown though the print slows when the ambient temperature is low.
Paper cover does not open or close	Does the paper cover come off?	Please set the paper cover.



Important

- Please contact technical support when problems cannot be solved by these suggestions.
- In parentheses (C. **) in the table indicates the corresponding chapter number.

7 Specifications

7.1 Printer Specifications

Items	Contents
Print Method	Thermal Line-dot Printing
Resolution	8dot/mm (203dpi)
Dimensions	84×136.5×43.6mm
Weight	About 220g Including battery, excluding paper
Max Print Width	About 48mm
Print Speed	Max 40mm/sec Battery full charge, print ratio 12.5%
Character	Alphanumeric, Katakana : 8x16, 16x16, 12x24, 24x24 Kanji : 16x16, 24x24
Barcode	UPC-A, UPC-E, JAN13(EAN13), JAN8(EAN8), CODE39, ITF, CODABAR, CODE128, GS1 DataBar, QR code, MAXI code, PDF417
Interface	USB, <i>Bluetooth</i> (Depends on model)
Conformity Standards	TELEC, VCCI, FCC, IC, CE marking
Operating Temperature	0 to 50 deg C 5 to 40 deg C (Print Quality assurance) 0 to 40 deg C (with AC adapter)
Operating Humidity	30 to 85%RH (no dew condensation)
Storage Temperature	-20 to 60 deg C
Storage Humidity	5 to 90%RH (no dew condensation)

7.2 Paper Specifications

Items	Contents		
Type	Thermal Roll Paper		
Width	58 ⁺⁰ ₋₁ mm		
Outer Diameter	Up to φ36mm		
Inner Diameter	φ 8mm or more		
Thickness	60 to 80μm		
Specified Paper	Type	Name	Manufacture
	High Sensitive	TF50KS-E4	Nippon Paper Group
	Standard Paper	TF60KS-E	Nippon Paper Group
		PD150R	Oji Paper Group
	Medium Term Storage	TP60KS-F1	Nippon Paper Group
		PD170R	Oji Paper Group
		P220VBB-1	Mitsubishi Paper Mills Limited
Long Term Storage	HA220AA	Mitsubishi Paper Mills Limited	



Important

Thermal paper will discolor due to chemical reaction.

When handling it, pay attention to the following points:

- Do not store it in a high-temperature, high-humidity place.
- Do not store for long periods of time in places exposed to direct sun-light.
- Do not use solvent type glue for pasting.
- Do not let it touch plastic film containing plasticizer for a long time.
- Do not stick it together with diazotized copying paper.
- Do not wet and scratch paper.

8 Recycle



This symbol means:

Do not dispose of this product together with your household waste!

 Please refer to your local community or contact our dealers to properly handle the end-of-life of electric and electronic equipment. Recycling this product will help to conserve natural resources and prevent potential negative impact on the environment and human health caused by inappropriate handling.

9 Appendix

9.1 *Bluetooth* Communication

(1) Android Terminal

1. Please turn on the power of printer.
2. Please open "Settings" - " WIRELESS & NETWORKS" from the menu of terminal, and turn on *Bluetooth*.
3. Please open the "*Bluetooth*", and tap "FTP-628WSL...".
(Please tap "SEARCH FOR DEVICES", if it does not appear)
- 4 Please input the PIN code, and tap "OK".
PIN code is "9999" and it is set by the factory.
(The PIN only needs to be entered once)
5. When the connection with the printer is successful, it is displayed in "FTP-628WS..." in "PAIRED DEVICES".
6. Please connect and print by using the application.

(2) iOS Terminal

1. Please turn on the power of printer.
2. Please open "Settings" - "General" - "*Bluetooth*" from the menu of terminal, and turn on *Bluetooth*.
3. Please tap "FTP-628WS···" from "Devices".
4. Please input the PIN code, and tap "Pair".
PIN code is "9999" in the state of the factory shipment.
(The PIN code input is unnecessary at the connection of second and subsequent)
5. When the connection with the printer succeeds, "Connected" is displayed to "FTP-628WS···".
6. Please connect and print by using the application.

10 Product Support

If you have questions about the product, please inquire with the distributor or the following.

Moreover, when you request repair, please provide the model name and the product serial number in addition to information on the actual failure etc.

Technical Support Section

FUJITSU COMPONENT LIMITED (Japan)

Global Marketing Dept.2

Tel: +81-3-5449-7014 Fax: +81-3-5449-2628

E-mail: promothq@fcl.fujitsu.com

MEMO

Mobile Printer FTP-628WSL210 Series
User's Guide

L0NA02265-L11802RS

Published by FUJITSU COMPONENT LIMITED
Oct. 2012 Rev. 1

FUJITSU