

Portable Thermal Printer

FTP-628WSL

User's Manual



FUJITSU COMPONENT LIMITED

< < Preface > >

Thank you for purchasing Fujitsu Thermal Printer FTP-628WSL.

This product is a small-sized, lightweight, high-speed printer driven by battery (one Lithium-ion battery) and has IrDA (infrared) and RS-232C Bluetooth (radio transmission) communication functions.

Before using, you are suggested to read this User's Manual carefully and handle the product properly so that its functions may be utilized to the fullest extent.

If you have any suggestions or comments on this Manual, please do not hesitate to let us know.

*The contents of this User's Manual may be subject to change without notice.

No part of this Manual may be reproduced, transferred to other use or reprinted, without prior written permission from the Company.

02	2004.06
----	---------

Contents

< < Preface > >	1
Notes on Safety	3
Precautions in the Handling of AC Adapter	6
Prohibitions/Precautions on Battery Handling	7
1. Precautions in the Use	8
2. Printer Interface Configuration	9
3. Name of Respective Parts	10
4. Operation of Respective Parts	12
5. Mounting of Paper Roll	22
6. Selecting Power Source of AC Adapter and Battery	25
7. Operating Switches	25
8. Status Indication Function by LED	26
9. Interface Connector Connection (RS-232C Connecting Part)	28
10. Interface Setting (Dip Switch Operating Part)	28
11. Function Specification	29
< 1 > List of Commands	29
< 2 > Test Printing	31
12. Hardware Specification	32
13. Recording Paper (Recommended Paper)	33
14. Others	33

Notes on Safety

Before using this product, carefully read and understand the contents of this Manual. Be sure to keep this Manual at a handy spot for easy reference during the use of this product.

Do not change or repair this product yourself to avoid any unexpected failures.

Products listed in this Manual are not authorized for use as critical component in applications requiring extremely high reliability such as medical devices for life support, submarine repeaters, aerospace uses, or atomic power control. For uses in such applications, please contact the sales representatives of our Company beforehand.

Indication of Warning Label

With the view to protecting the users and other persons from the risk of injuries and avoiding damage of properties, the matters that should be strictly observed are indicated in the following manner:



“Danger” indicates an imminent risk of causing severe personal injury or death if not used properly.









“Warning” indicates possibility of causing severe personal injury or death if not used properly.



“Caution” indicates that a minor or some personal injury may occur or that the product itself or other user’s property may be damaged.

Warning Label

Never erase or peel off the warning label. If the message on the label is unreadable due to stain or otherwise, please contact the sales representatives of the Company.

Warning display	Content of warning
HEAD  	Since the print head and its support plate get a high temperature during printing, do not touch them directly.
GEAR, HOOK  	Pay attention to fingers and hairs not to be caught in the moving part such as a gear or hook because it may cause an injury.
CAUTION  	Please do not touch the cutter blade when you exchange the roll paper because it may cause an injury by the contact of the blade.









<Precautions>

- The Company shall not be held responsible for any trouble caused as a consequence of using separately sold items or consumables other than those designated in this Manual.
- Never attempt to disassemble or repair any portion other than those indicated in this Manual.
- The Company shall not be held responsible for any injury caused as a consequence of improper handling or inappropriate use environment on the part of the user.
- Data etc. may not be recorded or stored for a long period of time or eternally. The Company shall not be held responsible for any damage or lost profit caused by the loss of data due to malfunction, repair, inspection, etc.
- Please get in touch with us, if there is anything unclear with respect to the contents of this Manual.









Warnings

Warning level	Type of danger	Warning message
Caution	Injury	<p>Pay attention so that your fingers, hairs, etc. may not be withdrawn into the moving parts such as gear, belt, etc. to avoid a risk of injury.</p> <p>When replacing the paper, be careful not to jam your fingers with the paper cover or not to touch the paper cutter. There is a risk of personal injury due clipping or contact with the cutter blade.</p>
	Burn	<p>Surely turn off the printer power and check that the printer head is sufficiently cooled down before cleaning: Hot printer head may cause a burn.</p> <p>The printer generates heat when in operation. Accordingly, pay special consideration to the radiation of heat in the mounting design because it may cause a burn.</p> <p>Since the motor gets a high temperature during its operation, do not touch it directly. Since heat is not radiated immediately after the motor is stopped, touching it at this stage may cause a burn.</p> <p>Since the printer head and its support plate get a high temperature during printing, do not touch them directly. Since heat is not radiated immediately after the printer is stopped, touching it at this stage may cause a burn.</p>
	Fire	<p>Do not use a voltage other than the specified voltage of power supply to avoid the risk of fire or electric shock.</p> <p>Do not put a metal or flammable substance in the inside of the aperture (for insertion or ejection of paper) to avoid fire or electric shock.</p> <p>Do not place the product at a highly humid or dusty place, poorly ventilated place, fire-hazardous place, or a place where temperature becomes excessively high. There is a risk of fire or electric shock.</p> <p>Do not use the product with wet hand. Avoid spill of liquid such as drinks, dropping of foreign substance such as clips to avoid the risk of fire or electric shock.</p>
	Electric shock	<p>Surely turn off the printer power before replacing the paper, changing battery and connecting or removing AC adapter. This is to avoid the risk of electric shock.</p>
		<p>If by any chance the product drops, or it emits heat, smoke, unusual smell, or abnormal sound, immediately turn off the power of the product, and then contact your sales agent (or the maintenance service center).</p>

Precautions on the Handling of AC Adapter

 Warning	<p>Do not remove, disassemble, repair or remodel the cover. Such action may cause electric shock.</p>
 Warning	<p>Use inlet power within specified range of voltage and frequency and outlet power within the specified range of voltage and current. Otherwise, it may cause a fire or electric shock.</p>
 Caution	<p>Do not use at an ambient temperature exceeding the specified one. It may cause a fire or electric shock.</p>
 Caution	<p>Protect against dew formation because of water or moisture. It may cause a fire or electric shock.</p>
 Caution	<p>Do not use at places exposed to excessive humidity, oily smoke or dust or in the environment with corrosive gases. It may cause a fire or electric shock.</p>
 Warning	<p>If you notice power failure or other abnormalities during the use, stop the use immediately. In the case of AC adapter, unplug the power cord. A fire or electric shock may be caused. Do not fail to contact our sales representatives.</p>
 Caution	<p>Do not cover or wrap AC adapter and battery charger with cloth, quilting etc. It may accumulate the heat, deform the casing and cause a fire.</p>
 Warning	<p>Do not connect or disconnect the power plug with wet hand. It may cause a fire or electric shock.</p>
 Warning	<p>Do not bend, pull or damage forcibly the power cord and AC plug cord. It may cause a fire or electric shock.</p>

Prohibitions/Precautions on Battery Handling

 <p>Danger</p>	<p>Disassembly of battery pack and battery Never disassemble the battery pack and battery. Disassembling the battery pack may destroy internal circuits leading to inoperable safety system for charging and discharging that generates heat, fire, or destruction. Also, disassembling the battery may generate gasses that bite the throat or cause the negative electrode to generate heat leading to fire</p>
 <p>Danger</p>	<p>Externally shorting battery pack and battery Never short the battery pack and battery. External shorting may generate heat or fire or cause destruction.</p>
 <p>Danger</p>	<p>Throwing battery pack and battery into fire Throwing the battery pack and battery may cause fire or destruction.</p>
 <p>Warning</p>	<p>Throwing battery pack and battery into water Throwing the battery pack into water may destroy internal circuits leading to inoperable safety system for charging and discharging that generates heat, fire, or destruction. Also, the battery generates oxygen and hydrogen by electrolysis, and concurrently the sealing portion may be corroded causing leaked liquid.</p>
 <p>Danger</p>	<p>Soldering and heating up battery pack and battery Do not solder a battery pack terminal. Soldering may cause melted case by generated heat or destruction of internal circuits, leading to inoperable safety system that generates heat, fire, or destruction. Heating the battery up to 100°C or higher may damage resin parts such as gaskets or the separator leading to leaked liquid, or internal shorts may lead to generated heat, fire, or destruction.</p>
 <p>Danger</p>	<p>Charging outside this device(outside dedicated adapter) Charge by a current larger than specified, overcharge, or reverse charge may occur. In this case, the inside of the battery may generate gasses rapidly causing fire or explosion. Charging outside this device may cause heat, fire, or destruction</p>
 <p>Danger</p>	<p>Use for another purpose Do not use the battery pack and battery for another device or purpose. A difference of the specifications may damage the battery or the device.</p>
 <p>Caution</p>	<p>Deformation If the applied pressure has deformed the battery pack and battery, the sealing position may deform leading to leaked liquid, or internal shorts may cause heat, fire, or destruction.</p>

1. Precautions in the Use

- (1) Use the printer keeping it horizontally or vertically as practically as possible.
- (2) Avoid the use of Product at a place exposed to direct sunlight; in high temperature, low temperature or highly humid atmosphere; or in the environment with much garbage and dust.
- (3) Separate the AC line from other noise emitting equipment (large size motor, etc.)
- (4) Use the Printer after checking that the recording paper is sufficiently installed.
- (5) Be careful to avoid the sticking or entering of foreign substances around the printing head.
- (6) Turn off the power before connecting the interface cable of the printer, replacing of battery, connecting and removal of the AC adaptor, etc.
- (7) Never attempt to disassemble the Printer as it may cause malfunctions.
- (8) Our AC adaptor and battery are for exclusive use for this Printer. Avoid the use of them for other products.
- (9) For carrying this Printer, use belt fixtures and straps exclusively made for this Printer.
- (10) When exchanging the roll paper, be careful not to be clipped your hand at opening and closing of paper cover or not to touch the paper cutter.
- (11) Do not peep into through IrDA communication window, especially while communication is being made.
- (12) When not using for long period
 - When you do not expect to use for a long period of time, keep the recording paper inserted. If the printing head is kept in direct touch with platen for a long time, platen may stick to the head.
- (13) Recording paper
 - Use paper roll with thermo-sensitive coating on the outside surface and set it so that the thermal side touches the printing head.
 - Set the paper properly along the paper guide. If the paper is inserted diagonally against the paper guide, it may cause improper feeding or paper jam. So, set the paper perfectly in parallel with the paper guide.
 - If the paper not specified is used, quality of printing may not be guaranteed and may cause malfunction.
 - Thermal paper does not withstand high temperature and high humidity. Especially, if the temperature rises over 60 °C, it starts being colored. Pay sufficient care for its storage.

2. Printer Interface Configuration

Type	Interface		
	RS232C	IrDA	Bluetooth
FTP-628WSL110			
FTP-628WSL120			-

: with interface function

3. Name of Respective Parts

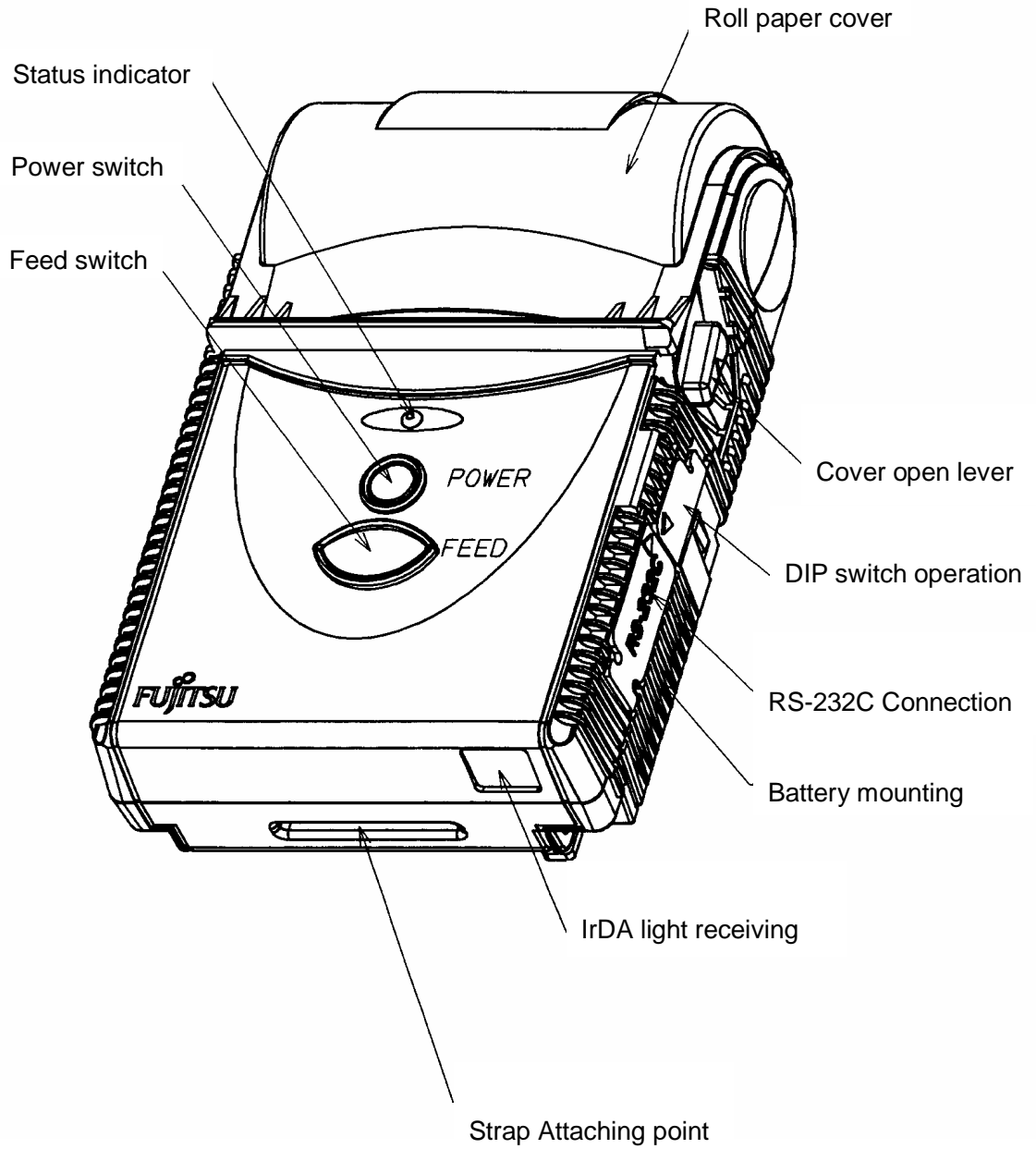

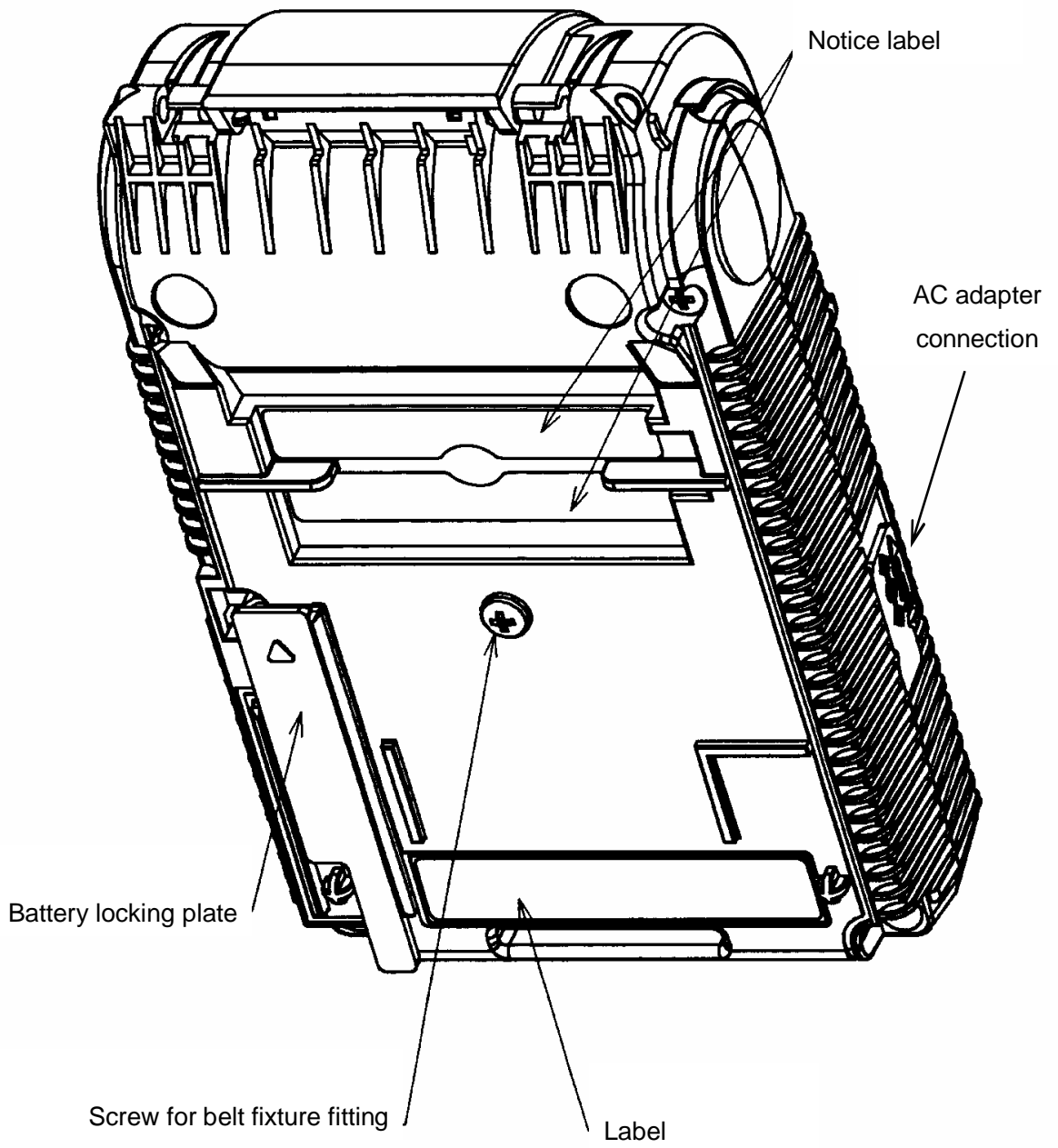

4. Operation of Respective Parts

- **Cover open lever/Roll paper cover**

The cover open lever is used when the roll paper cover is opened for replacement of paper roll and recording paper roll is set.

If you move the cover open lever, roll paper cover will open.

- **Status indication lamp**

This lamp is on when power is switched on. Further, when some errors happen, the lamp indicates its status.

- * The status indication lamp might not be seen easily in a bright place under direct sunshine etc.

- **Power switch**

This is the switch to turn on/off the power.

- * Please do not operate two seconds after cutting the power supply.

(About two seconds after cutting the power supply, the operation becomes invalid.)

- **Feed switch**

This is used to feed printing paper. The paper will be fed while you are pressing this switch.

• **AC adapter connection**

Open the cover of AC adapter connection from the side marked with  mark and connect the plug of AC adapter with internal connector. Then insert the power plug to AC outlet.

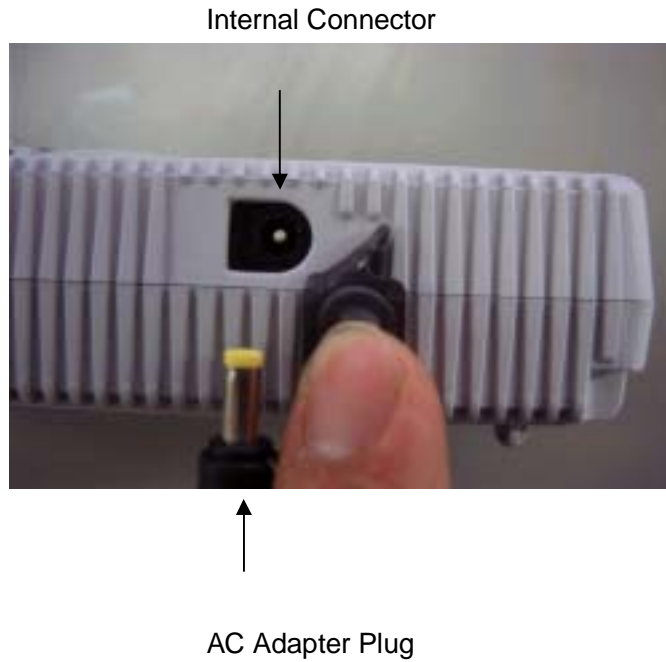

Plugging of power cable enables you to recharge battery and to operate printer with AC adapter.

<p>Battery recharging</p>	<p>When pre-charging is started, the status indication lamp flashes in red, and during the charging, the lamp is on in red. When the recharging is fully made, the status indication lamp will extinct. *Please turn off the power supply of the printer when red kept blinking for 30 seconds or more, pull out the AC adaptor from the main body, and take out the battery.(p16 to p18) Afterwards, please insert installation AC adaptor and charge with the battery again. When red keeps blinking even if the above-mentioned is operated, please remove the AC adaptor and contact the sales representatives of our Company beforehand.</p>
<p>Printer movement</p>	<p>By pushing power switch, printer movement by AC adapter is activated.</p>

- **Dip switch operating part**

Open cover of the dip switch operating part from the side marked with  and manipulate the dip switch inside. This is used when printer setting is changed.

Dip Switch



- **RS-232C connecting part**

Open the cover of RS-232C connecting part from the side marked with , and connect RS-232C cable (separately available) to internal connector.

RS-232C Connector



- **Battery lid/Battery locking plate**

These are used when the battery is mounted or replaced. If the sequence of the steps is wrong, they will not open. Operate in accordance with the following steps:

[Mounting]

- 1) Turn the Printer upside down and put it on the table.



- 2) Remove the battery lid. As shown in the enlarged illustration, pull up the lid while pressing the hook of the battery lid to the direction of the arrow.



(Enlarged illustration of the circulated part)

- 3) Lift the side marked with  of battery locking plate. In this case, if you lift it with too much vigor the battery locking plate may break. Handle carefully.



- 4) Mount the battery. Make sure that the (+,-) sides of the battery is in the same direction as the (+,-) indication on the battery locking plate.



- 5) While pressing the battery, push the battery locking plate at the side indicated with mark.

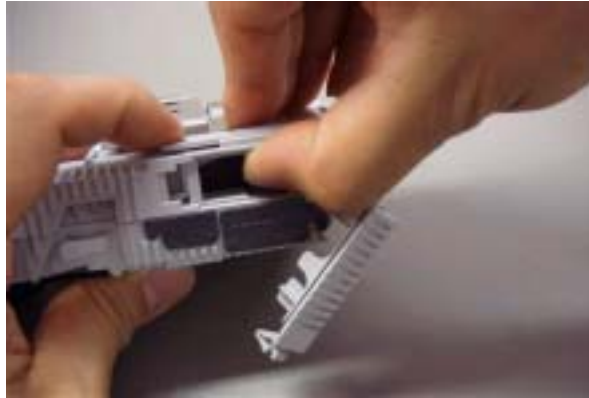

- 6) Fix the battery lid. While pushing the lid to the direction indicated by arrow , push the hook of battery lid to the direction indicated by arrow to close the lid.



[Exchange of battery]

- 1) Follow the same steps 1 to 3 for mounting.
- 2) Tilt the printer and take out the battery pack.



- 3) Follow the same steps 4 to 6 for mounting.

• **IrDA light-receiving and sending part**

This is for sending and receiving data by way of IrDA communications.



* Do not peep into through IrDA communication window. Especially, pay special attention when communication is being carried out.

For data transmission, use under the following conditions:

Transmission distance:	300 mm	(angle \pm 15 °)
	600 mm	(angle \pm 8 °)

- **Belt fixture**

With the use of enclosed belt fixture, you may hand-carry this Printer.

Fix the belt fixture with the screws attached to the Printer.

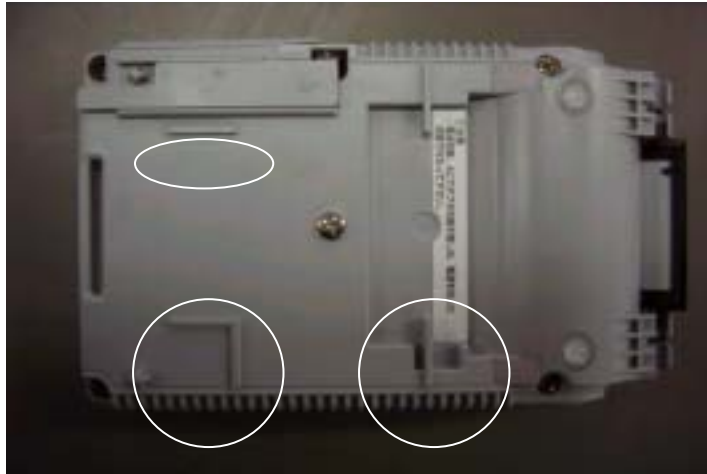

Portions indicated with circles function as stoppers for belt fixture.

Belt fixture may be mounted in the following three manners:

*Belt fixture should not touch or run on battery locking plate or stopper.



Fixing of belt fixture



An example of holding the Printer



Fixing of belt fixture

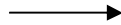

An example of holding the Printer

*Only in the case of the following example, the position of the hole for fixing the belt fixture is different from other cases. Be careful.



Fixing of belt fixture



An example of holding the Printer

• **Attachment of strap**

With the use of strap specially made for this Printer (sold separately), you may carry this Printer.

5. Mounting of Paper Roll

This printer uses thermal paper to be printed by means of heat. The method for mounting the paper roll is explained below:

- 1) Move the cover open lever to the direction indicated by arrow.

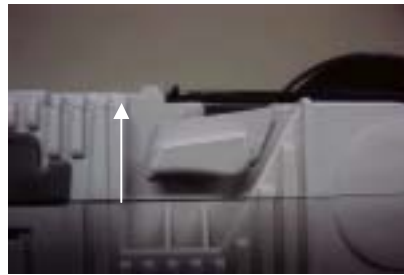

Enlargement of encircled portion

- 2) This is the state when paper cover is opened. At the portion indicated with arrow, lies the cutter blade. Be careful not to cut your finger, etc. accidentally.



3) Place the paper roll into the paper holder. In the case of new roll, the end of the paper may still hold adhesive. Draw the paper a little longer and set it.



4) Press the center part of the paper cover and close it firmly.



5) Cut the paper by moving it to the direction indicated by arrow.



6. Selecting Power Source of AC Adapter and Battery

This printer is operable with the lithium ion secondary battery and the AC adapter

Item	Description
AC Adapter	(1) When the printer power is ON and the AC adapter is connected, the AC adapter supplies the power. (2) When the printer power is OFF, the battery is charged. (3) When the printer power is turned on, charging the battery is terminated. (4) The AC adapter operation without inserting battery is no guarantee of proper operation.
Battery	(1) When the AC adapter does not supply the power, power is supplied from the battery. (2) The remained battery charge reaches a level lower than the setting level (Battery voltage detection function Discharge curve V3), the power is automatically turned off.

7. Operating Switches

This Printer is operated using two switches.

Item	Description
Power switch	(1) Press this switch to turn on the printer power. (2) When the power is turned on, LED blinks according to the printer status and printer becomes ready for operation. (3) When turning off the printer power, if the process including registration to the flash memory in progress, turn off the power using this switch after the completion of the registration. (4) When turning off the printer power, keep this switch pressed (for three seconds or more) until the LED comes off. (5) The power is automatically turned off after predetermined time has passed from the time of printer operation (printing, communication and etc.) stopping. (Automatic power off)
Feed switch	(1) Press this switch to feed paper forms. (2) When turning on the power with this switch pressed, it moves to the self-test printing function.

8. Status Indication Function by LED

(Printer status indication)

Printer status		LED indication			
		Orange	Green	Red	On-off cycle (ms)
Printer operation status	Normal status (radio transmission interface)				
	Normal status (RS-232C interface)				
	Link in progress (Bluetooth)				
	Link in progress (IrDA)				
	At the power-off				
	Low battery				
Error status	Paper run-out				
	Opened cover				
	Head temperature abnormality				
	Supply voltage abnormality				
	Hardware abnormality				
	Mark non-detection abnormality				
	Watchdog, RAM abnormality				
	Bluetooth abnormality				

Note 1) ○ indicates lighting, and ○ indicates blinking.

Note 2) For on-off cycle, numeric without color indicates lighting (upper side) and extinction (lower side).

(Battery charge status indication)

This indicates the battery charge status.

Printer status		LED indication			
		Orange	Green	Red	On-off cycle (ms)
Battery status	Charge in progress				
	Fully charged				
Error status	Overcharged				880
	Over discharged				880
	Timeout				880

Note 1) indicates lighting, and indicates blinking.

Note 2) For on-off cycle, upper side indicates lighting, and lower side indicates extinction.

(Maintenance status indication)

This indicates the printer maintenance status.

Printer status		LED indication			
		Orange	Green	Red	On-off cycle (ms)
Maintenance status	Printer F/W Download in progress				150(green) 1,000(orange)
	Bluetooth F/W Download in progress				150(green) 150(green) 300(orange) 1,000(orange)

Note 1) indicates lighting, and indicates blinking.

9. Interface Connector Connection (RS-232C Connection Part)

1) Part No.: RL01-R12P (Japan Aviation Electronics Industry, Ltd.) or equivalent

2) Signal pin assignment

No.	Signal name	Direction	Function
1	GND	-----	Signal ground
2	RxD	Input	Receive data
3	TxD	Output	Send data
4	DTR	Output	Data terminal ready
5	DSR	Input	Data set ready
6-12	N.C.	-----	Not connected

Note) • Input and output are defined from the printer side.
 • For pin number, refer to the figure below.

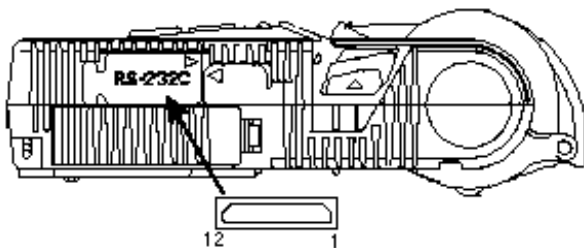

3) Connector model No.: RL01-P12S-C (Japan Aviation Electronics Industry, Ltd.) or equivalent

10. Interface Setting (Dip Switch Operating Part)

Bit No.	Function	Setting	Description
1	Interface setting	OFF	Wireless interface
		ON	Wired interface
2	Communication mode	OFF	No control sequence communication mode
		ON	Packet communication mode
3	RESERVE	OFF	
		ON	
4	Download setting mode	OFF	Printer execution mode
		ON	Program download mode

11. Function Specification

<1> List of Commands

Item	Command	Command name	Interface		
			RS	BT	IR
1	HT	Horizontal tab			
2	LF	Line feed with printing			
3	FF	Forms feed			
4	ESC RS	Black-white reversed printing specification			
5	ESC US	Black-white reversed printing cancellation			
6	ESC FF	Data printing in page print mode			
7	ESC !+n	Printing mode specification			
8	ESC %+n	External registration character specification/ cancellation			
9	ESC &+y+c1+c2+x+[d1 to dn]	External registration character definition			
10	ESC * m n1+n2+[d1 to dn]	Bit image mode specification			
11	ESC 3+n	Minimum-pitch-unit line pitch setting			
12	ESC ?+n	External registration character deletion			
13	ESC @	Printer initialization			
14	ESC A+n	Line spacing setting			
15	ESC C+n	Page length (number of lines) setting			
16	ESC D+n	Horizontal tab position setting			
17	ESC J+n	Printing and minimum-pitch-unit paper feed			
18	ESC K+n	Backward paper feed			
19	ESC L	Page print mode selection			
20	ESC R+n	International character specification			
21	ESC S	Print area setting in page print mode			
22	ESC V+n	Right rotation 90°			
23	ESC W+ X1+X2+Y1+Y2+dX1+ dX2+ dY1+dY2	Print area setting in page mode			
24	ESC X+m+n	Sleep mode time setting			
25	ESC c+1+n	Internal processing setting			
26	ESC s+n	Printing speed setting			
27	ESC { +n	Upside-down printing setting/cancellation			
28	FS !+n	Kanji printing mode collective specification			
29	FS &	Kanji printing mode specification			
30	FS .	Kanji printing mode cancellation			
31	FS 9+n	Detection function enable/disable setting			
32	FS C+n	Kanji code system selection			
33	FS E+n	Correction of impressed energy			
34	FS r+n	Parameter transmission			
35	GS \$+n1+n2	Vertical absolute position specification in page printing mode			
36	GS &+m+x+y1+y2+d1 to dn	Registration of image data			
37	GS '+m+n	Print registered image data			

38	GS <	Mark detection execution			
39	GS A+m+n	After-mark-detection head distance setting			
40	GS B+n	Bar code angle setting			
41	GS E+n	Print quality setting			
42	GS a+n	Setting and cancellation of status transmission			
43	GS e+n+m	Bar code width setting			
44	GS h+n	Bar code height setting			
45	GS k+m+n+d1 to dn	Bar code printing			
46	GS (A ENQ	Bluetooth information printing			

RS: RS-232C, BT: Bluetooth, IR:IrDA

: valid for with/without sequence mode

: valid for without sequence mode

<2> Test Printing

- 1) This printer is provided with test printing function.
- 2) To make test printing, press power switch while pressing “feed switch” of operating switch. The status indication lamp will put on green and the test printing is started. The printer will stop printing after printing a certain set length.

Example of test printing



12. Hardware Specification

Printing system	Thermal line-dot printing		
Thermal head configuration	Resolution:	8 dots/mm	
	Dot pitch:	0.125 mm (Length) x 0.125 mm (side)	
	Number of dot:	384 dots/line	
	Effective printing area:	Approx. 48 mm	
Printing speed	Alphanumeric Katakana Kanji	Half size character	Max. 40 (mm/sec)
		Full size character	
	Image integrated printing		
Number of characters printed	Alphanumeric Katakana	Half size character 12 x 24	32
		Full size character/Kanji.non-Kanji 24 x 24 16	
	Chinese character	Half size character 8 x 16	48
		Full size character/Kanji.non-Kanji 16 x 16 24	
Character type	Alphanumeric Katakana	Internal half size character (12 x 24) Internal full size character (24 x 24) Internal half size character (8 x 16) Internal full size character (16 x 16) Registered half size character (12 x 24) Registered full size character (24 x 24) Registered half size character (8 x 16) Registered full size character (16 x 16)	
	Kanji	Non-Kanji, Kanji JIS Class I, Class II level (JIS C6226-1983)	
Extended print mode	Horizontal double size, backward printing, reverse video, vertical double size, x4 size		
Image mode	Max. No. of dots/line:	384	
Interface	IrDA	Communication method: IrDA Ver 1.2 Baud rate: 9,600 bps, 19,200 bps, 38,400 bps, 115.2 kbps Communication mode: Semi duplex Protocol stack: IrLAP, IrLMP, IrLAS, TinyTP, IrCOMM	
	RS-232C	Communication mode: Semi/Full duplex Baud rate: 9.600 bps (Max. 115.2 kbps)	
	Bluetooth	Communication method: Ver 1.1 Modulation method: FHSS/GFSK Transmission speed: 460 kbps Profile: SPP	
AC adapter	Input supply voltage: Rating 100VAC to 240VAC Output voltage: 5 VDC (Rating) Output current: 1.5 A (Rating)		
	External dimensions	Main frame: 73(W) x 48(H) x 20(D) Cable: 1.8 m	
Battery pack	Kind: Lithium ion secondary battery pack, 1 parallel, 1 serial Life: Approx. 1 year (varies depending upon use conditions)		
Operating temperature and humidity	Temperature: 0 - 50 (5-40 for printing quality assurance) 0 - 40 (When AC adapter is used) Humidity: 20 - 50%RH (No condensation shall be found)		
Storage temperature and humidity	Temperature: -20 - 60 Humidity: 5 - 90%RH (No condensation shall be found)		
Structure	External dimensions: 84(W) x 135(H) x 44(D) Weight: Up to 270 g (Paper and battery included)		

13. Recording Paper (Recommended Paper)

Specified paper	Highly sensitive paper	TF50KS-E4 (Nippon Paper)
	Standard paper	TF-60KS-E (Nippon Paper) PD150R (Oji Paper)
	Medium term storage paper	TP60KS-F1 (Nippon Paper) PD170R (Oji Paper) P220VBB-1 (Mitsubishi Paper)
	Long term storage paper	HA220AA (Mitsubishi Paper)
Paper width	58 mm	
Paper type	Thermosensitive roll paper (thermosensitive side is on outside)	
Roll diameter	36 mm or less	

14. Others

<1> Handling of recording paper

Recording paper will get colored due to chemical reaction. When handling it, pay attention to the following points:

- Do not store it at high-temperature, high-humidity place.
- Do not store for a long time at a place exposed to direct sun-light.
- Do not use solvent type glue for pasting.
- Do not let it get in touch with plastic film containing plasticiser for a long time.
- Do not stick it together with diazotype copying paper.
- Be careful for wetting with water, scratching, etc.

<2> Clean-up and Care of Printer

- * Take off the battery pack and AC adapter before carrying out the followings:

Clean-up of the thermal head (Once a month)

- 1) Open the roll paper cover (Refer to Page 22, 5. Paper setting 1))
- 2) Moist cotton swab with alcohol and wipe the thermal head until the stain is removed. For alcohol, use IPA (Isopropyl alcohol) available in the market.



* Portion indicated by a box is thermal head.

- 3) Wipe off with dry soft cloth, and wait until it dries naturally. Shut the paper cover.

Cleaning of roller (Once a month)

- 1) Open the roll paper cover (Refer to Page 22, 5. Paper setting 1))
- 2) Wipe off the stain with alcohol pasted cloth. For alcohol, use IPA (Isopropyl alcohol) available in the market.



* Portion indicated by a box is thermal head.

- 3) Wipe off with dry soft cloth, and wait until it dries naturally. Shut the paper cover.

Cleaning of photo-sensor (Once a month)

- 1) Open the roll paper cover (Refer to Page 22, 5. Paper setting 1)
- 2) With nylon brush, etc., brush off the paper dust, etc.



* Portion indicated by a box is photo-sensor.

Cleaning of IrDA receiving and transmitting part (When the stains are visible)



* Portion indicated by a box is IrDA receiving and transmitting part

- 1) Moist the cloth with neutral detergent. Lightly wipe off the stains.
- 2) Dip the cloth into water and wring it. Wipe off well the detergent with this cloth.
- 3) Wipe with dry soft cloth.

<3> Troubleshooting

Symptom	Possible cause	Corrective action
No power	<ul style="list-style-type: none"> • Is the battery mounted? • Isn't the battery run out of capacity? • Isn't the battery mounted to the reverse direction? • Is AC adapter connected? • Is the power switch pressed? 	<ul style="list-style-type: none"> • Mount the battery. • Recharge the battery • Reset the battery correcting its polarity. (Refer to page 18) • Connect AC adapter (Refer to page 13) • Press the power switch on.
No printing	<ul style="list-style-type: none"> • Is the power on? • Is the recording paper correctly set? • Isn't the status indication lamp lighted red? • Isn't the status indication lamp flashing orange? • Is the paper holder cover firmly closed? • Isn't the distance for IrDA communication too far apart or the angle too big? • Isn't the IrDA window too much soiled? • Is the dip switch setting correct? • Aren't you communicating under the direct sunlight? 	<ul style="list-style-type: none"> • Press the power switch on. • Check the recording paper setting (Refer to page 22) • Recharge the battery. • Release the error mode. (Refer to page 26) • Close the paper holder cover properly. • Either reduce the distance or adjust the angle. • Clean the window. (Refer to page 36) • Check the dip switch setting. (Refer to page 28) • Avoid direct sunlight.
Printing too dim	<ul style="list-style-type: none"> • Isn't the thermal head stained? • Are the selection of paper and energy setting correct? 	<ul style="list-style-type: none"> • Clean the thermal head. (Refer to page 35) • Check the dip switch setting and energy setting.
Recharging time is too long	<ul style="list-style-type: none"> • Isn't the ambient temperature too low? 	<ul style="list-style-type: none"> • Recharge at 10 – 30 °C.
Recharging time is too short	<ul style="list-style-type: none"> • Is the same symptom repeated? (Red lamp is lighted when used after recharging) 	<ul style="list-style-type: none"> • Possibly the battery life is expiring. Change to new one.
Paper holder cover cannot be opened or shut	<ul style="list-style-type: none"> • Aren't the supporting points of paper holder cover removed? 	<ul style="list-style-type: none"> • Adjust the cover to the supporting points. (Refer to page 38)

Fixing Paper Cover



When the paper cover is removed, take the following steps for correction.

- 1) Keep the printer with paper cover opened. Press the opening/closing supporting points of the paper cover to the frame and fix the cover.

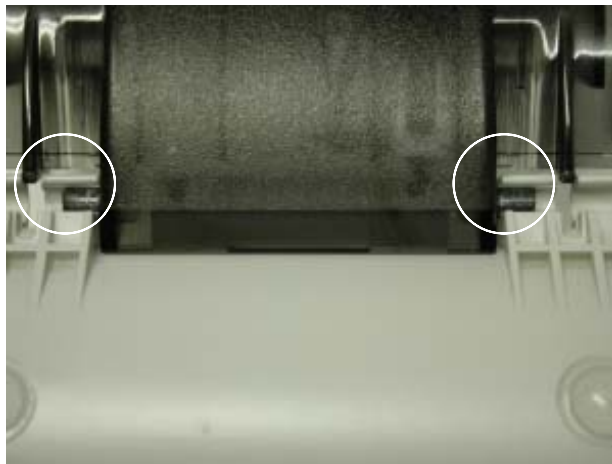

* The encircled parts are supporting points.

- 2) Open and close the paper cover once or twice and make sure that the opening/closing can be carried out smoothly.

Federal Communication Commission Interference Statement

This equipment has been tested and found to comply with the limits for a Class B digital device, pursuant to Part 15 of the FCC Rules. These limits are designed to provide reasonable protection against harmful interference in a residential installation. This equipment generates, uses and can radiate radio frequency energy and, if not installed and used in accordance with the instructions, may cause harmful interference to radio communications. However, there is no guarantee that interference will not occur in a particular installation. If this equipment does cause harmful interference to radio or television reception, which can be determined by turning the equipment off and on, the user is encouraged to try to correct the interference by one of the following measures:

- Reorient or relocate the receiving antenna.
- Increase the separation between the equipment and receiver.
- Connect the equipment into an outlet on a circuit different from that to which the receiver is connected.
- Consult the dealer or an experienced radio/TV technician for help.

FCC Caution: Any changes or modifications not expressly approved by the party responsible for compliance could void the user's authority to operate this equipment.

This device complies with Part 15 of the FCC Rules. Operation is subject to the following two conditions: (1) This device may not cause harmful interference, and (2) this device must accept any interference received, including interference that may cause undesired operation.

This transmitter must not be co-located or operating in conjunction with any other antenna or transmitter. CH1~CH11 by specified firmware controlled in the USA.