

FCC Test Report

FCC ID : SQGBL653
Equipment : Bluetooth 5.1 Data Module
Model No. : BL653
Brand Name : Laird Connectivity
Applicant : Laird Connectivity
Address : W66N220 Commerce Court, Cedarburg,
Wisconsin 53012, USA
Standard : 47 CFR FCC Part 15.247
Received Date : Jan. 30, 2020
Tested Date : Feb. 11 ~ Feb. 21, 2020

We, International Certification Corp., would like to declare that the tested sample has been evaluated and in compliance with the requirement of the above standards. The test results contained in this report refer exclusively to the product. It may be duplicated completely for legal use with the approval of the applicant. It shall not be reproduced except in full without the written approval of our laboratory.

Reviewed by:

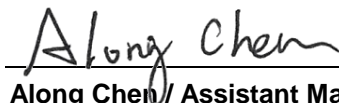

Along Chen / Assistant Manager

Approved by:



Gary Chang / Manager



Table of Contents

1	GENERAL DESCRIPTION	5
1.1	Information.....	5
1.2	Local Support Equipment List	8
1.3	Test Setup Chart	8
1.4	Test Equipment List and Calibration Data.....	9
1.5	Test Standards	10
1.6	Deviation from Test Standard and Measurement Procedure.....	10
1.7	Measurement Uncertainty	10
2	TEST CONFIGURATION	11
2.1	Testing Condition	11
2.2	The Worst Test Modes and Channel Details	11
3	TRANSMITTER TEST RESULTS.....	12
3.1	Conducted Emissions.....	12
3.2	6dB and Occupied Bandwidth	17
3.3	RF Output Power.....	28
3.4	Power Spectral Density	33
3.5	Emissions in Restricted Frequency Bands.....	44
3.6	Emissions in non-restricted Frequency Bands.....	129
4	TEST LABORATORY INFORMATION	142

Release Record

Report No.	Version	Description	Issued Date
FR013002	Rev. 01	Initial issue	May 11, 2020
FR013002	Rev. 02	Changing brand	May 26, 2020

Summary of Test Results

FCC Rules	Test Items	Measured	Result
15.207	AC Power Line Conducted Emissions	[dBuV]: 0.513MHz 30.39 (Margin -15.61dB) - AV	Pass
15.247(d) 15.209	Radiated Emissions	Meet the requirement of limit	Pass
15.247(b)(3)	Maximum Output Power	Power [dBm]: 8.03	Pass
15.247(a)(2)	6dB Bandwidth	Meet the requirement of limit	Pass
15.247(e)	Power Spectral Density	Meet the requirement of limit	Pass
15.203	Antenna Requirement	Meet the requirement of limit	Pass

Declaration of Conformity:

The test results with all measurement uncertainty excluded are presented in accordance with the regulation limits or requirements declared by manufacturers.

Comments and Explanations:

The declared of product specification for EUT presented in the report are provided by the manufacturer, and the manufacturer takes all the responsibilities for the accuracy of product specification.

1 General Description

1.1 Information

1.1.1 Product Details

The following models are provided to this EUT.

Brand Name	Model Name	Product Name	Description
Laird Connectivity	BL653	Bluetooth 5.1 Data Module	With Printed PCB antenna
			With MHF4 connector antenna

1.1.2 Specification of the Equipment under Test (EUT)

RF General Information				
Frequency Range (MHz)	Bluetooth Mode	Ch. Freq. (MHz)	Channel Number	Data Rate
2400-2483.5	LE	2402-2480	0-39 [40]	125 kbps
				500 kbps
				1 Mbps
				2 Mbps

Note: Bluetooth LE (Low energy) uses GFSK modulation.

1.1.3 Antenna Details

Manufacturer	Model	Laird Part Number	Type	Connector	Gain (dBi)
Laird	NanoBlue	EBL2400A1-10 MH4L	PCB Dipole	IPEX MHF4	2
Laird	FlexPIFA	001-0022	PCB Dipole	IPEX MHF4	2
Mag.Layers	EDA-8709-2G4 C1-B27-CY	0600-00057	Dipole	IPEX MHF4	2
Laird	mFlexPIFA	EFA2400A3S-10 MH4L	PIFA	IPEX MHF4	2
Laird	Laird NFC	0600-00061	NFC	N/A	--
Laird	BL653-SA PCB printed antenna	NA	Printed PCB	N/A	1.28

1.1.4 Power Supply Type of Equipment under Test (EUT)

Power Supply Type	Option 1: DC 5V from host Option 2: DC 3.3V from host Option 3: DC 1.8V from host
--------------------------	---

1.1.5 Channel List

Frequency band (MHz)				2400~2483.5			
Channel	Frequency (MHz)	Channel	Frequency (MHz)	Channel	Frequency (MHz)	Channel	Frequency (MHz)
37	2402	9	2422	18	2442	28	2462
0	2404	10	2424	19	2444	29	2464
1	2406	38	2426	20	2446	30	2466
2	2408	11	2428	21	2448	31	2468
3	2410	12	2430	22	2450	32	2470
4	2412	13	2432	23	2452	33	2472
5	2414	14	2434	24	2454	34	2474
6	2416	15	2436	25	2456	35	2476
7	2418	16	2438	26	2458	36	2478
8	2420	17	2440	27	2460	39	2480

1.1.6 Test Tool and Duty Cycle

Test Tool	UwTerminal, version: 7.94		
Duty Cycle and Duty Factor	Modulation Mode	Duty Cycle (%)	Duty Factor (dB)
	GFSK/125kbps	83.97%	0.76
	GFSK/500kbps	58.33%	2.34
	GFSK/1Mbps	63.89%	1.95
	GFSK/2Mbps	34.26%	4.65

1.1.7 Power Index of Test Tool

3.3V High Power

Modulation Mode	Test Frequency (MHz)		
	2402	2440	2480
GFSK/125kbps	8	8	8
GFSK/500kbps	8	8	8
GFSK/1Mbps	8	8	8
GFSK/2Mbps	8	8	8

3.3V Low Power

Modulation Mode	Test Frequency (MHz)		
	2402	2440	2480
GFSK/125kbps	-40	-40	-40
GFSK/500kbps	-40	-40	-40
GFSK/1Mbps	-40	-40	-40
GFSK/2Mbps	-40	-40	-40

1.2 Local Support Equipment List

Support Equipment List					
No.	Equipment	Brand	Model	FCC ID	Remarks
1	Notebook	DELL	Latitude E5470	DoC	---
2	50Ω terminator	---	---	---	---
3	USB Cable	I-Gota	micro to A	---	---
4	Fixture	Laird	DVK-BL653	---	Provided by applicant.

1.3 Test Setup Chart

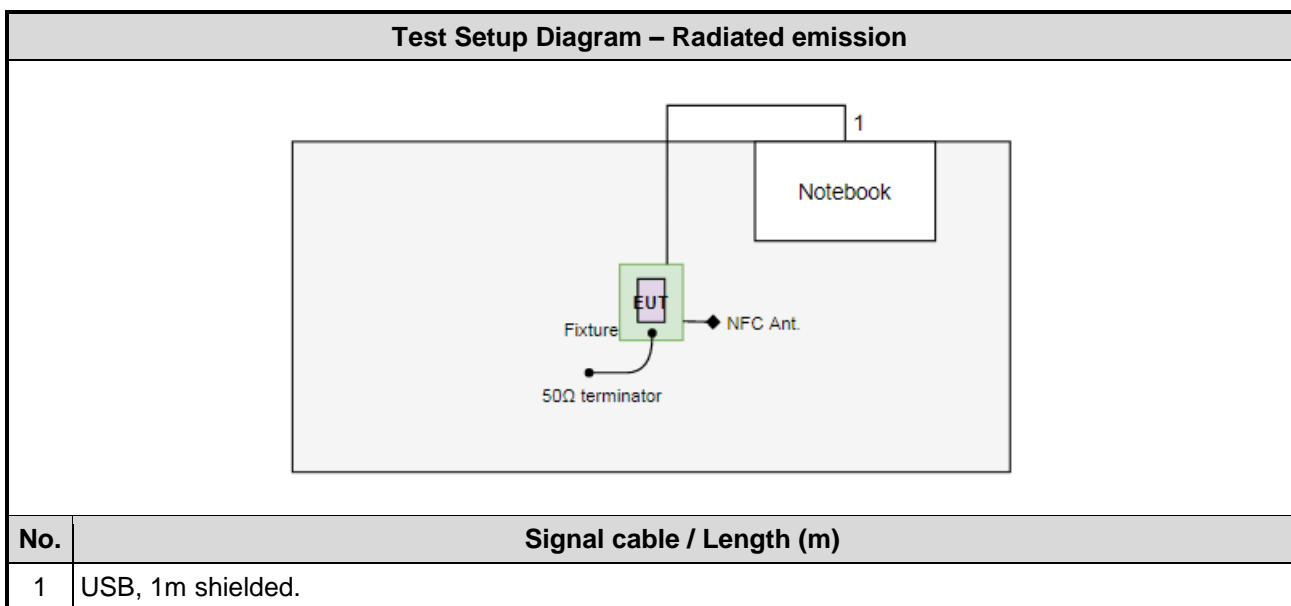
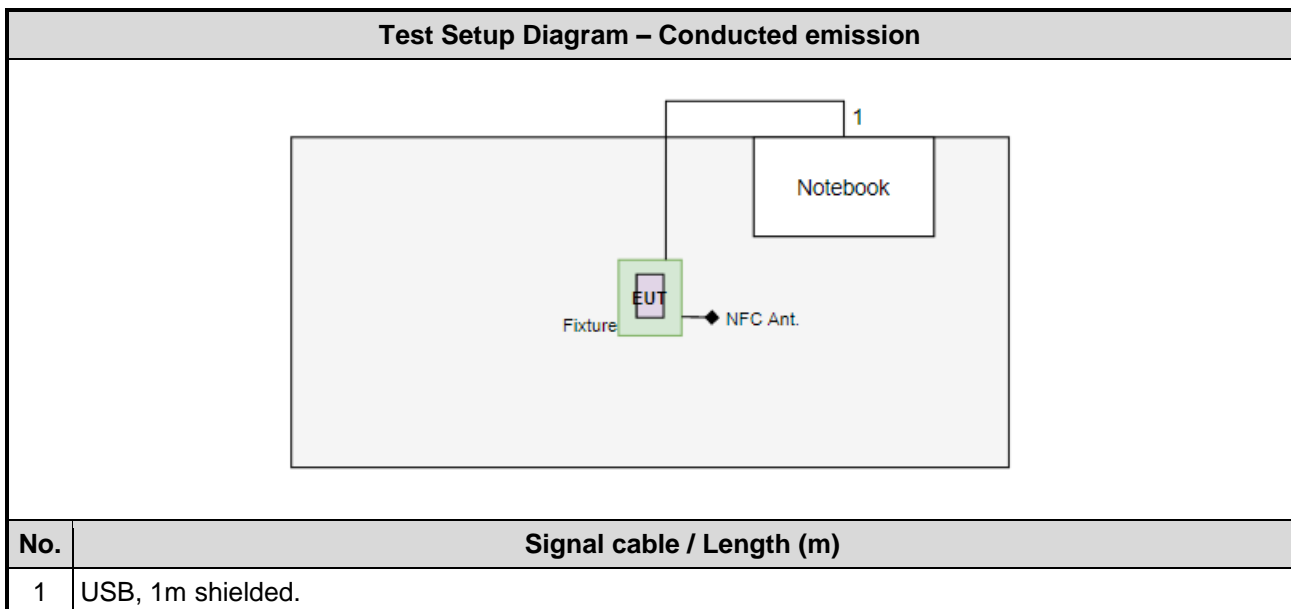

1.4 Test Equipment List and Calibration Data

Test Item	Conducted Emission				
Test Site	Conduction room 1 / (CO01-WS)				
Tested Date	Feb. 21, 2020				
Instrument	Manufacturer	Model No.	Serial No.	Calibration Date	Calibration Until
Receiver	R&S	ESR3	101658	Dec. 12, 2019	Dec. 10, 2020
LISN	R&S	ENV216	101579	Mar. 08, 2019	Mar. 07, 2020
RF Cable-CON	Woken	CFD200-NL	CFD200-NL-001	Oct. 22, 2019	Oct. 21, 2020
Measurement Software	AUDIX	e3	6.120210k	NA	NA
Note: Calibration Interval of instruments listed above is one year.					

Test Item	Radiated Emission				
Test Site	966 chamber1 / (03CH01-WS)				
Tested Date	Feb. 11 ~ Feb. 17, 2020				
Instrument	Manufacturer	Model No.	Serial No.	Calibration Date	Calibration Until
Spectrum Analyzer	R&S	FSV40	101498	Dec. 17, 2019	Dec. 16, 2020
Receiver	R&S	ESR3	101658	Dec. 12, 2019	Dec. 11, 2020
Bilog Antenna	SCHWARZBECK	VULB9168	VULB9168-522	Jul. 12, 2019	Jul. 11, 2020
Horn Antenna 1G-18G	SCHWARZBECK	BBHA 9120 D	BBHA 9120 D 1096	Dec. 12, 2019	Dec. 11, 2020
Horn Antenna 18G-40G	SCHWARZBECK	BBHA 9170	BBHA 9170517	Nov. 15, 2019	Nov. 14, 2020
Loop Antenna	R&S	HFH2-Z2	100330	Nov. 13, 2019	Nov. 12, 2020
Loop Antenna Cable	KOAX KABEL	101354-BW	101354-BW	Oct. 07, 2019	Oct. 06, 2020
Preamplifier	EMC	EMC02325	980225	Jul. 09, 2019	Jul. 08, 2020
Preamplifier	Agilent	83017A	MY39501308	Oct. 08, 2019	Oct. 07, 2020
Preamplifier	EMC	EMC184045B	980192	Aug. 01, 2019	Jul. 31, 2020
RF Cable	EMC	EMC104-SM-SM-8000	181106	Oct. 07, 2019	Oct. 06, 2020
RF Cable	HUBER+SUHNER	SUCOFLEX104	MY16019/4	Oct. 07, 2019	Oct. 06, 2020
RF Cable	HUBER+SUHNER	SUCOFLEX104	MY16014/4	Oct. 07, 2019	Oct. 06, 2020
LF cable 1M	EMC	EMCCFD400-NM-NM-1000	160502	Oct. 07, 2019	Oct. 06, 2020
LF cable 3M	Woken	CFD400NL-LW	CFD400NL-001	Oct. 07, 2019	Oct. 06, 2020
LF cable 10M	Woken	CFD400NL-LW	CFD400NL-002	Oct. 07, 2019	Oct. 06, 2020
Measurement Software	AUDIX	e3	6.120210g	NA	NA
Note: Calibration Interval of instruments listed above is one year.					

Test Item	RF Conducted				
Test Site	(TH01-WS)				
Tested Date	Feb. 18, 2020				
Instrument	Manufacturer	Model No.	Serial No.	Calibration Date	Calibration Until
Spectrum Analyzer	R&S	FSV40	101063	Apr. 17, 2019	Apr. 16, 2020
Power Meter	Anritsu	ML2495A	1241002	Oct. 23, 2019	Oct. 22, 2020
Power Sensor	Anritsu	MA2411B	1207366	Oct. 23, 2019	Oct. 22, 2020
DC POWER SOURCE	GW INSTRON	GPC-6030D	GES855395	Oct. 29, 2019	Oct. 28, 2020
Measurement Software	Sporton	Sporton_1	1.3.30	NA	NA
Note: Calibration Interval of instruments listed above is one year.					

1.5 Test Standards

According to the specification of EUT, the EUT must comply with following standards and KDB documents.

47 CFR FCC Part 15.247

ANSI C63.10-2013

FCC KDB 558074 D01 15.247 Meas Guidance v05r02

1.6 Deviation from Test Standard and Measurement Procedure

None

1.7 Measurement Uncertainty

ISO/IEC 17025 requires that an estimate of the measurement uncertainties associated with the emissions test results be included in the report. The measurement uncertainties given below are based on a 95% confidence level (based on a coverage factor ($k=2$)).

Measurement Uncertainty	
Parameters	Uncertainty
Bandwidth	± 34.130 Hz
Conducted power	± 0.808 dB
Power density	± 0.583 dB
Conducted emission	± 2.715 dB
AC conducted emission	± 2.92 dB
Radiated emission ≤ 1 GHz	± 3.41 dB
Radiated emission > 1 GHz	± 4.59 dB

2 Test Configuration

2.1 Testing Condition

Test Item	Test Site	Ambient Condition	Tested By
AC Conduction	CO01-WS	22°C / 67%	Akun Chung
Radiated Emissions	03CH01-WS	17-24°C / 68%	Miki Shu Akun Chung
RF Conducted	TH01-WS	19°C / 62%	Brad Wu

- FCC Designation No.: TW2732
- FCC site registration No.: 181692
- ISED#: 10807A
- CAB identifier: TW2732

2.2 The Worst Test Modes and Channel Details

Test item	Mode	Test Frequency (MHz)	Data Rate	Test Configuration
AC Power Line Conducted Emissions	BT LE	2402	1Mbps 2Mbps	3
Maximum Output Power 6dB bandwidth Power spectral density	BT LE	2402, 2440, 2480	125kbps 500kbps 1Mbps 2Mbps	1, 2
Emissions in non-restricted frequency bands	BT LE	2402, 2440, 2480	125kbps 500kbps 1Mbps 2Mbps	1, 2, 3
Radiated Emissions ≤ 1GHz Conducted Emission ≤ 1GHz	BT LE	2480	1Mbps 2Mbps	1, 2, 3
Radiated Emissions > 1GHz Conducted Emission > 1GHz	BT LE	2402, 2440, 2480	1Mbps 2Mbps	1, 2, 3

NOTE:

1. The EUT was pretested with 3 orientations placed on the table for the radiated emission measurement – X, Y, and Z-plane. The **X-plane** results were found as the worst case and were shown in this report.
2. The EUT supports three DC voltage options, DC 1.8V, DC 3.3V and DC 5V. All options were assessed and **DC 3.3V** was found to be the worst case and was selected for the final test.
3. The EUT supports High Power & Low Power. Each power had been performed the test.
4. Test configurations are listed as follows:
 - 1) Test configuration 1: Low Power with Printed PCB antenna
 - 2) Test configuration 2: High Power with Printed PCB antenna
 - 3) Test configuration 3: High Power with MHF4 connector antenna
5. 50Ω terminator was connected to antenna port of EUT for radiated emission measurement.

3 Transmitter Test Results

3.1 Conducted Emissions

3.1.1 Limit of Conducted Emissions

Conducted Emissions Limit		
Frequency Emission (MHz)	Quasi-Peak	Average
0.15-0.5	66 - 56 *	56 - 46 *
0.5-5	56	46
5-30	60	50

Note 1: * Decreases with the logarithm of the frequency.

3.1.2 Test Procedures

1. The device is placed on a test table, raised 80 cm above the reference ground plane. The vertical conducting plane is located 40 cm to the rear of the device.
2. The device is connected to line impedance stabilization network (LISN) and other accessories are connected to other LISN. Measured levels of AC power line conducted emission are across the 50 Ω LISN port.
3. AC conducted emission measurements is made over frequency range from 150 kHz to 30 MHz.
4. This measurement was performed with AC 120V/60Hz

3.1.3 Test Setup

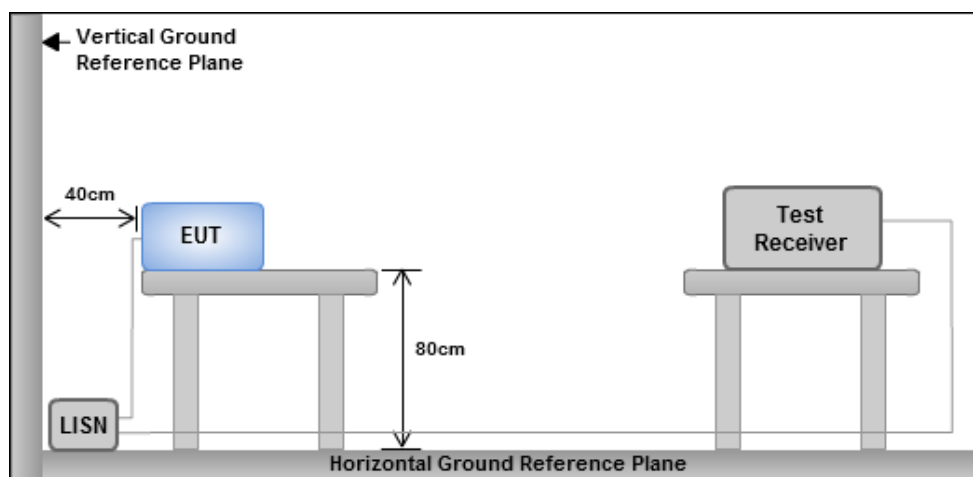

- Note: 1. Support units were connected to second LISN.
2. Both of LISNs (AMN) are 80 cm from EUT and at least 80 cm from other units and other metal planes

Test configuration 3: High Power with MHF4 connector antenna

3.1.4 Test Result of Conducted Emissions

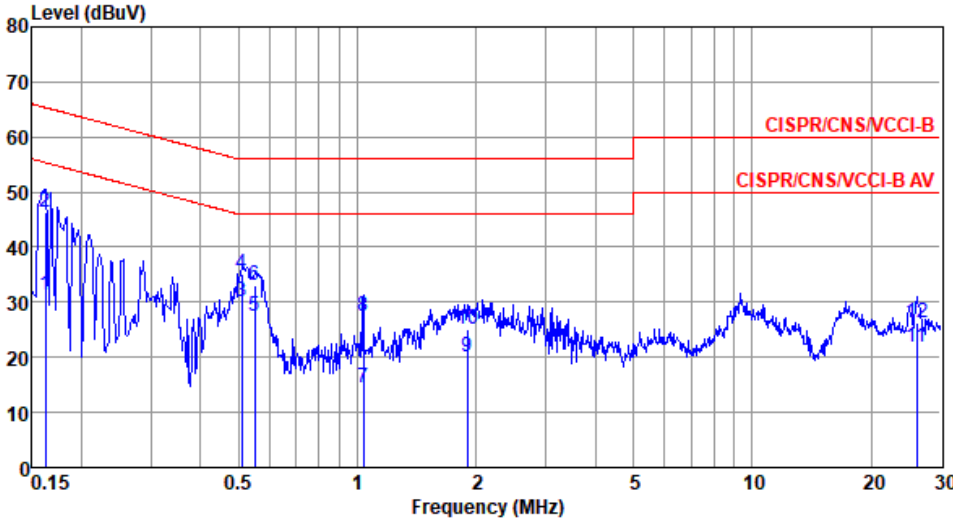
Modulation Mode	BT LE-1Mbps	Test Freq. (MHz)	2402																																																																																																																					
Power Phase	Line																																																																																																																							
																																																																																																																								
<table border="1"> <thead> <tr> <th></th> <th>Freq MHz</th> <th>Level dBuA</th> <th>Limit Line dBuA</th> <th>Over Limit dB</th> <th>Read Level dBuA</th> <th>LISN factor dB</th> <th>cable loss dB</th> <th>Remark</th> </tr> </thead> <tbody> <tr><td>1</td><td>0.162</td><td>31.30</td><td>55.34</td><td>-24.04</td><td>21.72</td><td>9.53</td><td>0.05</td><td>Average</td></tr> <tr><td>2</td><td>0.162</td><td>46.42</td><td>65.34</td><td>-18.92</td><td>36.84</td><td>9.53</td><td>0.05</td><td>QP</td></tr> <tr><td>3*</td><td>0.510</td><td>30.01</td><td>46.00</td><td>-15.99</td><td>20.34</td><td>9.58</td><td>0.09</td><td>Average</td></tr> <tr><td>4</td><td>0.510</td><td>35.19</td><td>56.00</td><td>-20.81</td><td>25.52</td><td>9.58</td><td>0.09</td><td>QP</td></tr> <tr><td>5</td><td>0.549</td><td>27.58</td><td>46.00</td><td>-18.42</td><td>17.91</td><td>9.58</td><td>0.09</td><td>Average</td></tr> <tr><td>6</td><td>0.549</td><td>33.11</td><td>56.00</td><td>-22.89</td><td>23.44</td><td>9.58</td><td>0.09</td><td>QP</td></tr> <tr><td>7</td><td>1.037</td><td>14.45</td><td>46.00</td><td>-31.55</td><td>4.73</td><td>9.60</td><td>0.12</td><td>Average</td></tr> <tr><td>8</td><td>1.037</td><td>27.38</td><td>56.00</td><td>-28.62</td><td>17.66</td><td>9.60</td><td>0.12</td><td>QP</td></tr> <tr><td>9</td><td>1.898</td><td>19.95</td><td>46.00</td><td>-26.05</td><td>10.17</td><td>9.60</td><td>0.18</td><td>Average</td></tr> <tr><td>10</td><td>1.898</td><td>25.14</td><td>56.00</td><td>-30.86</td><td>15.36</td><td>9.60</td><td>0.18</td><td>QP</td></tr> <tr><td>11</td><td>26.139</td><td>21.71</td><td>50.00</td><td>-28.29</td><td>11.35</td><td>9.63</td><td>0.73</td><td>Average</td></tr> <tr><td>12</td><td>26.139</td><td>26.26</td><td>60.00</td><td>-33.74</td><td>15.90</td><td>9.63</td><td>0.73</td><td>QP</td></tr> </tbody> </table>					Freq MHz	Level dBuA	Limit Line dBuA	Over Limit dB	Read Level dBuA	LISN factor dB	cable loss dB	Remark	1	0.162	31.30	55.34	-24.04	21.72	9.53	0.05	Average	2	0.162	46.42	65.34	-18.92	36.84	9.53	0.05	QP	3*	0.510	30.01	46.00	-15.99	20.34	9.58	0.09	Average	4	0.510	35.19	56.00	-20.81	25.52	9.58	0.09	QP	5	0.549	27.58	46.00	-18.42	17.91	9.58	0.09	Average	6	0.549	33.11	56.00	-22.89	23.44	9.58	0.09	QP	7	1.037	14.45	46.00	-31.55	4.73	9.60	0.12	Average	8	1.037	27.38	56.00	-28.62	17.66	9.60	0.12	QP	9	1.898	19.95	46.00	-26.05	10.17	9.60	0.18	Average	10	1.898	25.14	56.00	-30.86	15.36	9.60	0.18	QP	11	26.139	21.71	50.00	-28.29	11.35	9.63	0.73	Average	12	26.139	26.26	60.00	-33.74	15.90	9.63	0.73	QP
	Freq MHz	Level dBuA	Limit Line dBuA	Over Limit dB	Read Level dBuA	LISN factor dB	cable loss dB	Remark																																																																																																																
1	0.162	31.30	55.34	-24.04	21.72	9.53	0.05	Average																																																																																																																
2	0.162	46.42	65.34	-18.92	36.84	9.53	0.05	QP																																																																																																																
3*	0.510	30.01	46.00	-15.99	20.34	9.58	0.09	Average																																																																																																																
4	0.510	35.19	56.00	-20.81	25.52	9.58	0.09	QP																																																																																																																
5	0.549	27.58	46.00	-18.42	17.91	9.58	0.09	Average																																																																																																																
6	0.549	33.11	56.00	-22.89	23.44	9.58	0.09	QP																																																																																																																
7	1.037	14.45	46.00	-31.55	4.73	9.60	0.12	Average																																																																																																																
8	1.037	27.38	56.00	-28.62	17.66	9.60	0.12	QP																																																																																																																
9	1.898	19.95	46.00	-26.05	10.17	9.60	0.18	Average																																																																																																																
10	1.898	25.14	56.00	-30.86	15.36	9.60	0.18	QP																																																																																																																
11	26.139	21.71	50.00	-28.29	11.35	9.63	0.73	Average																																																																																																																
12	26.139	26.26	60.00	-33.74	15.90	9.63	0.73	QP																																																																																																																
<p>Note 1: Level (dBuV) = Read Level (dBuV) + LISN Factor (dB) + Cable Loss (dB). Note 2: Over Limit (dB) = Level (dBuV) – Limit Line (dBuV).</p>																																																																																																																								

Modulation Mode	BT LE-1Mbps	Test Freq. (MHz)	2402
Power Phase	Neutral		

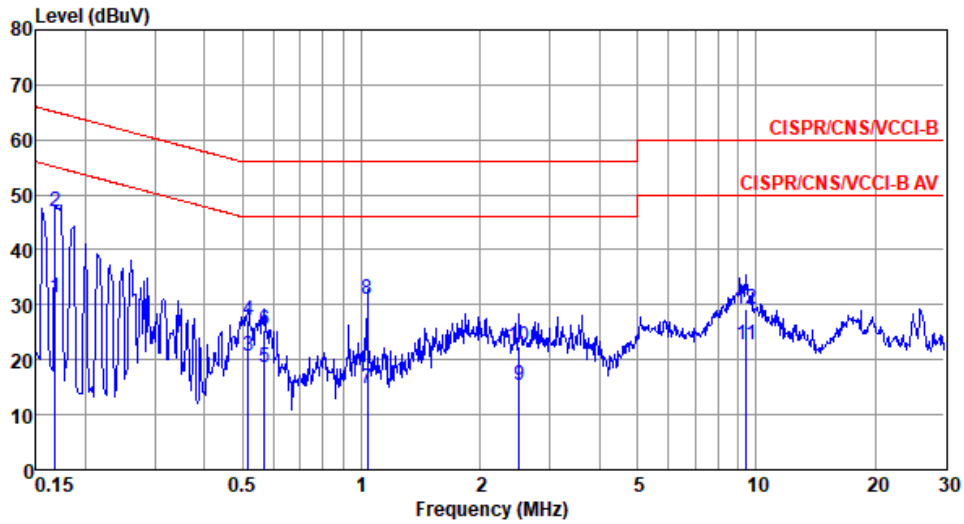

	Freq MHz	Level dBuA	Limit Line dBuA	Over Limit dB	Read Level dBuA	LISN factor dB	cable loss dB	Remark
1	0.168	31.30	55.08	-23.78	21.68	9.57	0.05	Average
2*	0.168	47.06	65.08	-18.02	37.44	9.57	0.05	QP
3	0.516	20.63	46.00	-25.37	10.92	9.62	0.09	Average
4	0.516	27.30	56.00	-28.70	17.59	9.62	0.09	QP
5	0.567	18.74	46.00	-27.26	9.02	9.62	0.10	Average
6	0.567	25.46	56.00	-30.54	15.74	9.62	0.10	QP
7	1.034	14.78	46.00	-31.22	5.02	9.64	0.12	Average
8	1.034	30.98	56.00	-25.02	21.22	9.64	0.12	QP
9	2.513	15.31	46.00	-30.69	5.44	9.65	0.22	Average
10	2.513	22.44	56.00	-33.56	12.57	9.65	0.22	QP
11	9.451	22.73	50.00	-27.27	12.64	9.71	0.38	Average
12	9.451	29.09	60.00	-30.91	19.00	9.71	0.38	QP

Note 1: Level (dBuV) = Read Level (dBuV) + LISN Factor (dB) + Cable Loss (dB).
 2: Over Limit (dB) = Level (dBuV) – Limit Line (dBuV).

Modulation Mode	BT LE-2Mbps	Test Freq. (MHz)	2402
Power Phase	Line		

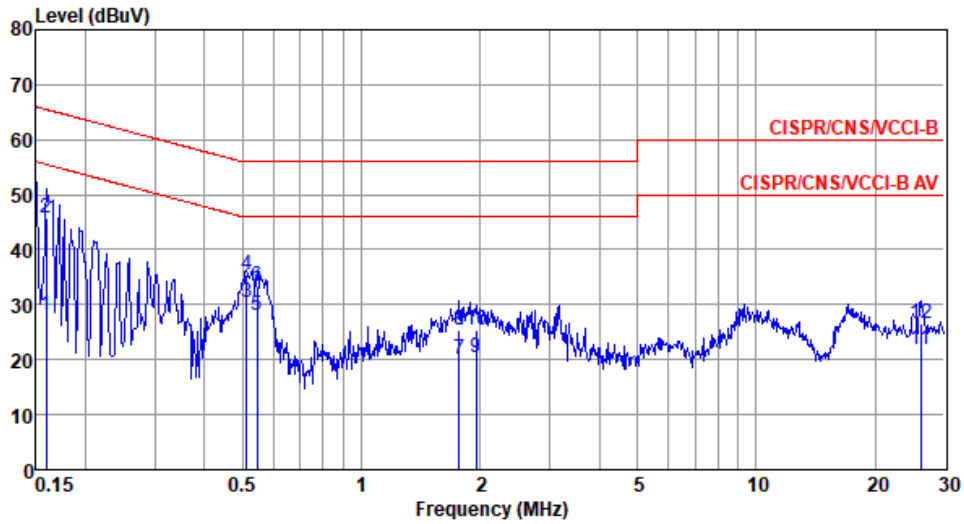

	Freq MHz	Level dBuA	Limit Line dBuA	Over Limit dB	Read Level dBuA	LISN factor dB	cable loss dB	Remark
1	0.159	27.94	55.52	-27.58	18.36	9.53	0.05	Average
2	0.159	45.74	65.52	-19.78	36.16	9.53	0.05	QP
3*	0.513	30.39	46.00	-15.61	20.72	9.58	0.09	Average
4	0.513	35.45	56.00	-20.55	25.78	9.58	0.09	QP
5	0.544	28.11	46.00	-17.89	18.44	9.58	0.09	Average
6	0.544	33.40	56.00	-22.60	23.73	9.58	0.09	QP
7	1.772	20.15	46.00	-25.85	10.38	9.60	0.17	Average
8	1.772	25.35	56.00	-30.65	15.58	9.60	0.17	QP
9	1.949	20.33	46.00	-25.67	10.55	9.60	0.18	Average
10	1.949	25.47	56.00	-30.53	15.69	9.60	0.18	QP
11	26.139	21.77	50.00	-28.23	11.41	9.63	0.73	Average
12	26.139	26.54	60.00	-33.46	16.18	9.63	0.73	QP

Note 1: Level (dBuV) = Read Level (dBuV) + LISN Factor (dB) + Cable Loss (dB).
 Note 2: Over Limit (dB) = Level (dBuV) – Limit Line (dBuV).

Modulation Mode	BT LE-2Mbps	Test Freq. (MHz)	2402
Power Phase	Neutral		

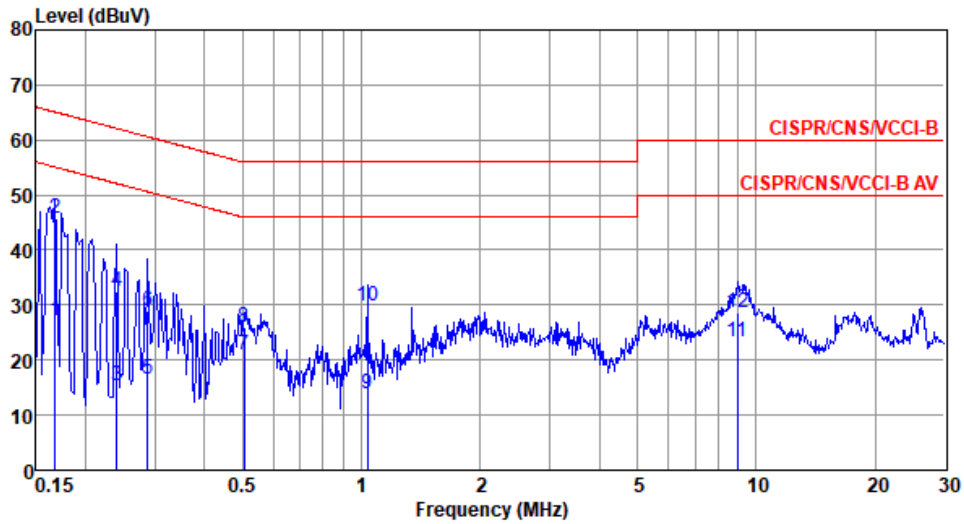

	Freq MHz	Level dBuA	Limit Line dBuA	Over Limit dB	Read Level dBuA	LISN factor dB	cable loss dB	Remark
1	0.168	27.27	55.08	-27.81	17.65	9.57	0.05	Average
2*	0.168	45.73	65.08	-19.35	36.11	9.57	0.05	QP
3	0.240	15.22	52.08	-36.86	5.56	9.59	0.07	Average
4	0.240	32.56	62.08	-29.52	22.90	9.59	0.07	QP
5	0.288	16.47	50.59	-34.12	6.80	9.60	0.07	Average
6	0.288	28.93	60.59	-31.66	19.26	9.60	0.07	QP
7	0.505	21.05	46.00	-24.95	11.34	9.62	0.09	Average
8	0.505	26.05	56.00	-29.95	16.34	9.62	0.09	QP
9	1.037	13.82	46.00	-32.18	4.06	9.64	0.12	Average
10	1.037	29.73	56.00	-26.27	19.97	9.64	0.12	QP
11	8.964	23.43	50.00	-26.57	13.35	9.70	0.38	Average
12	8.964	28.61	60.00	-31.39	18.53	9.70	0.38	QP

Note 1: Level (dBuV) = Read Level (dBuV) + LISN Factor (dB) + Cable Loss (dB).
 Note 2: Over Limit (dB) = Level (dBuV) – Limit Line (dBuV).

3.2 6dB and Occupied Bandwidth

3.2.1 Limit of 6dB Bandwidth

The minimum 6dB bandwidth shall be at least 500 kHz.

3.2.2 Test Procedures

6dB Bandwidth

1. Set resolution bandwidth (RBW) = 100 kHz, Video bandwidth = 300 kHz.
2. Detector = Peak, Trace mode = max hold.
3. Sweep = auto couple, Allow the trace to stabilize.
4. Measure the maximum width of the emission that is constrained by the frequencies associated with the two outermost amplitude points (upper and lower) that are attenuated by 6dB relative to the maximum level measured in the fundamental emission.

Occupied Bandwidth

1. Set resolution bandwidth (RBW) = 1% ~ 5 % of OBW, Video bandwidth = 3 x RBW.
2. Detector = Sample, Trace mode = max hold.
3. Sweep = auto couple, Allow the trace to stabilize.
4. Use the OBW measurement function of spectrum analyzer to measure the occupied bandwidth.

3.2.3 Test Setup

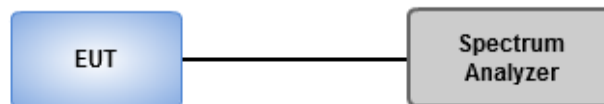

Test configuration 1: Low Power with Printed PCB antenna

3.2.4 Test Result of 6dB and Occupied Bandwidth

Summary

Mode	Max-N dB (Hz)	Max-OBW (Hz)	ITU-Code	Min-N dB (Hz)	Min-OBW (Hz)
2.4-2.4835GHz	-	-	-	-	-
BT-LE0.125_Nss1_1TX	637.681k	1.082M	1M08F1D	608.696k	1.075M
BT-LE0.5_Nss1_1TX	695.652k	1.042M	1M04F1D	684.783k	1.038M
BT-LE(1Mbps)	699.275k	1.046M	1M05F1D	688.406k	1.038M
BT-LE(2Mbps)	1.159M	2.041M	2M04F1D	1.123M	2.026M

Max-N dB = Maximum 6dB down bandwidth; **Max-OBW** = Maximum 99% occupied bandwidth;
Min-N dB = Minimum 6dB down bandwidth; **Min-OBW** = Minimum 99% occupied bandwidth;

Result

Mode	Result	Limit (Hz)	Port 1-N dB (Hz)	Port 1-OBW (Hz)
BT-LE0.125_Nss1_1TX	-	-	-	-
2402MHz	Pass	500k	608.696k	1.075M
2440MHz	Pass	500k	637.681k	1.082M
2480MHz	Pass	500k	608.696k	1.082M
BT-LE0.5_Nss1_1TX	-	-	-	-
2402MHz	Pass	500k	695.652k	1.038M
2440MHz	Pass	500k	684.783k	1.038M
2480MHz	Pass	500k	684.783k	1.042M
BT-LE(1Mbps)	-	-	-	-
2402MHz	Pass	500k	688.406k	1.038M
2440MHz	Pass	500k	699.275k	1.046M
2480MHz	Pass	500k	699.275k	1.046M
BT-LE(2Mbps)	-	-	-	-
2402MHz	Pass	500k	1.159M	2.026M
2440MHz	Pass	500k	1.13M	2.041M
2480MHz	Pass	500k	1.123M	2.041M

Port X-N dB = Port X 6dB down bandwidth; **Port X-OBW** = Port X 99% occupied bandwidth;

BT-LE0.125_Nss1_1TX

EBW

2402MHz

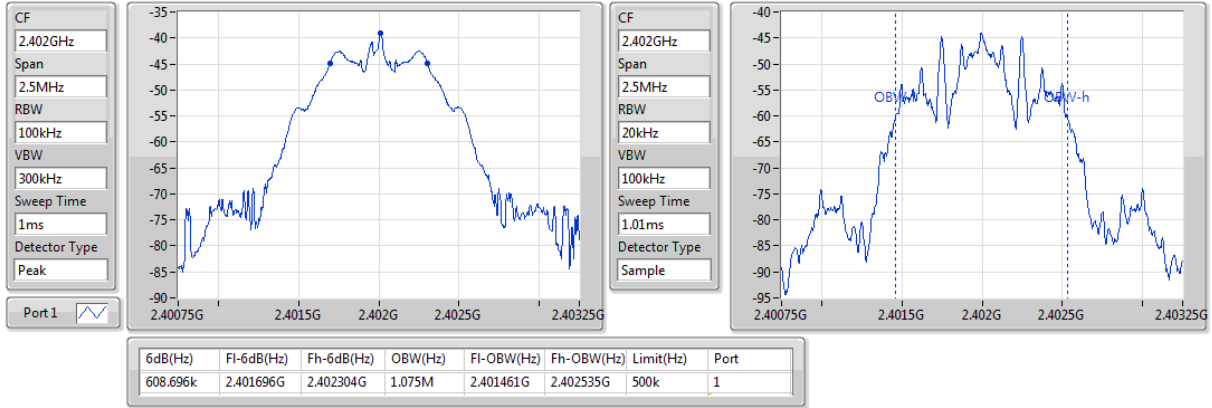

BT-LE0.125_Nss1_1TX

EBW

2440MHz

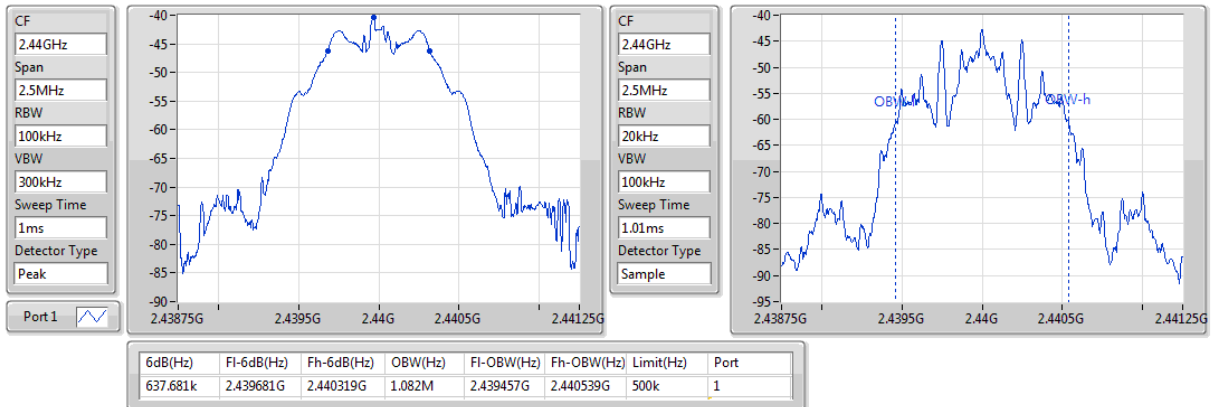

BT-LE0.125_Nss1_1TX

EBW

2480MHz

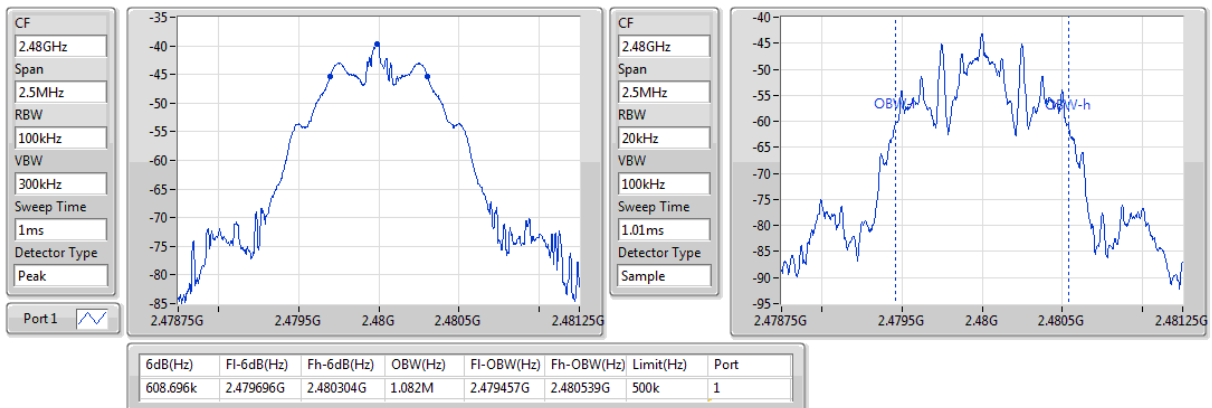

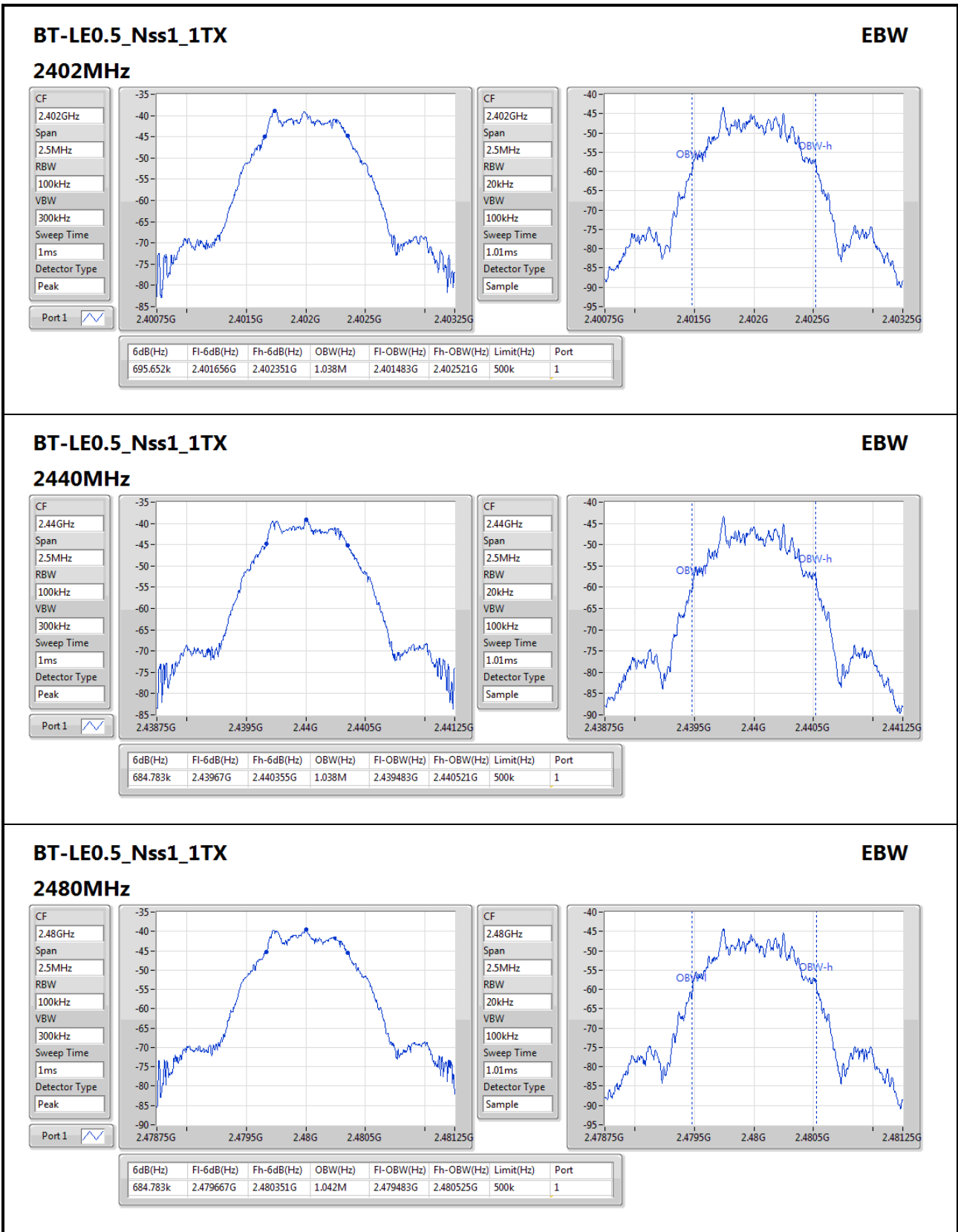
BT-LE0.5_Nss1_1TX
EBW

2480MHz

CF: 2.48GHz
Span: 2.5MHz
RBW: 100kHz
VBW: 300kHz
Sweep Time: 1ms
Detector Type: Peak



CF: 2.48GHz
Span: 2.5MHz
RBW: 20kHz
VBW: 100kHz
Sweep Time: 1.01ms
Detector Type: Sample



BT-LE(1Mbps)

EBW

2402MHz

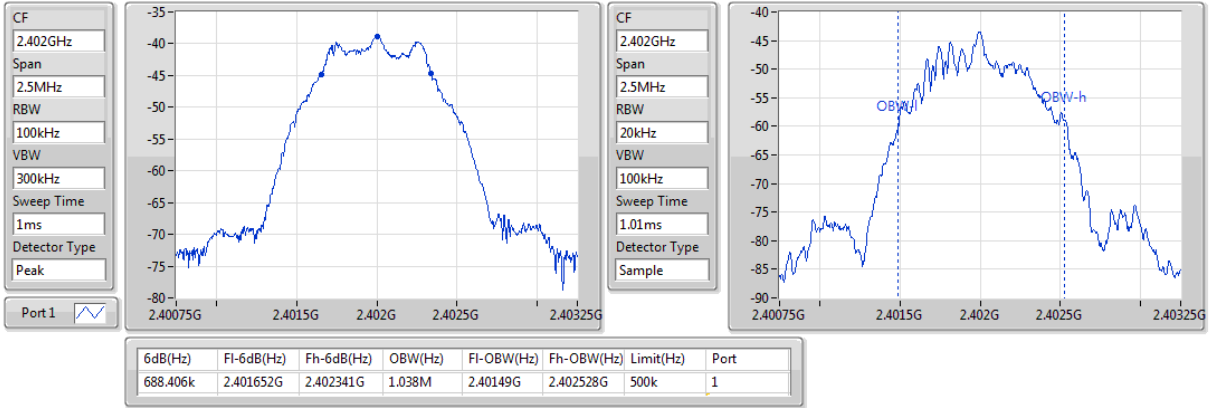

BT-LE(1Mbps)

EBW

2440MHz

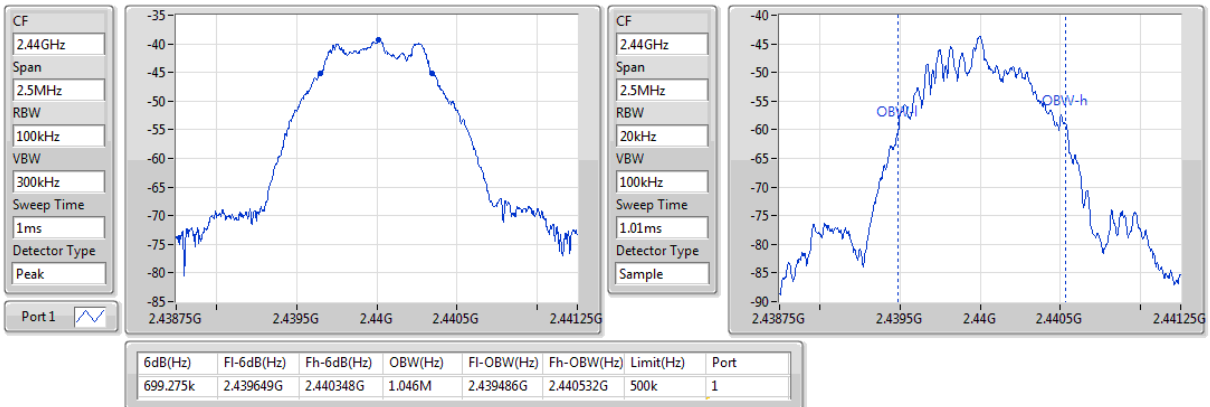

BT-LE(1Mbps)

EBW

2480MHz

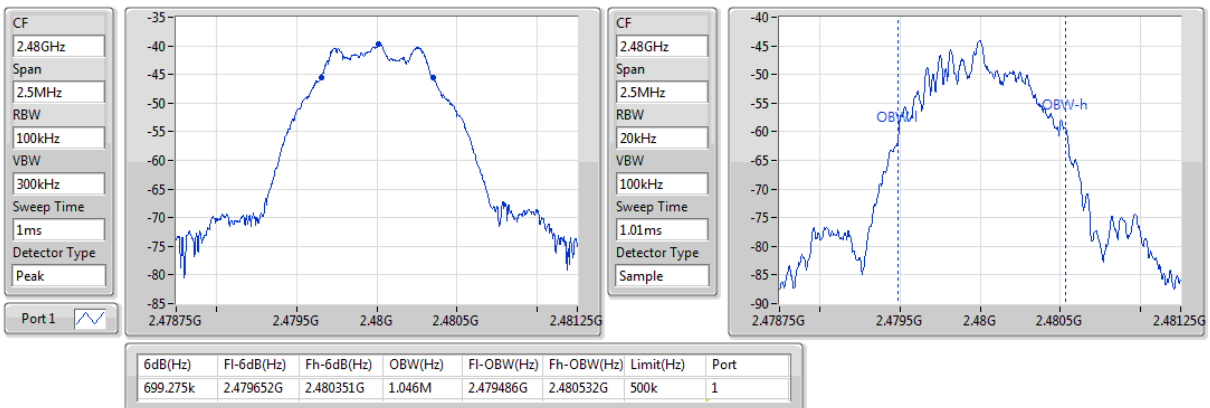

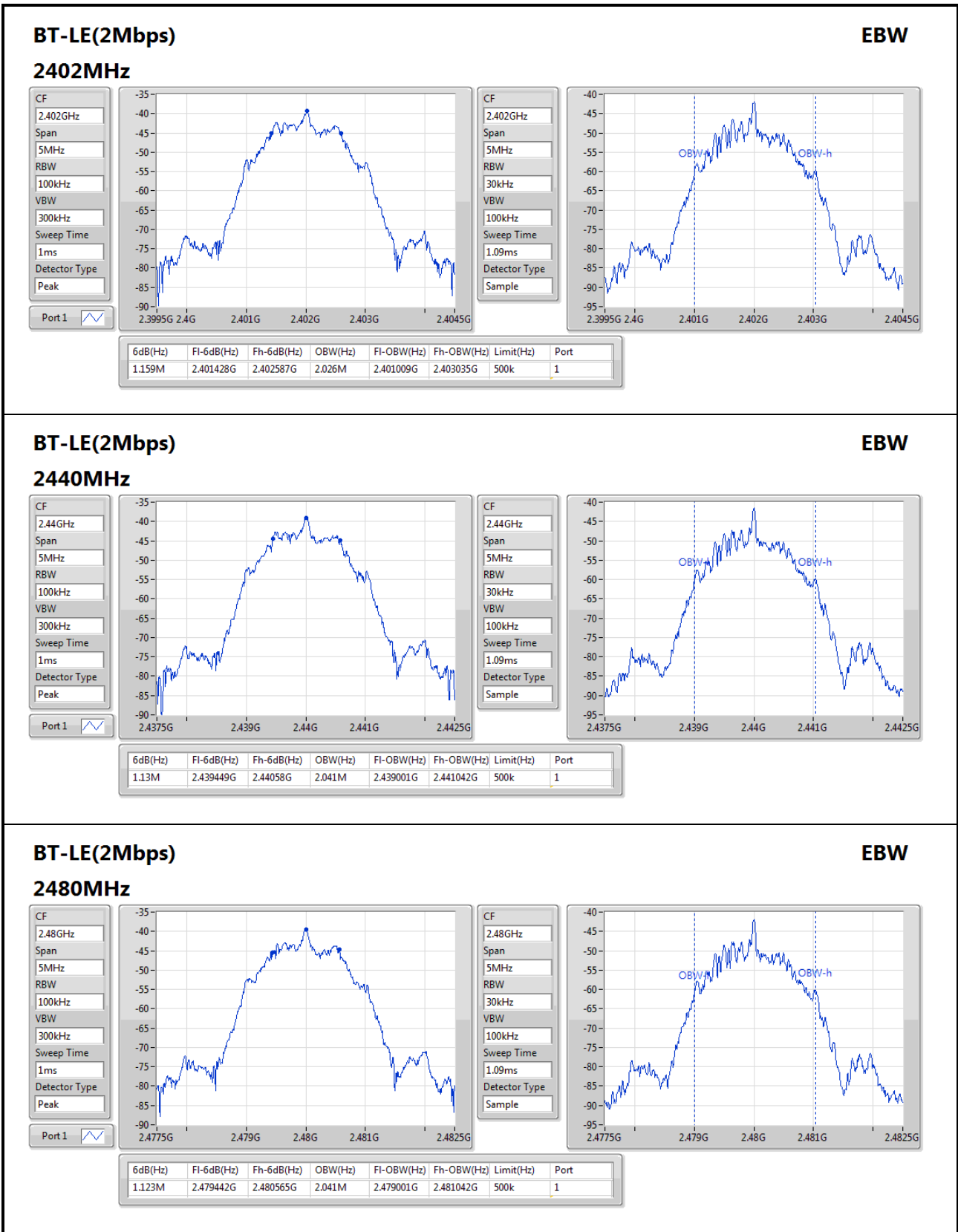

Test configuration 2: High Power with Printed PCB antenna

3.2.5 Test Result of 6dB and Occupied Bandwidth

Summary

Mode	Max-N dB (Hz)	Max-OBW (Hz)	ITU-Code	Min-N dB (Hz)	Min-OBW (Hz)
2.4-2.4835GHz	-	-	-	-	-
BT-LE0.125_Nss1_1TX	619.565k	1.082M	1M08F1D	615.942k	1.071M
BT-LE0.5_Nss1_1TX	695.652k	1.049M	1M05F1D	684.783k	1.038M
BT-LE(1Mbps)	702.899k	1.046M	1M05F1D	688.406k	1.038M
BT-LE(2Mbps)	1.138M	2.041M	2M04F1D	1.116M	2.026M

Max-N dB = Maximum 6dB down bandwidth; **Max-OBW** = Maximum 99% occupied bandwidth;
Min-N dB = Minimum 6dB down bandwidth; **Min-OBW** = Minimum 99% occupied bandwidth;

Result

Mode	Result	Limit (Hz)	Port 1-N dB (Hz)	Port 1-OBW (Hz)
BT-LE0.125_Nss1_1TX	-	-	-	-
2402MHz	Pass	500k	615.942k	1.071M
2440MHz	Pass	500k	619.565k	1.082M
2480MHz	Pass	500k	615.942k	1.075M
BT-LE0.5_Nss1_1TX	-	-	-	-
2402MHz	Pass	500k	692.029k	1.038M
2440MHz	Pass	500k	684.783k	1.049M
2480MHz	Pass	500k	695.652k	1.046M
BT-LE(1Mbps)	-	-	-	-
2402MHz	Pass	500k	702.899k	1.038M
2440MHz	Pass	500k	688.406k	1.042M
2480MHz	Pass	500k	695.652k	1.046M
BT-LE(2Mbps)	-	-	-	-
2402MHz	Pass	500k	1.116M	2.026M
2440MHz	Pass	500k	1.138M	2.041M
2480MHz	Pass	500k	1.138M	2.033M

Port X-N dB = Port X 6dB down bandwidth; **Port X-OBW** = Port X 99% occupied bandwidth;

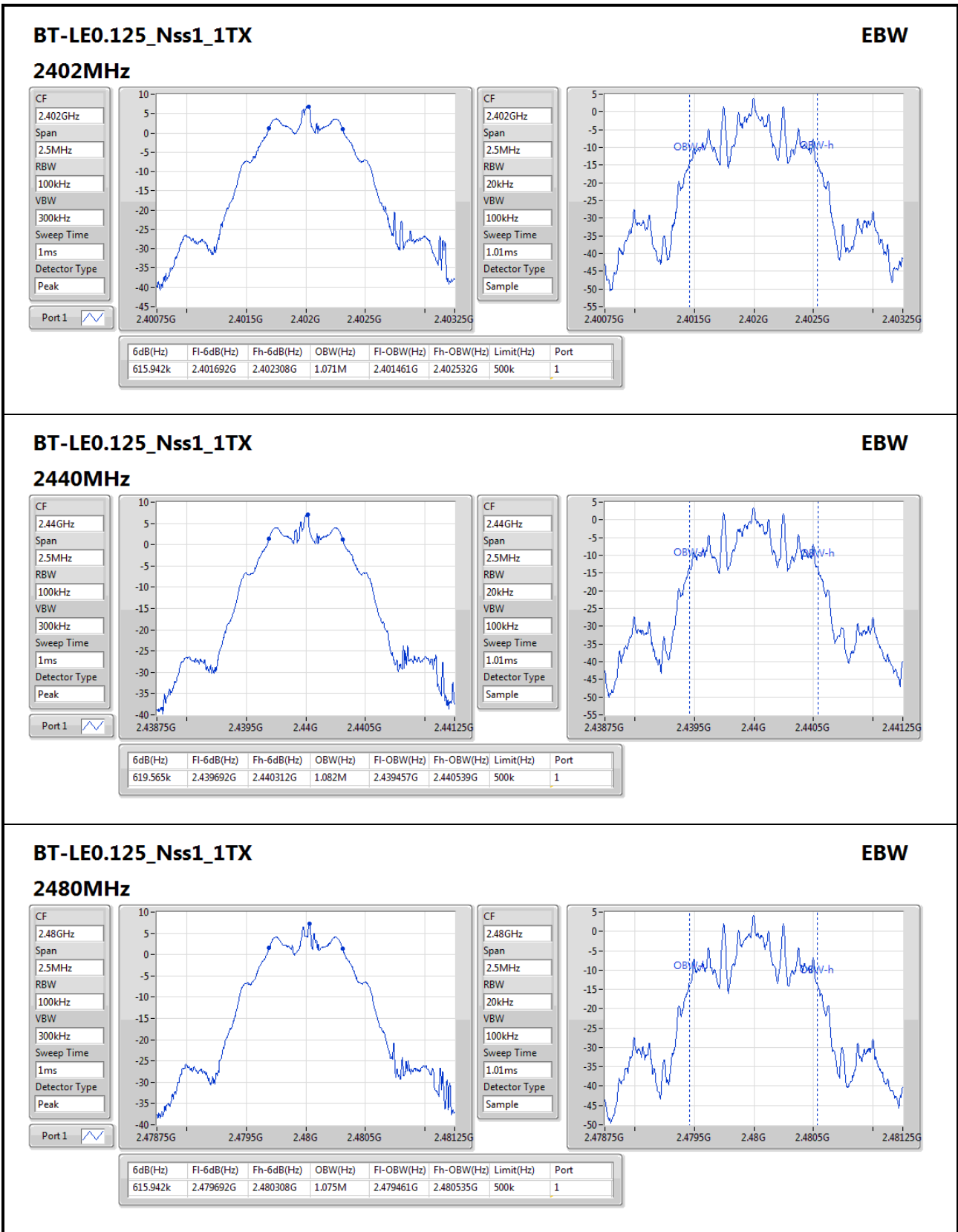

BT-LE0.5_Nss1_1TX

EBW

2402MHz

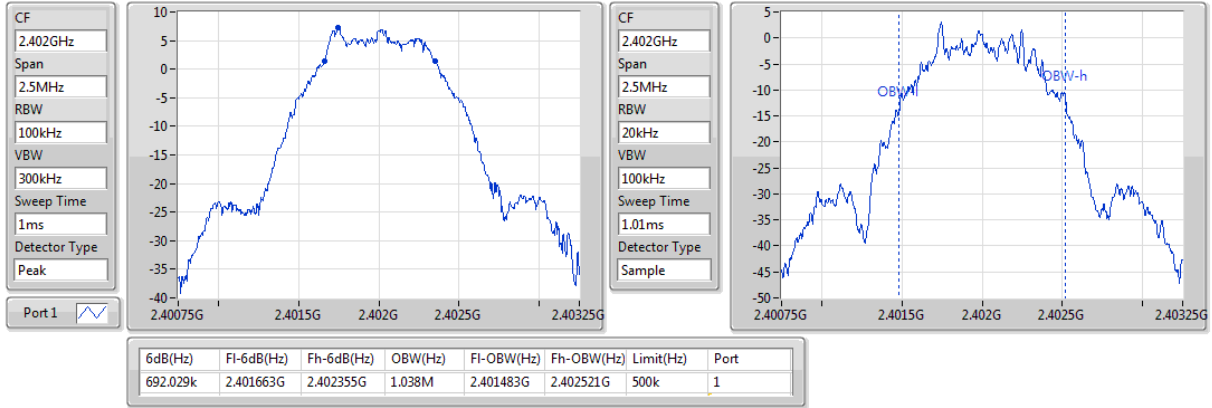

BT-LE0.5_Nss1_1TX

EBW

2440MHz

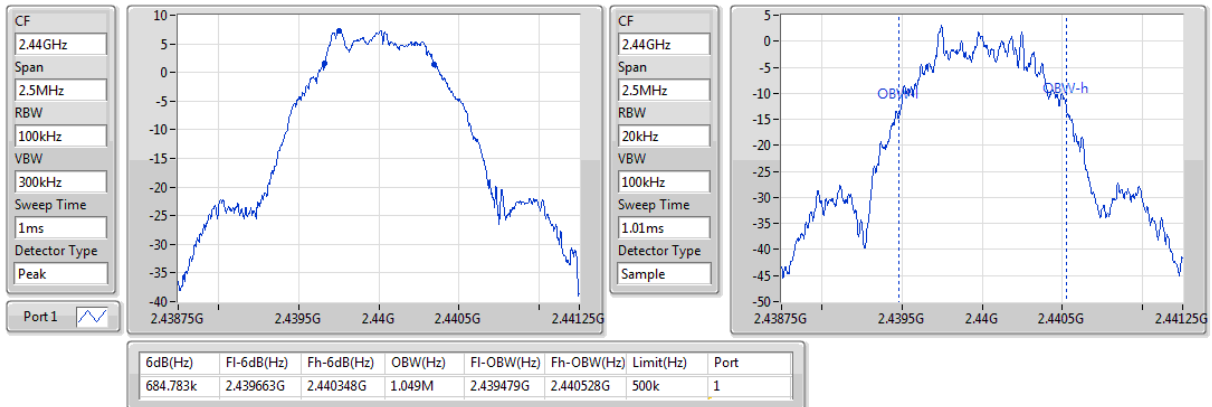

BT-LE0.5_Nss1_1TX

EBW

2480MHz

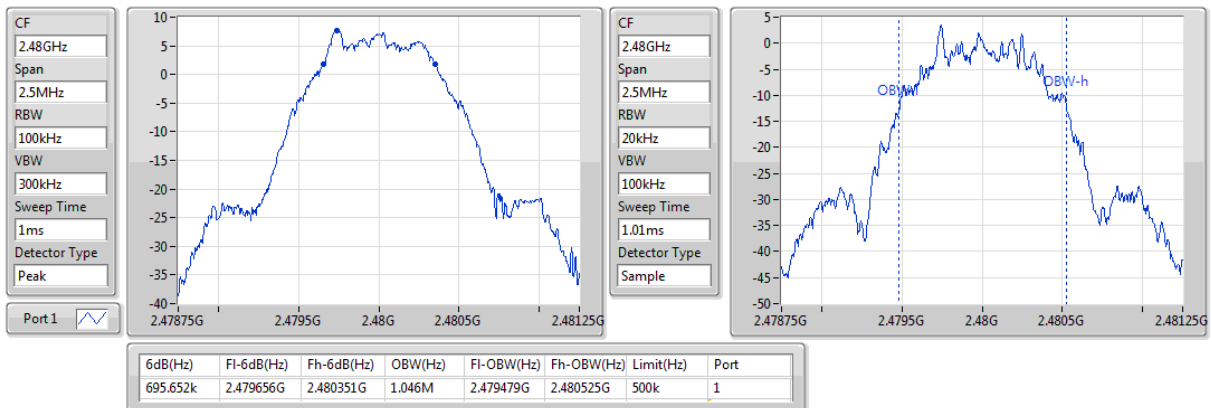

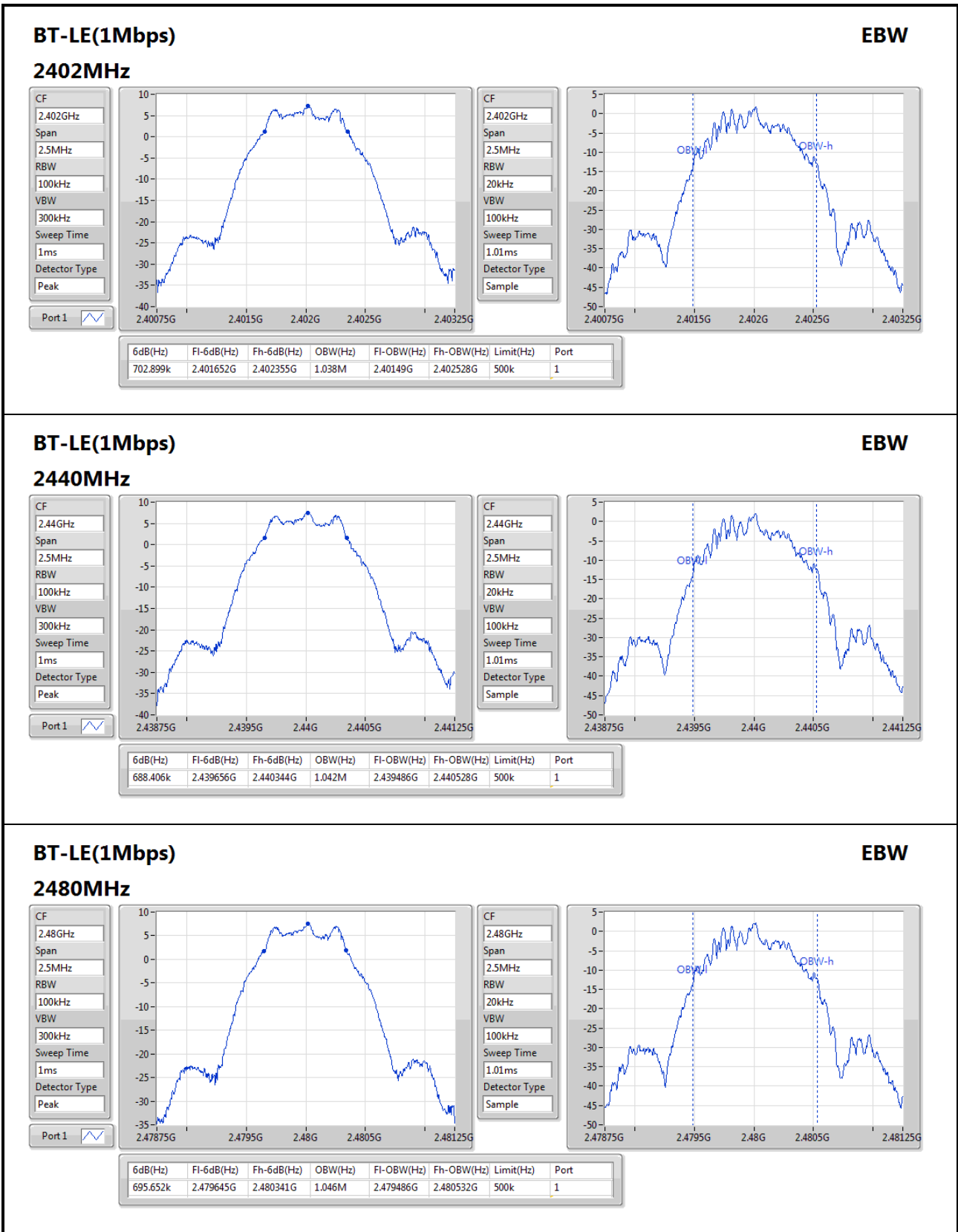

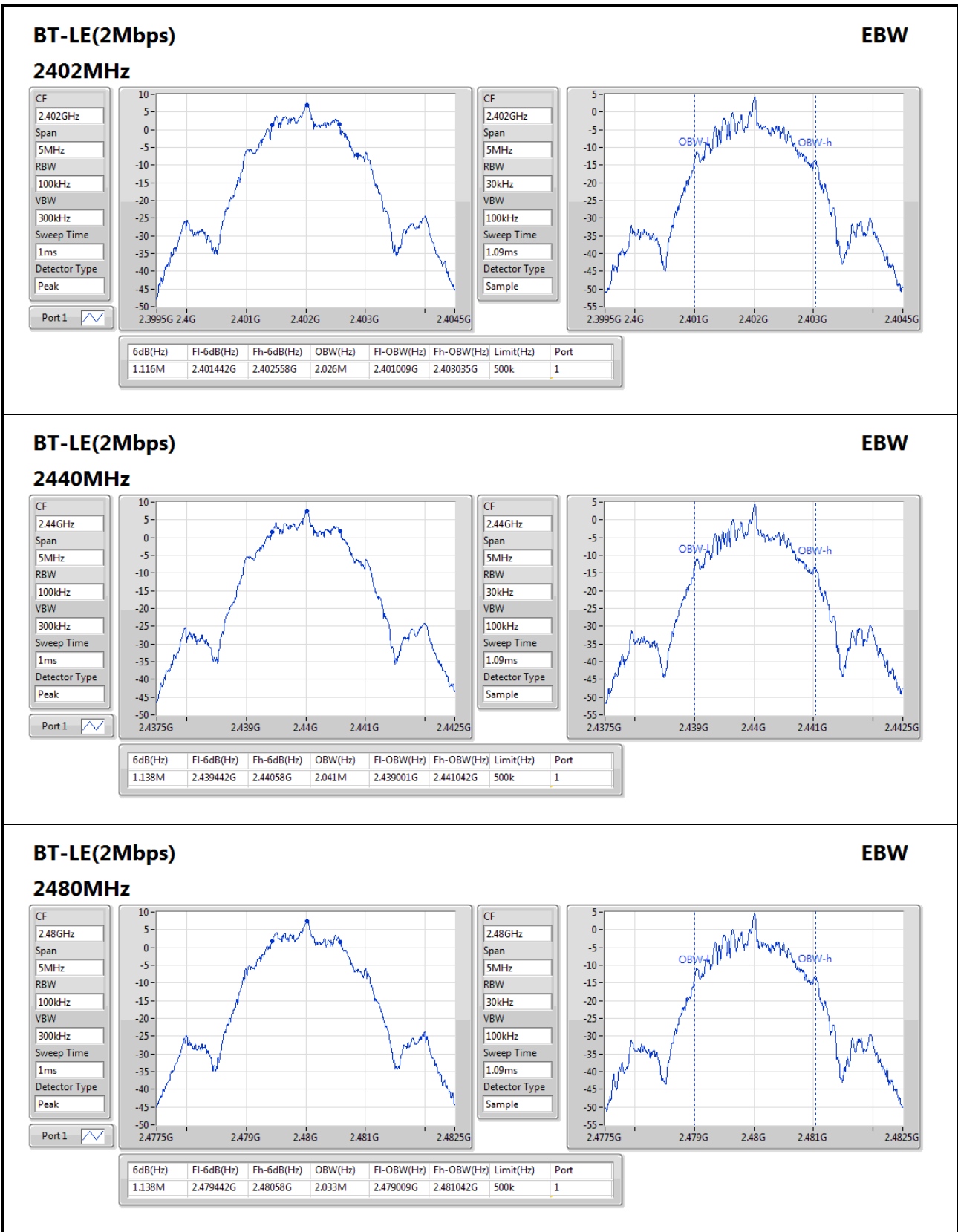

3.3 RF Output Power

3.3.1 Limit of RF Output Power

Conducted power shall not exceed 1Watt.

Antenna gain $\leq 6\text{dBi}$, no any corresponding reduction is in output power limit.

3.3.2 Test Procedures

A broadband RF power meter is used for output power measurement. The video bandwidth of power meter is greater than DTS bandwidth of EUT. If duty cycle of test signal is not 100 %, trigger and gating function of power meter will be enabled to capture transmission burst for measuring output power.

3.3.3 Test Setup

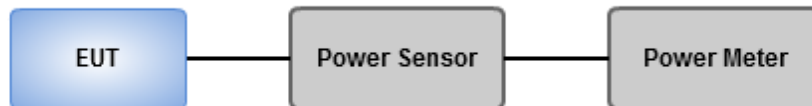

Test configuration 1: Low Power with Printed PCB antenna

3.3.4 Test Result of Maximum Output Power

Summary of Peak Conducted Output Power

Mode	Power (dBm)	Power (W)
2.4-2.4835GHz	-	-
BT-LE0.125_Nss1_1TX	-37.28	0.00000
BT-LE0.5_Nss1_1TX	-37.29	0.00000
BT-LE(1Mbps)	-37.40	0.00000
BT-LE(2Mbps)	-37.41	0.00000

Result

Mode	Result	Gain (dBi)	Power (dBm)	Power Limit (dBm)
BT-LE0.125_Nss1_1TX	-	-	-	-
2402MHz	Pass	2.00	-37.28	30.00
2440MHz	Pass	2.00	-37.44	30.00
2480MHz	Pass	2.00	-37.85	30.00
BT-LE0.5_Nss1_1TX	-	-	-	-
2402MHz	Pass	2.00	-37.29	30.00
2440MHz	Pass	2.00	-37.51	30.00
2480MHz	Pass	2.00	-37.88	30.00
BT-LE(1Mbps)	-	-	-	-
2402MHz	Pass	2.00	-37.40	30.00
2440MHz	Pass	2.00	-37.54	30.00
2480MHz	Pass	2.00	-37.91	30.00
BT-LE(2Mbps)	-	-	-	-
2402MHz	Pass	2.00	-37.41	30.00
2440MHz	Pass	2.00	-37.57	30.00
2480MHz	Pass	2.00	-37.91	30.00

Summary of Conducted (Average) Output Power

Mode	Power (dBm)	Power (W)
2.4-2.4835GHz	-	-
BT-LE0.125_Nss1_1TX	-37.40	0.00000
BT-LE0.5_Nss1_1TX	-37.41	0.00000
BT-LE(1Mbps)	-37.49	0.00000
BT-LE(2Mbps)	-37.51	0.00000

Result

Mode	Result	Gain (dBi)	Power (dBm)	Power Limit (dBm)
BT-LE0.125_Nss1_1TX	-	-	-	-
2402MHz	Pass	2.00	-37.40	-
2440MHz	Pass	2.00	-37.57	-
2480MHz	Pass	2.00	-37.96	-
BT-LE0.5_Nss1_1TX	-	-	-	-
2402MHz	Pass	2.00	-37.41	-
2440MHz	Pass	2.00	-37.61	-
2480MHz	Pass	2.00	-37.99	-
BT-LE(1Mbps)	-	-	-	-
2402MHz	Pass	2.00	-37.49	-
2440MHz	Pass	2.00	-37.64	-
2480MHz	Pass	2.00	-38.02	-
BT-LE(2Mbps)	-	-	-	-
2402MHz	Pass	2.00	-37.51	-
2440MHz	Pass	2.00	-37.68	-
2480MHz	Pass	2.00	-38.04	-

Note: Average power is for reference only.

Test configuration 2: High Power with Printed PCB antenna

3.3.5 Test Result of Maximum Output Power

Summary of Peak Conducted Output Power

Mode	Power (dBm)	Power (W)
2.4-2.4835GHz	-	-
BT-LE0.125_Nss1_1TX	8.03	0.00635
BT-LE0.5_Nss1_1TX	8.02	0.00634
BT-LE(1Mbps)	8.03	0.00635
BT-LE(2Mbps)	8.03	0.00635

Result

Mode	Result	Gain (dBi)	Power (dBm)	Power Limit (dBm)
BT-LE0.125_Nss1_1TX	-	-	-	-
2402MHz	Pass	2.00	7.71	30.00
2440MHz	Pass	2.00	7.88	30.00
2480MHz	Pass	2.00	8.03	30.00
BT-LE0.5_Nss1_1TX	-	-	-	-
2402MHz	Pass	2.00	7.71	30.00
2440MHz	Pass	2.00	7.88	30.00
2480MHz	Pass	2.00	8.02	30.00
BT-LE(1Mbps)	-	-	-	-
2402MHz	Pass	2.00	7.72	30.00
2440MHz	Pass	2.00	7.89	30.00
2480MHz	Pass	2.00	8.03	30.00
BT-LE(2Mbps)	-	-	-	-
2402MHz	Pass	2.00	7.71	30.00
2440MHz	Pass	2.00	7.88	30.00
2480MHz	Pass	2.00	8.03	30.00

Summary of Conducted (Average) Output Power

Mode	Power (dBm)	Power (W)
2.4-2.4835GHz	-	-
BT-LE0.125_Nss1_1TX	7.98	0.00628
BT-LE0.5_Nss1_1TX	7.97	0.00627
BT-LE(1Mbps)	7.98	0.00628
BT-LE(2Mbps)	7.97	0.00627

Result

Mode	Result	Gain (dBi)	Power (dBm)	Power Limit (dBm)
BT-LE0.125_Nss1_1TX	-	-	-	-
2402MHz	Pass	2.00	7.65	-
2440MHz	Pass	2.00	7.82	-
2480MHz	Pass	2.00	7.98	-
BT-LE0.5_Nss1_1TX	-	-	-	-
2402MHz	Pass	2.00	7.65	-
2440MHz	Pass	2.00	7.82	-
2480MHz	Pass	2.00	7.97	-
BT-LE(1Mbps)	-	-	-	-
2402MHz	Pass	2.00	7.65	-
2440MHz	Pass	2.00	7.83	-
2480MHz	Pass	2.00	7.98	-
BT-LE(2Mbps)	-	-	-	-
2402MHz	Pass	2.00	7.65	-
2440MHz	Pass	2.00	7.82	-
2480MHz	Pass	2.00	7.97	-

Note: Average power is for reference only.

3.4 Power Spectral Density

3.4.1 Limit of Power Spectral Density

Power spectral density shall not be greater than 8 dBm in any 3 kHz band.

3.4.2 Test Procedures

1. Set the RBW = 3 kHz, VBW = 10 kHz.
2. Detector = Peak, Sweep time = auto couple.
3. Trace mode = max hold, allow trace to fully stabilize.
4. Use the peak marker function to determine the maximum amplitude level.

3.4.3 Test Setup

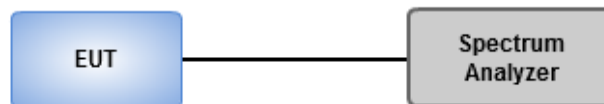

Test configuration 1: Low Power with Printed PCB antenna

3.4.4 Test Result of Power Spectral Density

Summary

Mode	PD (dBm/RBW)
2.4-2.4835GHz	-
BT-LE0.125_Nss1_1TX	-44.85
BT-LE0.5_Nss1_1TX	-45.04
BT-LE(1Mbps)	-54.14
BT-LE(2Mbps)	-56.48

Result

Mode	Result	Gain (dBi)	PD (dBm/RBW)	PD Limit (dBm/RBW)
BT-LE0.125_Nss1_1TX	-	-	-	-
2402MHz	Pass	2.00	-44.85	8.00
2440MHz	Pass	2.00	-45.01	8.00
2480MHz	Pass	2.00	-45.36	8.00
BT-LE0.5_Nss1_1TX	-	-	-	-
2402MHz	Pass	2.00	-45.04	8.00
2440MHz	Pass	2.00	-45.23	8.00
2480MHz	Pass	2.00	-45.60	8.00
BT-LE(1Mbps)	-	-	-	-
2402MHz	Pass	2.00	-54.14	8.00
2440MHz	Pass	2.00	-54.37	8.00
2480MHz	Pass	2.00	-54.76	8.00
BT-LE(2Mbps)	-	-	-	-
2402MHz	Pass	2.00	-56.48	8.00
2440MHz	Pass	2.00	-56.64	8.00
2480MHz	Pass	2.00	-57.08	8.00

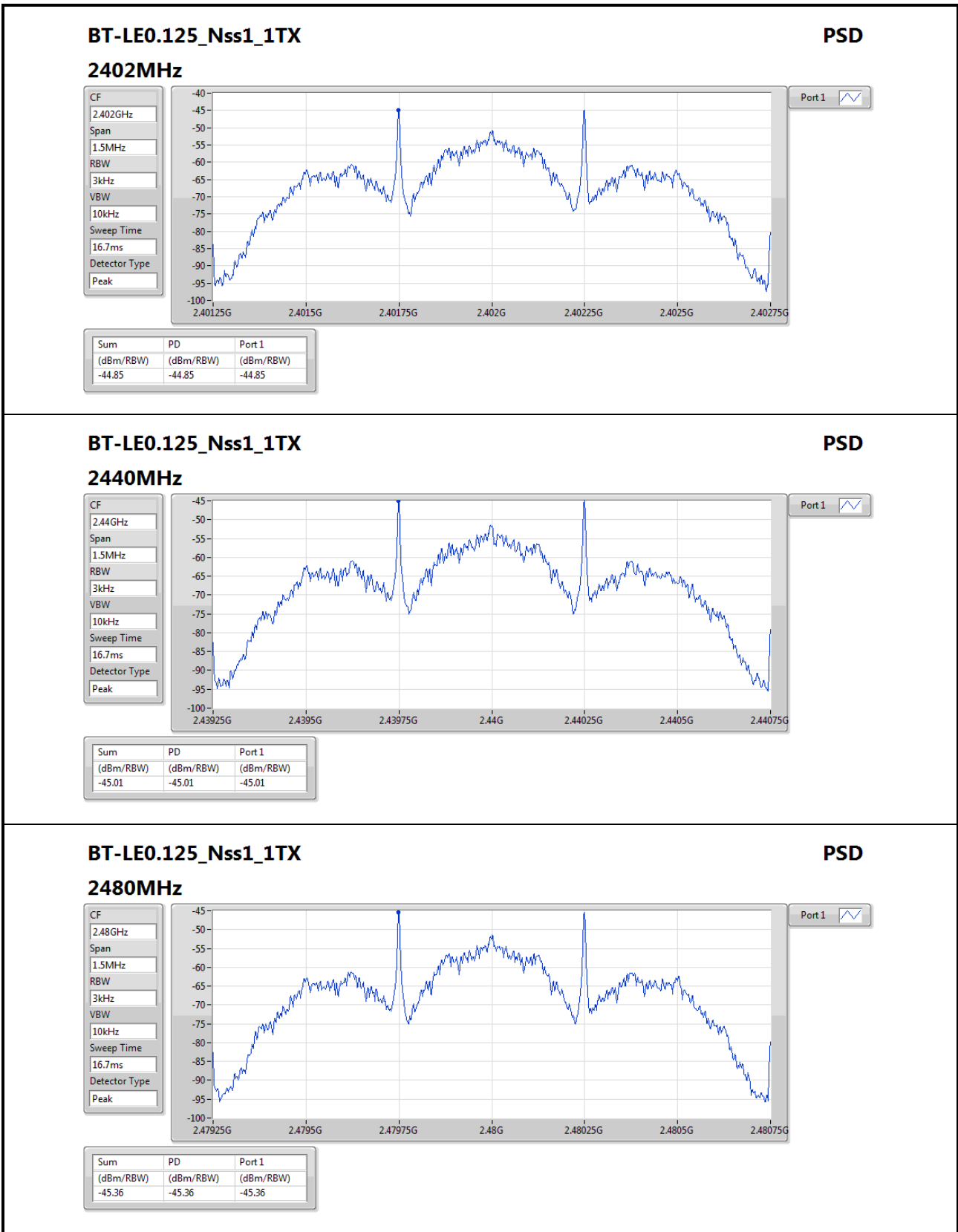

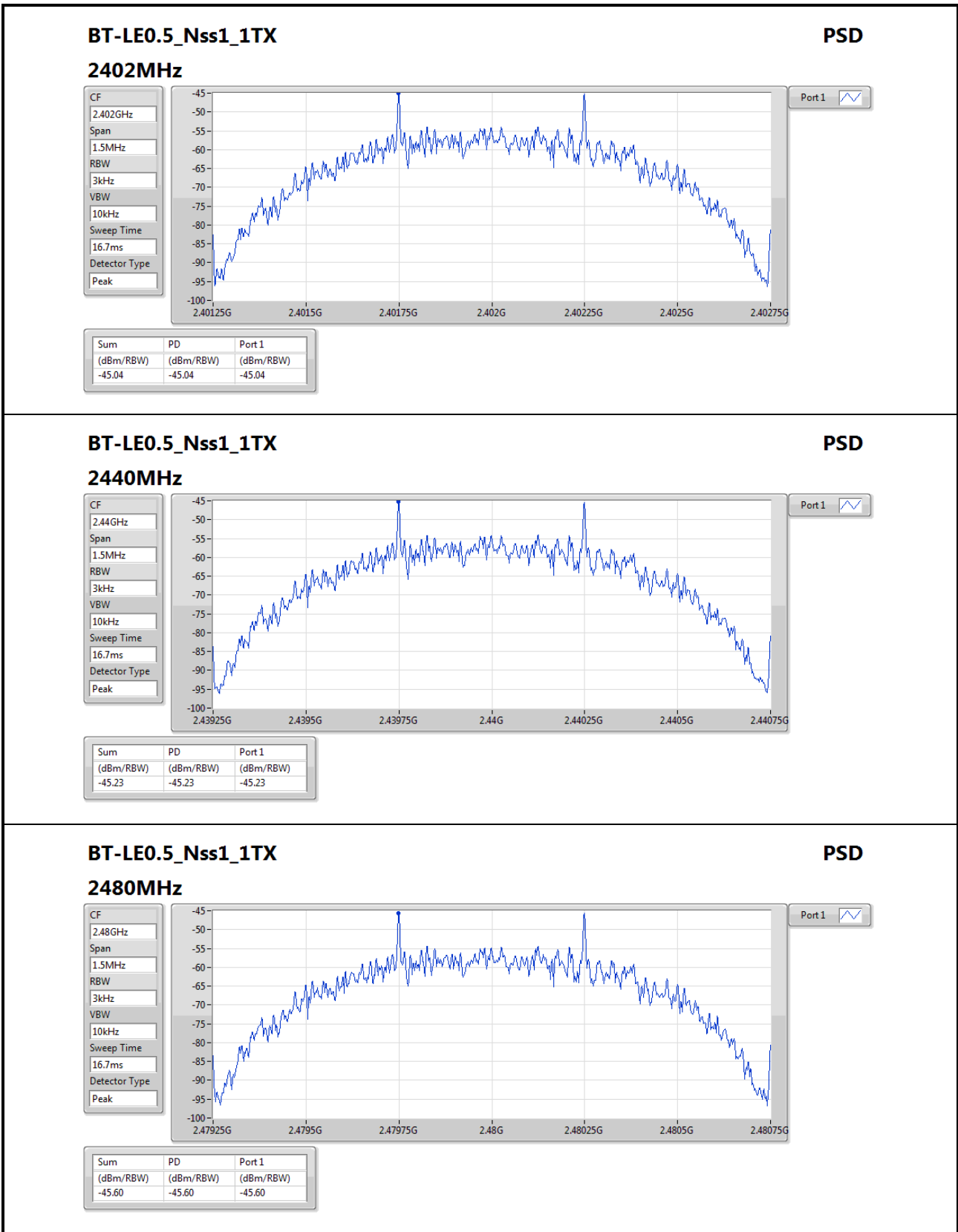

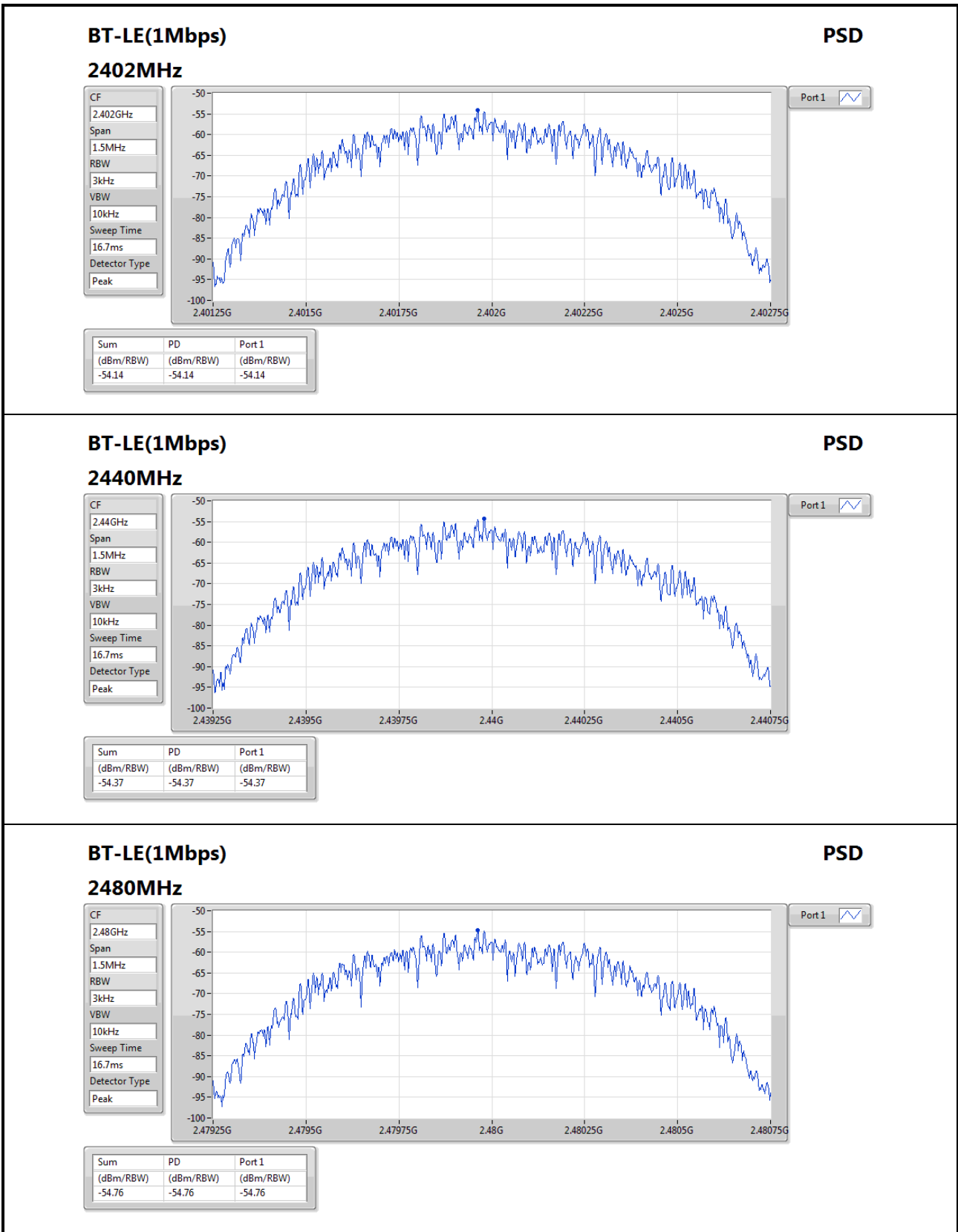

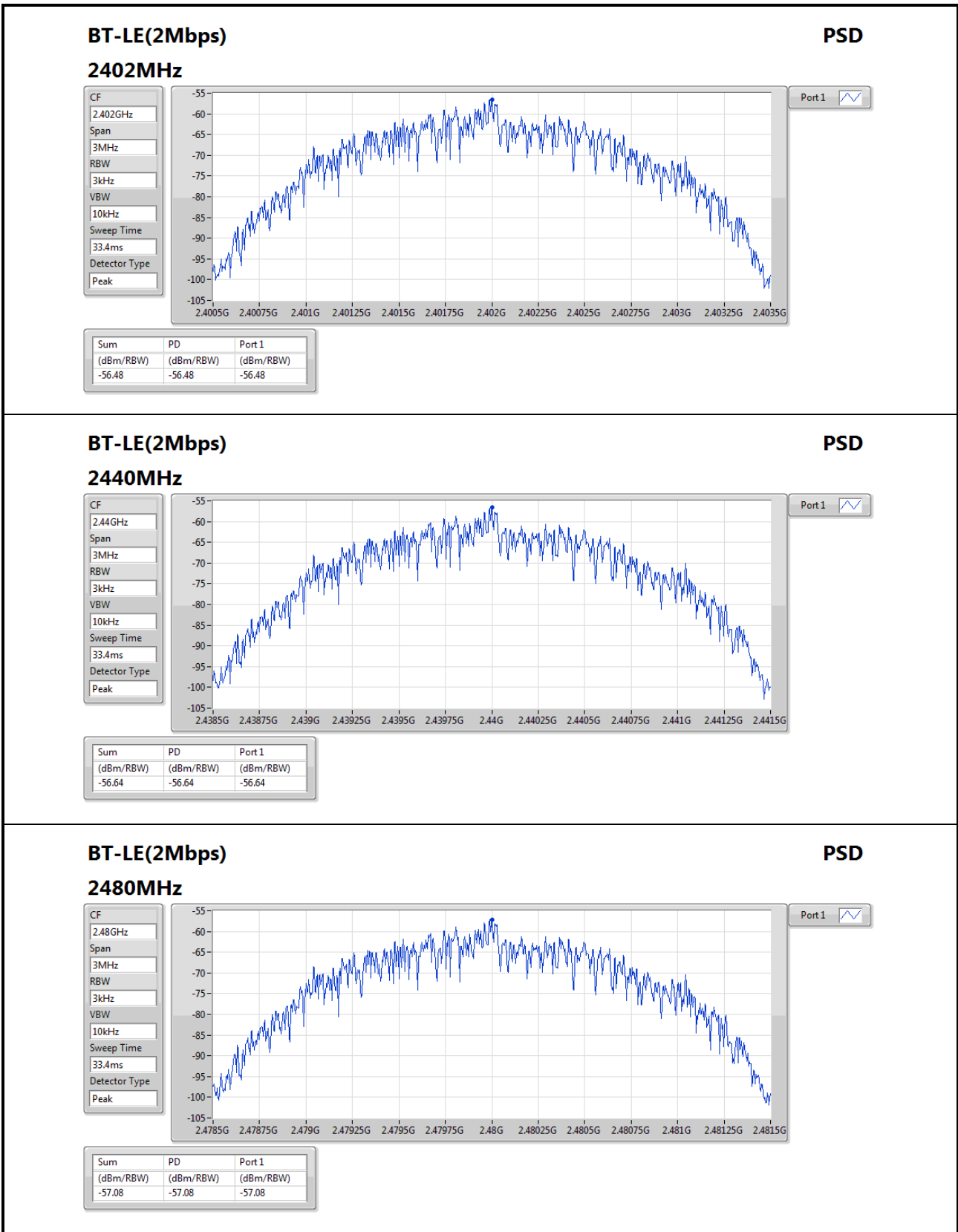

Test configuration 2: High Power with Printed PCB antenna

3.4.5 Test Result of Power Spectral Density

Summary

Mode	PD (dBm/RBW)
2.4-2.4835GHz	-
BT-LE0.125_Nss1_1TX	1.82
BT-LE0.5_Nss1_1TX	1.56
BT-LE(1Mbps)	-7.76
BT-LE(2Mbps)	-10.55

Result

Mode	Result	Gain (dBi)	PD (dBm/RBW)	PD Limit (dBm/RBW)
BT-LE0.125_Nss1_1TX	-	-	-	-
2402MHz	Pass	2.00	1.34	8.00
2440MHz	Pass	2.00	1.71	8.00
2480MHz	Pass	2.00	1.82	8.00
BT-LE0.5_Nss1_1TX	-	-	-	-
2402MHz	Pass	2.00	1.16	8.00
2440MHz	Pass	2.00	1.53	8.00
2480MHz	Pass	2.00	1.56	8.00
BT-LE(1Mbps)	-	-	-	-
2402MHz	Pass	2.00	-8.19	8.00
2440MHz	Pass	2.00	-7.88	8.00
2480MHz	Pass	2.00	-7.76	8.00
BT-LE(2Mbps)	-	-	-	-
2402MHz	Pass	2.00	-10.66	8.00
2440MHz	Pass	2.00	-10.55	8.00
2480MHz	Pass	2.00	-10.57	8.00

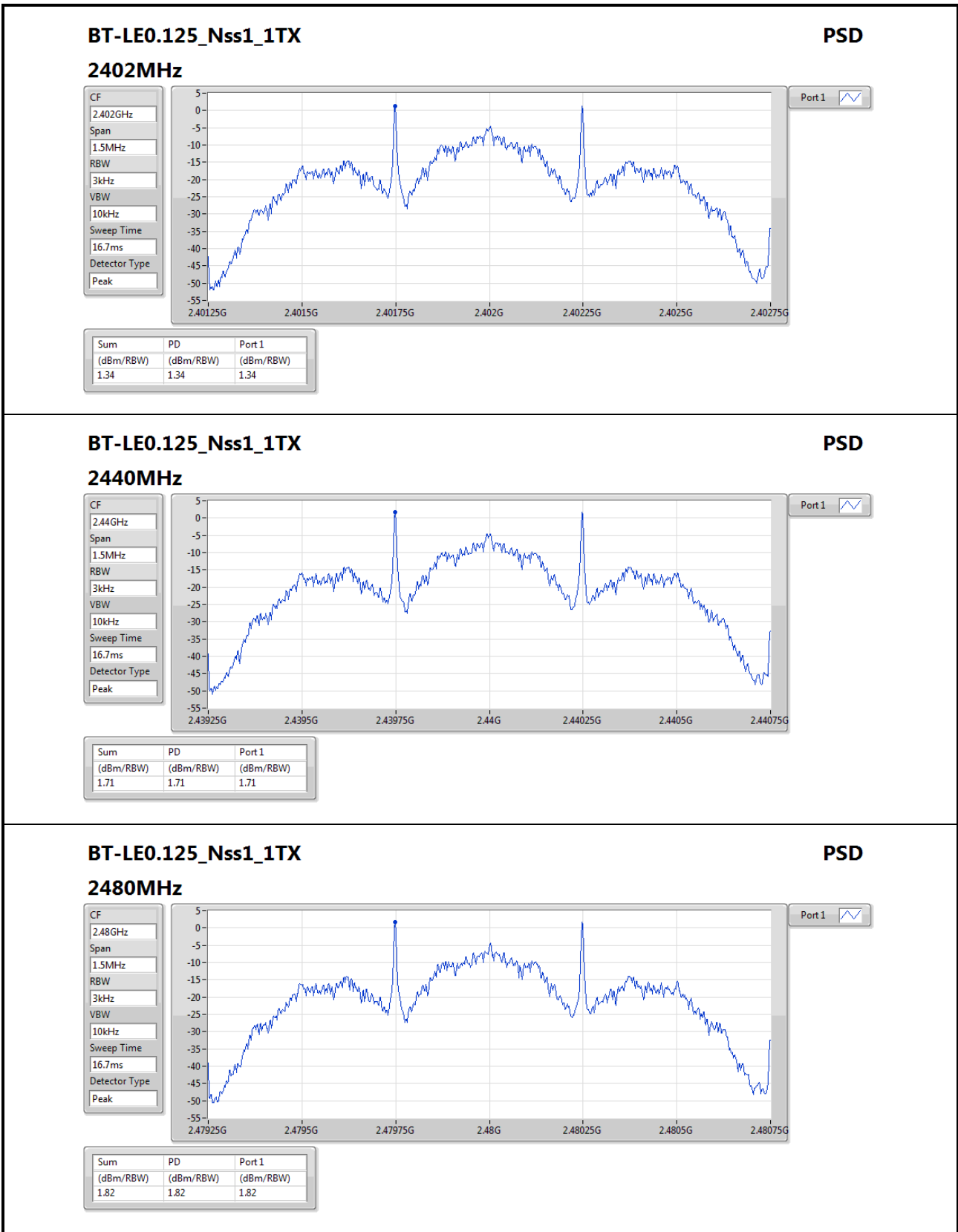

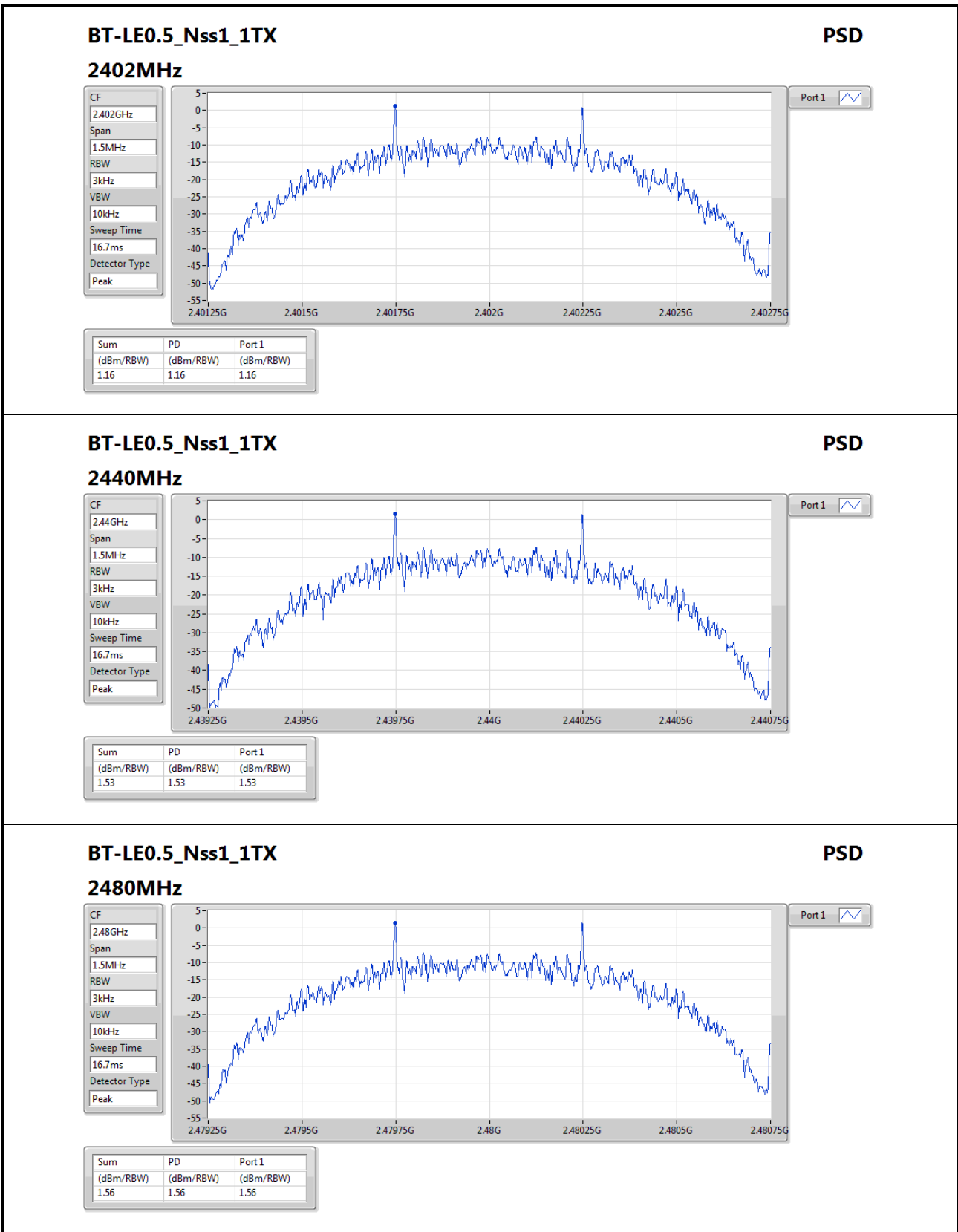

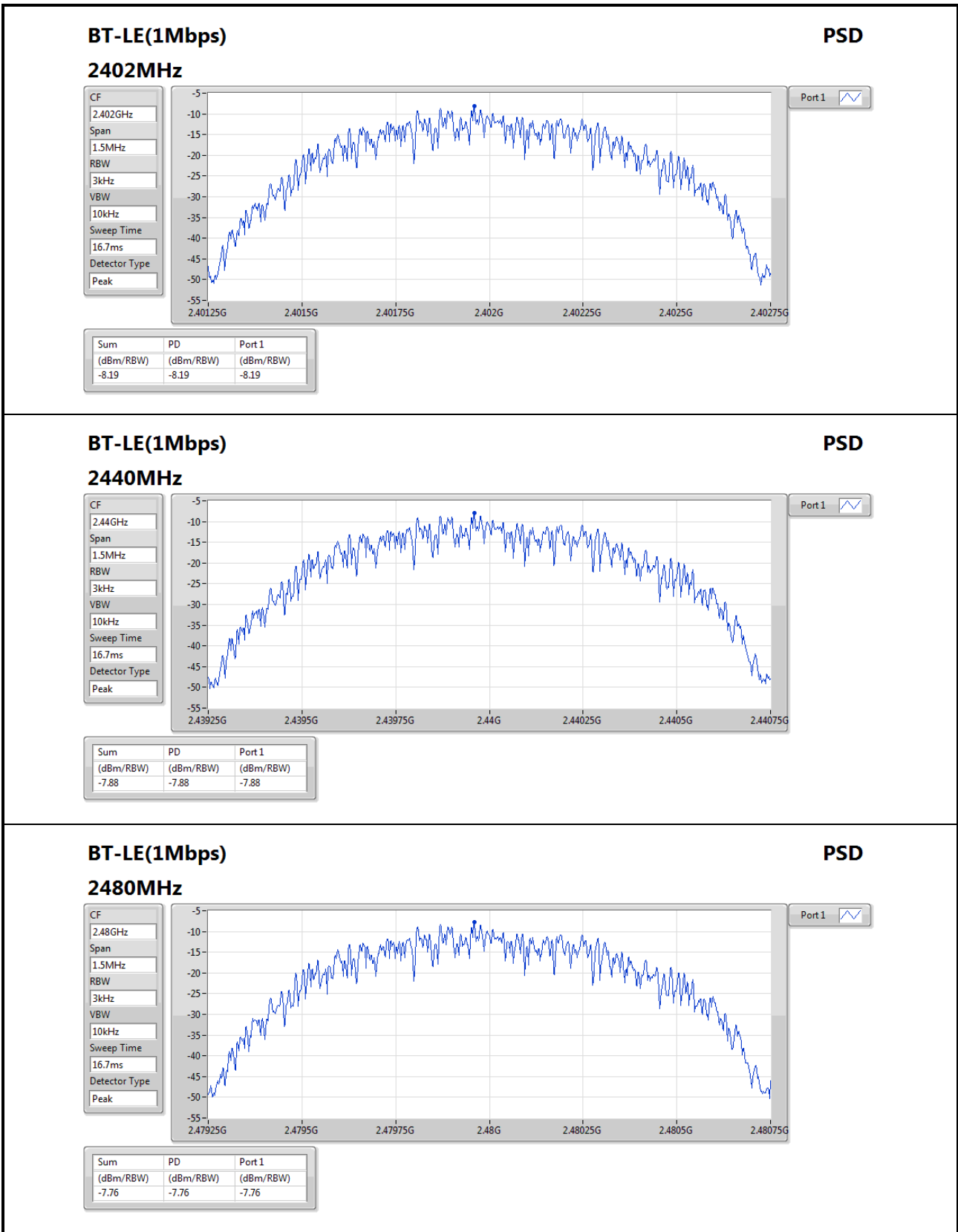

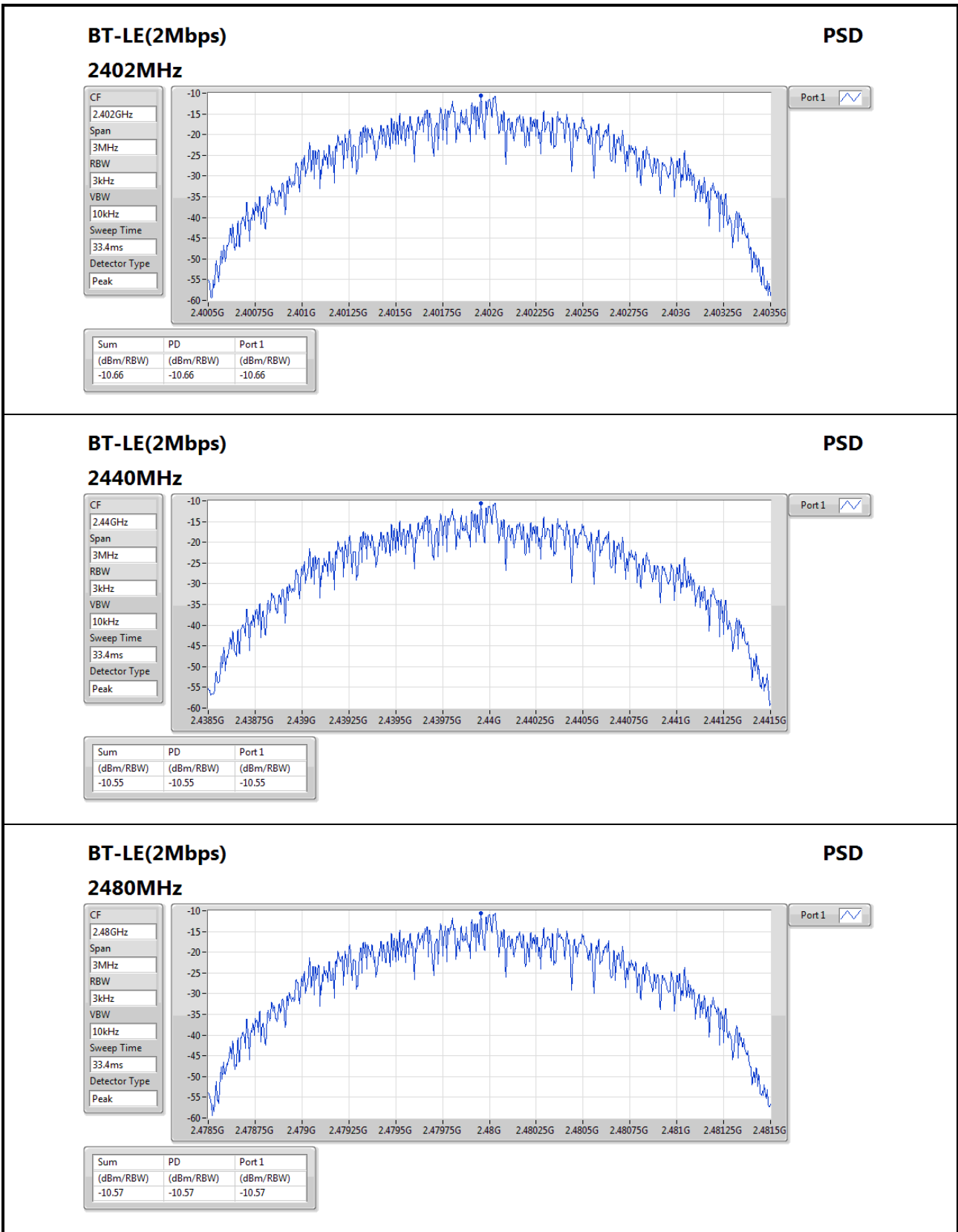

3.5 Emissions in Restricted Frequency Bands

3.5.1 Limit of Emissions in Restricted Frequency Bands

Restricted Band Emissions Limit			
Frequency Range (MHz)	Field Strength (uV/m)	Field Strength (dBuV/m)	Measure Distance (m)
0.009~0.490	2400/F(kHz)	48.5 - 13.8	300
0.490~1.705	24000/F(kHz)	33.8 - 23	30
1.705~30.0	30	29	30
30~88	100	40	3
88~216	150	43.5	3
216~960	200	46	3
Above 960	500	54	3

Note 1:
Quasi-Peak value is measured for frequency below 1GHz except for 9–90 kHz, 110–490 kHz frequency band. Peak and average value are measured for frequency above 1GHz. The limit on average radio frequency emission is as above table. The limit on peak radio frequency emissions is 20 dB above the maximum permitted average emission limit

Note 2:
Measurements may be performed at a distance other than what is specified provided. When performing measurements at a distance other than that specified, the results shall be extrapolated to the specified distance using an extrapolation factor as below, Frequency at or above 30 MHz: 20 dB/decade Frequency below 30 MHz: 40 dB/decade.

3.5.2 Test Procedures

1. Measurement is made at a semi-anechoic chamber that incorporates a turntable allowing a EUT rotation of 360°. A continuously-rotating, remotely-controlled turntable is installed at the test site to support the EUT and facilitate determination of the direction of maximum radiation for each EUT emission frequency. The EUT is placed at test table. For emissions testing at or below 1 GHz, the table height is 80 cm above the reference ground plane. For emission measurements above 1 GHz, the table height is 1.5 m
2. Measurement is made with the antenna positioned in both the horizontal and vertical planes of polarization. The measurement antenna is varied in height (1m ~ 4m) above the reference ground plane to obtain the maximum signal strength. Distance between EUT and antenna is 3 m.
3. This investigation is performed with the EUT rotated 360°, the antenna height scanned between 1 m and 4 m, and the antenna rotated to repeat the measurements for both the horizontal and vertical antenna polarizations.

Note:

1. 120kHz measurement bandwidth of test receiver and Quasi-peak detector is for radiated emission below 1GHz.
2. RBW=1MHz, VBW=3MHz and Peak detector is for peak measured value of radiated emission above 1GHz.
3. RBW=1MHz, VBW=1/T and Peak detector is for average measured value of radiated emission above 1GHz.

3.5.3 Test Setup

Radiated Emissions below 1 GHz

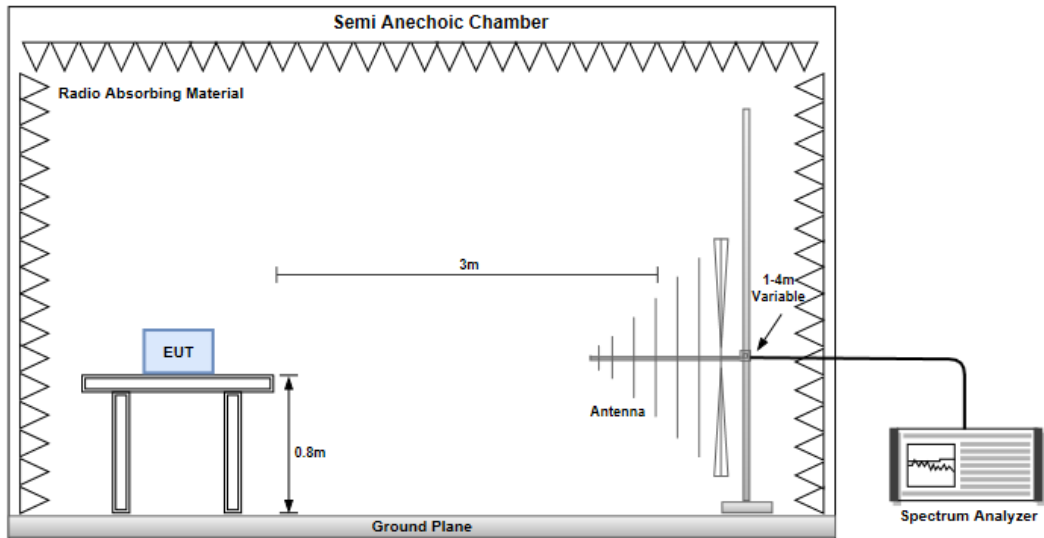

Radiated Emissions above 1 GHz

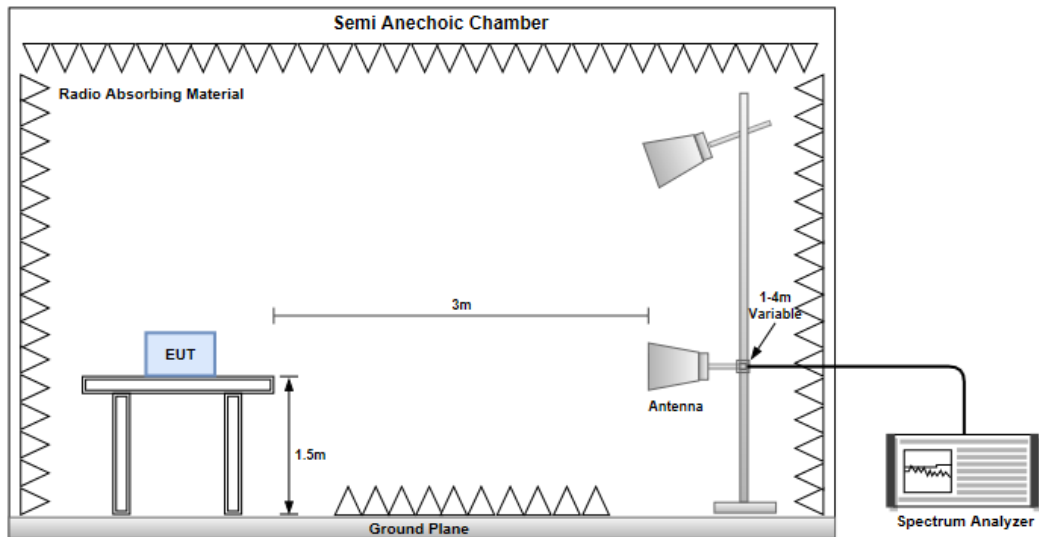

Conducted Emissions

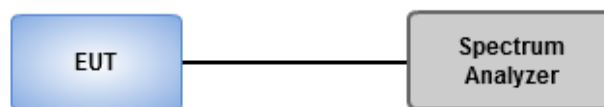

Test configuration 1: Low Power with Printed PCB antenna

3.5.4 Transmitter Radiated Unwanted Emissions (Below 1GHz)

Modulation	BT-LE (1Mbps)	Test Freq. (MHz)	2480
Polarization	Horizontal		

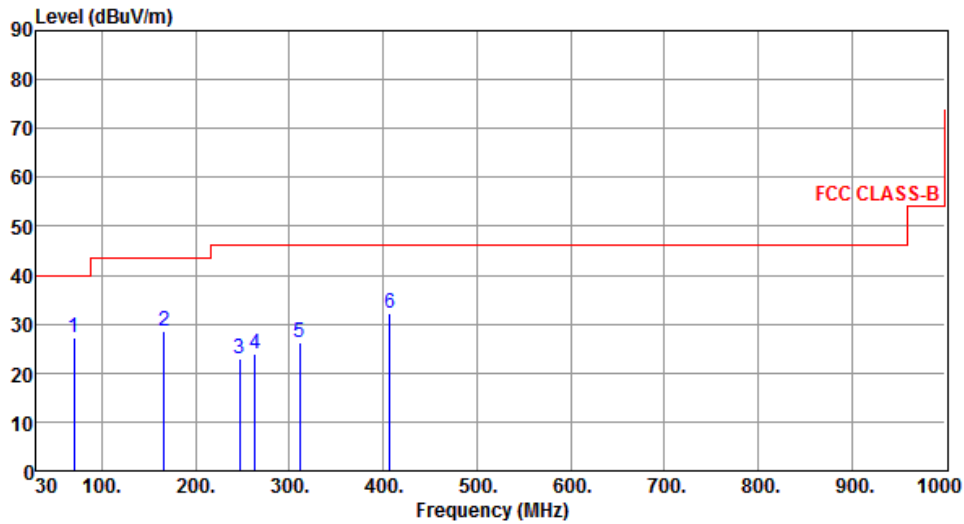

	Freq. MHz	Emission level dBuV/m	Limit dBuV/m	Margin dB	SA reading dBuV	Factor dB	Remark	ANT High cm	Turn Table deg
1	70.55	27.11	40.00	-12.89	37.81	-10.70	Peak	---	---
2	166.36	28.52	43.50	-14.98	37.22	-8.70	Peak	---	---
3	246.58	22.89	46.00	-23.11	32.86	-9.97	Peak	---	---
4	263.14	23.98	46.00	-22.02	33.40	-9.42	Peak	---	---
5	311.25	26.25	46.00	-19.75	33.94	-7.69	Peak	---	---
6	407.52	32.25	46.00	-13.75	37.63	-5.38	Peak	---	---

Note 1: Emission Level (dBuV/m) = SA Reading (dBuV/m) + Factor* (dB)

*Factor includes antenna factor , cable loss and amplifier gain

Note 2: Margin (dB) = Emission level (dBuV/m) – Limit (dBuV/m).

Note 3: All spurious emissions below 30MHz are more than 20 dB below the limit.

Modulation	BT-LE (1Mbps)	Test Freq. (MHz)	2480
Polarization	Vertical		

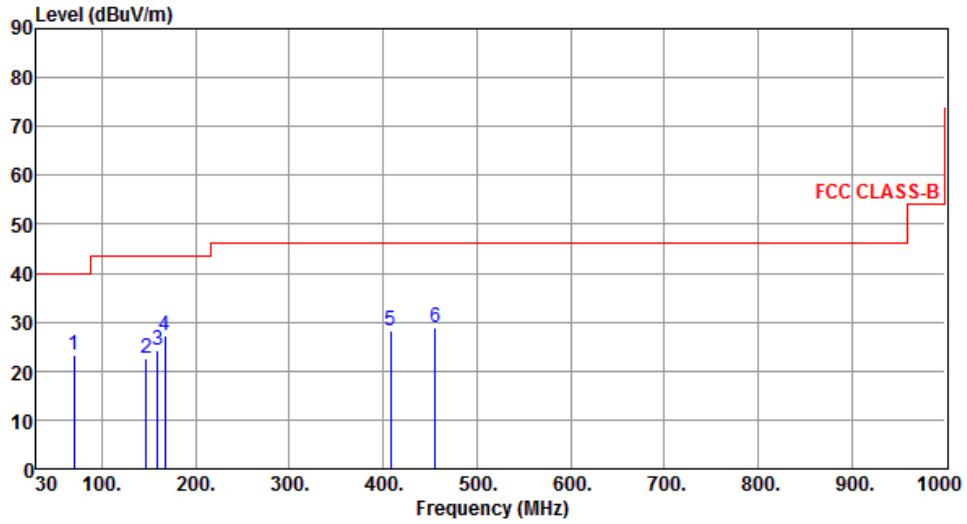

	Freq. MHz	Emission level dBuV/m	Limit dBuV/m	Margin dB	SA reading dBuV	Factor dB	Remark	ANT High cm	Turn Table deg
1	70.52	23.25	40.00	-16.75	33.94	-10.69	Peak	---	---
2	147.52	22.58	43.50	-20.92	31.03	-8.45	Peak	---	---
3	159.00	24.24	43.50	-19.26	32.56	-8.32	Peak	---	---
4	166.98	27.11	43.50	-16.39	35.81	-8.70	Peak	---	---
5	407.89	28.17	46.00	-17.83	33.54	-5.37	Peak	---	---
6	455.45	28.92	46.00	-17.08	32.89	-3.97	Peak	---	---

Note 1: Emission Level (dBuV/m) = SA Reading (dBuV/m) + Factor* (dB)

*Factor includes antenna factor , cable loss and amplifier gain

Note 2: Margin (dB) = Emission level (dBuV/m) – Limit (dBuV/m).

Note 3: All spurious emissions below 30MHz are more than 20 dB below the limit.

Modulation	BT-LE (2Mbps)	Test Freq. (MHz)	2480
Polarization	Horizontal		

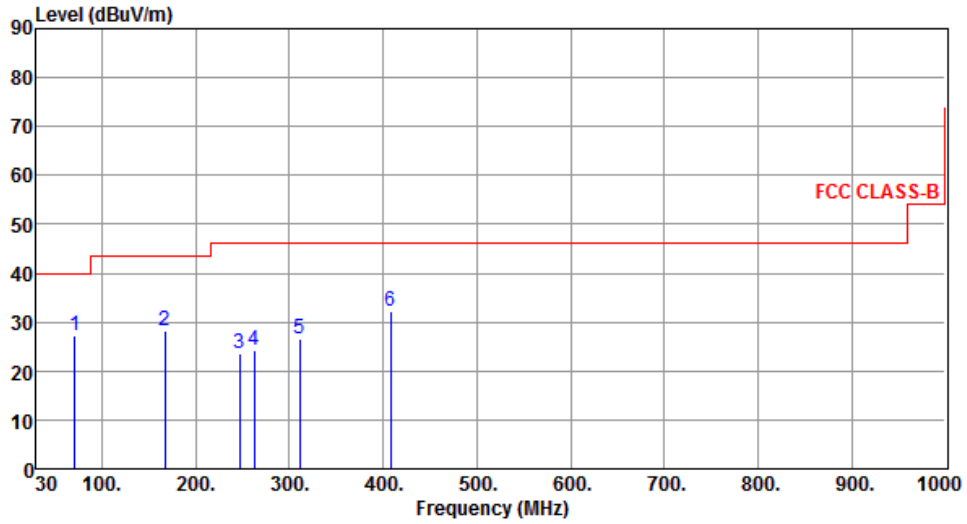

	Freq. MHz	Emission level dBuV/m	Limit dBuV/m	Margin dB	SA reading dBuV	Factor dB	Remark	ANT High cm	Turn Table deg
1	70.80	27.14	40.00	-12.86	37.87	-10.73	Peak	---	---
2	167.52	28.25	43.50	-15.25	36.95	-8.70	Peak	---	---
3	247.25	23.52	46.00	-22.48	33.48	-9.96	Peak	---	---
4	262.45	24.25	46.00	-21.75	33.71	-9.46	Peak	---	---
5	311.33	26.45	46.00	-19.55	34.14	-7.69	Peak	---	---
6	408.41	32.17	46.00	-13.83	37.53	-5.36	Peak	---	---

Note 1: Emission Level (dBuV/m) = SA Reading (dBuV/m) + Factor* (dB)

*Factor includes antenna factor , cable loss and amplifier gain

Note 2: Margin (dB) = Emission level (dBuV/m) – Limit (dBuV/m).

Note 3: All spurious emissions below 30MHz are more than 20 dB below the limit.

Modulation	BT-LE (2Mbps)	Test Freq. (MHz)	2480
Polarization	Vertical		

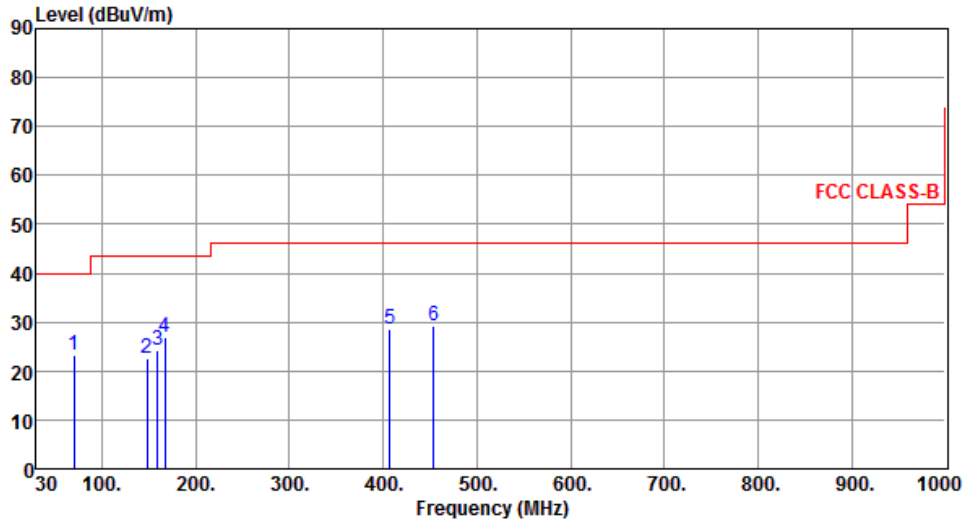

	Freq. MHz	Emission level dBuV/m	Limit dBuV/m	Margin dB	SA reading dBuV	Factor dB	Remark	ANT High cm	Turn Table deg
1	70.44	23.30	40.00	-16.70	33.99	-10.69	Peak	---	---
2	148.20	22.47	43.50	-21.03	30.92	-8.45	Peak	---	---
3	159.52	24.11	43.50	-19.39	32.48	-8.37	Peak	---	---
4	166.89	26.88	43.50	-16.62	35.58	-8.70	Peak	---	---
5	407.22	28.42	46.00	-17.58	33.82	-5.40	Peak	---	---
6	454.25	29.25	46.00	-16.75	33.25	-4.00	Peak	---	---

Note 1: Emission Level (dBuV/m) = SA Reading (dBuV/m) + Factor* (dB)

*Factor includes antenna factor , cable loss and amplifier gain

Note 2: Margin (dB) = Emission level (dBuV/m) – Limit (dBuV/m).

Note 3: All spurious emissions below 30MHz are more than 20 dB below the limit.

3.5.5 Transmitter Radiated Unwanted Emissions (Above 1GHz)

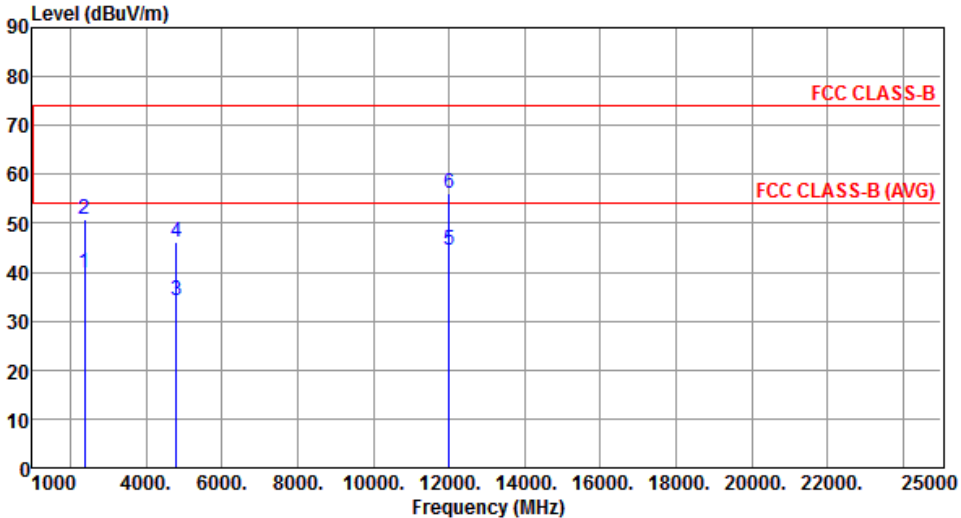
Modulation	BT-LE (1Mbps)	Test Freq. (MHz)	2402						
Polarization	Horizontal								
									
	Freq.	Emission level	Limit	Margin	SA reading	Factor	Remark	ANT High	Turn Table
	MHz	dBuV/m	dBuV/m	dB	dBuV	dB		cm	deg
1	2390.00	39.97	54.00	-14.03	42.77	-2.80	Average	100	187
2	2390.00	50.78	74.00	-23.22	53.58	-2.80	Peak	100	187
3	4804.00	34.21	54.00	-19.79	30.68	3.53	Average	100	201
4	4804.00	46.18	74.00	-27.82	42.65	3.53	Peak	100	201
5	12010.00	44.48	54.00	-9.52	30.76	13.72	Average	100	203
6	12010.00	56.28	74.00	-17.72	42.56	13.72	Peak	100	203
<p>Note 1: Emission Level (dBuV/m) = SA Reading (dBuV/m) + Factor* (dB) *Factor includes antenna factor , cable loss and amplifier gain Note 2: Margin (dB) = Emission level (dBuV/m) – Limit (dBuV/m).</p>									

Modulation	BT-LE (1Mbps)	Test Freq. (MHz)	2402
Polarization	Vertical		

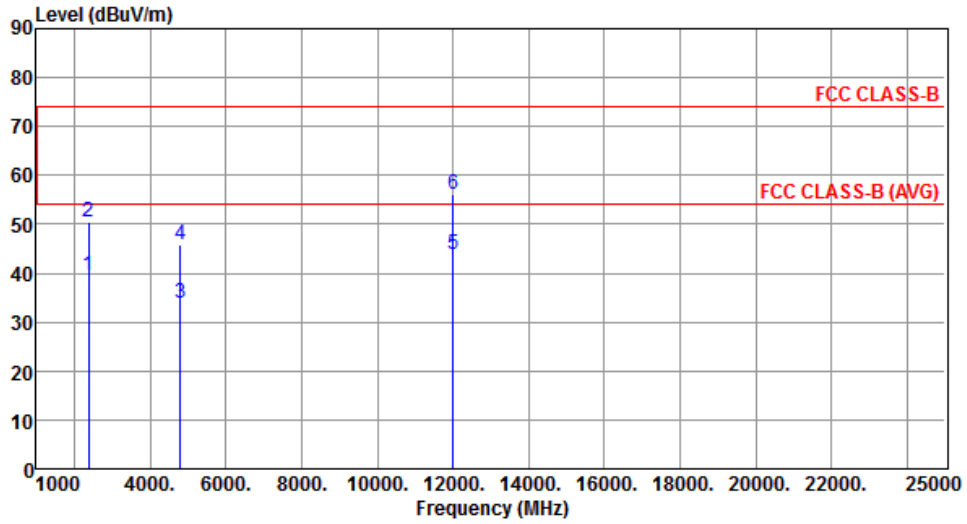

	Freq. MHz	Emission level dBuV/m	Limit dBuV/m	Margin dB	SA reading dBuV	Factor dB	Remark	ANT High cm	Turn Table deg
1	2390.00	39.57	54.00	-14.43	42.37	-2.80	Average	100	242
2	2390.00	50.60	74.00	-23.40	53.40	-2.80	Peak	100	242
3	4804.00	33.71	54.00	-20.29	30.18	3.53	Average	100	50
4	4804.00	45.71	74.00	-28.29	42.18	3.53	Peak	100	50
5	12010.00	43.92	54.00	-10.08	30.20	13.72	Average	100	49
6	12010.00	56.06	74.00	-17.94	42.34	13.72	Peak	100	49

Note 1: Emission Level (dBuV/m) = SA Reading (dBuV/m) + Factor* (dB)

*Factor includes antenna factor , cable loss and amplifier gain

Note 2: Margin (dB) = Emission level (dBuV/m) – Limit (dBuV/m).

Modulation	BT-LE (1Mbps)	Test Freq. (MHz)	2440
Polarization	Horizontal		

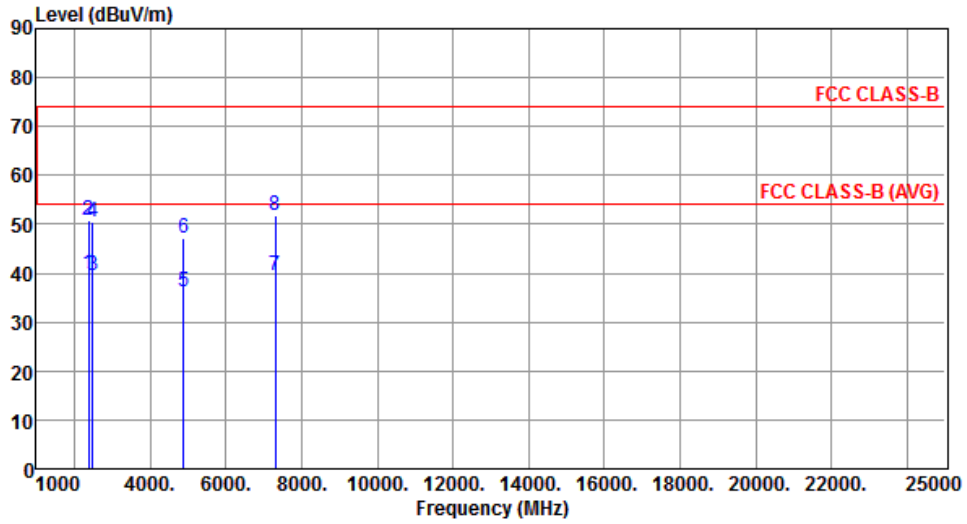

	Freq. MHz	Emission level dBuV/m	Limit dBuV/m	Margin dB	SA reading dBuV	Factor dB	Remark	ANT High cm	Turn Table deg
1	2390.00	39.86	54.00	-14.14	42.66	-2.80	Average	100	184
2	2390.00	50.76	74.00	-23.24	53.56	-2.80	Peak	100	184
3	2483.50	39.55	54.00	-14.45	42.58	-3.03	Average	100	184
4	2483.50	50.55	74.00	-23.45	53.58	-3.03	Peak	100	184
5	4880.00	36.35	54.00	-17.65	32.72	3.63	Average	100	192
6	4880.00	47.16	74.00	-26.84	43.53	3.63	Peak	100	192
7	7320.00	39.61	54.00	-14.39	30.39	9.22	Average	100	200
8	7320.00	51.85	74.00	-22.15	42.63	9.22	Peak	100	200

Note 1: Emission Level (dBuV/m) = SA Reading (dBuV/m) + Factor* (dB)

*Factor includes antenna factor , cable loss and amplifier gain

Note 2: Margin (dB) = Emission level (dBuV/m) – Limit (dBuV/m).

Modulation	BT-LE (1Mbps)	Test Freq. (MHz)	2440
Polarization	Vertical		

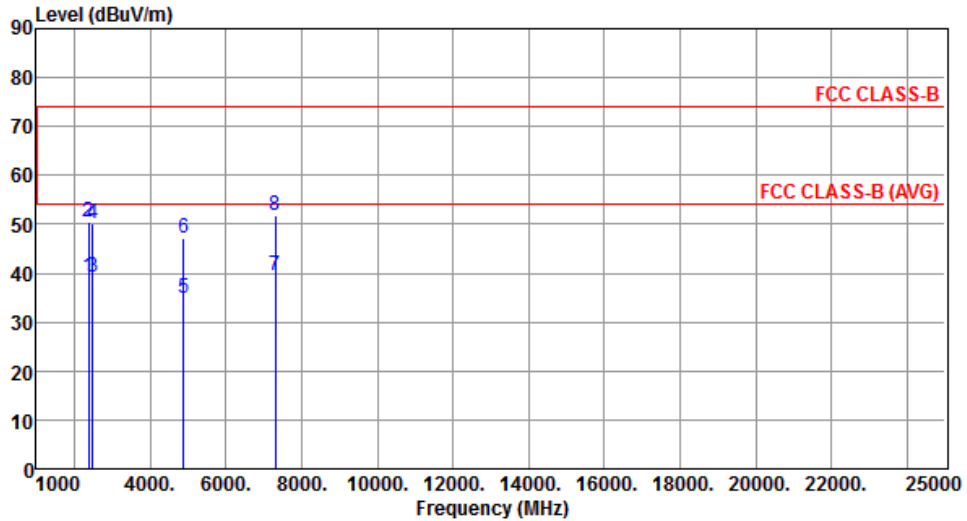

	Freq. MHz	Emission level dBuV/m	Limit dBuV/m	Margin dB	SA reading dBuV	Factor dB	Remark	ANT High cm	Turn Table deg
1	2390.00	39.28	54.00	-14.72	42.08	-2.80	Average	100	254
2	2390.00	50.45	74.00	-23.55	53.25	-2.80	Peak	100	254
3	2483.50	39.16	54.00	-14.84	42.19	-3.03	Average	100	254
4	2483.50	50.16	74.00	-23.84	53.19	-3.03	Peak	100	254
5	4880.00	34.93	54.00	-19.07	31.30	3.63	Average	100	51
6	4880.00	47.27	74.00	-26.73	43.64	3.63	Peak	100	51
7	7320.00	39.64	54.00	-14.36	30.42	9.22	Average	100	58
8	7320.00	51.80	74.00	-22.20	42.58	9.22	Peak	100	58

Note 1: Emission Level (dBuV/m) = SA Reading (dBuV/m) + Factor* (dB)

*Factor includes antenna factor , cable loss and amplifier gain

Note 2: Margin (dB) = Emission level (dBuV/m) – Limit (dBuV/m).

Modulation	BT-LE (1Mbps)	Test Freq. (MHz)	2480
Polarization	Horizontal		

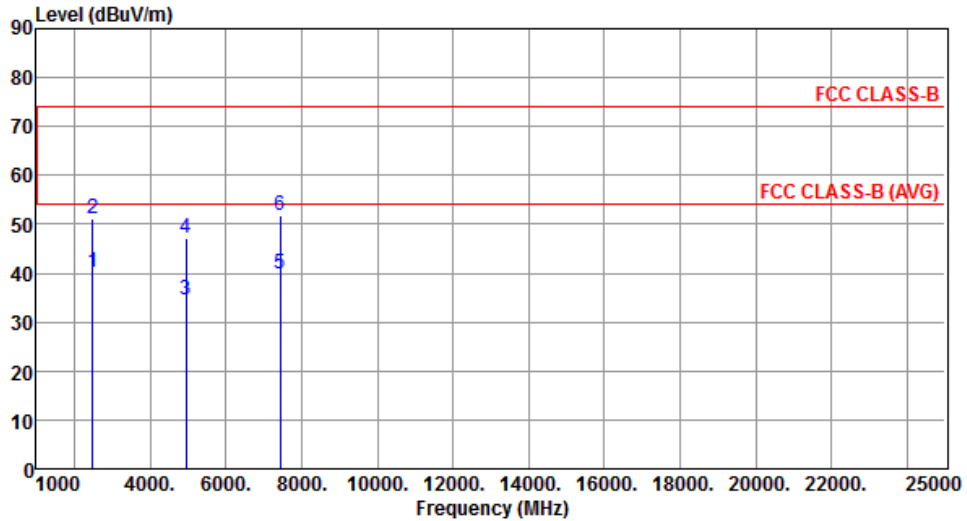

	Freq. MHz	Emission level dBuV/m	Limit dBuV/m	Margin dB	SA reading dBuV	Factor dB	Remark	ANT High cm	Turn Table deg
1	2483.50	40.08	54.00	-13.92	43.11	-3.03	Average	100	202
2	2483.50	51.15	74.00	-22.85	54.18	-3.03	Peak	100	202
3	4960.00	34.41	54.00	-19.59	30.58	3.83	Average	100	203
4	4960.00	47.31	74.00	-26.69	43.48	3.83	Peak	100	203
5	7440.00	39.84	54.00	-14.16	30.63	9.21	Average	100	202
6	7440.00	51.95	74.00	-22.05	42.74	9.21	Peak	100	202

Note 1: Emission Level (dBuV/m) = SA Reading (dBuV/m) + Factor* (dB)

*Factor includes antenna factor , cable loss and amplifier gain

Note 2: Margin (dB) = Emission level (dBuV/m) – Limit (dBuV/m).

Modulation	BT-LE (1Mbps)	Test Freq. (MHz)	2480
Polarization	Vertical		

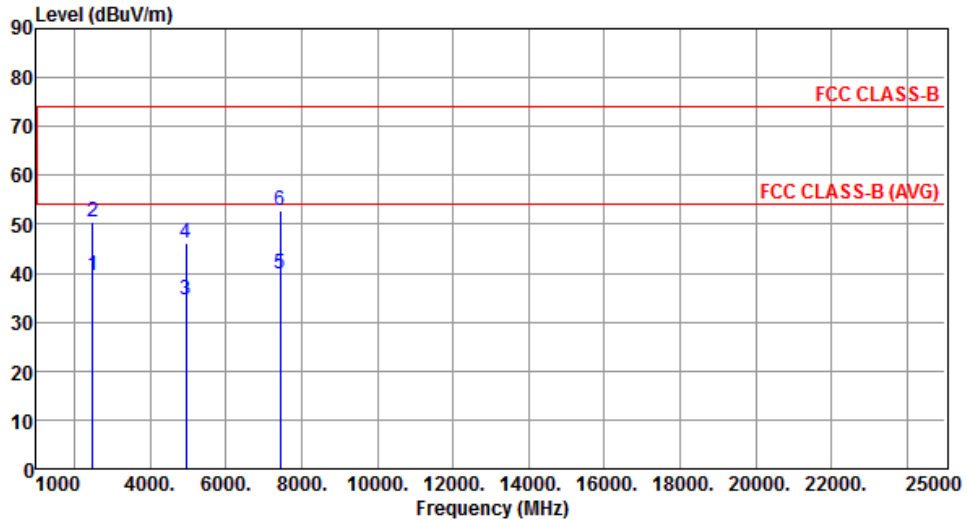

	Freq. MHz	Emission level dBuV/m	Limit dBuV/m	Margin dB	SA reading dBuV	Factor dB	Remark	ANT High cm	Turn Table deg
1	2483.50	39.63	54.00	-14.37	42.66	-3.03	Average	100	251
2	2483.50	50.62	74.00	-23.38	53.65	-3.03	Peak	100	251
3	4960.00	34.42	54.00	-19.58	30.59	3.83	Average	100	51
4	4960.00	46.19	74.00	-27.81	42.36	3.83	Peak	100	51
5	7440.00	39.78	54.00	-14.22	30.57	9.21	Average	100	54
6	7440.00	52.73	74.00	-21.27	43.52	9.21	Peak	100	54

Note 1: Emission Level (dBuV/m) = SA Reading (dBuV/m) + Factor* (dB)

*Factor includes antenna factor , cable loss and amplifier gain

Note 2: Margin (dB) = Emission level (dBuV/m) – Limit (dBuV/m).

Modulation	BT-LE (2Mbps)	Test Freq. (MHz)	2402
Polarization	Horizontal		

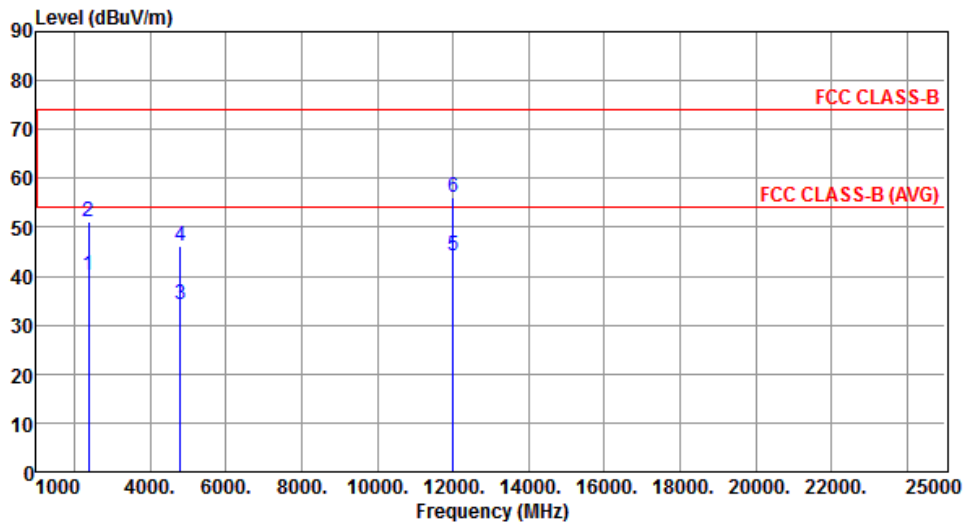

	Freq. MHz	Emission level dBuV/m	Limit dBuV/m	Margin dB	SA reading dBuV	Factor dB	Remark	ANT High cm	Turn Table deg
1	2390.00	40.04	54.00	-13.96	42.84	-2.80	Average	100	192
2	2390.00	51.01	74.00	-22.99	53.81	-2.80	Peak	100	192
3	4804.00	34.16	54.00	-19.84	30.63	3.53	Average	100	202
4	4804.00	46.15	74.00	-27.85	42.62	3.53	Peak	100	202
5	12010.00	44.22	54.00	-9.78	30.50	13.72	Average	100	203
6	12010.00	56.22	74.00	-17.78	42.50	13.72	Peak	100	203

Note 1: Emission Level (dBuV/m) = SA Reading (dBuV/m) + Factor* (dB)

*Factor includes antenna factor , cable loss and amplifier gain

Note 2: Margin (dB) = Emission level (dBuV/m) – Limit (dBuV/m).

Modulation	BT-LE (2Mbps)	Test Freq. (MHz)	2402
Polarization	Vertical		

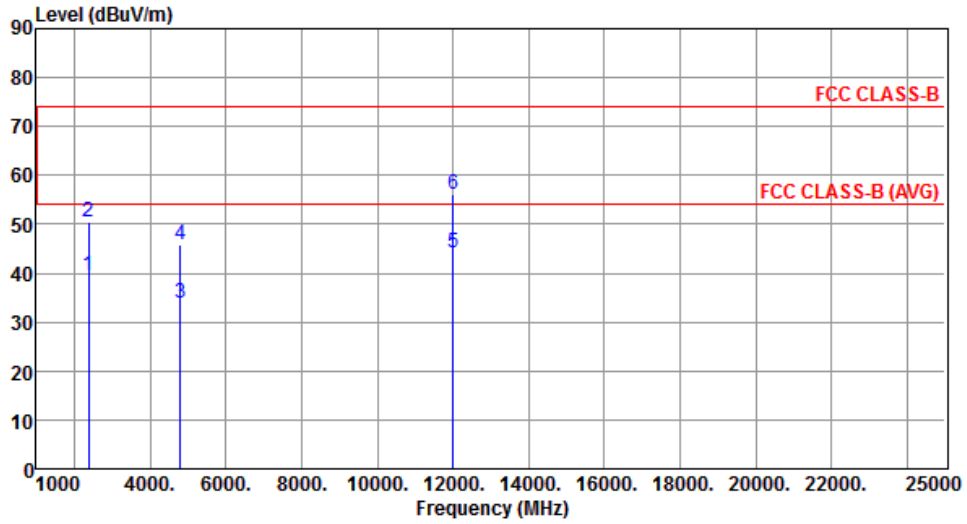

	Freq. MHz	Emission level dBuV/m	Limit dBuV/m	Margin dB	SA reading dBuV	Factor dB	Remark	ANT High cm	Turn Table deg
1	2390.00	39.39	54.00	-14.61	42.19	-2.80	Average	100	241
2	2390.00	50.56	74.00	-23.44	53.36	-2.80	Peak	100	241
3	4804.00	33.72	54.00	-20.28	30.19	3.53	Average	100	54
4	4804.00	45.72	74.00	-28.28	42.19	3.53	Peak	100	54
5	12010.00	44.12	54.00	-9.88	30.40	13.72	Average	100	57
6	12010.00	56.12	74.00	-17.88	42.40	13.72	Peak	100	57

Note 1: Emission Level (dBuV/m) = SA Reading (dBuV/m) + Factor* (dB)

*Factor includes antenna factor , cable loss and amplifier gain

Note 2: Margin (dB) = Emission level (dBuV/m) – Limit (dBuV/m).

Modulation	BT-LE (2Mbps)	Test Freq. (MHz)	2440
Polarization	Horizontal		

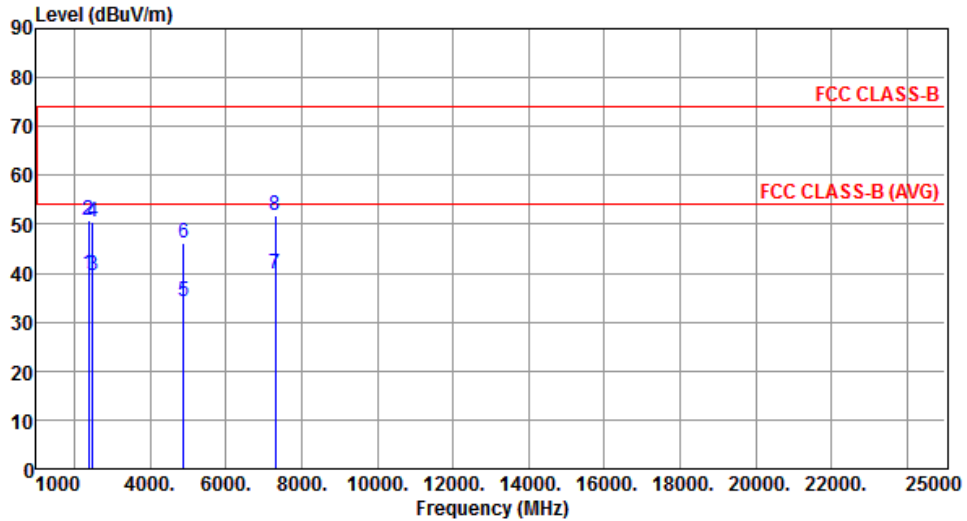

	Freq. MHz	Emission level dBuV/m	Limit dBuV/m	Margin dB	SA reading dBuV	Factor dB	Remark	ANT High cm	Turn Table deg
1	2390.00	39.69	54.00	-14.31	42.49	-2.80	Average	100	195
2	2390.00	50.72	74.00	-23.28	53.52	-2.80	Peak	100	195
3	2483.50	39.44	54.00	-14.56	42.47	-3.03	Average	100	195
4	2483.50	50.41	74.00	-23.59	53.44	-3.03	Peak	100	195
5	4880.00	34.23	54.00	-19.77	30.60	3.63	Average	100	209
6	4880.00	46.11	74.00	-27.89	42.48	3.63	Peak	100	209
7	7320.00	39.81	54.00	-14.19	30.59	9.22	Average	100	207
8	7320.00	51.90	74.00	-22.10	42.68	9.22	Peak	100	207

Note 1: Emission Level (dBuV/m) = SA Reading (dBuV/m) + Factor* (dB)

*Factor includes antenna factor , cable loss and amplifier gain

Note 2: Margin (dB) = Emission level (dBuV/m) – Limit (dBuV/m).

Modulation	BT-LE (2Mbps)	Test Freq. (MHz)	2440
Polarization	Vertical		

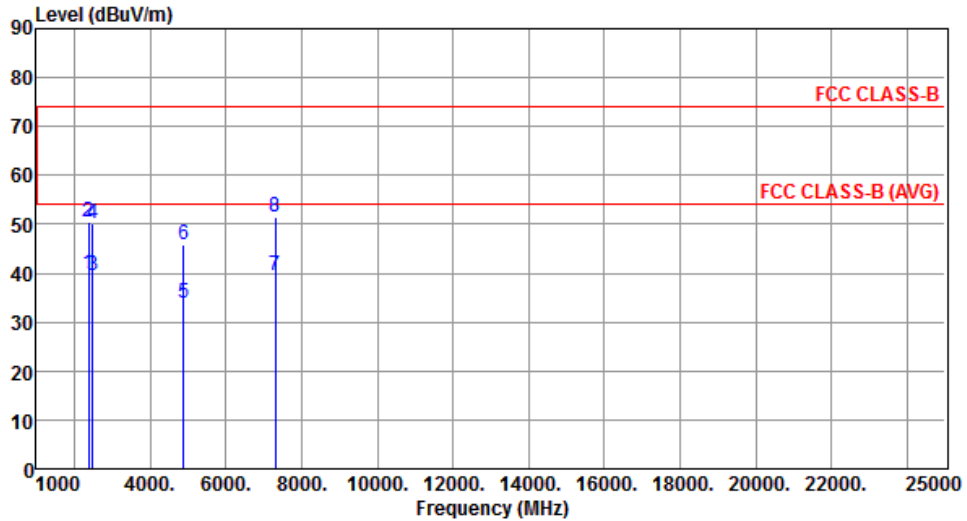

	Freq. MHz	Emission level dBuV/m	Limit dBuV/m	Margin dB	SA reading dBuV	Factor dB	Remark	ANT High cm	Turn Table deg
1	2390.00	39.69	54.00	-14.31	42.49	-2.80	Average	100	252
2	2390.00	50.37	74.00	-23.63	53.17	-2.80	Peak	100	252
3	2483.50	39.36	54.00	-14.64	42.39	-3.03	Average	100	252
4	2483.50	50.16	74.00	-23.84	53.19	-3.03	Peak	100	252
5	4880.00	34.03	54.00	-19.97	30.40	3.63	Average	100	53
6	4880.00	45.91	74.00	-28.09	42.28	3.63	Peak	100	53
7	7320.00	39.50	54.00	-14.50	30.28	9.22	Average	100	57
8	7320.00	51.52	74.00	-22.48	42.30	9.22	Peak	100	57

Note 1: Emission Level (dBuV/m) = SA Reading (dBuV/m) + Factor* (dB)

*Factor includes antenna factor , cable loss and amplifier gain

Note 2: Margin (dB) = Emission level (dBuV/m) – Limit (dBuV/m).

Modulation	BT-LE (2Mbps)	Test Freq. (MHz)	2480
Polarization	Horizontal		

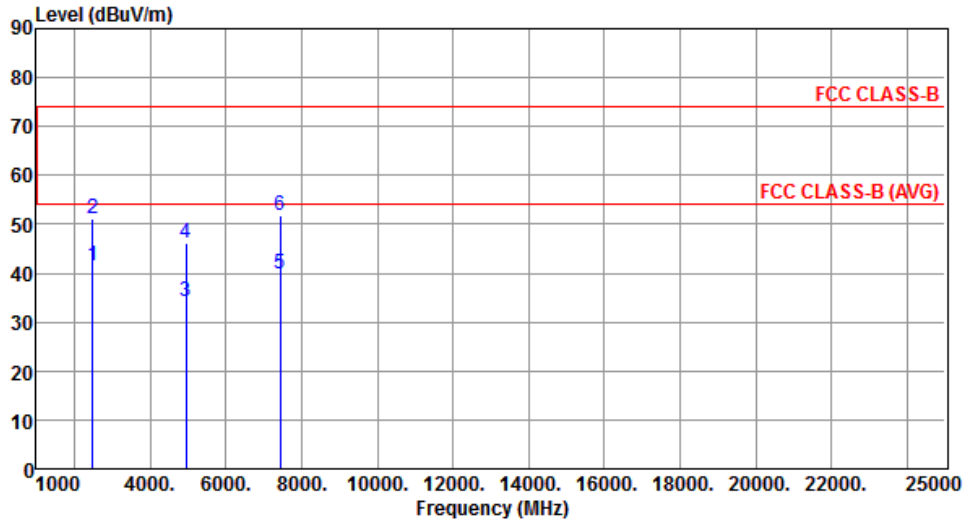

	Freq. MHz	Emission level dBuV/m	Limit dBuV/m	Margin dB	SA reading dBuV	Factor dB	Remark	ANT High cm	Turn Table deg
1	2483.50	41.35	54.00	-12.65	44.38	-3.03	Average	100	185
2	2483.50	51.26	74.00	-22.74	54.29	-3.03	Peak	100	185
3	4960.00	34.31	54.00	-19.69	30.48	3.83	Average	100	204
4	4960.00	46.28	74.00	-27.72	42.45	3.83	Peak	100	204
5	7440.00	39.80	54.00	-14.20	30.59	9.21	Average	100	206
6	7440.00	51.80	74.00	-22.20	42.59	9.21	Peak	100	206

Note 1: Emission Level (dBuV/m) = SA Reading (dBuV/m) + Factor* (dB)

*Factor includes antenna factor , cable loss and amplifier gain

Note 2: Margin (dB) = Emission level (dBuV/m) – Limit (dBuV/m).

Modulation	BT-LE (2Mbps)	Test Freq. (MHz)	2480
Polarization	Vertical		

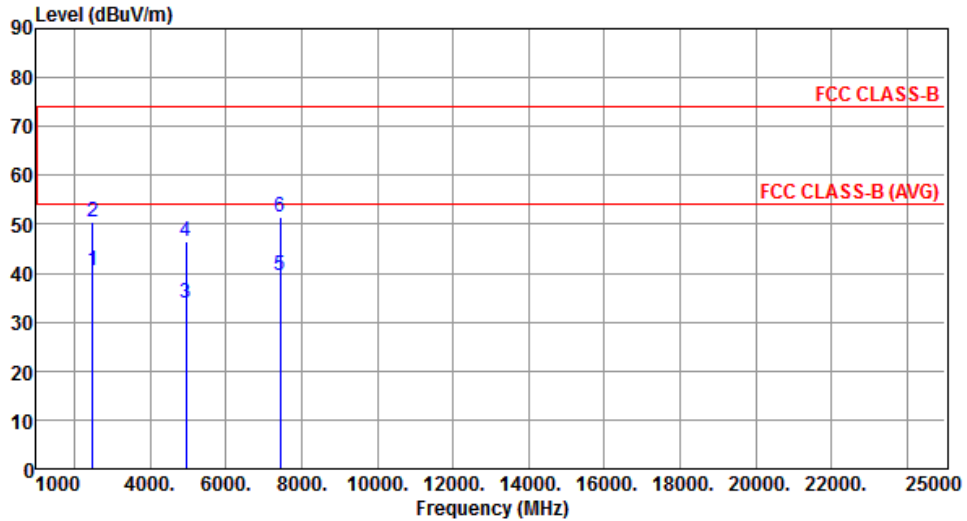

	Freq. MHz	Emission level dBuV/m	Limit dBuV/m	Margin dB	SA reading dBuV	Factor dB	Remark	ANT High cm	Turn Table deg
1	2483.50	40.52	54.00	-13.48	43.55	-3.03	Average	100	251
2	2483.50	50.42	74.00	-23.58	53.45	-3.03	Peak	100	251
3	4960.00	34.02	54.00	-19.98	30.19	3.83	Average	100	55
4	4960.00	46.35	74.00	-27.65	42.52	3.83	Peak	100	55
5	7440.00	39.46	54.00	-14.54	30.25	9.21	Average	100	53
6	7440.00	51.54	74.00	-22.46	42.33	9.21	Peak	100	53

Note 1: Emission Level (dBuV/m) = SA Reading (dBuV/m) + Factor* (dB)

*Factor includes antenna factor , cable loss and amplifier gain

Note 2: Margin (dB) = Emission level (dBuV/m) – Limit (dBuV/m).

3.5.6 Transmitter Conducted Unwanted Emissions (Below 1 GHz)

Modulation Mode		BT LE-1Mbps		Frequency		2480MHz	
Range (MHz)	Max Value chain0 (dBm)	DG (dBi)	GRF (dB)	EIRP (dBm)	E-Field (dBuV/m)	Min E-Field Limit (dBuV/m)	E-Field Margin (dB)
30~1000	-91.30	2.00	4.70	-84.60	10.66	40.00	-29.34

Modulation Mode		BT LE-2Mbps		Frequency		2480MHz	
Range (MHz)	Max Value chain0 (dBm)	DG (dBi)	GRF (dB)	EIRP (dBm)	E-Field (dBuV/m)	Min E-Field Limit (dBuV/m)	E-Field Margin (dB)
30~1000	-91.80	2.00	4.70	-85.10	10.16	40.00	-29.84

Note:

1. GRF = Ground Reflection Factor.
2. DG = Directional Gain.
3. Worst case of emission limit below 1GHz is selected to be limit.

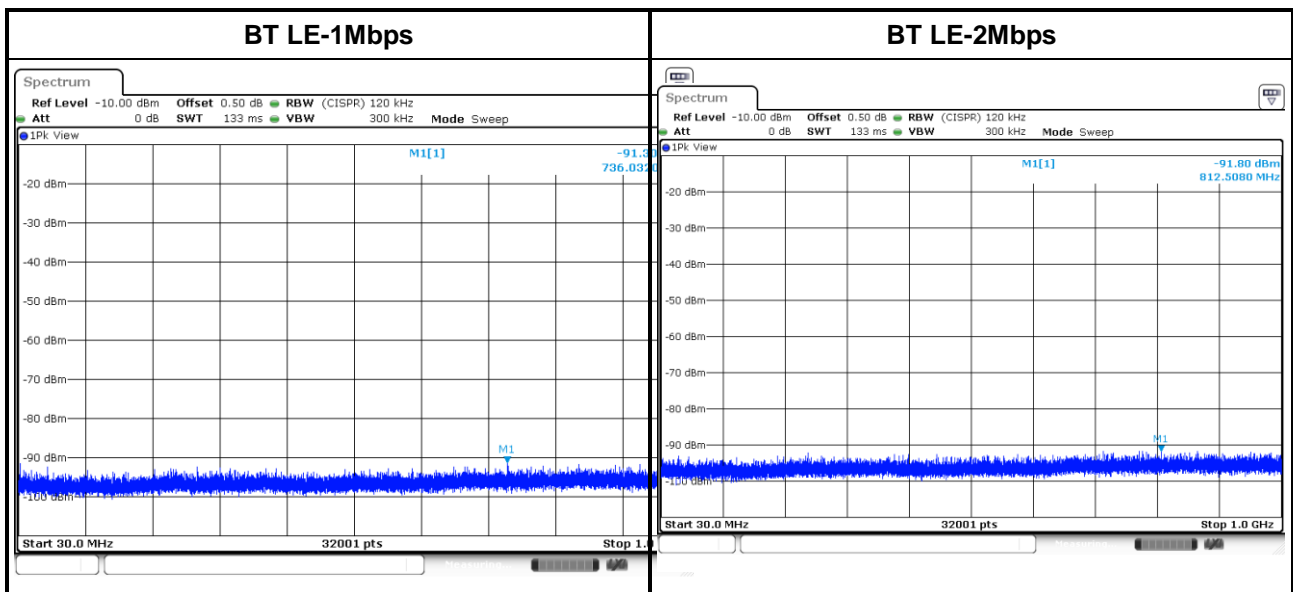

3.5.7 Transmitter Conducted Unwanted Emissions (Above 1GHz) in Band Edge

Transmitter Conducted Unwanted Emissions Results in Band Edge								
Modulation Mode		BT LE-1Mbps						
Test ch. Freq. (MHz)	Range (MHz)	Max Value chain0 (dBm)	DG (dBi)	EIRP (dBm)	E-Field (dBuV/m)	E-Field Limit (dBuV/m)	E-Field Margin (dB)	Remark
2402	2310~2390	-75.12	2.00	-73.12	22.14	74.00	-51.86	PK
	2310~2390	-93.42	2.00	-91.42	3.84	54.00	-50.16	AV
	2483.5~2690	-77.08	2.00	-75.08	20.18	74.00	-53.82	PK
	2483.5~2690	-90.15	2.00	-88.15	7.11	54.00	-46.89	AV
2440	2310~2390	-80.61	2.00	-78.61	16.65	74.00	-57.35	PK
	2310~2390	-93.11	2.00	-91.11	4.15	54.00	-49.85	AV
	2483.5~2500	-78.61	2.00	-76.61	18.65	74.00	-55.35	PK
	2483.5~2500	-93.14	2.00	-91.14	4.12	54.00	-49.88	AV
2480	2310~2390	-80.27	2.00	-78.27	16.99	74.00	-57.01	PK
	2310~2390	-93.18	2.00	-91.18	4.08	54.00	-49.92	AV
	2483.5~2690	-65.70	2.00	-63.70	31.56	74.00	-42.44	PK
	2483.5~2690	-92.50	2.00	-90.50	4.76	54.00	-49.24	AV

Note: DG = Directional Gain.

Band Edge Test Plot

2402MHz - AV

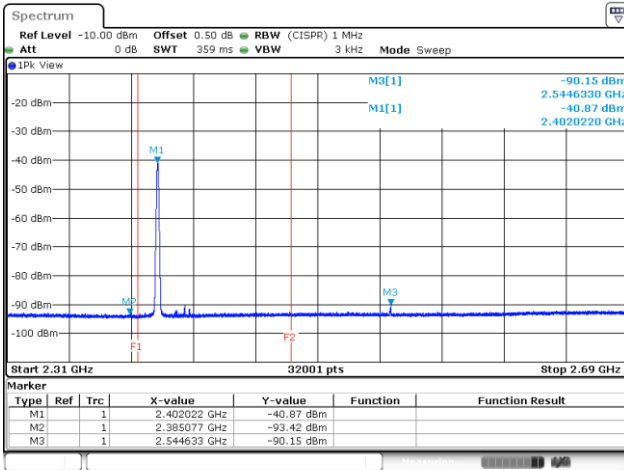

2402MHz - PK

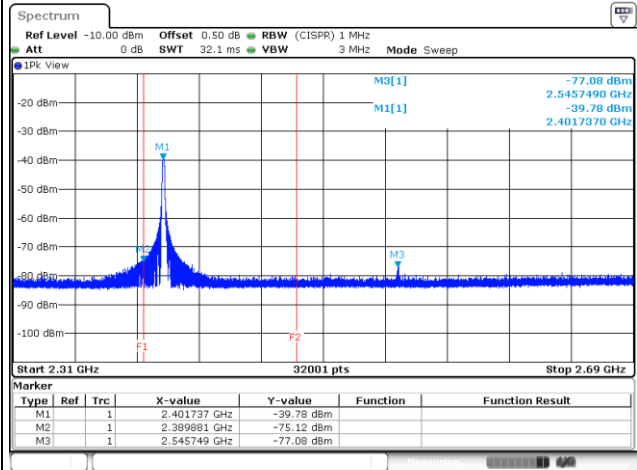

2440MHz - AV

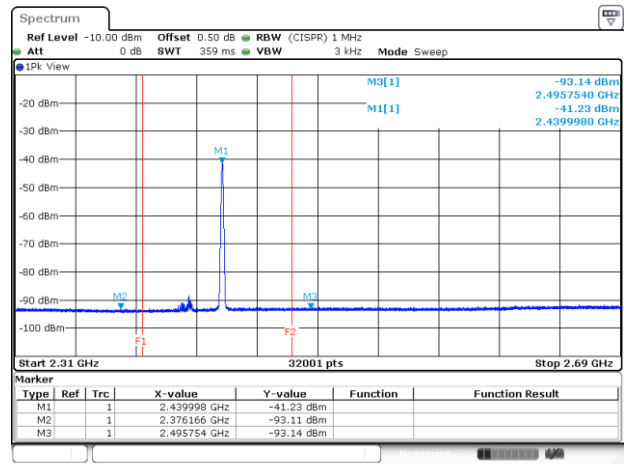

2440MHz - PK

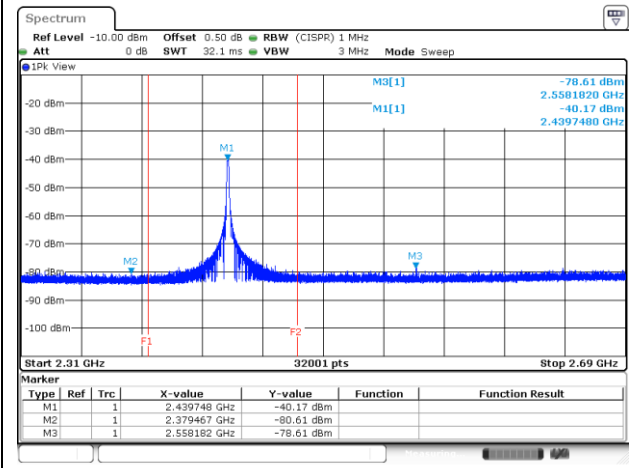

2480MHz - AV

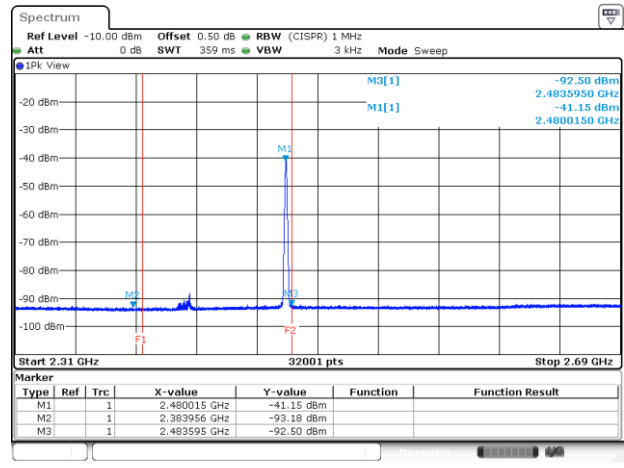

2480MHz - PK

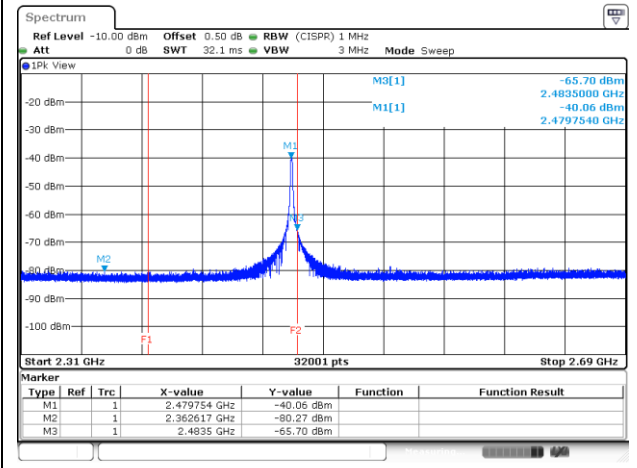

Transmitter Conducted Unwanted Emissions Results in Band Edge								
Modulation Mode		BT LE-2Mbps						
Test ch. Freq. (MHz)	Range (MHz)	Max Value chain0 (dBm)	DG (dBi)	EIRP (dBm)	E-Field (dBuV/m)	E-Field Limit (dBuV/m)	E-Field Margin (dB)	Remark
2402	2310~2390	-74.58	2.00	-72.58	22.68	74.00	-51.32	PK
	2310~2390	-93.33	2.00	-91.33	3.93	54.00	-50.07	AV
	2483.5~2500	-79.88	2.00	-77.88	17.38	74.00	-56.62	PK
	2483.5~2500	-92.66	2.00	-90.66	4.60	54.00	-49.40	AV
2440	2310~2390	-80.88	2.00	-78.88	16.38	74.00	-57.62	PK
	2310~2390	-92.93	2.00	-90.93	4.33	54.00	-49.67	AV
	2483.5~2500	-78.97	2.00	-76.97	18.29	74.00	-55.71	PK
	2483.5~2500	-91.95	2.00	-89.95	5.31	54.00	-48.69	AV
2480	2310~2390	-80.31	2.00	-78.31	16.95	74.00	-57.05	PK
	2310~2390	-92.84	2.00	-90.84	4.42	54.00	-49.58	AV
	2483.5~2690	-65.44	2.00	-63.44	31.82	74.00	-42.18	PK
	2483.5~2690	-91.85	2.00	-89.85	5.41	54.00	-48.59	AV

Note: DG = Directional Gain.

Band Edge Test Plot

2402MHz - AV

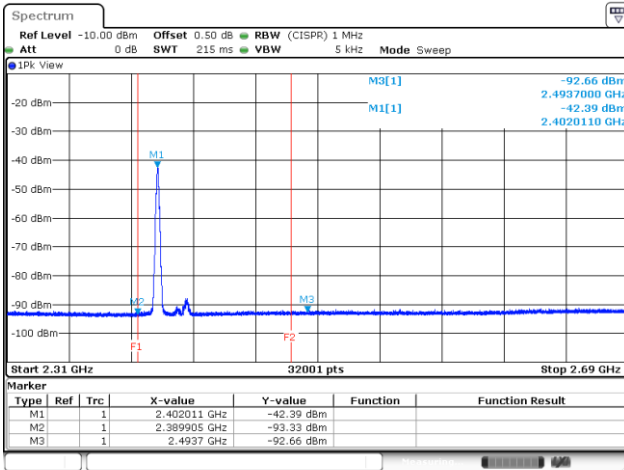

2402MHz - PK

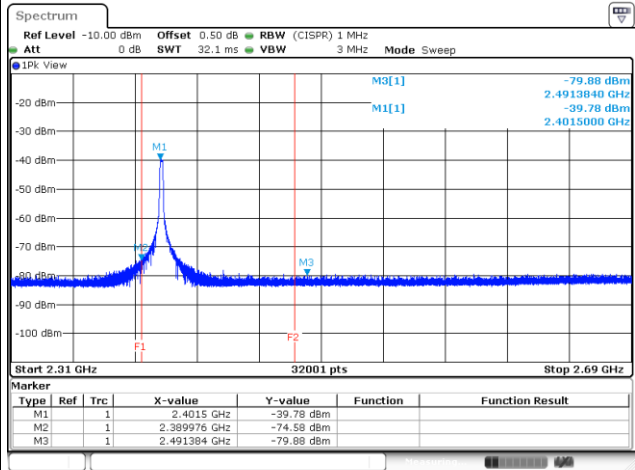

2440MHz - AV

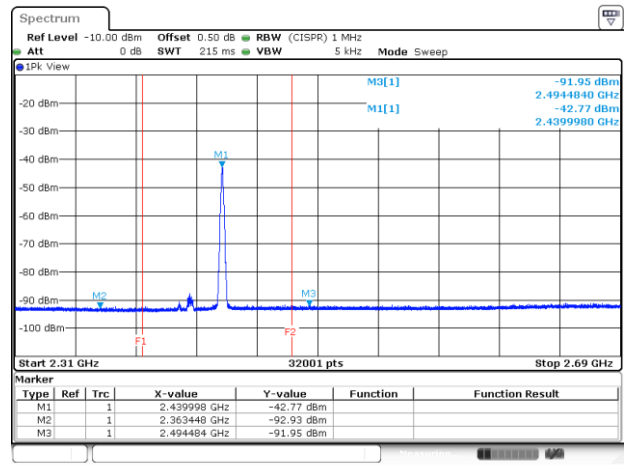

2440MHz - PK

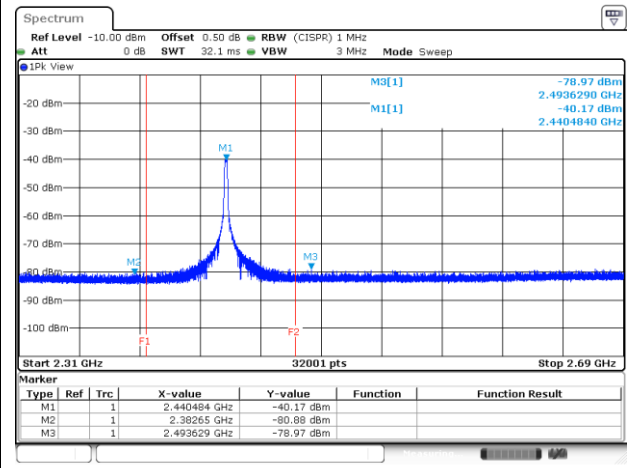

2480MHz - AV

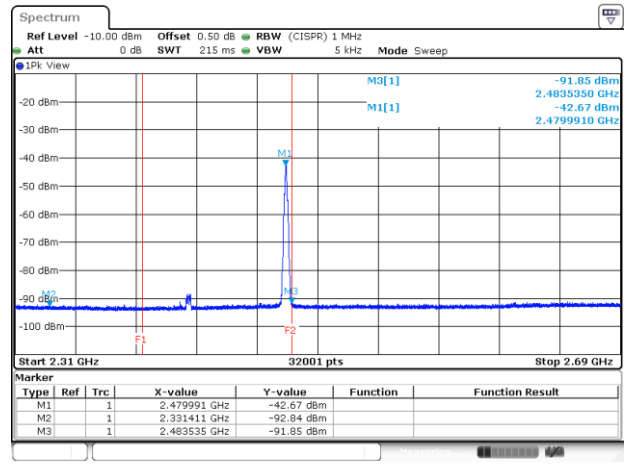

2480MHz - PK

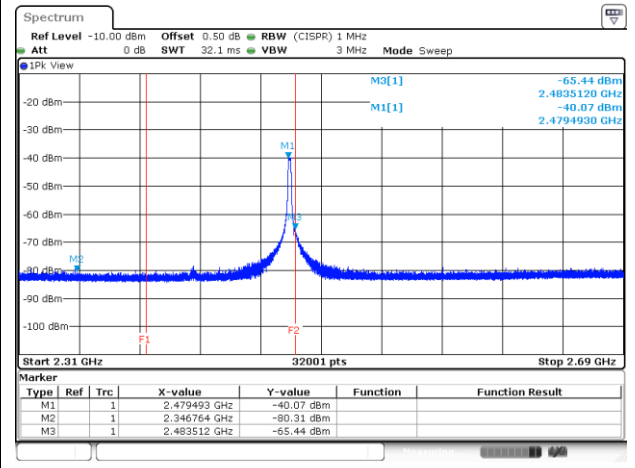

Transmitter Conducted Unwanted Emissions Results in Restricted Frequency Band							
Modulation Mode		BT LE-1Mbps		Frequency		2402MHz	
Freq. (MHz)	Remark	Max Value chain0 (dBm)	DG (dBi)	EIRP (dBm)	E-Field (dBuV/m)	E-Field Limit (dBm)	E-Field Margin (dB)
4804.00	PK	-72.88	2.00	-70.88	24.38	74.00	-49.62

Transmitter Conducted Unwanted Emissions Results in Restricted Frequency Band							
Modulation Mode		BT LE-1Mbps		Frequency		2440MHz	
Freq. (MHz)	Remark	Max Value chain0 (dBm)	DG (dBi)	EIRP (dBm)	E-Field (dBuV/m)	E-Field Limit (dBm)	E-Field Margin (dB)
4880.00	PK	-74.30	2.00	-72.30	22.96	74.00	-51.04

Transmitter Conducted Unwanted Emissions Results in Restricted Frequency Band							
Modulation Mode		BT LE-1Mbps		Frequency		2480MHz	
Freq. (MHz)	Remark	Max Value chain0 (dBm)	DG (dBi)	EIRP (dBm)	E-Field (dBuV/m)	E-Field Limit (dBm)	E-Field Margin (dB)
4960.00	PK	-74.25	2.00	-72.25	23.01	74.00	-50.99

Note:

1. If the PK margin greater than 20 dB, there is no need to get AVG reading.
2. DG = Directional Gain.

Test Plots

4804MHz - PK

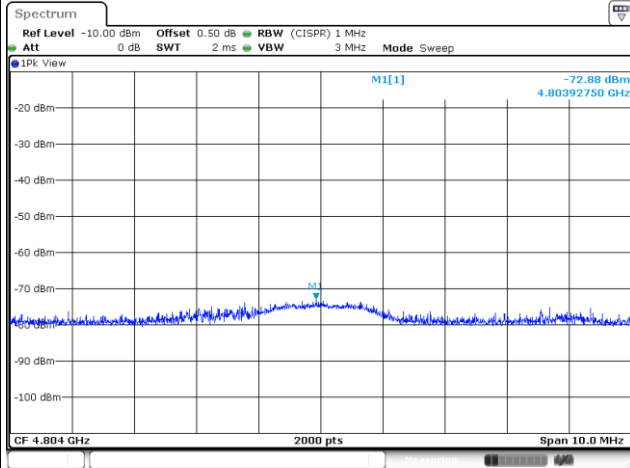

4880MHz - PK

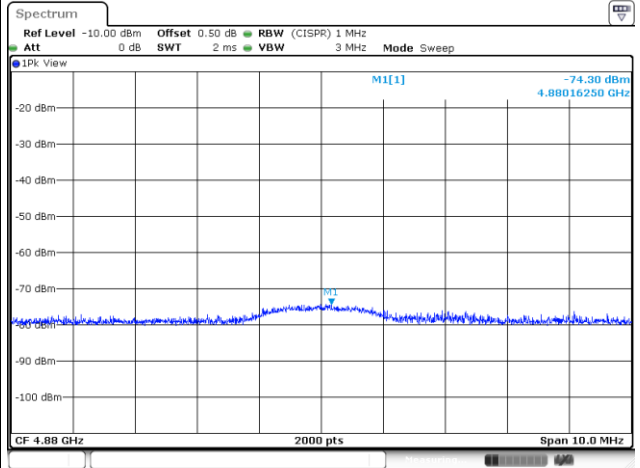

4960MHz - PK

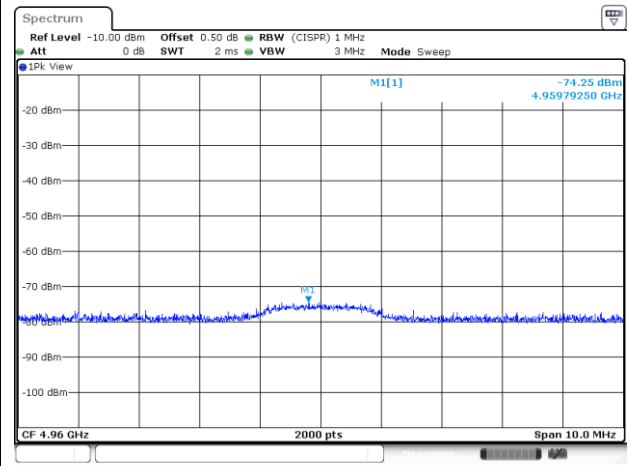

--

--

Transmitter Conducted Unwanted Emissions Results in Restricted Frequency Band							
Modulation Mode		BT LE-2Mbps		Frequency		2402MHz	
Freq. (MHz)	Remark	Max Value chain0 (dBm)	DG (dBi)	EIRP (dBm)	E-Field (dBuV/m)	E-Field Limit (dBm)	E-Field Margin (dB)
4804.00	PK	-73.82	2.00	-71.82	23.44	74.00	-50.56

Transmitter Conducted Unwanted Emissions Results in Restricted Frequency Band							
Modulation Mode		BT LE-2Mbps		Frequency		2440MHz	
Freq. (MHz)	Remark	Max Value chain0 (dBm)	DG (dBi)	EIRP (dBm)	E-Field (dBuV/m)	E-Field Limit (dBm)	E-Field Margin (dB)
4880.00	PK	-73.91	2.00	-71.91	23.35	74.00	-50.65

Transmitter Conducted Unwanted Emissions Results in Restricted Frequency Band							
Modulation Mode		BT LE-2Mbps		Frequency		2480MHz	
Freq. (MHz)	Remark	Max Value chain0 (dBm)	DG (dBi)	EIRP (dBm)	E-Field (dBuV/m)	E-Field Limit (dBm)	E-Field Margin (dB)
4960.00	PK	-74.54	2.00	-72.54	22.72	74.00	-51.28

Note:

1. If the PK margin greater than 20 dB, there is no need to get AVG reading.
2. DG = Directional Gain.

Test Plots

4804MHz - PK

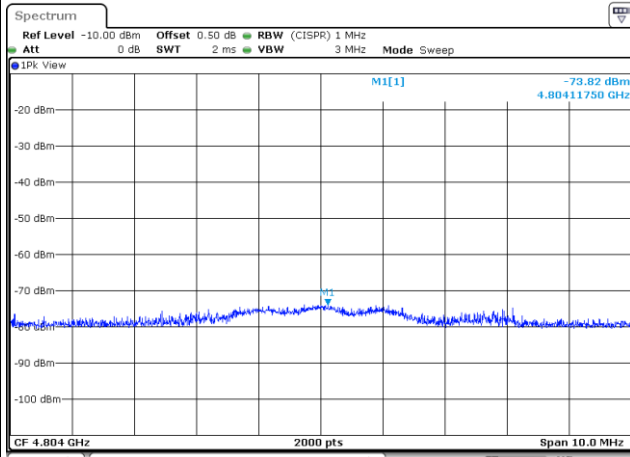

4880MHz - PK

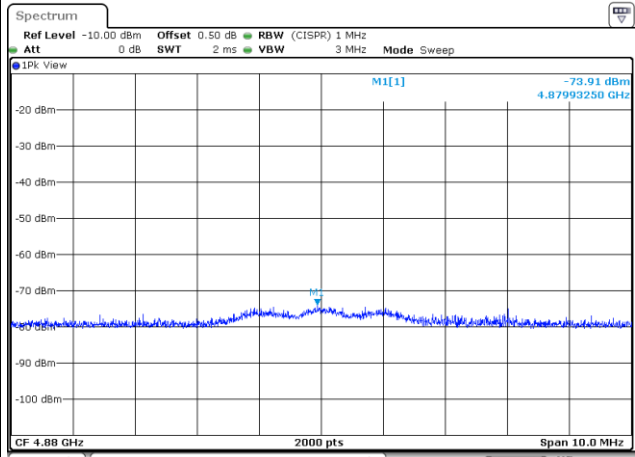

4960MHz - PK

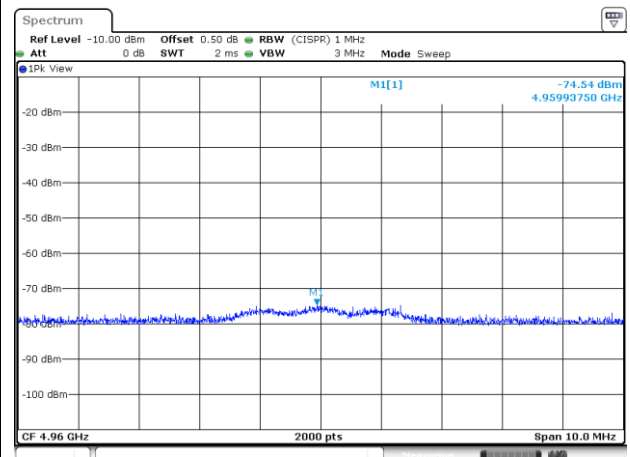

--

--

BT LE-1Mbps - Full Range Scan Test Plot

2402MHz

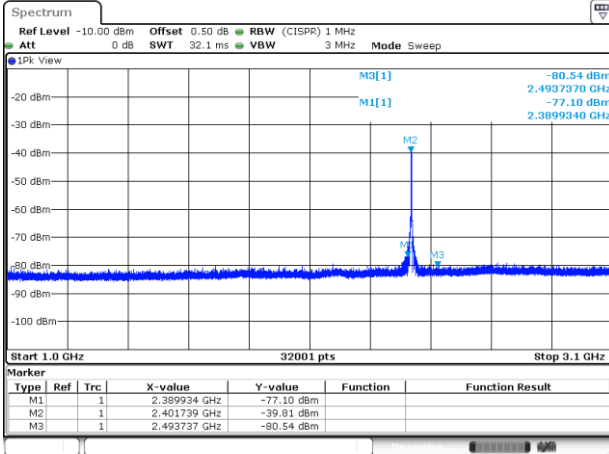

2402MHz

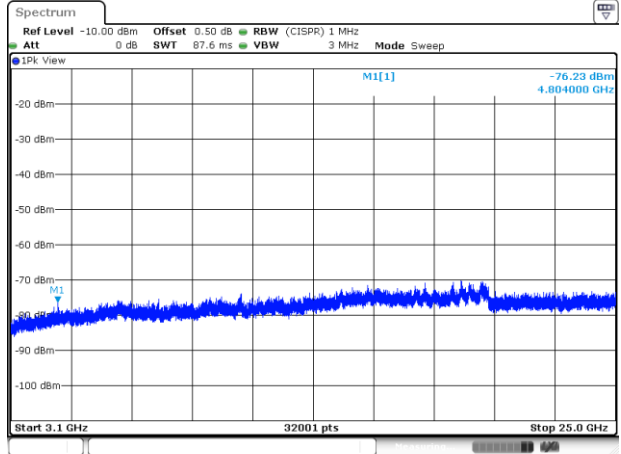

2440MHz

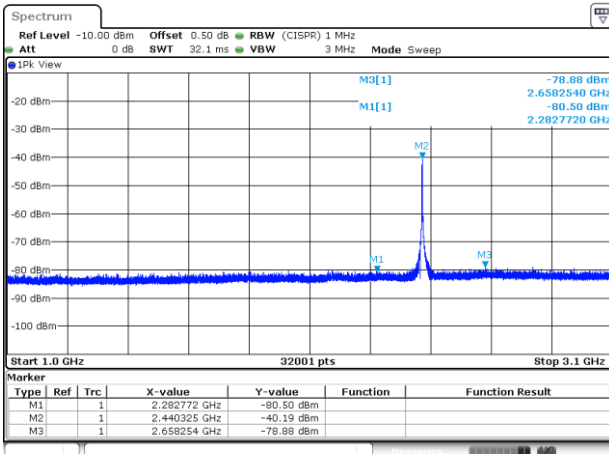

2440MHz

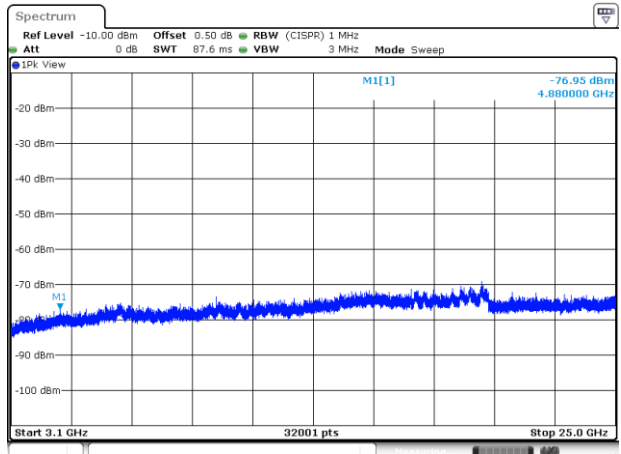

2480MHz

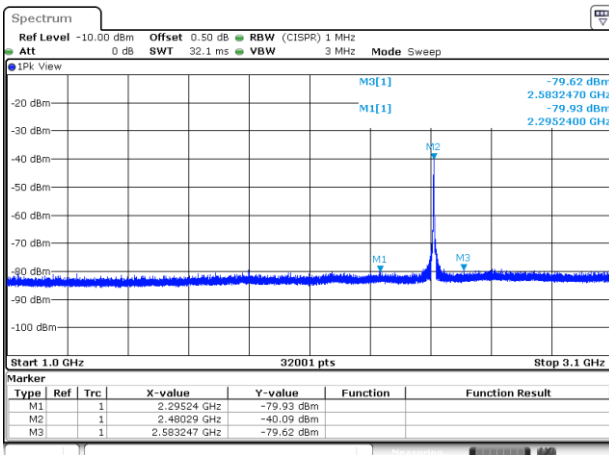

2480MHz

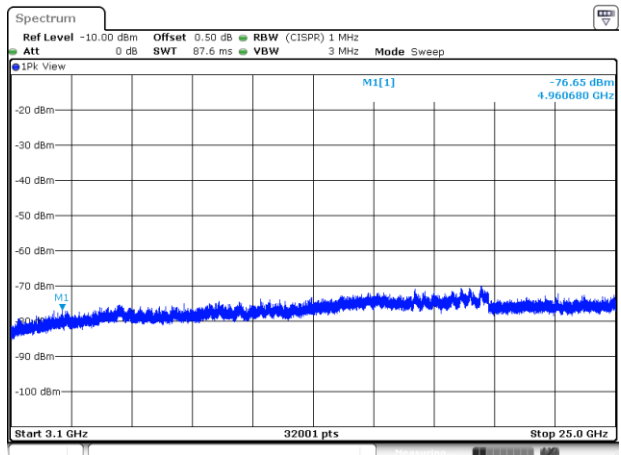

BT LE-2Mbps - Full Range Scan Test Plot

2402MHz

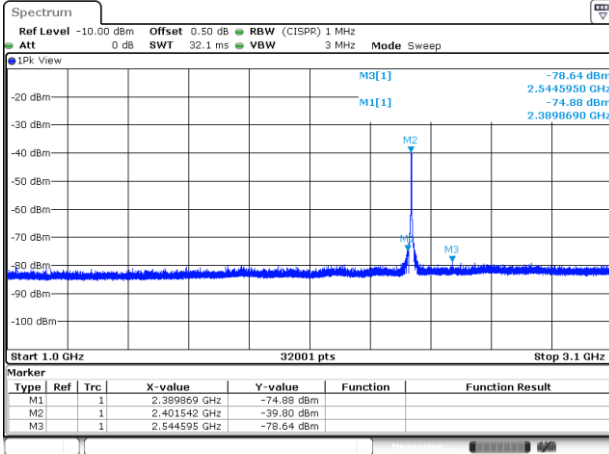

2402MHz

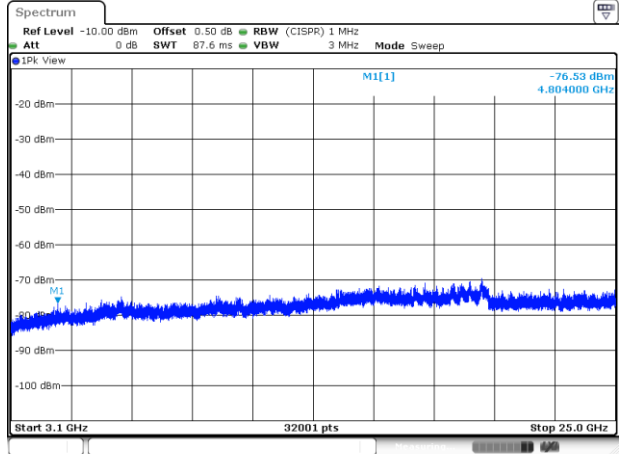

2440MHz

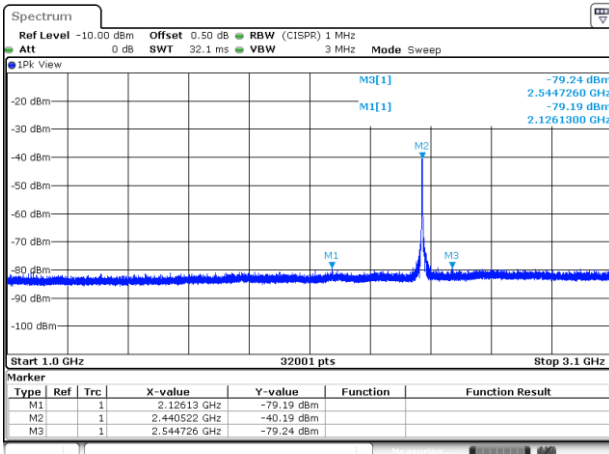

2440MHz

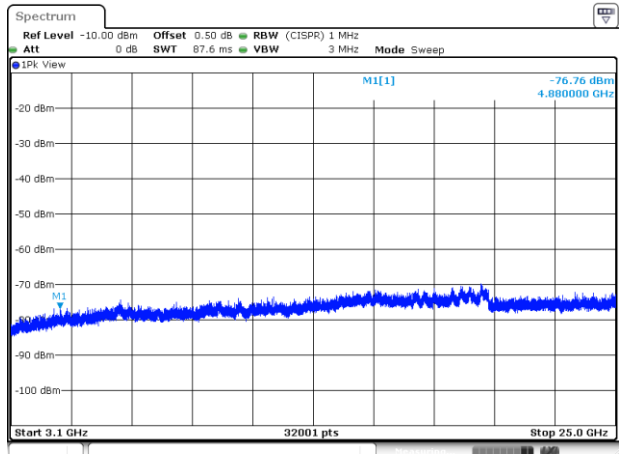

2480MHz

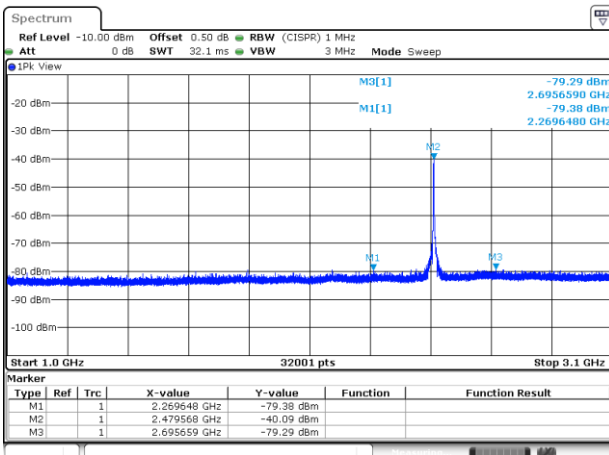

2480MHz

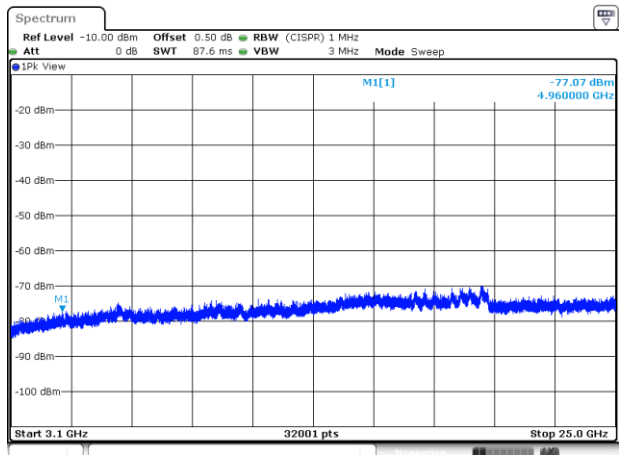

Test configuration 2: High Power with Printed PCB antenna

3.5.8 Transmitter Radiated Unwanted Emissions (Below 1GHz)

Modulation	BT-LE (1Mbps)	Test Freq. (MHz)	2480
Polarization	Horizontal		

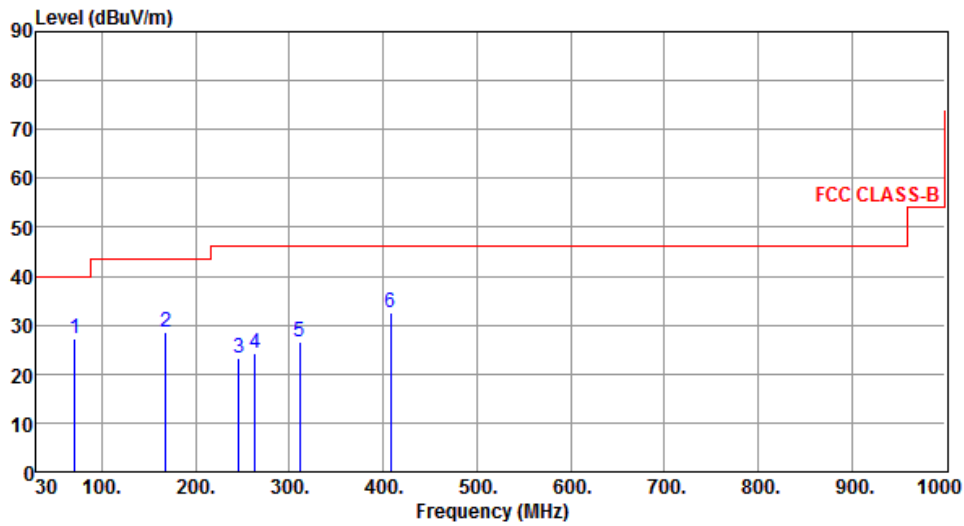

	Freq. MHz	Emission level dBuV/m	Limit dBuV/m	Margin dB	SA reading dBuV	Factor dB	Remark	ANT High cm	Turn Table deg
1	70.74	27.32	40.00	-12.68	38.04	-10.72	Peak	---	---
2	167.74	28.64	43.50	-14.86	37.34	-8.70	Peak	---	---
3	246.31	23.16	46.00	-22.84	33.13	-9.97	Peak	---	---
4	263.77	24.35	46.00	-21.65	33.73	-9.38	Peak	---	---
5	311.30	26.49	46.00	-19.51	34.18	-7.69	Peak	---	---
6	408.30	32.44	46.00	-13.56	37.80	-5.36	Peak	---	---

Note 1: Emission Level (dBuV/m) = SA Reading (dBuV/m) + Factor* (dB)

*Factor includes antenna factor , cable loss and amplifier gain

Note 2: Margin (dB) = Emission level (dBuV/m) – Limit (dBuV/m).

Note 3: All spurious emissions below 30MHz are more than 20 dB below the limit.

Modulation	BT-LE (1Mbps)	Test Freq. (MHz)	2480
Polarization	Vertical		

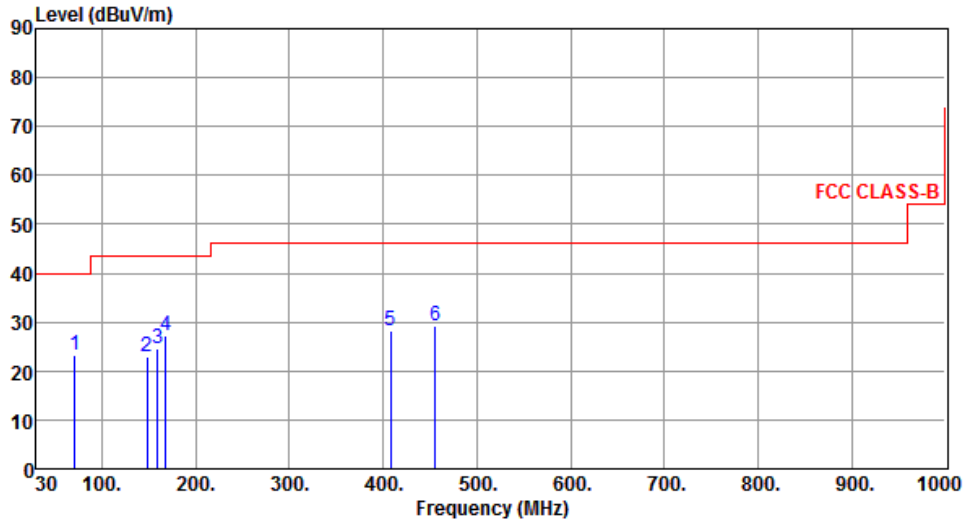

	Freq. MHz	Emission level dBuV/m	Limit dBuV/m	Margin dB	SA reading dBuV	Factor dB	Remark	ANT High cm	Turn Table deg
1	70.74	23.41	40.00	-16.59	34.13	-10.72	Peak	---	---
2	148.34	22.94	43.50	-20.56	31.38	-8.44	Peak	---	---
3	159.01	24.66	43.50	-18.84	32.98	-8.32	Peak	---	---
4	167.74	27.25	43.50	-16.25	35.95	-8.70	Peak	---	---
5	408.30	28.31	46.00	-17.69	33.67	-5.36	Peak	---	---
6	455.83	29.14	46.00	-16.86	33.10	-3.96	Peak	---	---

Note 1: Emission Level (dBuV/m) = SA Reading (dBuV/m) + Factor* (dB)

*Factor includes antenna factor , cable loss and amplifier gain

Note 2: Margin (dB) = Emission level (dBuV/m) – Limit (dBuV/m).

Note 3: All spurious emissions below 30MHz are more than 20 dB below the limit.

Modulation	BT-LE (2Mbps)	Test Freq. (MHz)	2480
Polarization	Horizontal		

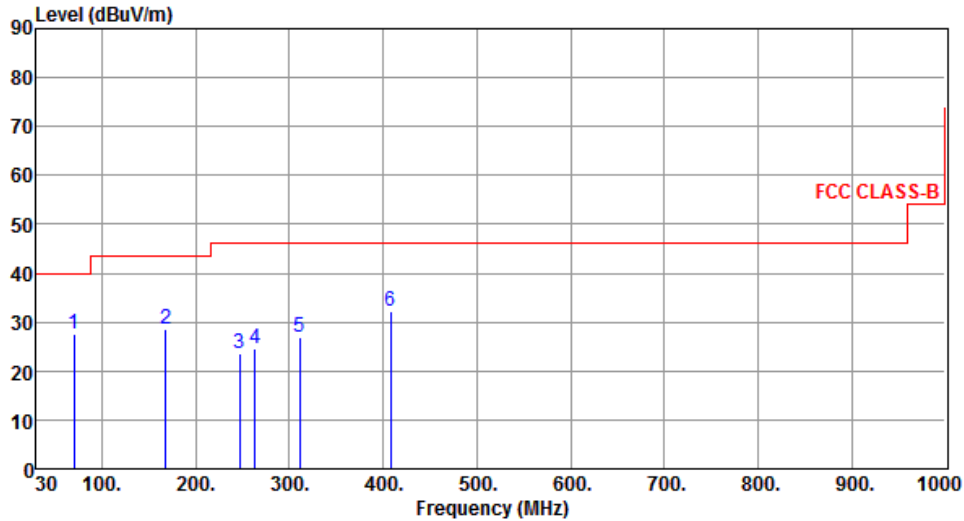

	Freq. MHz	Emission level dBuV/m	Limit dBuV/m	Margin dB	SA reading dBuV	Factor dB	Remark	ANT High cm	Turn Table deg
1	70.44	27.56	40.00	-12.44	38.25	-10.69	Peak	---	---
2	167.96	28.44	43.50	-15.06	37.15	-8.71	Peak	---	---
3	247.11	23.67	46.00	-22.33	33.63	-9.96	Peak	---	---
4	262.99	24.42	46.00	-21.58	33.85	-9.43	Peak	---	---
5	311.25	26.83	46.00	-19.17	34.52	-7.69	Peak	---	---
6	408.36	32.37	46.00	-13.63	37.73	-5.36	Peak	---	---

Note 1: Emission Level (dBuV/m) = SA Reading (dBuV/m) + Factor* (dB)

*Factor includes antenna factor , cable loss and amplifier gain

Note 2: Margin (dB) = Emission level (dBuV/m) – Limit (dBuV/m).

Note 3: All spurious emissions below 30MHz are more than 20 dB below the limit.

Modulation	BT-LE (2Mbps)	Test Freq. (MHz)	2480
Polarization	Vertical		

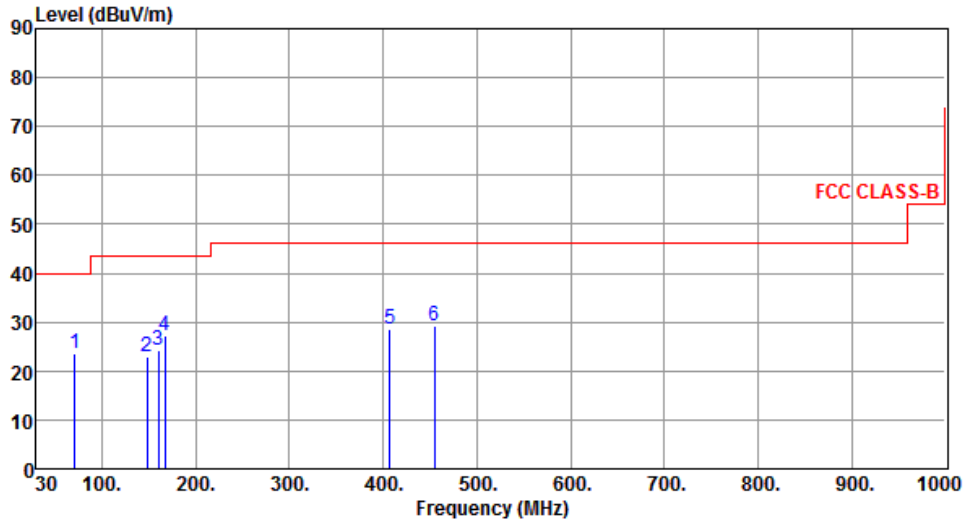

	Freq. MHz	Emission level dBuV/m	Limit dBuV/m	Margin dB	SA reading dBuV	Factor dB	Remark	ANT High cm	Turn Table deg
1	70.85	23.49	40.00	-16.51	34.23	-10.74	Peak	---	---
2	148.17	23.00	43.50	-20.50	31.45	-8.45	Peak	---	---
3	160.25	24.35	43.50	-19.15	32.77	-8.42	Peak	---	---
4	167.22	27.11	43.50	-16.39	35.81	-8.70	Peak	---	---
5	407.52	28.63	46.00	-17.37	34.01	-5.38	Peak	---	---
6	454.98	29.33	46.00	-16.67	33.31	-3.98	Peak	---	---

Note 1: Emission Level (dBuV/m) = SA Reading (dBuV/m) + Factor* (dB)

*Factor includes antenna factor , cable loss and amplifier gain

Note 2: Margin (dB) = Emission level (dBuV/m) – Limit (dBuV/m).

Note 3: All spurious emissions below 30MHz are more than 20 dB below the limit.

3.5.9 Transmitter Radiated Unwanted Emissions (Above 1GHz)

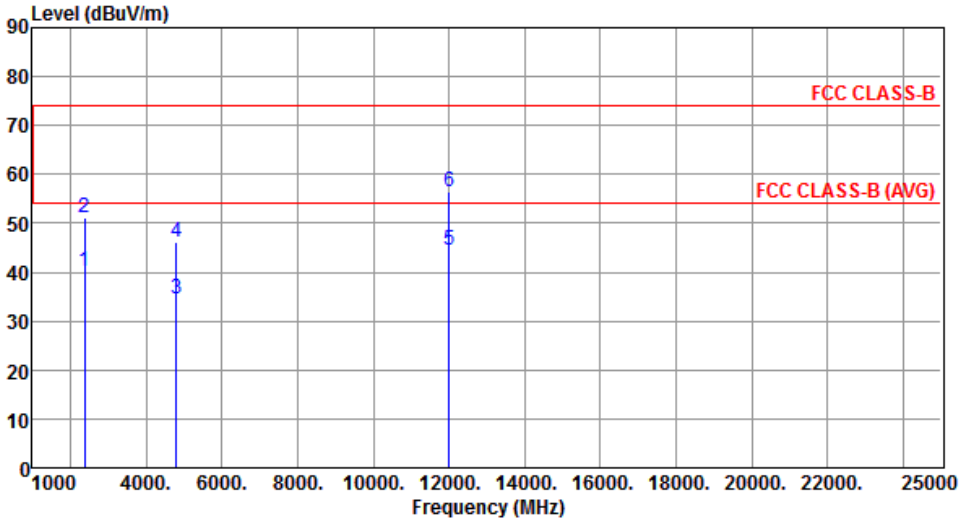
Modulation	BT-LE (1Mbps)	Test Freq. (MHz)	2402						
Polarization	Horizontal								
									
	Freq.	Emission level	Limit	Margin	SA reading	Factor	Remark	ANT High	Turn Table
	MHz	dBuV/m	dBuV/m	dB	dBuV	dB		cm	deg
1	2390.00	40.05	54.00	-13.95	42.85	-2.80	Average	100	188
2	2390.00	51.18	74.00	-22.82	53.98	-2.80	Peak	100	188
3	4804.00	34.41	54.00	-19.59	30.88	3.53	Average	100	206
4	4804.00	46.30	74.00	-27.70	42.77	3.53	Peak	100	206
5	12010.00	44.58	54.00	-9.42	30.86	13.72	Average	100	204
6	12010.00	56.39	74.00	-17.61	42.67	13.72	Peak	100	204
<p>Note 1: Emission Level (dBuV/m) = SA Reading (dBuV/m) + Factor* (dB) *Factor includes antenna factor , cable loss and amplifier gain Note 2: Margin (dB) = Emission level (dBuV/m) – Limit (dBuV/m).</p>									

Modulation	BT-LE (1Mbps)	Test Freq. (MHz)	2402
Polarization	Vertical		

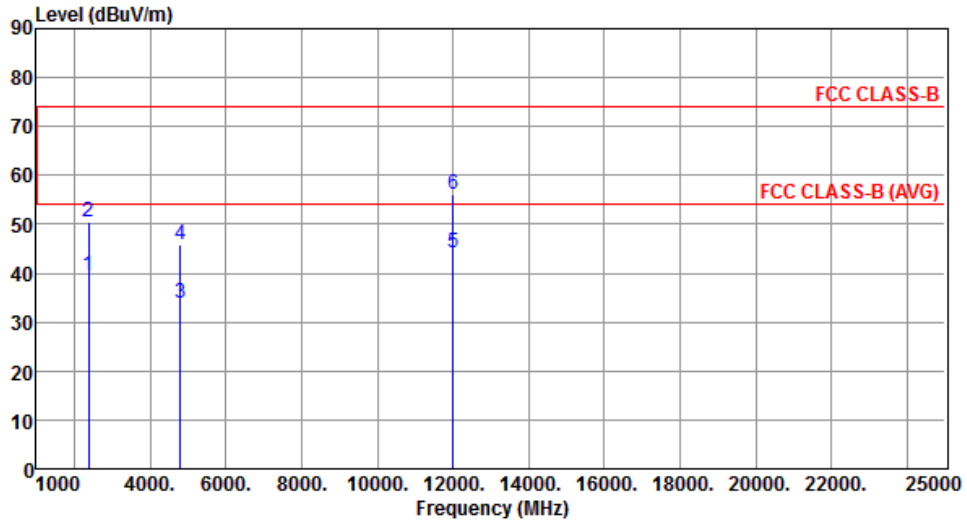

	Freq. MHz	Emission level dBuV/m	Limit dBuV/m	Margin dB	SA reading dBuV	Factor dB	Remark	ANT High cm	Turn Table deg
1	2390.00	39.67	54.00	-14.33	42.47	-2.80	Average	100	243
2	2390.00	50.61	74.00	-23.39	53.41	-2.80	Peak	100	243
3	4804.00	33.78	54.00	-20.22	30.25	3.53	Average	100	53
4	4804.00	45.78	74.00	-28.22	42.25	3.53	Peak	100	53
5	12010.00	44.05	54.00	-9.95	30.33	13.72	Average	100	51
6	12010.00	56.14	74.00	-17.86	42.42	13.72	Peak	100	51

Note 1: Emission Level (dBuV/m) = SA Reading (dBuV/m) + Factor* (dB)

*Factor includes antenna factor , cable loss and amplifier gain

Note 2: Margin (dB) = Emission level (dBuV/m) – Limit (dBuV/m).

Modulation	BT-LE (1Mbps)	Test Freq. (MHz)	2440
Polarization	Horizontal		

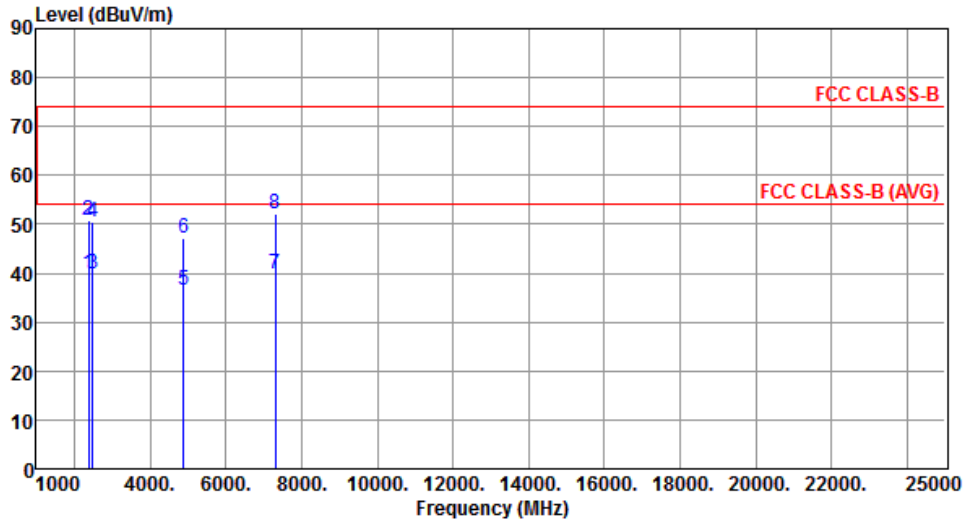

	Freq. MHz	Emission level dBuV/m	Limit dBuV/m	Margin dB	SA reading dBuV	Factor dB	Remark	ANT High cm	Turn Table deg
1	2390.00	39.97	54.00	-14.03	42.77	-2.80	Average	100	185
2	2390.00	50.86	74.00	-23.14	53.66	-2.80	Peak	100	185
3	2483.50	39.77	54.00	-14.23	42.80	-3.03	Average	100	185
4	2483.50	50.63	74.00	-23.37	53.66	-3.03	Peak	100	185
5	4880.00	36.53	54.00	-17.47	32.90	3.63	Average	100	198
6	4880.00	47.26	74.00	-26.74	43.63	3.63	Peak	100	198
7	7320.00	39.69	54.00	-14.31	30.47	9.22	Average	100	202
8	7320.00	52.00	74.00	-22.00	42.78	9.22	Peak	100	202

Note 1: Emission Level (dBuV/m) = SA Reading (dBuV/m) + Factor* (dB)

*Factor includes antenna factor , cable loss and amplifier gain

Note 2: Margin (dB) = Emission level (dBuV/m) – Limit (dBuV/m).

Modulation	BT-LE (1Mbps)	Test Freq. (MHz)	2440
Polarization	Vertical		

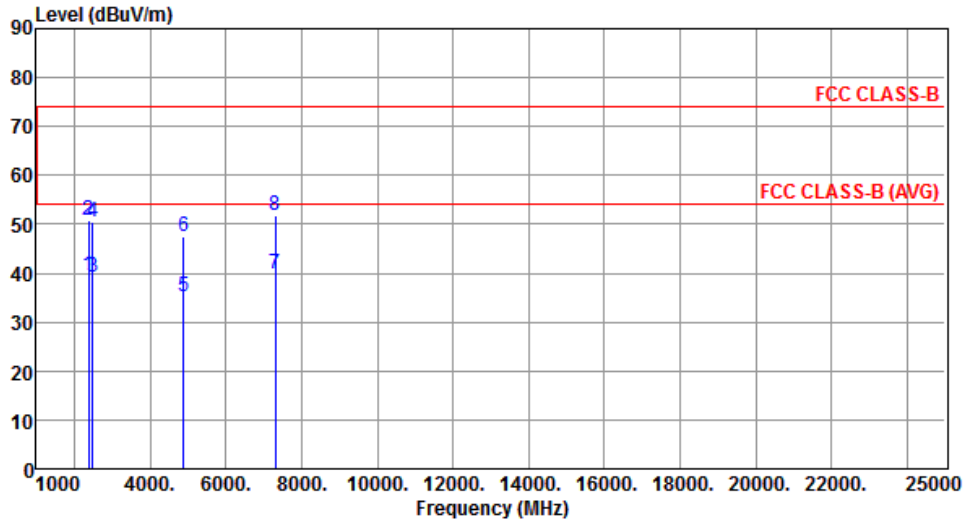

	Freq. MHz	Emission level dBuV/m	Limit dBuV/m	Margin dB	SA reading dBuV	Factor dB	Remark	ANT High cm	Turn Table deg
1	2390.00	39.37	54.00	-14.63	42.17	-2.80	Average	100	257
2	2390.00	50.67	74.00	-23.33	53.47	-2.80	Peak	100	257
3	2483.50	39.25	54.00	-14.75	42.28	-3.03	Average	100	257
4	2483.50	50.38	74.00	-23.62	53.41	-3.03	Peak	100	257
5	4880.00	35.08	54.00	-18.92	31.45	3.63	Average	100	55
6	4880.00	47.47	74.00	-26.53	43.84	3.63	Peak	100	55
7	7320.00	39.77	54.00	-14.23	30.55	9.22	Average	100	60
8	7320.00	51.88	74.00	-22.12	42.66	9.22	Peak	100	60

Note 1: Emission Level (dBuV/m) = SA Reading (dBuV/m) + Factor* (dB)

*Factor includes antenna factor , cable loss and amplifier gain

Note 2: Margin (dB) = Emission level (dBuV/m) – Limit (dBuV/m).

Modulation	BT-LE (1Mbps)	Test Freq. (MHz)	2480
Polarization	Horizontal		

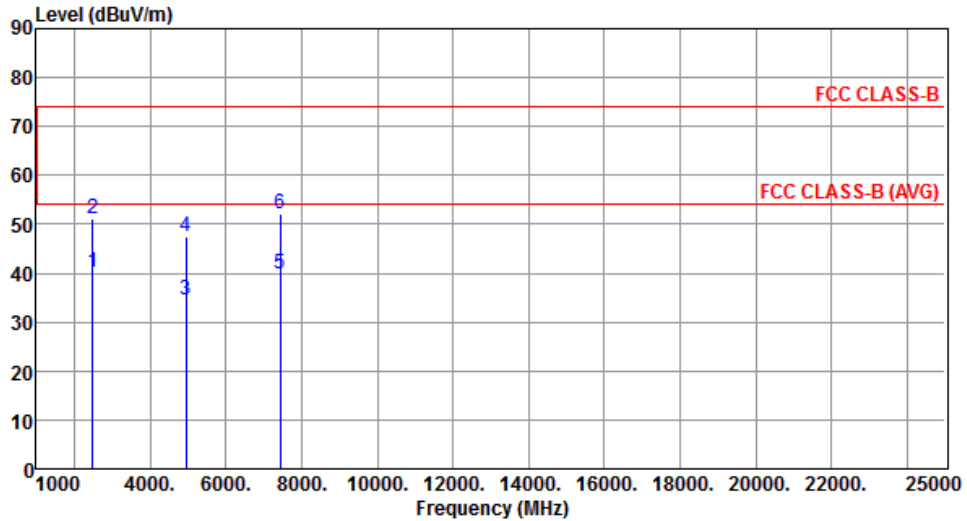

	Freq. MHz	Emission level dBuV/m	Limit dBuV/m	Margin dB	SA reading dBuV	Factor dB	Remark	ANT High cm	Turn Table deg
1	2483.50	40.29	54.00	-13.71	43.32	-3.03	Average	100	204
2	2483.50	51.22	74.00	-22.78	54.25	-3.03	Peak	100	204
3	4960.00	34.52	54.00	-19.48	30.69	3.83	Average	100	207
4	4960.00	47.41	74.00	-26.59	43.58	3.83	Peak	100	207
5	7440.00	39.98	54.00	-14.02	30.77	9.21	Average	100	200
6	7440.00	52.09	74.00	-21.91	42.88	9.21	Peak	100	200

Note 1: Emission Level (dBuV/m) = SA Reading (dBuV/m) + Factor* (dB)

*Factor includes antenna factor , cable loss and amplifier gain

Note 2: Margin (dB) = Emission level (dBuV/m) – Limit (dBuV/m).

Modulation	BT-LE (1Mbps)	Test Freq. (MHz)	2480
Polarization	Vertical		

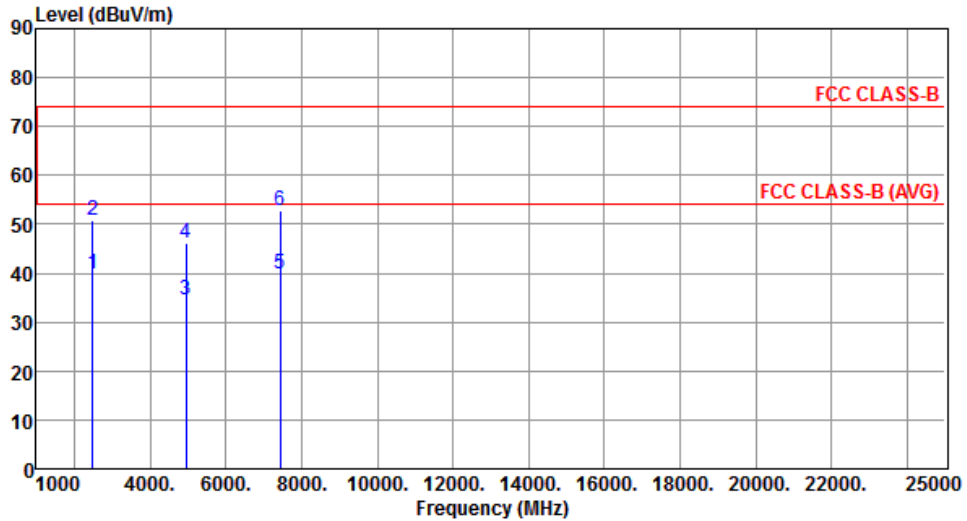

	Freq. MHz	Emission level dBuV/m	Limit dBuV/m	Margin dB	SA reading dBuV	Factor dB	Remark	ANT High cm	Turn Table deg
1	2483.50	39.84	54.00	-14.16	42.87	-3.03	Average	100	250
2	2483.50	50.74	74.00	-23.26	53.77	-3.03	Peak	100	250
3	4960.00	34.48	54.00	-19.52	30.65	3.83	Average	100	57
4	4960.00	46.30	74.00	-27.70	42.47	3.83	Peak	100	57
5	7440.00	39.90	54.00	-14.10	30.69	9.21	Average	100	59
6	7440.00	52.83	74.00	-21.17	43.62	9.21	Peak	100	59

Note 1: Emission Level (dBuV/m) = SA Reading (dBuV/m) + Factor* (dB)

*Factor includes antenna factor , cable loss and amplifier gain

Note 2: Margin (dB) = Emission level (dBuV/m) – Limit (dBuV/m).

Modulation	BT-LE (2Mbps)	Test Freq. (MHz)	2402
Polarization	Horizontal		

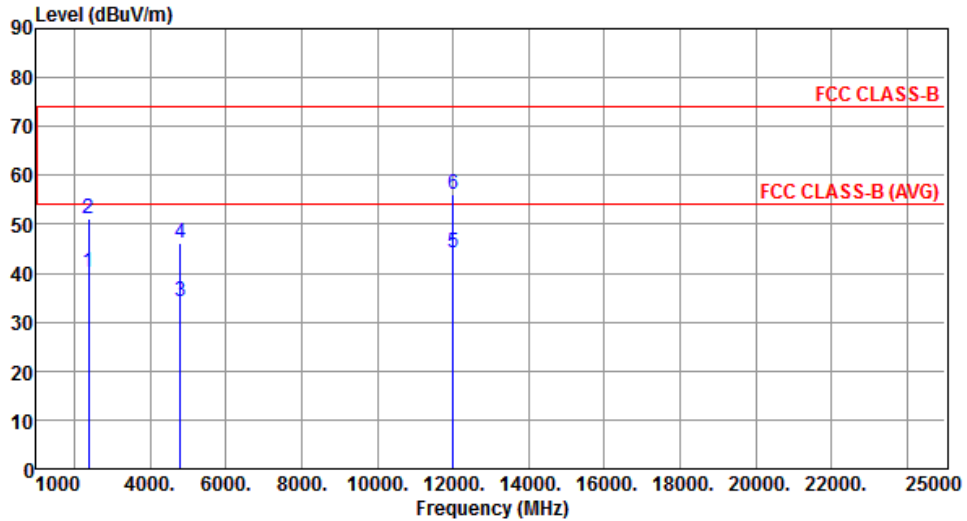

	Freq. MHz	Emission level dBuV/m	Limit dBuV/m	Margin dB	SA reading dBuV	Factor dB	Remark	ANT High cm	Turn Table deg
1	2390.00	40.18	54.00	-13.82	42.98	-2.80	Average	100	195
2	2390.00	51.16	74.00	-22.84	53.96	-2.80	Peak	100	195
3	4804.00	34.21	54.00	-19.79	30.68	3.53	Average	100	206
4	4804.00	46.19	74.00	-27.81	42.66	3.53	Peak	100	206
5	12010.00	44.30	54.00	-9.70	30.58	13.72	Average	100	207
6	12010.00	56.28	74.00	-17.72	42.56	13.72	Peak	100	207

Note 1: Emission Level (dBuV/m) = SA Reading (dBuV/m) + Factor* (dB)

*Factor includes antenna factor , cable loss and amplifier gain

Note 2: Margin (dB) = Emission level (dBuV/m) – Limit (dBuV/m).

Modulation	BT-LE (2Mbps)	Test Freq. (MHz)	2402
Polarization	Vertical		

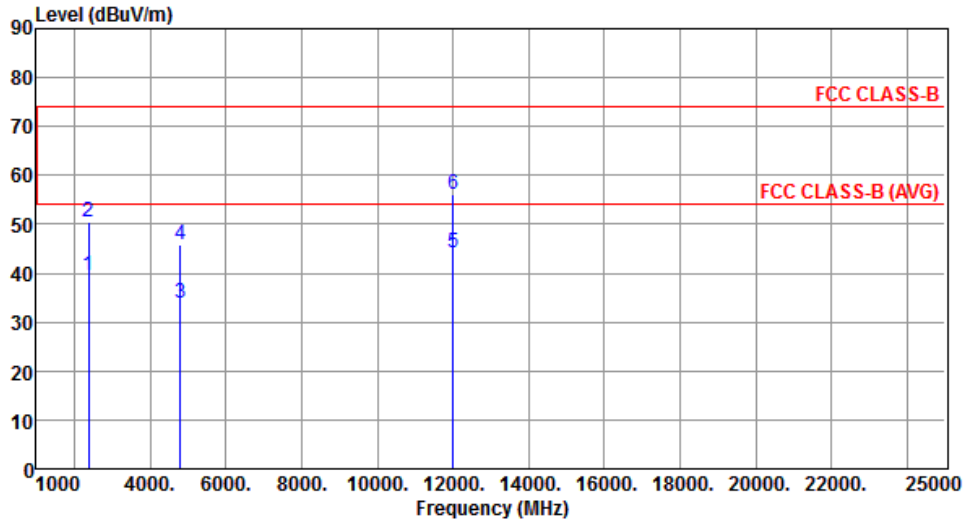

	Freq. MHz	Emission level dBuV/m	Limit dBuV/m	Margin dB	SA reading dBuV	Factor dB	Remark	ANT High cm	Turn Table deg
1	2390.00	39.43	54.00	-14.57	42.23	-2.80	Average	100	247
2	2390.00	50.64	74.00	-23.36	53.44	-2.80	Peak	100	247
3	4804.00	33.78	54.00	-20.22	30.25	3.53	Average	100	51
4	4804.00	45.78	74.00	-28.22	42.25	3.53	Peak	100	51
5	12010.00	44.12	54.00	-9.88	30.40	13.72	Average	100	59
6	12010.00	56.19	74.00	-17.81	42.47	13.72	Peak	100	59

Note 1: Emission Level (dBuV/m) = SA Reading (dBuV/m) + Factor* (dB)

*Factor includes antenna factor , cable loss and amplifier gain

Note 2: Margin (dB) = Emission level (dBuV/m) – Limit (dBuV/m).

Modulation	BT-LE (2Mbps)	Test Freq. (MHz)	2440
Polarization	Horizontal		

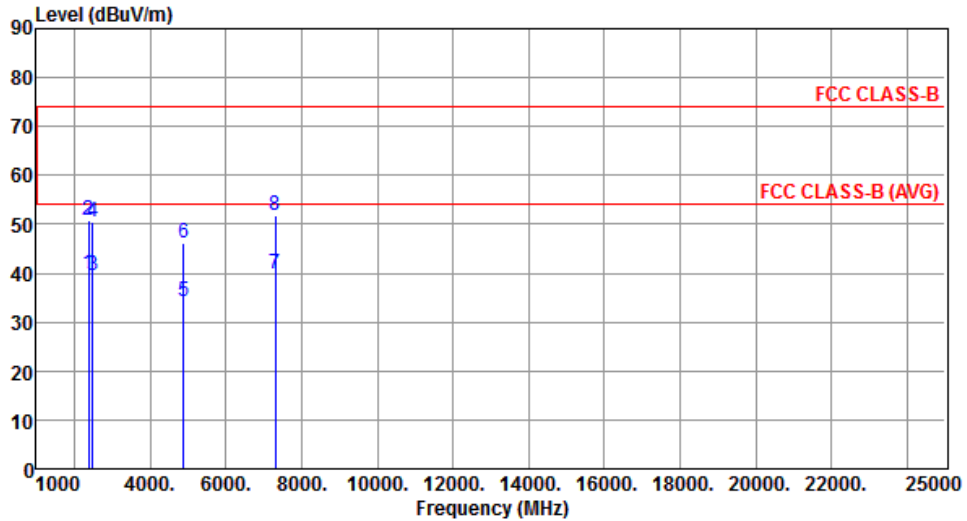

	Freq. MHz	Emission level dBuV/m	Limit dBuV/m	Margin dB	SA reading dBuV	Factor dB	Remark	ANT High cm	Turn Table deg
1	2390.00	39.78	54.00	-14.22	42.58	-2.80	Average	100	191
2	2390.00	50.83	74.00	-23.17	53.63	-2.80	Peak	100	191
3	2483.50	39.52	54.00	-14.48	42.55	-3.03	Average	100	191
4	2483.50	50.52	74.00	-23.48	53.55	-3.03	Peak	100	191
5	4880.00	34.30	54.00	-19.70	30.67	3.63	Average	100	201
6	4880.00	46.22	74.00	-27.78	42.59	3.63	Peak	100	201
7	7320.00	39.91	54.00	-14.09	30.69	9.22	Average	100	205
8	7320.00	51.91	74.00	-22.09	42.69	9.22	Peak	100	205

Note 1: Emission Level (dBuV/m) = SA Reading (dBuV/m) + Factor* (dB)

*Factor includes antenna factor , cable loss and amplifier gain

Note 2: Margin (dB) = Emission level (dBuV/m) – Limit (dBuV/m).

Modulation	BT-LE (2Mbps)	Test Freq. (MHz)	2440
Polarization	Vertical		

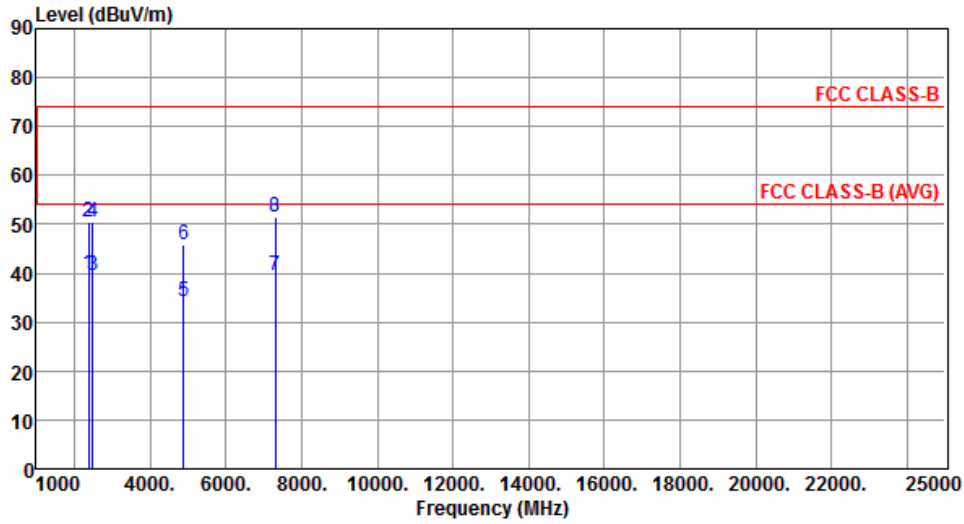

	Freq. MHz	Emission level dBuV/m	Limit dBuV/m	Margin dB	SA reading dBuV	Factor dB	Remark	ANT High cm	Turn Table deg
1	2390.00	39.77	54.00	-14.23	42.57	-2.80	Average	100	247
2	2390.00	50.42	74.00	-23.58	53.22	-2.80	Peak	100	247
3	2483.50	39.44	54.00	-14.56	42.47	-3.03	Average	100	247
4	2483.50	50.33	74.00	-23.67	53.36	-3.03	Peak	100	247
5	4880.00	34.08	54.00	-19.92	30.45	3.63	Average	100	51
6	4880.00	45.89	74.00	-28.11	42.26	3.63	Peak	100	51
7	7320.00	39.61	54.00	-14.39	30.39	9.22	Average	100	58
8	7320.00	51.39	74.00	-22.61	42.17	9.22	Peak	100	58

Note 1: Emission Level (dBuV/m) = SA Reading (dBuV/m) + Factor* (dB)

*Factor includes antenna factor , cable loss and amplifier gain

Note 2: Margin (dB) = Emission level (dBuV/m) – Limit (dBuV/m).

Modulation	BT-LE (2Mbps)	Test Freq. (MHz)	2480
Polarization	Horizontal		

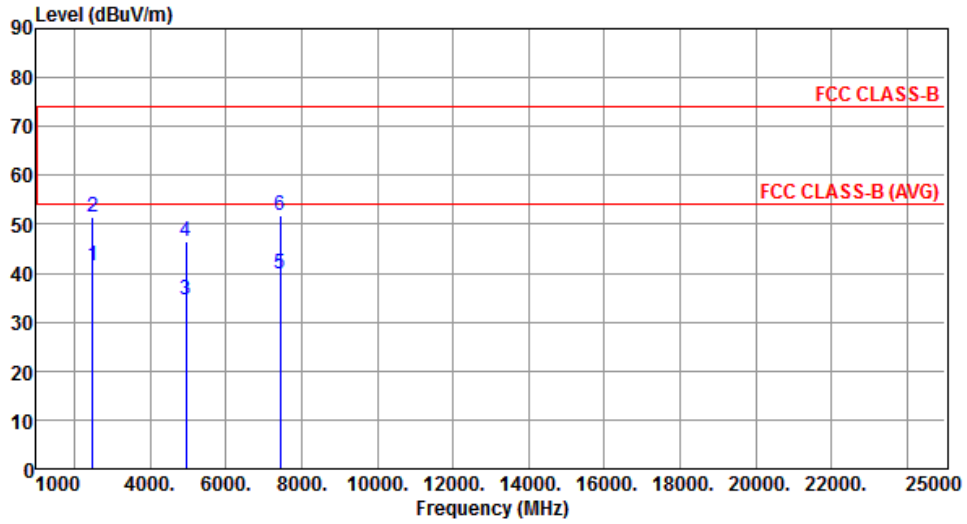

	Freq. MHz	Emission level dBuV/m	Limit dBuV/m	Margin dB	SA reading dBuV	Factor dB	Remark	ANT High cm	Turn Table deg
1	2483.50	41.51	54.00	-12.49	44.54	-3.03	Average	100	187
2	2483.50	51.63	74.00	-22.37	54.66	-3.03	Peak	100	187
3	4960.00	34.40	54.00	-19.60	30.57	3.83	Average	100	205
4	4960.00	46.42	74.00	-27.58	42.59	3.83	Peak	100	205
5	7440.00	39.90	54.00	-14.10	30.69	9.21	Average	100	207
6	7440.00	51.82	74.00	-22.18	42.61	9.21	Peak	100	207

Note 1: Emission Level (dBuV/m) = SA Reading (dBuV/m) + Factor* (dB)

*Factor includes antenna factor , cable loss and amplifier gain

Note 2: Margin (dB) = Emission level (dBuV/m) – Limit (dBuV/m).

Modulation	BT-LE (2Mbps)	Test Freq. (MHz)	2480
Polarization	Vertical		

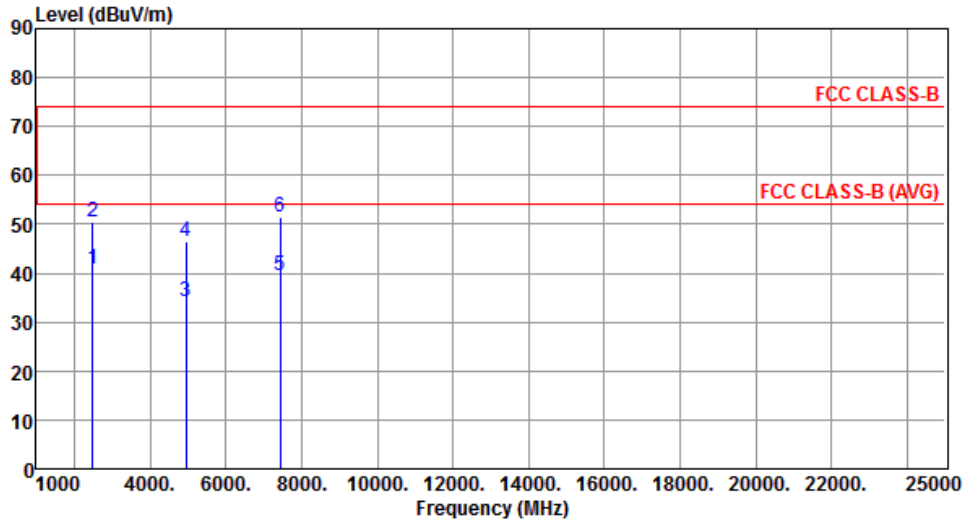

	Freq. MHz	Emission level dBuV/m	Limit dBuV/m	Margin dB	SA reading dBuV	Factor dB	Remark	ANT High cm	Turn Table deg
1	2483.50	40.82	54.00	-13.18	43.85	-3.03	Average	100	253
2	2483.50	50.62	74.00	-23.38	53.65	-3.03	Peak	100	253
3	4960.00	34.09	54.00	-19.91	30.26	3.83	Average	100	58
4	4960.00	46.46	74.00	-27.54	42.63	3.83	Peak	100	58
5	7440.00	39.49	54.00	-14.51	30.28	9.21	Average	100	49
6	7440.00	51.61	74.00	-22.39	42.40	9.21	Peak	100	49

Note 1: Emission Level (dBuV/m) = SA Reading (dBuV/m) + Factor* (dB)

*Factor includes antenna factor , cable loss and amplifier gain

Note 2: Margin (dB) = Emission level (dBuV/m) – Limit (dBuV/m).

3.5.10 Transmitter Conducted Unwanted Emissions (Below 1 GHz)

Modulation Mode		BT LE-1Mbps		Frequency		2480MHz	
Range (MHz)	Max Value chain0 (dBm)	DG (dBi)	GRF (dB)	EIRP (dBm)	E-Field (dBuV/m)	Min E-Field Limit (dBuV/m)	E-Field Margin (dB)
30~1000	-70.24	2.00	4.70	-63.54	31.72	40.00	-8.28

Modulation Mode		BT LE-2Mbps		Frequency		2480MHz	
Range (MHz)	Max Value chain0 (dBm)	DG (dBi)	GRF (dB)	EIRP (dBm)	E-Field (dBuV/m)	Min E-Field Limit (dBuV/m)	E-Field Margin (dB)
30~1000	-70.94	2.00	4.70	-64.24	31.02	40.00	-8.98

Note:

1. GRF = Ground Reflection Factor.
2. DG = Directional Gain.
3. Worst case of emission limit below 1GHz is selected to be limit.

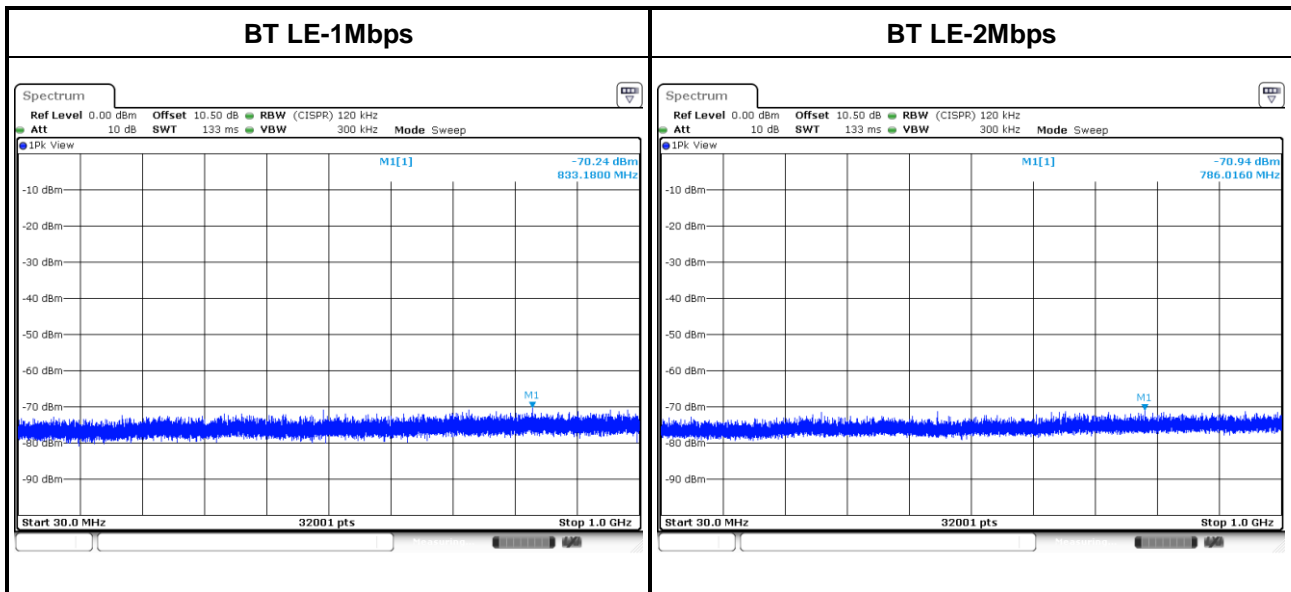

3.5.11 Transmitter Conducted Unwanted Emissions (Above 1GHz) in Band Edge

Transmitter Conducted Unwanted Emissions Results in Band Edge								
Modulation Mode		BT LE-1Mbps						
Test ch. Freq. (MHz)	Range (MHz)	Max Value chain0 (dBm)	DG (dBi)	EIRP (dBm)	E-Field (dBuV/m)	E-Field Limit (dBuV/m)	E-Field Margin (dB)	Remark
2402	2310~2390	-48.25	2.00	-46.25	49.01	74.00	-24.99	PK
	2310~2390	-55.17	2.00	-53.17	42.09	54.00	-11.91	AV
	2483.5~2690	-49.27	2.00	-47.27	47.99	74.00	-26.01	PK
	2483.5~2690	-57.81	2.00	-55.81	39.45	54.00	-14.55	AV
2440	2310~2390	-48.25	2.00	-46.25	49.01	74.00	-24.99	PK
	2310~2390	-58.49	2.00	-56.49	38.77	54.00	-15.23	AV
	2483.5~2500	-47.94	2.00	-45.94	49.32	74.00	-24.68	PK
	2483.5~2500	-55.78	2.00	-53.78	41.48	54.00	-12.52	AV
2480	2310~2390	-49.85	2.00	-47.85	47.41	74.00	-26.59	PK
	2310~2390	-58.23	2.00	-56.23	39.03	54.00	-14.97	AV
	2483.5~2690	-36.92	2.00	-34.92	60.34	74.00	-13.66	PK
	2483.5~2690	-53.96	2.00	-51.96	43.30	54.00	-10.70	AV

Note: DG = Directional Gain.

Band Edge Test Plot

2402MHz - AV

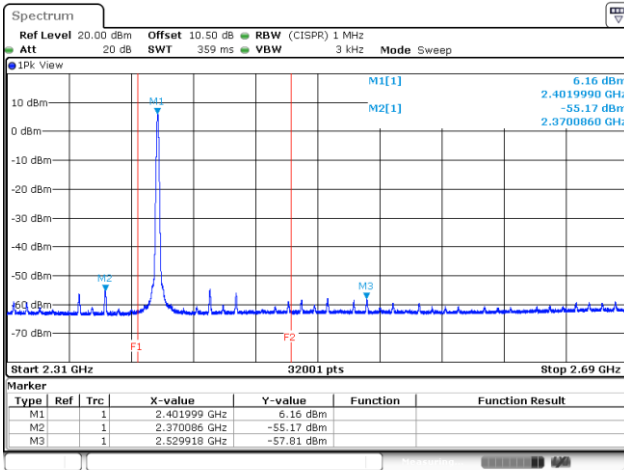

2402MHz - PK

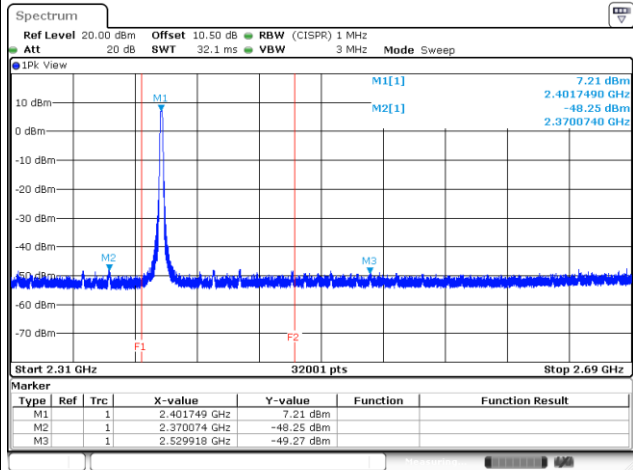

2440MHz - AV

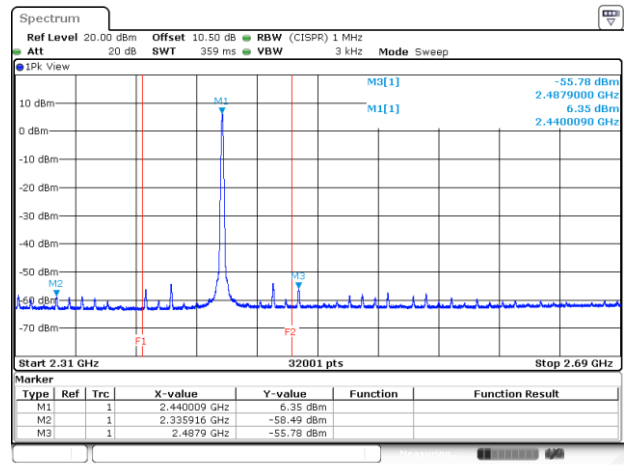

2440MHz - PK

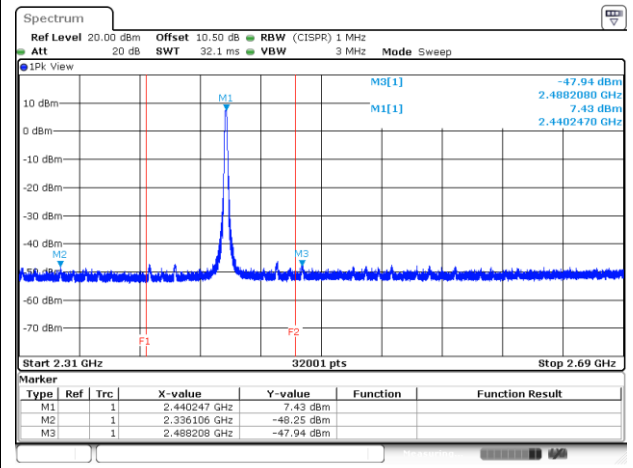

2480MHz - AV

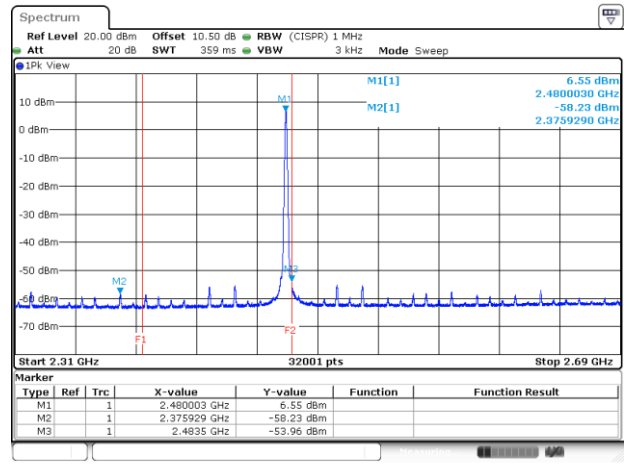

2480MHz - PK

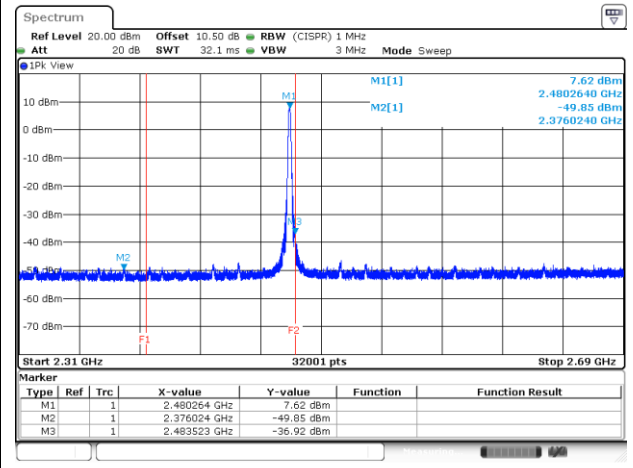

Transmitter Conducted Unwanted Emissions Results in Band Edge								
Modulation Mode		BT LE-2Mbps						
Test ch. Freq. (MHz)	Range (MHz)	Max Value chain0 (dBm)	DG (dBi)	EIRP (dBm)	E-Field (dBuV/m)	E-Field Limit (dBuV/m)	E-Field Margin (dB)	Remark
2402	2310~2390	-47.61	2.00	-45.61	49.65	74.00	-24.35	PK
	2310~2390	-55.80	2.00	-53.80	41.46	54.00	-12.54	AV
	2483.5~2500	-47.44	2.00	-45.44	49.82	74.00	-24.18	PK
	2483.5~2500	-57.87	2.00	-55.87	39.39	54.00	-14.61	AV
2440	2310~2390	-49.22	2.00	-47.22	48.04	74.00	-25.96	PK
	2310~2390	-59.09	2.00	-57.09	38.17	54.00	-15.83	AV
	2483.5~2500	-47.25	2.00	-45.25	50.01	74.00	-23.99	PK
	2483.5~2500	-56.89	2.00	-54.89	40.37	54.00	-13.63	AV
2480	2310~2390	-49.90	2.00	-47.90	47.36	74.00	-26.64	PK
	2310~2390	-59.27	2.00	-57.27	37.99	54.00	-16.01	AV
	2483.5~2690	-38.26	2.00	-36.26	59.00	74.00	-15.00	PK
	2483.5~2690	-50.53	2.00	-48.53	46.73	54.00	-7.27	AV

Note: DG = Directional Gain.

Band Edge Test Plot

2402MHz - AV

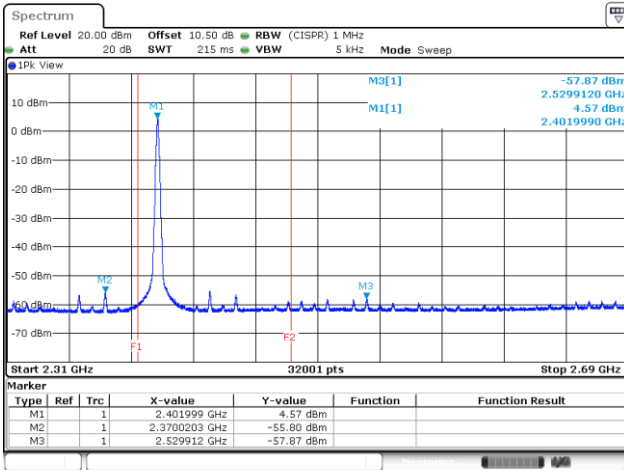

2402MHz - PK

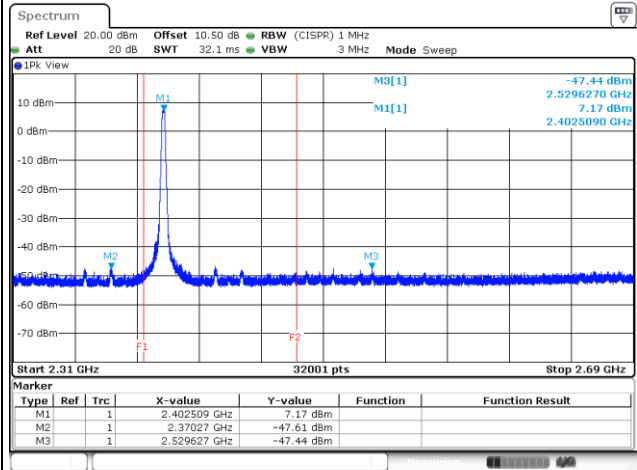

2440MHz - AV

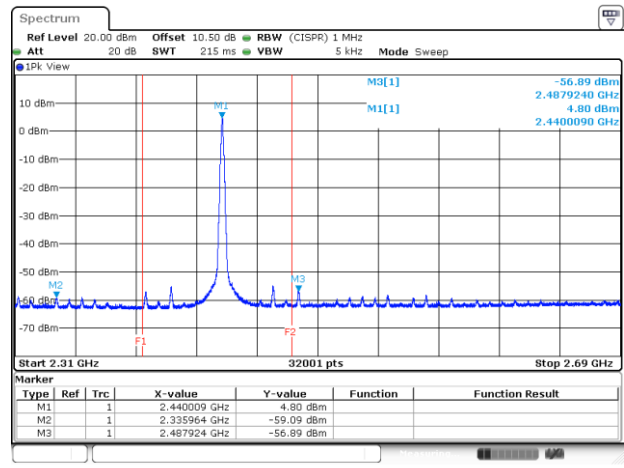

2440MHz - PK

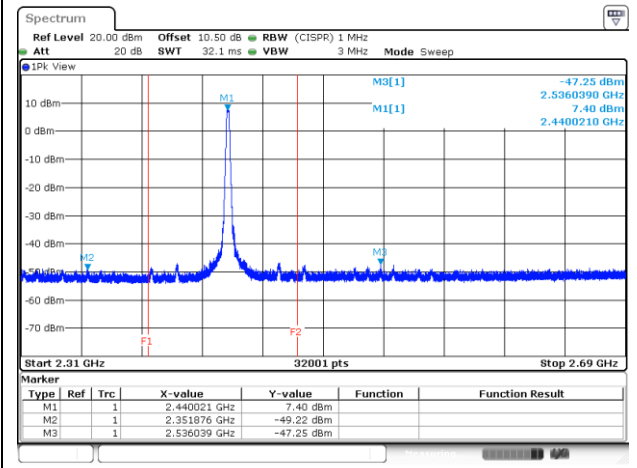

2480MHz - AV

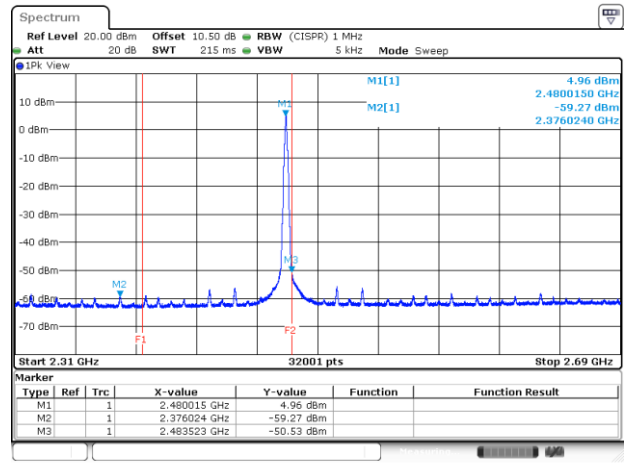

2480MHz - PK

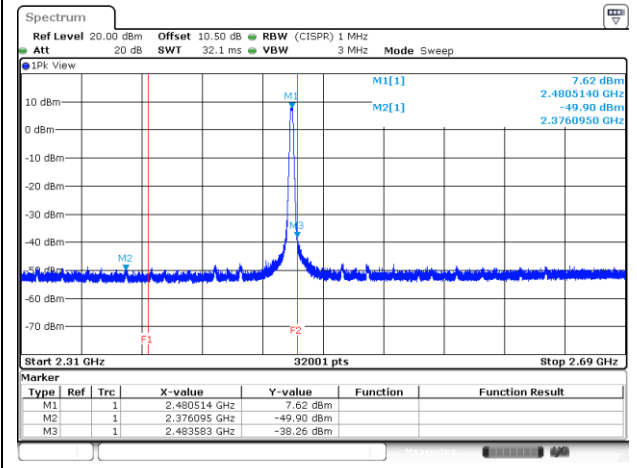

Transmitter Conducted Unwanted Emissions Results in Restricted Frequency Band							
Modulation Mode		BT LE-1Mbps		Frequency		2402MHz	
Freq. (MHz)	Remark	Max Value chain0 (dBm)	DG (dBi)	EIRP (dBm)	E-Field (dBuV/m)	E-Field Limit (dBm)	E-Field Margin (dB)
4804.00	PK	-46.21	2.00	-44.21	51.05	74.00	-22.95
12010.00	PK	-49.72	2.00	-47.72	47.54	74.00	-26.46

Transmitter Conducted Unwanted Emissions Results in Restricted Frequency Band							
Modulation Mode		BT LE-1Mbps		Frequency		2440MHz	
Freq. (MHz)	Remark	Max Value chain0 (dBm)	DG (dBi)	EIRP (dBm)	E-Field (dBuV/m)	E-Field Limit (dBm)	E-Field Margin (dB)
4880.00	PK	-48.77	2.00	-46.77	48.49	74.00	-25.51
7320.00	PK	-53.19	2.00	-51.19	44.07	74.00	-29.93
12200.00	PK	-51.11	2.00	-49.11	46.15	74.00	-27.85

Transmitter Conducted Unwanted Emissions Results in Restricted Frequency Band							
Modulation Mode		BT LE-1Mbps		Frequency		2480MHz	
Freq. (MHz)	Remark	Max Value chain0 (dBm)	DG (dBi)	EIRP (dBm)	E-Field (dBuV/m)	E-Field Limit (dBm)	E-Field Margin (dB)
4960.00	PK	-51.19	2.00	-49.19	46.07	74.00	-27.93
7440.00	PK	-54.10	2.00	-52.10	43.16	74.00	-30.84
12400.00	PK	-52.58	2.00	-50.58	44.68	74.00	-29.32

Note:

1. If the PK margin greater than 20 dB, there is no need to get AVG reading.
2. DG = Directional Gain.

Test Plots

4804MHz - PK

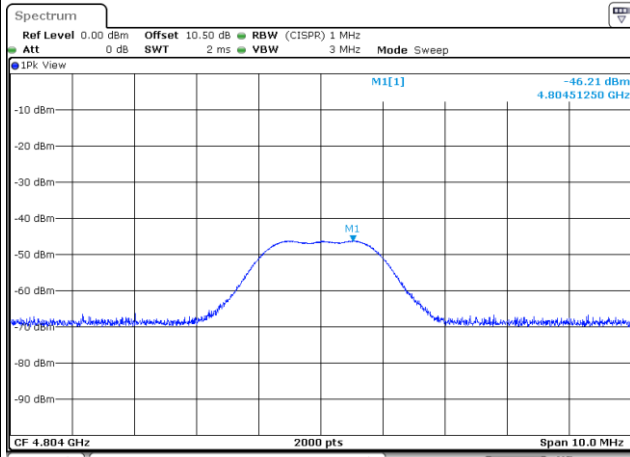

12010MHz - PK

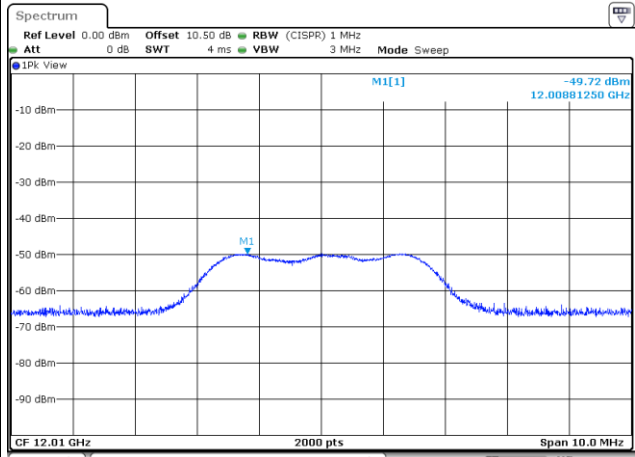

4880MHz - PK

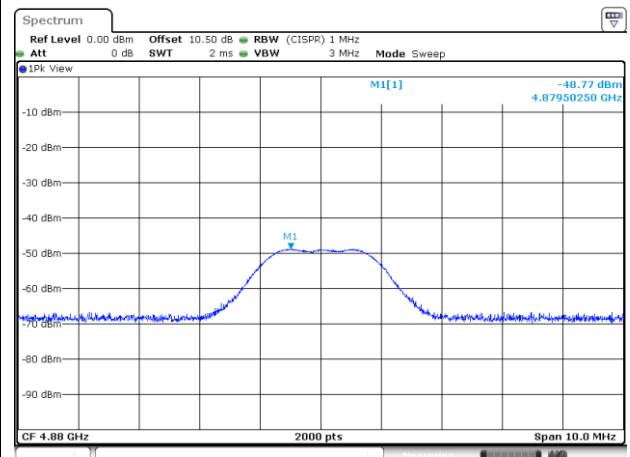

7320MHz - PK

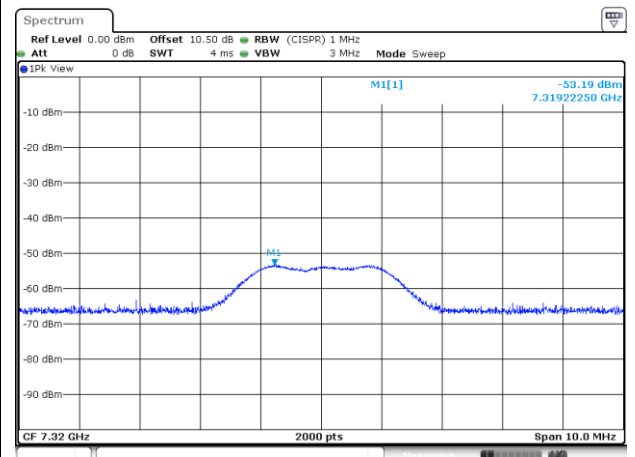

12200MHz - PK

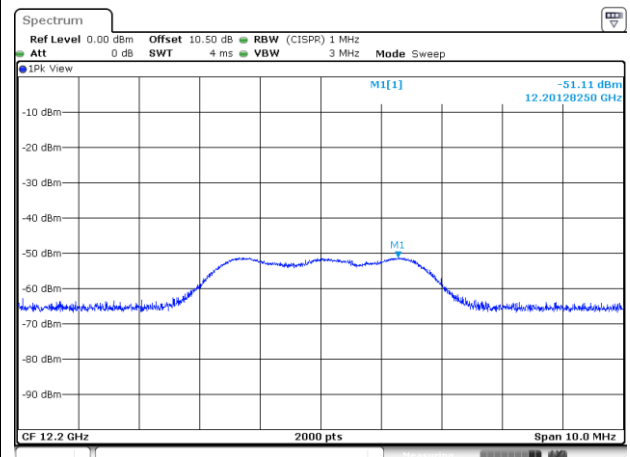

4960MHz - PK

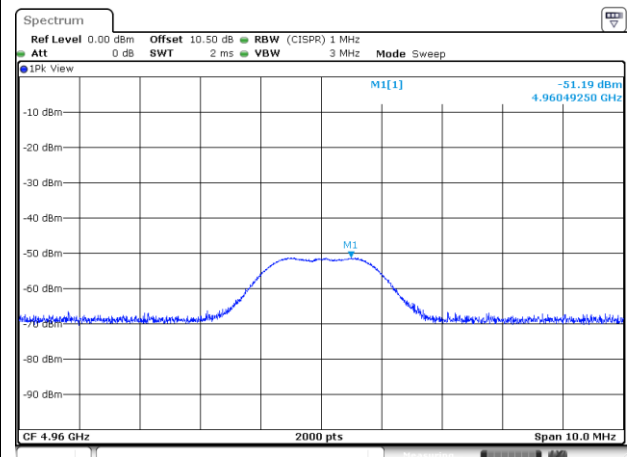

Test Plots

7440MHz - PK

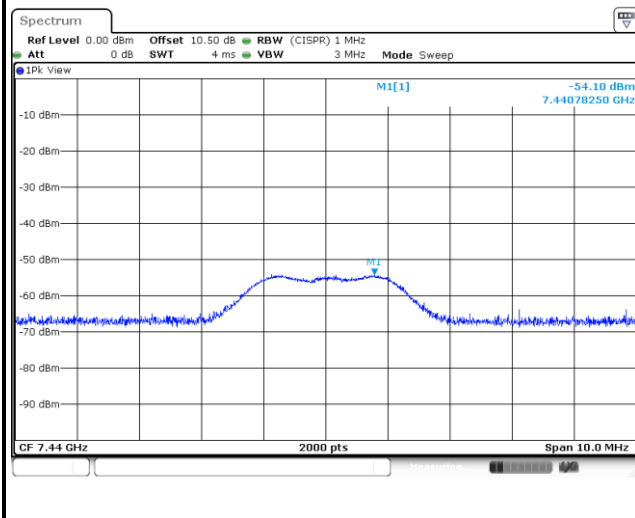

12400MHz - PK

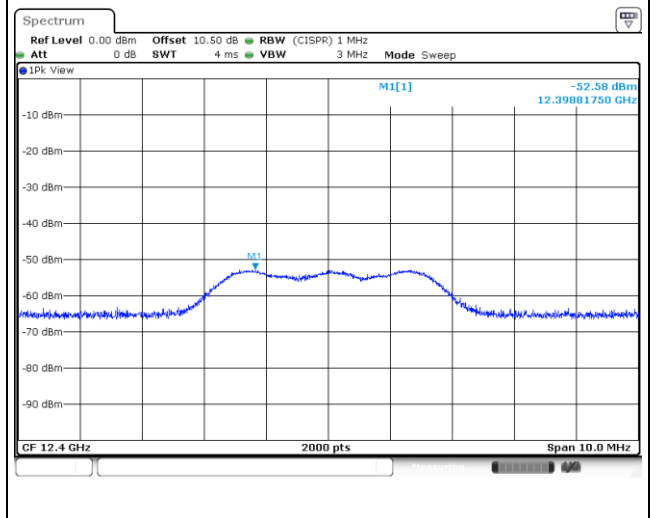

Transmitter Conducted Unwanted Emissions Results in Restricted Frequency Band							
Modulation Mode		BT LE-2Mbps		Frequency		2402MHz	
Freq. (MHz)	Remark	Max Value chain0 (dBm)	DG (dBi)	EIRP (dBm)	E-Field (dBuV/m)	E-Field Limit (dBm)	E-Field Margin (dB)
4804.00	PK	-46.29	2.00	-44.29	50.97	74.00	-23.03
12010.00	PK	-50.00	2.00	-48.00	47.26	74.00	-26.74

Transmitter Conducted Unwanted Emissions Results in Restricted Frequency Band							
Modulation Mode		BT LE-2Mbps		Frequency		2440MHz	
Freq. (MHz)	Remark	Max Value chain0 (dBm)	DG (dBi)	EIRP (dBm)	E-Field (dBuV/m)	E-Field Limit (dBm)	E-Field Margin (dB)
4880.00	PK	-48.99	2.00	-46.99	48.27	74.00	-25.73
7320.00	PK	-53.94	2.00	-51.94	43.32	74.00	-30.68
12200.00	PK	-51.25	2.00	-49.25	46.01	74.00	-27.99

Transmitter Conducted Unwanted Emissions Results in Restricted Frequency Band							
Modulation Mode		BT LE-2Mbps		Frequency		2480MHz	
Freq. (MHz)	Remark	Max Value chain0 (dBm)	DG (dBi)	EIRP (dBm)	E-Field (dBuV/m)	E-Field Limit (dBm)	E-Field Margin (dB)
4960.00	PK	-51.43	2.00	-49.43	45.83	74.00	-28.17
7440.00	PK	-54.51	2.00	-52.51	42.75	74.00	-31.25
12400.00	PK	-52.45	2.00	-50.45	44.81	74.00	-29.19

Note:

1. If the PK margin greater than 20 dB, there is no need to get AVG reading.
2. DG = Directional Gain.

Test Plots

4804MHz - PK

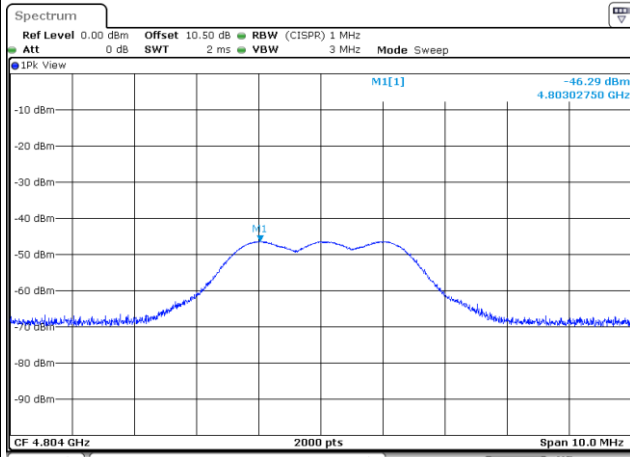

12010MHz - PK

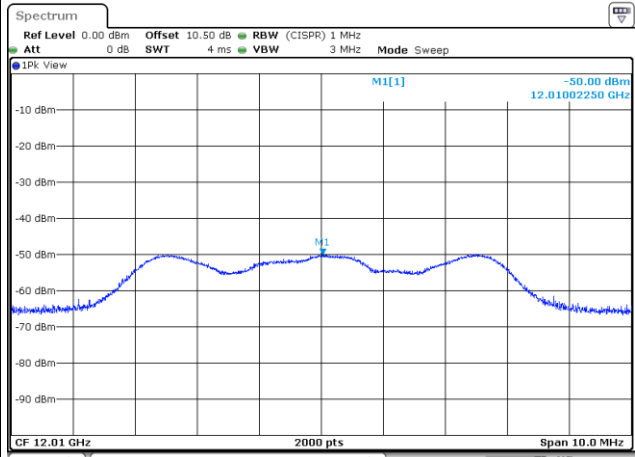

4880MHz - PK

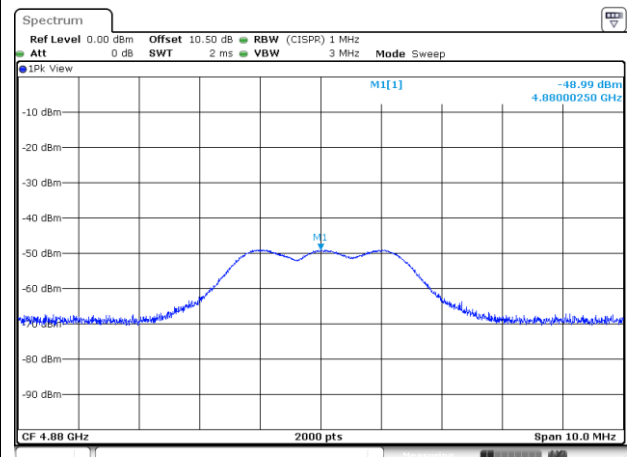

7320MHz - PK

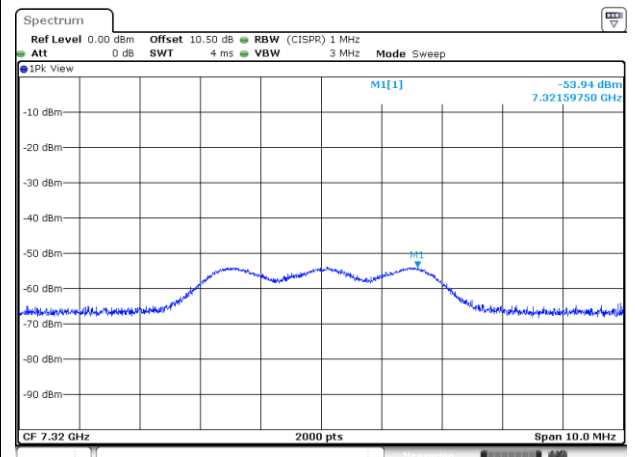

12200MHz - PK

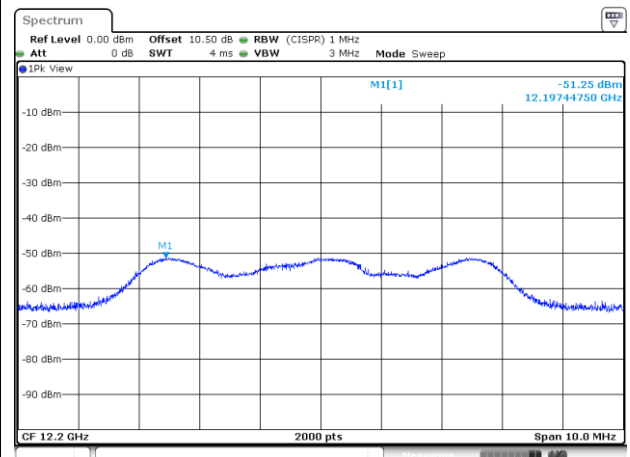

4960MHz - PK

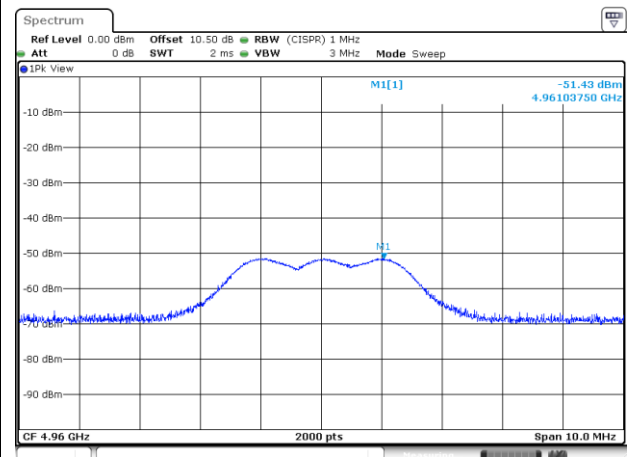

Test Plots

7440MHz - PK

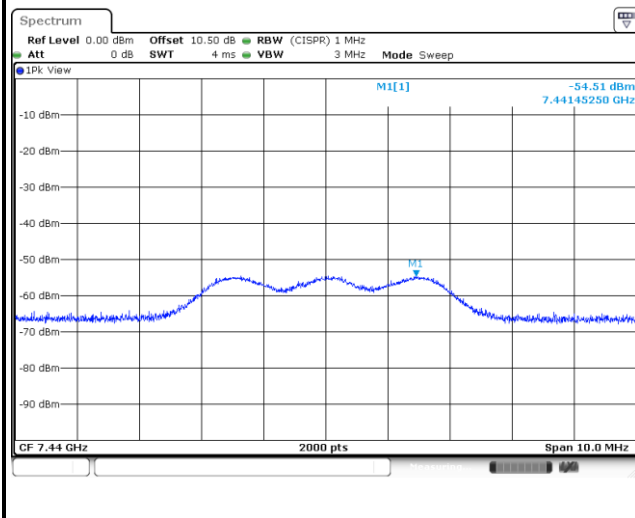

12400MHz - PK

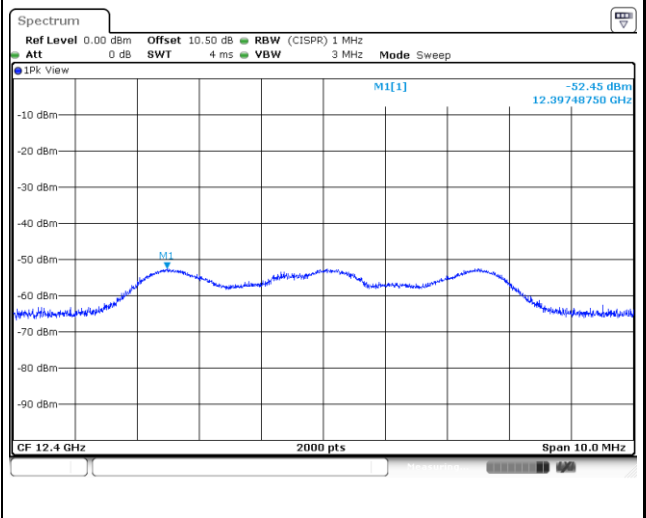

BT LE-1Mbps - Full Range Scan Test Plot

2402MHz

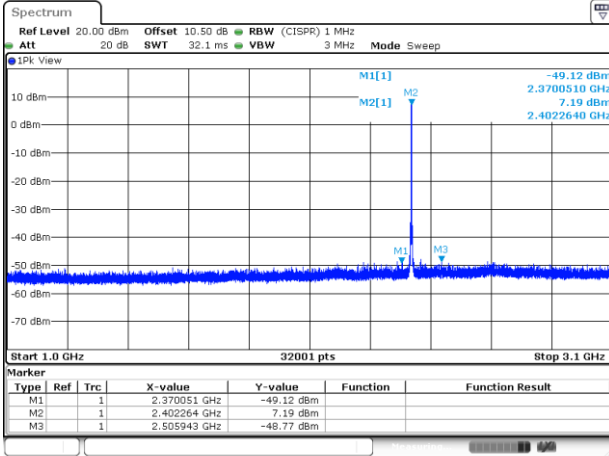

2402MHz

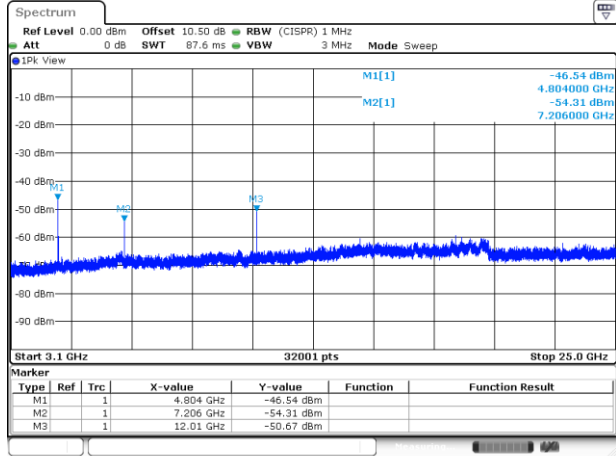

2440MHz

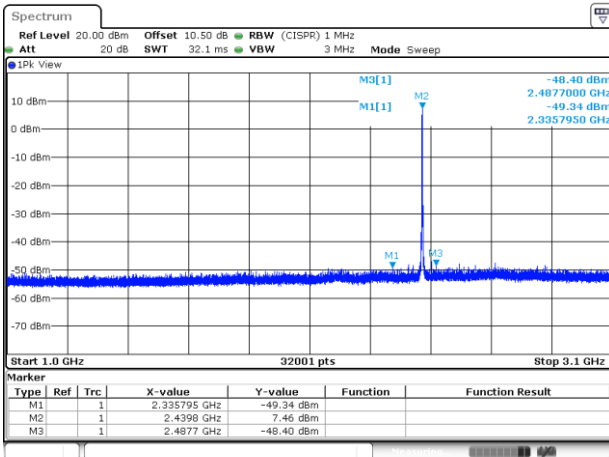

2440MHz

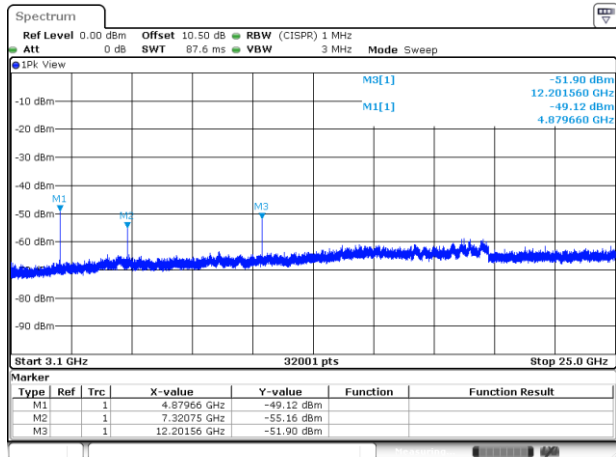

2480MHz

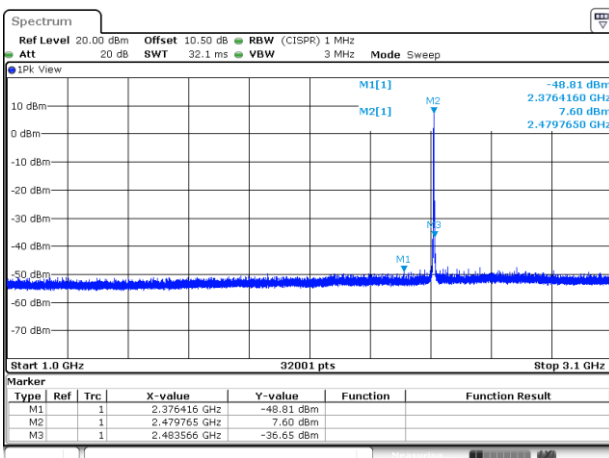

2480MHz

