

FCC C2PC Test Report

FCC ID : SQG-WB50NBT
Equipment : Wireless 802.11abgn + BT4.1 intelligent module
Model No. : WB50NBT
Brand Name : Laird Connectivity
Applicant : Laird Connectivity
Address : W66N220 Commerce Court, Cedarburg, Wisconsin 53012, USA
Standard : 47 CFR FCC Part 15.407
Received Date : Apr. 02, 2020
Tested Date : Apr. 02 ~ Jun. 04, 2020

We, International Certification Corp., would like to declare that the tested sample has been evaluated and in compliance with the requirement of the above standards. The test results contained in this report refer exclusively to the product. It may be duplicated completely for legal use with the approval of the applicant. It shall not be reproduced except in full without the written approval of our laboratory.

Reviewed by:



Along Chen / Assistant Manager

Approved by:



Gary Chang / Manager



Table of Contents

1	GENERAL DESCRIPTION	5
1.1	Information.....	5
1.2	Local Support Equipment List	9
1.3	Test Setup Chart	9
1.4	The Equipment List	10
1.5	Test Standards	11
1.6	Deviation from Test Standard and Measurement Procedure.....	11
1.7	Measurement Uncertainty	12
2	TEST CONFIGURATION.....	13
2.1	Testing Condition	13
2.2	Testing Facility	13
2.3	The Worst Test Modes and Channel Details	14
3	TRANSMITTER TEST RESULTS	16
3.1	Conducted Emissions.....	16
3.2	Emission Bandwidth	21
3.3	RF Output Power.....	34
3.4	Peak Power Spectral Density.....	40
3.5	Transmitter Radiated and Band Edge Emissions	54
3.6	Frequency Stability.....	295
4	TEST LABORATORY INFORMATION	298

Release Record

Report No.	Version	Description	Issued Date
FR631002-07AN	Rev. 01	Initial issue	Jun. 29, 2020

Summary of Test Results

FCC Rules	Test Items	Measured	Result
15.207	Conducted Emissions	[dBuV]: 16.226MHz 34.59 (Margin -25.41dB) - QP	Pass
15.407(b) 15.209	Radiated Emissions	[dBuV/m at 3m]: 17160.00MHz 67.19 (Margin -1.01dB) - PK	Pass
15.407(a)	Emission Bandwidth	Meet the requirement of limit	Pass
15.407(e)	6dB bandwidth	Meet the requirement of limit	Pass
15.407(a)	RF Output Power	Max Power [dBm]: 5150~5250MHz: 20.41 5250~5350MHz: 19.59 5470~5725MHz: 20.17 5725~5850MHz: 19.44	Pass
15.407(a)	Peak Power Spectral Density	Meet the requirement of limit	Pass
15.407(g)	Frequency Stability	Meet the requirement of limit	Pass
15.203	Antenna Requirement	Meet the requirement of limit	Pass

Declaration of Conformity:

The test results with all measurement uncertainty excluded are presented in accordance with the regulation limits or requirements declared by manufacturers.

Comments and Explanations:

The declared of product specification for EUT presented in the report are provided by the manufacturer, and the manufacturer takes all the responsibilities for the accuracy of product specification.

1 General Description

1.1 Information

This is a Class II Permissive Change report (C2PC).

This report is issued as a supplementary report to the original project no. FR631002AN. The modification is concerned with

1. decreasing output power by software setting
2. adding channel 144 / 142 by software setting
3. adding new antennas.
4. Updated brand name and applicant.

In this test report, relative test items have been re-tested and its data was recorded in the following sections.

1.1.1 Specification of the Equipment under Test (EUT)

RF General Information					
Frequency Range (MHz)	IEEE Std. 802.11	Ch. Freq. (MHz)	Channel Number	Transmit Chains (N _{TX})	Data Rate / MCS
5150-5250 5250-5350 5470-5725 5725-5850	a	5180-5240 5260-5320 5500-5720 5745-5825	36-48 [4] 52-64 [4] 100-144 [12] 149-165 [5]	1 2	6-54 Mbps
5150-5250 5250-5350 5470-5725 5725-5850	n (HT20)	5180-5240 5260-5320 5500-5720 5745-5825	36-48 [4] 52-64 [4] 100-144 [12] 149-165 [5]	1 2 2	MCS 0-7 MCS 0-7 MCS 8-15
5150-5250 5250-5350 5470-5725 5725-5850	n (HT40)	5190-5230 5270-5310 5510-5710 5755-5795	38-46 [2] 54-62 [2] 102-142 [6] 151-159 [2]	1 2 2	MCS 0-7 MCS 0-7 MCS 8-15
<p>Note 1: RF output power specifies that Maximum Conducted Output Power. Note 2: 802.11a/n uses a combination of OFDM-BPSK, QPSK, 16QAM, 64QAM, modulation. Note 3: The device supports TX antenna diversity function. The conducted power of single chain is same for 1TX and 2TX operating mode. Therefore, Ant1+Ant2 configuration is chosen for final testing.</p>					

1.1.2 Antenna Details (New set of antennas were marked in boldface.)

Ant. No.	Model	Type	Connector	Operating Frequencies (MHz) / Antenna Gain (dBi)				
				2400~2483.5	5150~5250	5250~5350	5470~5725	5725~5850
1	Laird MAF94051	Dipole	RP-SMA	2.1	2.4	2.6	3.4	3.4
2	Laird NanoBlade-IP04	PCB Dipole	IPEX MHF	2	3.9	3.9	4	4
3	Laird MAF95310 Mini NanoBlade Flex	PCB Dipole	IPEX MHF	2.79	3.38			
4	Laird NanoBlue-IP04	PCB Dipole	IPEX MHF	2	---	---	---	---
5	Ethertronics WLAN_1000146	Isolated Magnetic Dipole	IPEX MHF	2.5	3.5			
6	Ethertronics 1004450	PCB Dipole	U.FI	1.3	2.69	2.69	2	1.9
7	Ethertronics 1004788	Dipole	U.FI	2.2	2.7			
8	Ethertronics 1004791	Dipole	U.FI	1.8	2.6			

1.1.3 Power Supply Type of Equipment under Test (EUT)

Power Supply Type	3.3Vdc from host
--------------------------	------------------

1.1.4 Accessories

N/A

1.1.5 Channel List

802.11 a / HT20		HT40	
Channel	Frequency(MHz)	Channel	Frequency(MHz)
36	5180	38	5190
40	5200	46	5230
44	5220	54	5270
48	5240	62	5310
52	5260	102	5510
56	5280	110	5550
60	5300	118	5590
64	5320	126	5630
100	5500	134	5670
104	5520	142	5710
108	5540	151	5755
112	5560	159	5795
116	5580	---	---
120	5600	---	---
124	5620	---	---
128	5640	---	---
132	5660	---	---
136	5680	---	---
140	5700	---	---
144	5720	---	---
149	5745	---	---
153	5765	---	---
157	5785	---	---
161	5805	---	---
165	5825	---	---

1.1.6 Test Tool and Duty Cycle

Test Tool	Tera Term, V4.8		
Duty Cycle and Duty Factor	Mode	Duty Cycle (%)	Duty Factor (dB)
	11a	98.76%	0.05
	HT20	99.11%	0.04
	HT40	98.22%	0.08

1.1.7 Power Index of Test Tool

Modulation Mode	Test Frequency (MHz)	Power Index
11a	5180	18.5
11a	5240	21
11a	5300	20
11a	5500	18
11a	5580	20
11a	5700	16.5
11a	5720	21
11a	5745	21
11a	5785	21
11a	5825	21
HT20	5180	18.5
HT20	5300	20
HT20	5320	19
HT20	5500	18
HT20	5580	20
HT20	5700	16.5
HT20	5720	21
HT20	5785	21
HT20	5825	21
HT40	5190	14.5
HT40	5310	15
HT40	5510	14
HT40	5670	19
HT40	5710	23
HT40	5795	23

1.2 Local Support Equipment List

Support Equipment List						
No.	Equipment	Brand	Model	S/N	FCC ID	Remarks
1	DC Power Supply	GW INSTEK	GPC-3060D	EM884797	---	---
2	Notebook	DELL	Latitude E6430	9ZFB4X1	DoC	---
3	Fixture	---	---	---	---	Provided by applicant

1.3 Test Setup Chart

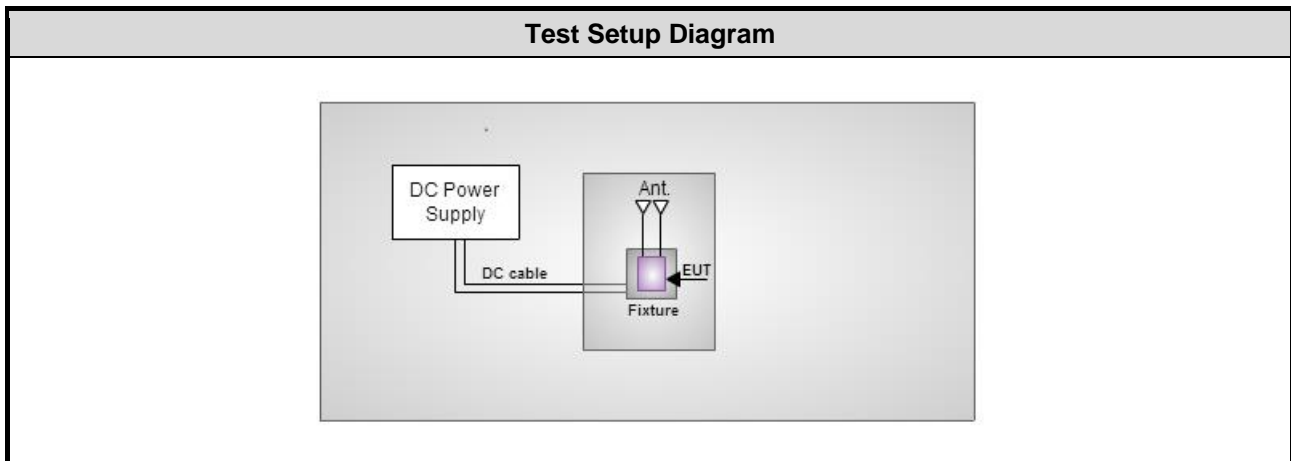

Note: The support notebook was disconnected from EUT and removed from test table when EUT is set to transmit continuously.

1.4 The Equipment List

Test Item	Conducted Emission				
Test Site	Conduction room 1 / (CO01-WS)				
Tested Date	Jun. 04, 2020				
Instrument	Manufacturer	Model No.	Serial No.	Calibration Date	Calibration Until
Receiver	R&S	ESR3	101658	Dec. 12, 2019	Dec. 11, 2020
LISN	R&S	ENV216	101579	Mar. 12, 2020	Mar. 11, 2021
RF Cable-CON	Woken	CFD200-NL	CFD200-NL-001	Oct. 22, 2019	Oct. 21, 2020
Measurement Software	AUDIX	e3	6.120210k	NA	NA
Note: Calibration Interval of instruments listed above is one year.					

Test Item	Radiated Emission				
Test Site	966 chamber 3 / (03CH03-WS)				
Tested Date	Apr. 02 ~ May 31, 2020				
Instrument	Manufacturer	Model No.	Serial No.	Calibration Date	Calibration Until
Spectrum Analyzer	R&S	FSV40	101499	Jan. 09, 2020	Jan. 08, 2021
Receiver	R&S	ESR3	101657	Feb. 14, 2020	Feb. 13, 2021
Bilog Antenna	SCHWARZBECK	VULB9168	VULB9168-522	Jul. 12, 2019	Jul. 11, 2020
Horn Antenna 1G-18G	SCHWARZBECK	BBHA 9120 D	BBHA 9120 D 1206	Dec. 27, 2019	Dec. 26, 2020
Horn Antenna 18G-40G	SCHWARZBECK	BBHA 9170	BBHA 9170517	Nov. 15, 2019	Nov. 14, 2020
Loop Antenna	R&S	HFH2-Z2	100330	Nov. 13, 2019	Nov. 12, 2020
Loop Antenna Cable	KOAX KABEL	101354-BW	101354-BW	Oct. 07, 2019	Oct. 06, 2020
Preamplifier	EMC	EMC02325	980187	Aug. 14, 2019	Aug. 13, 2020
Preamplifier	Agilent	83017A	MY53270014	Aug. 07, 2019	Aug. 06, 2020
Preamplifier	EMC	EMC184045B	980192	Aug. 01, 2019	Jul. 31, 2020
RF cable-3M	HUBER+SUHNER	SUCOFLEX104	MY22620/4	Sep. 27, 2019	Sep. 26, 2020
RF cable-8M	EMC	EMC104-SM-SM-80 00	181107	Sep. 27, 2019	Sep. 26, 2020
RF cable-1M	HUBER+SUHNER	SUCOFLEX104	MY22624/4	Sep. 27, 2019	Sep. 26, 2020
LF cable-0.8M	EMC	EMC8D-NM-NM-800	EMC8D-NM-NM-800 -001	Sep. 27, 2019	Sep. 26, 2020
LF cable-3M	EMC	EMC8D-NM-NM-300 0	131103	Sep. 27, 2019	Sep. 26, 2020
LF cable-13M	EMC	EMC8D-NM-NM-130 00	131104	Sep. 27, 2019	Sep. 26, 2020
Measurement Software	AUDIX	e3	6.120210g	NA	NA
Note: Calibration Interval of instruments listed above is one year.					

Test Item	RF Conducted				
Test Site	(TH01-WS)				
Tested Date	Jun. 05, 2020				
Instrument	Manufacturer	Model No.	Serial No.	Calibration Date	Calibration Until
Spectrum Analyzer	R&S	FSV40	101063	Apr. 30, 2020	Apr. 29, 2021
TEMP&HUMIDITY CHAMBER	GIANT FORCE	GCT-225-40-SP-SD	MAF1212-002	Dec. 12, 2019	Dec. 11, 2020
Power Meter	Anritsu	ML2495A	1241002	Oct. 23, 2019	Oct. 22, 2020
Power Sensor	Anritsu	MA2411B	1207366	Oct. 23, 2019	Oct. 22, 2020
DC POWER SOURCE	GW INSTRON	GPC-6030D	GES855395	Oct. 29, 2019	Oct. 28, 2020
Measurement Software	Sporton	Sporton_1	1.3.30	NA	NA
Note: Calibration Interval of instruments listed above is one year.					

1.5 Test Standards

47 CFR FCC Part 15.407

ANSI C63.10-2013

FCC KDB 789033 D02 General UNII Test Procedures New Rules v02r01

FCC KDB 662911 D01 Multiple Transmitter Output v02r01

FCC KDB 412172 D01 Determining ERP and EIRP v01r01

1.6 Deviation from Test Standard and Measurement Procedure

None

1.7 Measurement Uncertainty

The measurement uncertainties given below are based on a 95% confidence level (based on a coverage factor (k=2)).

Measurement Uncertainty	
Parameters	Uncertainty
Bandwidth	±34.130 Hz
Conducted power	±0.808 dB
Frequency error	±1×10 ⁻⁹
Power density	±0.583 dB
Conducted emission	±2.715 dB
AC conducted emission	±2.92 dB
Radiated emission ≤ 1GHz	±3.96 dB
Radiated emission > 1GHz	±4.51 dB
Time	±0.1%
Temperature	±0.4 °C

2 Test Configuration

2.1 Testing Condition

Test Item	Test Site	Ambient Condition	Tested By
AC Conduction	CO01-WS	25°C / 62%	Alex Tsai
Radiated Emissions	03CH03-WS	21-25°C / 62-67%	Brad Wu Roger Lu Aska Huang
RF Conducted	TH01-WS	24°C / 67%	Aska Huang

- FCC Designation No.: TW0009
- FCC site registration No.: 207696
- ISED#: 10807A
- CAB identifier: TW2732

2.2 Testing Facility

Test Laboratory	International Certification Corp.
Test Site	CO01-WS, TH01-WS
Address of Test Site	No. 3-1, Lane 6, Wen San 3rd St., Kwei Shan District, Tao Yuan City 333, Taiwan, R.O.C.
Test Site	03CH03-WS
Address of Test Site	No. 14-1, Lane 19, Wen San 3rd St., Kwei Shan District, Tao Yuan City 333, Taiwan, R.O.C.

2.3 The Worst Test Modes and Channel Details

Frequency band 5150~5250 MHz / 5250~5350 MHz / 5470~5725 MHz				
Test item	Modulation Mode	Test Frequency (MHz)	Data Rate (Mbps) / MCS	Test Configuration
Conducted Emissions	11a	5240	6 Mbps	4
Radiated Emissions ≤1GHz	11a	5240	6 Mbps	1, 2, 3,4
RF Output Power Emission Bandwidth Peak Power Spectral Density	11a	5180 / 5240 / 5300 / 5500 / 5580 / 5700 / 5720	6 Mbps	2
	HT20	5180 / 5300 / 5320 / 5500 / 5580 / 5700 / 5720	MCS 0	
	HT40	5190 / 5310 / 5510 / 5670 / 5710	MCS 0	
Radiated Emissions >1GHz	11a	5180 / 5240 / 5300 / 5500 / 5580 / 5700 / 5720	6 Mbps	1, 2, 3
	HT20	5180 / 5300 / 5320 / 5500 / 5580 / 5700 / 5720	MCS 0	
	HT40	5190 / 5310 / 5510 / 5670 / 5710	MCS 0	
Radiated Emissions >1GHz	11a	5180 / 5200 / 5240 / 5260 / 5300 / 5320 / 5500 / 5580 / 5700 / 5720	6 Mbps	4
	HT20	5180 / 5200 / 5240 / 5260 / 5300 / 5320 / 5500 / 5580 / 5700 / 5720	MCS 0	
	HT40	5190 / 5230 / 5270 / 5310 / 5510 / 5590 / 5670 / 5710	MCS 0	
Frequency Stability	Un-modulation	5320	---	---

NOTE:

- The EUT was pretested with 3 orientations placed on the table for the radiated emission measurement – X, Y, and Z-plane. The **Z-plane** results were found as the worst case and were shown in this report.
- The following antennas are used for final testing for this module: (See item 1.1.2 for more details.)
 - Configuration 1 : Antenna MAF94051
 - Configuration 2 : Antenna NanoBlade-IP04
 - Configuration 3 : Antenna WLAN_1000146
 - Configuration 4 : Antenna 1004788 & 1004791

Frequency band 5725-5850 MHz				
Test item	Modulation Mode	Test Frequency (MHz)	Data Rate (Mbps) / MCS	Test Configuration
Conducted Emissions	HT40	5795	MCS 0	4
Radiated Emissions ≤1GHz	HT40	5795	MCS 0	1, 2, 3,4
RF Output Power	11a	5745 / 5785 / 5825	6 Mbps	2
Emission Bandwidth	HT20	5785 / 5825	MCS 0	
6dB bandwidth	HT40	5795	MCS 0	
Peak Power Spectral Densit	HT40	5795	MCS 0	
Radiated Emissions >1GHz	11a	5745 / 5785 / 5825	6 Mbps	1, 2, 3
	HT20	5785 / 5825	MCS 0	
	HT40	5795	MCS 0	
Radiated Emissions >1GHz	11a	5745 / 5785 / 5825	6 Mbps	4
	HT20	5745 / 5785 / 5825	MCS 0	
	HT40	5755 / 5795	MCS 0	
Frequency Stability	Un-modulation	5785	---	---

NOTE:

- The EUT was pretested with 3 orientations placed on the table for the radiated emission measurement – X, Y, and Z-plane. The **Z-plane** results were found as the worst case and were shown in this report.
- The following antennas are used for final testing for this module: (See item 1.1.2 for more details.)
 - Configuration 1 : Antenna MAF94051
 - Configuration 2 : Antenna NanoBlade-IP04
 - Configuration 3 : Antenna WLAN_1000146
 - Configuration 4 : Antenna 1004788 & 1004791

3 Transmitter Test Results

3.1 Conducted Emissions

3.1.1 Limit of Conducted Emissions

Conducted Emissions Limit		
Frequency Emission (MHz)	Quasi-Peak	Average
0.15-0.5	66 - 56 *	56 - 46 *
0.5-5	56	46
5-30	60	50

Note 1: * Decreases with the logarithm of the frequency.

3.1.2 Test Procedures

1. The device is placed on a test table, raised 80 cm above the reference ground plane. The vertical conducting plane is located 40 cm to the rear of the device.
2. The device is connected to line impedance stabilization network (LISN) and other accessories are connected to other LISN. Measured levels of AC power line conducted emission are across the 50 Ω LISN port.
3. AC conducted emission measurements is made over frequency range from 150 kHz to 30 MHz.
4. This measurement was performed with AC 120V/60Hz

3.1.3 Test Setup

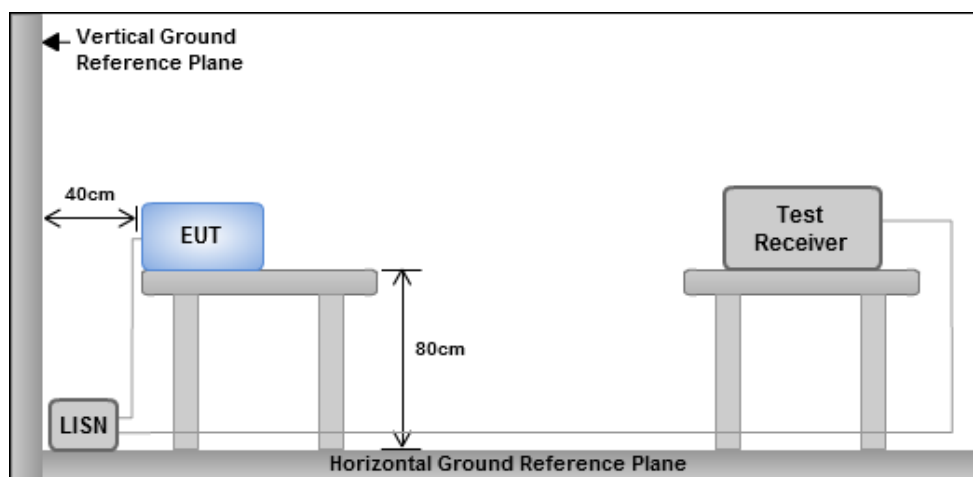

- Note: 1. Support units were connected to second LISN.
 2. Both of LISNs (AMN) are 80 cm from EUT and at least 80 cm from other units and other metal planes

3.1.4 Test Result of Conducted Emissions

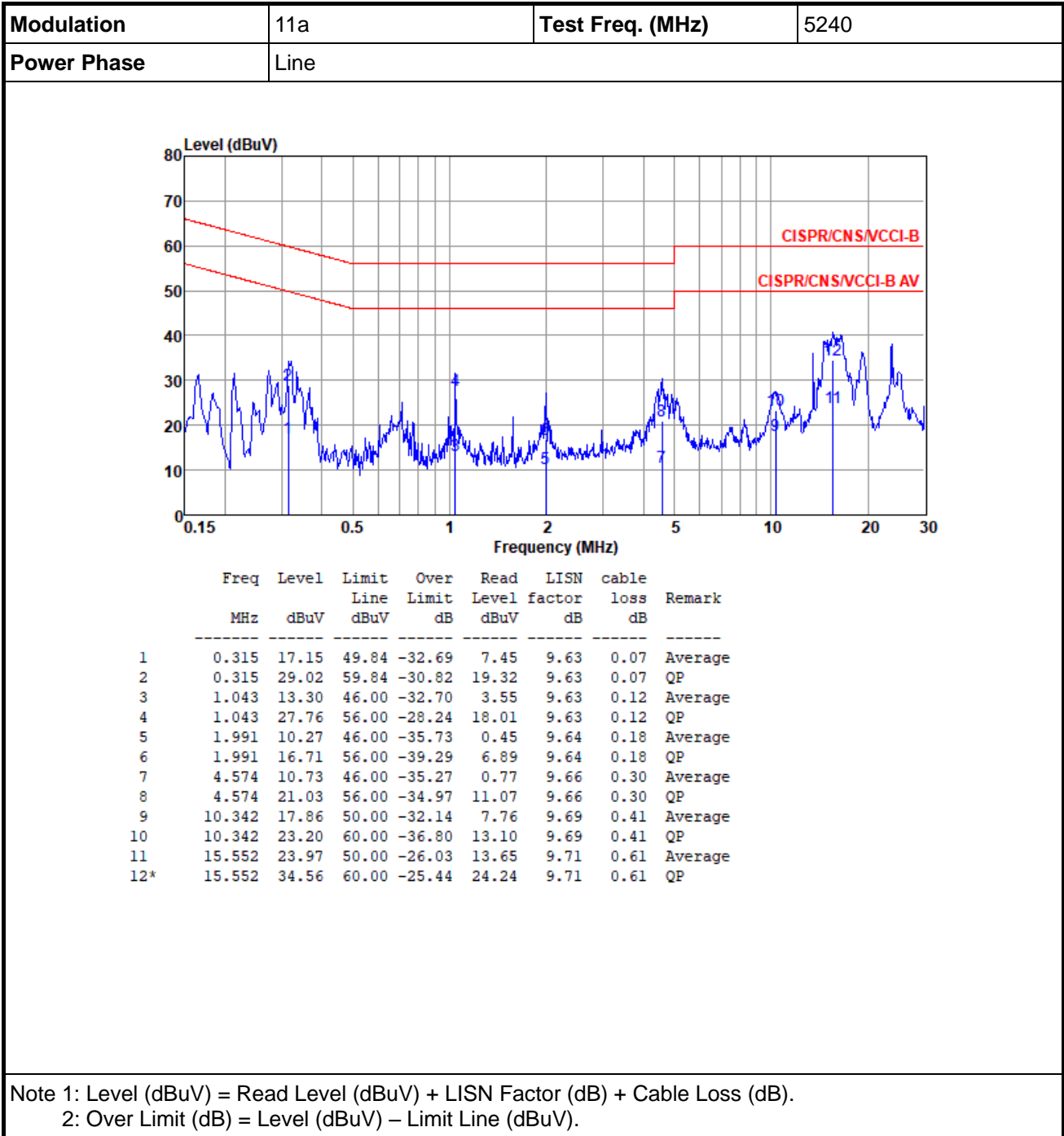

Modulation	11a	Test Freq. (MHz)	5240
Power Phase	Neutral		

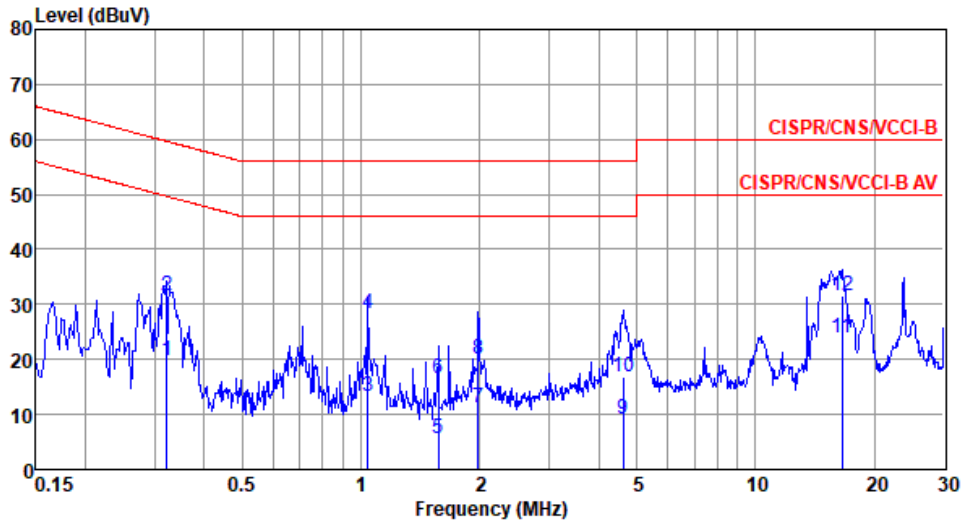

	Freq MHz	Level dBuV	Limit Line dBuV	Over Limit dB	Read Level dBuV	LISN factor dB	cable loss dB	Remark
1	0.322	19.66	49.66	-30.00	9.94	9.65	0.07	Average
2	0.322	31.59	59.66	-28.07	21.87	9.65	0.07	QP
3	1.043	13.35	46.00	-32.65	3.58	9.65	0.12	Average
4	1.043	28.22	56.00	-27.78	18.45	9.65	0.12	QP
5	1.568	5.51	46.00	-40.49	-4.31	9.66	0.16	Average
6	1.568	16.46	56.00	-39.54	6.64	9.66	0.16	QP
7	1.980	11.21	46.00	-34.79	1.37	9.66	0.18	Average
8	1.980	20.20	56.00	-35.80	10.36	9.66	0.18	QP
9	4.622	9.02	46.00	-36.98	-0.97	9.68	0.31	Average
10	4.622	16.69	56.00	-39.31	6.70	9.68	0.31	QP
11*	16.573	23.87	50.00	-26.13	13.44	9.81	0.62	Average
12	16.573	31.66	60.00	-28.34	21.23	9.81	0.62	QP

Note 1: Level (dBuV) = Read Level (dBuV) + LISN Factor (dB) + Cable Loss (dB).
 2: Over Limit (dB) = Level (dBuV) – Limit Line (dBuV).

Modulation	HT40	Test Freq. (MHz)	5795
Power Phase	Line		

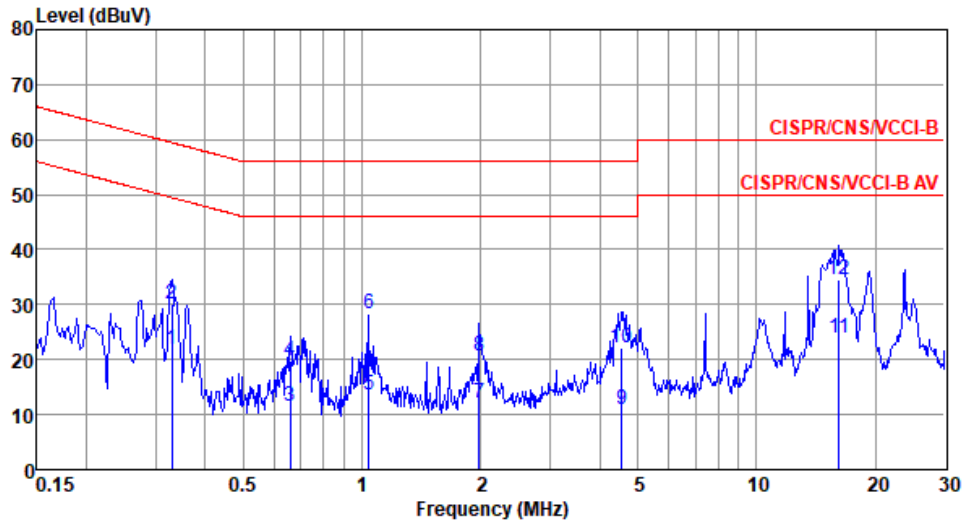

	Freq MHz	Level dBuV	Limit Line dBuV	Over Limit dB	Read Level dBuV	LISN factor dB	cable loss dB	Remark
1	0.330	21.80	49.44	-27.64	12.10	9.63	0.07	Average
2	0.330	30.23	59.44	-29.21	20.53	9.63	0.07	QP
3	0.658	11.51	46.00	-34.49	1.78	9.63	0.10	Average
4	0.658	19.80	56.00	-36.20	10.07	9.63	0.10	QP
5	1.043	13.67	46.00	-32.33	3.92	9.63	0.12	Average
6	1.043	28.45	56.00	-27.55	18.70	9.63	0.12	QP
7	1.980	12.00	46.00	-34.00	2.18	9.64	0.18	Average
8	1.980	20.79	56.00	-35.21	10.97	9.64	0.18	QP
9	4.549	11.04	46.00	-34.96	1.08	9.66	0.30	Average
10	4.549	22.07	56.00	-33.93	12.11	9.66	0.30	QP
11	16.226	23.91	50.00	-26.09	13.58	9.71	0.62	Average
12*	16.226	34.59	60.00	-25.41	24.26	9.71	0.62	QP

Note 1: Level (dBuV) = Read Level (dBuV) + LISN Factor (dB) + Cable Loss (dB).
 2: Over Limit (dB) = Level (dBuV) – Limit Line (dBuV).

Modulation	HT40	Test Freq. (MHz)	5795
Power Phase	Neutral		

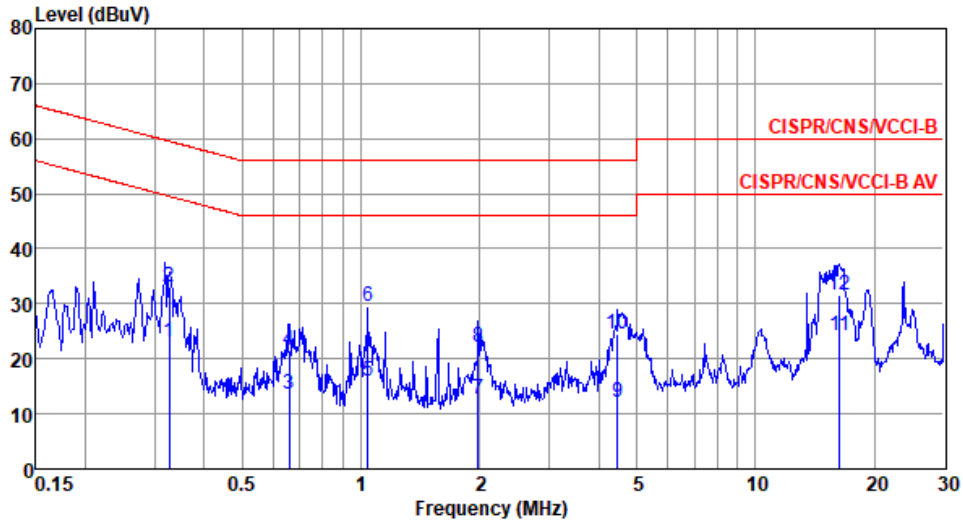

	Freq MHz	Level dBuV	Limit Line dBuV	Over Limit dB	Read Level dBuV	LISN factor dB	cable loss dB	Remark
1	0.327	23.05	49.53	-26.48	13.33	9.65	0.07	Average
2	0.327	32.93	59.53	-26.60	23.21	9.65	0.07	QP
3	0.658	13.49	46.00	-32.51	3.74	9.65	0.10	Average
4	0.658	21.65	56.00	-34.35	11.90	9.65	0.10	QP
5	1.043	15.94	46.00	-30.06	6.17	9.65	0.12	Average
6	1.043	29.65	56.00	-26.35	19.88	9.65	0.12	QP
7	1.980	12.78	46.00	-33.22	2.94	9.66	0.18	Average
8	1.980	22.11	56.00	-33.89	12.27	9.66	0.18	QP
9	4.478	12.11	46.00	-33.89	2.13	9.68	0.30	Average
10	4.478	24.58	56.00	-31.42	14.60	9.68	0.30	QP
11*	16.312	24.08	50.00	-25.92	13.65	9.81	0.62	Average
12	16.312	31.63	60.00	-28.37	21.20	9.81	0.62	QP

Note 1: Level (dBuV) = Read Level (dBuV) + LISN Factor (dB) + Cable Loss (dB).
 2: Over Limit (dB) = Level (dBuV) – Limit Line (dBuV).

3.2 Emission Bandwidth

3.2.1 Limit of Emission Bandwidth

Within the 5.725-5.85 GHz band, the minimum 6 dB bandwidth of U-NII devices shall be at least 500 kHz.

3.2.2 Test Procedures

26dB Bandwidth

1. Set RBW = approximately 1% of the emission bandwidth.
2. Set the VBW > RBW, Detector = Peak.
3. Trace mode = max hold.
4. Measure the maximum width of the emission that is 26 dB down from the peak of the emission.

Occupied Bandwidth

1. Set RBW = 1 % to 5 % of the OBW.
2. Set VBW \geq 3 RBW.
3. Sample detection and single sweep mode shall be used.
4. Use the 99 % power bandwidth function of the instrument.

6dB Bandwidth

1. Set RBW = 100kHz, VBW = 300kHz.
2. Detector = Peak, Trace mode = max hold.
3. Allow the trace to stabilize.
4. Measure the maximum width of the emission that is constrained by the frequencies associated with the two outermost amplitude points (upper and lower frequencies) that are attenuated by 6 dB relative to the maximum level measured in the fundamental emission.

3.2.3 Test Setup

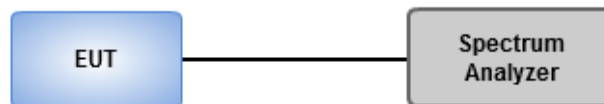

3.2.4 Test Result of Emission Bandwidth

Summary

Mode	Max-N dB (Hz)	Max-OBW (Hz)	ITU-Code	Min-N dB (Hz)	Min-OBW (Hz)
5.15-5.25GHz	-	-	-	-	-
802.11a_Nss1,(6Mbps)_2TX	20.87M	16.425M	16M4D1D	19.203M	16.353M
802.11n HT20_Nss1,(MCS0)_2TX	20.797M	17.583M	17M6D1D	19.783M	17.583M
802.11n HT40_Nss1,(MCS0)_2TX	40.58M	35.601M	35M6D1D	40.435M	35.601M
5.25-5.35GHz	-	-	-	-	-
802.11a_Nss1,(6Mbps)_2TX	20M	16.425M	16M4D1D	19.13M	16.425M
802.11n HT20_Nss1,(MCS0)_2TX	21.014M	17.583M	17M6D1D	19.565M	17.511M
802.11n HT40_Nss1,(MCS0)_2TX	41.014M	35.456M	35M5D1D	40.725M	35.456M
5.47-5.725GHz	-	-	-	-	-
802.11a_Nss1,(6Mbps)_2TX	19.42M	16.425M	16M4D1D	15.304M	13.285M
802.11n HT20_Nss1,(MCS0)_2TX	21.449M	17.583M	17M6D1D	15.435M	13.893M
802.11n HT40_Nss1,(MCS0)_2TX	41.739M	35.745M	35M7D1D	37.942M	32.822M
5.725-5.85GHz	-	-	-	-	-
802.11a_Nss1,(6Mbps)_2TX	16.304M	16.498M	16M5D1D	2.725M	3.357M
802.11n HT20_Nss1,(MCS0)_2TX	15.362M	17.583M	17M6D1D	3.652M	3.936M
802.11n HT40_Nss1,(MCS0)_2TX	33.913M	35.89M	35M9D1D	3.014M	12.33M

Max-N dB = Maximum 6dB down bandwidth for 5.725-5.85GHz band / Maximum 26dB down bandwidth for other band;

Max-OBW = Maximum 99% occupied bandwidth;

Min-N dB = Minimum 6dB down bandwidth for 5.725-5.85GHz band / Maximum 26dB down bandwidth for other band;

Min-OBW = Minimum 99% occupied bandwidth;

Result

Mode	Result	Limit (Hz)	Port 1-N dB (Hz)	Port 1-OBW (Hz)	Port 2-N dB (Hz)	Port 2-OBW (Hz)
802.11a_Nss1,(6Mbps)_2TX	-	-	-	-	-	-
5180MHz	Pass	Inf	19.348M	16.425M	19.203M	16.353M
5240MHz	Pass	Inf	20.87M	16.425M	20.725M	16.425M
5300MHz	Pass	Inf	19.13M	16.425M	20M	16.425M
5500MHz	Pass	Inf	19.13M	16.425M	18.913M	16.353M
5580MHz	Pass	Inf	19.348M	16.425M	18.696M	16.353M
5700MHz	Pass	Inf	19.42M	16.425M	19.42M	16.353M
5720MHz Straddle 5.47-5.725GHz	Pass	Inf	15.304M	13.329M	15.304M	13.285M
5720MHz Straddle 5.725-5.85GHz	Pass	500k	2.725M	4.226M	3.014M	3.357M
5745MHz	Pass	500k	15.87M	16.498M	16.304M	16.353M
5785MHz	Pass	500k	15.29M	16.425M	15.435M	16.353M
5825MHz	Pass	500k	16.232M	16.425M	15.507M	16.353M
802.11n HT20_Nss1,(MCS0)_2TX	-	-	-	-	-	-
5180MHz	Pass	Inf	19.783M	17.583M	20.797M	17.583M
5300MHz	Pass	Inf	20.725M	17.511M	20.58M	17.583M
5320MHz	Pass	Inf	19.565M	17.583M	21.014M	17.583M
5500MHz	Pass	Inf	20.87M	17.583M	20.652M	17.583M
5580MHz	Pass	Inf	21.087M	17.583M	21.449M	17.583M
5700MHz	Pass	Inf	21.159M	17.583M	20.87M	17.583M
5720MHz Straddle 5.47-5.725GHz	Pass	Inf	15.435M	13.893M	15.478M	13.893M
5720MHz Straddle 5.725-5.85GHz	Pass	500k	3.652M	4.515M	3.71M	3.936M
5785MHz	Pass	500k	15.362M	17.583M	14.203M	17.583M
5825MHz	Pass	500k	15.072M	17.583M	15.145M	17.583M
802.11n HT40_Nss1,(MCS0)_2TX	-	-	-	-	-	-
5190MHz	Pass	Inf	40.435M	35.601M	40.58M	35.601M
5310MHz	Pass	Inf	40.725M	35.456M	41.014M	35.456M
5510MHz	Pass	Inf	40.435M	35.601M	40.87M	35.745M
5670MHz	Pass	Inf	40.725M	35.601M	41.739M	35.601M
5710MHz Straddle 5.47-5.725GHz	Pass	Inf	41.087M	32.923M	37.942M	32.822M
5710MHz Straddle 5.725-5.85GHz	Pass	500k	3.014M	19.855M	3.072M	12.33M
5795MHz	Pass	500k	31.304M	35.89M	33.913M	35.601M

Port X-N dB = Port X 6dB down bandwidth for 5.725-5.85GHz band / 26dB down bandwidth for other band

Port X-OBW = Port X 99% occupied bandwidth;

802.11a_Nss1,(6Mbps)_2TX

EBW

5180MHz

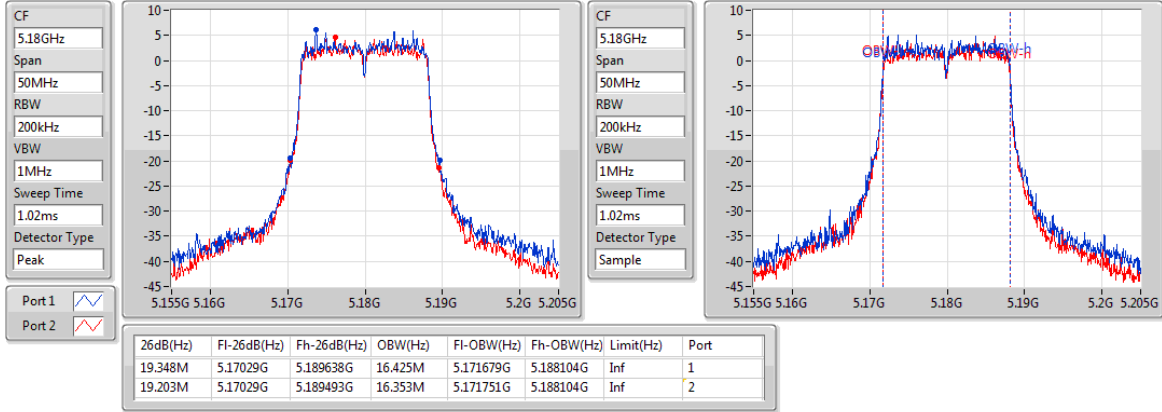

802.11a_Nss1,(6Mbps)_2TX

EBW

5240MHz

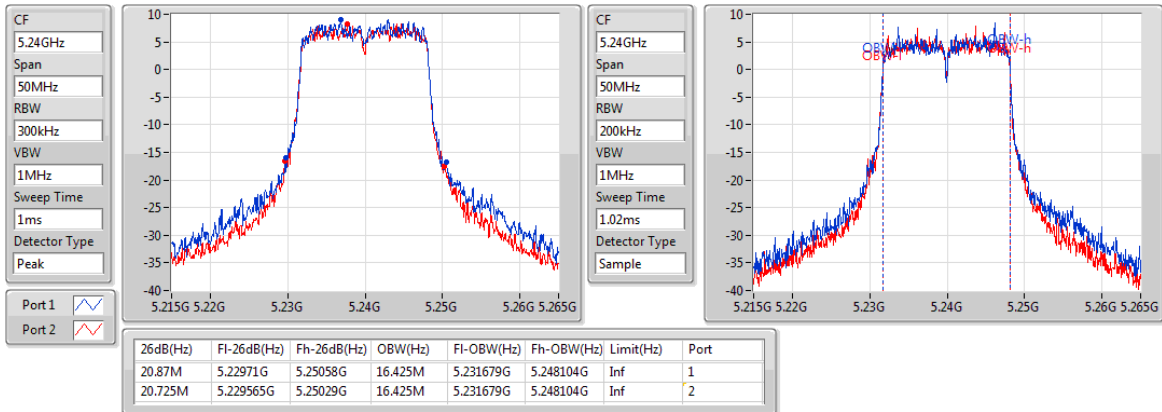

802.11a_Nss1,(6Mbps)_2TX

EBW

5300MHz

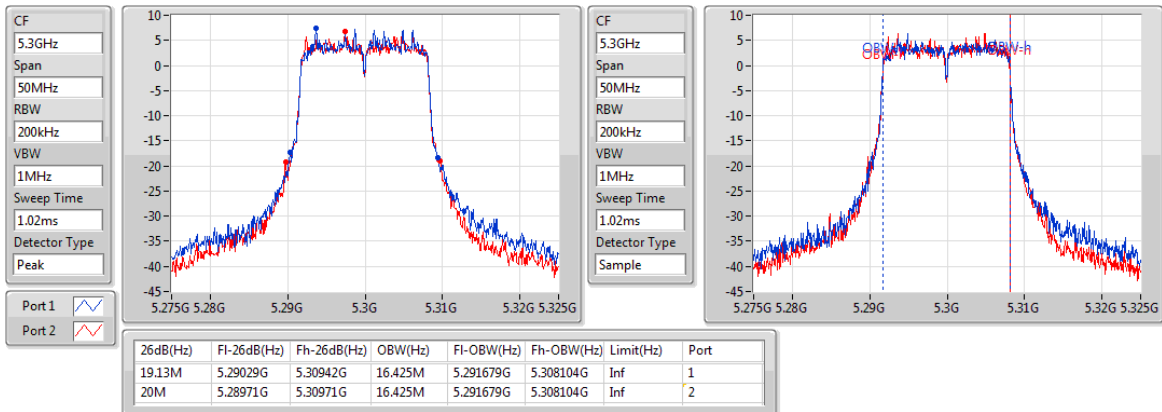

802.11a_Nss1,(6Mbps)_2TX

EBW

5500MHz

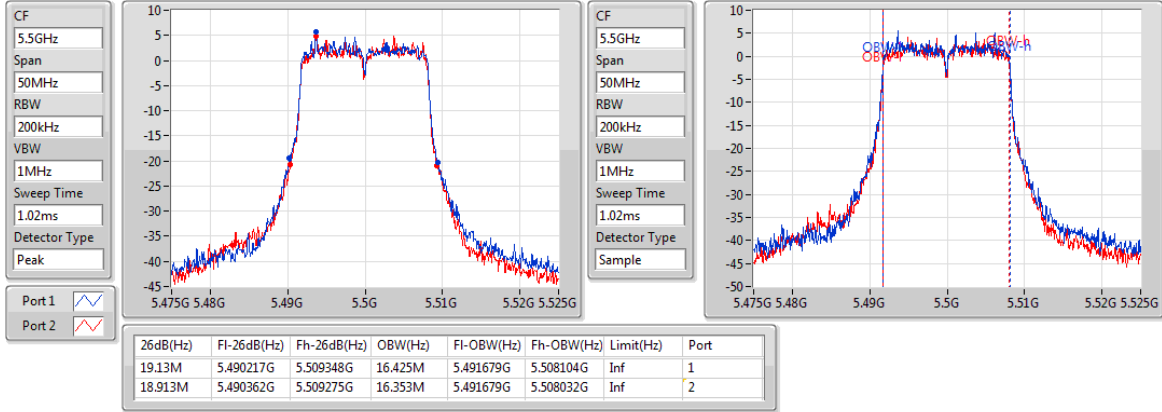

802.11a_Nss1,(6Mbps)_2TX

EBW

5580MHz

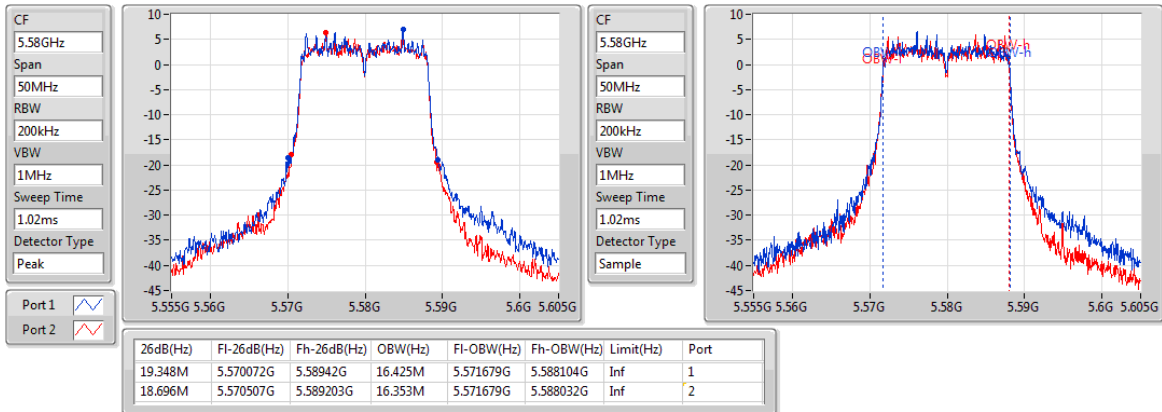

802.11a_Nss1,(6Mbps)_2TX

EBW

5700MHz

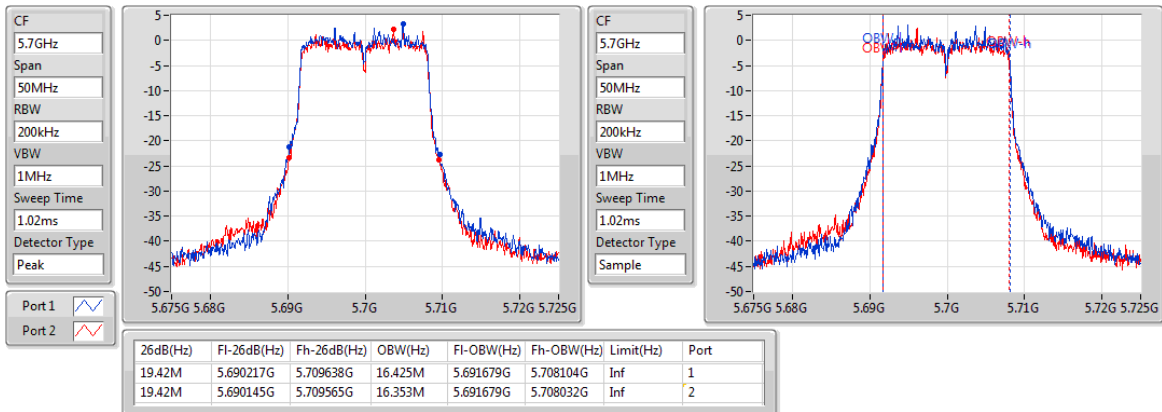

802.11a_Nss1,(6Mbps)_2TX

EBW

5720MHz Straddle 5.47-5.725GHz

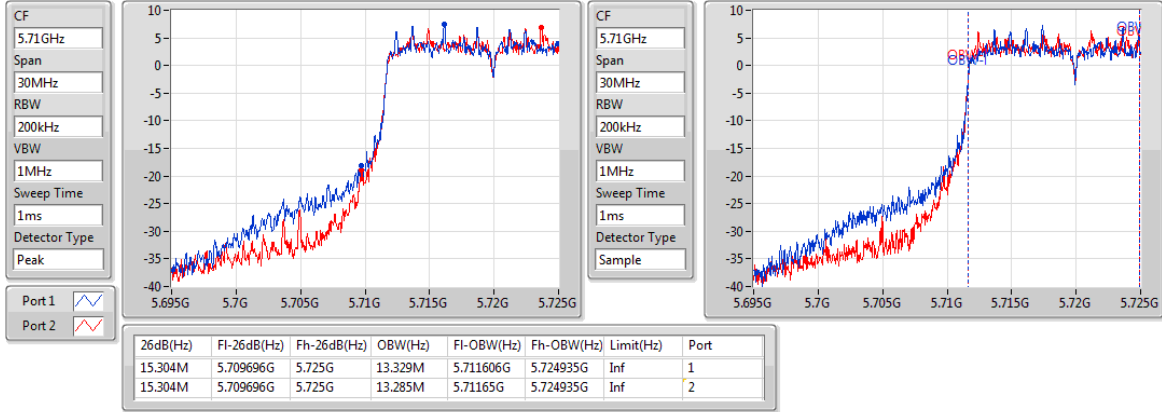

802.11a_Nss1,(6Mbps)_2TX

EBW

5720MHz Straddle 5.725-5.85GHz

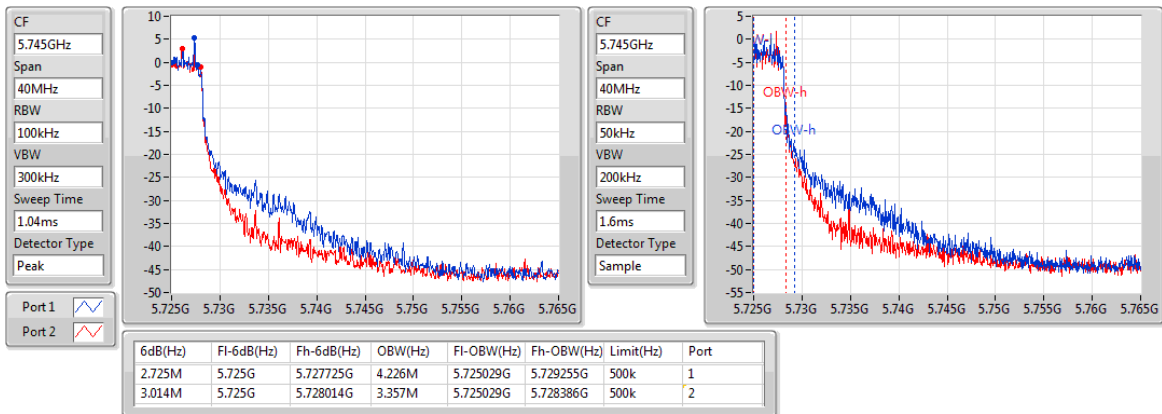

802.11a_Nss1,(6Mbps)_2TX

EBW

5745MHz

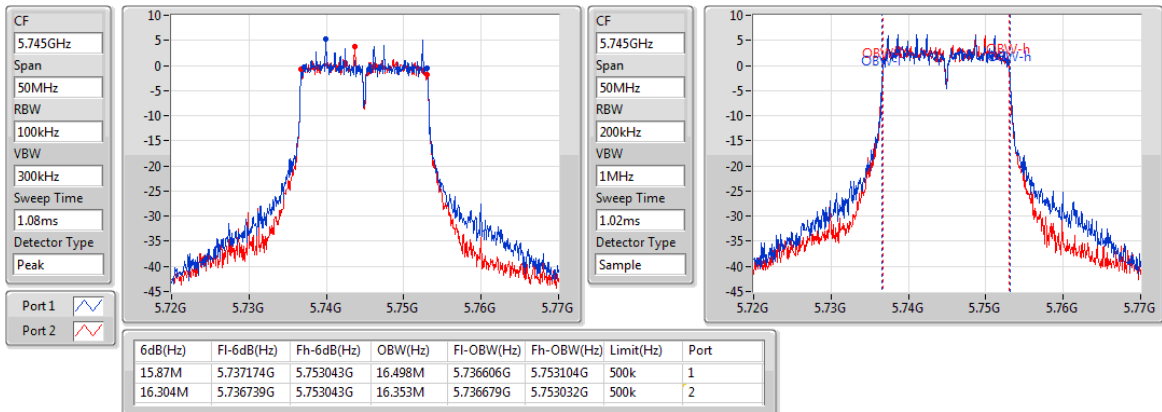

802.11a_Nss1,(6Mbps)_2TX

EBW

5785MHz

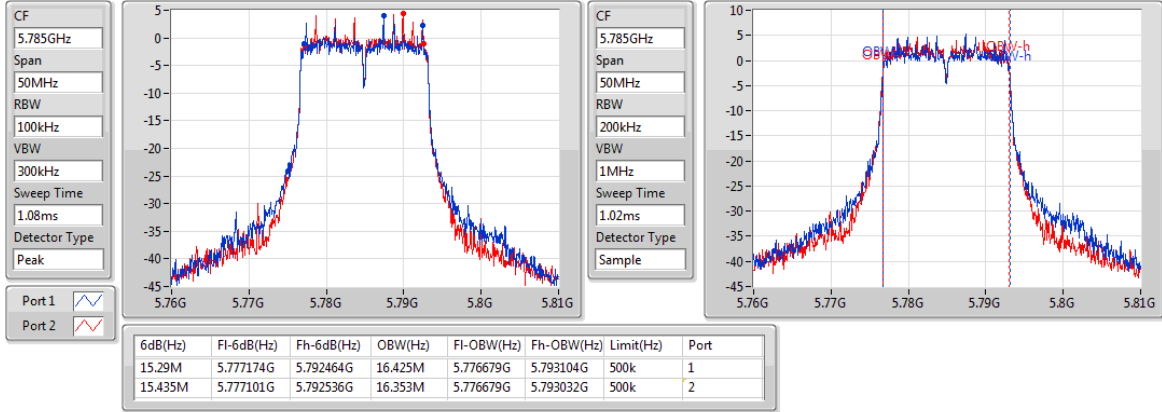

802.11a_Nss1,(6Mbps)_2TX

EBW

5825MHz

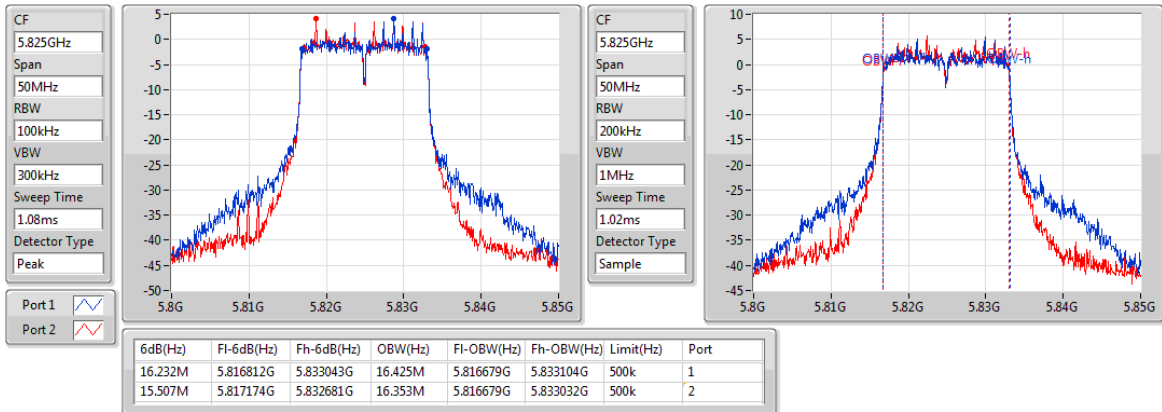

802.11n HT20_Nss1,(MCS0)_2TX

EBW

5180MHz

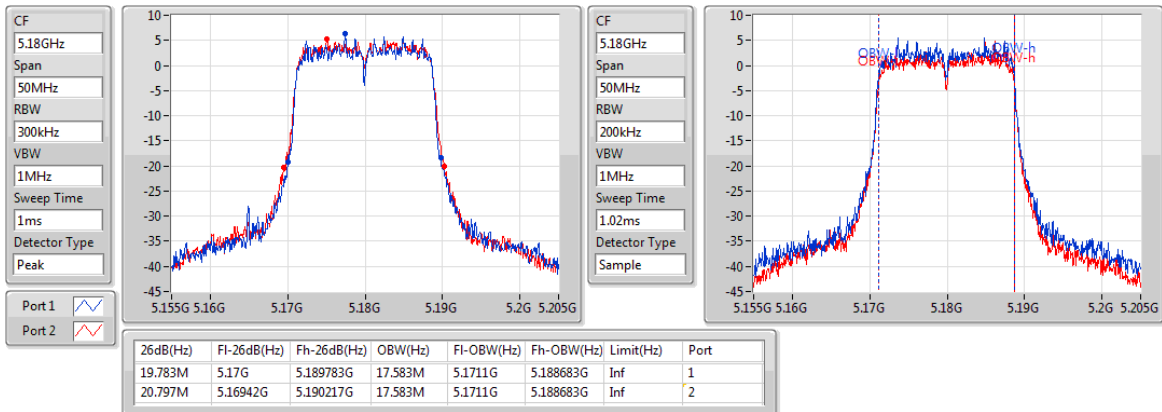

802.11n HT20_Nss1,(MCS0)_2TX

EBW

5300MHz

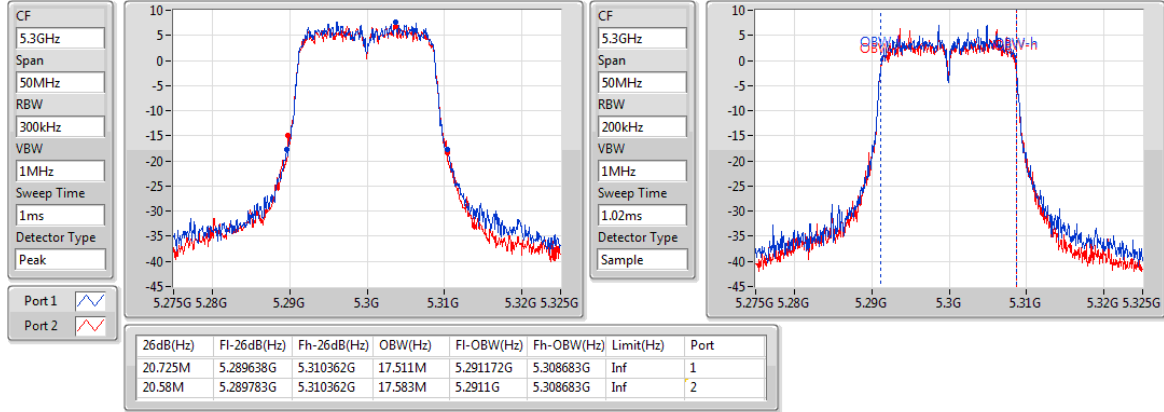

802.11n HT20_Nss1,(MCS0)_2TX

EBW

5320MHz

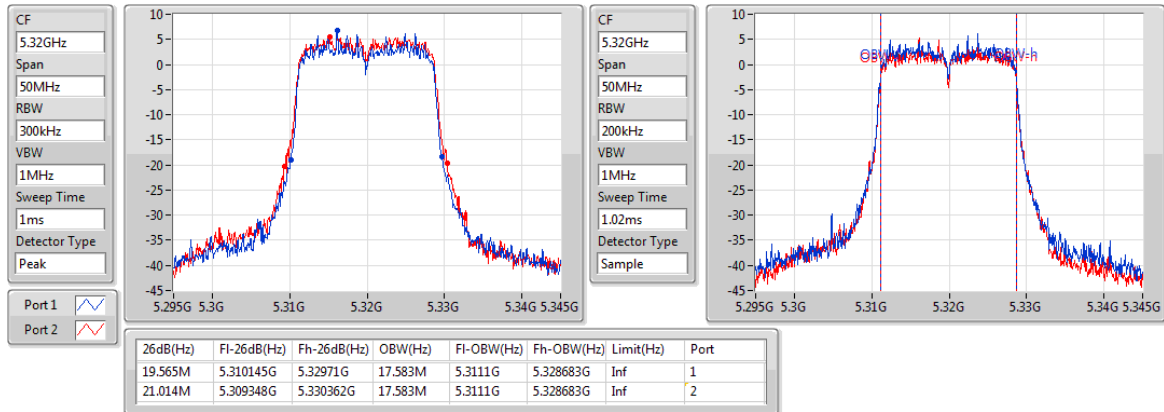

802.11n HT20_Nss1,(MCS0)_2TX

EBW

5500MHz

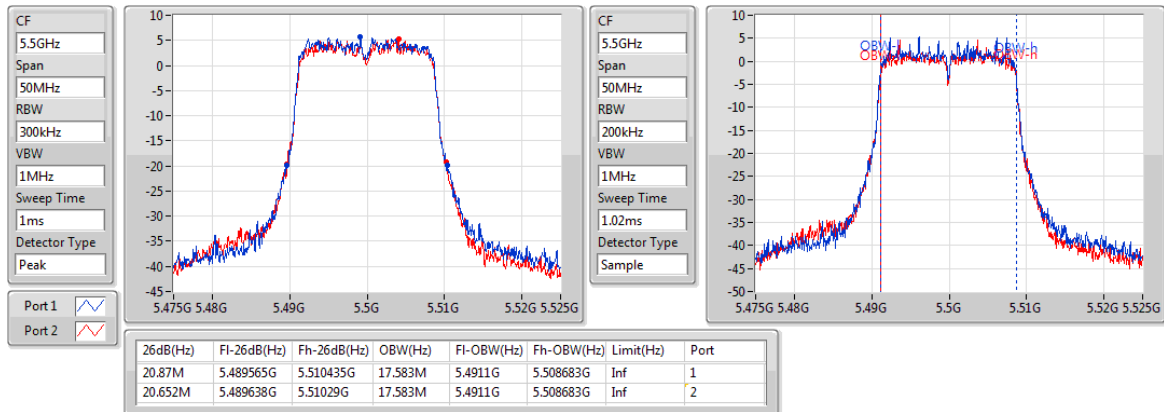

802.11n HT20_Nss1,(MCS0)_2TX

EBW

5580MHz

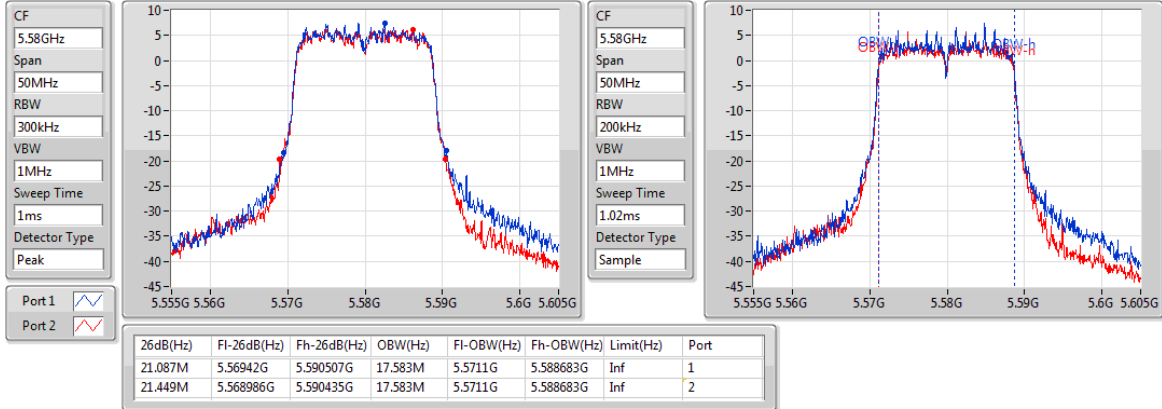

802.11n HT20_Nss1,(MCS0)_2TX

EBW

5700MHz

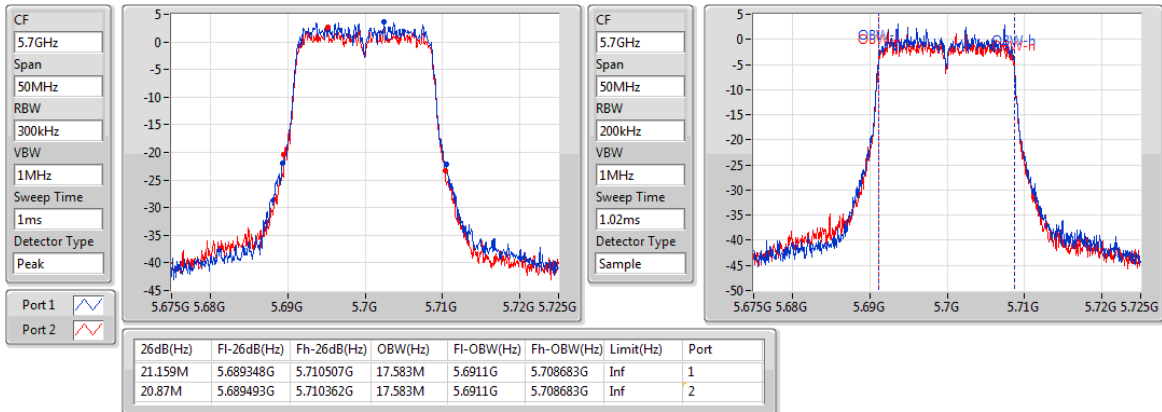

802.11n HT20_Nss1,(MCS0)_2TX

EBW

5720MHz Straddle 5.47-5.725GHz

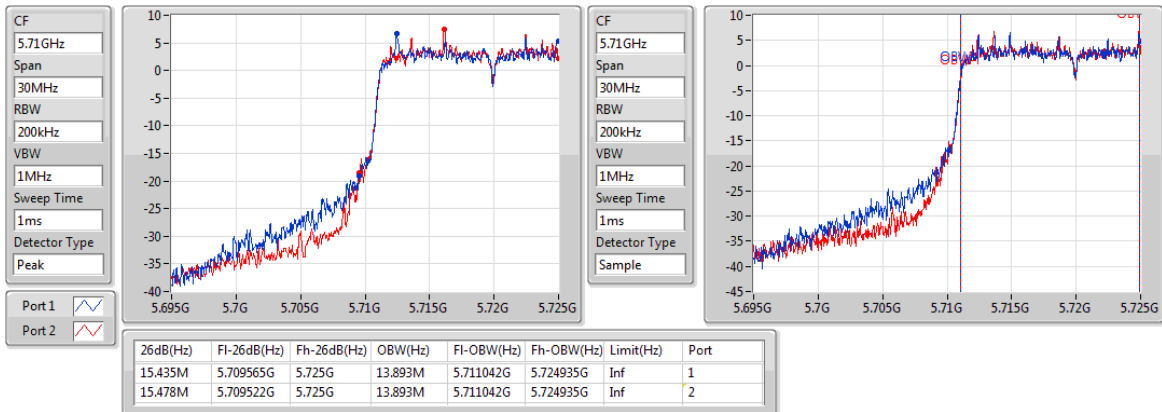

802.11n HT20_Nss1,(MCS0)_2TX

EBW

5720MHz Straddle 5.725-5.85GHz

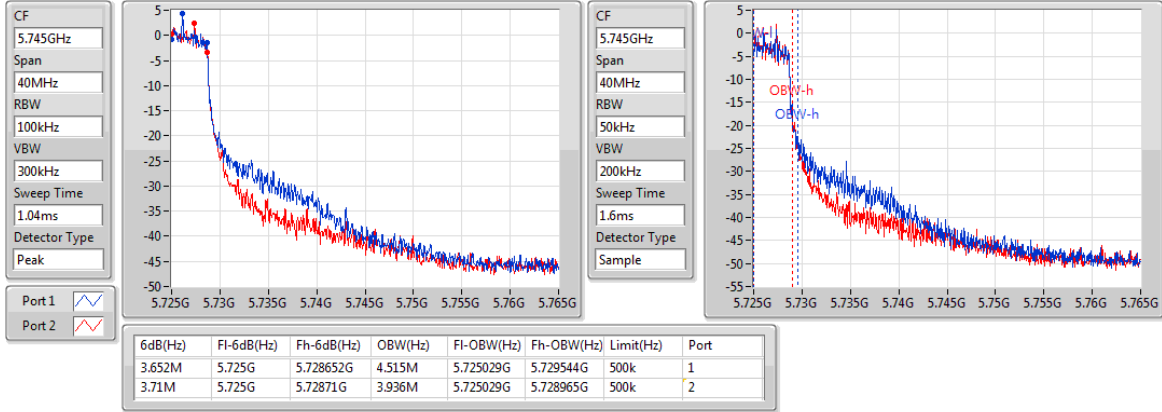

802.11n HT20_Nss1,(MCS0)_2TX

EBW

5785MHz

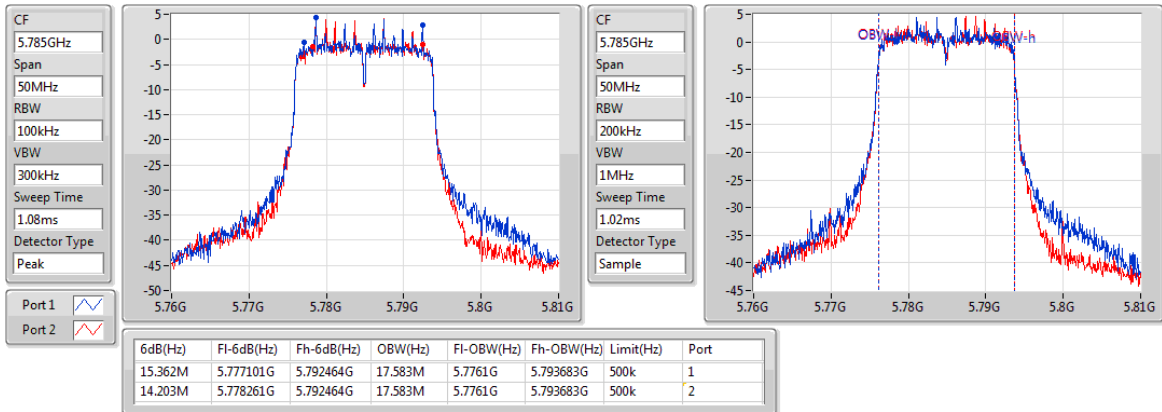

802.11n HT20_Nss1,(MCS0)_2TX

EBW

5825MHz

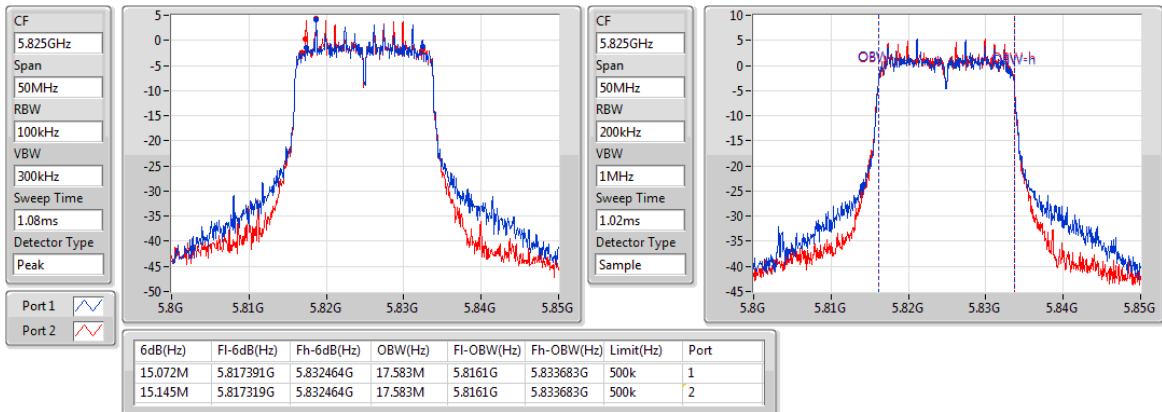

802.11n HT40_Nss1,(MCS0)_2TX

EBW

5190MHz

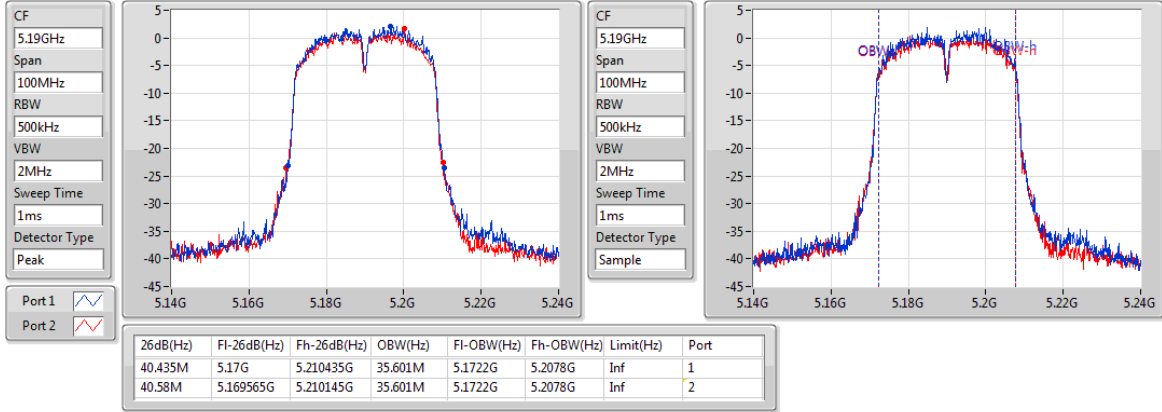

802.11n HT40_Nss1,(MCS0)_2TX

EBW

5310MHz

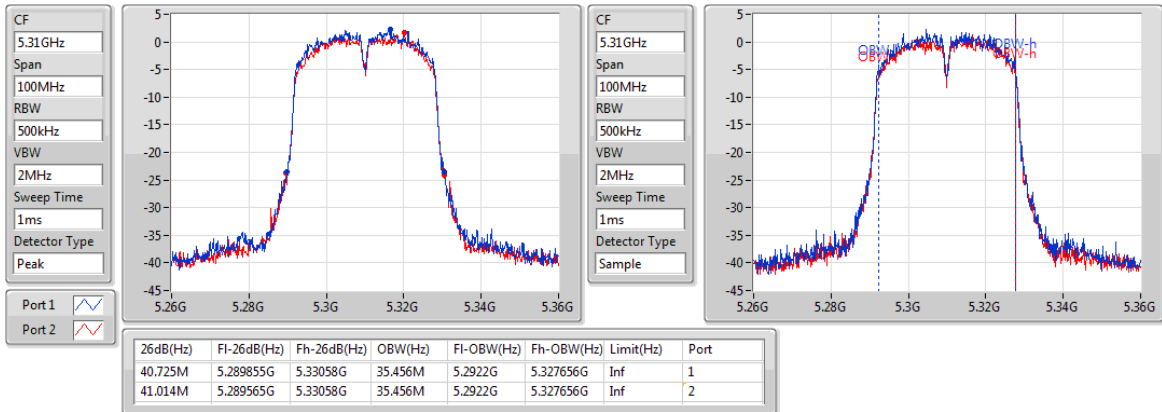

802.11n HT40_Nss1,(MCS0)_2TX

EBW

5510MHz

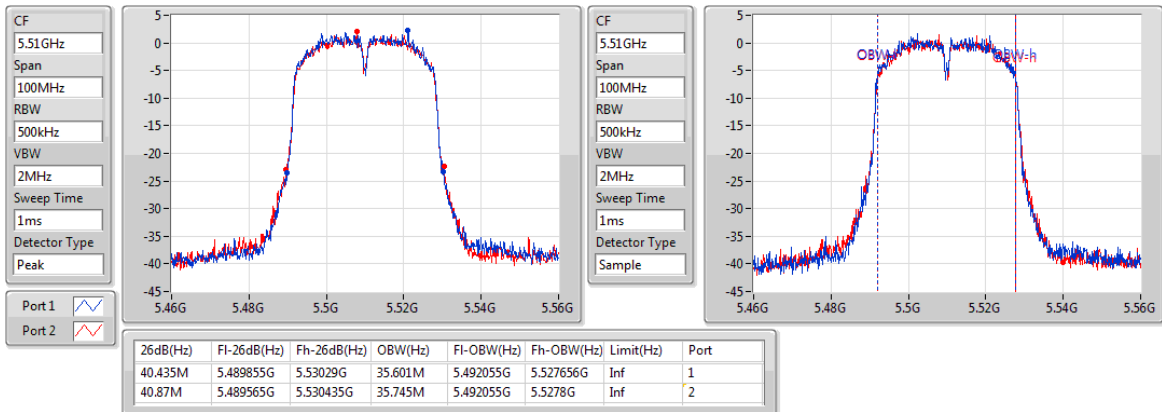

802.11n HT40_Nss1,(MCS0)_2TX

EBW

5670MHz

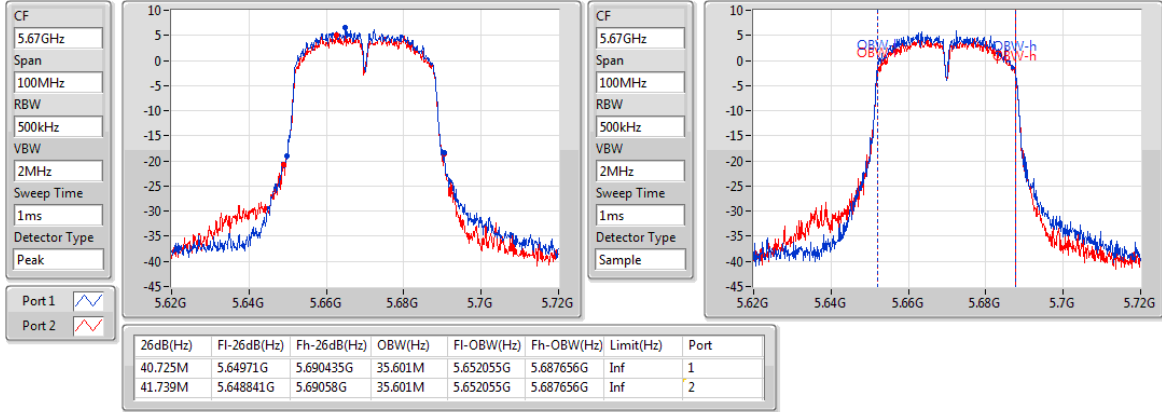

802.11n HT40_Nss1,(MCS0)_2TX

EBW

5710MHz Straddle 5.47-5.725GHz

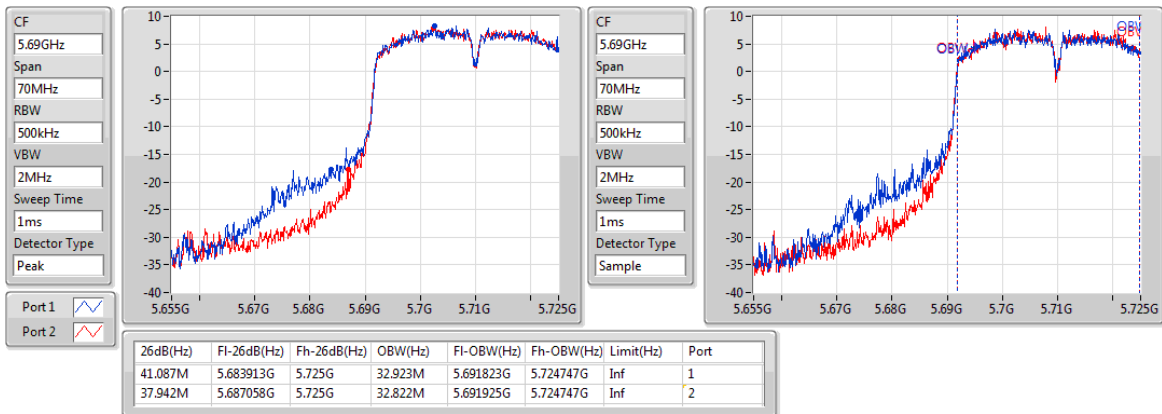

802.11n HT40_Nss1,(MCS0)_2TX

EBW

5710MHz Straddle 5.725-5.85GHz

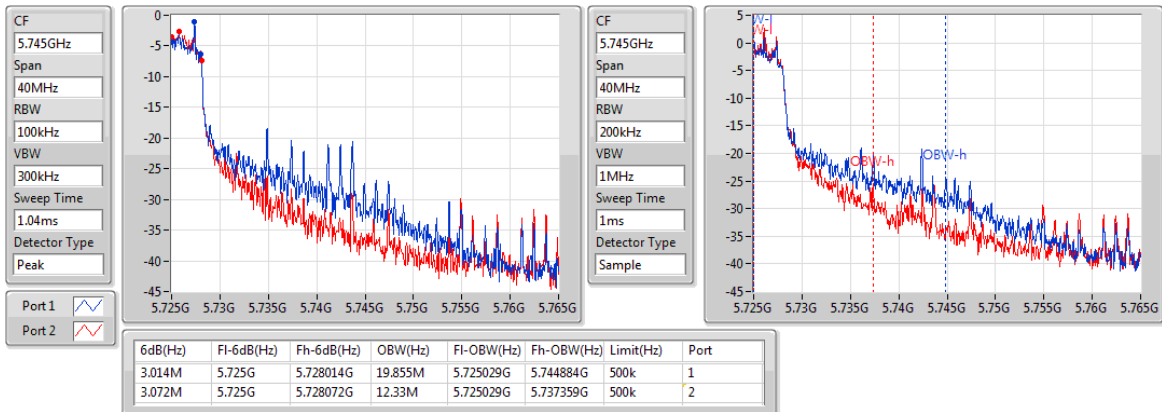

802.11n HT40_Nss1,(MCS0)_2TX

EBW

5795MHz

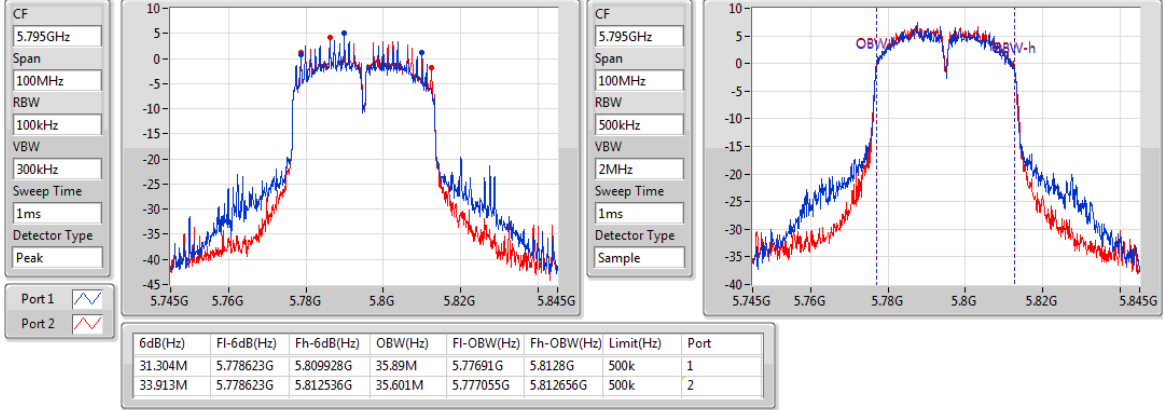

3.3 RF Output Power

3.3.1 Limit of RF Output Power

Frequency band 5150-5250 MHz	
Operating Mode	Limit
<input type="checkbox"/> Outdoor access point	Conducted Power: 1 W The maximum e.i.r.p. at any elevation angle above 30 degrees as measured from the horizon must not exceed 125 mW (21 dBm)
<input type="checkbox"/> Indoor access point	Conducted Power: 1 W
<input type="checkbox"/> Fixed point-to-point access points	Conducted Power: 1 W
<input checked="" type="checkbox"/> Client devices	Conducted Power: 250 mW

Frequency Band (MHz)	Limit
<input checked="" type="checkbox"/> 5250 ~ 5350	Conducted Power: 250mW or 11dBm+10 log B
<input checked="" type="checkbox"/> 5470 ~ 5725	Conducted Power: 250mW or 11dBm+10 log B
<input checked="" type="checkbox"/> 5725 ~ 5850	Conducted Power: 1 W

Note: "B" is the 26dB emission bandwidth in MHz.

3.3.2 Test Procedures

Method PM-G (Measurement using a gated RF average power meter)

Measurements is performed using a wideband gated RF power meter provided that the gate parameters are adjusted such that the power is measured only when the EUT is transmitting at its maximum power control level. Since the measurement is made only during the ON time of the transmitter, no duty cycle correction factor is required.

Spectrum analyzer (For channel that extends across the 5.725 GHz boundary)

1. Set RBW = 1MHz, VBW = 3MHz, Sweep time = Auto, Detector = RMS.
2. Trace average at least 100 traces in power averaging mode.
3. Compute power by integrating the spectrum across the 26 dB EBW.
4. Add $10 \log(1/X)$, X:duty cycle) if duty cycle is <98%).

3.3.3 Test Setup

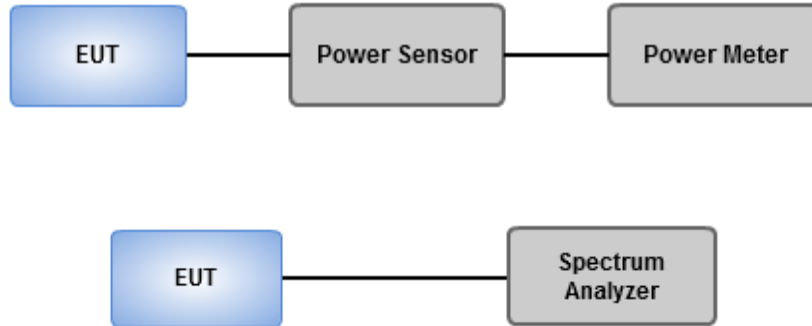

3.3.4 Test Result of Maximum Conducted Output Power

Summary

Mode	Total Power (dBm)	Total Power (W)	EIRP (dBm)	EIRP (W)
5.15-5.25GHz	-	-	-	-
802.11a_Nss1,(6Mbps)_2TX	20.41	0.10990	24.31	0.26977
802.11n HT20_Nss1,(MCS0)_2TX	18.08	0.06427	21.98	0.15776
802.11n HT40_Nss1,(MCS0)_2TX	14.07	0.02553	17.97	0.06266
5.25-5.35GHz	-	-	-	-
802.11a_Nss1,(6Mbps)_2TX	19.50	0.08913	23.40	0.21878
802.11n HT20_Nss1,(MCS0)_2TX	19.59	0.09099	23.49	0.22336
802.11n HT40_Nss1,(MCS0)_2TX	14.41	0.02761	18.31	0.06776
5.47-5.725GHz	-	-	-	-
802.11a_Nss1,(6Mbps)_2TX	19.18	0.08279	23.18	0.20797
802.11n HT20_Nss1,(MCS0)_2TX	18.79	0.07568	22.79	0.19011
802.11n HT40_Nss1,(MCS0)_2TX	20.17	0.10399	24.17	0.26122
5.725-5.85GHz	-	-	-	-
802.11a_Nss1,(6Mbps)_2TX	17.91	0.06180	21.91	0.15524
802.11n HT20_Nss1,(MCS0)_2TX	17.64	0.05808	21.64	0.14588
802.11n HT40_Nss1,(MCS0)_2TX	19.44	0.08790	23.44	0.22080

Result

Mode	Result	DG (dBi)	Port 1 (dBm)	Port 2 (dBm)	Total Power (dBm)	Power Limit (dBm)	EIRP (dBm)	EIRP Limit (dBm)
802.11a_Nss1,(6Mbps)_2TX	-	-	-	-	-	-	-	-
5180MHz	Pass	3.90	15.81	14.31	18.13	24.00	22.03	30.00
5240MHz	Pass	3.90	17.55	17.25	20.41	24.00	24.31	30.00
5300MHz	Pass	3.90	16.65	16.32	19.50	23.82	23.40	29.82
5500MHz	Pass	4.00	15.27	14.92	18.11	23.77	22.11	29.77
5580MHz	Pass	4.00	16.39	15.94	19.18	23.72	23.18	29.72
5700MHz	Pass	4.00	13.34	12.22	15.83	23.88	19.83	29.88
5720MHz Straddle 5.47-5.725GHz	Pass	4.00	14.52	14.79	17.67	22.85	21.67	28.85
5720MHz Straddle 5.725-5.85GHz	Pass	4.00	7.89	8.27	11.09	30.00	15.09	36.00
5745MHz	Pass	4.00	15.12	14.67	17.91	30.00	21.91	36.00
5785MHz	Pass	4.00	14.98	14.36	17.69	30.00	21.69	36.00
5825MHz	Pass	4.00	15.23	14.23	17.77	30.00	21.77	36.00
802.11n HT20_Nss1,(MCS0)_2TX	-	-	-	-	-	-	-	-
5180MHz	Pass	3.90	15.62	14.45	18.08	24.00	21.98	30.00
5300MHz	Pass	3.90	16.81	16.34	19.59	24.00	23.49	30.00
5320MHz	Pass	3.90	15.64	15.43	18.55	23.91	22.45	29.91
5500MHz	Pass	4.00	15.33	14.62	18.00	24.00	22.00	30.00
5580MHz	Pass	4.00	16.02	15.53	18.79	24.00	22.79	30.00
5700MHz	Pass	4.00	13.43	12.02	15.79	24.00	19.79	30.00
5720MHz Straddle 5.47-5.725GHz	Pass	4.00	14.30	14.63	17.48	22.89	21.48	28.89
5720MHz Straddle 5.725-5.85GHz	Pass	4.00	8.17	8.28	11.24	30.00	15.24	36.00
5785MHz	Pass	4.00	14.93	14.21	17.60	30.00	21.60	36.00
5825MHz	Pass	4.00	15.07	14.15	17.64	30.00	21.64	36.00
802.11n HT40_Nss1,(MCS0)_2TX	-	-	-	-	-	-	-	-
5190MHz	Pass	3.90	11.34	10.77	14.07	24.00	17.97	30.00
5310MHz	Pass	3.90	11.73	11.05	14.41	24.00	18.31	30.00
5510MHz	Pass	4.00	11.25	11.03	14.15	24.00	18.15	30.00
5670MHz	Pass	4.00	15.52	14.66	18.12	24.00	22.12	30.00
5710MHz Straddle 5.47-5.725GHz	Pass	4.00	17.00	17.32	20.17	24.00	24.17	30.00
5710MHz Straddle 5.725-5.85GHz	Pass	4.00	3.95	4.25	7.11	30.00	11.11	36.00
5795MHz	Pass	4.00	16.82	16.01	19.44	30.00	23.44	36.00

DG = Directional Gain; **Port X** = Port X output power

802.11a_Nss1,(6Mbps)_2TX

AV Power

5720MHz Straddle 5.47-5.725GHz

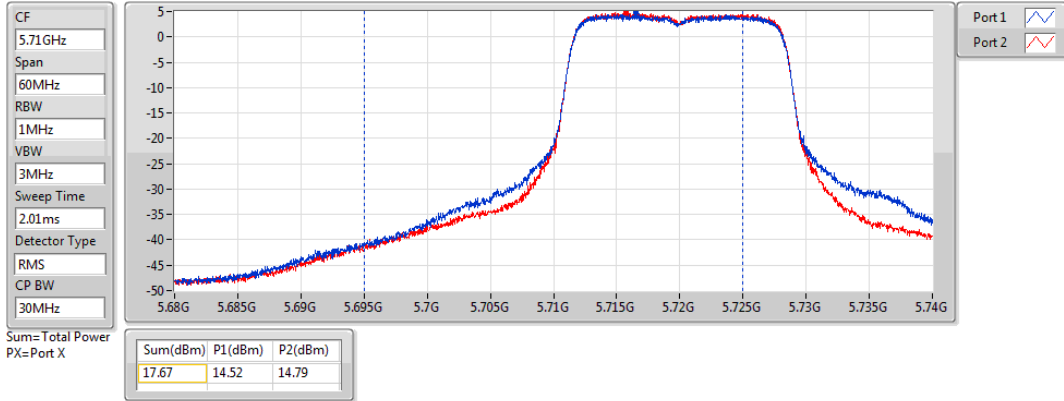

802.11a_Nss1,(6Mbps)_2TX

AV Power

5720MHz Straddle 5.725-5.85GHz

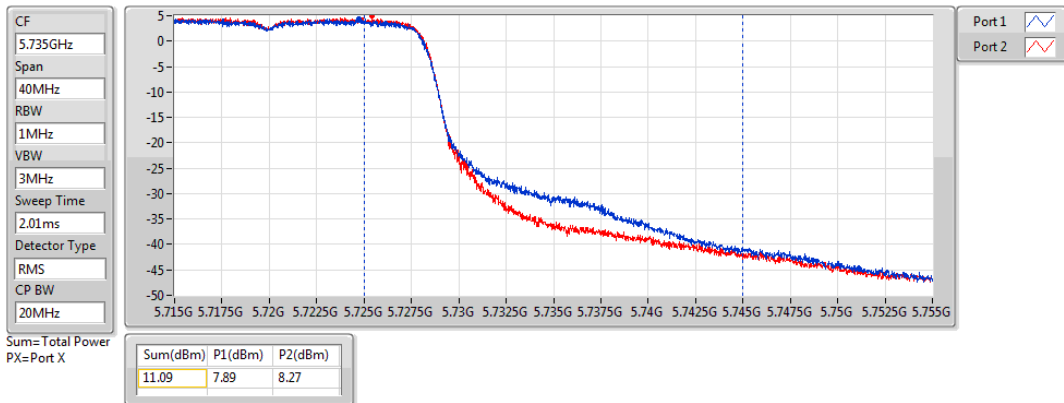

802.11n HT20_Nss1,(MCS0)_2TX

AV Power

5720MHz Straddle 5.47-5.725GHz

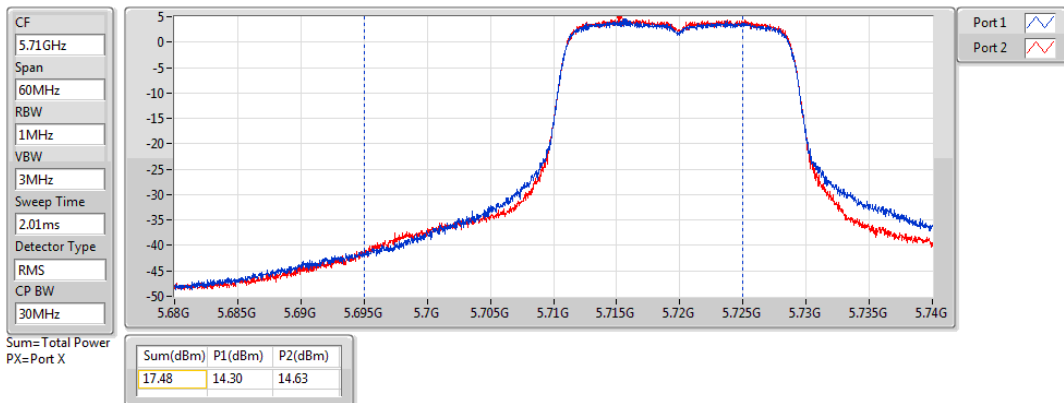

802.11n HT20_Nss1,(MCS0)_2TX

AV Power

5720MHz Straddle 5.725-5.85GHz

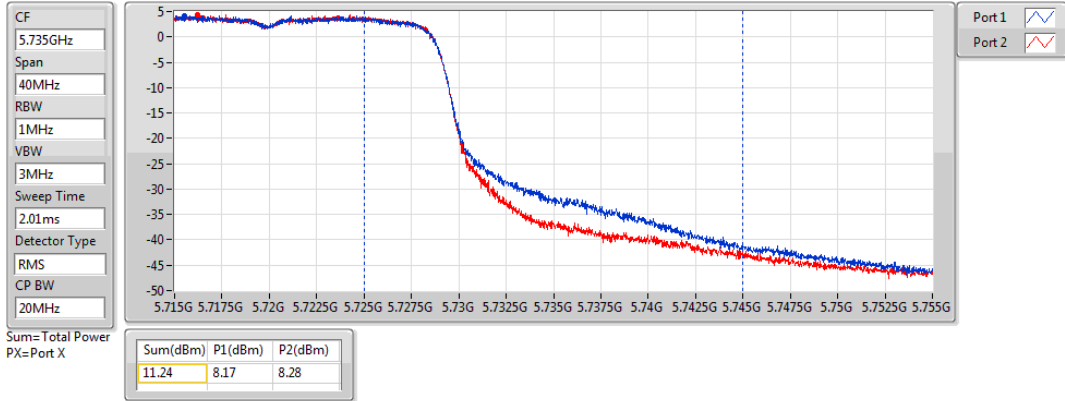

802.11n HT40_Nss1,(MCS0)_2TX

AV Power

5710MHz Straddle 5.47-5.725GHz

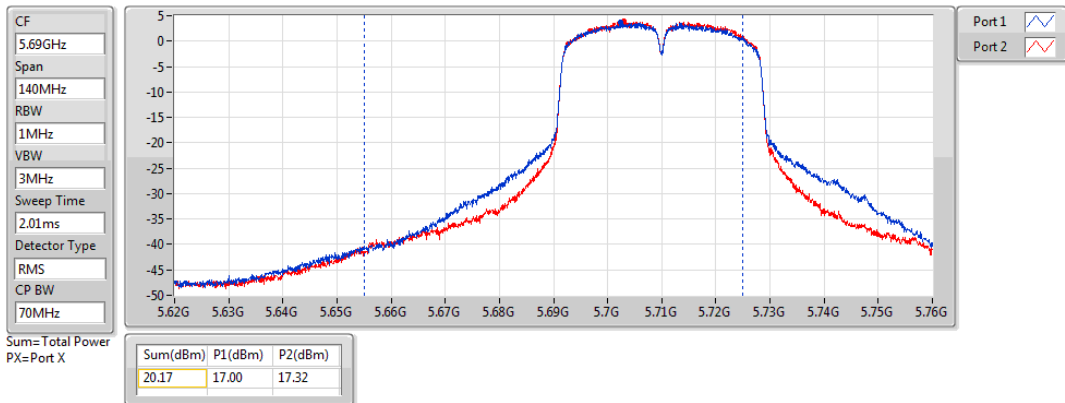

802.11n HT40_Nss1,(MCS0)_2TX

AV Power

5710MHz Straddle 5.725-5.85GHz

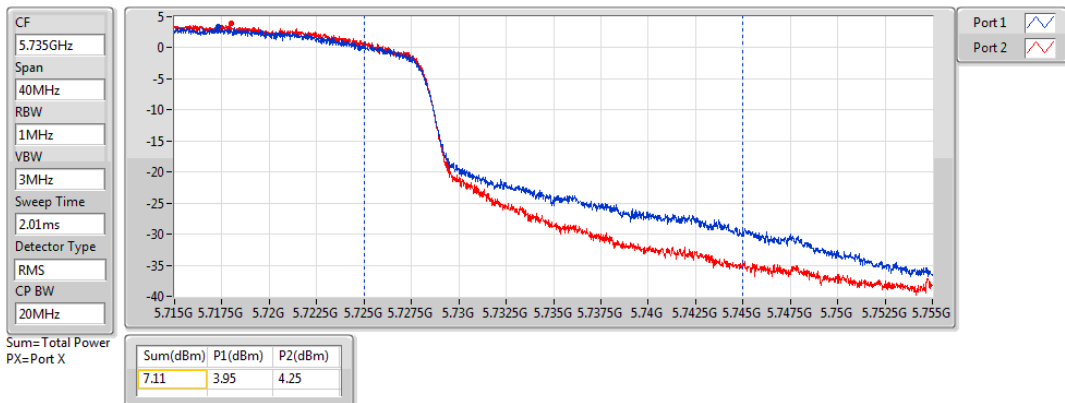

3.4 Peak Power Spectral Density

3.4.1 Limit of Peak Power Spectral Density

Frequency band 5150-5250 MHz		
Operating Mode		Limit
<input type="checkbox"/>	Outdoor access point	17 dBm / MHz
<input type="checkbox"/>	Indoor access point	17 dBm / MHz
<input type="checkbox"/>	Fixed point-to-point access points	17 dBm / MHz
<input checked="" type="checkbox"/>	Client devices	11 dBm / MHz

Frequency Band (MHz)		Limit
<input checked="" type="checkbox"/>	5250 ~ 5350	11 dBm / MHz
<input checked="" type="checkbox"/>	5470 ~ 5725	11 dBm / MHz
<input checked="" type="checkbox"/>	5725 ~ 5850	30 dBm /500 kHz

3.4.2 Test Procedures

For 5150 ~ 5250 MHz / 5250 ~ 5350 MHz / 5470 ~ 5725 MHz

Duty cycle \geq 98 %

1. Set RBW = 1 MHz, VBW = 3 MHz, Sweep time = auto, Detector = RMS.
2. Trace average 100 traces.
3. Use the peak marker function to determine the maximum amplitude level.

Duty cycle $<$ 98 %

1. Set RBW = 1 MHz, VBW = 3 MHz, Detector = RMS.
2. Set sweep time $\geq 10 * (\text{number of points in sweep}) * (\text{total on/off period of the transmitted signal})$.
3. Perform a single sweep.
4. Use the peak marker function to determine the maximum amplitude level.
5. Add $10 \log(1/x)$, where x is the duty cycle.

For 5725 ~ 5850 MHz

Duty cycle \geq 98 %

1. Set RBW = 500 kHz, VBW = 3 MHz, Sweep time = auto, Detector = RMS.
2. Trace average 100 traces.
3. Use the peak marker function to determine the maximum amplitude level.

Duty cycle $<$ 98 %

1. Set RBW = 500 kHz, VBW = 3 MHz, Detector = RMS.
2. Set sweep time $\geq 10 * (\text{number of points in sweep}) * (\text{total on/off period of the transmitted signal})$.
3. Perform a single sweep.
4. Use the peak marker function to determine the maximum amplitude level.
5. Add $10 \log(1/x)$, where x is the duty cycle.

3.4.3 Test Setup

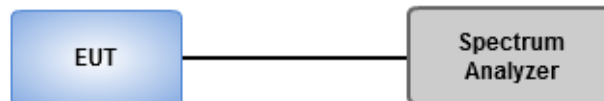

3.4.4 Test Result of Peak Power Spectral Density

Summary

Mode	PD (dBm/RBW)	EIRP PD (dBm/RBW)
5.15-5.25GHz	-	-
802.11a_Nss1,(6Mbps)_2TX	7.18	14.09
802.11n HT20_Nss1,(MCS0)_2TX	4.82	11.73
802.11n HT40_Nss1,(MCS0)_2TX	-1.61	5.30
5.25-5.35GHz	-	-
802.11a_Nss1,(6Mbps)_2TX	6.25	13.16
802.11n HT20_Nss1,(MCS0)_2TX	6.10	13.01
802.11n HT40_Nss1,(MCS0)_2TX	-1.35	5.56
5.47-5.725GHz	-	-
802.11a_Nss1,(6Mbps)_2TX	5.88	12.89
802.11n HT20_Nss1,(MCS0)_2TX	5.42	12.43
802.11n HT40_Nss1,(MCS0)_2TX	4.64	11.65
5.725-5.85GHz	-	-
802.11a_Nss1,(6Mbps)_2TX	4.09	11.10
802.11n HT20_Nss1,(MCS0)_2TX	3.63	10.64
802.11n HT40_Nss1,(MCS0)_2TX	2.36	9.37

RBW = 500kHz for 5.725-5.85GHz band / 1MHz for other band;

RBW = 500kHz for 5.725-5.85GHz band / 1MHz for other band;

For 5.15 ~ 5.25 GHz

Directional Gain = 3.9 dBi + 10*log(2/1) = 6.91 dBi > 6 dBi, limit shall be reduced to 11dBm – (6.91 dBi – 6dBi) = 10.09 dBm

For 5.25 ~ 5.35 GHz

Directional Gain = 3.9 dBi + 10*log(2/1) = 6.91 dBi > 6 dBi, limit shall be reduced to 11dBm – (6.91 dBi – 6dBi) = 10.09 dBm

For 5.47 ~ 5.725 GHz

Directional Gain = 4 dBi + 10*log(2/1) = 7.01 dBi > 6 dBi, limit shall be reduced to 11dBm – (7.01 dBi – 6dBi) = 9.99 dBm

For 5.725 ~ 5.85 GHz

Directional Gain = 4 dBi + 10*log(2/1) = 7.01 dBi > 6 dBi, limit shall be reduced to 30dBm – (7.01 dBi – 6dBi) = 28.99 dBm

Result

Mode	Result	DG (dBi)	Port 1 (dBm/ RBW)	Port 2 (dBm/ RBW)	PD (dBm/ RBW)	PD Limit (dBm/ RBW)	EIRP PD (dBm/ RBW)	EIRP PD Limit (dBm/ RBW)
802.11a_Nss1,(6Mbps)_2TX	-	-	-	-	-	-	-	-
5180MHz	Pass	6.91	2.70	1.77	5.02	10.09	11.93	17.00
5240MHz	Pass	6.91	4.40	4.41	7.18	10.09	14.09	17.00
5300MHz	Pass	6.91	3.53	3.40	6.25	10.09	13.16	17.00
5500MHz	Pass	7.01	2.05	1.62	4.82	9.99	11.83	17.00
5580MHz	Pass	7.01	3.24	2.54	5.88	9.99	12.89	17.00
5700MHz	Pass	7.01	0.22	-1.17	2.37	9.99	9.38	17.00
5720MHz Straddle 5.47-5.725GHz	Pass	7.01	2.60	3.04	5.74	9.99	12.75	17.00
5720MHz Straddle 5.725-5.85GHz	Pass	7.01	0.74	1.04	3.80	28.99	10.81	36.00
5745MHz	Pass	7.01	1.44	1.35	4.09	28.99	11.10	36.00
5785MHz	Pass	7.01	0.31	0.19	3.01	28.99	10.02	36.00
5825MHz	Pass	7.01	0.05	-0.12	2.88	28.99	9.89	36.00
802.11n HT20_Nss1,(MCS0)_2TX	-	-	-	-	-	-	-	-
5180MHz	Pass	6.91	2.35	1.53	4.82	10.09	11.73	17.00
5300MHz	Pass	6.91	3.34	3.11	6.10	10.09	13.01	17.00
5320MHz	Pass	6.91	2.19	1.97	4.98	10.09	11.89	17.00
5500MHz	Pass	7.01	2.16	1.54	4.78	9.99	11.79	17.00
5580MHz	Pass	7.01	2.87	2.22	5.42	9.99	12.43	17.00
5700MHz	Pass	7.01	-0.02	-1.03	2.38	9.99	9.39	17.00
5720MHz Straddle 5.47-5.725GHz	Pass	7.01	2.15	2.55	5.21	9.99	12.22	17.00
5720MHz Straddle 5.725-5.85GHz	Pass	7.01	0.75	0.78	3.63	28.99	10.64	36.00
5785MHz	Pass	7.01	-0.13	-0.01	2.64	28.99	9.65	36.00
5825MHz	Pass	7.01	-0.27	0.19	2.78	28.99	9.79	36.00
802.11n HT40_Nss1,(MCS0)_2TX	-	-	-	-	-	-	-	-
5190MHz	Pass	6.91	-4.12	-4.89	-1.61	10.09	5.30	17.00
5310MHz	Pass	6.91	-4.04	-4.36	-1.35	10.09	5.56	17.00
5510MHz	Pass	7.01	-4.37	-4.61	-1.57	9.99	5.44	17.00
5670MHz	Pass	7.01	-0.25	-0.80	2.31	9.99	9.32	17.00
5710MHz Straddle 5.47-5.725GHz	Pass	7.01	1.54	2.00	4.64	9.99	11.65	17.00
5710MHz Straddle 5.725-5.85GHz	Pass	7.01	-3.04	-2.62	0.13	28.99	7.14	36.00
5795MHz	Pass	7.01	-0.60	-0.34	2.36	28.99	9.37	36.00

DG = Directional Gain; RBW = 500kHz for 5.725-5.85GHz band / 1MHz for other band;

PD = trace bin-by-bin of each transmits port summing can be performed maximum power density; Port X = Port Xpower density;

802.11a_Nss1,(6Mbps)_2TX

PSD

5180MHz

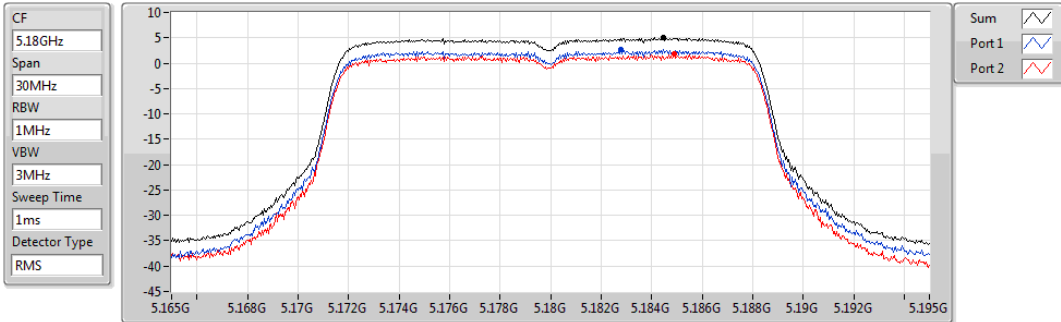

Sum	PD	Port 1	Port 2
(dBm/RBW)	(dBm/RBW)	(dBm/RBW)	(dBm/RBW)
5.02	5.02	2.70	1.77

802.11a_Nss1,(6Mbps)_2TX

PSD

5240MHz

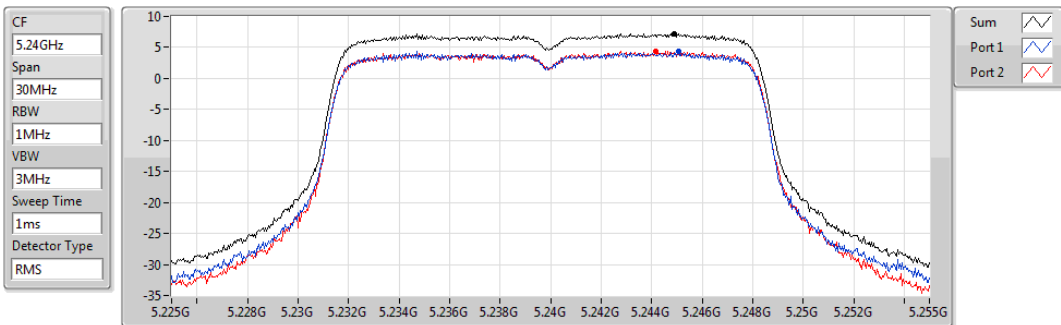

Sum	PD	Port 1	Port 2
(dBm/RBW)	(dBm/RBW)	(dBm/RBW)	(dBm/RBW)
7.18	7.18	4.40	4.41

802.11a_Nss1,(6Mbps)_2TX

PSD

5300MHz

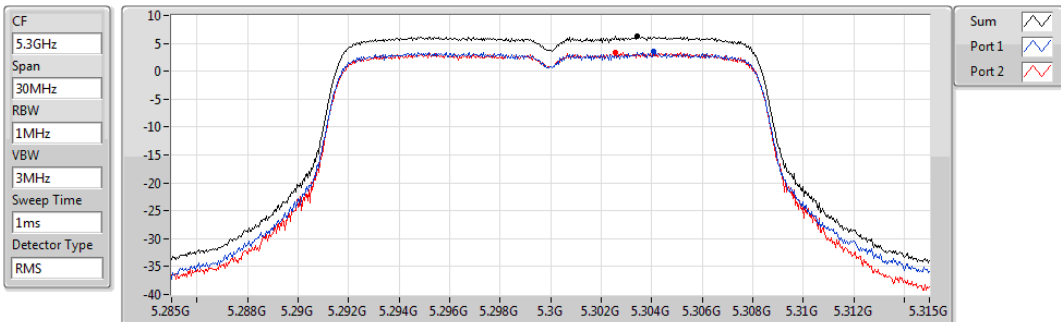

Sum	PD	Port 1	Port 2
(dBm/RBW)	(dBm/RBW)	(dBm/RBW)	(dBm/RBW)
6.25	6.25	3.53	3.40

802.11a_Nss1,(6Mbps)_2TX

PSD

5500MHz

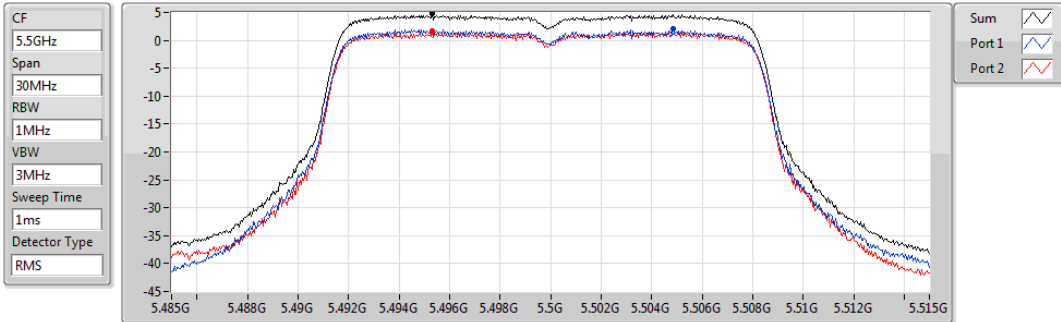

Sum	PD	Port 1	Port 2
(dBm/100kHz)	(dBm/100kHz)	(dBm/100kHz)	(dBm/100kHz)
4.82	4.82	2.05	1.62

802.11a_Nss1,(6Mbps)_2TX

PSD

5580MHz

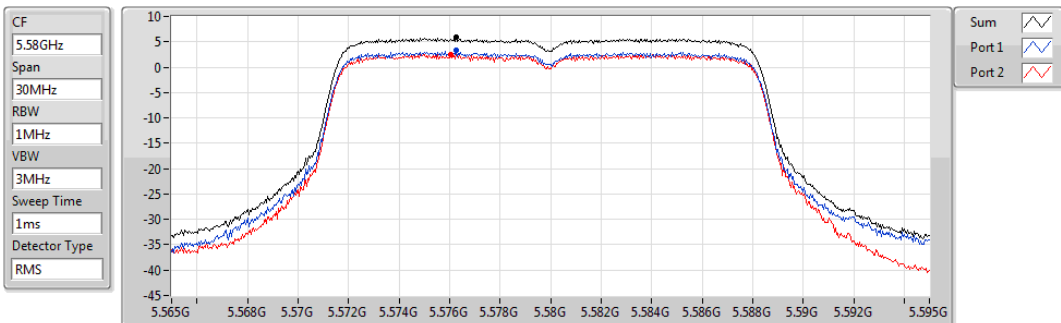

Sum	PD	Port 1	Port 2
(dBm/100kHz)	(dBm/100kHz)	(dBm/100kHz)	(dBm/100kHz)
5.88	5.88	3.24	2.54

802.11a_Nss1,(6Mbps)_2TX

PSD

5700MHz

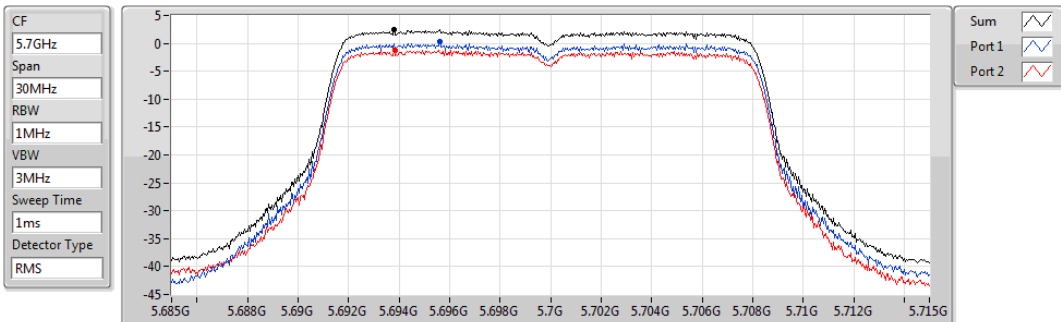

Sum	PD	Port 1	Port 2
(dBm/100kHz)	(dBm/100kHz)	(dBm/100kHz)	(dBm/100kHz)
2.37	2.37	0.22	-1.17

802.11a_Nss1,(6Mbps)_2TX

PSD

5720MHz Straddle 5.47-5.725GHz

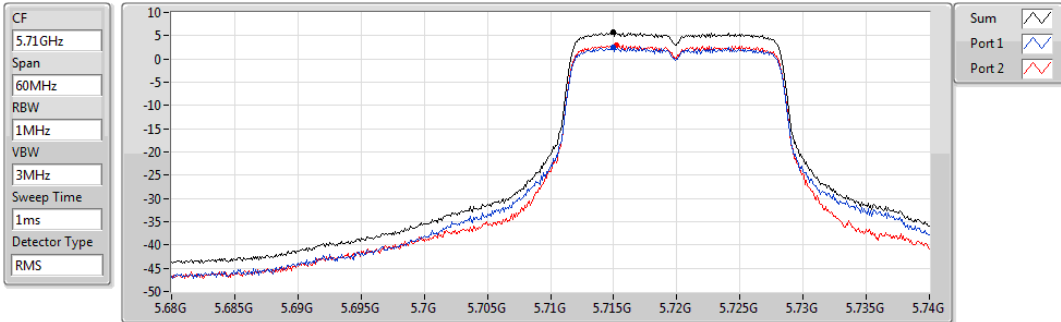

Sum	PD	Port 1	Port 2
(dBm/RBW)	(dBm/RBW)	(dBm/RBW)	(dBm/RBW)
5.74	5.74	2.60	3.04

802.11a_Nss1,(6Mbps)_2TX

PSD

5720MHz Straddle 5.725-5.85GHz

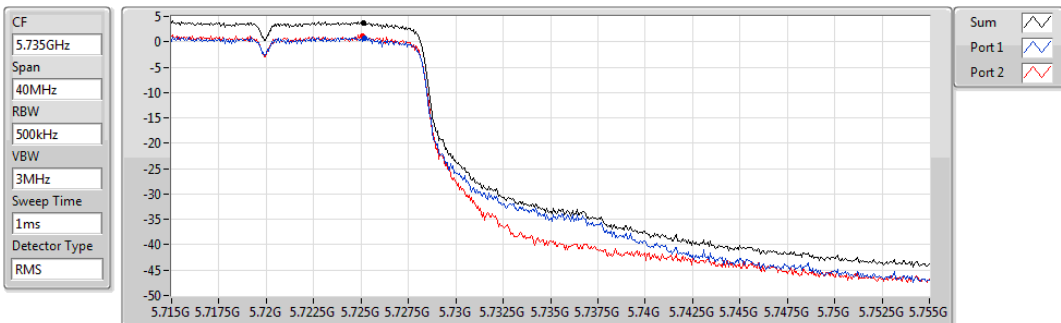

Sum	PD	Port 1	Port 2
(dBm/RBW)	(dBm/RBW)	(dBm/RBW)	(dBm/RBW)
3.80	3.80	0.74	1.04

802.11a_Nss1,(6Mbps)_2TX

PSD

5745MHz

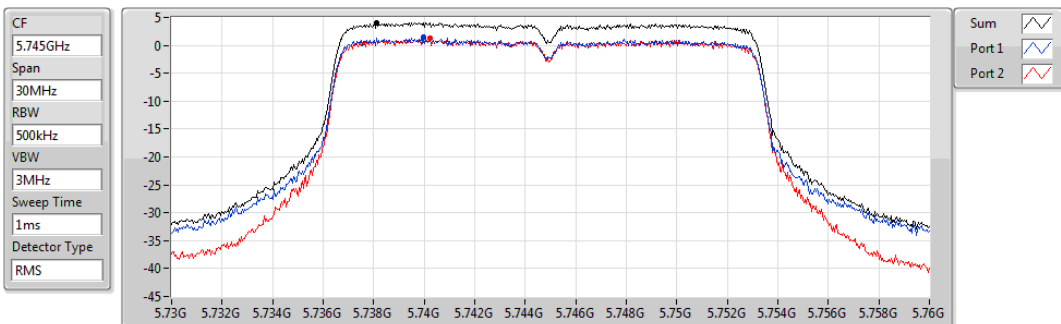

Sum	PD	Port 1	Port 2
(dBm/RBW)	(dBm/RBW)	(dBm/RBW)	(dBm/RBW)
4.09	4.09	1.44	1.35

802.11a_Nss1,(6Mbps)_2TX

PSD

5785MHz

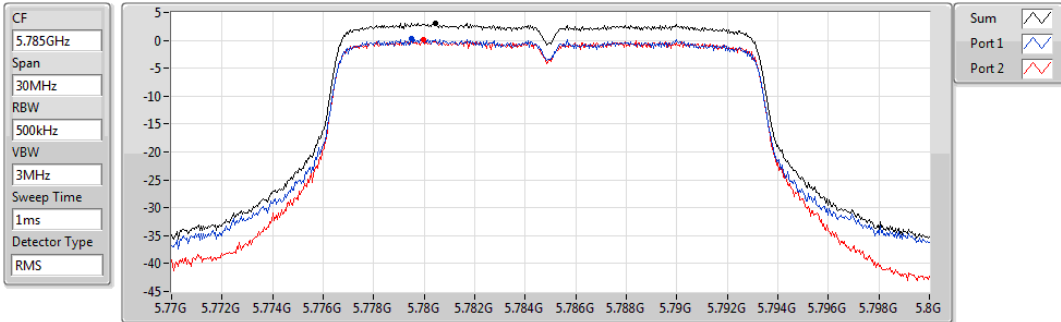

Sum	PD	Port 1	Port 2
(dBm/RBW)	(dBm/RBW)	(dBm/RBW)	(dBm/RBW)
3.01	3.01	0.31	0.19

802.11a_Nss1,(6Mbps)_2TX

PSD

5825MHz

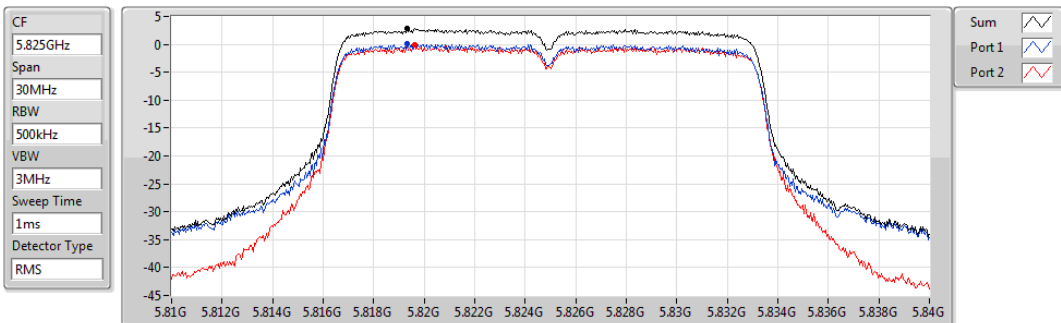

Sum	PD	Port 1	Port 2
(dBm/RBW)	(dBm/RBW)	(dBm/RBW)	(dBm/RBW)
2.88	2.88	0.05	-0.12

802.11n HT20_Nss1,(MCS0)_2TX

PSD

5180MHz

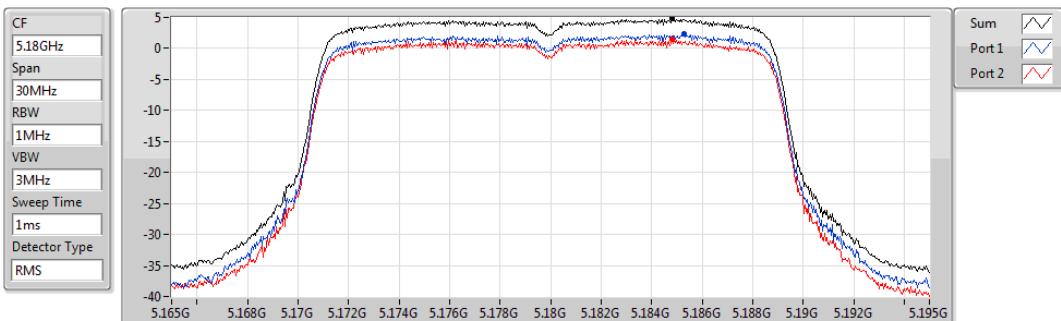

Sum	PD	Port 1	Port 2
(dBm/RBW)	(dBm/RBW)	(dBm/RBW)	(dBm/RBW)
4.82	4.82	2.35	1.53

802.11n HT20_Nss1,(MCS0)_2TX

PSD

5300MHz

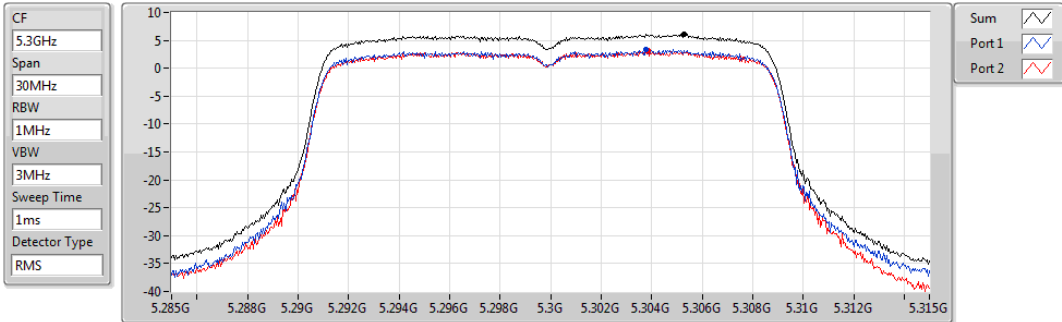

Sum	PD	Port 1	Port 2
(dBm/RBW)	(dBm/RBW)	(dBm/RBW)	(dBm/RBW)
6.10	6.10	3.34	3.11

802.11n HT20_Nss1,(MCS0)_2TX

PSD

5320MHz

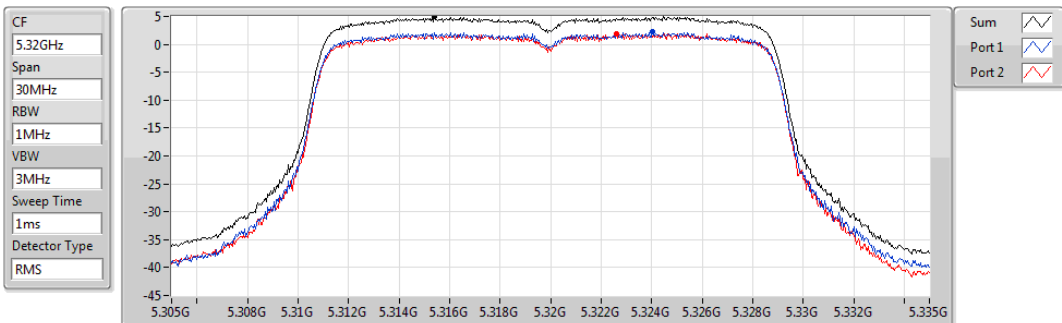

Sum	PD	Port 1	Port 2
(dBm/RBW)	(dBm/RBW)	(dBm/RBW)	(dBm/RBW)
4.98	4.98	2.19	1.97

802.11n HT20_Nss1,(MCS0)_2TX

PSD

5500MHz

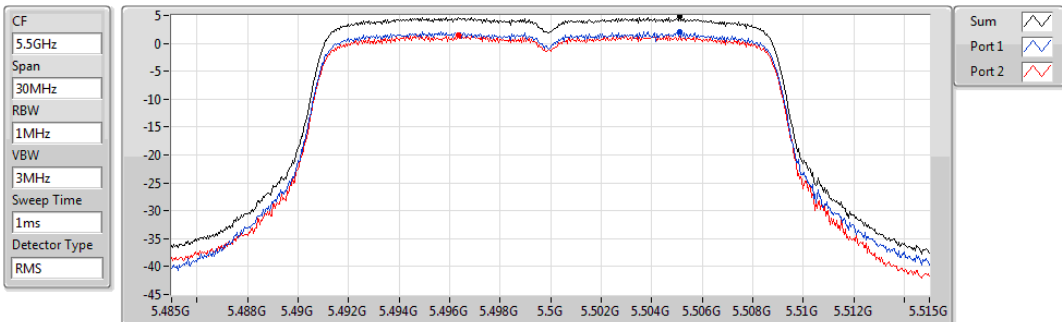

Sum	PD	Port 1	Port 2
(dBm/RBW)	(dBm/RBW)	(dBm/RBW)	(dBm/RBW)
4.78	4.78	2.16	1.54

802.11n HT20_Nss1,(MCS0)_2TX

PSD

5580MHz

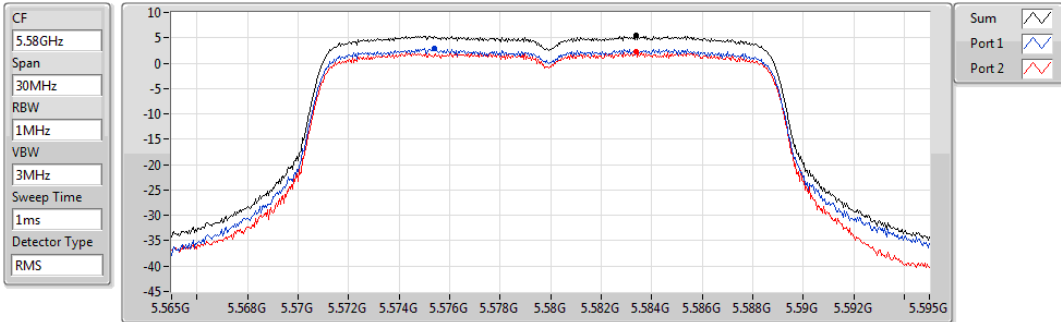

Sum	PD	Port 1	Port 2
(dBm/RBW)	(dBm/RBW)	(dBm/RBW)	(dBm/RBW)
5.42	5.42	2.87	2.22

802.11n HT20_Nss1,(MCS0)_2TX

PSD

5700MHz

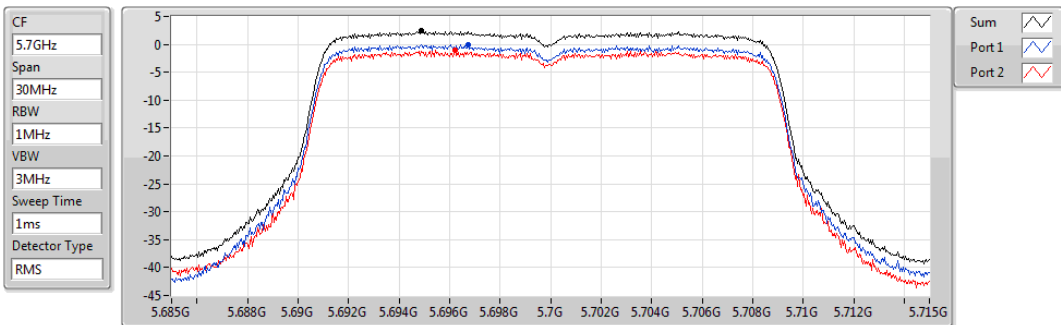

Sum	PD	Port 1	Port 2
(dBm/RBW)	(dBm/RBW)	(dBm/RBW)	(dBm/RBW)
2.38	2.38	-0.02	-1.03

802.11n HT20_Nss1,(MCS0)_2TX

PSD

5720MHz Straddle 5.47-5.725GHz

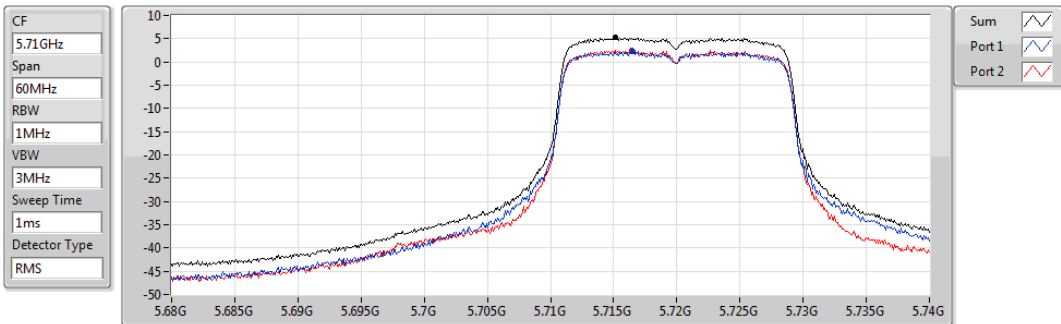

Sum	PD	Port 1	Port 2
(dBm/RBW)	(dBm/RBW)	(dBm/RBW)	(dBm/RBW)
5.21	5.21	2.15	2.55

802.11n HT20_Nss1,(MCS0)_2TX

PSD

5720MHz Straddle 5.725-5.85GHz

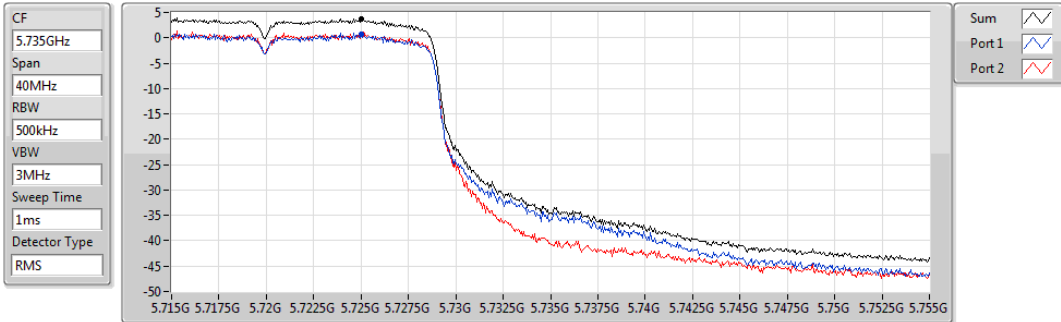

Sum	PD	Port 1	Port 2
(dBm/RBW)	(dBm/RBW)	(dBm/RBW)	(dBm/RBW)
3.63	3.63	0.75	0.78

802.11n HT20_Nss1,(MCS0)_2TX

PSD

5785MHz

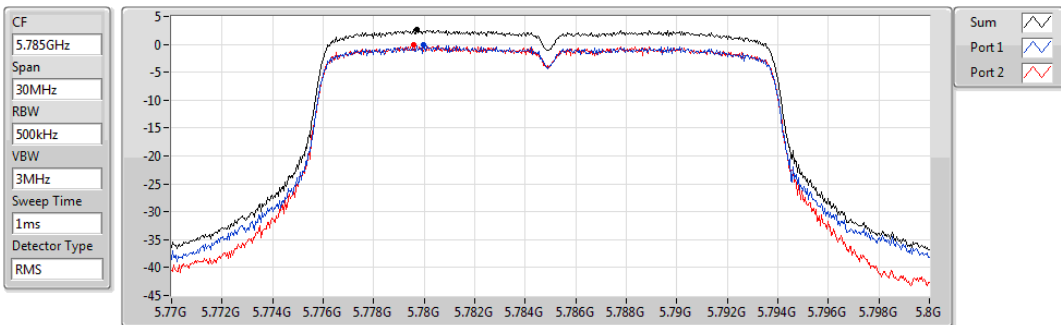

Sum	PD	Port 1	Port 2
(dBm/RBW)	(dBm/RBW)	(dBm/RBW)	(dBm/RBW)
2.64	2.64	-0.13	-0.01

802.11n HT20_Nss1,(MCS0)_2TX

PSD

5825MHz

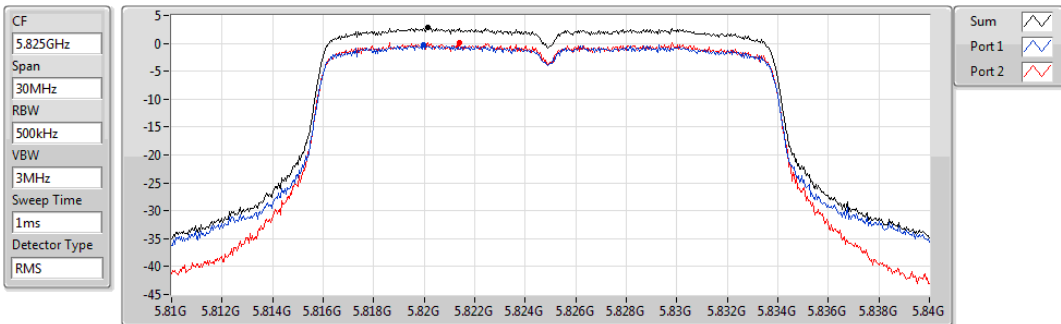

Sum	PD	Port 1	Port 2
(dBm/RBW)	(dBm/RBW)	(dBm/RBW)	(dBm/RBW)
2.78	2.78	-0.27	0.19

802.11n HT40_Nss1,(MCS0)_2TX

PSD

5190MHz

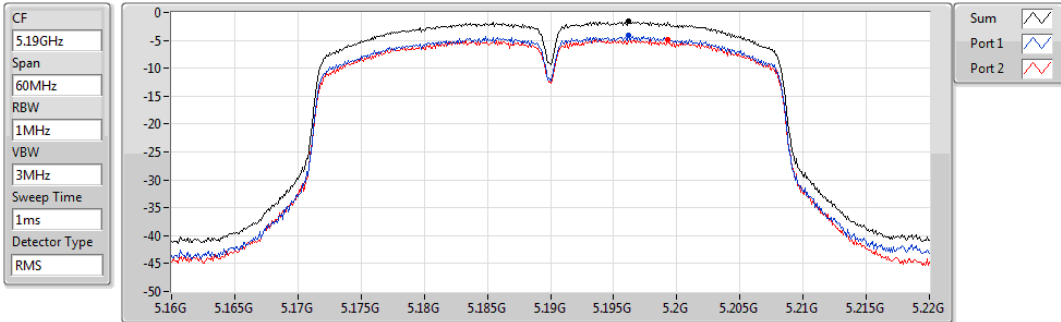

Sum	PD	Port 1	Port 2
(dBm/1MHz)	(dBm/1MHz)	(dBm/1MHz)	(dBm/1MHz)
-1.61	-1.61	-4.12	-4.89

802.11n HT40_Nss1,(MCS0)_2TX

PSD

5310MHz

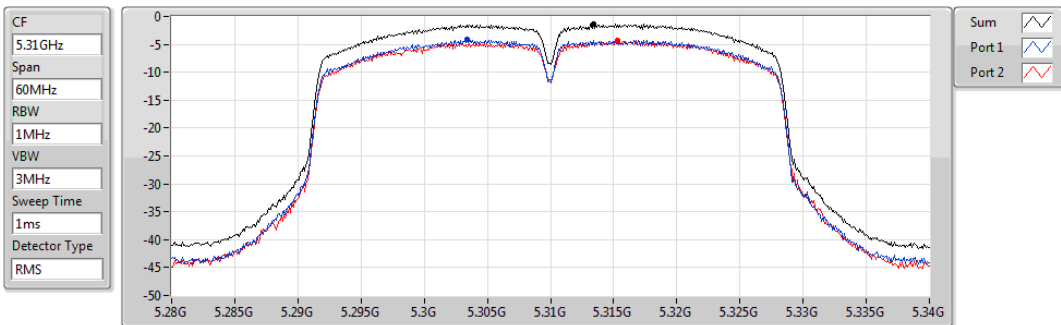

Sum	PD	Port 1	Port 2
(dBm/1MHz)	(dBm/1MHz)	(dBm/1MHz)	(dBm/1MHz)
-1.35	-1.35	-4.04	-4.36

802.11n HT40_Nss1,(MCS0)_2TX

PSD

5510MHz

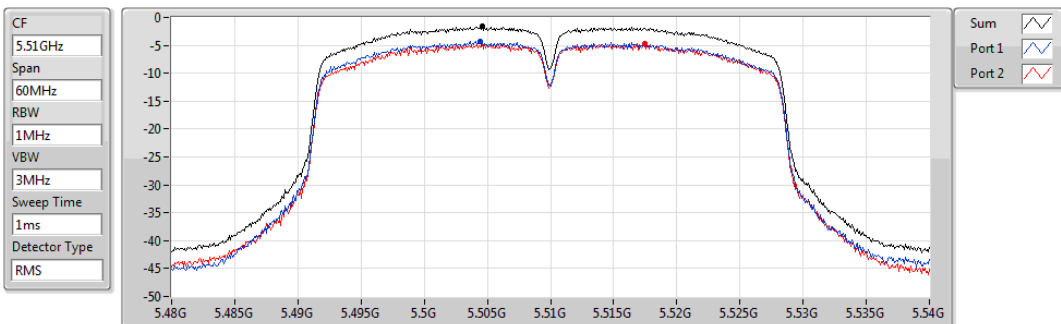

Sum	PD	Port 1	Port 2
(dBm/1MHz)	(dBm/1MHz)	(dBm/1MHz)	(dBm/1MHz)
-1.57	-1.57	-4.37	-4.61

802.11n HT40_Nss1,(MCS0)_2TX

PSD

5670MHz

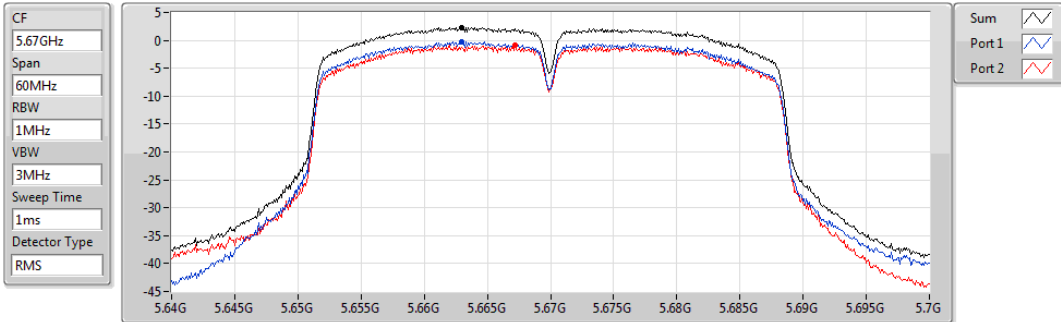

Sum	PD	Port 1	Port 2
(dBm/1MHz)	(dBm/1MHz)	(dBm/1MHz)	(dBm/1MHz)
2.31	2.31	-0.25	-0.80

802.11n HT40_Nss1,(MCS0)_2TX

PSD

5710MHz Straddle 5.47-5.725GHz

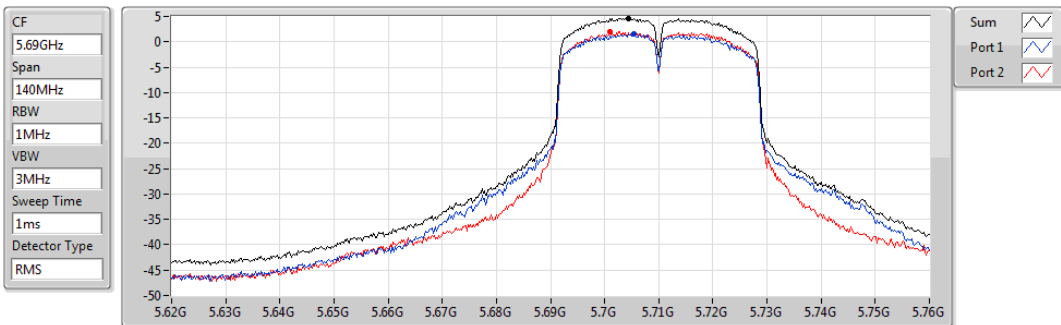

Sum	PD	Port 1	Port 2
(dBm/1MHz)	(dBm/1MHz)	(dBm/1MHz)	(dBm/1MHz)
4.64	4.64	1.54	2.00

802.11n HT40_Nss1,(MCS0)_2TX

PSD

5710MHz Straddle 5.725-5.85GHz

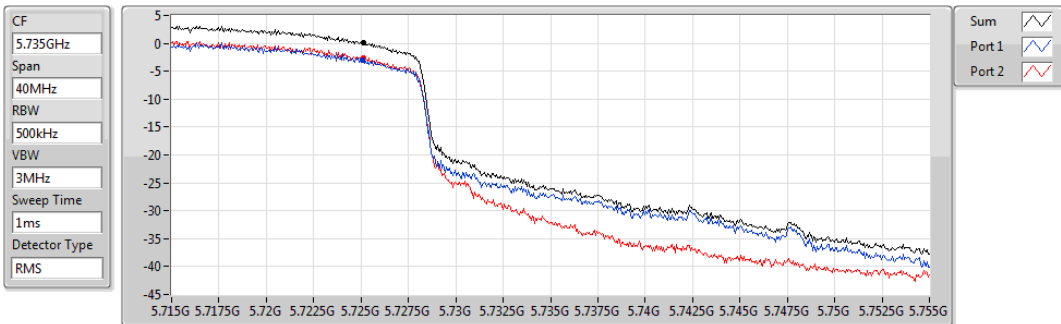

Sum	PD	Port 1	Port 2
(dBm/1MHz)	(dBm/1MHz)	(dBm/1MHz)	(dBm/1MHz)
0.13	0.13	-3.04	-2.62

802.11n HT40_Nss1,(MCS0)_2TX

PSD

5795MHz

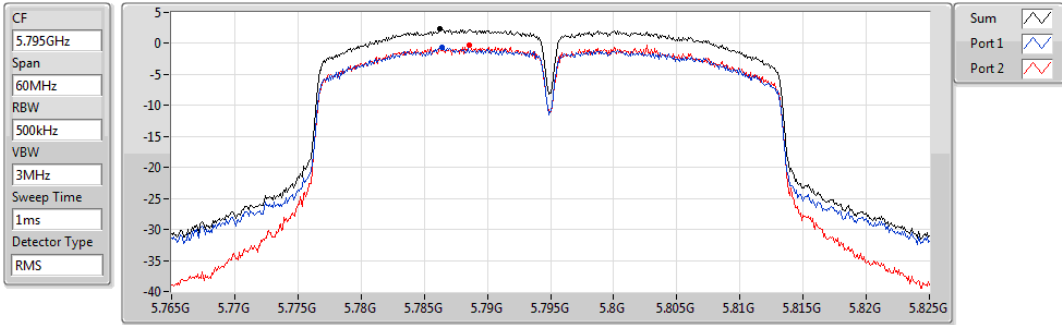

Sum	PD	Port 1	Port 2
(dBm/RBW)	(dBm/RBW)	(dBm/RBW)	(dBm/RBW)
2.36	2.36	-0.60	-0.34

3.5 Transmitter Radiated and Band Edge Emissions

3.5.1 Limit of Transmitter Radiated and Band Edge Emissions

Restricted Band Emissions Limit			
Frequency Range (MHz)	Field Strength (uV/m)	Field Strength (dBuV/m)	Measure Distance (m)
0.009~0.490	2400/F(kHz)	48.5 - 13.8	300
0.490~1.705	24000/F(kHz)	33.8 - 23	30
1.705~30.0	30	29	30
30~88	100	40	3
88~216	150	43.5	3
216~960	200	46	3
Above 960	500	54	3

Note 1:
Qusai-Peak value is measured for frequency below 1GHz except for 9–90 kHz, 110–490 kHz frequency band. Peak and average value are measured for frequency above 1GHz. The limit on average radio frequency emission is as above table. The limit on peak radio frequency emissions is 20 dB above the maximum permitted average emission limit

Note 2:
Measurements may be performed at a distance other than what is specified provided. When performing measurements at a distance other than that specified, the results shall be extrapolated to the specified distance using an extrapolation factor as below, Frequency at or above 30 MHz: 20 dB/decade Frequency below 30 MHz: 40 dB/decade.

Un-restricted band emissions above 1GHz Limit	
Operating Band	Limit
5.15 - 5.25 GHz	e.i.r.p. -27 dBm [68.2 dBuV/m@3m]
5.25 - 5.35 GHz	e.i.r.p. -27 dBm [68.2 dBuV/m@3m]
5.47 - 5.725 GHz	e.i.r.p. -27 dBm [68.2 dBuV/m@3m]
5.725 - 5.850 GHz	All emissions shall be limited to a level of -27 dBm/MHz at 75 MHz or more above or below the band edge increasing linearly to 10 dBm/MHz at 25 MHz above or below the band edge, and from 25 MHz above or below the band edge increasing linearly to a level of 15.6 dBm/MHz at 5 MHz above or below the band edge, and from 5 MHz above or below the band edge increasing linearly to a level of 27 dBm/MHz at the band edge.

Note 1: Measurements may be performed at a distance other than the limit distance provided they are not performed in the near field and the emissions to be measured can be detected by the measurement equipment. When performing measurements at a distance other than that specified, the results shall be extrapolated to the specified distance using an extrapolation factor of 20 dB/decade (inverse of linear distance for field-strength measurements, inverse of linear distance-squared for power-density measurements).

3.5.2 Test Procedures

1. Measurement is made at a semi-anechoic chamber that incorporates a turntable allowing a EUT rotation of 360°. A continuously-rotating, remotely-controlled turntable is installed at the test site to support the EUT and facilitate determination of the direction of maximum radiation for each EUT emission frequency. The EUT is placed at test table. For emissions testing at or below 1 GHz, the table height is 80 cm above the reference ground plane. For emission measurements above 1 GHz, the table height is 1.5 m
2. Measurement is made with the antenna positioned in both the horizontal and vertical planes of polarization. The measurement antenna is varied in height (1m ~ 4m) above the reference ground plane to obtain the maximum signal strength. Distance between EUT and antenna is 3 m.
3. This investigation is performed with the EUT rotated 360°, the antenna height scanned between 1 m and 4 m, and the antenna rotated to repeat the measurements for both the horizontal and vertical antenna polarizations.

Note:

1. 120kHz measurement bandwidth of test receiver and Quasi-peak detector is for radiated emission below 1GHz.
2. RBW=1MHz, VBW=3MHz and Peak detector is for peak measured value of radiated emission above 1GHz.
3. RBW=1MHz, VBW=1/T and Peak detector is for average measured value of radiated emission above 1GHz.

3.5.3 Test Setup

Radiated Emissions below 1 GHz

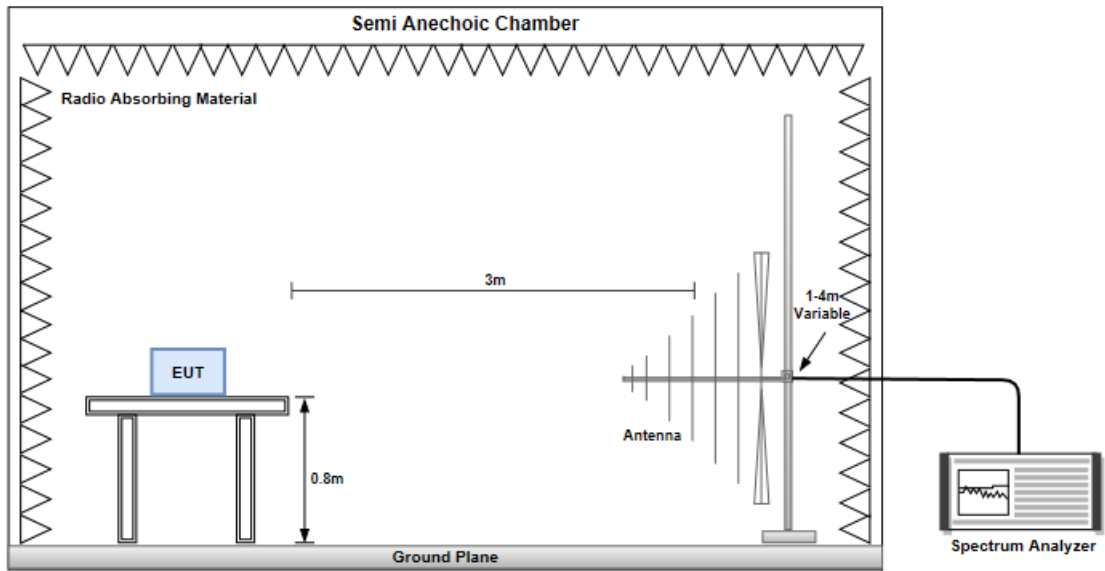

Radiated Emissions above 1 GHz

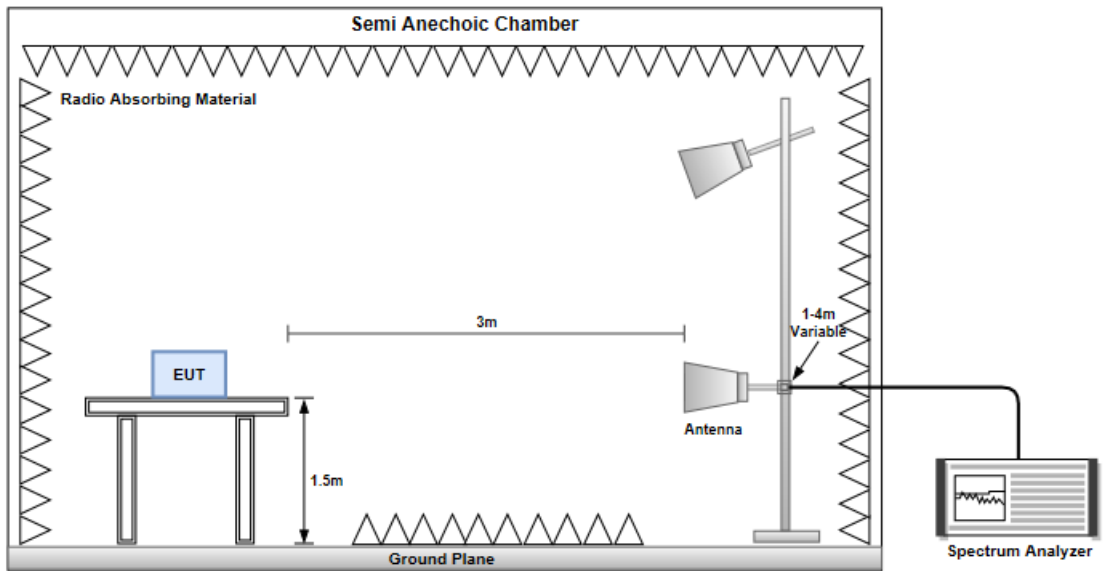

Configuration 1 : Antenna MAF94051

3.5.4 Transmitter Radiated Unwanted Emissions (Below 1GHz)

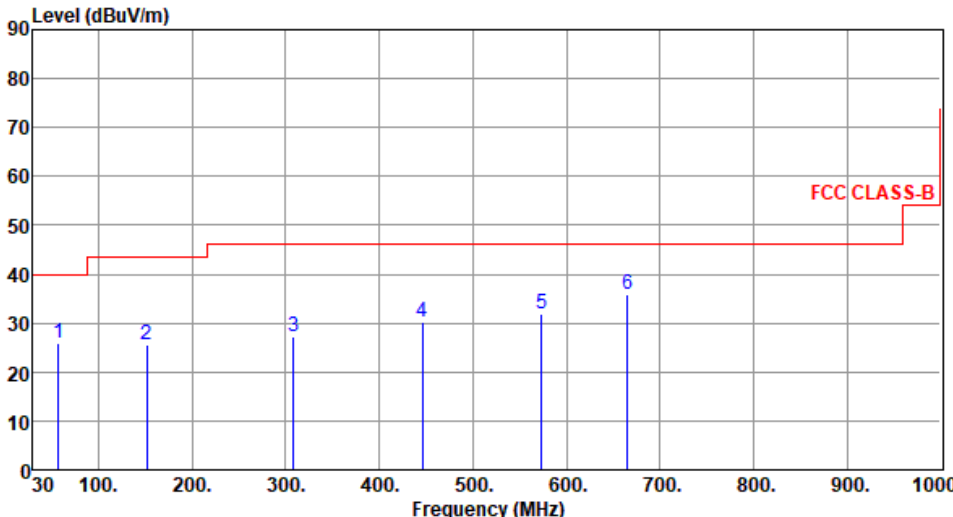
Modulation	11a	Test Freq. (MHz)	5240						
Polarization	Horizontal								
									
	Freq. MHz	Emission level dBuV/m	Limit dBuV/m	Margin dB	SA reading dBuV	Factor dB	Remark	ANT High cm	Turn Table deg
1	57.16	25.96	40.00	-14.04	35.02	-9.06	Peak	---	---
2	151.25	25.41	43.50	-18.09	34.37	-8.96	Peak	---	---
3	308.39	27.09	46.00	-18.91	35.31	-8.22	Peak	---	---
4	446.13	30.23	46.00	-15.77	34.16	-3.93	Peak	---	---
5	573.20	32.05	46.00	-13.95	33.71	-1.66	Peak	---	---
6	665.35	35.84	46.00	-10.16	35.16	0.68	Peak	---	---

Note 1: Emission Level (dBuV/m) = SA Reading (dBuV/m) + Factor* (dB)
*Factor includes antenna factor , cable loss and amplifier gain
Note 2: Margin (dB) = Emission level (dBuV/m) – Limit (dBuV/m).
Note 3: All spurious emissions below 30MHz are more than 20 dB below the limit.

Modulation	11a	Test Freq. (MHz)	5240
Polarization	Vertical		

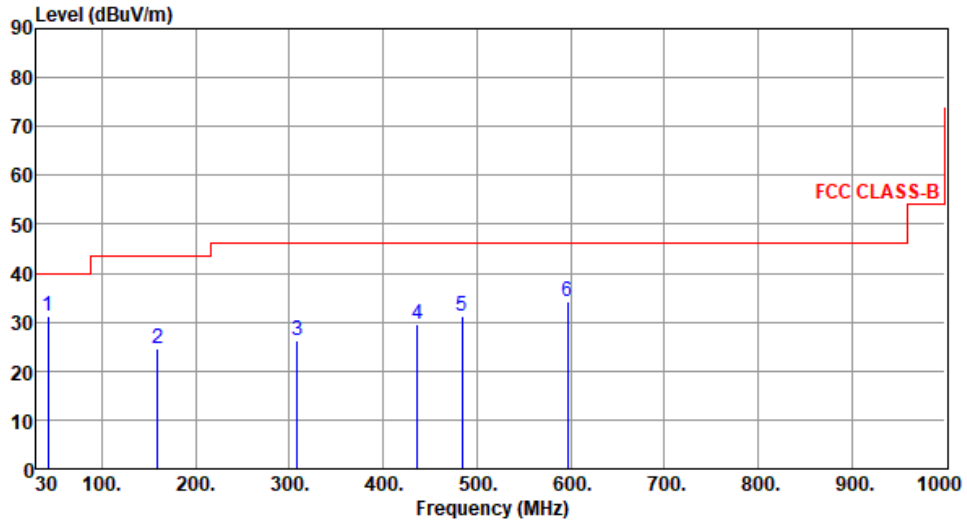

	Freq. MHz	Emission level dBuV/m	Limit dBuV/m	Margin dB	SA reading dBuV	Factor dB	Remark	ANT High cm	Turn Table deg
1	42.61	31.27	40.00	-8.73	40.09	-8.82	Peak	---	---
2	159.01	24.51	43.50	-18.99	33.43	-8.92	Peak	---	---
3	308.39	26.23	46.00	-19.77	34.45	-8.22	Peak	---	---
4	436.43	29.42	46.00	-16.58	33.89	-4.47	Peak	---	---
5	483.96	31.17	46.00	-14.83	34.57	-3.40	Peak	---	---
6	596.48	34.25	46.00	-11.75	35.03	-0.78	Peak	---	---

Note 1: Emission Level (dBuV/m) = SA Reading (dBuV/m) + Factor* (dB)

*Factor includes antenna factor , cable loss and amplifier gain

Note 2: Margin (dB) = Emission level (dBuV/m) – Limit (dBuV/m).

Note 3: All spurious emissions below 30MHz are more than 20 dB below the limit.

Modulation	HT40	Test Freq. (MHz)	5795
Polarization	Horizontal		

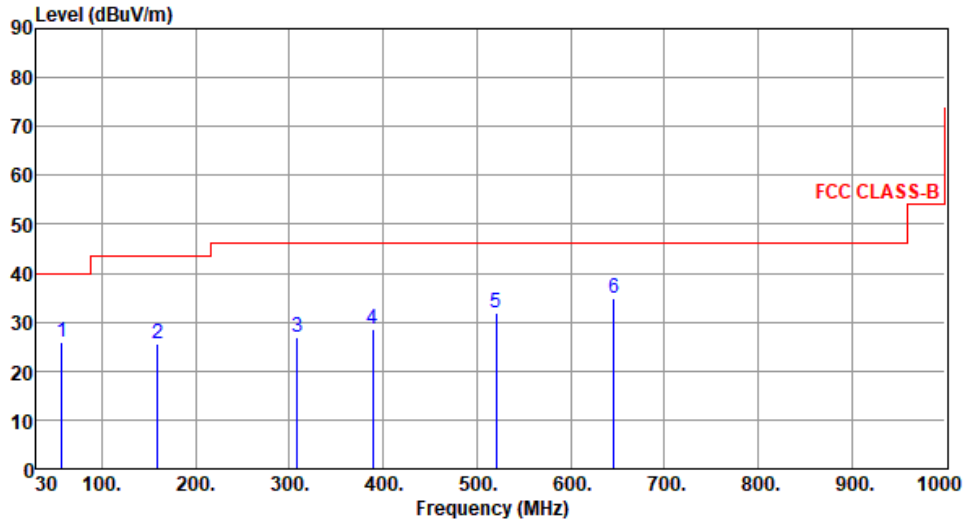

	Freq. MHz	Emission level dBuV/m	Limit dBuV/m	Margin dB	SA reading dBuV	Factor dB	Remark	ANT High cm	Turn Table deg
1	57.16	25.79	40.00	-14.21	34.85	-9.06	Peak	---	---
2	159.01	25.43	43.50	-18.07	34.35	-8.92	Peak	---	---
3	308.39	26.92	46.00	-19.08	35.14	-8.22	Peak	---	---
4	388.90	28.64	46.00	-17.36	34.65	-6.01	Peak	---	---
5	520.82	31.97	46.00	-14.03	34.54	-2.57	Peak	---	---
6	645.95	34.99	46.00	-11.01	34.39	0.60	Peak	---	---

Note 1: Emission Level (dBuV/m) = SA Reading (dBuV/m) + Factor* (dB)

*Factor includes antenna factor , cable loss and amplifier gain

Note 2: Margin (dB) = Emission level (dBuV/m) – Limit (dBuV/m).

Note 3: All spurious emissions below 30MHz are more than 20 dB below the limit.

Modulation	HT40	Test Freq. (MHz)	5795
Polarization	Vertical		

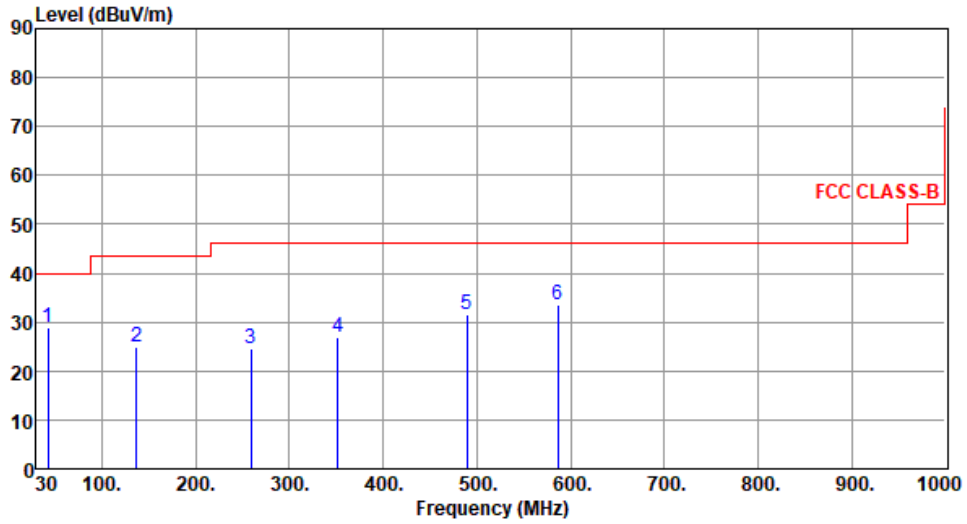

	Freq. MHz	Emission level dBuV/m	Limit dBuV/m	Margin dB	SA reading dBuV	Factor dB	Remark	ANT High cm	Turn Table deg
1	42.61	28.77	40.00	-11.23	37.59	-8.82	Peak	---	---
2	136.70	24.81	43.50	-18.69	34.39	-9.58	Peak	---	---
3	258.92	24.62	46.00	-21.38	34.55	-9.93	Peak	---	---
4	352.04	27.05	46.00	-18.95	34.25	-7.20	Peak	---	---
5	489.78	31.70	46.00	-14.30	35.08	-3.38	Peak	---	---
6	586.78	33.71	46.00	-12.29	34.71	-1.00	Peak	---	---

Note 1: Emission Level (dBuV/m) = SA Reading (dBuV/m) + Factor* (dB)

*Factor includes antenna factor , cable loss and amplifier gain

Note 2: Margin (dB) = Emission level (dBuV/m) – Limit (dBuV/m).

Note 3: All spurious emissions below 30MHz are more than 20 dB below the limit.

3.5.5 Transmitter Radiated Unwanted Emissions (Above 1GHz) for 11a

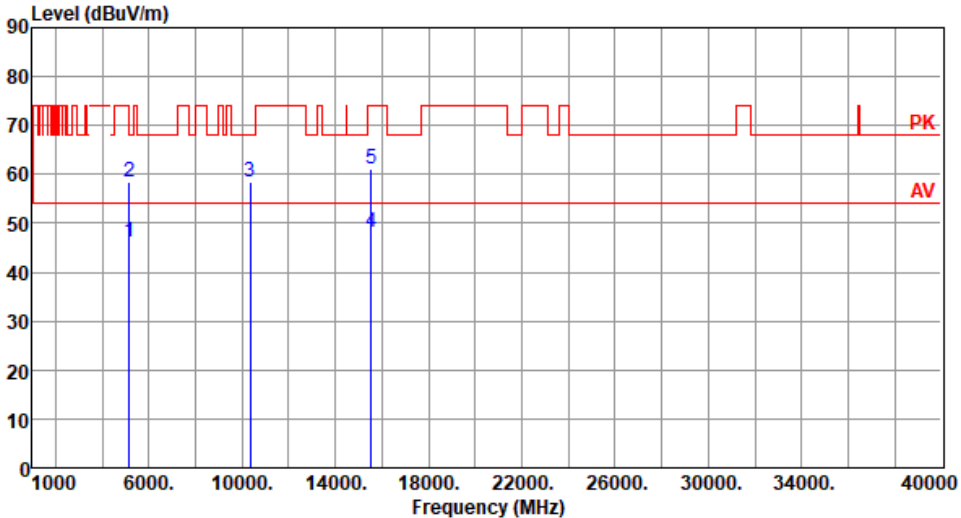
Modulation	11a	Test Freq. (MHz)	5180						
Polarization	Horizontal								
									
	Freq.	Emission level	Limit	Margin	SA reading	Factor	Remark	ANT High	Turn Table
	MHz	dBuV/m	dBuV/m	dB	dBuV	dB		cm	deg
1	5150.00	46.00	54.00	-8.00	38.68	7.32	Average	100	122
2	5150.00	58.60	74.00	-15.40	51.28	7.32	Peak	100	122
3	10360.00	58.44	68.20	-9.76	42.35	16.09	Peak	100	60
4	15540.00	48.05	54.00	-5.95	30.68	17.37	Average	100	333
5	15540.00	60.96	74.00	-13.04	43.59	17.37	Peak	100	333

Note 1: Emission Level (dBuV/m) = SA Reading (dBuV/m) + Factor* (dB)
*Factor includes antenna factor , cable loss and amplifier gain
Note 2: Margin (dB) = Emission level (dBuV/m) – Limit (dBuV/m).

Modulation	11a	Test Freq. (MHz)	5180
Polarization	Vertical		

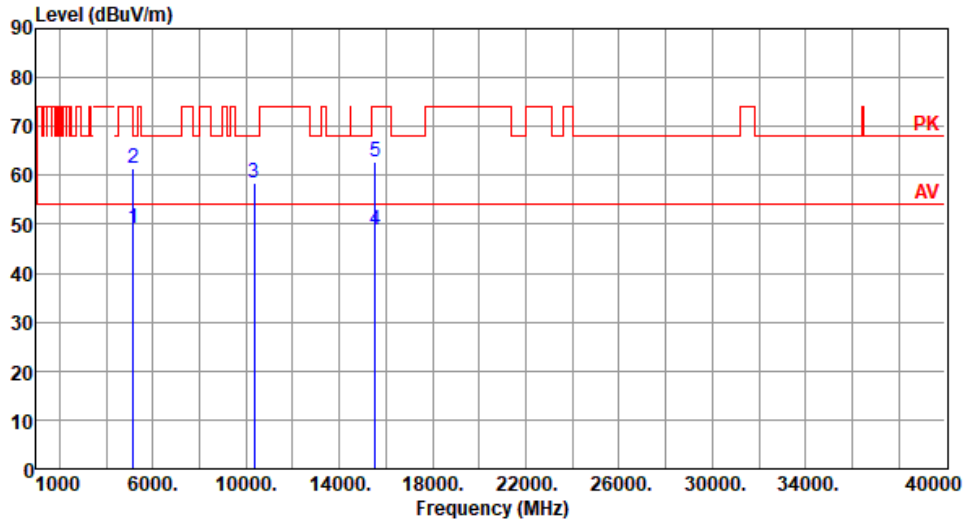

	Freq. MHz	Emission level dBuV/m	Limit dBuV/m	Margin dB	SA reading dBuV	Factor dB	Remark	ANT High cm	Turn Table deg
1	5150.00	49.04	54.00	-4.96	41.72	7.32	Average	124	22
2	5150.00	61.60	74.00	-12.40	54.28	7.32	Peak	124	22
3	10360.00	58.55	68.20	-9.65	42.46	16.09	Peak	100	30
4	15540.00	48.93	54.00	-5.07	31.56	17.37	Average	100	335
5	15540.00	62.63	74.00	-11.37	45.26	17.37	Peak	100	335

Note 1: Emission Level (dBuV/m) = SA Reading (dBuV/m) + Factor* (dB)

*Factor includes antenna factor , cable loss and amplifier gain

Note 2: Margin (dB) = Emission level (dBuV/m) – Limit (dBuV/m).

Modulation	11a	Test Freq. (MHz)	5240
Polarization	Horizontal		

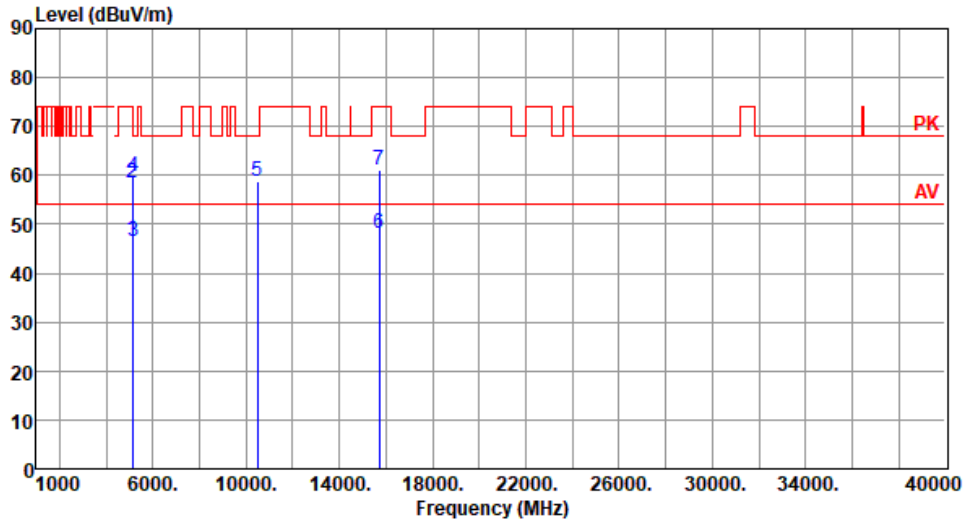

	Freq. MHz	Emission level dBuV/m	Limit dBuV/m	Margin dB	SA reading dBuV	Factor dB	Remark	ANT High cm	Turn Table deg
1	5120.00	46.98	54.00	-7.02	39.67	7.31	Average	100	125
2	5120.00	58.48	74.00	-15.52	51.17	7.31	Peak	100	125
3	5150.00	46.56	54.00	-7.44	39.24	7.32	Average	100	125
4	5150.00	59.65	74.00	-14.35	52.33	7.32	Peak	100	125
5	10480.00	58.86	68.20	-9.34	42.45	16.41	Peak	100	60
6	15720.00	48.16	54.00	-5.84	31.56	16.60	Average	100	353
7	15720.00	61.16	74.00	-12.84	44.56	16.60	Peak	100	353

Note 1: Emission Level (dBuV/m) = SA Reading (dBuV/m) + Factor* (dB)

*Factor includes antenna factor , cable loss and amplifier gain

Note 2: Margin (dB) = Emission level (dBuV/m) – Limit (dBuV/m).

Modulation	11a	Test Freq. (MHz)	5240
Polarization	Vertical		

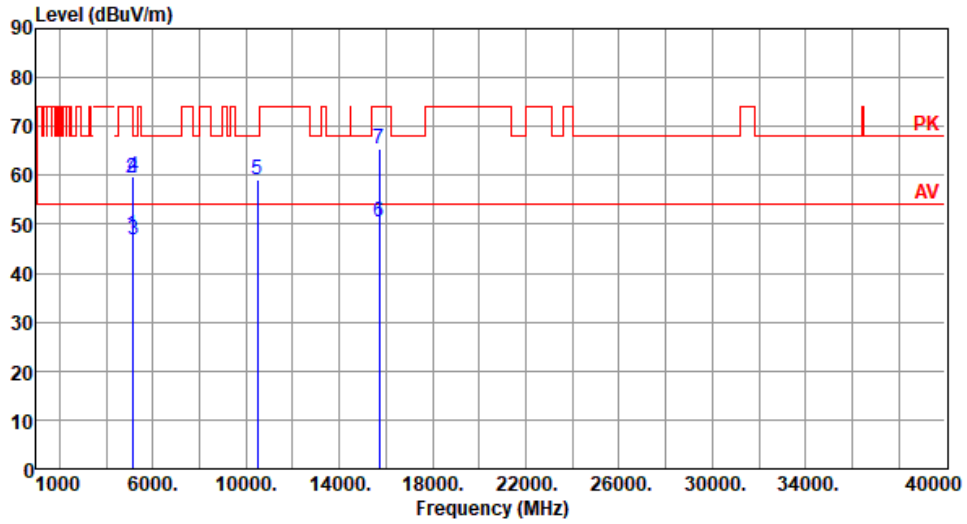

	Freq. MHz	Emission level dBuV/m	Limit dBuV/m	Margin dB	SA reading dBuV	Factor dB	Remark	ANT High cm	Turn Table deg
1	5120.00	47.78	54.00	-6.22	40.47	7.31	Average	100	334
2	5120.00	59.47	74.00	-14.53	52.16	7.31	Peak	100	334
3	5150.00	46.77	54.00	-7.23	39.45	7.32	Average	100	334
4	5150.00	59.72	74.00	-14.28	52.40	7.32	Peak	100	334
5	10480.00	59.00	68.20	-9.20	42.59	16.41	Peak	100	20
6	15720.00	50.58	54.00	-3.42	33.98	16.60	Average	100	334
7	15720.00	65.27	74.00	-8.73	48.67	16.60	Peak	100	334

Note 1: Emission Level (dBuV/m) = SA Reading (dBuV/m) + Factor* (dB)

*Factor includes antenna factor , cable loss and amplifier gain

Note 2: Margin (dB) = Emission level (dBuV/m) – Limit (dBuV/m).

Modulation	11a	Test Freq. (MHz)	5300
Polarization	Horizontal		

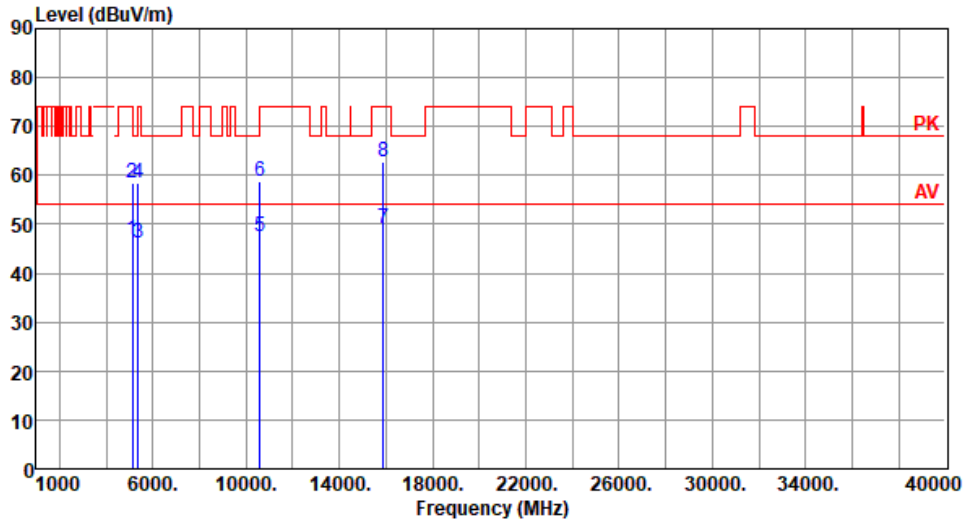

	Freq. MHz	Emission level dBuV/m	Limit dBuV/m	Margin dB	SA reading dBuV	Factor dB	Remark	ANT High cm	Turn Table deg
1	5120.00	46.78	54.00	-7.22	39.47	7.31	Average	100	123
2	5120.00	58.51	74.00	-15.49	51.20	7.31	Peak	100	123
3	5350.00	46.10	54.00	-7.90	39.25	6.85	Average	100	122
4	5350.00	58.40	74.00	-15.60	51.55	6.85	Peak	100	122
5	10600.00	47.61	54.00	-6.39	31.25	16.36	Average	100	40
6	10600.00	58.83	74.00	-15.17	42.47	16.36	Peak	100	40
7	15900.00	49.24	54.00	-4.76	32.55	16.69	Average	153	356
8	15900.00	62.70	74.00	-11.30	46.01	16.69	Peak	153	356

Note 1: Emission Level (dBuV/m) = SA Reading (dBuV/m) + Factor* (dB)

*Factor includes antenna factor , cable loss and amplifier gain

Note 2: Margin (dB) = Emission level (dBuV/m) – Limit (dBuV/m).

Modulation	11a	Test Freq. (MHz)	5300
Polarization	Vertical		

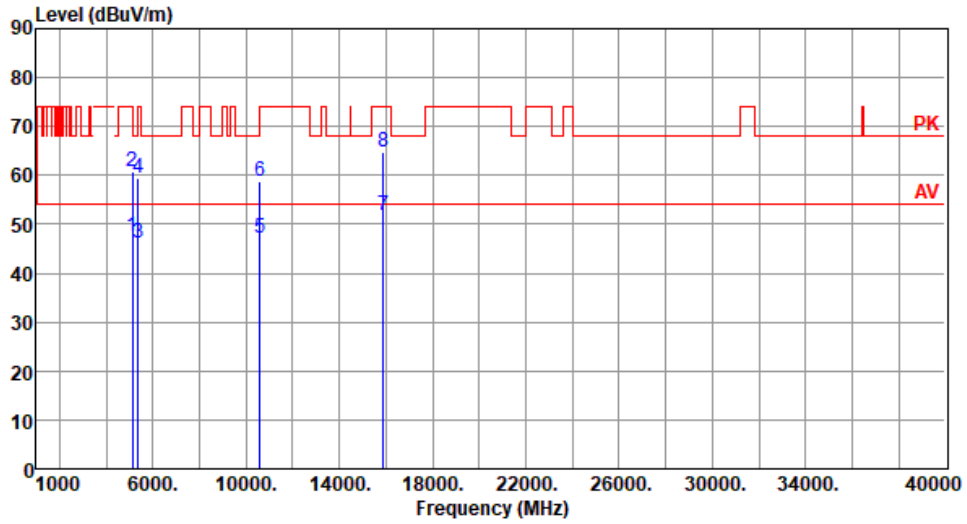

	Freq. MHz	Emission level dBuV/m	Limit dBuV/m	Margin dB	SA reading dBuV	Factor dB	Remark	ANT High cm	Turn Table deg
1	5120.00	47.56	54.00	-6.44	40.25	7.31	Average	107	36
2	5120.00	60.78	74.00	-13.22	53.47	7.31	Peak	107	36
3	5350.00	46.31	54.00	-7.69	39.46	6.85	Average	107	36
4	5350.00	59.31	74.00	-14.69	52.46	6.85	Peak	107	36
5	10600.00	47.23	54.00	-6.77	30.87	16.36	Average	100	60
6	10600.00	58.81	74.00	-15.19	42.45	16.36	Peak	100	60
7	15900.00	51.65	54.00	-2.35	34.96	16.69	Average	116	334
8	15900.00	64.82	74.00	-9.18	48.13	16.69	Peak	116	334

Note 1: Emission Level (dBuV/m) = SA Reading (dBuV/m) + Factor* (dB)

*Factor includes antenna factor , cable loss and amplifier gain

Note 2: Margin (dB) = Emission level (dBuV/m) – Limit (dBuV/m).

Modulation	11a	Test Freq. (MHz)	5500
Polarization	Horizontal		

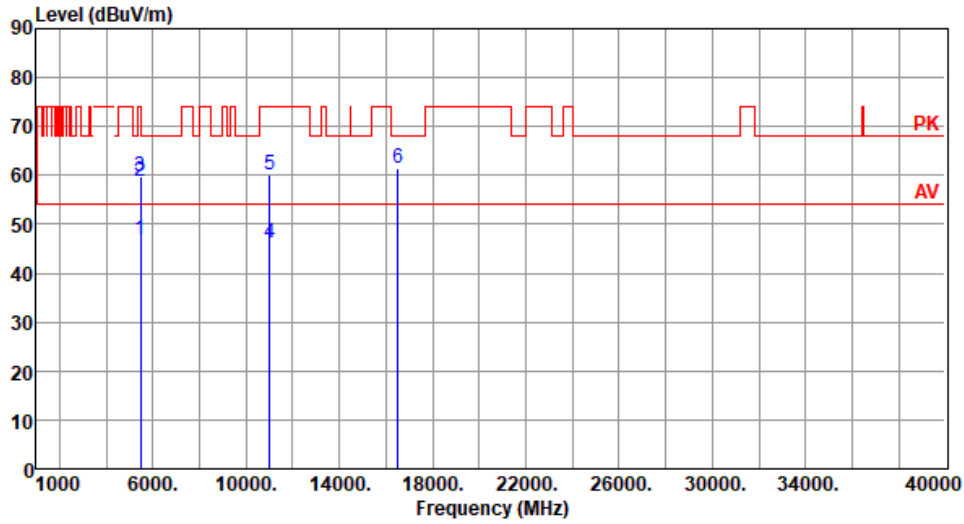

	Freq. MHz	Emission level dBuV/m	Limit dBuV/m	Margin dB	SA reading dBuV	Factor dB	Remark	ANT High cm	Turn Table deg
1	5460.00	46.70	54.00	-7.30	39.45	7.25	Average	100	126
2	5460.00	58.94	74.00	-15.06	51.69	7.25	Peak	100	126
3	5470.00	59.87	68.20	-8.33	52.59	7.28	Peak	100	126
4	11000.00	46.09	54.00	-7.91	29.25	16.84	Average	100	30
5	11000.00	60.03	74.00	-13.97	43.19	16.84	Peak	100	30
6	16500.00	61.49	68.20	-6.71	43.85	17.64	Peak	216	2

Note 1: Emission Level (dBuV/m) = SA Reading (dBuV/m) + Factor* (dB)

*Factor includes antenna factor , cable loss and amplifier gain

Note 2: Margin (dB) = Emission level (dBuV/m) – Limit (dBuV/m).

Modulation	11a	Test Freq. (MHz)	5500
Polarization	Vertical		

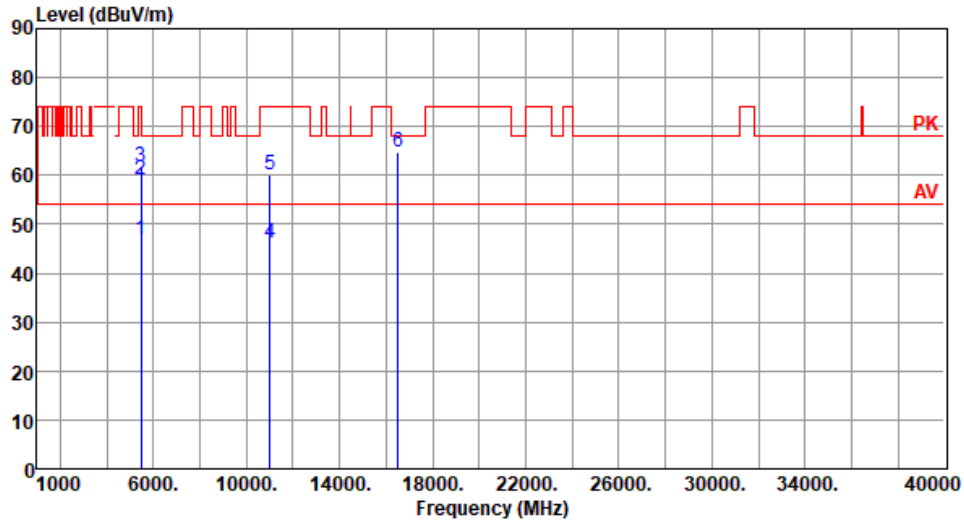

	Freq. MHz	Emission level dBuV/m	Limit dBuV/m	Margin dB	SA reading dBuV	Factor dB	Remark	ANT High cm	Turn Table deg
1	5460.00	46.93	54.00	-7.07	39.68	7.25	Average	112	35
2	5460.00	59.01	74.00	-14.99	51.76	7.25	Peak	112	35
3	5470.00	61.88	68.20	-6.32	54.60	7.28	Peak	112	35
4	11000.00	46.15	54.00	-7.85	29.31	16.84	Average	100	50
5	11000.00	60.09	74.00	-13.91	43.25	16.84	Peak	100	50
6	16500.00	64.60	68.20	-3.60	46.96	17.64	Peak	235	305

Note 1: Emission Level (dBuV/m) = SA Reading (dBuV/m) + Factor* (dB)

*Factor includes antenna factor , cable loss and amplifier gain

Note 2: Margin (dB) = Emission level (dBuV/m) – Limit (dBuV/m).

Modulation	11a	Test Freq. (MHz)	5580
Polarization	Horizontal		

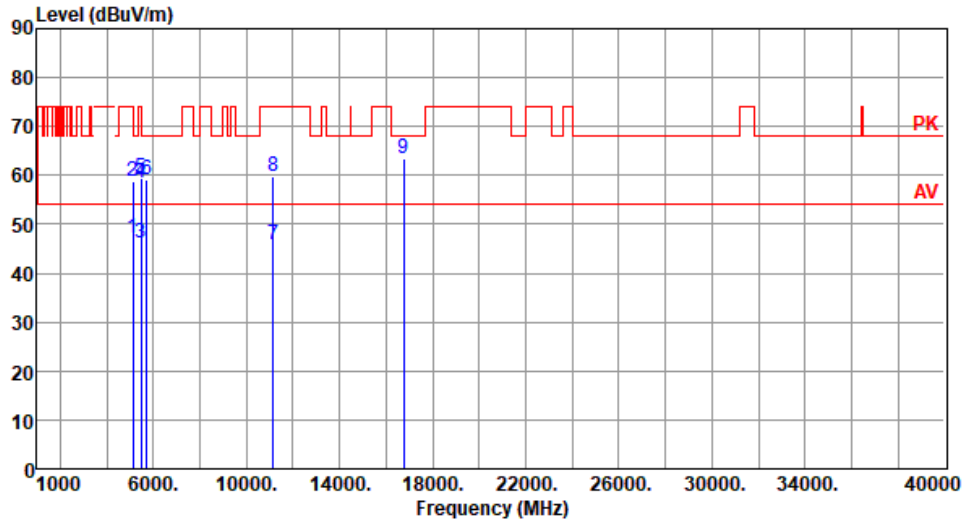

	Freq. MHz	Emission level dBuV/m	Limit dBuV/m	Margin dB	SA reading dBuV	Factor dB	Remark	ANT High cm	Turn Table deg
1	5120.00	47.09	54.00	-6.91	39.78	7.31	Average	100	125
2	5120.00	58.90	74.00	-15.10	51.59	7.31	Peak	100	125
3	5460.00	46.30	54.00	-7.70	39.05	7.25	Average	100	125
4	5460.00	58.38	74.00	-15.62	51.13	7.25	Peak	100	125
5	5470.00	59.41	68.20	-8.79	52.13	7.28	Peak	100	125
6	5725.00	59.11	68.20	-9.09	51.45	7.66	Peak	100	125
7	11160.00	45.91	54.00	-8.09	29.32	16.59	Average	100	60
8	11160.00	59.77	74.00	-14.23	43.18	16.59	Peak	100	60
9	16740.00	63.59	68.20	-4.61	45.36	18.23	Peak	215	0

Note 1: Emission Level (dBuV/m) = SA Reading (dBuV/m) + Factor* (dB)

*Factor includes antenna factor , cable loss and amplifier gain

Note 2: Margin (dB) = Emission level (dBuV/m) – Limit (dBuV/m).

Modulation	11a	Test Freq. (MHz)	5580
Polarization	Vertical		

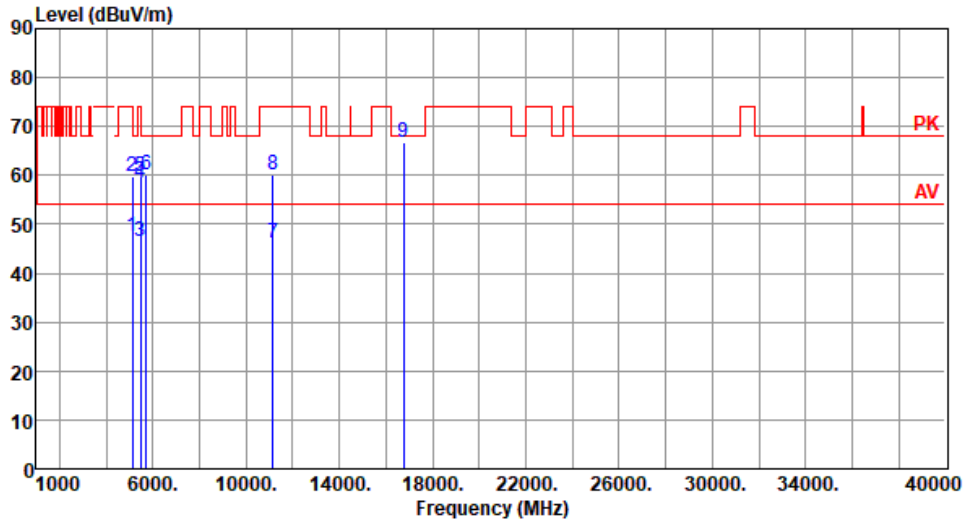

	Freq. MHz	Emission level dBuV/m	Limit dBuV/m	Margin dB	SA reading dBuV	Factor dB	Remark	ANT High cm	Turn Table deg
1	5120.00	47.56	54.00	-6.44	40.25	7.31	Average	108	2
2	5120.00	59.78	74.00	-14.22	52.47	7.31	Peak	108	2
3	5460.00	46.37	54.00	-7.63	39.12	7.25	Average	108	2
4	5460.00	58.51	74.00	-15.49	51.26	7.25	Peak	108	2
5	5470.00	59.74	68.20	-8.46	52.46	7.28	Peak	108	2
6	5725.00	60.18	68.20	-8.02	52.52	7.66	Peak	108	2
7	11160.00	46.04	54.00	-7.96	29.45	16.59	Average	100	40
8	11160.00	60.04	74.00	-13.96	43.45	16.59	Peak	100	40
9	16740.00	66.71	68.20	-1.49	48.48	18.23	Peak	232	308

Note 1: Emission Level (dBuV/m) = SA Reading (dBuV/m) + Factor* (dB)

*Factor includes antenna factor , cable loss and amplifier gain

Note 2: Margin (dB) = Emission level (dBuV/m) – Limit (dBuV/m).

Modulation	11a	Test Freq. (MHz)	5700
Polarization	Horizontal		

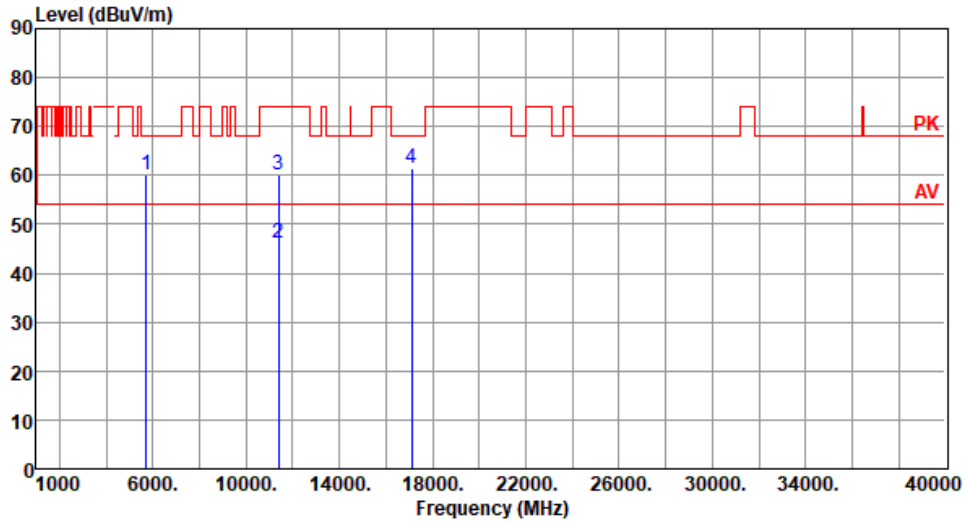

	Freq. MHz	Emission level dBuV/m	Limit dBuV/m	Margin dB	SA reading dBuV	Factor dB	Remark	ANT High cm	Turn Table deg
1	5725.00	60.21	68.20	-7.99	52.55	7.66	Peak	100	128
2	11400.00	46.00	54.00	-8.00	29.27	16.73	Average	100	30
3	11400.00	59.97	74.00	-14.03	43.24	16.73	Peak	100	30
4	17100.00	61.36	68.20	-6.84	43.12	18.24	Peak	211	1

Note 1: Emission Level (dBuV/m) = SA Reading (dBuV/m) + Factor* (dB)

*Factor includes antenna factor , cable loss and amplifier gain

Note 2: Margin (dB) = Emission level (dBuV/m) – Limit (dBuV/m).

Modulation	11a	Test Freq. (MHz)	5700
Polarization	Vertical		

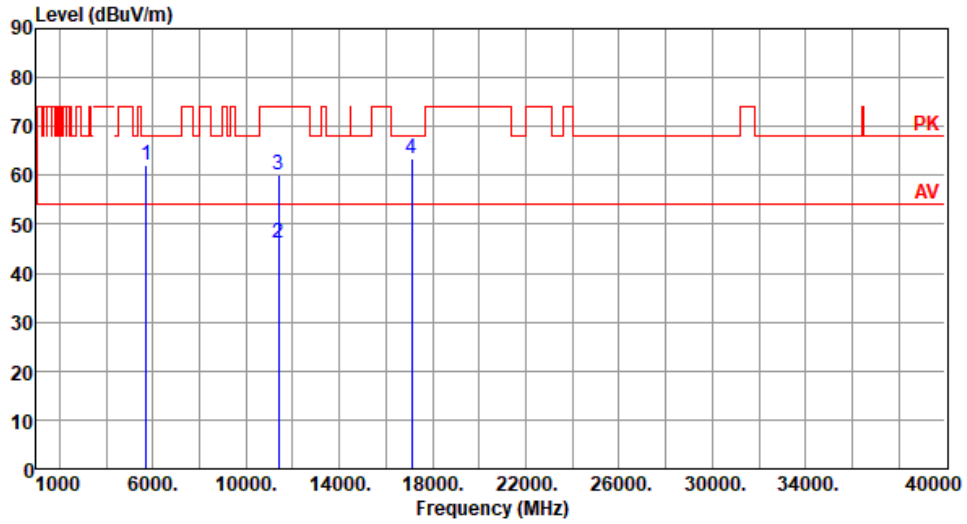

	Freq. MHz	Emission level dBuV/m	Limit dBuV/m	Margin dB	SA reading dBuV	Factor dB	Remark	ANT High cm	Turn Table deg
1	5725.00	62.15	68.20	-6.05	54.49	7.66	Peak	108	36
2	11400.00	46.10	54.00	-7.90	29.37	16.73	Average	100	20
3	11400.00	60.14	74.00	-13.86	43.41	16.73	Peak	100	20
4	17100.00	63.46	68.20	-4.74	45.22	18.24	Peak	233	306

Note 1: Emission Level (dBuV/m) = SA Reading (dBuV/m) + Factor* (dB)

*Factor includes antenna factor , cable loss and amplifier gain

Note 2: Margin (dB) = Emission level (dBuV/m) – Limit (dBuV/m).

Modulation	11a	Test Freq. (MHz)	5720
Polarization	Horizontal		

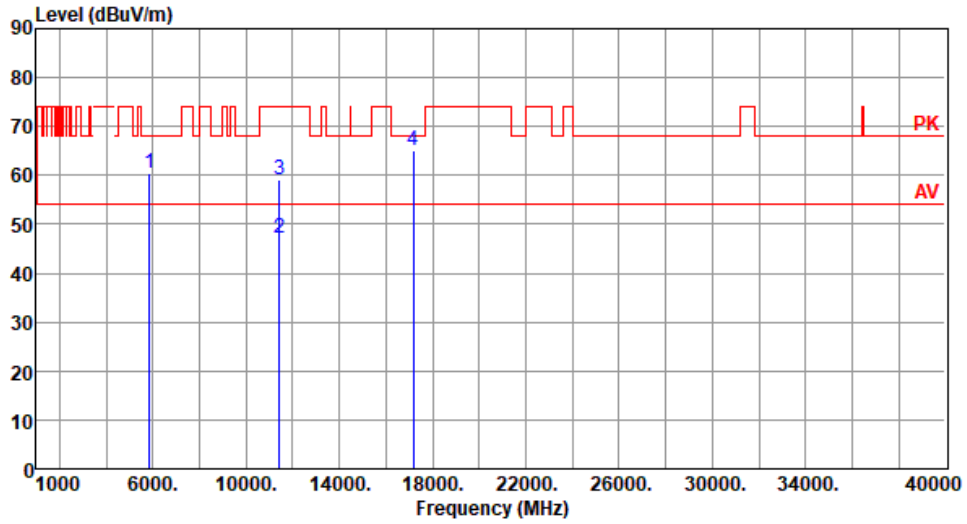

	Freq. MHz	Emission level dBuV/m	Limit dBuV/m	Margin dB	SA reading dBuV	Factor dB	Remark	ANT High cm	Turn Table deg
1	5850.00	60.44	68.20	-7.76	52.42	8.02	Peak	100	129
2	11440.00	47.19	54.00	-6.81	30.45	16.74	Average	100	25
3	11440.00	59.10	74.00	-14.90	42.36	16.74	Peak	100	25
4	17160.00	64.95	68.20	-3.25	46.57	18.38	Peak	141	20

Note 1: Emission Level (dBuV/m) = SA Reading (dBuV/m) + Factor* (dB)

*Factor includes antenna factor , cable loss and amplifier gain

Note 2: Margin (dB) = Emission level (dBuV/m) – Limit (dBuV/m).

Modulation	11a	Test Freq. (MHz)	5720
Polarization	Vertical		

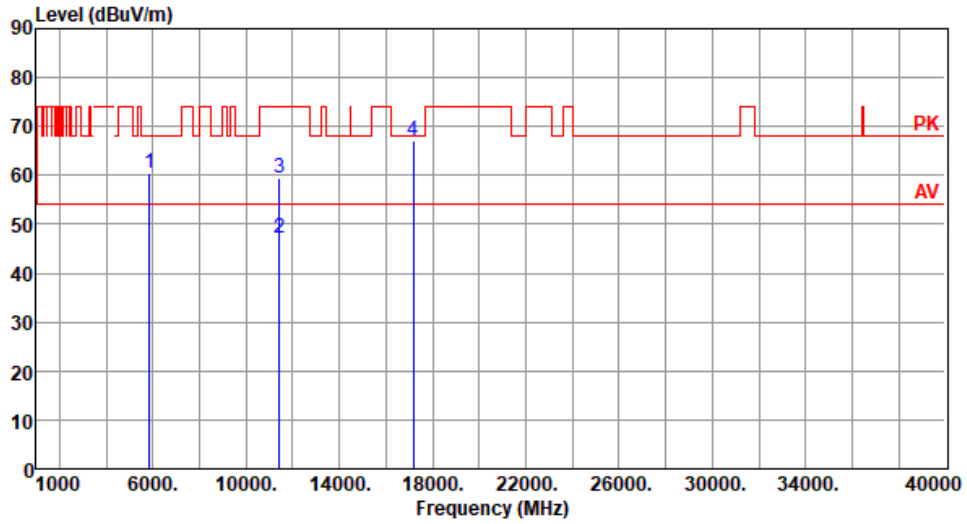

	Freq. MHz	Emission level dBuV/m	Limit dBuV/m	Margin dB	SA reading dBuV	Factor dB	Remark	ANT High cm	Turn Table deg
1	5850.00	60.56	68.20	-7.64	52.54	8.02	Peak	144	142
2	11440.00	47.03	54.00	-6.97	30.29	16.74	Average	100	46
3	11440.00	59.50	74.00	-14.50	42.76	16.74	Peak	100	46
4	17160.00	67.19	68.20	-1.01	48.81	18.38	Peak	231	320

Note 1: Emission Level (dBuV/m) = SA Reading (dBuV/m) + Factor* (dB)

*Factor includes antenna factor , cable loss and amplifier gain

Note 2: Margin (dB) = Emission level (dBuV/m) – Limit (dBuV/m).

Modulation	11a	Test Freq. (MHz)	5745
Polarization	Horizontal		

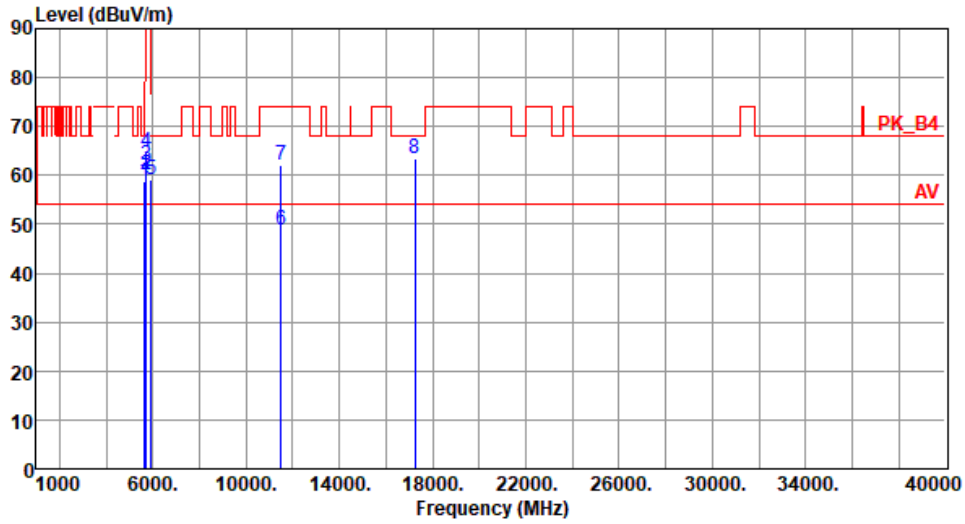

	Freq. MHz	Emission level dBuV/m	Limit dBuV/m	Margin dB	SA reading dBuV	Factor dB	Remark	ANT High cm	Turn Table deg
1	5650.00	58.87	68.20	-9.33	51.48	7.39	Peak	100	124
2	5700.00	60.06	105.20	-45.14	52.56	7.50	Peak	100	124
3	5720.00	62.21	110.80	-48.59	54.59	7.62	Peak	100	124
4	5725.00	64.91	122.20	-57.29	57.25	7.66	Peak	100	124
5	5925.00	59.22	68.20	-8.98	51.15	8.07	Peak	100	124
6	11490.00	48.92	54.00	-5.08	32.16	16.76	Average	220	285
7	11490.00	61.99	74.00	-12.01	45.23	16.76	Peak	220	285
8	17235.00	63.30	68.20	-4.90	44.66	18.64	Peak	100	297

Note 1: Emission Level (dBuV/m) = SA Reading (dBuV/m) + Factor* (dB)

*Factor includes antenna factor , cable loss and amplifier gain

Note 2: Margin (dB) = Emission level (dBuV/m) – Limit (dBuV/m).

Modulation	11a	Test Freq. (MHz)	5745
Polarization	Vertical		

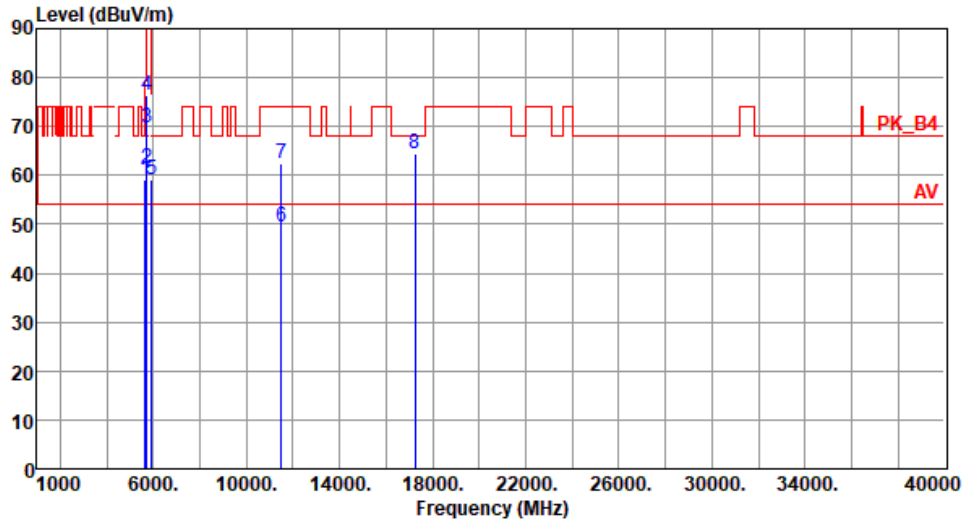

	Freq. MHz	Emission level dBuV/m	Limit dBuV/m	Margin dB	SA reading dBuV	Factor dB	Remark	ANT High cm	Turn Table deg
1	5650.00	58.95	68.20	-9.25	51.56	7.39	Peak	174	39
2	5700.00	61.55	105.20	-43.65	54.05	7.50	Peak	174	39
3	5720.00	69.81	110.80	-40.99	62.19	7.62	Peak	174	39
4	5725.00	76.34	122.20	-45.86	68.68	7.66	Peak	174	39
5	5925.00	59.24	68.20	-8.96	51.17	8.07	Peak	174	39
6	11490.00	49.38	54.00	-4.62	32.62	16.76	Average	115	319
7	11490.00	62.46	74.00	-11.54	45.70	16.76	Peak	115	319
8	17235.00	64.53	68.20	-3.67	45.89	18.64	Peak	105	296

Note 1: Emission Level (dBuV/m) = SA Reading (dBuV/m) + Factor* (dB)

*Factor includes antenna factor , cable loss and amplifier gain

Note 2: Margin (dB) = Emission level (dBuV/m) – Limit (dBuV/m).

Modulation	11a	Test Freq. (MHz)	5785
Polarization	Horizontal		

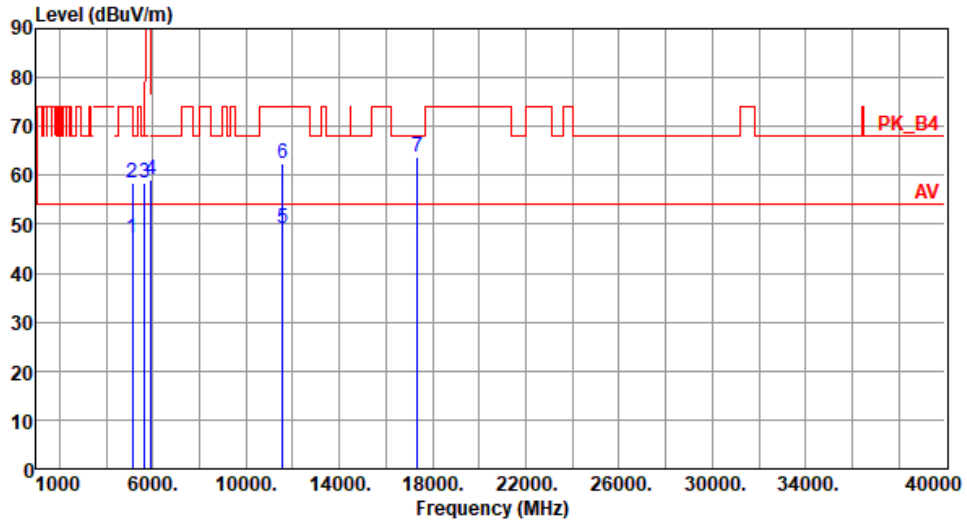

	Freq. MHz	Emission level dBuV/m	Limit dBuV/m	Margin dB	SA reading dBuV	Factor dB	Remark	ANT High cm	Turn Table deg
1	5120.00	47.17	54.00	-6.83	39.86	7.31	Average	100	129
2	5120.00	58.33	74.00	-15.67	51.02	7.31	Peak	100	129
3	5650.00	58.51	68.20	-9.69	51.12	7.39	Peak	100	129
4	5925.00	59.19	68.20	-9.01	51.12	8.07	Peak	100	129
5	11570.00	48.99	54.00	-5.01	32.38	16.61	Average	219	287
6	11570.00	62.50	74.00	-11.50	45.89	16.61	Peak	219	287
7	17355.00	63.80	68.20	-4.40	44.57	19.23	Peak	100	296

Note 1: Emission Level (dBuV/m) = SA Reading (dBuV/m) + Factor* (dB)

*Factor includes antenna factor , cable loss and amplifier gain

Note 2: Margin (dB) = Emission level (dBuV/m) – Limit (dBuV/m).

Modulation	11a	Test Freq. (MHz)	5785
Polarization	Vertical		

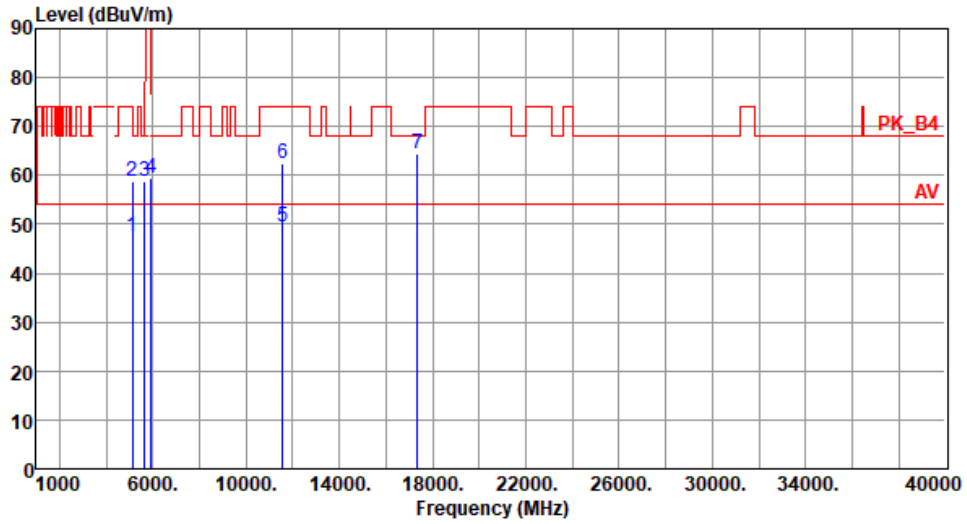

	Freq. MHz	Emission level dBuV/m	Limit dBuV/m	Margin dB	SA reading dBuV	Factor dB	Remark	ANT High cm	Turn Table deg
1	5120.00	47.57	54.00	-6.43	40.26	7.31	Average	170	33
2	5120.00	58.67	74.00	-15.33	51.36	7.31	Peak	170	33
3	5650.00	58.85	68.20	-9.35	51.46	7.39	Peak	170	33
4	5925.00	59.33	68.20	-8.87	51.26	8.07	Peak	170	33
5	11570.00	49.45	54.00	-4.55	32.84	16.61	Average	114	313
6	11570.00	62.49	74.00	-11.51	45.88	16.61	Peak	114	313
7	17355.00	64.59	68.20	-3.61	45.36	19.23	Peak	103	295

Note 1: Emission Level (dBuV/m) = SA Reading (dBuV/m) + Factor* (dB)

*Factor includes antenna factor , cable loss and amplifier gain

Note 2: Margin (dB) = Emission level (dBuV/m) – Limit (dBuV/m).

Modulation	11a	Test Freq. (MHz)	5825
Polarization	Horizontal		

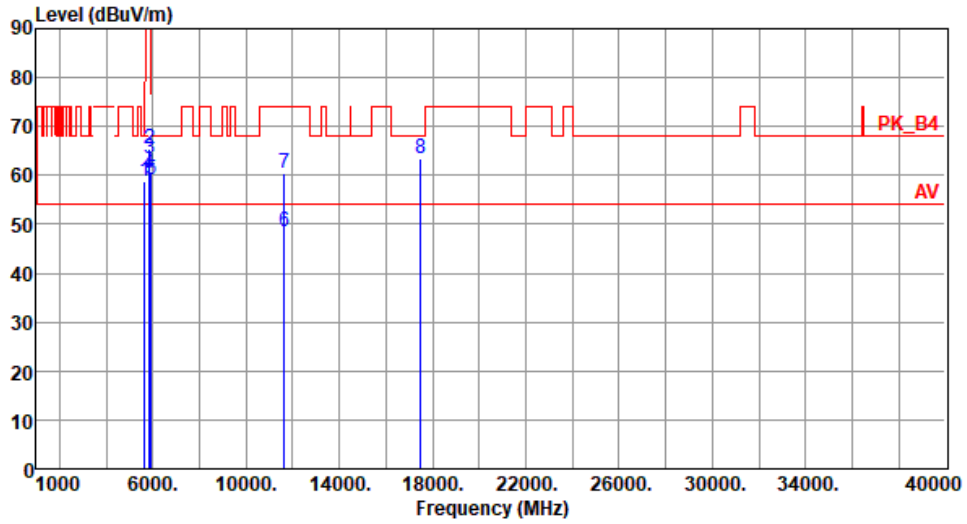

	Freq. MHz	Emission level dBuV/m	Limit dBuV/m	Margin dB	SA reading dBuV	Factor dB	Remark	ANT High cm	Turn Table deg
1	5650.00	58.64	68.20	-9.56	51.25	7.39	Peak	100	127
2	5850.00	65.48	122.20	-56.72	57.46	8.02	Peak	100	127
3	5855.00	63.48	110.80	-47.32	55.46	8.02	Peak	100	127
4	5875.00	60.48	105.20	-44.72	52.45	8.03	Peak	100	127
5	5925.00	59.24	68.20	-8.96	51.17	8.07	Peak	100	127
6	11650.00	48.59	54.00	-5.41	32.21	16.38	Average	225	284
7	11650.00	60.43	74.00	-13.57	44.05	16.38	Peak	225	284
8	17475.00	63.38	68.20	-4.82	43.64	19.74	Peak	100	295

Note 1: Emission Level (dBuV/m) = SA Reading (dBuV/m) + Factor* (dB)

*Factor includes antenna factor , cable loss and amplifier gain

Note 2: Margin (dB) = Emission level (dBuV/m) – Limit (dBuV/m).

Modulation	11a	Test Freq. (MHz)	5825
Polarization	Vertical		

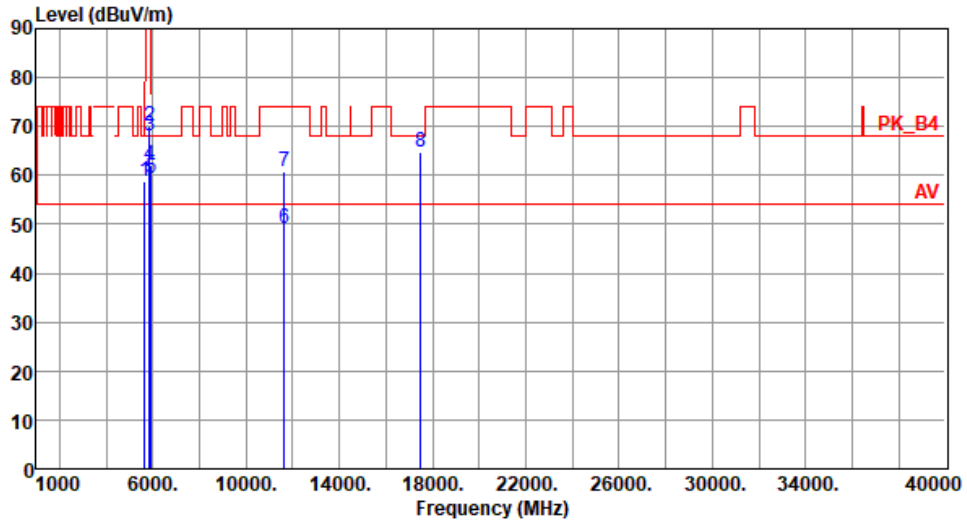

	Freq. MHz	Emission level dBuV/m	Limit dBuV/m	Margin dB	SA reading dBuV	Factor dB	Remark	ANT High cm	Turn Table deg
1	5650.00	58.85	68.20	-9.35	51.46	7.39	Peak	174	38
2	5850.00	69.92	122.20	-52.28	61.90	8.02	Peak	174	38
3	5855.00	67.95	110.80	-42.85	59.93	8.02	Peak	174	38
4	5875.00	62.18	105.20	-43.02	54.15	8.03	Peak	174	38
5	5925.00	59.31	68.20	-8.89	51.24	8.07	Peak	174	38
6	11650.00	49.07	54.00	-4.93	32.69	16.38	Average	113	316
7	11650.00	60.64	74.00	-13.36	44.26	16.38	Peak	113	316
8	17475.00	64.61	68.20	-3.59	44.87	19.74	Peak	100	293

Note 1: Emission Level (dBuV/m) = SA Reading (dBuV/m) + Factor* (dB)

*Factor includes antenna factor , cable loss and amplifier gain

Note 2: Margin (dB) = Emission level (dBuV/m) – Limit (dBuV/m).

3.5.6 Transmitter Radiated Unwanted Emissions (Above 1GHz) for HT20

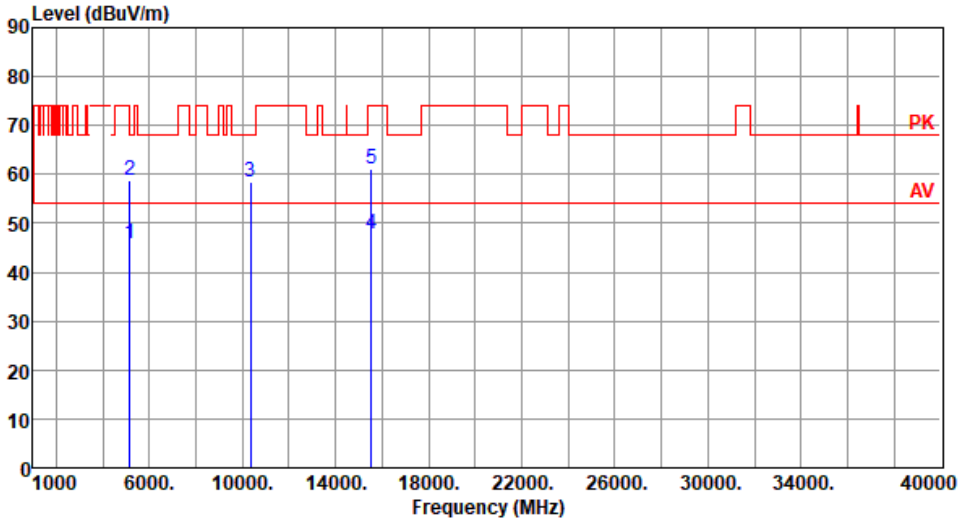
Modulation	HT20	Test Freq. (MHz)	5180																																																																
Polarization	Horizontal																																																																		
																																																																			
	<table border="1"> <thead> <tr> <th>Freq.</th> <th>Emission level</th> <th>Limit</th> <th>Margin</th> <th>SA reading</th> <th>Factor</th> <th>Remark</th> <th>ANT High</th> <th>Turn Table</th> </tr> <tr> <th>MHz</th> <th>dBuV/m</th> <th>dBuV/m</th> <th>dB</th> <th>dBuV</th> <th>dB</th> <th></th> <th>cm</th> <th>deg</th> </tr> </thead> <tbody> <tr> <td>1</td> <td>5150.00</td> <td>45.86</td> <td>54.00</td> <td>-8.14</td> <td>38.54</td> <td>7.32</td> <td>Average</td> <td>100 123</td> </tr> <tr> <td>2</td> <td>5150.00</td> <td>58.62</td> <td>74.00</td> <td>-15.38</td> <td>51.30</td> <td>7.32</td> <td>Peak</td> <td>100 123</td> </tr> <tr> <td>3</td> <td>10360.00</td> <td>58.34</td> <td>68.20</td> <td>-9.86</td> <td>42.25</td> <td>16.09</td> <td>Peak</td> <td>100 40</td> </tr> <tr> <td>4</td> <td>15540.00</td> <td>47.99</td> <td>54.00</td> <td>-6.01</td> <td>30.62</td> <td>17.37</td> <td>Average</td> <td>100 334</td> </tr> <tr> <td>5</td> <td>15540.00</td> <td>61.06</td> <td>74.00</td> <td>-12.94</td> <td>43.69</td> <td>17.37</td> <td>Peak</td> <td>100 334</td> </tr> </tbody> </table>	Freq.	Emission level	Limit	Margin	SA reading	Factor	Remark	ANT High	Turn Table	MHz	dBuV/m	dBuV/m	dB	dBuV	dB		cm	deg	1	5150.00	45.86	54.00	-8.14	38.54	7.32	Average	100 123	2	5150.00	58.62	74.00	-15.38	51.30	7.32	Peak	100 123	3	10360.00	58.34	68.20	-9.86	42.25	16.09	Peak	100 40	4	15540.00	47.99	54.00	-6.01	30.62	17.37	Average	100 334	5	15540.00	61.06	74.00	-12.94	43.69	17.37	Peak	100 334			
Freq.	Emission level	Limit	Margin	SA reading	Factor	Remark	ANT High	Turn Table																																																											
MHz	dBuV/m	dBuV/m	dB	dBuV	dB		cm	deg																																																											
1	5150.00	45.86	54.00	-8.14	38.54	7.32	Average	100 123																																																											
2	5150.00	58.62	74.00	-15.38	51.30	7.32	Peak	100 123																																																											
3	10360.00	58.34	68.20	-9.86	42.25	16.09	Peak	100 40																																																											
4	15540.00	47.99	54.00	-6.01	30.62	17.37	Average	100 334																																																											
5	15540.00	61.06	74.00	-12.94	43.69	17.37	Peak	100 334																																																											
<p>Note 1: Emission Level (dBuV/m) = SA Reading (dBuV/m) + Factor* (dB) *Factor includes antenna factor , cable loss and amplifier gain Note 2: Margin (dB) = Emission level (dBuV/m) – Limit (dBuV/m).</p>																																																																			

Modulation	HT20	Test Freq. (MHz)	5180
Polarization	Vertical		

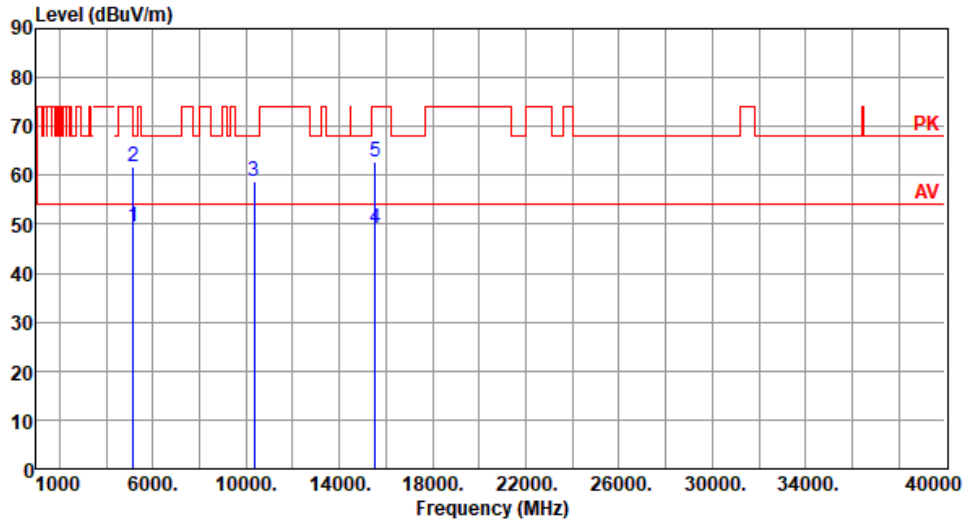

	Freq. MHz	Emission level dBuV/m	Limit dBuV/m	Margin dB	SA reading dBuV	Factor dB	Remark	ANT High cm	Turn Table deg
1	5150.00	49.36	54.00	-4.64	42.04	7.32	Average	125	23
2	5150.00	61.67	74.00	-12.33	54.35	7.32	Peak	125	23
3	10360.00	58.63	68.20	-9.57	42.54	16.09	Peak	100	40
4	15540.00	48.99	54.00	-5.01	31.62	17.37	Average	100	339
5	15540.00	62.68	74.00	-11.32	45.31	17.37	Peak	100	339

Note 1: Emission Level (dBuV/m) = SA Reading (dBuV/m) + Factor* (dB)

*Factor includes antenna factor , cable loss and amplifier gain

Note 2: Margin (dB) = Emission level (dBuV/m) – Limit (dBuV/m).

Modulation	HT20	Test Freq. (MHz)	5300
Polarization	Horizontal		

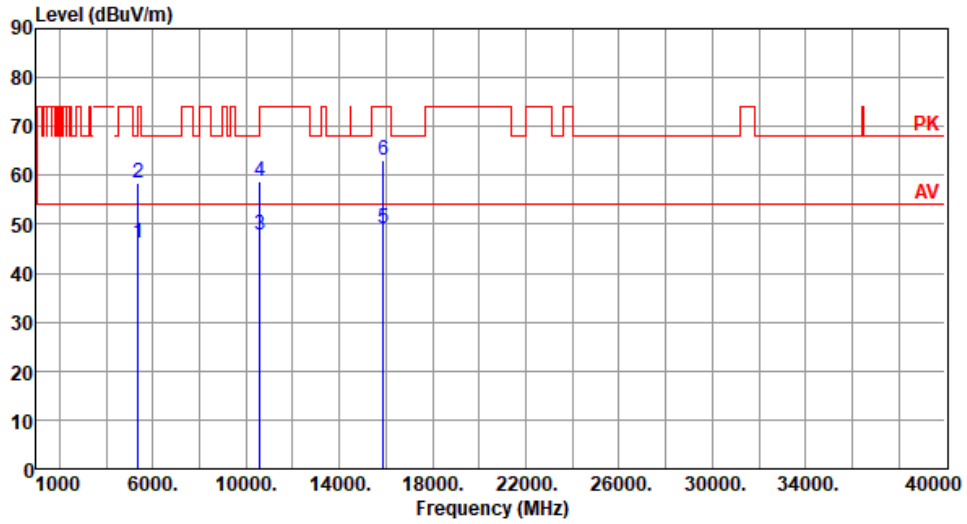

	Freq. MHz	Emission level dBuV/m	Limit dBuV/m	Margin dB	SA reading dBuV	Factor dB	Remark	ANT High cm	Turn Table deg
1	5350.00	46.30	54.00	-7.70	39.45	6.85	Average	100	125
2	5350.00	58.31	74.00	-15.69	51.46	6.85	Peak	100	125
3	10600.00	47.67	54.00	-6.33	31.31	16.36	Average	100	30
4	10600.00	58.87	74.00	-15.13	42.51	16.36	Peak	100	30
5	15900.00	49.30	54.00	-4.70	32.61	16.69	Average	154	355
6	15900.00	62.94	74.00	-11.06	46.25	16.69	Peak	154	355

Note 1: Emission Level (dBuV/m) = SA Reading (dBuV/m) + Factor* (dB)

*Factor includes antenna factor , cable loss and amplifier gain

Note 2: Margin (dB) = Emission level (dBuV/m) – Limit (dBuV/m).

Modulation	HT20	Test Freq. (MHz)	5300
Polarization	Vertical		

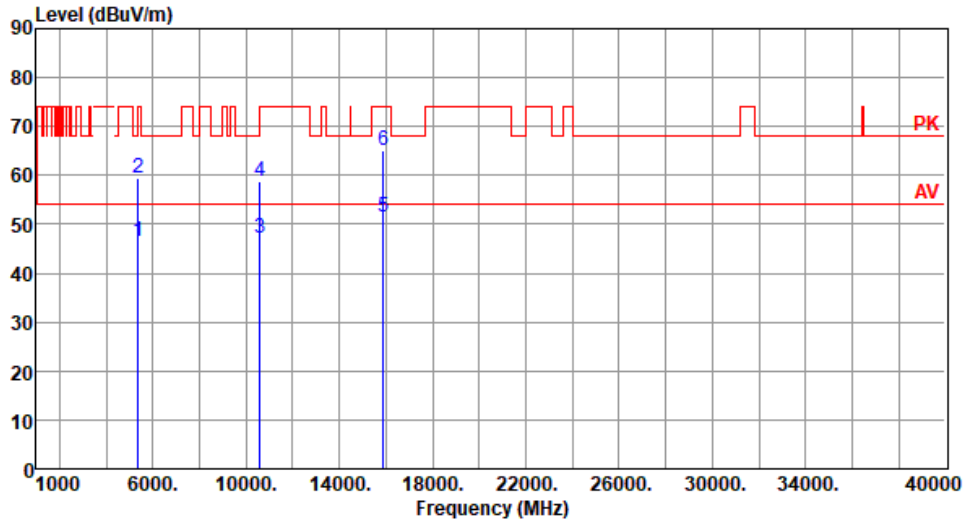

	Freq. MHz	Emission level dBuV/m	Limit dBuV/m	Margin dB	SA reading dBuV	Factor dB	Remark	ANT High cm	Turn Table deg
1	5350.00	46.43	54.00	-7.57	39.58	6.85	Average	105	40
2	5350.00	59.40	74.00	-14.60	52.55	6.85	Peak	105	40
3	10600.00	47.01	54.00	-6.99	30.65	16.36	Average	100	50
4	10600.00	58.71	74.00	-15.29	42.35	16.36	Peak	100	50
5	15900.00	51.55	54.00	-2.45	34.86	16.69	Average	117	335
6	15900.00	64.98	74.00	-9.02	48.29	16.69	Peak	117	335

Note 1: Emission Level (dBuV/m) = SA Reading (dBuV/m) + Factor* (dB)

*Factor includes antenna factor , cable loss and amplifier gain

Note 2: Margin (dB) = Emission level (dBuV/m) – Limit (dBuV/m).

Modulation	HT20	Test Freq. (MHz)	5320
Polarization	Horizontal		

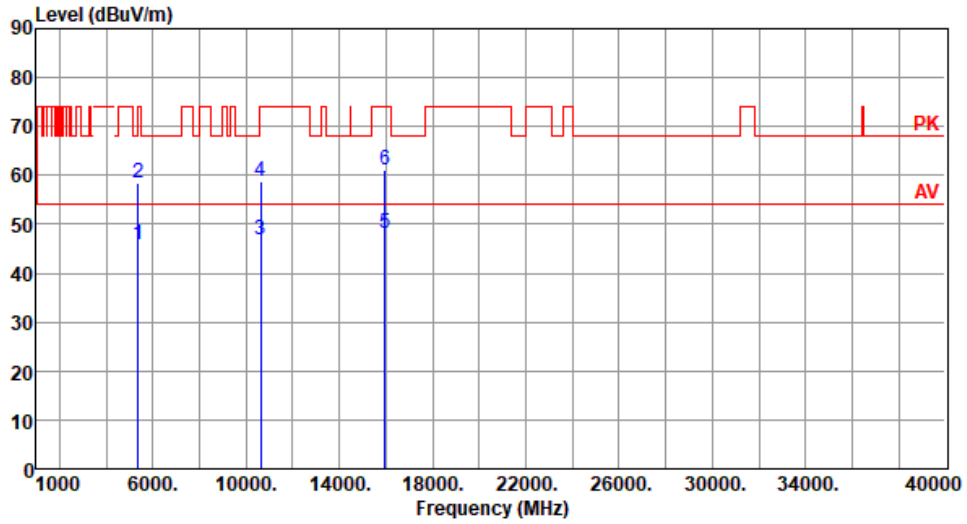

	Freq. MHz	Emission level dBUV/m	Limit dBUV/m	Margin dB	SA reading dBUV	Factor dB	Remark	ANT High cm	Turn Table deg
1	5350.00	45.97	54.00	-8.03	39.12	6.85	Average	100	127
2	5350.00	58.44	74.00	-15.56	51.59	6.85	Peak	100	127
3	10640.00	46.93	54.00	-7.07	30.56	16.37	Average	100	30
4	10640.00	58.62	74.00	-15.38	42.25	16.37	Peak	100	30
5	15960.00	48.05	54.00	-5.95	31.52	16.53	Average	155	356
6	15960.00	61.12	74.00	-12.88	44.59	16.53	Peak	155	356

Note 1: Emission Level (dBUV/m) = SA Reading (dBUV/m) + Factor* (dB)

*Factor includes antenna factor , cable loss and amplifier gain

Note 2: Margin (dB) = Emission level (dBUV/m) – Limit (dBUV/m).

Modulation	HT20	Test Freq. (MHz)	5320
Polarization	Vertical		

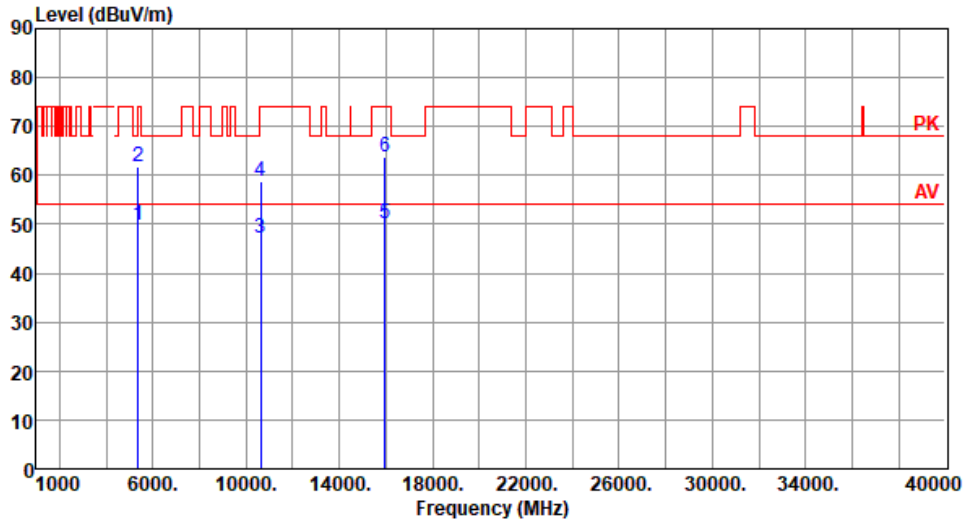

	Freq. MHz	Emission level dBuV/m	Limit dBuV/m	Margin dB	SA reading dBuV	Factor dB	Remark	ANT High cm	Turn Table deg
1	5350.00	49.96	54.00	-4.04	43.11	6.85	Average	108	23
2	5350.00	61.63	74.00	-12.37	54.78	6.85	Peak	108	23
3	10640.00	47.02	54.00	-6.98	30.65	16.37	Average	100	40
4	10640.00	58.70	74.00	-15.30	42.33	16.37	Peak	100	40
5	15960.00	50.09	54.00	-3.91	33.56	16.53	Average	117	332
6	15960.00	63.78	74.00	-10.22	47.25	16.53	Peak	117	332

Note 1: Emission Level (dBuV/m) = SA Reading (dBuV/m) + Factor* (dB)

*Factor includes antenna factor , cable loss and amplifier gain

Note 2: Margin (dB) = Emission level (dBuV/m) – Limit (dBuV/m).

Modulation	HT20	Test Freq. (MHz)	5500
Polarization	Horizontal		

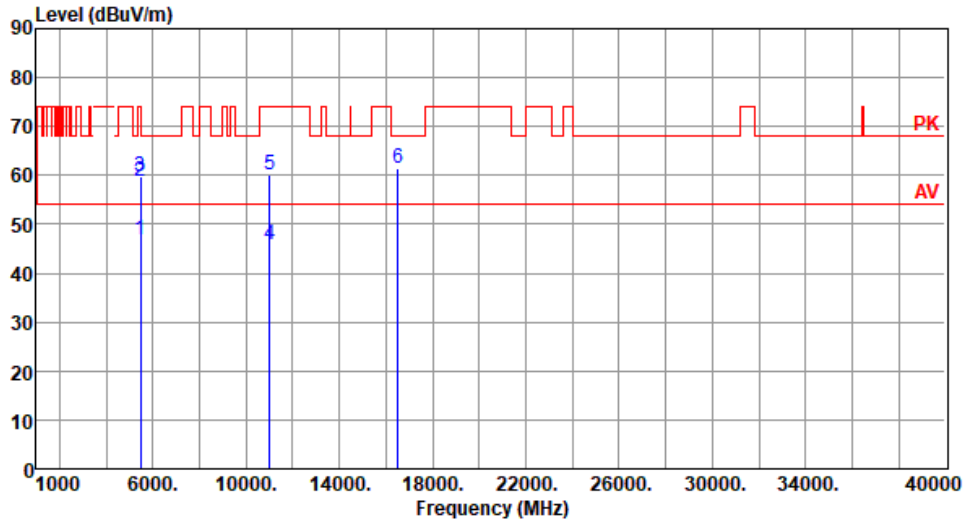

	Freq. MHz	Emission level dBuV/m	Limit dBuV/m	Margin dB	SA reading dBuV	Factor dB	Remark	ANT High cm	Turn Table deg
1	5460.00	46.73	54.00	-7.27	39.48	7.25	Average	100	124
2	5460.00	58.84	74.00	-15.16	51.59	7.25	Peak	100	124
3	5470.00	59.73	68.20	-8.47	52.45	7.28	Peak	100	124
4	11000.00	45.97	54.00	-8.03	29.13	16.84	Average	100	50
5	11000.00	60.10	74.00	-13.90	43.26	16.84	Peak	100	50
6	16500.00	61.32	68.20	-6.88	43.68	17.64	Peak	213	5

Note 1: Emission Level (dBuV/m) = SA Reading (dBuV/m) + Factor* (dB)

*Factor includes antenna factor , cable loss and amplifier gain

Note 2: Margin (dB) = Emission level (dBuV/m) – Limit (dBuV/m).

Modulation	HT20	Test Freq. (MHz)	5500
Polarization	Vertical		

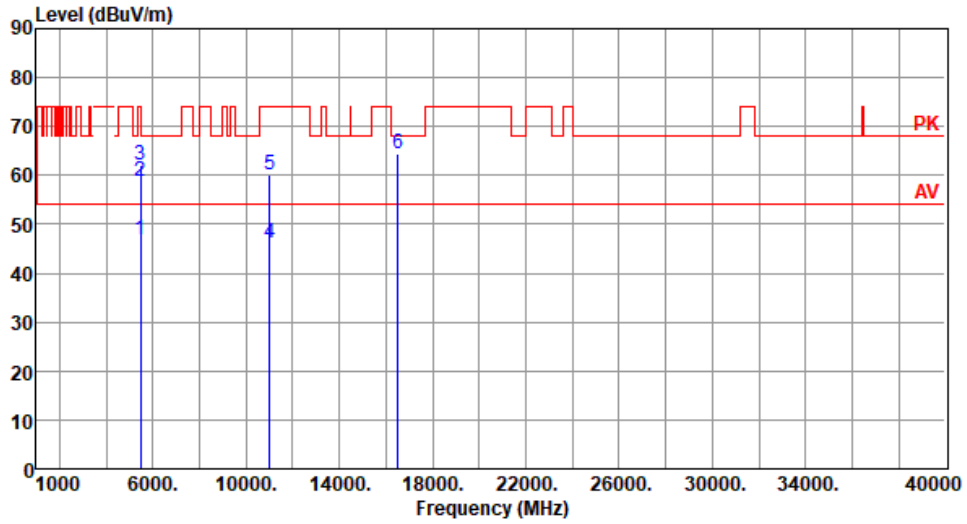

	Freq. MHz	Emission level dBuV/m	Limit dBuV/m	Margin dB	SA reading dBuV	Factor dB	Remark	ANT High cm	Turn Table deg
1	5460.00	46.70	54.00	-7.30	39.45	7.25	Average	115	39
2	5460.00	58.90	74.00	-15.10	51.65	7.25	Peak	115	39
3	5470.00	62.24	68.20	-5.96	54.96	7.28	Peak	115	39
4	11000.00	46.09	54.00	-7.91	29.25	16.84	Average	100	60
5	11000.00	59.99	74.00	-14.01	43.15	16.84	Peak	100	60
6	16500.00	64.52	68.20	-3.68	46.88	17.64	Peak	231	307

Note 1: Emission Level (dBuV/m) = SA Reading (dBuV/m) + Factor* (dB)

*Factor includes antenna factor , cable loss and amplifier gain

Note 2: Margin (dB) = Emission level (dBuV/m) – Limit (dBuV/m).

Modulation	HT20	Test Freq. (MHz)	5580
Polarization	Horizontal		

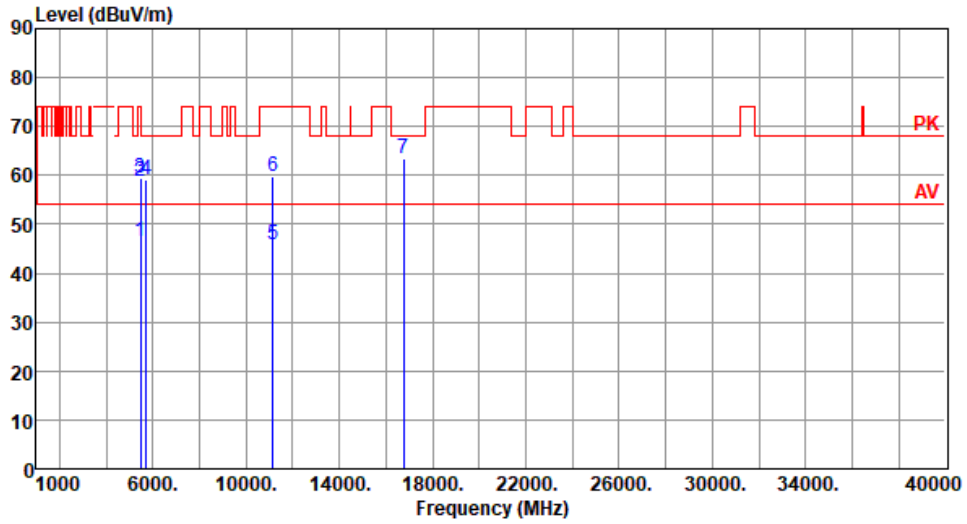

	Freq. MHz	Emission level dBuV/m	Limit dBuV/m	Margin dB	SA reading dBuV	Factor dB	Remark	ANT High cm	Turn Table deg
1	5460.00	46.50	54.00	-7.50	39.25	7.25	Average	100	127
2	5460.00	58.81	74.00	-15.19	51.56	7.25	Peak	100	127
3	5470.00	59.57	68.20	-8.63	52.29	7.28	Peak	100	127
4	5725.00	59.11	68.20	-9.09	51.45	7.66	Peak	100	127
5	11160.00	45.80	54.00	-8.20	29.21	16.59	Average	100	50
6	11160.00	59.74	74.00	-14.26	43.15	16.59	Peak	100	50
7	16740.00	63.47	68.20	-4.73	45.24	18.23	Peak	216	2

Note 1: Emission Level (dBuV/m) = SA Reading (dBuV/m) + Factor* (dB)

*Factor includes antenna factor , cable loss and amplifier gain

Note 2: Margin (dB) = Emission level (dBuV/m) – Limit (dBuV/m).

Modulation	HT20	Test Freq. (MHz)	5580
Polarization	Vertical		

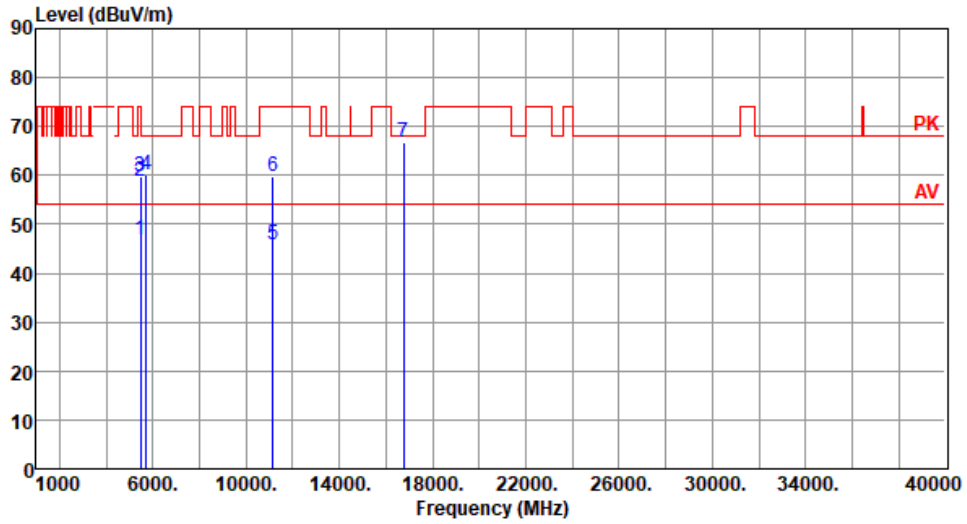

	Freq. MHz	Emission level dBuV/m	Limit dBuV/m	Margin dB	SA reading dBuV	Factor dB	Remark	ANT High cm	Turn Table deg
1	5460.00	46.90	54.00	-7.10	39.65	7.25	Average	109	10
2	5460.00	58.64	74.00	-15.36	51.39	7.25	Peak	109	10
3	5470.00	59.89	68.20	-8.31	52.61	7.28	Peak	109	10
4	5725.00	60.06	68.20	-8.14	52.40	7.66	Peak	109	10
5	11160.00	45.90	54.00	-8.10	29.31	16.59	Average	100	20
6	11160.00	59.80	74.00	-14.20	43.21	16.59	Peak	100	20
7	16740.00	66.65	68.20	-1.55	48.42	18.23	Peak	233	309

Note 1: Emission Level (dBuV/m) = SA Reading (dBuV/m) + Factor* (dB)

*Factor includes antenna factor , cable loss and amplifier gain

Note 2: Margin (dB) = Emission level (dBuV/m) – Limit (dBuV/m).

Modulation	HT20	Test Freq. (MHz)	5700
Polarization	Horizontal		

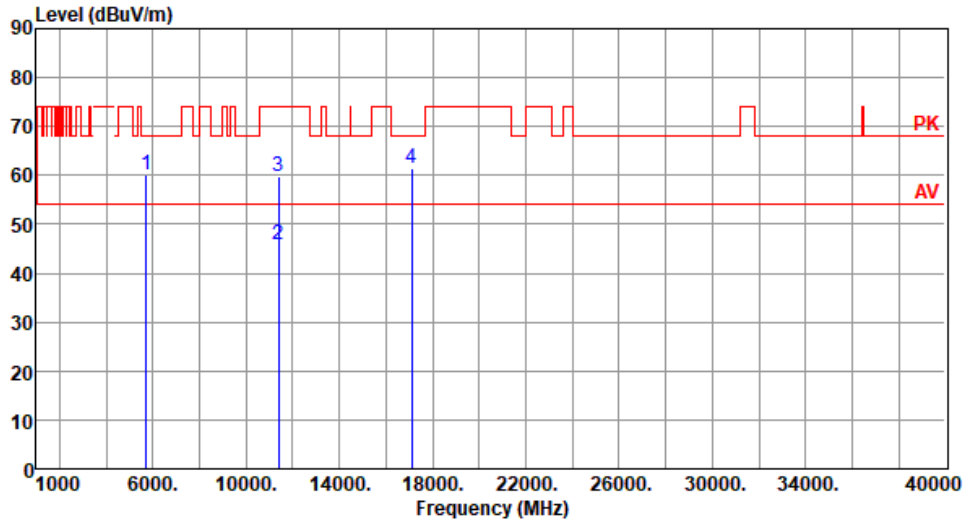

	Freq. MHz	Emission level dBuV/m	Limit dBuV/m	Margin dB	SA reading dBuV	Factor dB	Remark	ANT High cm	Turn Table deg
1	5725.00	60.10	68.20	-8.10	52.44	7.66	Peak	100	126
2	11400.00	45.85	54.00	-8.15	29.12	16.73	Average	100	50
3	11400.00	59.87	74.00	-14.13	43.14	16.73	Peak	100	50
4	17100.00	61.45	68.20	-6.75	43.21	18.24	Peak	213	3

Note 1: Emission Level (dBuV/m) = SA Reading (dBuV/m) + Factor* (dB)

*Factor includes antenna factor , cable loss and amplifier gain

Note 2: Margin (dB) = Emission level (dBuV/m) – Limit (dBuV/m).

Modulation	HT20	Test Freq. (MHz)	5700
Polarization	Vertical		

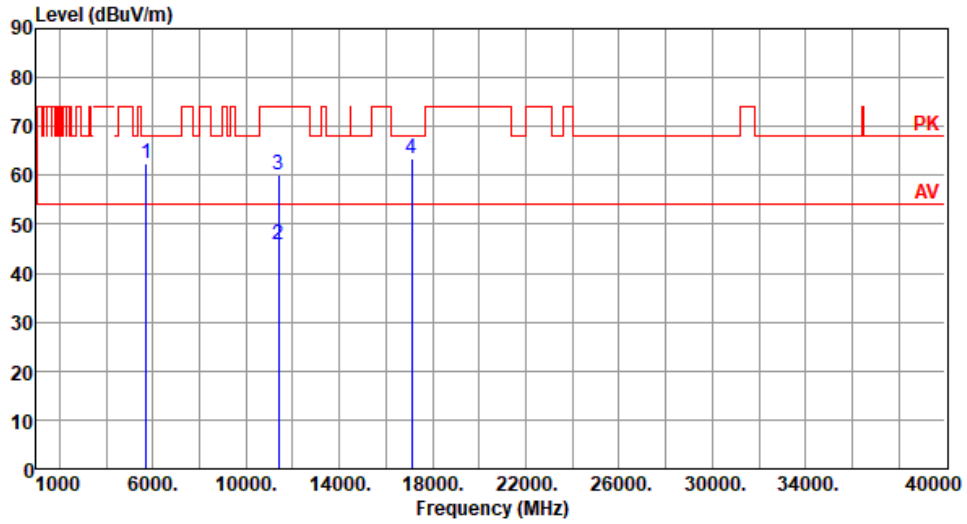

	Freq. MHz	Emission level dBuV/m	Limit dBuV/m	Margin dB	SA reading dBuV	Factor dB	Remark	ANT High cm	Turn Table deg
1	5725.00	62.34	68.20	-5.86	54.68	7.66	Peak	105	40
2	11400.00	45.97	54.00	-8.03	29.24	16.73	Average	100	30
3	11400.00	60.26	74.00	-13.74	43.53	16.73	Peak	100	30
4	17100.00	63.55	68.20	-4.65	45.31	18.24	Peak	234	302

Note 1: Emission Level (dBuV/m) = SA Reading (dBuV/m) + Factor* (dB)

*Factor includes antenna factor , cable loss and amplifier gain

Note 2: Margin (dB) = Emission level (dBuV/m) – Limit (dBuV/m).

Modulation	HT20	Test Freq. (MHz)	5720
Polarization	Horizontal		

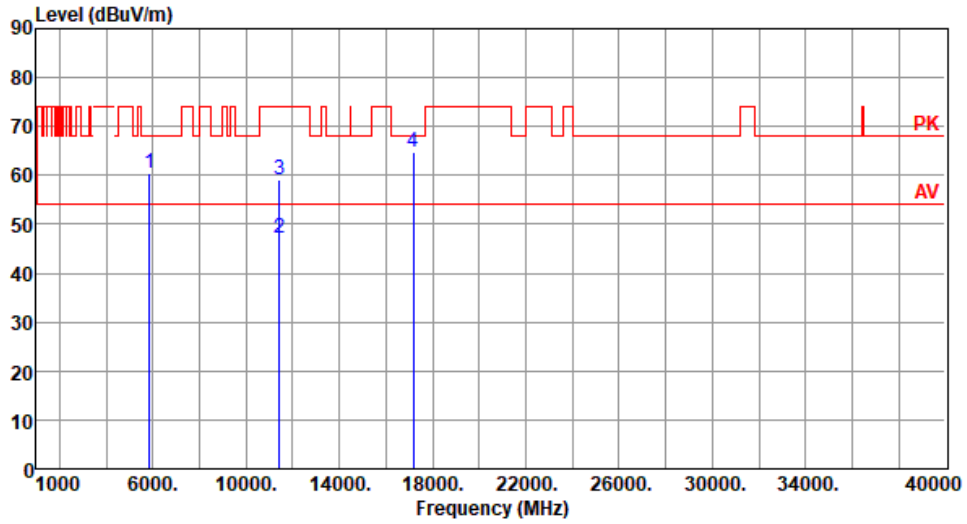

	Freq. MHz	Emission level dBuV/m	Limit dBuV/m	Margin dB	SA reading dBuV	Factor dB	Remark	ANT High cm	Turn Table deg
1	5850.00	60.39	68.20	-7.81	52.37	8.02	Peak	100	131
2	11440.00	47.14	54.00	-6.86	30.40	16.74	Average	100	36
3	11440.00	59.04	74.00	-14.96	42.30	16.74	Peak	100	36
4	17160.00	64.91	68.20	-3.29	46.53	18.38	Peak	135	28

Note 1: Emission Level (dBuV/m) = SA Reading (dBuV/m) + Factor* (dB)

*Factor includes antenna factor , cable loss and amplifier gain

Note 2: Margin (dB) = Emission level (dBuV/m) – Limit (dBuV/m).

Modulation	HT20	Test Freq. (MHz)	5720
Polarization	Vertical		

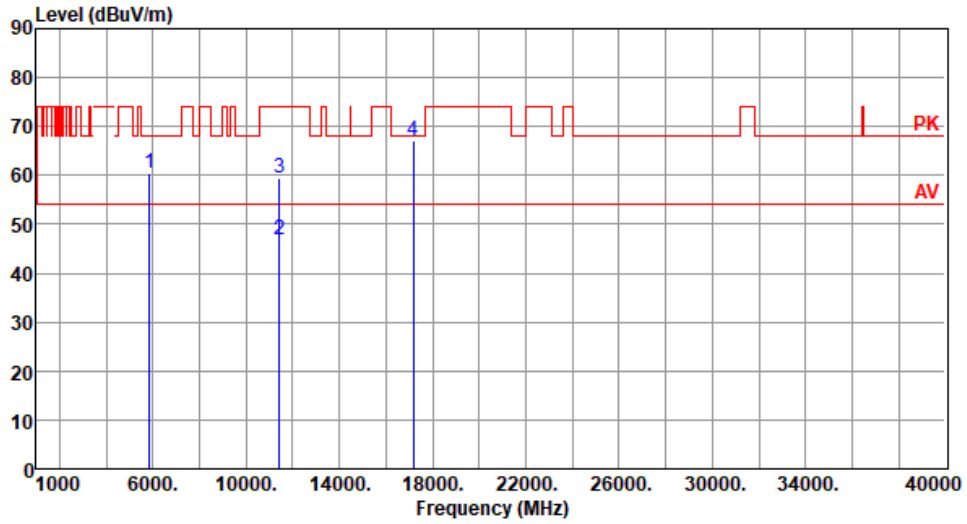

	Freq. MHz	Emission level dBuV/m	Limit dBuV/m	Margin dB	SA reading dBuV	Factor dB	Remark	ANT High cm	Turn Table deg
1	5850.00	60.48	68.20	-7.72	52.46	8.02	Peak	143	145
2	11440.00	46.99	54.00	-7.01	30.25	16.74	Average	100	52
3	11440.00	59.41	74.00	-14.59	42.67	16.74	Peak	100	52
4	17160.00	67.18	68.20	-1.02	48.80	18.38	Peak	233	325

Note 1: Emission Level (dBuV/m) = SA Reading (dBuV/m) + Factor* (dB)

*Factor includes antenna factor , cable loss and amplifier gain

Note 2: Margin (dB) = Emission level (dBuV/m) – Limit (dBuV/m).

Modulation	HT20	Test Freq. (MHz)	5785
Polarization	Horizontal		

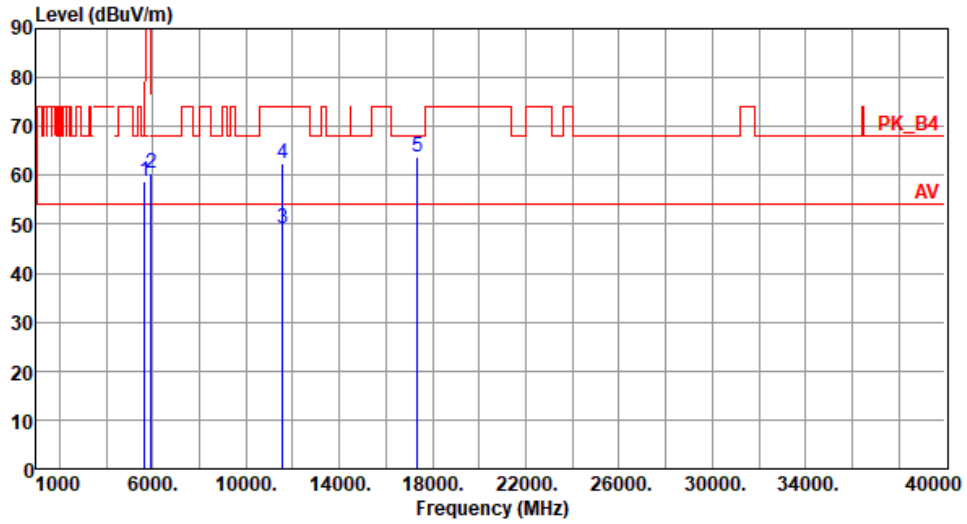

	Freq. MHz	Emission level dBuV/m	Limit dBuV/m	Margin dB	SA reading dBuV	Factor dB	Remark	ANT High cm	Turn Table deg
1	5650.00	58.67	68.20	-9.53	51.28	7.39	Peak	100	126
2	5925.00	60.35	68.20	-7.85	52.28	8.07	Peak	100	126
3	11570.00	49.01	54.00	-4.99	32.40	16.61	Average	220	285
4	11570.00	62.29	74.00	-11.71	45.68	16.61	Peak	220	285
5	17355.00	63.68	68.20	-4.52	44.45	19.23	Peak	100	295

Note 1: Emission Level (dBuV/m) = SA Reading (dBuV/m) + Factor* (dB)

*Factor includes antenna factor , cable loss and amplifier gain

Note 2: Margin (dB) = Emission level (dBuV/m) – Limit (dBuV/m).

Modulation	HT20	Test Freq. (MHz)	5785
Polarization	Vertical		

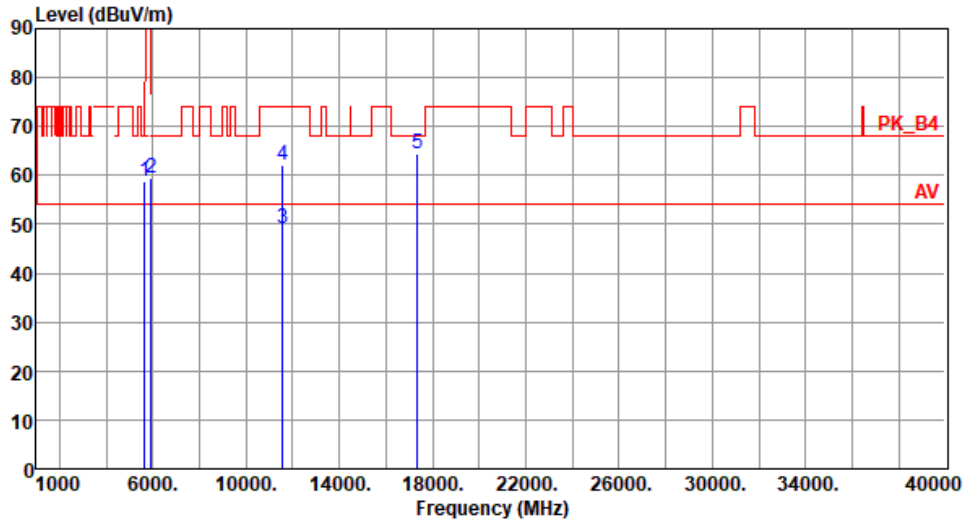

	Freq. MHz	Emission level dBuV/m	Limit dBuV/m	Margin dB	SA reading dBuV	Factor dB	Remark	ANT High cm	Turn Table deg
1	5650.00	58.65	68.20	-9.55	51.26	7.39	Peak	166	34
2	5925.00	59.47	68.20	-8.73	51.40	8.07	Peak	166	34
3	11570.00	49.22	54.00	-4.78	32.61	16.61	Average	119	311
4	11570.00	62.23	74.00	-11.77	45.62	16.61	Peak	119	311
5	17355.00	64.43	68.20	-3.77	45.20	19.23	Peak	105	299

Note 1: Emission Level (dBuV/m) = SA Reading (dBuV/m) + Factor* (dB)

*Factor includes antenna factor , cable loss and amplifier gain

Note 2: Margin (dB) = Emission level (dBuV/m) – Limit (dBuV/m).

Modulation	HT20	Test Freq. (MHz)	5825
Polarization	Horizontal		

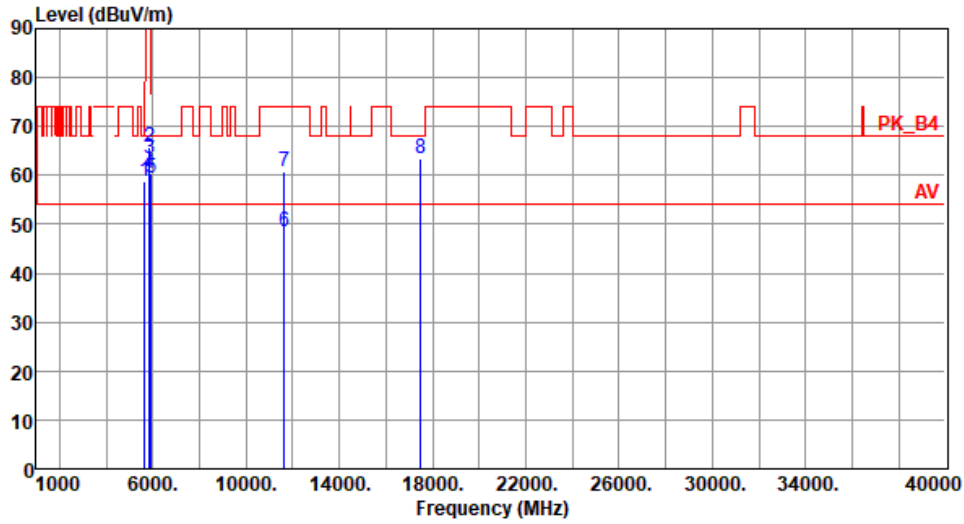

	Freq. MHz	Emission level dBuV/m	Limit dBuV/m	Margin dB	SA reading dBuV	Factor dB	Remark	ANT High cm	Turn Table deg
1	5650.00	58.70	68.20	-9.50	51.31	7.39	Peak	100	125
2	5850.00	65.61	122.20	-56.59	57.59	8.02	Peak	100	125
3	5855.00	63.33	110.80	-47.47	55.31	8.02	Peak	100	125
4	5875.00	60.36	105.20	-44.84	52.33	8.03	Peak	100	125
5	5925.00	59.34	68.20	-8.86	51.27	8.07	Peak	100	125
6	11650.00	48.53	54.00	-5.47	32.15	16.38	Average	226	279
7	11650.00	60.64	74.00	-13.36	44.26	16.38	Peak	226	279
8	17475.00	63.29	68.20	-4.91	43.55	19.74	Peak	100	293

Note 1: Emission Level (dBuV/m) = SA Reading (dBuV/m) + Factor* (dB)

*Factor includes antenna factor , cable loss and amplifier gain

Note 2: Margin (dB) = Emission level (dBuV/m) – Limit (dBuV/m).

Modulation	HT20	Test Freq. (MHz)	5825
Polarization	Vertical		

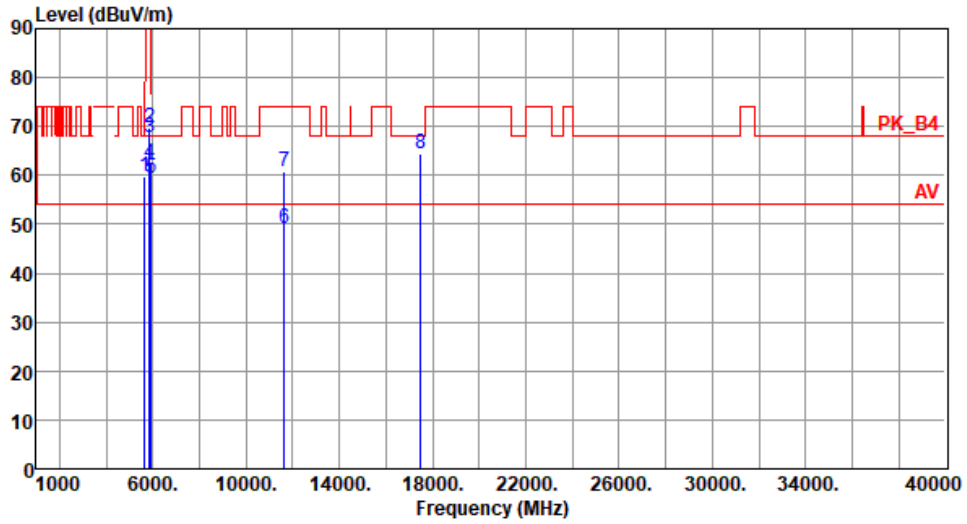

	Freq. MHz	Emission level dBuV/m	Limit dBuV/m	Margin dB	SA reading dBuV	Factor dB	Remark	ANT High cm	Turn Table deg
1	5650.00	59.85	68.20	-8.35	52.46	7.39	Peak	177	41
2	5850.00	69.88	122.20	-52.32	61.86	8.02	Peak	177	41
3	5855.00	67.88	110.80	-42.92	59.86	8.02	Peak	177	41
4	5875.00	62.28	105.20	-42.92	54.25	8.03	Peak	177	41
5	5925.00	59.44	68.20	-8.76	51.37	8.07	Peak	177	41
6	11650.00	49.06	54.00	-4.94	32.68	16.38	Average	114	318
7	11650.00	60.69	74.00	-13.31	44.31	16.38	Peak	114	318
8	17475.00	64.42	68.20	-3.78	44.68	19.74	Peak	100	295

Note 1: Emission Level (dBuV/m) = SA Reading (dBuV/m) + Factor* (dB)

*Factor includes antenna factor , cable loss and amplifier gain

Note 2: Margin (dB) = Emission level (dBuV/m) – Limit (dBuV/m).

3.5.7 Transmitter Radiated Unwanted Emissions (Above 1GHz) for HT40

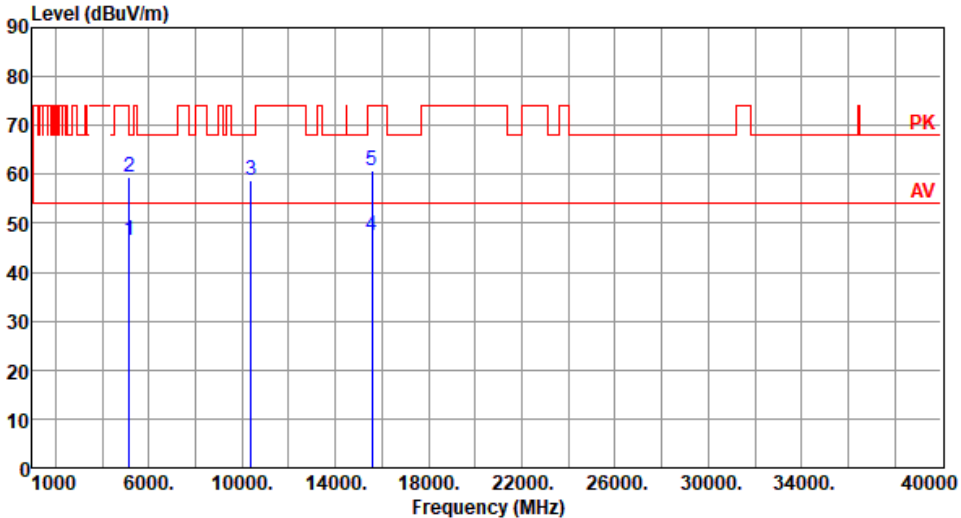
Modulation	HT40	Test Freq. (MHz)	5190						
Polarization	Horizontal								
									
	Freq. MHz	Emission level dBuV/m	Limit dBuV/m	Margin dB	SA reading dBuV	Factor dB	Remark	ANT High cm	Turn Table deg
1	5150.00	46.51	54.00	-7.49	39.19	7.32	Average	100	122
2	5150.00	59.47	74.00	-14.53	52.15	7.32	Peak	100	122
3	10380.00	58.80	68.20	-9.40	42.62	16.18	Peak	100	50
4	15570.00	47.45	54.00	-6.55	30.13	17.32	Average	100	30
5	15570.00	60.78	74.00	-13.22	43.46	17.32	Peak	100	30

Note 1: Emission Level (dBuV/m) = SA Reading (dBuV/m) + Factor* (dB)
*Factor includes antenna factor , cable loss and amplifier gain
Note 2: Margin (dB) = Emission level (dBuV/m) – Limit (dBuV/m).

Modulation	HT40	Test Freq. (MHz)	5190
Polarization	Vertical		

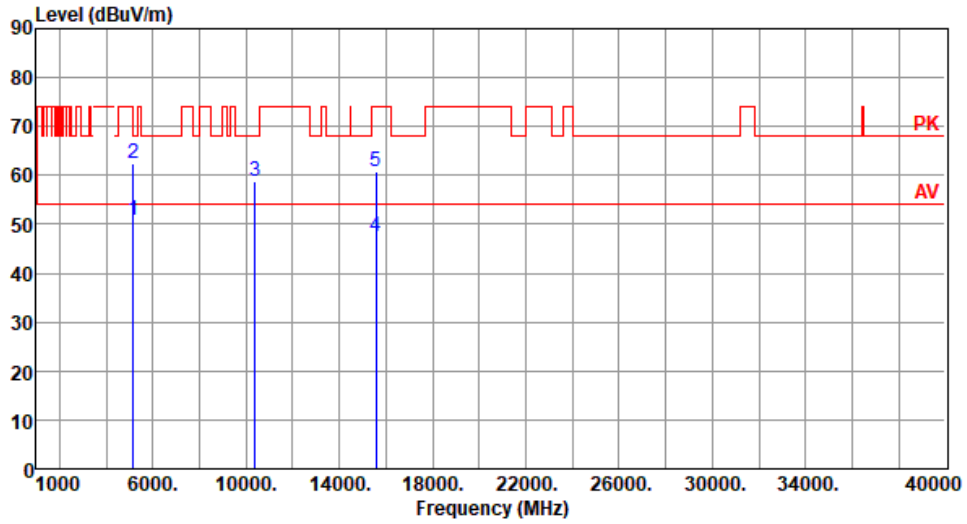

	Freq. MHz	Emission level dBuV/m	Limit dBuV/m	Margin dB	SA reading dBuV	Factor dB	Remark	ANT High cm	Turn Table deg
1	5150.00	50.72	54.00	-3.28	43.40	7.32	Average	106	15
2	5150.00	62.47	74.00	-11.53	55.15	7.32	Peak	106	15
3	10380.00	58.75	68.20	-9.45	42.57	16.18	Peak	100	20
4	15570.00	47.58	54.00	-6.42	30.26	17.32	Average	100	40
5	15570.00	60.91	74.00	-13.09	43.59	17.32	Peak	100	40

Note 1: Emission Level (dBuV/m) = SA Reading (dBuV/m) + Factor* (dB)

*Factor includes antenna factor , cable loss and amplifier gain

Note 2: Margin (dB) = Emission level (dBuV/m) – Limit (dBuV/m).

Modulation	HT40	Test Freq. (MHz)	5310
Polarization	Horizontal		

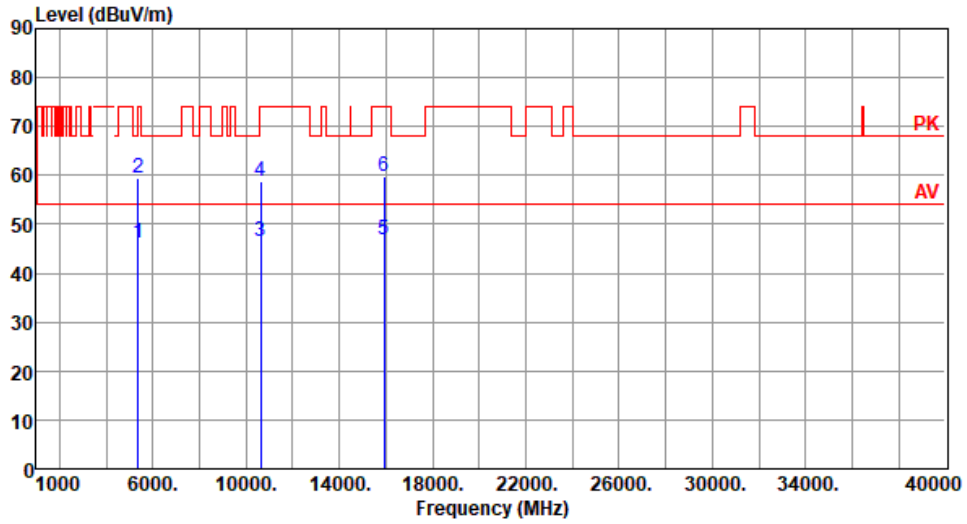

	Freq. MHz	Emission level dBuV/m	Limit dBuV/m	Margin dB	SA reading dBuV	Factor dB	Remark	ANT High cm	Turn Table deg
1	5350.00	46.30	54.00	-7.70	39.45	6.85	Average	100	120
2	5350.00	59.41	74.00	-14.59	52.56	6.85	Peak	100	120
3	10620.00	46.65	54.00	-7.35	30.28	16.37	Average	100	30
4	10620.00	58.69	74.00	-15.31	42.32	16.37	Peak	100	30
5	15930.00	46.96	54.00	-7.04	30.35	16.61	Average	100	20
6	15930.00	59.84	74.00	-14.16	43.23	16.61	Peak	100	20

Note 1: Emission Level (dBuV/m) = SA Reading (dBuV/m) + Factor* (dB)

*Factor includes antenna factor , cable loss and amplifier gain

Note 2: Margin (dB) = Emission level (dBuV/m) – Limit (dBuV/m).

Modulation	HT40	Test Freq. (MHz)	5310
Polarization	Vertical		

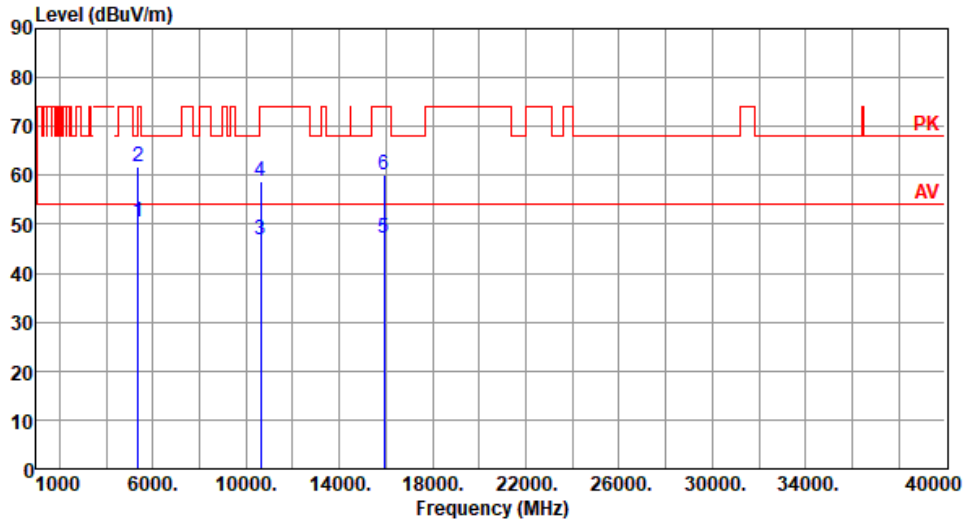

	Freq. MHz	Emission level dBuV/m	Limit dBuV/m	Margin dB	SA reading dBuV	Factor dB	Remark	ANT High cm	Turn Table deg
1	5350.00	50.41	54.00	-3.59	43.56	6.85	Average	102	22
2	5350.00	61.67	74.00	-12.33	54.82	6.85	Peak	102	22
3	10620.00	46.78	54.00	-7.22	30.41	16.37	Average	100	40
4	10620.00	58.82	74.00	-15.18	42.45	16.37	Peak	100	40
5	15930.00	47.09	54.00	-6.91	30.48	16.61	Average	100	50
6	15930.00	60.06	74.00	-13.94	43.45	16.61	Peak	100	50

Note 1: Emission Level (dBuV/m) = SA Reading (dBuV/m) + Factor* (dB)

*Factor includes antenna factor , cable loss and amplifier gain

Note 2: Margin (dB) = Emission level (dBuV/m) – Limit (dBuV/m).

Modulation	HT40	Test Freq. (MHz)	5510
Polarization	Horizontal		

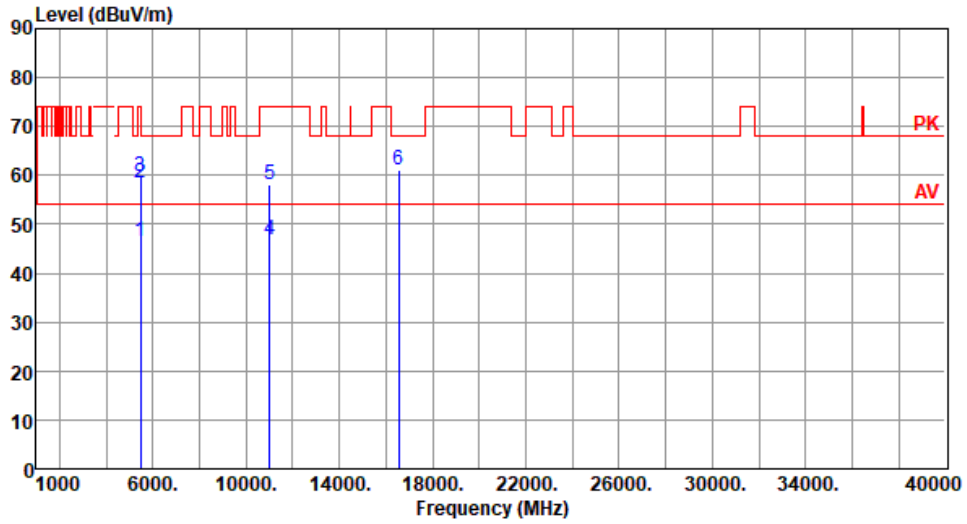

	Freq. MHz	Emission level dBuV/m	Limit dBuV/m	Margin dB	SA reading dBuV	Factor dB	Remark	ANT High cm	Turn Table deg
1	5460.00	46.50	54.00	-7.50	39.25	7.25	Average	100	128
2	5460.00	58.51	74.00	-15.49	51.26	7.25	Peak	100	128
3	5470.00	59.74	68.20	-8.46	52.46	7.28	Peak	100	128
4	11020.00	46.94	54.00	-7.06	30.13	16.81	Average	100	25
5	11020.00	58.27	74.00	-15.73	41.46	16.81	Peak	100	25
6	16530.00	61.08	68.20	-7.12	43.25	17.83	Peak	100	90

Note 1: Emission Level (dBuV/m) = SA Reading (dBuV/m) + Factor* (dB)

*Factor includes antenna factor , cable loss and amplifier gain

Note 2: Margin (dB) = Emission level (dBuV/m) – Limit (dBuV/m).

Modulation	HT40	Test Freq. (MHz)	5510
Polarization	Vertical		

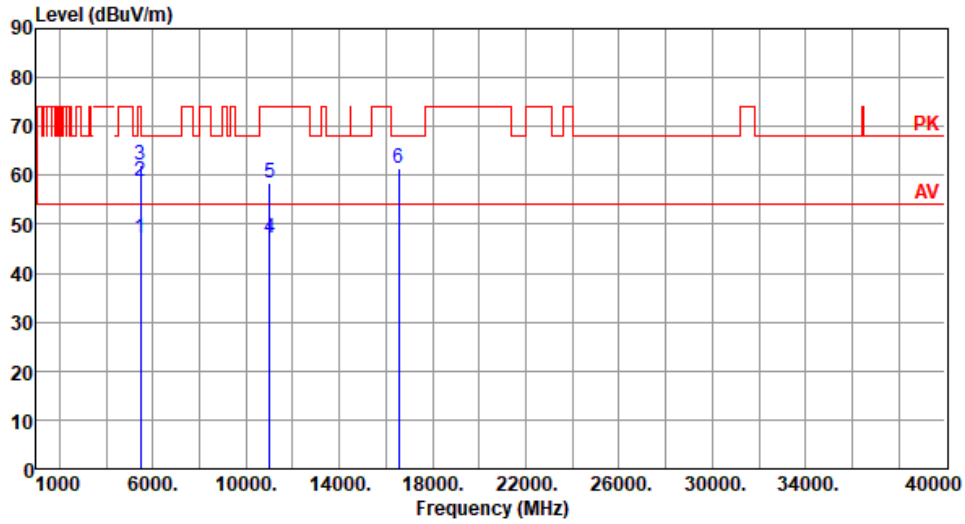

	Freq. MHz	Emission level dBuV/m	Limit dBuV/m	Margin dB	SA reading dBuV	Factor dB	Remark	ANT High cm	Turn Table deg
1	5460.00	47.31	54.00	-6.69	40.06	7.25	Average	126	42
2	5460.00	58.68	74.00	-15.32	51.43	7.25	Peak	126	42
3	5470.00	62.18	68.20	-6.02	54.90	7.28	Peak	126	42
4	11020.00	47.06	54.00	-6.94	30.25	16.81	Average	100	30
5	11020.00	58.40	74.00	-15.60	41.59	16.81	Peak	100	30
6	16530.00	61.29	68.20	-6.91	43.46	17.83	Peak	100	20

Note 1: Emission Level (dBuV/m) = SA Reading (dBuV/m) + Factor* (dB)

*Factor includes antenna factor , cable loss and amplifier gain

Note 2: Margin (dB) = Emission level (dBuV/m) – Limit (dBuV/m).

Modulation	HT40	Test Freq. (MHz)	5670
Polarization	Horizontal		

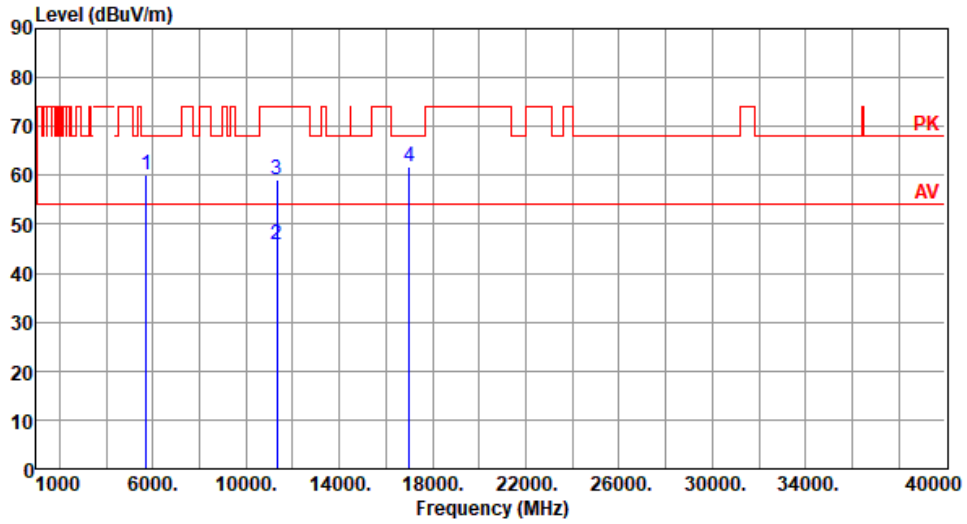

	Freq. MHz	Emission level dBuV/m	Limit dBuV/m	Margin dB	SA reading dBuV	Factor dB	Remark	ANT High cm	Turn Table deg
1	5725.00	60.21	68.20	-7.99	52.55	7.66	Peak	100	130
2	11340.00	45.71	54.00	-8.29	29.13	16.58	Average	100	40
3	11340.00	59.04	74.00	-14.96	42.46	16.58	Peak	100	40
4	17010.00	61.78	68.20	-6.42	43.12	18.66	Peak	100	60

Note 1: Emission Level (dBuV/m) = SA Reading (dBuV/m) + Factor* (dB)

*Factor includes antenna factor , cable loss and amplifier gain

Note 2: Margin (dB) = Emission level (dBuV/m) – Limit (dBuV/m).

Modulation	HT40	Test Freq. (MHz)	5670
Polarization	Vertical		

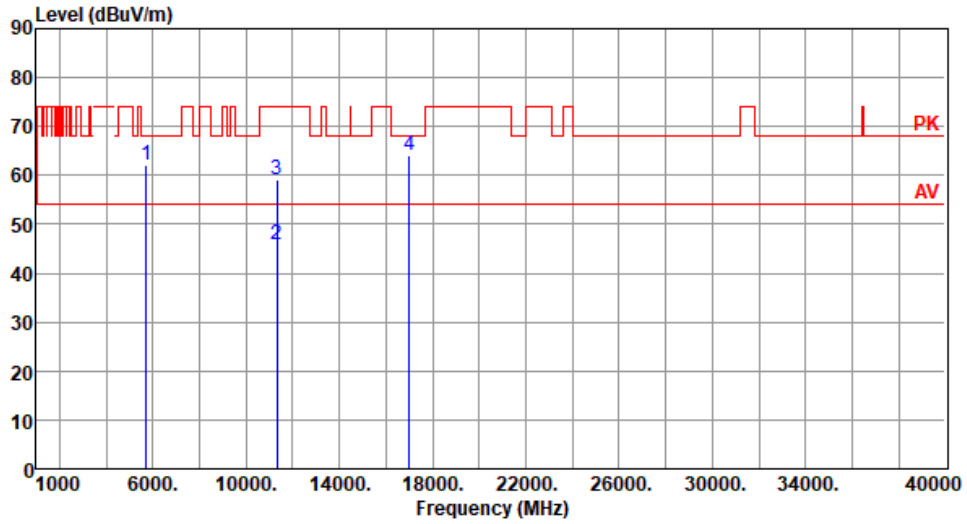

	Freq. MHz	Emission level dBuV/m	Limit dBuV/m	Margin dB	SA reading dBuV	Factor dB	Remark	ANT High cm	Turn Table deg
1	5725.00	62.22	68.20	-5.98	54.56	7.66	Peak	109	49
2	11340.00	45.83	54.00	-8.17	29.25	16.58	Average	100	30
3	11340.00	59.14	74.00	-14.86	42.56	16.58	Peak	100	30
4	17010.00	64.02	68.20	-4.18	45.36	18.66	Peak	229	301

Note 1: Emission Level (dBuV/m) = SA Reading (dBuV/m) + Factor* (dB)

*Factor includes antenna factor , cable loss and amplifier gain

Note 2: Margin (dB) = Emission level (dBuV/m) – Limit (dBuV/m).

Modulation	HT40	Test Freq. (MHz)	5710
Polarization	Horizontal		

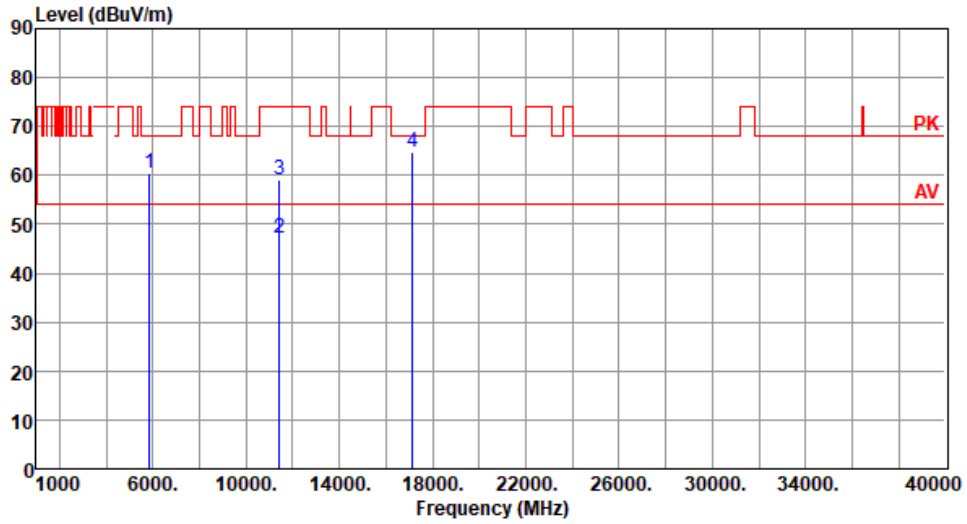

	Freq. MHz	Emission level dBuV/m	Limit dBuV/m	Margin dB	SA reading dBuV	Factor dB	Remark	ANT High cm	Turn Table deg
1	5850.00	60.46	68.20	-7.74	52.44	8.02	Peak	100	132
2	11420.00	47.12	54.00	-6.88	30.39	16.73	Average	100	31
3	11420.00	58.96	74.00	-15.04	42.23	16.73	Peak	100	31
4	17130.00	64.86	68.20	-3.34	46.56	18.30	Peak	135	26

Note 1: Emission Level (dBuV/m) = SA Reading (dBuV/m) + Factor* (dB)

*Factor includes antenna factor , cable loss and amplifier gain

Note 2: Margin (dB) = Emission level (dBuV/m) – Limit (dBuV/m).

Modulation	HT40	Test Freq. (MHz)	5710
Polarization	Vertical		

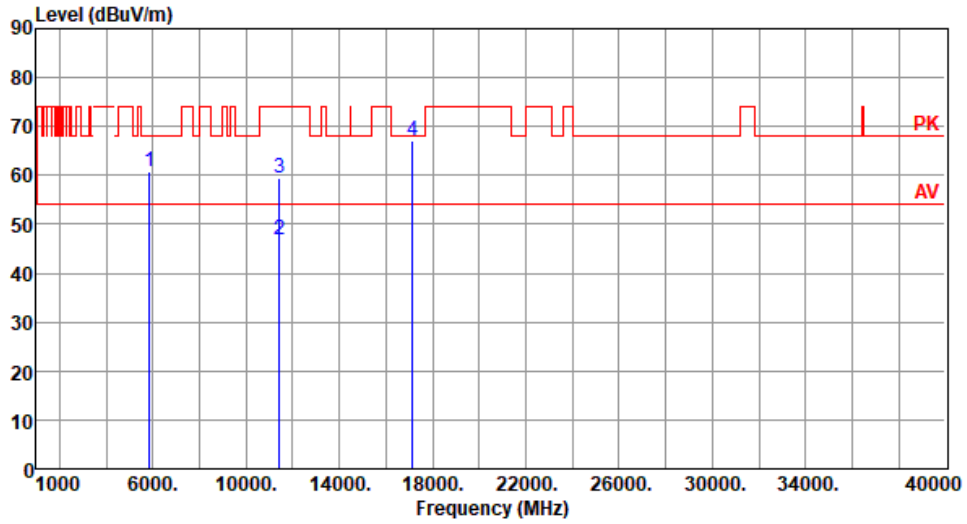

	Freq. MHz	Emission level dBuV/m	Limit dBuV/m	Margin dB	SA reading dBuV	Factor dB	Remark	ANT High cm	Turn Table deg
1	5850.00	60.65	68.20	-7.55	52.63	8.02	Peak	144	146
2	11420.00	46.94	54.00	-7.06	30.21	16.73	Average	100	55
3	11420.00	59.38	74.00	-14.62	42.65	16.73	Peak	100	55
4	17130.00	67.14	68.20	-1.06	48.84	18.30	Peak	228	324

Note 1: Emission Level (dBuV/m) = SA Reading (dBuV/m) + Factor* (dB)

*Factor includes antenna factor , cable loss and amplifier gain

Note 2: Margin (dB) = Emission level (dBuV/m) – Limit (dBuV/m).

Modulation	HT40	Test Freq. (MHz)	5795
Polarization	Horizontal		

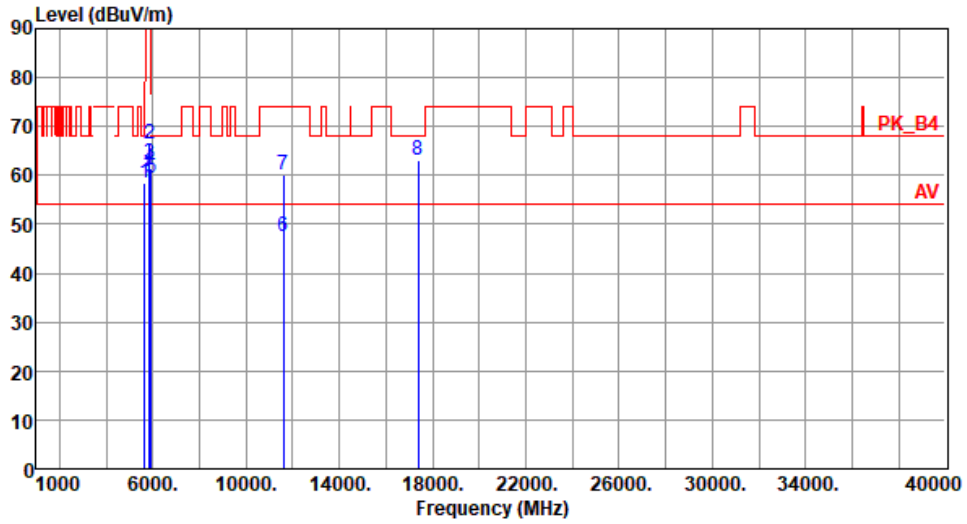

	Freq. MHz	Emission level dBuV/m	Limit dBuV/m	Margin dB	SA reading dBuV	Factor dB	Remark	ANT High cm	Turn Table deg
1	5650.00	58.44	68.20	-9.76	51.05	7.39	Peak	100	123
2	5850.00	66.48	122.20	-55.72	58.46	8.02	Peak	100	123
3	5855.00	62.28	110.80	-48.52	54.26	8.02	Peak	100	123
4	5875.00	61.47	105.20	-43.73	53.44	8.03	Peak	100	123
5	5925.00	59.34	68.20	-8.86	51.27	8.07	Peak	100	123
6	11590.00	47.58	54.00	-6.42	31.01	16.57	Average	216	288
7	11590.00	60.12	74.00	-13.88	43.55	16.57	Peak	216	288
8	17385.00	62.96	68.20	-5.24	43.61	19.35	Peak	100	295

Note 1: Emission Level (dBuV/m) = SA Reading (dBuV/m) + Factor* (dB)

*Factor includes antenna factor , cable loss and amplifier gain

Note 2: Margin (dB) = Emission level (dBuV/m) – Limit (dBuV/m).

Modulation	HT40	Test Freq. (MHz)	5795
Polarization	Vertical		

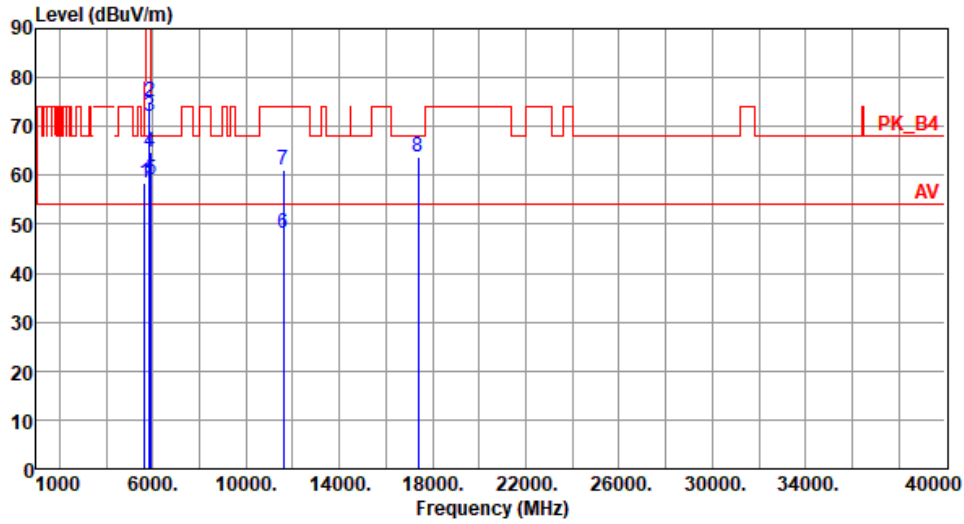

	Freq. MHz	Emission level dBuV/m	Limit dBuV/m	Margin dB	SA reading dBuV	Factor dB	Remark	ANT High cm	Turn Table deg
1	5650.00	58.51	68.20	-9.69	51.12	7.39	Peak	152	33
2	5850.00	74.94	122.20	-47.26	66.92	8.02	Peak	152	33
3	5855.00	72.15	110.80	-38.65	64.13	8.02	Peak	152	33
4	5875.00	64.66	105.20	-40.54	56.63	8.03	Peak	152	33
5	5925.00	59.14	68.20	-9.06	51.07	8.07	Peak	152	33
6	11590.00	48.12	54.00	-5.88	31.55	16.57	Average	115	319
7	11590.00	61.15	74.00	-12.85	44.58	16.57	Peak	115	319
8	17385.00	63.90	68.20	-4.30	44.55	19.35	Peak	105	299

Note 1: Emission Level (dBuV/m) = SA Reading (dBuV/m) + Factor* (dB)

*Factor includes antenna factor , cable loss and amplifier gain

Note 2: Margin (dB) = Emission level (dBuV/m) – Limit (dBuV/m).

Configuration 2 : Antenna NanoBlade-IP04

3.5.8 Transmitter Radiated Unwanted Emissions (Below 1GHz)

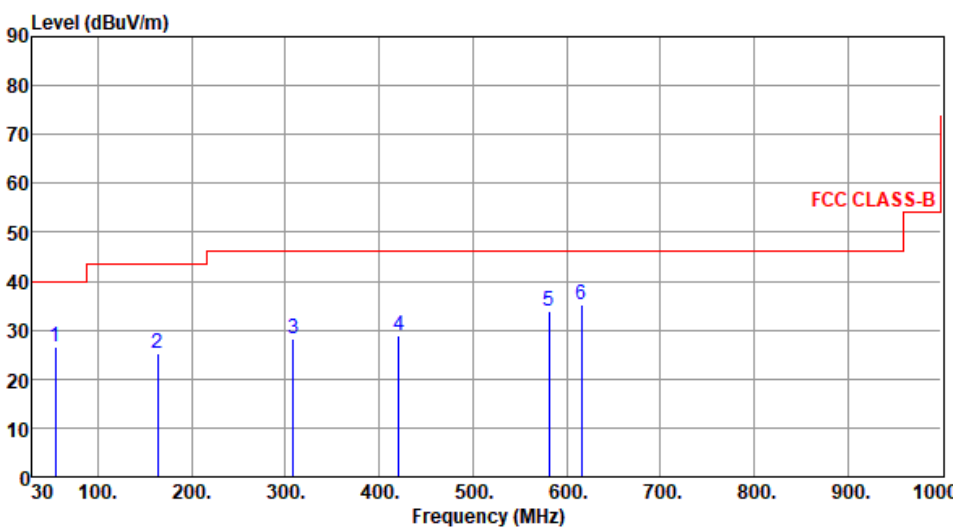
Modulation	11a	Test Freq. (MHz)	5240						
Polarization	Horizontal								
 <p>The graph displays the radiated unwanted emissions for Configuration 2. The y-axis represents the emission level in dBuV/m, ranging from 0 to 90. The x-axis represents the frequency in MHz, ranging from 30 to 1000. A red line indicates the FCC CLASS-B limit, which is 40 dBuV/m from 30 MHz to 100 MHz, 45 dBuV/m from 100 MHz to 300 MHz, and 50 dBuV/m from 300 MHz to 1000 MHz. Six emission peaks are identified and labeled 1 through 6, with their respective frequencies, emission levels, limits, margins, SA readings, and factors listed in the table below.</p>									
	Freq. MHz	Emission level dBuV/m	Limit dBuV/m	Margin dB	SA reading dBuV	Factor dB	Remark	ANT High cm	Turn Table deg
1	54.25	26.69	40.00	-13.31	35.67	-8.98	Peak	---	---
2	163.86	25.19	43.50	-18.31	34.28	-9.09	Peak	---	---
3	308.39	28.32	46.00	-17.68	36.54	-8.22	Peak	---	---
4	420.91	28.74	46.00	-17.26	33.84	-5.10	Peak	---	---
5	580.96	33.90	46.00	-12.10	35.13	-1.23	Peak	---	---
6	615.88	35.20	46.00	-10.80	35.31	-0.11	Peak	---	---

Note 1: Emission Level (dBuV/m) = SA Reading (dBuV/m) + Factor* (dB)
*Factor includes antenna factor , cable loss and amplifier gain
Note 2: Margin (dB) = Emission level (dBuV/m) – Limit (dBuV/m).
Note 3: All spurious emissions below 30MHz are more than 20 dB below the limit.

Modulation	11a	Test Freq. (MHz)	5240
Polarization	Vertical		

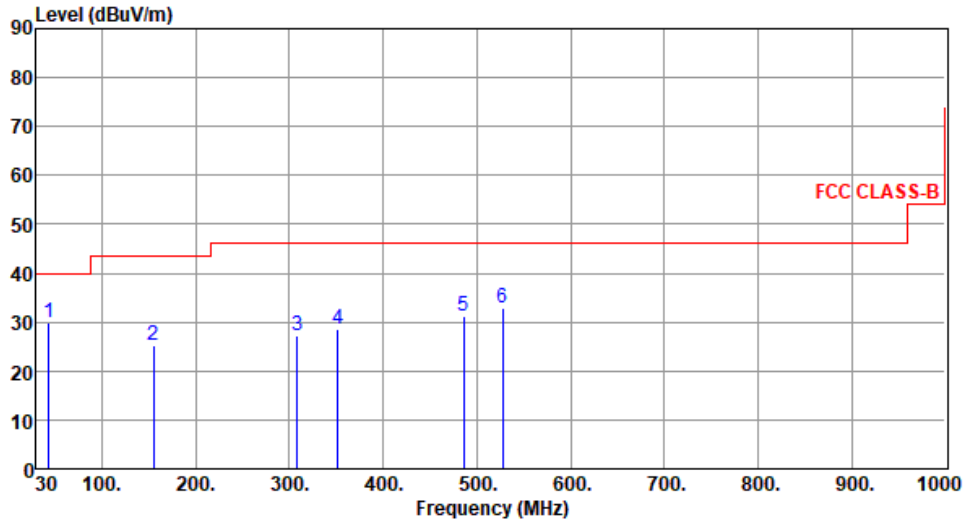

	Freq. MHz	Emission level dBuV/m	Limit dBuV/m	Margin dB	SA reading dBuV	Factor dB	Remark	ANT High cm	Turn Table deg
1	43.58	29.88	40.00	-10.12	38.66	-8.78	Peak	---	---
2	155.13	25.35	43.50	-18.15	34.29	-8.94	Peak	---	---
3	308.39	27.14	46.00	-18.86	35.36	-8.22	Peak	---	---
4	352.04	28.48	46.00	-17.52	35.68	-7.20	Peak	---	---
5	485.90	31.25	46.00	-14.75	34.65	-3.40	Peak	---	---
6	527.61	33.01	46.00	-12.99	35.56	-2.55	Peak	---	---

Note 1: Emission Level (dBuV/m) = SA Reading (dBuV/m) + Factor* (dB)

*Factor includes antenna factor , cable loss and amplifier gain

Note 2: Margin (dB) = Emission level (dBuV/m) – Limit (dBuV/m).

Note 3: All spurious emissions below 30MHz are more than 20 dB below the limit.

Modulation	HT40	Test Freq. (MHz)	5795
Polarization	Horizontal		

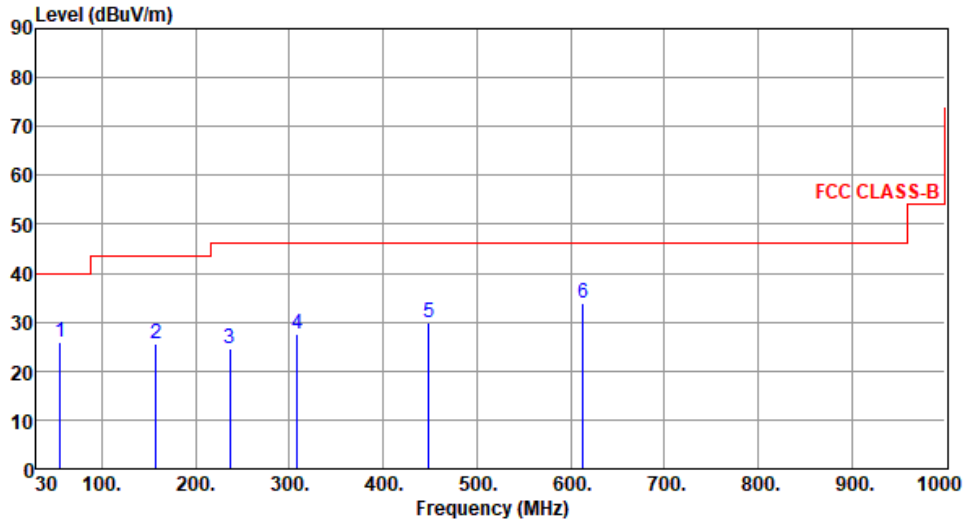

	Freq. MHz	Emission level dBuV/m	Limit dBuV/m	Margin dB	SA reading dBuV	Factor dB	Remark	ANT High cm	Turn Table deg
1	55.22	25.93	40.00	-14.07	35.04	-9.11	Peak	---	---
2	158.04	25.70	43.50	-17.80	34.72	-9.02	Peak	---	---
3	236.61	24.48	46.00	-21.52	35.36	-10.88	Peak	---	---
4	308.39	27.54	46.00	-18.46	35.76	-8.22	Peak	---	---
5	449.04	29.98	46.00	-16.02	34.00	-4.02	Peak	---	---
6	612.97	33.96	46.00	-12.04	34.04	-0.08	Peak	---	---

Note 1: Emission Level (dBuV/m) = SA Reading (dBuV/m) + Factor* (dB)

*Factor includes antenna factor , cable loss and amplifier gain

Note 2: Margin (dB) = Emission level (dBuV/m) – Limit (dBuV/m).

Note 3: All spurious emissions below 30MHz are more than 20 dB below the limit.

Modulation	HT40	Test Freq. (MHz)	5795
Polarization	Vertical		

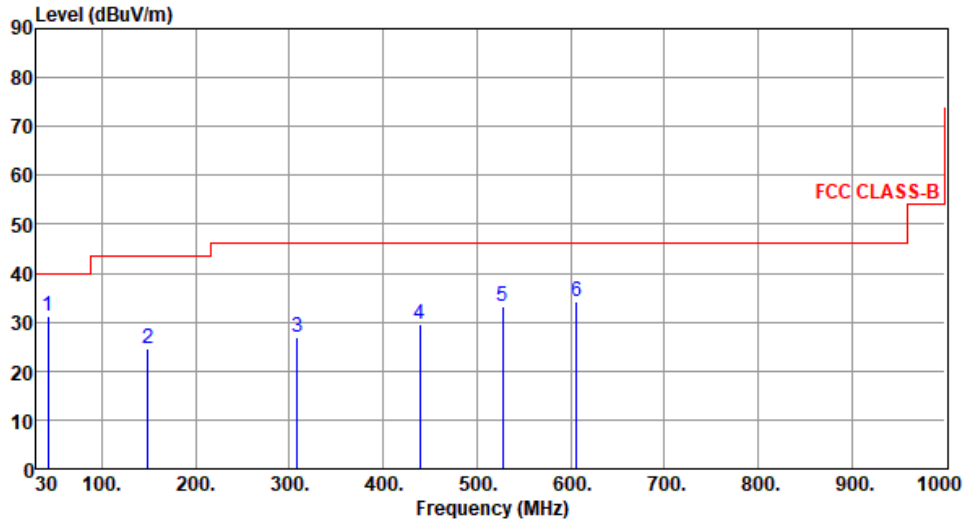

	Freq. MHz	Emission level dBuV/m	Limit dBuV/m	Margin dB	SA reading dBuV	Factor dB	Remark	ANT High cm	Turn Table deg
1	42.61	31.32	40.00	-8.68	40.14	-8.82	Peak	---	---
2	149.31	24.52	43.50	-18.98	33.50	-8.98	Peak	---	---
3	308.39	26.79	46.00	-19.21	35.01	-8.22	Peak	---	---
4	439.34	29.49	46.00	-16.51	33.84	-4.35	Peak	---	---
5	527.61	33.24	46.00	-12.76	35.79	-2.55	Peak	---	---
6	606.18	34.06	46.00	-11.94	34.35	-0.29	Peak	---	---

Note 1: Emission Level (dBuV/m) = SA Reading (dBuV/m) + Factor* (dB)

*Factor includes antenna factor , cable loss and amplifier gain

Note 2: Margin (dB) = Emission level (dBuV/m) – Limit (dBuV/m).

Note 3: All spurious emissions below 30MHz are more than 20 dB below the limit.

3.5.9 Transmitter Radiated Unwanted Emissions (Above 1GHz) for 11a

Modulation	11a	Test Freq. (MHz)	5180					
Polarization	Horizontal							
Freq.	Emission level	Limit	Margin	SA	Factor	Remark	ANT	Turn
MHz	dBuV/m	dBuV/m	dB	reading	dB		High	Table
				dBuV			cm	deg
1	5120.00	48.37	54.00	-5.63	41.06	7.31	Average	207
2	5120.00	61.19	74.00	-12.81	53.88	7.31	Peak	261
3	5150.00	50.93	54.00	-3.07	43.61	7.32	Average	347
4	5150.00	64.14	74.00	-9.86	56.82	7.32	Peak	261
5	10360.00	60.42	68.20	-7.78	44.33	16.09	Peak	196
6	15540.00	49.05	54.00	-4.95	31.68	17.37	Average	342
7	15540.00	62.60	74.00	-11.40	45.23	17.37	Peak	168

Note 1: Emission Level (dBuV/m) = SA Reading (dBuV/m) + Factor* (dB)
*Factor includes antenna factor , cable loss and amplifier gain
Note 2: Margin (dB) = Emission level (dBuV/m) – Limit (dBuV/m).

Modulation	11a	Test Freq. (MHz)	5180
Polarization	Vertical		

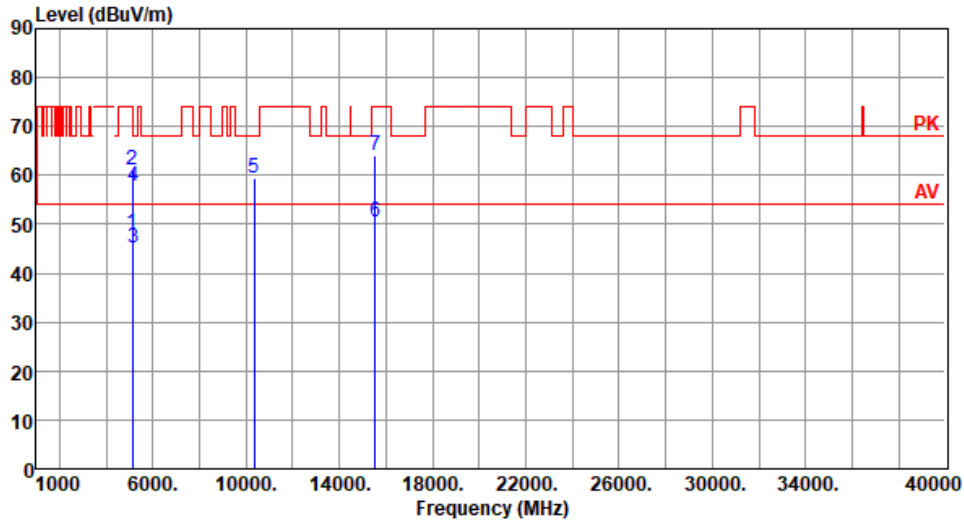

	Freq. MHz	Emission level dBuV/m	Limit dBuV/m	Margin dB	SA reading dBuV	Factor dB	Remark	ANT High cm	Turn Table deg
1	5120.00	48.14	54.00	-5.86	40.83	7.31	Average	151	52
2	5120.00	61.25	74.00	-12.75	53.94	7.31	Peak	151	52
3	5150.00	45.33	54.00	-8.67	38.01	7.32	Average	188	234
4	5150.00	57.93	74.00	-16.07	50.61	7.32	Peak	188	234
5	10360.00	59.40	68.20	-8.80	43.31	16.09	Peak	115	48
6	15540.00	50.51	54.00	-3.49	33.14	17.37	Average	196	321
7	15540.00	63.99	74.00	-10.01	46.62	17.37	Peak	196	321

Note 1: Emission Level (dBuV/m) = SA Reading (dBuV/m) + Factor* (dB)

*Factor includes antenna factor , cable loss and amplifier gain

Note 2: Margin (dB) = Emission level (dBuV/m) – Limit (dBuV/m).

Modulation	11a	Test Freq. (MHz)	5240
Polarization	Horizontal		

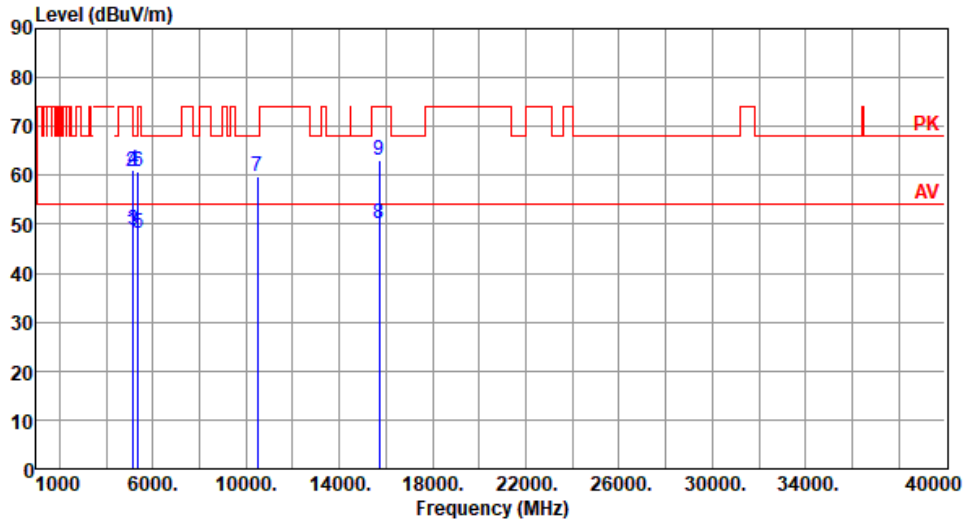

	Freq. MHz	Emission level dBUV/m	Limit dBUV/m	Margin dB	SA reading dBUV	Factor dB	Remark	ANT High cm	Turn Table deg
1	5120.00	48.59	54.00	-5.41	41.28	7.31	Average	269	195
2	5120.00	60.84	74.00	-13.16	53.53	7.31	Peak	269	195
3	5148.00	48.96	54.00	-5.04	41.65	7.31	Average	269	343
4	5148.00	61.00	74.00	-13.00	53.69	7.31	Peak	269	343
5	5350.00	48.07	54.00	-5.93	41.22	6.85	Average	269	343
6	5350.00	60.68	74.00	-13.32	53.83	6.85	Peak	269	343
7	10480.00	59.69	68.20	-8.51	43.28	16.41	Peak	271	342
8	15720.00	50.18	54.00	-3.82	33.58	16.60	Average	175	8
9	15720.00	63.13	74.00	-10.87	46.53	16.60	Peak	175	8

Note 1: Emission Level (dBUV/m) = SA Reading (dBUV/m) + Factor* (dB)

*Factor includes antenna factor , cable loss and amplifier gain

Note 2: Margin (dB) = Emission level (dBUV/m) – Limit (dBUV/m).

Modulation	11a	Test Freq. (MHz)	5240
Polarization	Vertical		

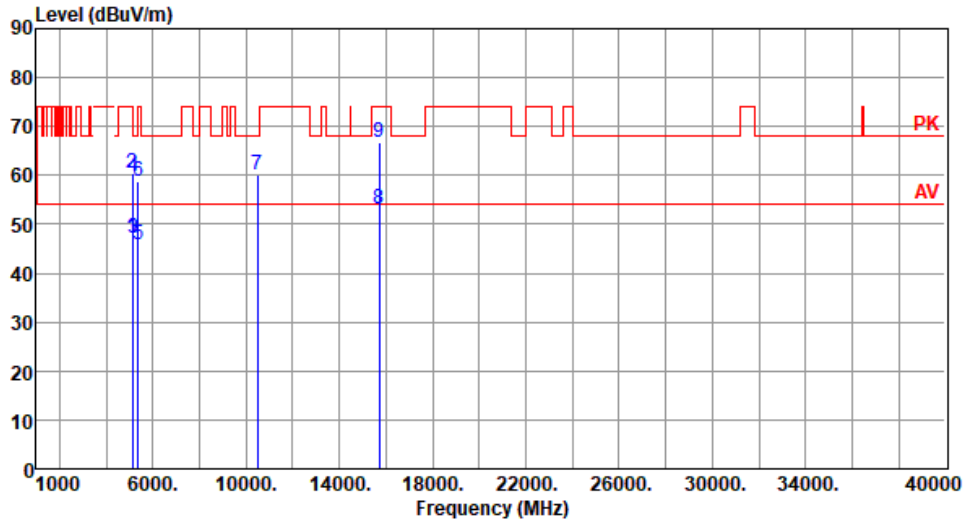

	Freq. MHz	Emission level dBuV/m	Limit dBuV/m	Margin dB	SA reading dBuV	Factor dB	Remark	ANT High cm	Turn Table deg
1	5120.00	47.25	54.00	-6.75	39.94	7.31	Average	151	92
2	5120.00	60.36	74.00	-13.64	53.05	7.31	Peak	151	92
3	5148.00	47.14	54.00	-6.86	39.83	7.31	Average	166	114
4	5148.00	59.85	74.00	-14.15	52.54	7.31	Peak	166	114
5	5350.00	45.99	54.00	-8.01	39.14	6.85	Average	185	231
6	5350.00	58.81	74.00	-15.19	51.96	6.85	Peak	185	231
7	10480.00	60.15	68.20	-8.05	43.74	16.41	Peak	100	63
8	15720.00	52.98	54.00	-1.02	36.38	16.60	Average	153	317
9	15720.00	66.83	74.00	-7.17	50.23	16.60	Peak	153	317

Note 1: Emission Level (dBuV/m) = SA Reading (dBuV/m) + Factor* (dB)

*Factor includes antenna factor , cable loss and amplifier gain

Note 2: Margin (dB) = Emission level (dBuV/m) – Limit (dBuV/m).

Modulation	11a	Test Freq. (MHz)	5300
Polarization	Horizontal		

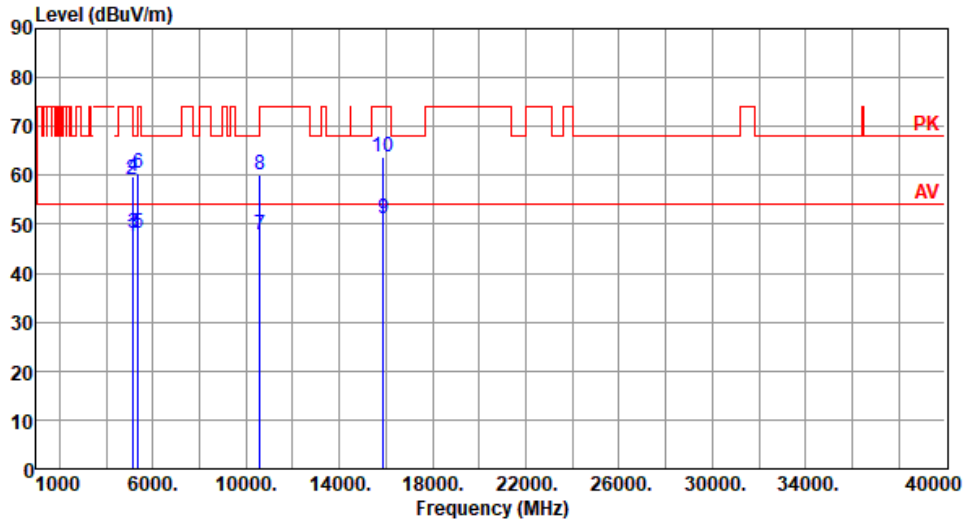

	Freq. MHz	Emission level dBuV/m	Limit dBuV/m	Margin dB	SA reading dBuV	Factor dB	Remark	ANT High cm	Turn Table deg
1	5120.00	47.51	54.00	-6.49	40.20	7.31	Average	250	350
2	5120.00	59.10	74.00	-14.90	51.79	7.31	Peak	250	350
3	5148.00	48.00	54.00	-6.00	40.69	7.31	Average	250	350
4	5148.00	59.70	74.00	-14.30	52.39	7.31	Peak	250	350
5	5350.00	48.25	54.00	-5.75	41.40	6.85	Average	250	350
6	5350.00	60.41	74.00	-13.59	53.56	6.85	Peak	250	350
7	10600.00	47.71	54.00	-6.29	31.35	16.36	Average	100	351
8	10600.00	59.98	74.00	-14.02	43.62	16.36	Peak	100	351
9	15900.00	51.21	54.00	-2.79	34.52	16.69	Average	196	7
10	15900.00	63.76	74.00	-10.24	47.07	16.69	Peak	196	7

Note 1: Emission Level (dBuV/m) = SA Reading (dBuV/m) + Factor* (dB)

*Factor includes antenna factor , cable loss and amplifier gain

Note 2: Margin (dB) = Emission level (dBuV/m) – Limit (dBuV/m).

Modulation	11a	Test Freq. (MHz)	5300
Polarization	Vertical		

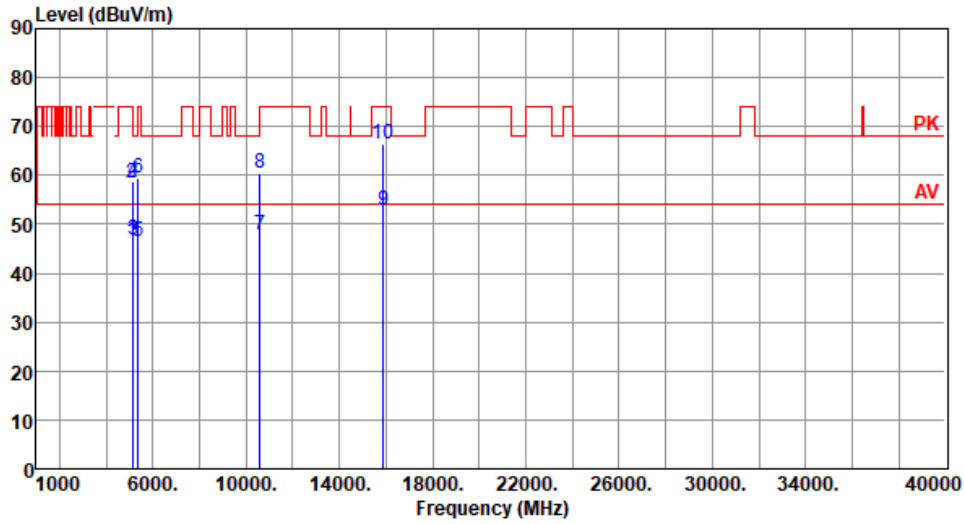

	Freq. MHz	Emission level dBuV/m	Limit dBuV/m	Margin dB	SA reading dBuV	Factor dB	Remark	ANT High cm	Turn Table deg
1	5120.00	46.42	54.00	-7.58	39.11	7.31	Average	152	95
2	5120.00	58.57	74.00	-15.43	51.26	7.31	Peak	152	95
3	5148.00	46.67	54.00	-7.33	39.36	7.31	Average	169	115
4	5148.00	58.88	74.00	-15.12	51.57	7.31	Peak	169	115
5	5350.00	46.50	54.00	-7.50	39.65	6.85	Average	186	239
6	5350.00	59.31	74.00	-14.69	52.46	6.85	Peak	186	239
7	10600.00	47.73	54.00	-6.27	31.37	16.36	Average	100	65
8	10600.00	60.50	74.00	-13.50	44.14	16.36	Peak	100	65
9	15900.00	52.97	54.00	-1.03	36.28	16.69	Average	197	307
10	15900.00	66.53	74.00	-7.47	49.84	16.69	Peak	197	307

Note 1: Emission Level (dBuV/m) = SA Reading (dBuV/m) + Factor* (dB)

*Factor includes antenna factor , cable loss and amplifier gain

Note 2: Margin (dB) = Emission level (dBuV/m) – Limit (dBuV/m).

Modulation	11a	Test Freq. (MHz)	5500
Polarization	Horizontal		

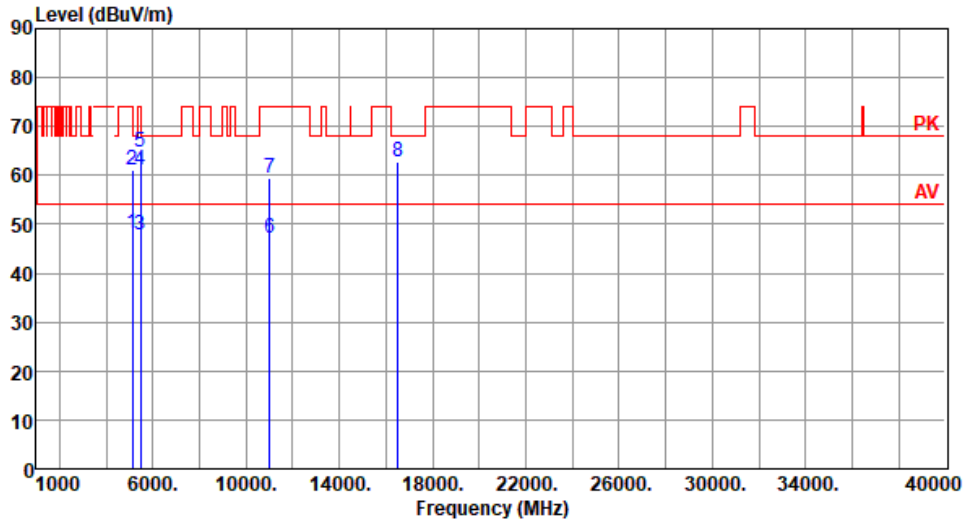

	Freq. MHz	Emission level dBuV/m	Limit dBuV/m	Margin dB	SA reading dBuV	Factor dB	Remark	ANT High cm	Turn Table deg
1	5120.00	48.13	54.00	-5.87	40.82	7.31	Average	247	205
2	5120.00	60.96	74.00	-13.04	53.65	7.31	Peak	247	205
3	5460.00	47.69	54.00	-6.31	40.44	7.25	Average	247	182
4	5460.00	60.96	74.00	-13.04	53.71	7.25	Peak	247	182
5	5470.00	64.91	68.20	-3.29	57.63	7.28	Peak	247	182
6	11000.00	47.05	54.00	-6.95	30.21	16.84	Average	100	320
7	11000.00	59.43	74.00	-14.57	42.59	16.84	Peak	100	320
8	16500.00	62.89	68.20	-5.31	45.25	17.64	Peak	166	315

Note 1: Emission Level (dBuV/m) = SA Reading (dBuV/m) + Factor* (dB)

*Factor includes antenna factor , cable loss and amplifier gain

Note 2: Margin (dB) = Emission level (dBuV/m) – Limit (dBuV/m).

Modulation	11a	Test Freq. (MHz)	5500
Polarization	Vertical		

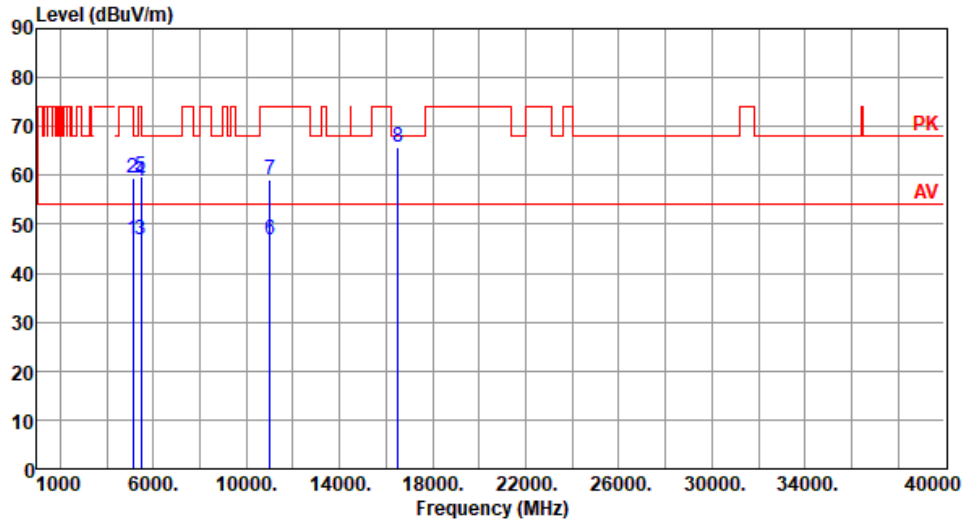

	Freq. MHz	Emission level dBuV/m	Limit dBuV/m	Margin dB	SA reading dBuV	Factor dB	Remark	ANT High cm	Turn Table deg
1	5120.00	46.77	54.00	-7.23	39.46	7.31	Average	144	93
2	5120.00	59.55	74.00	-14.45	52.24	7.31	Peak	144	93
3	5460.00	46.81	54.00	-7.19	39.56	7.25	Average	187	232
4	5460.00	58.71	74.00	-15.29	51.46	7.25	Peak	187	232
5	5470.00	59.86	68.20	-8.34	52.58	7.28	Peak	187	232
6	11000.00	46.99	54.00	-7.01	30.15	16.84	Average	100	66
7	11000.00	59.17	74.00	-14.83	42.33	16.84	Peak	100	66
8	16500.00	65.75	68.20	-2.45	48.11	17.64	Peak	245	311

Note 1: Emission Level (dBuV/m) = SA Reading (dBuV/m) + Factor* (dB)

*Factor includes antenna factor , cable loss and amplifier gain

Note 2: Margin (dB) = Emission level (dBuV/m) – Limit (dBuV/m).

Modulation	11a	Test Freq. (MHz)	5580
Polarization	Horizontal		

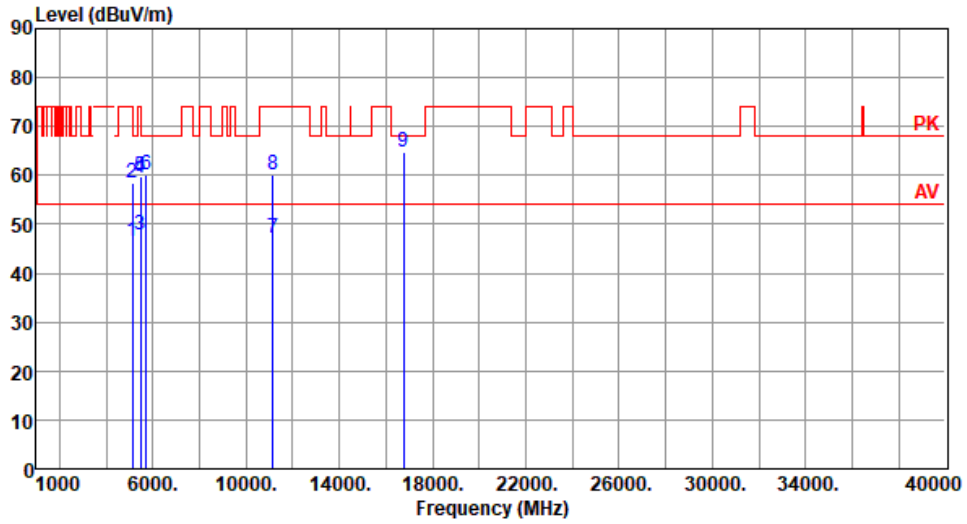

	Freq. MHz	Emission level dBuV/m	Limit dBuV/m	Margin dB	SA reading dBuV	Factor dB	Remark	ANT High cm	Turn Table deg
1	5120.00	46.49	54.00	-7.51	39.18	7.31	Average	255	195
2	5120.00	58.36	74.00	-15.64	51.05	7.31	Peak	255	195
3	5460.00	47.81	54.00	-6.19	40.56	7.25	Average	242	319
4	5460.00	59.50	74.00	-14.50	52.25	7.25	Peak	242	319
5	5470.00	59.83	68.20	-8.37	52.55	7.28	Peak	242	319
6	5725.00	59.96	68.20	-8.24	52.30	7.66	Peak	242	319
7	11160.00	47.12	54.00	-6.88	30.53	16.59	Average	175	319
8	11160.00	60.01	74.00	-13.99	43.42	16.59	Peak	175	319
9	16740.00	64.65	68.20	-3.55	46.42	18.23	Peak	165	319

Note 1: Emission Level (dBuV/m) = SA Reading (dBuV/m) + Factor* (dB)

*Factor includes antenna factor , cable loss and amplifier gain

Note 2: Margin (dB) = Emission level (dBuV/m) – Limit (dBuV/m).

Modulation	11a	Test Freq. (MHz)	5580
Polarization	Vertical		

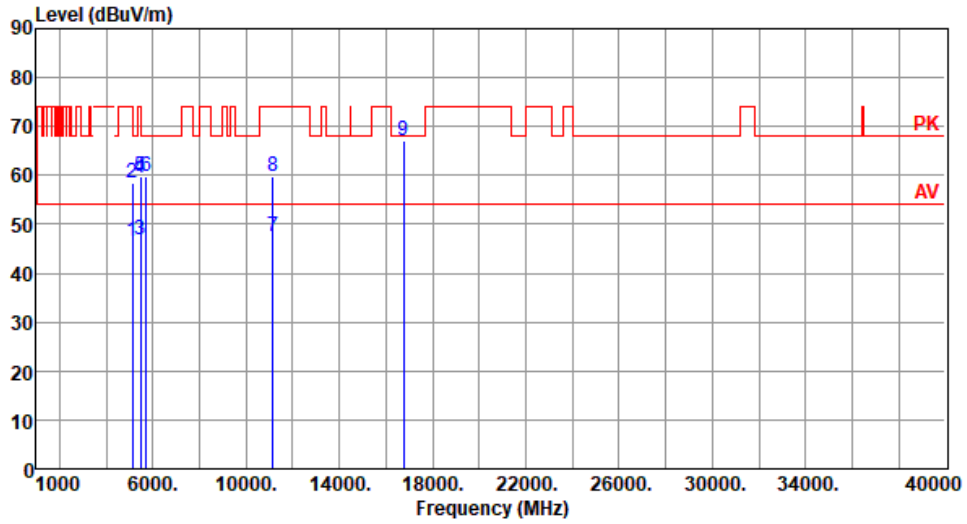

	Freq. MHz	Emission level dBuV/m	Limit dBuV/m	Margin dB	SA reading dBuV	Factor dB	Remark	ANT High cm	Turn Table deg
1	5120.00	46.42	54.00	-7.58	39.11	7.31	Average	149	95
2	5120.00	58.32	74.00	-15.68	51.01	7.31	Peak	149	95
3	5460.00	46.67	54.00	-7.33	39.42	7.25	Average	188	233
4	5460.00	59.40	74.00	-14.60	52.15	7.25	Peak	188	233
5	5470.00	59.73	68.20	-8.47	52.45	7.28	Peak	188	233
6	5725.00	59.67	68.20	-8.53	52.01	7.66	Peak	188	233
7	11160.00	47.37	54.00	-6.63	30.78	16.59	Average	100	65
8	11160.00	59.70	74.00	-14.30	43.11	16.59	Peak	100	65
9	16740.00	67.18	68.20	-1.02	48.95	18.23	Peak	253	310

Note 1: Emission Level (dBuV/m) = SA Reading (dBuV/m) + Factor* (dB)

*Factor includes antenna factor , cable loss and amplifier gain

Note 2: Margin (dB) = Emission level (dBuV/m) – Limit (dBuV/m).

Modulation	11a	Test Freq. (MHz)	5700
Polarization	Horizontal		

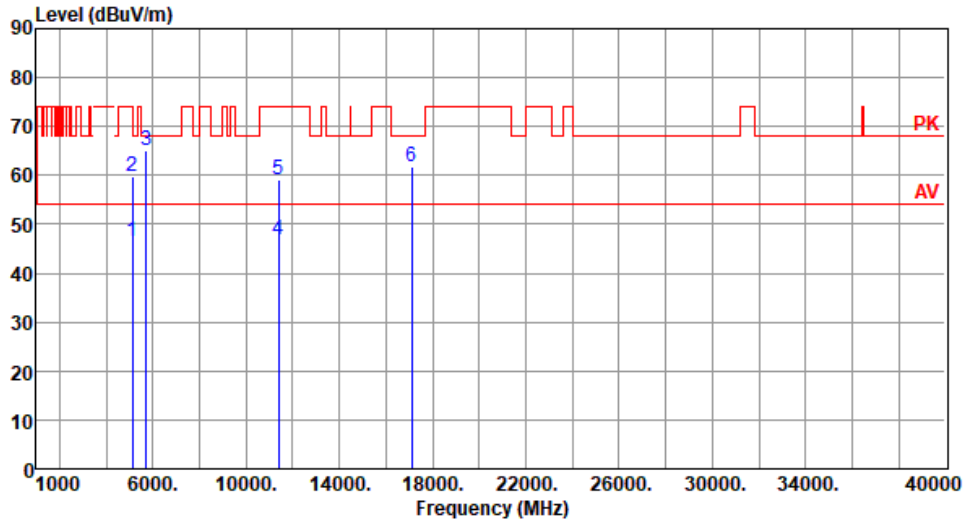

	Freq. MHz	Emission level dBuV/m	Limit dBuV/m	Margin dB	SA reading dBuV	Factor dB	Remark	ANT High cm	Turn Table deg
1	5120.00	46.66	54.00	-7.34	39.35	7.31	Average	262	203
2	5120.00	59.74	74.00	-14.26	52.43	7.31	Peak	262	203
3	5725.00	65.09	68.20	-3.11	57.43	7.66	Peak	262	349
4	11400.00	46.98	54.00	-7.02	30.25	16.73	Average	100	50
5	11400.00	59.15	74.00	-14.85	42.42	16.73	Peak	100	50
6	17100.00	61.69	68.20	-6.51	43.45	18.24	Peak	100	315

Note 1: Emission Level (dBuV/m) = SA Reading (dBuV/m) + Factor* (dB)

*Factor includes antenna factor , cable loss and amplifier gain

Note 2: Margin (dB) = Emission level (dBuV/m) – Limit (dBuV/m).

Modulation	11a	Test Freq. (MHz)	5700
Polarization	Vertical		

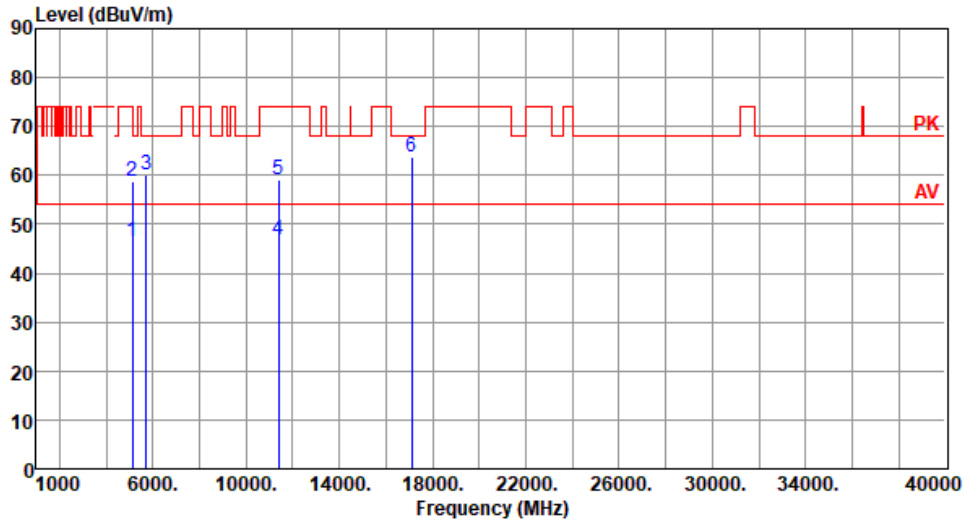

	Freq. MHz	Emission level dBuV/m	Limit dBuV/m	Margin dB	SA reading dBuV	Factor dB	Remark	ANT High cm	Turn Table deg
1	5120.00	46.52	54.00	-7.48	39.21	7.31	Average	146	95
2	5120.00	58.84	74.00	-15.16	51.53	7.31	Peak	146	95
3	5725.00	60.11	68.20	-8.09	52.45	7.66	Peak	189	235
4	11400.00	46.89	54.00	-7.11	30.16	16.73	Average	100	30
5	11400.00	59.06	74.00	-14.94	42.33	16.73	Peak	100	30
6	17100.00	63.70	68.20	-4.50	45.46	18.24	Peak	243	311

Note 1: Emission Level (dBuV/m) = SA Reading (dBuV/m) + Factor* (dB)

*Factor includes antenna factor , cable loss and amplifier gain

Note 2: Margin (dB) = Emission level (dBuV/m) – Limit (dBuV/m).

Modulation	11a	Test Freq. (MHz)	5720
Polarization	Horizontal		

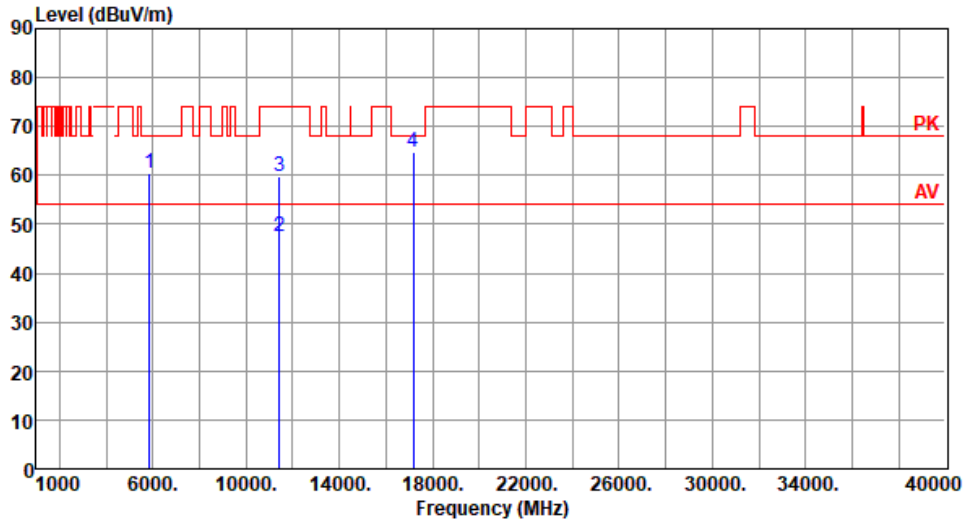

	Freq. MHz	Emission level dBuV/m	Limit dBuV/m	Margin dB	SA reading dBuV	Factor dB	Remark	ANT High cm	Turn Table deg
1	5850.00	60.52	68.20	-7.68	52.50	8.02	Peak	259	342
2	11440.00	47.52	54.00	-6.48	30.78	16.74	Average	100	36
3	11440.00	59.89	74.00	-14.11	43.15	16.74	Peak	100	36
4	17160.00	64.88	68.20	-3.32	46.50	18.38	Peak	144	29

Note 1: Emission Level (dBuV/m) = SA Reading (dBuV/m) + Factor* (dB)

*Factor includes antenna factor , cable loss and amplifier gain

Note 2: Margin (dB) = Emission level (dBuV/m) – Limit (dBuV/m).

Modulation	11a	Test Freq. (MHz)	5720
Polarization	Vertical		

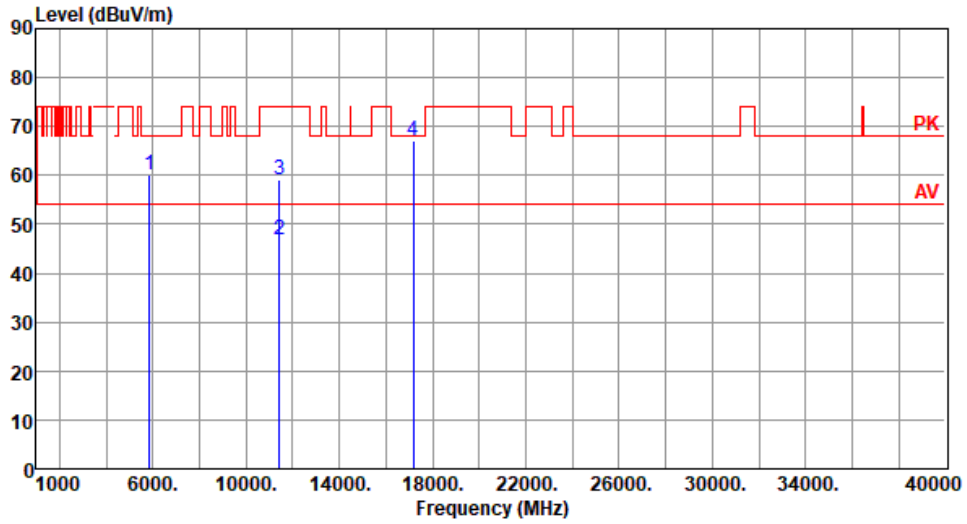

	Freq. MHz	Emission level dBuV/m	Limit dBuV/m	Margin dB	SA reading dBuV	Factor dB	Remark	ANT High cm	Turn Table deg
1	5850.00	60.26	68.20	-7.94	52.24	8.02	Peak	189	236
2	11440.00	46.95	54.00	-7.05	30.21	16.74	Average	100	28
3	11440.00	59.21	74.00	-14.79	42.47	16.74	Peak	100	28
4	17160.00	67.12	68.20	-1.08	48.74	18.38	Peak	295	312

Note 1: Emission Level (dBuV/m) = SA Reading (dBuV/m) + Factor* (dB)

*Factor includes antenna factor , cable loss and amplifier gain

Note 2: Margin (dB) = Emission level (dBuV/m) – Limit (dBuV/m).

Modulation	11a	Test Freq. (MHz)	5745
Polarization	Horizontal		

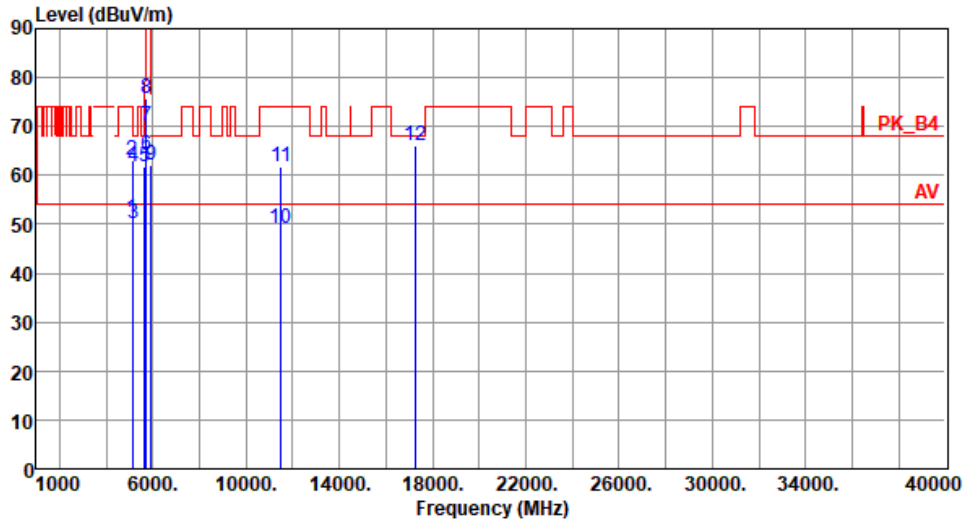

	Freq. MHz	Emission level dBuV/m	Limit dBuV/m	Margin dB	SA reading dBuV	Factor dB	Remark	ANT High cm	Turn Table deg
1	5120.00	50.99	54.00	-3.01	43.68	7.31	Average	265	200
2	5120.00	62.95	74.00	-11.05	55.64	7.31	Peak	265	200
3	5148.00	50.19	54.00	-3.81	42.88	7.31	Average	260	347
4	5148.00	61.70	74.00	-12.30	54.39	7.31	Peak	260	347
5	5650.00	61.64	68.20	-6.56	54.25	7.39	Peak	260	347
6	5700.00	64.21	105.20	-40.99	56.71	7.50	Peak	260	347
7	5720.00	70.14	110.80	-40.66	62.52	7.62	Peak	260	347
8	5725.00	75.60	122.20	-46.60	67.94	7.66	Peak	260	347
9	5925.00	62.20	68.20	-6.00	54.13	8.07	Peak	260	347
10	11490.00	49.27	54.00	-4.73	32.51	16.76	Average	176	319
11	11490.00	61.62	74.00	-12.38	44.86	16.76	Peak	176	319
12	17235.00	66.00	68.20	-2.20	47.36	18.64	Peak	192	359

Note 1: Emission Level (dBuV/m) = SA Reading (dBuV/m) + Factor* (dB)

*Factor includes antenna factor , cable loss and amplifier gain

Note 2: Margin (dB) = Emission level (dBuV/m) – Limit (dBuV/m).

Modulation	11a	Test Freq. (MHz)	5745
Polarization	Vertical		

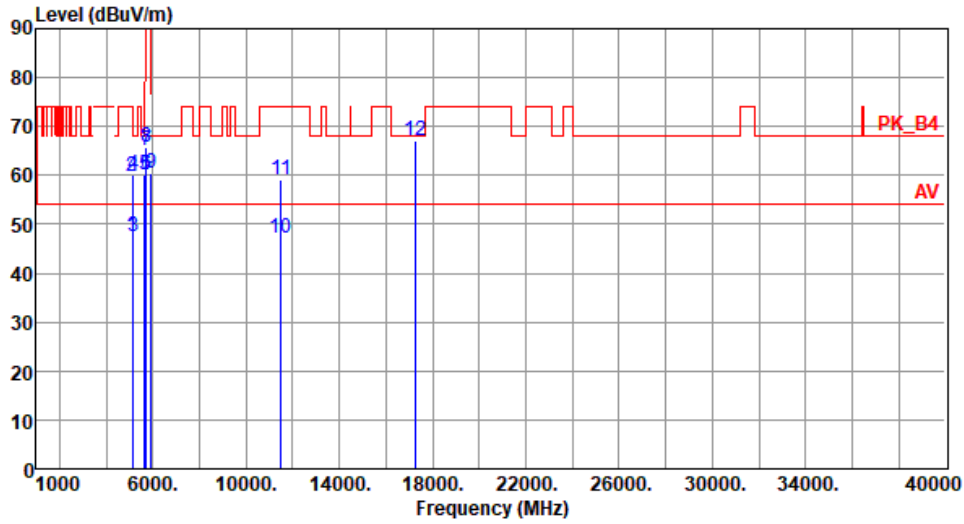

	Freq. MHz	Emission level dBuV/m	Limit dBuV/m	Margin dB	SA reading dBuV	Factor dB	Remark	ANT High cm	Turn Table deg
1	5120.00	47.43	54.00	-6.57	40.12	7.31	Average	146	90
2	5120.00	59.77	74.00	-14.23	52.46	7.31	Peak	146	90
3	5148.00	47.33	54.00	-6.67	40.02	7.31	Average	146	90
4	5148.00	60.00	74.00	-14.00	52.69	7.31	Peak	146	90
5	5650.00	59.95	68.20	-8.25	52.56	7.39	Peak	188	233
6	5700.00	59.96	105.20	-45.24	52.46	7.50	Peak	188	233
7	5720.00	65.08	110.80	-45.72	57.46	7.62	Peak	188	233
8	5725.00	65.77	122.20	-56.43	58.11	7.66	Peak	188	233
9	5925.00	60.44	68.20	-7.76	52.37	8.07	Peak	188	233
10	11490.00	47.13	54.00	-6.87	30.37	16.76	Average	100	50
11	11490.00	59.23	74.00	-14.77	42.47	16.76	Peak	100	50
12	17235.00	67.10	68.20	-1.10	48.46	18.64	Peak	295	310

Note 1: Emission Level (dBuV/m) = SA Reading (dBuV/m) + Factor* (dB)

*Factor includes antenna factor , cable loss and amplifier gain

Note 2: Margin (dB) = Emission level (dBuV/m) – Limit (dBuV/m).

Modulation	11a	Test Freq. (MHz)	5785
Polarization	Horizontal		

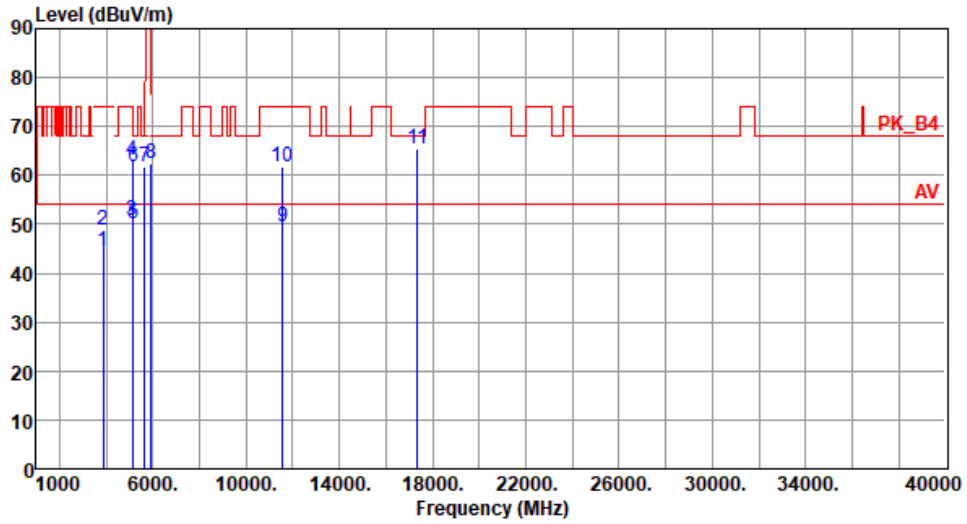

	Freq. MHz	Emission level dBuV/m	Limit dBuV/m	Margin dB	SA reading dBuV	Factor dB	Remark	ANT High cm	Turn Table deg
1	3856.66	44.65	54.00	-9.35	40.63	4.02	Average	210	195
2	3856.66	48.94	74.00	-25.06	44.92	4.02	Peak	210	195
3	5120.00	50.69	54.00	-3.31	43.38	7.31	Average	250	195
4	5120.00	63.02	74.00	-10.98	55.71	7.31	Peak	250	195
5	5148.00	50.28	54.00	-3.72	42.97	7.31	Average	250	352
6	5148.00	61.87	74.00	-12.13	54.56	7.31	Peak	250	352
7	5650.00	61.65	68.20	-6.55	54.26	7.39	Peak	250	352
8	5925.00	62.44	68.20	-5.76	54.37	8.07	Peak	250	352
9	11570.00	49.34	54.00	-4.66	32.73	16.61	Average	173	309
10	11570.00	61.75	74.00	-12.25	45.14	16.61	Peak	173	309
11	17355.00	65.41	68.20	-2.79	46.18	19.23	Peak	143	310

Note 1: Emission Level (dBuV/m) = SA Reading (dBuV/m) + Factor* (dB)

*Factor includes antenna factor , cable loss and amplifier gain

Note 2: Margin (dB) = Emission level (dBuV/m) – Limit (dBuV/m).

Modulation	11a	Test Freq. (MHz)	5785
Polarization	Vertical		

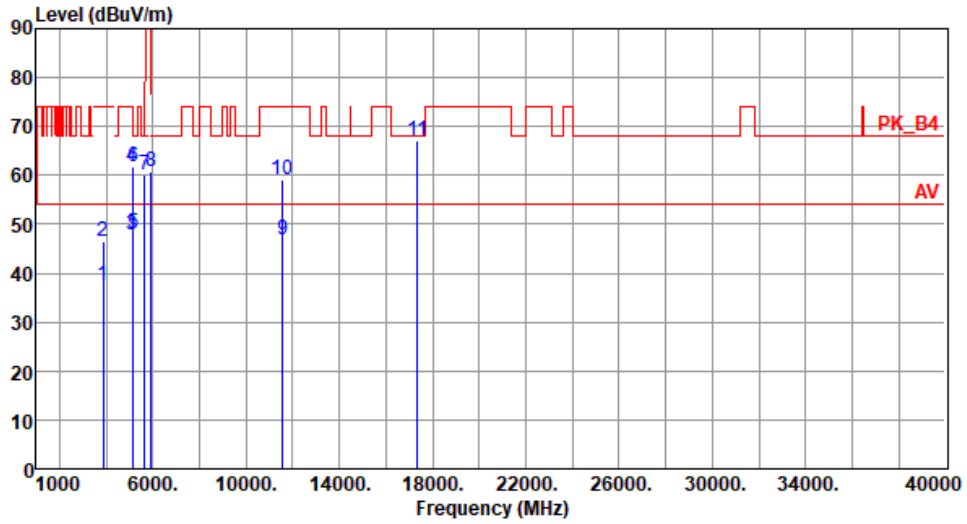

	Freq. MHz	Emission level dBuV/m	Limit dBuV/m	Margin dB	SA reading dBuV	Factor dB	Remark	ANT High cm	Turn Table deg
1	3856.66	37.37	54.00	-16.63	33.35	4.02	Average	100	97
2	3856.66	46.35	74.00	-27.65	42.33	4.02	Peak	100	97
3	5120.00	47.87	54.00	-6.13	40.56	7.31	Average	144	80
4	5120.00	61.66	74.00	-12.34	54.35	7.31	Peak	144	80
5	5148.00	48.06	54.00	-5.94	40.75	7.31	Average	144	80
6	5148.00	61.85	74.00	-12.15	54.54	7.31	Peak	144	80
7	5650.00	59.95	68.20	-8.25	52.56	7.39	Peak	189	234
8	5925.00	60.63	68.20	-7.57	52.56	8.07	Peak	189	234
9	11570.00	46.86	54.00	-7.14	30.25	16.61	Average	100	60
10	11570.00	59.15	74.00	-14.85	42.54	16.61	Peak	100	60
11	17355.00	67.08	68.20	-1.12	47.85	19.23	Peak	250	325

Note 1: Emission Level (dBuV/m) = SA Reading (dBuV/m) + Factor* (dB)

*Factor includes antenna factor , cable loss and amplifier gain

Note 2: Margin (dB) = Emission level (dBuV/m) – Limit (dBuV/m).

Modulation	11a	Test Freq. (MHz)	5825
Polarization	Horizontal		

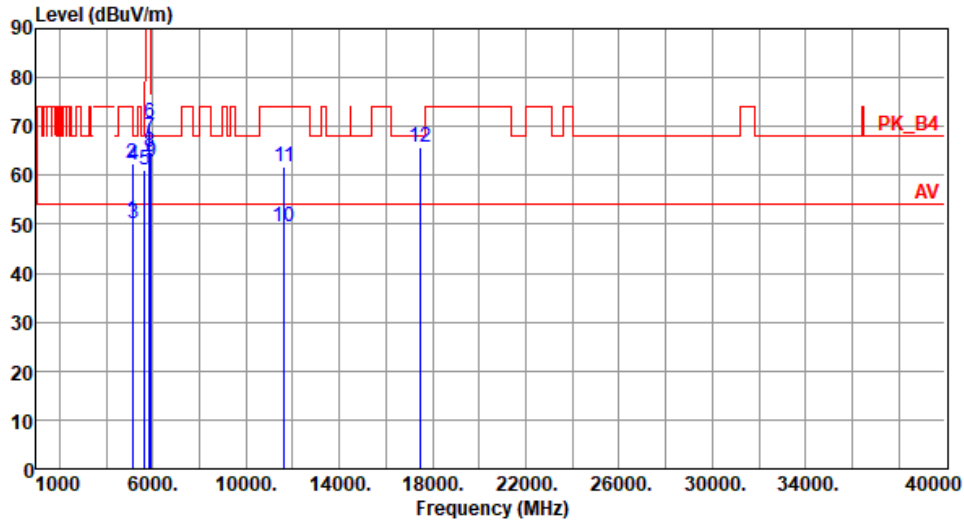

	Freq. MHz	Emission level dBuV/m	Limit dBuV/m	Margin dB	SA reading dBuV	Factor dB	Remark	ANT High cm	Turn Table deg
1	5120.00	50.66	54.00	-3.34	43.35	7.31	Average	273	205
2	5120.00	62.57	74.00	-11.43	55.26	7.31	Peak	273	205
3	5148.00	50.07	54.00	-3.93	42.76	7.31	Average	273	356
4	5148.00	62.00	74.00	-12.00	54.69	7.31	Peak	273	356
5	5650.00	61.22	68.20	-6.98	53.83	7.39	Peak	273	356
6	5850.00	70.77	122.20	-51.43	62.75	8.02	Peak	273	356
7	5855.00	67.83	110.80	-42.97	59.81	8.02	Peak	273	356
8	5875.00	64.86	105.20	-40.34	56.83	8.03	Peak	273	356
9	5925.00	62.76	68.20	-5.44	54.69	8.07	Peak	273	356
10	11650.00	49.33	54.00	-4.67	32.95	16.38	Average	273	306
11	11650.00	61.64	74.00	-12.36	45.26	16.38	Peak	273	306
12	17475.00	65.59	68.20	-2.61	45.85	19.74	Peak	175	315

Note 1: Emission Level (dBuV/m) = SA Reading (dBuV/m) + Factor* (dB)

*Factor includes antenna factor , cable loss and amplifier gain

Note 2: Margin (dB) = Emission level (dBuV/m) – Limit (dBuV/m).

Modulation	11a	Test Freq. (MHz)	5825
Polarization	Vertical		

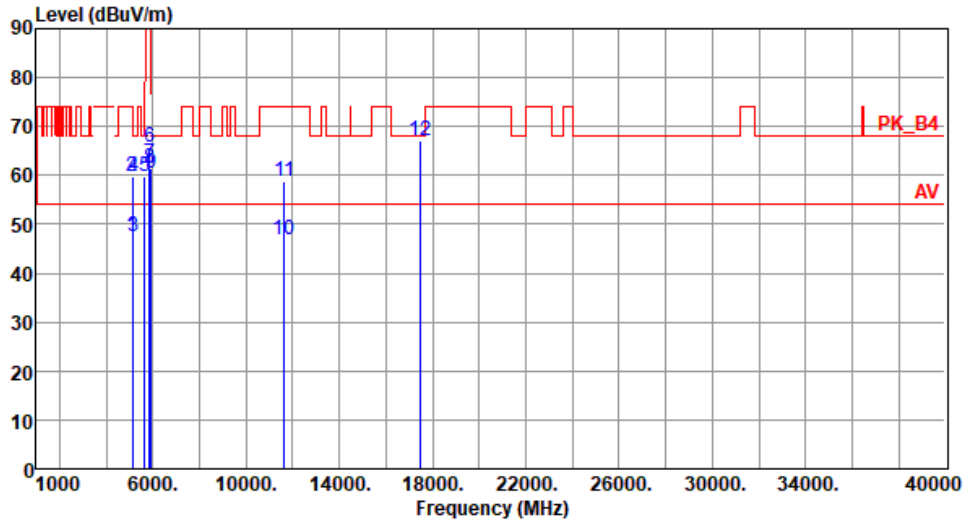

	Freq. MHz	Emission level dBuV/m	Limit dBuV/m	Margin dB	SA reading dBuV	Factor dB	Remark	ANT High cm	Turn Table deg
1	5120.00	47.57	54.00	-6.43	40.26	7.31	Average	144	93
2	5120.00	59.76	74.00	-14.24	52.45	7.31	Peak	144	93
3	5148.00	47.63	54.00	-6.37	40.32	7.31	Average	144	93
4	5148.00	59.78	74.00	-14.22	52.47	7.31	Peak	144	93
5	5650.00	59.85	68.20	-8.35	52.46	7.39	Peak	187	232
6	5850.00	65.61	122.20	-56.59	57.59	8.02	Peak	187	232
7	5855.00	62.58	110.80	-48.22	54.56	8.02	Peak	187	232
8	5875.00	61.47	105.20	-43.73	53.44	8.03	Peak	187	232
9	5925.00	60.44	68.20	-7.76	52.37	8.07	Peak	187	232
10	11650.00	46.81	54.00	-7.19	30.43	16.38	Average	100	40
11	11650.00	58.86	74.00	-15.14	42.48	16.38	Peak	100	40
12	17475.00	67.04	68.20	-1.16	47.30	19.74	Peak	275	316

Note 1: Emission Level (dBuV/m) = SA Reading (dBuV/m) + Factor* (dB)

*Factor includes antenna factor , cable loss and amplifier gain

Note 2: Margin (dB) = Emission level (dBuV/m) – Limit (dBuV/m).

3.5.10 Transmitter Radiated Unwanted Emissions (Above 1GHz) for HT20

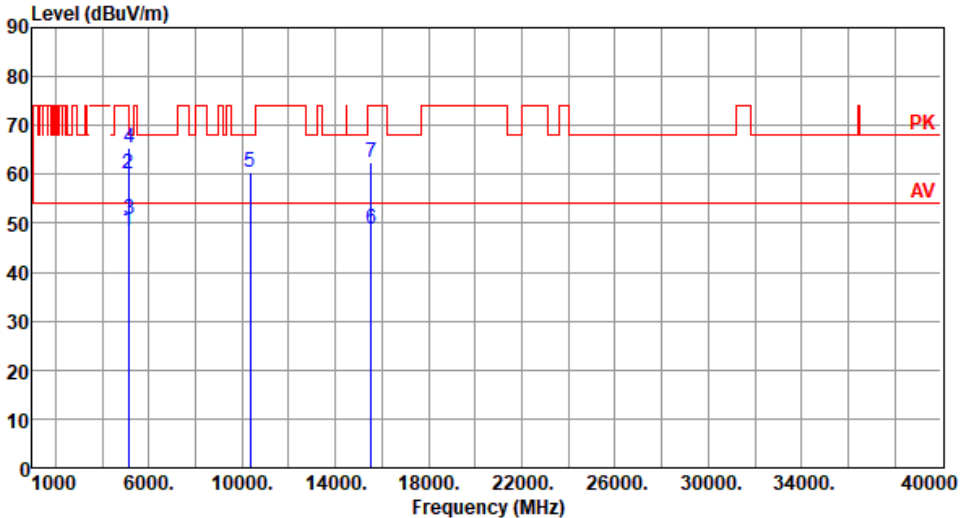
Modulation	HT20	Test Freq. (MHz)	5180																																																																																									
Polarization	Horizontal																																																																																											
																																																																																												
	<table border="1"> <thead> <tr> <th>Freq.</th> <th>Emission level</th> <th>Limit</th> <th>Margin</th> <th>SA reading</th> <th>Factor</th> <th>Remark</th> <th>ANT High</th> <th>Turn Table</th> </tr> <tr> <th>MHz</th> <th>dBuV/m</th> <th>dBuV/m</th> <th>dB</th> <th>dBuV</th> <th>dB</th> <th></th> <th>cm</th> <th>deg</th> </tr> </thead> <tbody> <tr> <td>1</td> <td>5120.00</td> <td>48.34</td> <td>54.00</td> <td>-5.66</td> <td>41.03</td> <td>7.31</td> <td>Average</td> <td>243</td> <td>209</td> </tr> <tr> <td>2</td> <td>5120.00</td> <td>60.25</td> <td>74.00</td> <td>-13.75</td> <td>52.94</td> <td>7.31</td> <td>Peak</td> <td>243</td> <td>209</td> </tr> <tr> <td>3</td> <td>5150.00</td> <td>50.66</td> <td>54.00</td> <td>-3.34</td> <td>43.34</td> <td>7.32</td> <td>Average</td> <td>243</td> <td>334</td> </tr> <tr> <td>4</td> <td>5150.00</td> <td>65.38</td> <td>74.00</td> <td>-8.62</td> <td>58.06</td> <td>7.32</td> <td>Peak</td> <td>243</td> <td>334</td> </tr> <tr> <td>5</td> <td>10360.00</td> <td>60.35</td> <td>68.20</td> <td>-7.85</td> <td>44.26</td> <td>16.09</td> <td>Peak</td> <td>195</td> <td>344</td> </tr> <tr> <td>6</td> <td>15540.00</td> <td>48.93</td> <td>54.00</td> <td>-5.07</td> <td>31.56</td> <td>17.37</td> <td>Average</td> <td>165</td> <td>344</td> </tr> <tr> <td>7</td> <td>15540.00</td> <td>62.50</td> <td>74.00</td> <td>-11.50</td> <td>45.13</td> <td>17.37</td> <td>Peak</td> <td>165</td> <td>344</td> </tr> </tbody> </table>	Freq.	Emission level	Limit	Margin	SA reading	Factor	Remark	ANT High	Turn Table	MHz	dBuV/m	dBuV/m	dB	dBuV	dB		cm	deg	1	5120.00	48.34	54.00	-5.66	41.03	7.31	Average	243	209	2	5120.00	60.25	74.00	-13.75	52.94	7.31	Peak	243	209	3	5150.00	50.66	54.00	-3.34	43.34	7.32	Average	243	334	4	5150.00	65.38	74.00	-8.62	58.06	7.32	Peak	243	334	5	10360.00	60.35	68.20	-7.85	44.26	16.09	Peak	195	344	6	15540.00	48.93	54.00	-5.07	31.56	17.37	Average	165	344	7	15540.00	62.50	74.00	-11.50	45.13	17.37	Peak	165	344			
Freq.	Emission level	Limit	Margin	SA reading	Factor	Remark	ANT High	Turn Table																																																																																				
MHz	dBuV/m	dBuV/m	dB	dBuV	dB		cm	deg																																																																																				
1	5120.00	48.34	54.00	-5.66	41.03	7.31	Average	243	209																																																																																			
2	5120.00	60.25	74.00	-13.75	52.94	7.31	Peak	243	209																																																																																			
3	5150.00	50.66	54.00	-3.34	43.34	7.32	Average	243	334																																																																																			
4	5150.00	65.38	74.00	-8.62	58.06	7.32	Peak	243	334																																																																																			
5	10360.00	60.35	68.20	-7.85	44.26	16.09	Peak	195	344																																																																																			
6	15540.00	48.93	54.00	-5.07	31.56	17.37	Average	165	344																																																																																			
7	15540.00	62.50	74.00	-11.50	45.13	17.37	Peak	165	344																																																																																			
<p>Note 1: Emission Level (dBuV/m) = SA Reading (dBuV/m) + Factor* (dB) *Factor includes antenna factor , cable loss and amplifier gain Note 2: Margin (dB) = Emission level (dBuV/m) – Limit (dBuV/m).</p>																																																																																												

Modulation	HT20	Test Freq. (MHz)	5180
Polarization	Vertical		

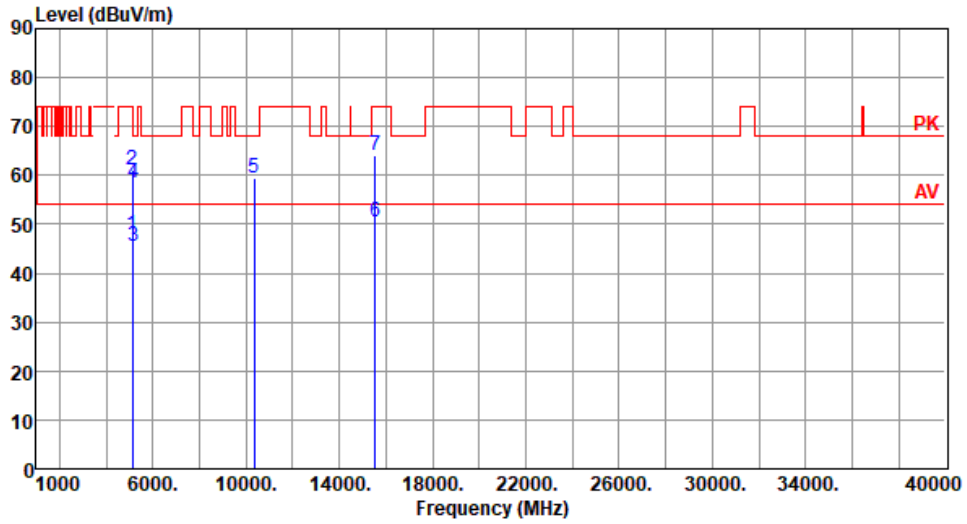

	Freq. MHz	Emission level dBuV/m	Limit dBuV/m	Margin dB	SA reading dBuV	Factor dB	Remark	ANT High cm	Turn Table deg
1	5120.00	47.98	54.00	-6.02	40.67	7.31	Average	149	46
2	5120.00	60.96	74.00	-13.04	53.65	7.31	Peak	149	46
3	5150.00	45.58	54.00	-8.42	38.26	7.32	Average	185	233
4	5150.00	58.43	74.00	-15.57	51.11	7.32	Peak	185	233
5	10360.00	59.35	68.20	-8.85	43.26	16.09	Peak	100	50
6	15540.00	50.62	54.00	-3.38	33.25	17.37	Average	195	322
7	15540.00	63.96	74.00	-10.04	46.59	17.37	Peak	195	322

Note 1: Emission Level (dBuV/m) = SA Reading (dBuV/m) + Factor* (dB)

*Factor includes antenna factor , cable loss and amplifier gain

Note 2: Margin (dB) = Emission level (dBuV/m) – Limit (dBuV/m).

Modulation	HT20	Test Freq. (MHz)	5300
Polarization	Horizontal		

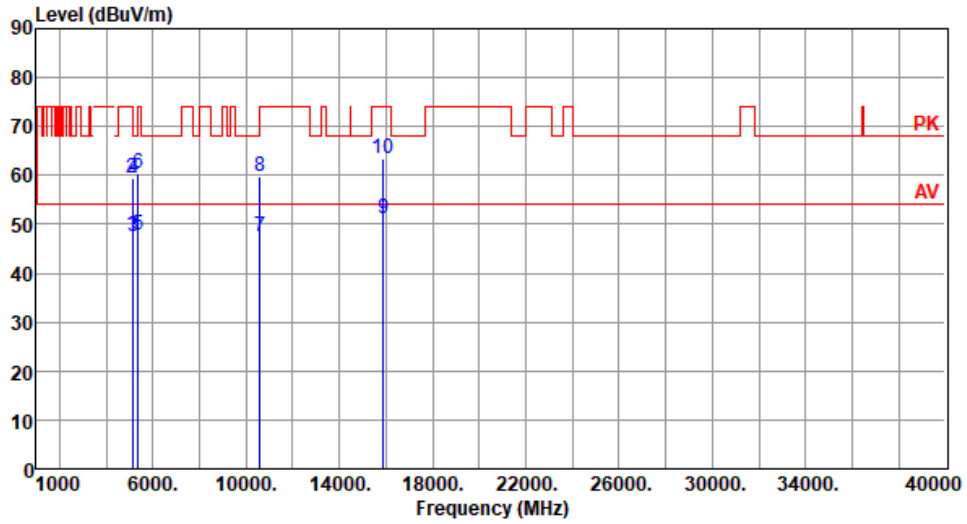

	Freq. MHz	Emission level dBuV/m	Limit dBuV/m	Margin dB	SA reading dBuV	Factor dB	Remark	ANT High cm	Turn Table deg
1	5120.00	47.90	54.00	-6.10	40.59	7.31	Average	278	347
2	5120.00	59.60	74.00	-14.40	52.29	7.31	Peak	278	347
3	5148.00	47.61	54.00	-6.39	40.30	7.31	Average	278	347
4	5148.00	59.51	74.00	-14.49	52.20	7.31	Peak	278	347
5	5350.00	47.89	54.00	-6.11	41.04	6.85	Average	278	347
6	5350.00	60.45	74.00	-13.55	53.60	6.85	Peak	278	347
7	10600.00	47.62	54.00	-6.38	31.26	16.36	Average	100	349
8	10600.00	59.92	74.00	-14.08	43.56	16.36	Peak	100	349
9	15900.00	51.15	54.00	-2.85	34.46	16.69	Average	195	10
10	15900.00	63.38	74.00	-10.62	46.69	16.69	Peak	195	10

Note 1: Emission Level (dBuV/m) = SA Reading (dBuV/m) + Factor* (dB)

*Factor includes antenna factor , cable loss and amplifier gain

Note 2: Margin (dB) = Emission level (dBuV/m) – Limit (dBuV/m).

Modulation	HT20	Test Freq. (MHz)	5300
Polarization	Vertical		

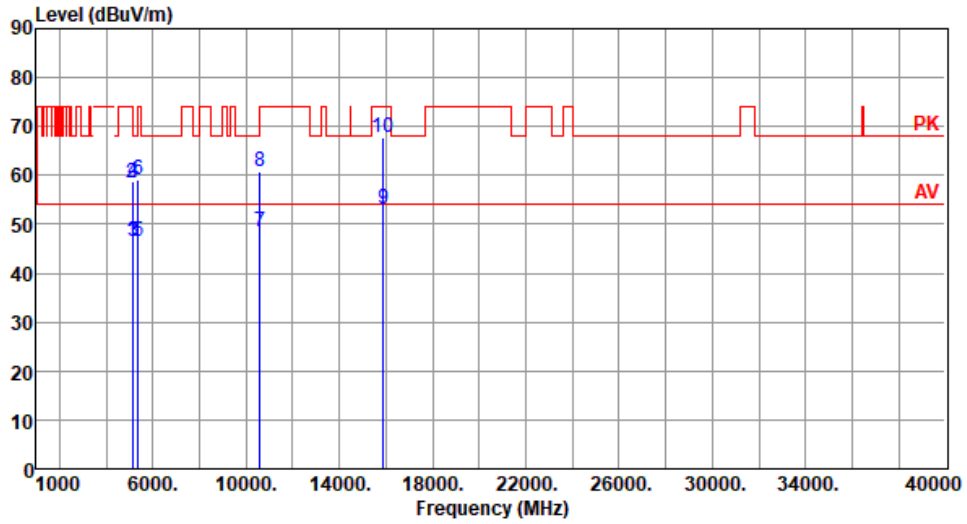

	Freq. MHz	Emission level dBuV/m	Limit dBuV/m	Margin dB	SA reading dBuV	Factor dB	Remark	ANT High cm	Turn Table deg
1	5120.00	46.57	54.00	-7.43	39.26	7.31	Average	155	96
2	5120.00	58.44	74.00	-15.56	51.13	7.31	Peak	155	96
3	5148.00	46.56	54.00	-7.44	39.25	7.31	Average	165	117
4	5148.00	58.77	74.00	-15.23	51.46	7.31	Peak	165	117
5	5350.00	46.34	54.00	-7.66	39.49	6.85	Average	188	237
6	5350.00	58.98	74.00	-15.02	52.13	6.85	Peak	188	237
7	10600.00	48.57	54.00	-5.43	32.21	16.36	Average	100	67
8	10600.00	60.88	74.00	-13.12	44.52	16.36	Peak	100	67
9	15900.00	52.99	54.00	-1.01	36.30	16.69	Average	277	307
10	15900.00	67.60	74.00	-6.40	50.91	16.69	Peak	277	307

Note 1: Emission Level (dBuV/m) = SA Reading (dBuV/m) + Factor* (dB)

*Factor includes antenna factor , cable loss and amplifier gain

Note 2: Margin (dB) = Emission level (dBuV/m) – Limit (dBuV/m).

Modulation	HT20	Test Freq. (MHz)	5320
Polarization	Horizontal		

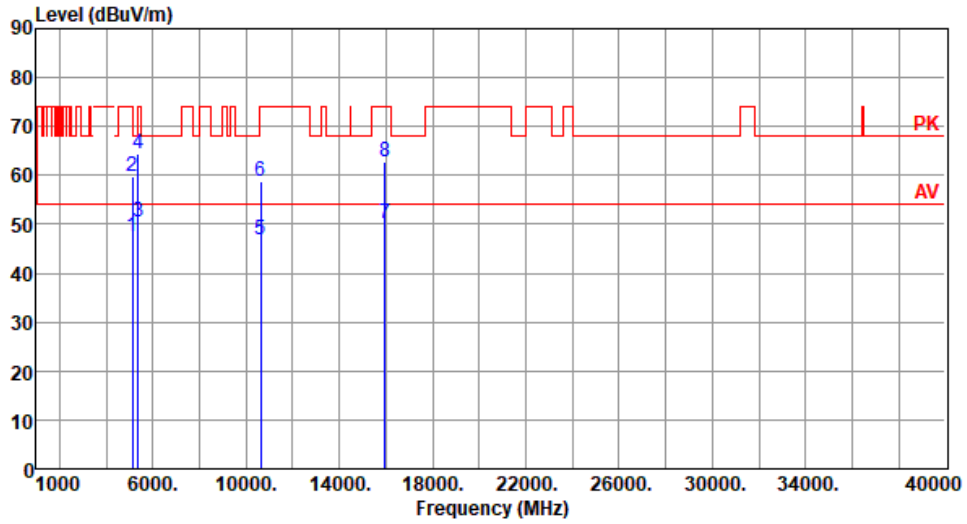

	Freq. MHz	Emission level dBuV/m	Limit dBuV/m	Margin dB	SA reading dBuV	Factor dB	Remark	ANT High cm	Turn Table deg
1	5120.00	47.54	54.00	-6.46	40.23	7.31	Average	245	211
2	5120.00	59.77	74.00	-14.23	52.46	7.31	Peak	245	211
3	5350.00	50.63	54.00	-3.37	43.78	6.85	Average	245	353
4	5350.00	64.40	74.00	-9.60	57.55	6.85	Peak	245	353
5	10640.00	46.83	54.00	-7.17	30.46	16.37	Average	100	350
6	10640.00	58.92	74.00	-15.08	42.55	16.37	Peak	100	350
7	15960.00	49.99	54.00	-4.01	33.46	16.53	Average	199	8
8	15960.00	62.88	74.00	-11.12	46.35	16.53	Peak	199	8

Note 1: Emission Level (dBuV/m) = SA Reading (dBuV/m) + Factor* (dB)

*Factor includes antenna factor , cable loss and amplifier gain

Note 2: Margin (dB) = Emission level (dBuV/m) – Limit (dBuV/m).

Modulation	HT20	Test Freq. (MHz)	5320
Polarization	Vertical		

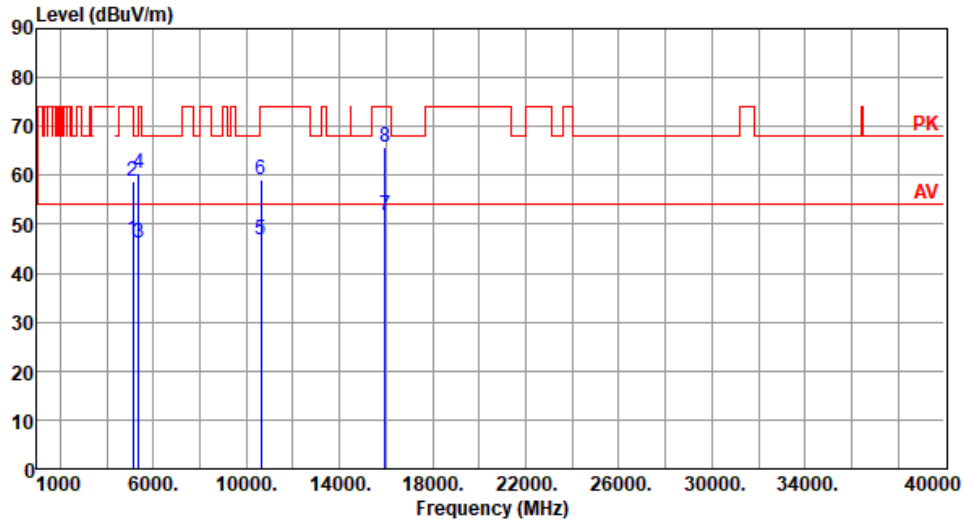

	Freq. MHz	Emission level dBuV/m	Limit dBuV/m	Margin dB	SA reading dBuV	Factor dB	Remark	ANT High cm	Turn Table deg
1	5120.00	46.77	54.00	-7.23	39.46	7.31	Average	146	95
2	5120.00	58.94	74.00	-15.06	51.63	7.31	Peak	146	95
3	5350.00	46.31	54.00	-7.69	39.46	6.85	Average	188	236
4	5350.00	60.32	74.00	-13.68	53.47	6.85	Peak	188	236
5	10640.00	46.88	54.00	-7.12	30.51	16.37	Average	100	50
6	10640.00	58.98	74.00	-15.02	42.61	16.37	Peak	100	50
7	15960.00	51.65	54.00	-2.35	35.12	16.53	Average	276	305
8	15960.00	65.86	74.00	-8.14	49.33	16.53	Peak	276	305

Note 1: Emission Level (dBuV/m) = SA Reading (dBuV/m) + Factor* (dB)

*Factor includes antenna factor , cable loss and amplifier gain

Note 2: Margin (dB) = Emission level (dBuV/m) – Limit (dBuV/m).

Modulation	HT20	Test Freq. (MHz)	5500
Polarization	Horizontal		

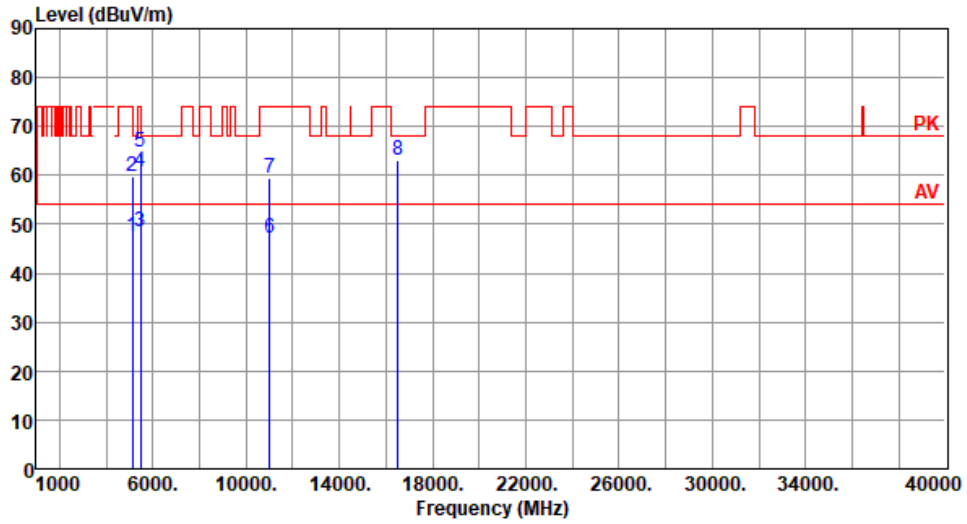

	Freq. MHz	Emission level dBuV/m	Limit dBuV/m	Margin dB	SA reading dBuV	Factor dB	Remark	ANT High cm	Turn Table deg
1	5120.00	47.36	54.00	-6.64	40.05	7.31	Average	255	201
2	5120.00	59.85	74.00	-14.15	52.54	7.31	Peak	255	201
3	5460.00	48.60	54.00	-5.40	41.35	7.25	Average	265	353
4	5460.00	60.76	74.00	-13.24	53.51	7.25	Peak	265	353
5	5470.00	64.82	68.20	-3.38	57.54	7.28	Peak	265	353
6	11000.00	47.02	54.00	-6.98	30.18	16.84	Average	100	315
7	11000.00	59.48	74.00	-14.52	42.64	16.84	Peak	100	315
8	16500.00	62.95	68.20	-5.25	45.31	17.64	Peak	165	317

Note 1: Emission Level (dBuV/m) = SA Reading (dBuV/m) + Factor* (dB)

*Factor includes antenna factor , cable loss and amplifier gain

Note 2: Margin (dB) = Emission level (dBuV/m) – Limit (dBuV/m).

Modulation	HT20	Test Freq. (MHz)	5500
Polarization	Vertical		

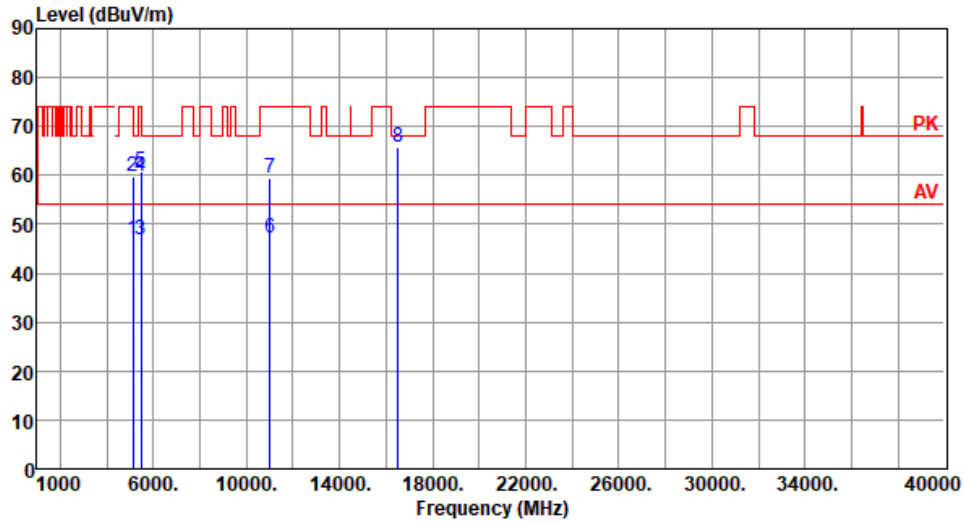

	Freq. MHz	Emission level dBuV/m	Limit dBuV/m	Margin dB	SA reading dBuV	Factor dB	Remark	ANT High cm	Turn Table deg
1	5120.00	46.97	54.00	-7.03	39.66	7.31	Average	146	95
2	5120.00	59.78	74.00	-14.22	52.47	7.31	Peak	146	95
3	5460.00	46.90	54.00	-7.10	39.65	7.25	Average	189	233
4	5460.00	59.71	74.00	-14.29	52.46	7.25	Peak	189	233
5	5470.00	60.75	68.20	-7.45	53.47	7.28	Peak	189	233
6	11000.00	47.10	54.00	-6.90	30.26	16.84	Average	100	60
7	11000.00	59.30	74.00	-14.70	42.46	16.84	Peak	100	60
8	16500.00	65.85	68.20	-2.35	48.21	17.64	Peak	255	312

Note 1: Emission Level (dBuV/m) = SA Reading (dBuV/m) + Factor* (dB)

*Factor includes antenna factor , cable loss and amplifier gain

Note 2: Margin (dB) = Emission level (dBuV/m) – Limit (dBuV/m).

Modulation	HT20	Test Freq. (MHz)	5580
Polarization	Horizontal		

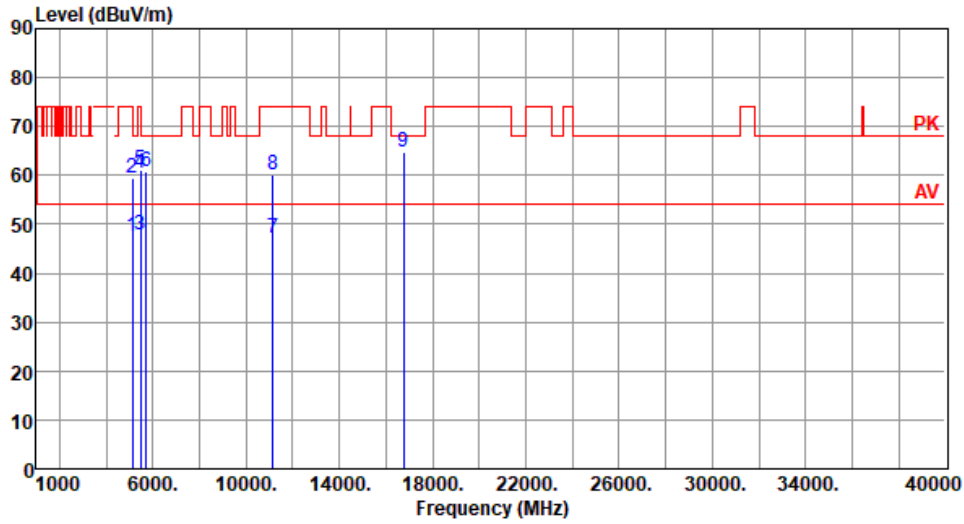

	Freq. MHz	Emission level dBuV/m	Limit dBuV/m	Margin dB	SA reading dBuV	Factor dB	Remark	ANT High cm	Turn Table deg
1	5120.00	47.52	54.00	-6.48	40.21	7.31	Average	254	349
2	5120.00	59.49	74.00	-14.51	52.18	7.31	Peak	254	349
3	5460.00	47.96	54.00	-6.04	40.71	7.25	Average	254	349
4	5460.00	60.40	74.00	-13.60	53.15	7.25	Peak	254	349
5	5470.00	61.20	68.20	-7.00	53.92	7.28	Peak	254	349
6	5725.00	60.89	68.20	-7.31	53.23	7.66	Peak	254	349
7	11160.00	47.05	54.00	-6.95	30.46	16.59	Average	177	315
8	11160.00	60.15	74.00	-13.85	43.56	16.59	Peak	177	315
9	16740.00	64.77	68.20	-3.43	46.54	18.23	Peak	166	318

Note 1: Emission Level (dBuV/m) = SA Reading (dBuV/m) + Factor* (dB)

*Factor includes antenna factor , cable loss and amplifier gain

Note 2: Margin (dB) = Emission level (dBuV/m) – Limit (dBuV/m).

Modulation	HT20	Test Freq. (MHz)	5580
Polarization	Vertical		

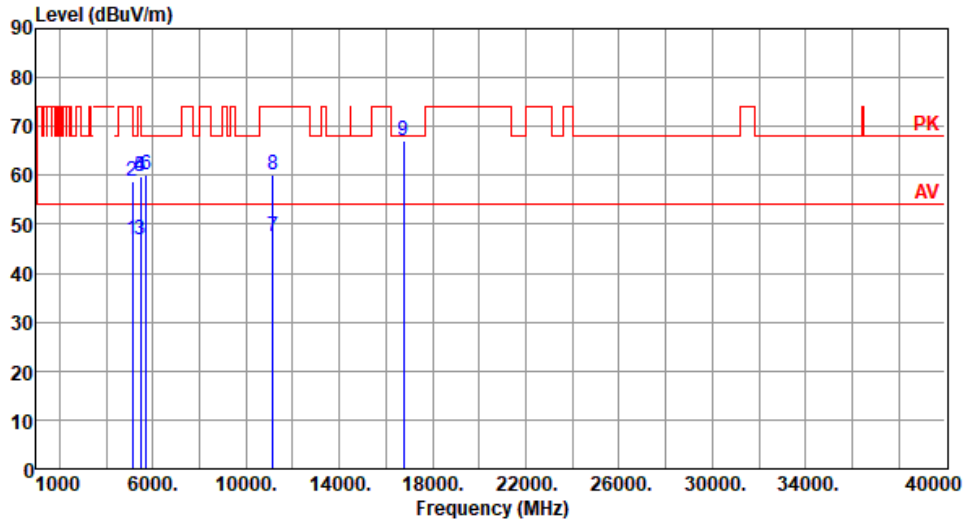

	Freq. MHz	Emission level dBuV/m	Limit dBuV/m	Margin dB	SA reading dBuV	Factor dB	Remark	ANT High cm	Turn Table deg
1	5120.00	46.77	54.00	-7.23	39.46	7.31	Average	155	86
2	5120.00	58.90	74.00	-15.10	51.59	7.31	Peak	155	86
3	5460.00	46.71	54.00	-7.29	39.46	7.25	Average	187	235
4	5460.00	59.84	74.00	-14.16	52.59	7.25	Peak	187	235
5	5470.00	59.76	68.20	-8.44	52.48	7.28	Peak	187	235
6	5725.00	59.99	68.20	-8.21	52.33	7.66	Peak	187	235
7	11160.00	47.45	54.00	-6.55	30.86	16.59	Average	100	62
8	11160.00	60.14	74.00	-13.86	43.55	16.59	Peak	100	62
9	16740.00	67.13	68.20	-1.07	48.90	18.23	Peak	254	310

Note 1: Emission Level (dBuV/m) = SA Reading (dBuV/m) + Factor* (dB)

*Factor includes antenna factor , cable loss and amplifier gain

Note 2: Margin (dB) = Emission level (dBuV/m) – Limit (dBuV/m).

Modulation	HT20	Test Freq. (MHz)	5700
Polarization	Horizontal		

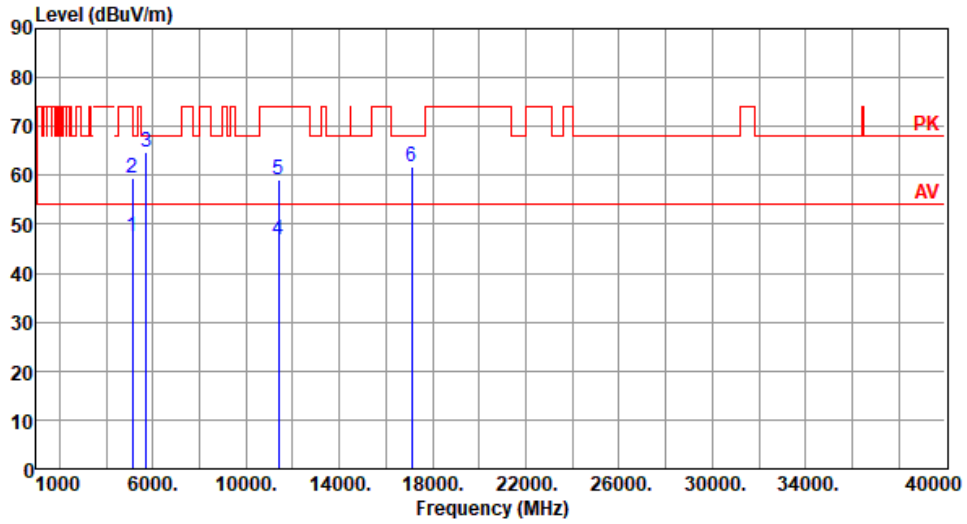

	Freq. MHz	Emission level dBuV/m	Limit dBuV/m	Margin dB	SA reading dBuV	Factor dB	Remark	ANT High cm	Turn Table deg
1	5120.00	47.49	54.00	-6.51	40.18	7.31	Average	245	202
2	5120.00	59.53	74.00	-14.47	52.22	7.31	Peak	245	202
3	5725.00	64.90	68.20	-3.30	57.24	7.66	Peak	240	185
4	11400.00	46.87	54.00	-7.13	30.14	16.73	Average	100	40
5	11400.00	59.18	74.00	-14.82	42.45	16.73	Peak	100	40
6	17100.00	61.75	68.20	-6.45	43.51	18.24	Peak	100	319

Note 1: Emission Level (dBuV/m) = SA Reading (dBuV/m) + Factor* (dB)

*Factor includes antenna factor , cable loss and amplifier gain

Note 2: Margin (dB) = Emission level (dBuV/m) – Limit (dBuV/m).

Modulation	HT20	Test Freq. (MHz)	5700
Polarization	Vertical		

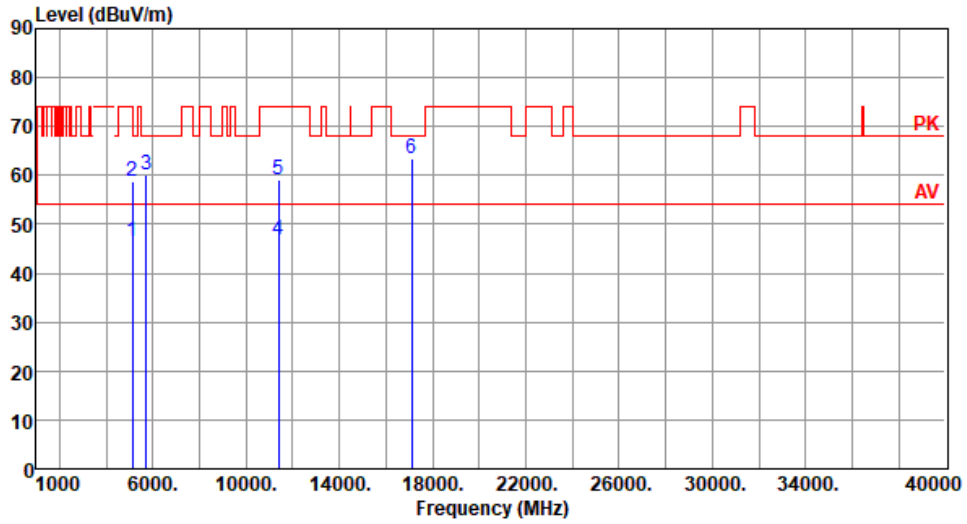

	Freq. MHz	Emission level dBuV/m	Limit dBuV/m	Margin dB	SA reading dBuV	Factor dB	Remark	ANT High cm	Turn Table deg
1	5120.00	46.61	54.00	-7.39	39.30	7.31	Average	144	92
2	5120.00	58.77	74.00	-15.23	51.46	7.31	Peak	144	92
3	5725.00	59.96	68.20	-8.24	52.30	7.66	Peak	188	236
4	11400.00	46.97	54.00	-7.03	30.24	16.73	Average	100	40
5	11400.00	59.20	74.00	-14.80	42.47	16.73	Peak	100	40
6	17100.00	63.59	68.20	-4.61	45.35	18.24	Peak	245	316

Note 1: Emission Level (dBuV/m) = SA Reading (dBuV/m) + Factor* (dB)

*Factor includes antenna factor , cable loss and amplifier gain

Note 2: Margin (dB) = Emission level (dBuV/m) – Limit (dBuV/m).

Modulation	HT20	Test Freq. (MHz)	5720
Polarization	Horizontal		

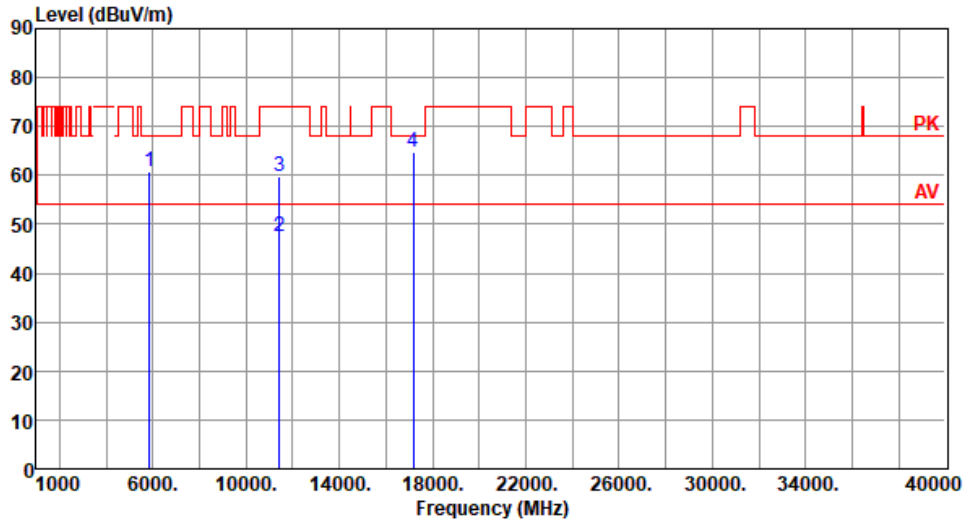

	Freq. MHz	Emission level dBuV/m	Limit dBuV/m	Margin dB	SA reading dBuV	Factor dB	Remark	ANT High cm	Turn Table deg
1	5850.00	60.68	68.20	-7.52	52.66	8.02	Peak	238	181
2	11440.00	47.46	54.00	-6.54	30.72	16.74	Average	100	39
3	11440.00	59.82	74.00	-14.18	43.08	16.74	Peak	100	39
4	17160.00	64.79	68.20	-3.41	46.41	18.38	Peak	145	34

Note 1: Emission Level (dBuV/m) = SA Reading (dBuV/m) + Factor* (dB)

*Factor includes antenna factor , cable loss and amplifier gain

Note 2: Margin (dB) = Emission level (dBuV/m) – Limit (dBuV/m).

Modulation	HT20	Test Freq. (MHz)	5720
Polarization	Vertical		

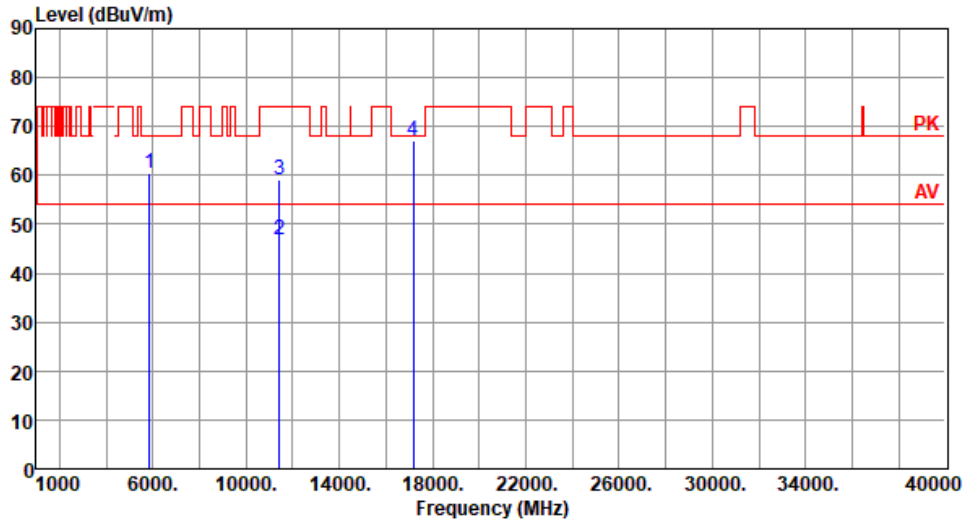

	Freq. MHz	Emission level dBuV/m	Limit dBuV/m	Margin dB	SA reading dBuV	Factor dB	Remark	ANT High cm	Turn Table deg
1	5850.00	60.28	68.20	-7.92	52.26	8.02	Peak	191	234
2	11440.00	46.88	54.00	-7.12	30.14	16.74	Average	100	15
3	11440.00	59.15	74.00	-14.85	42.41	16.74	Peak	100	15
4	17160.00	67.09	68.20	-1.11	48.71	18.38	Peak	296	311

Note 1: Emission Level (dBuV/m) = SA Reading (dBuV/m) + Factor* (dB)

*Factor includes antenna factor , cable loss and amplifier gain

Note 2: Margin (dB) = Emission level (dBuV/m) – Limit (dBuV/m).

Modulation	HT20	Test Freq. (MHz)	5785
Polarization	Horizontal		

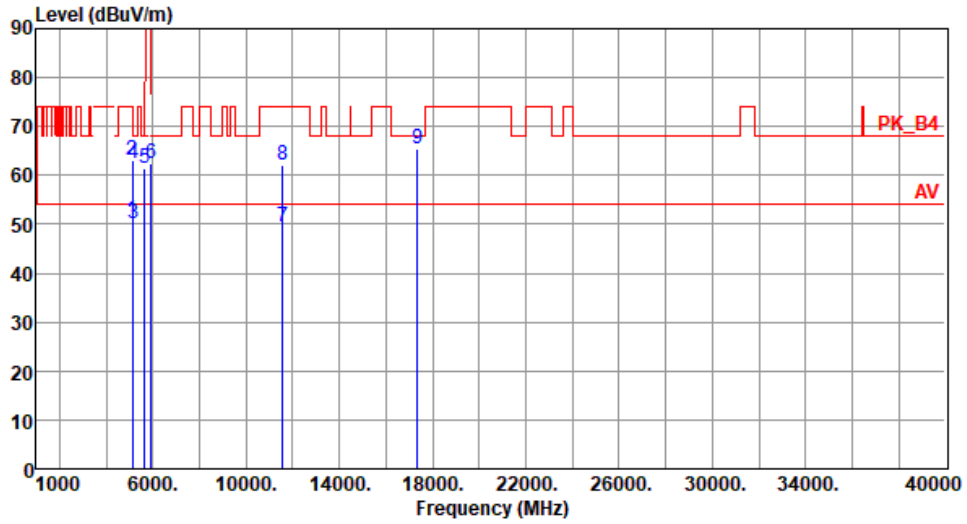

	Freq. MHz	Emission level dBuV/m	Limit dBuV/m	Margin dB	SA reading dBuV	Factor dB	Remark	ANT High cm	Turn Table deg
1	5120.00	50.79	54.00	-3.21	43.48	7.31	Average	246	201
2	5120.00	62.97	74.00	-11.03	55.66	7.31	Peak	246	201
3	5148.00	50.17	54.00	-3.83	42.86	7.31	Average	246	349
4	5148.00	62.42	74.00	-11.58	55.11	7.31	Peak	246	349
5	5650.00	61.52	68.20	-6.68	54.13	7.39	Peak	246	349
6	5925.00	62.36	68.20	-5.84	54.29	8.07	Peak	246	349
7	11570.00	49.37	54.00	-4.63	32.76	16.61	Average	177	303
8	11570.00	62.20	74.00	-11.80	45.59	16.61	Peak	177	303
9	17355.00	65.47	68.20	-2.73	46.24	19.23	Peak	145	308

Note 1: Emission Level (dBuV/m) = SA Reading (dBuV/m) + Factor* (dB)

*Factor includes antenna factor , cable loss and amplifier gain

Note 2: Margin (dB) = Emission level (dBuV/m) – Limit (dBuV/m).

Modulation	HT20	Test Freq. (MHz)	5785
Polarization	Vertical		

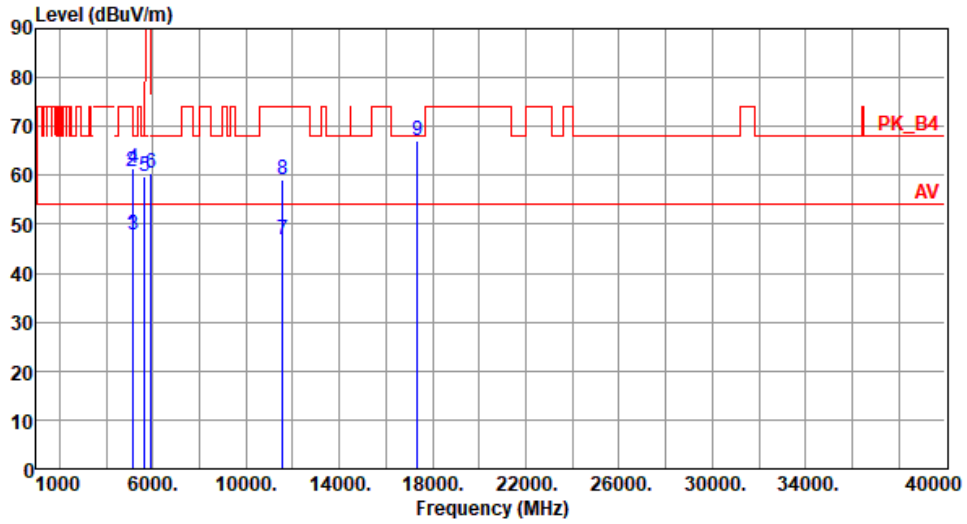

	Freq. MHz	Emission level dBuV/m	Limit dBuV/m	Margin dB	SA reading dBuV	Factor dB	Remark	ANT High cm	Turn Table deg
1	5120.00	47.77	54.00	-6.23	40.46	7.31	Average	146	79
2	5120.00	60.87	74.00	-13.13	53.56	7.31	Peak	146	79
3	5148.00	47.66	54.00	-6.34	40.35	7.31	Average	146	79
4	5148.00	61.30	74.00	-12.70	53.99	7.31	Peak	146	79
5	5650.00	59.85	68.20	-8.35	52.46	7.39	Peak	183	230
6	5925.00	60.51	68.20	-7.69	52.44	8.07	Peak	183	230
7	11570.00	46.83	54.00	-7.17	30.22	16.61	Average	100	55
8	11570.00	59.22	74.00	-14.78	42.61	16.61	Peak	100	55
9	17355.00	67.03	68.20	-1.17	47.80	19.23	Peak	271	311

Note 1: Emission Level (dBuV/m) = SA Reading (dBuV/m) + Factor* (dB)

*Factor includes antenna factor , cable loss and amplifier gain

Note 2: Margin (dB) = Emission level (dBuV/m) – Limit (dBuV/m).

Modulation	HT20	Test Freq. (MHz)	5825
Polarization	Horizontal		

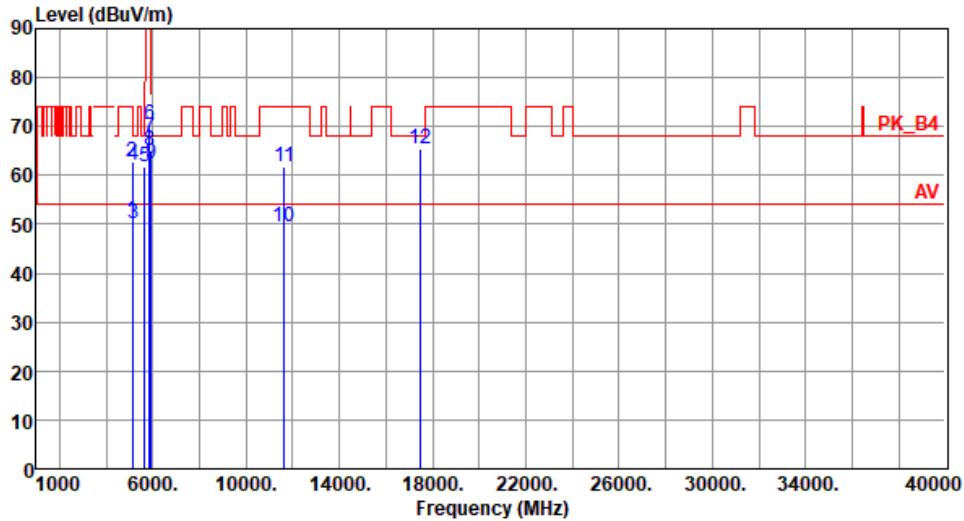

	Freq. MHz	Emission level dBuV/m	Limit dBuV/m	Margin dB	SA reading dBuV	Factor dB	Remark	ANT High cm	Turn Table deg
1	5120.00	50.79	54.00	-3.21	43.48	7.31	Average	268	203
2	5120.00	62.70	74.00	-11.30	55.39	7.31	Peak	268	203
3	5148.00	50.14	54.00	-3.86	42.83	7.31	Average	271	347
4	5148.00	62.17	74.00	-11.83	54.86	7.31	Peak	271	347
5	5650.00	61.65	68.20	-6.55	54.26	7.39	Peak	271	347
6	5850.00	70.36	122.20	-51.84	62.34	8.02	Peak	271	347
7	5855.00	67.78	110.80	-43.02	59.76	8.02	Peak	271	347
8	5875.00	65.20	105.20	-40.00	57.17	8.03	Peak	271	347
9	5925.00	62.43	68.20	-5.77	54.36	8.07	Peak	271	347
10	11650.00	49.40	54.00	-4.60	33.02	16.38	Average	266	305
11	11650.00	61.71	74.00	-12.29	45.33	16.38	Peak	266	305
12	17475.00	65.40	68.20	-2.80	45.66	19.74	Peak	177	319

Note 1: Emission Level (dBuV/m) = SA Reading (dBuV/m) + Factor* (dB)

*Factor includes antenna factor , cable loss and amplifier gain

Note 2: Margin (dB) = Emission level (dBuV/m) – Limit (dBuV/m).

Modulation	HT20	Test Freq. (MHz)	5825
Polarization	Vertical		

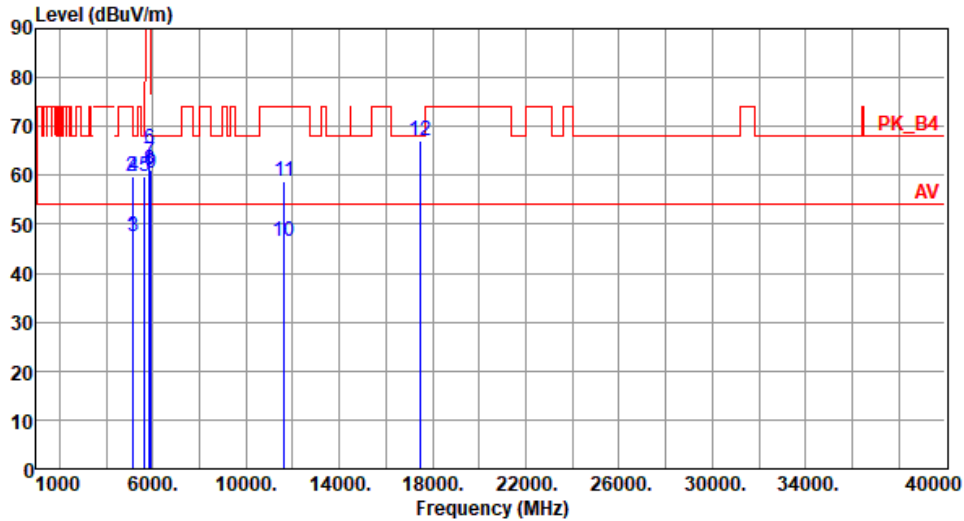

	Freq. MHz	Emission level dBuV/m	Limit dBuV/m	Margin dB	SA reading dBuV	Factor dB	Remark	ANT High cm	Turn Table deg
1	5120.00	47.47	54.00	-6.53	40.16	7.31	Average	146	95
2	5120.00	59.87	74.00	-14.13	52.56	7.31	Peak	146	95
3	5148.00	47.56	54.00	-6.44	40.25	7.31	Average	146	95
4	5148.00	59.87	74.00	-14.13	52.56	7.31	Peak	146	95
5	5650.00	59.89	68.20	-8.31	52.50	7.39	Peak	185	234
6	5850.00	65.48	122.20	-56.72	57.46	8.02	Peak	185	234
7	5855.00	62.71	110.80	-48.09	54.69	8.02	Peak	185	234
8	5875.00	61.14	105.20	-44.06	53.11	8.03	Peak	185	234
9	5925.00	60.30	68.20	-7.90	52.23	8.07	Peak	185	234
10	11650.00	46.63	54.00	-7.37	30.25	16.38	Average	100	30
11	11650.00	58.84	74.00	-15.16	42.46	16.38	Peak	100	30
12	17475.00	67.19	68.20	-1.01	47.45	19.74	Peak	228	312

Note 1: Emission Level (dBuV/m) = SA Reading (dBuV/m) + Factor* (dB)

*Factor includes antenna factor , cable loss and amplifier gain

Note 2: Margin (dB) = Emission level (dBuV/m) – Limit (dBuV/m).

3.5.11 Transmitter Radiated Unwanted Emissions (Above 1GHz) for HT40

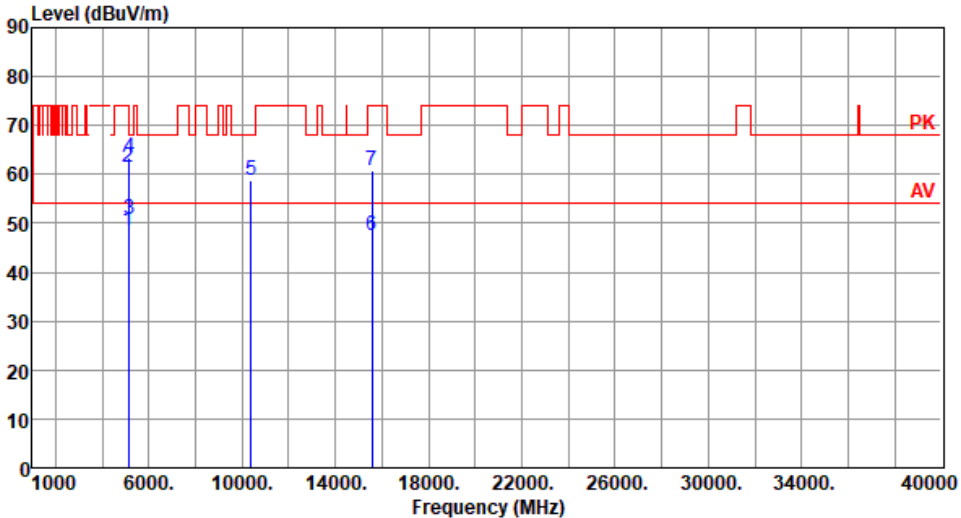
Modulation	HT40	Test Freq. (MHz)	5190																																																																																														
Polarization	Horizontal																																																																																																
																																																																																																	
	<table border="1"> <thead> <tr> <th>Freq.</th> <th>Emission level</th> <th>Limit</th> <th>Margin</th> <th>SA reading</th> <th>Factor</th> <th>Remark</th> <th>ANT High</th> <th>Turn Table</th> </tr> <tr> <th>MHz</th> <th>dBuV/m</th> <th>dBuV/m</th> <th>dB</th> <th>dBuV</th> <th>dB</th> <th></th> <th>cm</th> <th>deg</th> </tr> </thead> <tbody> <tr> <td>1</td> <td>5120.00</td> <td>48.54</td> <td>54.00</td> <td>-5.46</td> <td>41.23</td> <td>7.31</td> <td>Average</td> <td>226</td> <td>191</td> </tr> <tr> <td>2</td> <td>5120.00</td> <td>61.57</td> <td>74.00</td> <td>-12.43</td> <td>54.26</td> <td>7.31</td> <td>Peak</td> <td>226</td> <td>191</td> </tr> <tr> <td>3</td> <td>5150.00</td> <td>50.77</td> <td>54.00</td> <td>-3.23</td> <td>43.45</td> <td>7.32</td> <td>Average</td> <td>226</td> <td>345</td> </tr> <tr> <td>4</td> <td>5150.00</td> <td>63.52</td> <td>74.00</td> <td>-10.48</td> <td>56.20</td> <td>7.32</td> <td>Peak</td> <td>226</td> <td>345</td> </tr> <tr> <td>5</td> <td>10380.00</td> <td>58.69</td> <td>68.20</td> <td>-9.51</td> <td>42.51</td> <td>16.18</td> <td>Peak</td> <td>100</td> <td>60</td> </tr> <tr> <td>6</td> <td>15570.00</td> <td>47.58</td> <td>54.00</td> <td>-6.42</td> <td>30.26</td> <td>17.32</td> <td>Average</td> <td>100</td> <td>55</td> </tr> <tr> <td>7</td> <td>15570.00</td> <td>60.79</td> <td>74.00</td> <td>-13.21</td> <td>43.47</td> <td>17.32</td> <td>Peak</td> <td>100</td> <td>55</td> </tr> </tbody> </table>	Freq.	Emission level	Limit	Margin	SA reading	Factor	Remark	ANT High	Turn Table	MHz	dBuV/m	dBuV/m	dB	dBuV	dB		cm	deg	1	5120.00	48.54	54.00	-5.46	41.23	7.31	Average	226	191	2	5120.00	61.57	74.00	-12.43	54.26	7.31	Peak	226	191	3	5150.00	50.77	54.00	-3.23	43.45	7.32	Average	226	345	4	5150.00	63.52	74.00	-10.48	56.20	7.32	Peak	226	345	5	10380.00	58.69	68.20	-9.51	42.51	16.18	Peak	100	60	6	15570.00	47.58	54.00	-6.42	30.26	17.32	Average	100	55	7	15570.00	60.79	74.00	-13.21	43.47	17.32	Peak	100	55								
Freq.	Emission level	Limit	Margin	SA reading	Factor	Remark	ANT High	Turn Table																																																																																									
MHz	dBuV/m	dBuV/m	dB	dBuV	dB		cm	deg																																																																																									
1	5120.00	48.54	54.00	-5.46	41.23	7.31	Average	226	191																																																																																								
2	5120.00	61.57	74.00	-12.43	54.26	7.31	Peak	226	191																																																																																								
3	5150.00	50.77	54.00	-3.23	43.45	7.32	Average	226	345																																																																																								
4	5150.00	63.52	74.00	-10.48	56.20	7.32	Peak	226	345																																																																																								
5	10380.00	58.69	68.20	-9.51	42.51	16.18	Peak	100	60																																																																																								
6	15570.00	47.58	54.00	-6.42	30.26	17.32	Average	100	55																																																																																								
7	15570.00	60.79	74.00	-13.21	43.47	17.32	Peak	100	55																																																																																								
<p>Note 1: Emission Level (dBuV/m) = SA Reading (dBuV/m) + Factor* (dB) *Factor includes antenna factor , cable loss and amplifier gain Note 2: Margin (dB) = Emission level (dBuV/m) – Limit (dBuV/m).</p>																																																																																																	

Modulation	HT40	Test Freq. (MHz)	5190
Polarization	Vertical		

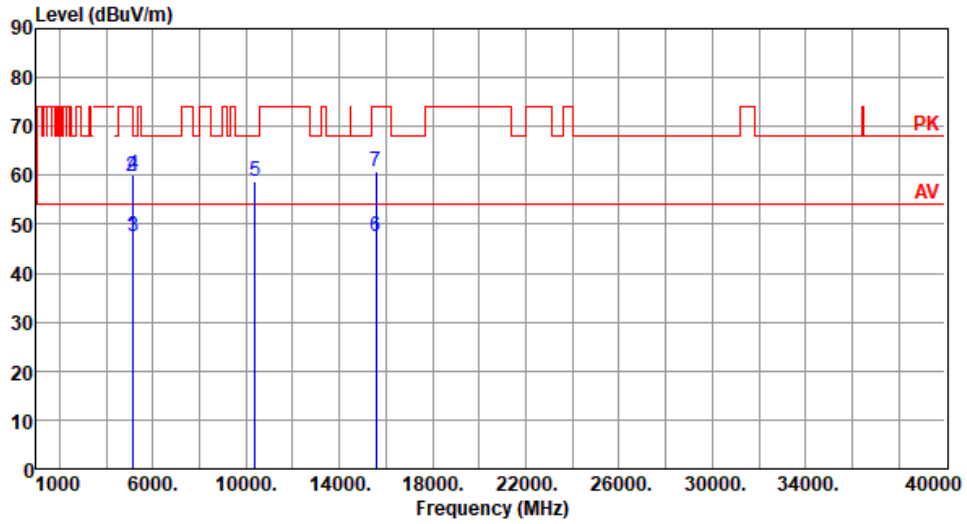

	Freq. MHz	Emission level dBuV/m	Limit dBuV/m	Margin dB	SA reading dBuV	Factor dB	Remark	ANT High cm	Turn Table deg
1	5120.00	47.62	54.00	-6.38	40.31	7.31	Average	148	83
2	5120.00	59.86	74.00	-14.14	52.55	7.31	Peak	148	83
3	5150.00	47.52	54.00	-6.48	40.20	7.32	Average	148	83
4	5150.00	60.19	74.00	-13.81	52.87	7.32	Peak	148	83
5	10380.00	58.78	68.20	-9.42	42.60	16.18	Peak	100	20
6	15570.00	47.47	54.00	-6.53	30.15	17.32	Average	100	30
7	15570.00	60.78	74.00	-13.22	43.46	17.32	Peak	100	30

Note 1: Emission Level (dBuV/m) = SA Reading (dBuV/m) + Factor* (dB)

*Factor includes antenna factor , cable loss and amplifier gain

Note 2: Margin (dB) = Emission level (dBuV/m) – Limit (dBuV/m).

Modulation	HT40	Test Freq. (MHz)	5310
Polarization	Horizontal		

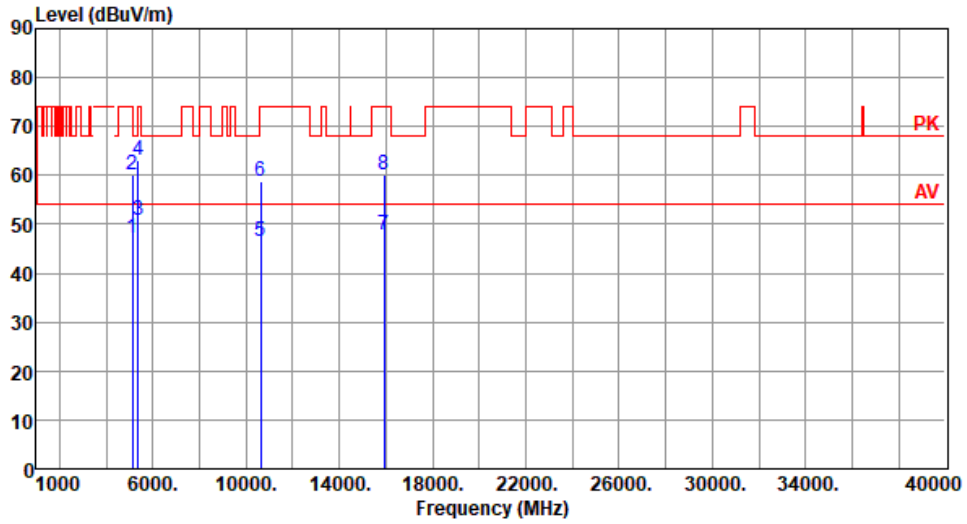

	Freq. MHz	Emission level dBuV/m	Limit dBuV/m	Margin dB	SA reading dBuV	Factor dB	Remark	ANT High cm	Turn Table deg
1	5120.00	47.28	54.00	-6.72	39.97	7.31	Average	239	205
2	5120.00	60.09	74.00	-13.91	52.78	7.31	Peak	239	205
3	5350.00	50.79	54.00	-3.21	43.94	6.85	Average	239	344
4	5350.00	62.97	74.00	-11.03	56.12	6.85	Peak	239	344
5	10620.00	46.61	54.00	-7.39	30.24	16.37	Average	100	50
6	10620.00	58.82	74.00	-15.18	42.45	16.37	Peak	100	50
7	15930.00	47.87	54.00	-6.13	31.26	16.61	Average	100	40
8	15930.00	60.15	74.00	-13.85	43.54	16.61	Peak	100	40

Note 1: Emission Level (dBuV/m) = SA Reading (dBuV/m) + Factor* (dB)

*Factor includes antenna factor , cable loss and amplifier gain

Note 2: Margin (dB) = Emission level (dBuV/m) – Limit (dBuV/m).

Modulation	HT40	Test Freq. (MHz)	5310
Polarization	Vertical		

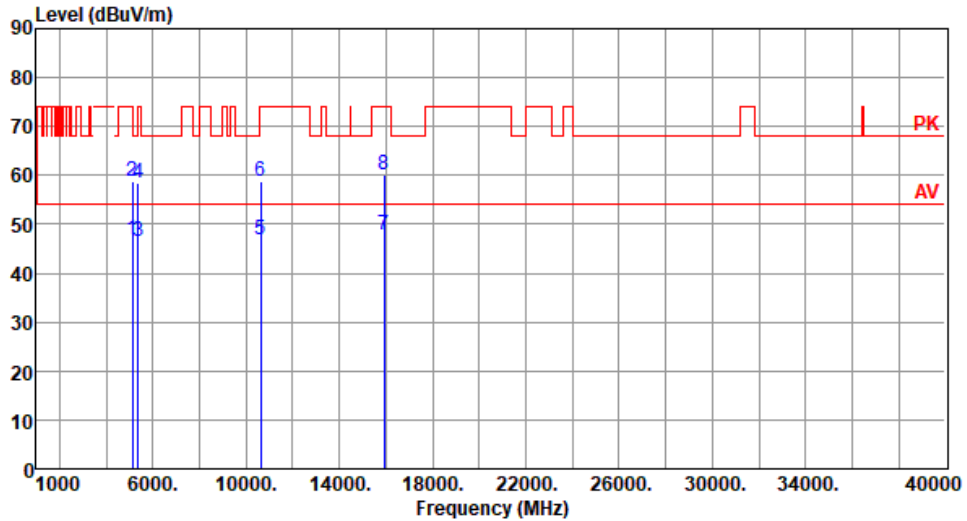

	Freq. MHz	Emission level dBuV/m	Limit dBuV/m	Margin dB	SA reading dBuV	Factor dB	Remark	ANT High cm	Turn Table deg
1	5120.00	46.87	54.00	-7.13	39.56	7.31	Average	149	88
2	5120.00	58.77	74.00	-15.23	51.46	7.31	Peak	149	88
3	5350.00	46.44	54.00	-7.56	39.59	6.85	Average	188	237
4	5350.00	58.43	74.00	-15.57	51.58	6.85	Peak	188	237
5	10620.00	46.72	54.00	-7.28	30.35	16.37	Average	100	100
6	10620.00	58.92	74.00	-15.08	42.55	16.37	Peak	100	100
7	15930.00	47.92	54.00	-6.08	31.31	16.61	Average	100	30
8	15930.00	60.25	74.00	-13.75	43.64	16.61	Peak	100	30

Note 1: Emission Level (dBuV/m) = SA Reading (dBuV/m) + Factor* (dB)

*Factor includes antenna factor , cable loss and amplifier gain

Note 2: Margin (dB) = Emission level (dBuV/m) – Limit (dBuV/m).

Modulation	HT40	Test Freq. (MHz)	5510
Polarization	Horizontal		

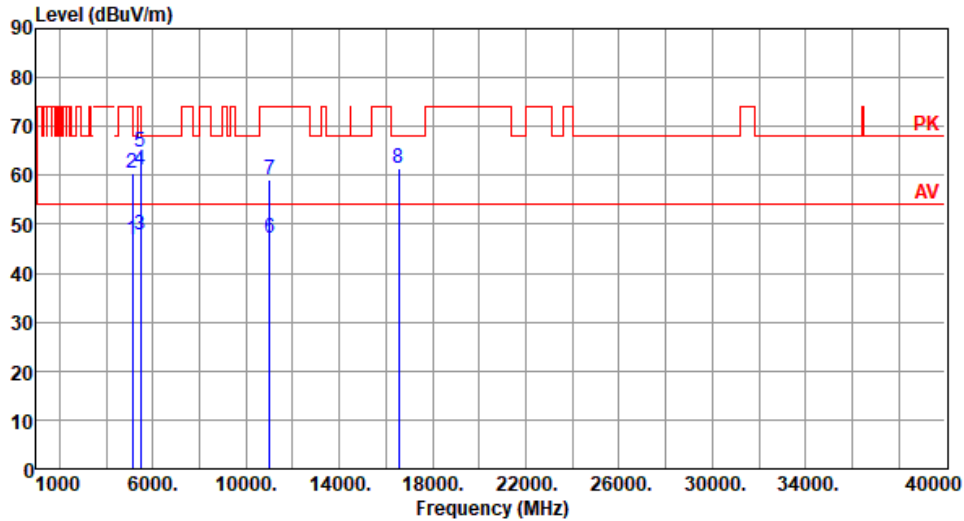

	Freq. MHz	Emission level dBuV/m	Limit dBuV/m	Margin dB	SA reading dBuV	Factor dB	Remark	ANT High cm	Turn Table deg
1	5120.00	46.89	54.00	-7.11	39.58	7.31	Average	257	204
2	5120.00	60.49	74.00	-13.51	53.18	7.31	Peak	257	204
3	5460.00	47.97	54.00	-6.03	40.72	7.25	Average	257	189
4	5460.00	61.23	74.00	-12.77	53.98	7.25	Peak	257	189
5	5470.00	64.84	68.20	-3.36	57.56	7.28	Peak	257	189
6	11020.00	47.06	54.00	-6.94	30.25	16.81	Average	100	20
7	11020.00	59.28	74.00	-14.72	42.47	16.81	Peak	100	20
8	16530.00	61.39	68.20	-6.81	43.56	17.83	Peak	100	40

Note 1: Emission Level (dBuV/m) = SA Reading (dBuV/m) + Factor* (dB)

*Factor includes antenna factor , cable loss and amplifier gain

Note 2: Margin (dB) = Emission level (dBuV/m) – Limit (dBuV/m).

Modulation	HT40	Test Freq. (MHz)	5510
Polarization	Vertical		

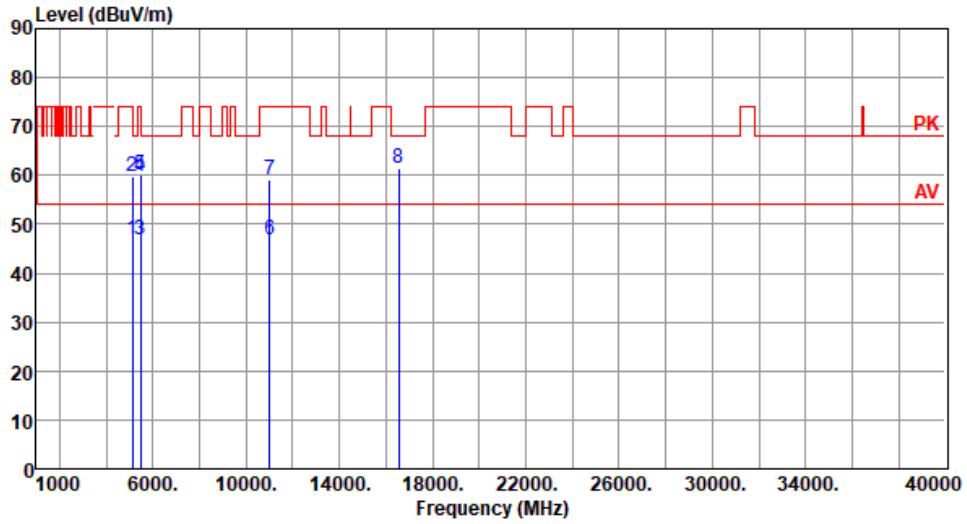

	Freq. MHz	Emission level dBuV/m	Limit dBuV/m	Margin dB	SA reading dBuV	Factor dB	Remark	ANT High cm	Turn Table deg
1	5120.00	46.77	54.00	-7.23	39.46	7.31	Average	187	234
2	5120.00	59.77	74.00	-14.23	52.46	7.31	Peak	187	234
3	5460.00	46.81	54.00	-7.19	39.56	7.25	Average	187	234
4	5460.00	59.71	74.00	-14.29	52.46	7.25	Peak	187	234
5	5470.00	59.97	68.20	-8.23	52.69	7.28	Peak	187	234
6	11020.00	46.99	54.00	-7.01	30.18	16.81	Average	100	30
7	11020.00	59.03	74.00	-14.97	42.22	16.81	Peak	100	30
8	16530.00	61.29	68.20	-6.91	43.46	17.83	Peak	100	50

Note 1: Emission Level (dBuV/m) = SA Reading (dBuV/m) + Factor* (dB)

*Factor includes antenna factor , cable loss and amplifier gain

Note 2: Margin (dB) = Emission level (dBuV/m) – Limit (dBuV/m).

Modulation	HT40	Test Freq. (MHz)	5670
Polarization	Horizontal		

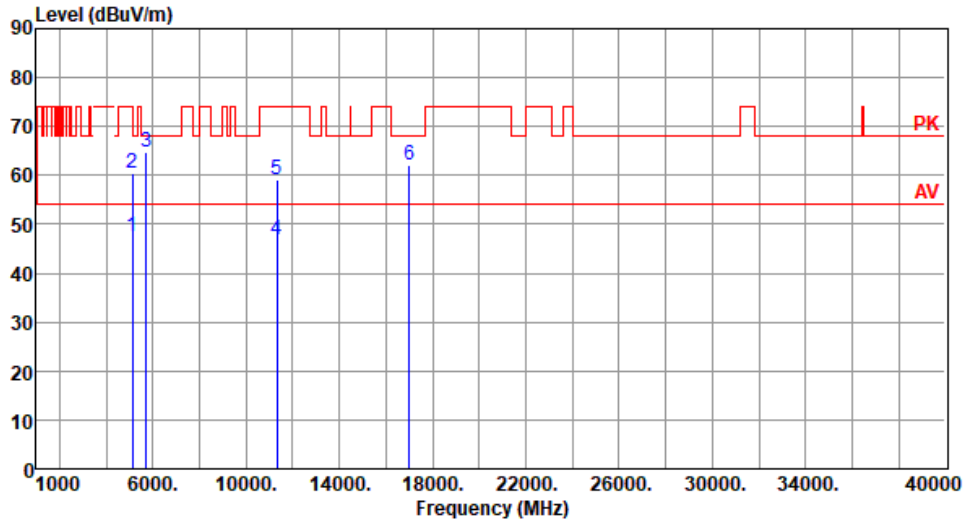

	Freq. MHz	Emission level dBuV/m	Limit dBuV/m	Margin dB	SA reading dBuV	Factor dB	Remark	ANT High cm	Turn Table deg
1	5120.00	47.57	54.00	-6.43	40.26	7.31	Average	243	205
2	5120.00	60.44	74.00	-13.56	53.13	7.31	Peak	243	205
3	5725.00	64.87	68.20	-3.33	57.21	7.66	Peak	252	351
4	11340.00	46.83	54.00	-7.17	30.25	16.58	Average	100	90
5	11340.00	59.04	74.00	-14.96	42.46	16.58	Peak	100	90
6	17010.00	62.21	68.20	-5.99	43.55	18.66	Peak	160	320

Note 1: Emission Level (dBuV/m) = SA Reading (dBuV/m) + Factor* (dB)

*Factor includes antenna factor , cable loss and amplifier gain

Note 2: Margin (dB) = Emission level (dBuV/m) – Limit (dBuV/m).

Modulation	HT40	Test Freq. (MHz)	5670
Polarization	Vertical		

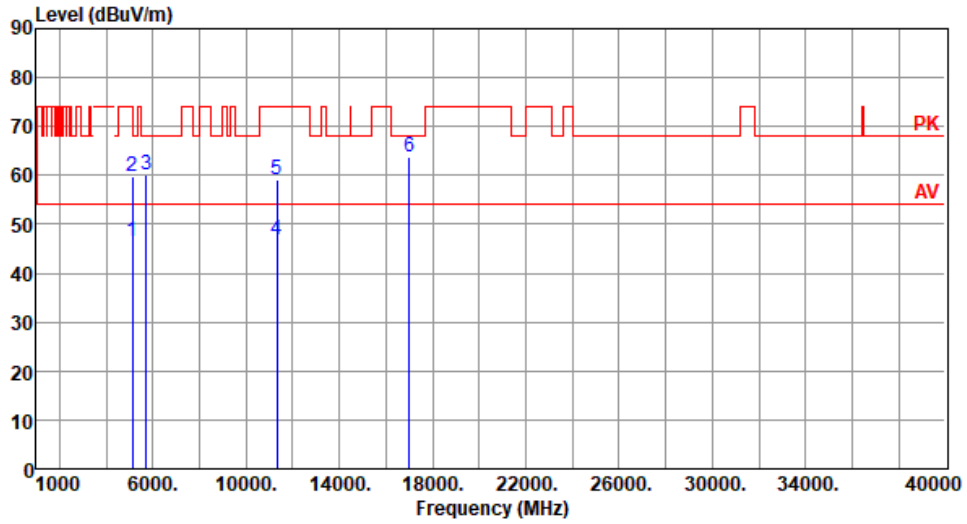

	Freq. MHz	Emission level dBuV/m	Limit dBuV/m	Margin dB	SA reading dBuV	Factor dB	Remark	ANT High cm	Turn Table deg
1	5120.00	46.51	54.00	-7.49	39.20	7.31	Average	191	238
2	5120.00	59.87	74.00	-14.13	52.56	7.31	Peak	191	238
3	5725.00	60.11	68.20	-8.09	52.45	7.66	Peak	191	238
4	11340.00	46.74	54.00	-7.26	30.16	16.58	Average	100	70
5	11340.00	59.16	74.00	-14.84	42.58	16.58	Peak	100	70
6	17010.00	63.91	68.20	-4.29	45.25	18.66	Peak	255	311

Note 1: Emission Level (dBuV/m) = SA Reading (dBuV/m) + Factor* (dB)

*Factor includes antenna factor , cable loss and amplifier gain

Note 2: Margin (dB) = Emission level (dBuV/m) – Limit (dBuV/m).

Modulation	HT40	Test Freq. (MHz)	5710
Polarization	Horizontal		

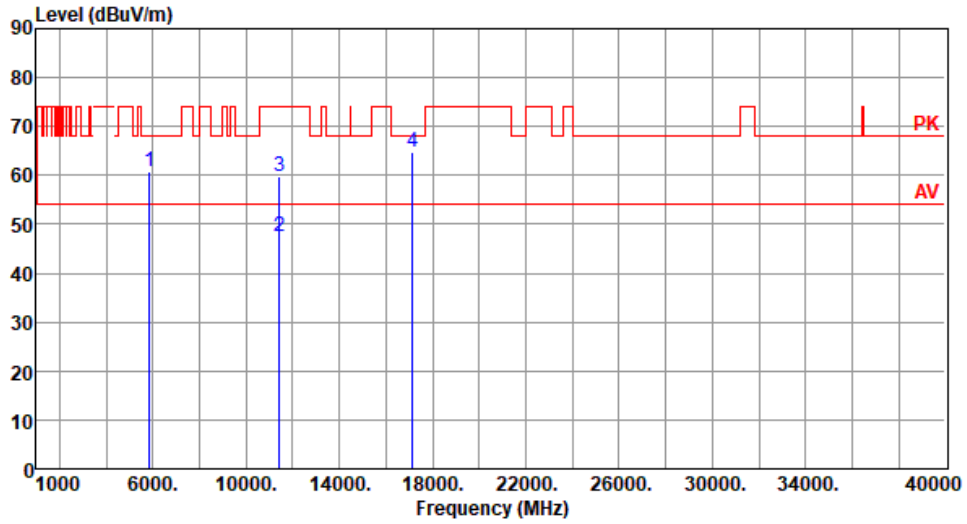

	Freq. MHz	Emission level dBuV/m	Limit dBuV/m	Margin dB	SA reading dBuV	Factor dB	Remark	ANT High cm	Turn Table deg
1	5850.00	60.69	68.20	-7.51	52.67	8.02	Peak	252	352
2	11420.00	47.48	54.00	-6.52	30.75	16.73	Average	100	54
3	11420.00	59.62	74.00	-14.38	42.89	16.73	Peak	100	54
4	17130.00	64.75	68.20	-3.45	46.45	18.30	Peak	145	32

Note 1: Emission Level (dBuV/m) = SA Reading (dBuV/m) + Factor* (dB)

*Factor includes antenna factor , cable loss and amplifier gain

Note 2: Margin (dB) = Emission level (dBuV/m) – Limit (dBuV/m).

Modulation	HT40	Test Freq. (MHz)	5710
Polarization	Vertical		

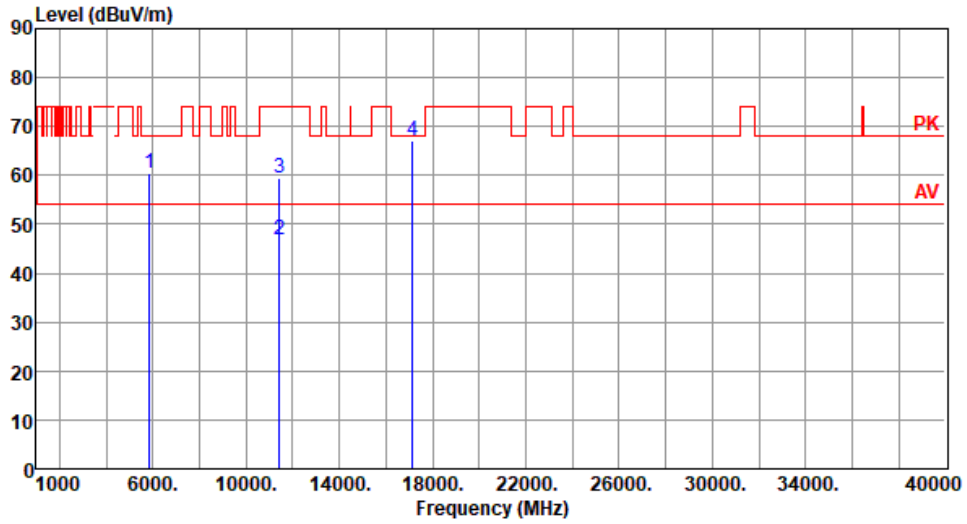

	Freq. MHz	Emission level dBuV/m	Limit dBuV/m	Margin dB	SA reading dBuV	Factor dB	Remark	ANT High cm	Turn Table deg
1	5850.00	60.32	68.20	-7.88	52.30	8.02	Peak	193	241
2	11420.00	46.98	54.00	-7.02	30.25	16.73	Average	100	41
3	11420.00	59.35	74.00	-14.65	42.62	16.73	Peak	100	41
4	17130.00	67.11	68.20	-1.09	48.81	18.30	Peak	296	311

Note 1: Emission Level (dBuV/m) = SA Reading (dBuV/m) + Factor* (dB)

*Factor includes antenna factor , cable loss and amplifier gain

Note 2: Margin (dB) = Emission level (dBuV/m) – Limit (dBuV/m).

Modulation	HT40	Test Freq. (MHz)	5795
Polarization	Horizontal		

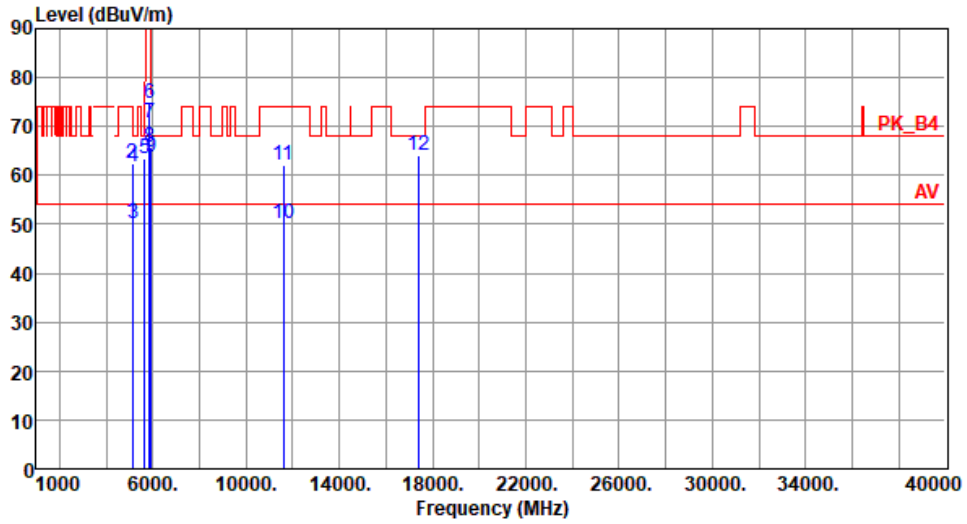

	Freq. MHz	Emission level dBuV/m	Limit dBuV/m	Margin dB	SA reading dBuV	Factor dB	Remark	ANT High cm	Turn Table deg
1	5120.00	50.46	54.00	-3.54	43.15	7.31	Average	253	203
2	5120.00	62.49	74.00	-11.51	55.18	7.31	Peak	253	203
3	5148.00	50.17	54.00	-3.83	42.86	7.31	Average	264	350
4	5148.00	61.89	74.00	-12.11	54.58	7.31	Peak	264	350
5	5650.00	63.40	68.20	-4.80	56.01	7.39	Peak	264	350
6	5850.00	74.58	122.20	-47.62	66.56	8.02	Peak	264	350
7	5855.00	70.81	110.80	-39.99	62.79	8.02	Peak	264	350
8	5875.00	65.69	105.20	-39.51	57.66	8.03	Peak	264	350
9	5925.00	63.64	68.20	-4.56	55.57	8.07	Peak	264	350
10	11590.00	50.16	54.00	-3.84	33.59	16.57	Average	170	301
11	11590.00	62.22	74.00	-11.78	45.65	16.57	Peak	170	301
12	17385.00	64.21	68.20	-3.99	44.86	19.35	Peak	149	305

Note 1: Emission Level (dBuV/m) = SA Reading (dBuV/m) + Factor* (dB)

*Factor includes antenna factor , cable loss and amplifier gain

Note 2: Margin (dB) = Emission level (dBuV/m) – Limit (dBuV/m).

Modulation	HT40	Test Freq. (MHz)	5795
Polarization	Vertical		

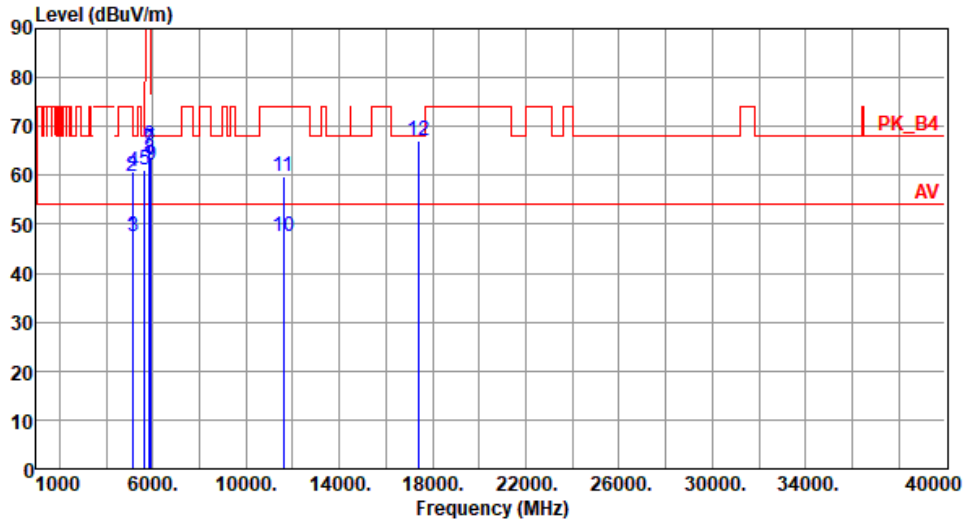

	Freq. MHz	Emission level dBuV/m	Limit dBuV/m	Margin dB	SA reading dBuV	Factor dB	Remark	ANT High cm	Turn Table deg
1	5120.00	47.57	54.00	-6.43	40.26	7.31	Average	149	88
2	5120.00	59.90	74.00	-14.10	52.59	7.31	Peak	149	88
3	5148.00	47.46	54.00	-6.54	40.15	7.31	Average	146	88
4	5148.00	60.79	74.00	-13.21	53.48	7.31	Peak	146	88
5	5650.00	60.95	68.20	-7.25	53.56	7.39	Peak	138	89
6	5850.00	66.08	122.20	-56.12	58.06	8.02	Peak	138	89
7	5855.00	65.34	110.80	-45.46	57.32	8.02	Peak	138	89
8	5875.00	63.31	105.20	-41.89	55.28	8.03	Peak	138	89
9	5925.00	62.20	68.20	-6.00	54.13	8.07	Peak	138	89
10	11590.00	47.42	54.00	-6.58	30.85	16.57	Average	100	69
11	11590.00	59.71	74.00	-14.29	43.14	16.57	Peak	100	69
12	17385.00	67.01	68.20	-1.19	47.66	19.35	Peak	251	323

Note 1: Emission Level (dBuV/m) = SA Reading (dBuV/m) + Factor* (dB)

*Factor includes antenna factor , cable loss and amplifier gain

Note 2: Margin (dB) = Emission level (dBuV/m) – Limit (dBuV/m).

Configuration 3 : Antenna WLAN_1000146

3.5.12 Transmitter Radiated Unwanted Emissions (Below 1GHz)

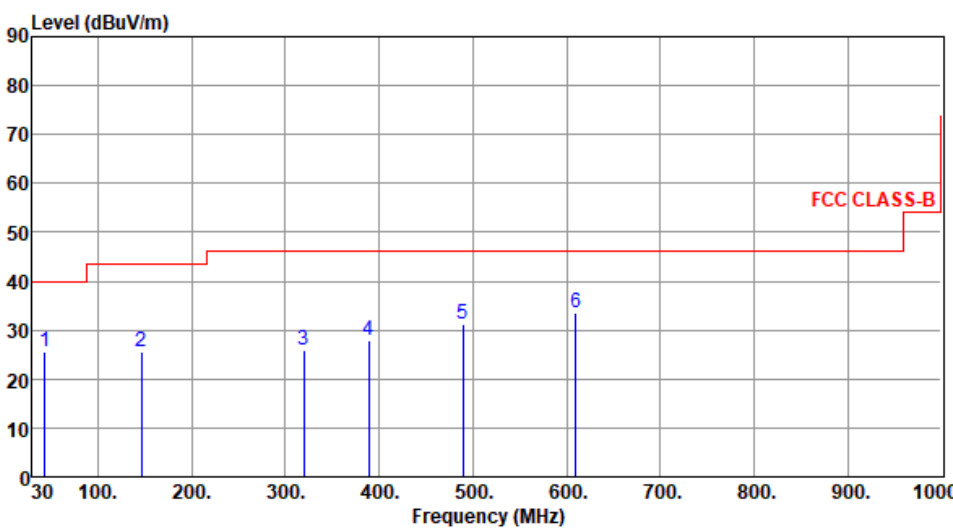
Modulation	11a	Test Freq. (MHz)	5240						
Polarization	Horizontal								
									
	Freq. MHz	Emission level dBuV/m	Limit dBuV/m	Margin dB	SA reading dBuV	Factor dB	Remark	ANT High cm	Turn Table deg
1	43.58	25.58	40.00	-14.42	34.36	-8.78	Peak	---	---
2	146.40	25.45	43.50	-18.05	34.52	-9.07	Peak	---	---
3	320.03	25.99	46.00	-20.01	33.81	-7.82	Peak	---	---
4	388.90	27.88	46.00	-18.12	33.89	-6.01	Peak	---	---
5	489.78	31.20	46.00	-14.80	34.58	-3.38	Peak	---	---
6	610.06	33.42	46.00	-12.58	33.45	-0.03	Peak	---	---

Note 1: Emission Level (dBuV/m) = SA Reading (dBuV/m) + Factor* (dB)
 *Factor includes antenna factor , cable loss and amplifier gain
 Note 2: Margin (dB) = Emission level (dBuV/m) – Limit (dBuV/m).
 Note 3: All spurious emissions below 30MHz are more than 20 dB below the limit.

Modulation	11a	Test Freq. (MHz)	5240
Polarization	Vertical		

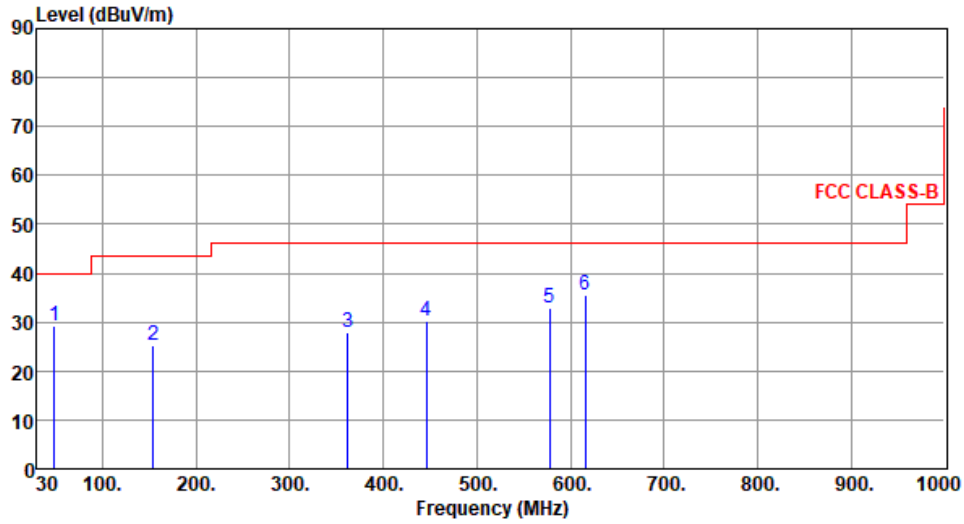

	Freq. MHz	Emission level dBuV/m	Limit dBuV/m	Margin dB	SA reading dBuV	Factor dB	Remark	ANT High cm	Turn Table deg
1	48.43	29.10	40.00	-10.90	37.96	-8.86	Peak	---	---
2	154.16	25.11	43.50	-18.39	34.04	-8.93	Peak	---	---
3	361.74	27.77	46.00	-18.23	34.69	-6.92	Peak	---	---
4	446.13	30.27	46.00	-15.73	34.20	-3.93	Peak	---	---
5	578.05	33.01	46.00	-12.99	34.41	-1.40	Peak	---	---
6	615.88	35.54	46.00	-10.46	35.65	-0.11	Peak	---	---

Note 1: Emission Level (dBuV/m) = SA Reading (dBuV/m) + Factor* (dB)

*Factor includes antenna factor , cable loss and amplifier gain

Note 2: Margin (dB) = Emission level (dBuV/m) – Limit (dBuV/m).

Note 3: All spurious emissions below 30MHz are more than 20 dB below the limit.

Modulation	HT40	Test Freq. (MHz)	5795
Polarization	Horizontal		

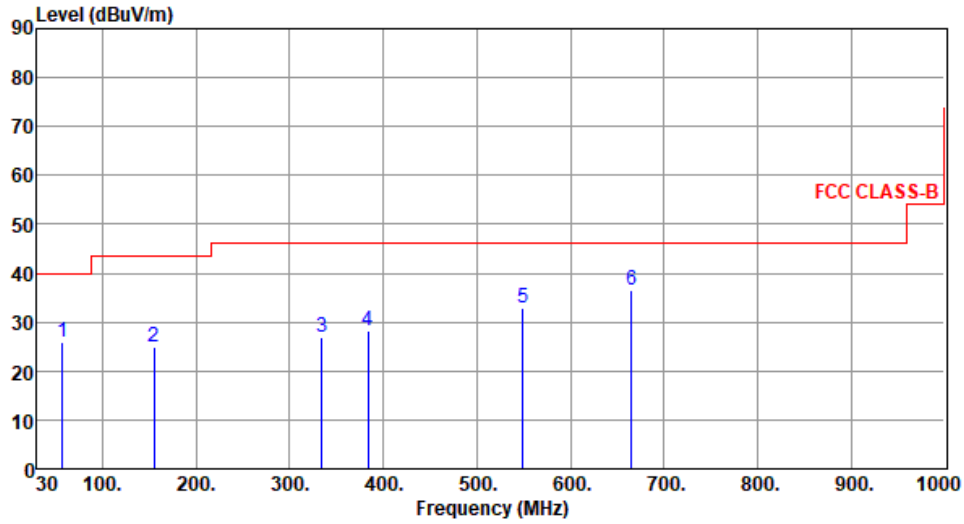

	Freq. MHz	Emission level dBuV/m	Limit dBuV/m	Margin dB	SA reading dBuV	Factor dB	Remark	ANT High cm	Turn Table deg
1	57.16	26.05	40.00	-13.95	35.11	-9.06	Peak	---	---
2	155.13	24.78	43.50	-18.72	33.72	-8.94	Peak	---	---
3	334.58	26.97	46.00	-19.03	34.21	-7.24	Peak	---	---
4	384.05	28.09	46.00	-17.91	34.22	-6.13	Peak	---	---
5	548.95	32.77	46.00	-13.23	35.06	-2.29	Peak	---	---
6	665.35	36.66	46.00	-9.34	35.98	0.68	Peak	---	---

Note 1: Emission Level (dBuV/m) = SA Reading (dBuV/m) + Factor* (dB)

*Factor includes antenna factor , cable loss and amplifier gain

Note 2: Margin (dB) = Emission level (dBuV/m) – Limit (dBuV/m).

Note 3: All spurious emissions below 30MHz are more than 20 dB below the limit.

Modulation	HT40	Test Freq. (MHz)	5795
Polarization	Vertical		

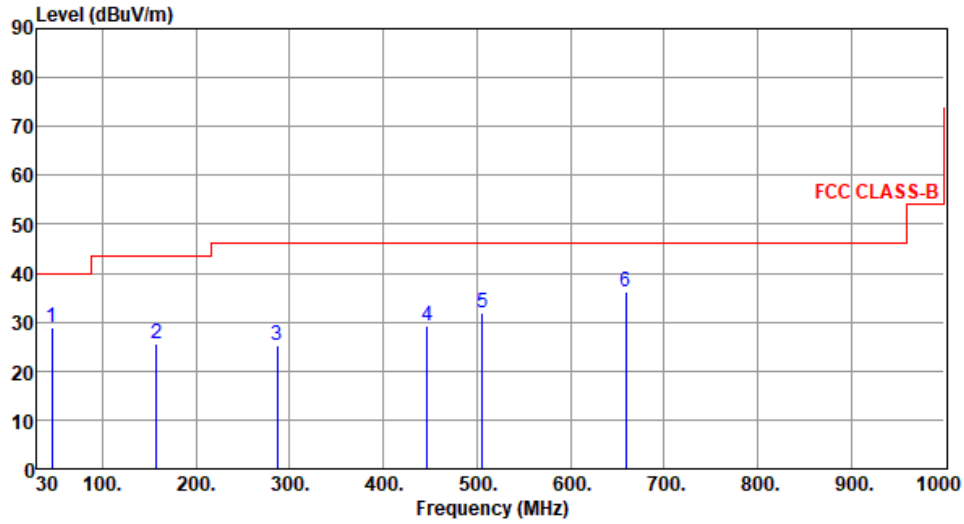

	Freq. MHz	Emission level dBuV/m	Limit dBuV/m	Margin dB	SA reading dBuV	Factor dB	Remark	ANT High cm	Turn Table deg
1	45.52	29.01	40.00	-10.99	37.77	-8.76	Peak	---	---
2	158.04	25.44	43.50	-18.06	34.46	-9.02	Peak	---	---
3	287.05	25.34	46.00	-20.66	34.15	-8.81	Peak	---	---
4	447.10	29.17	46.00	-16.83	33.12	-3.95	Peak	---	---
5	506.27	31.81	46.00	-14.19	34.78	-2.97	Peak	---	---
6	659.53	36.23	46.00	-9.77	35.66	0.57	Peak	---	---

Note 1: Emission Level (dBuV/m) = SA Reading (dBuV/m) + Factor* (dB)

*Factor includes antenna factor , cable loss and amplifier gain

Note 2: Margin (dB) = Emission level (dBuV/m) – Limit (dBuV/m).

Note 3: All spurious emissions below 30MHz are more than 20 dB below the limit.

3.5.13 Transmitter Radiated Unwanted Emissions (Above 1GHz) for 11a

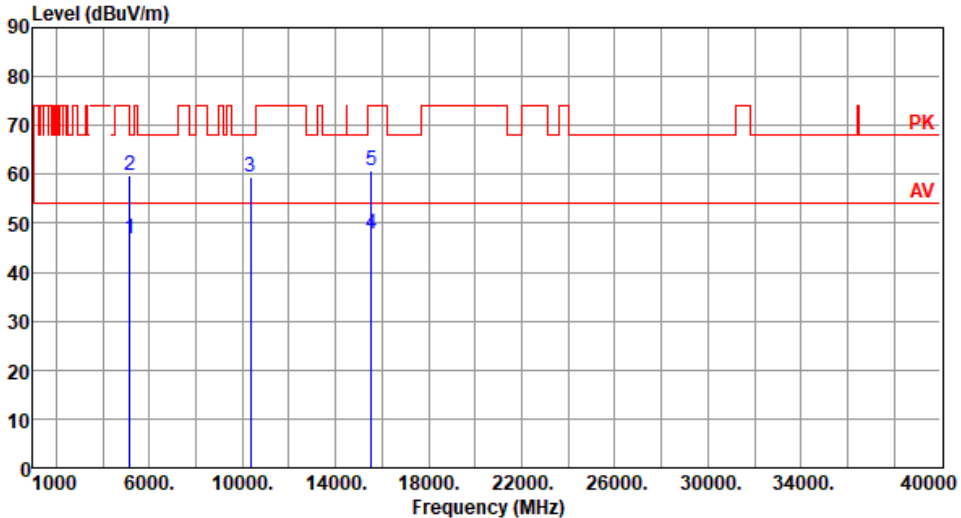
Modulation	11a	Test Freq. (MHz)	5180						
Polarization	Horizontal								
									
	Freq. MHz	Emission level dBuV/m	Limit dBuV/m	Margin dB	SA reading dBuV	Factor dB	Remark	ANT High cm	Turn Table deg
1	5150.00	46.92	54.00	-7.08	39.60	7.32	Average	115	234
2	5150.00	59.76	74.00	-14.24	52.44	7.32	Peak	115	234
3	10360.00	59.55	68.20	-8.65	43.46	16.09	Peak	100	20
4	15540.00	47.83	54.00	-6.17	30.46	17.37	Average	100	7
5	15540.00	60.93	74.00	-13.07	43.56	17.37	Peak	100	7
<p>Note 1: Emission Level (dBuV/m) = SA Reading (dBuV/m) + Factor* (dB) *Factor includes antenna factor , cable loss and amplifier gain Note 2: Margin (dB) = Emission level (dBuV/m) – Limit (dBuV/m).</p>									

Modulation	11a	Test Freq. (MHz)	5180
Polarization	Vertical		

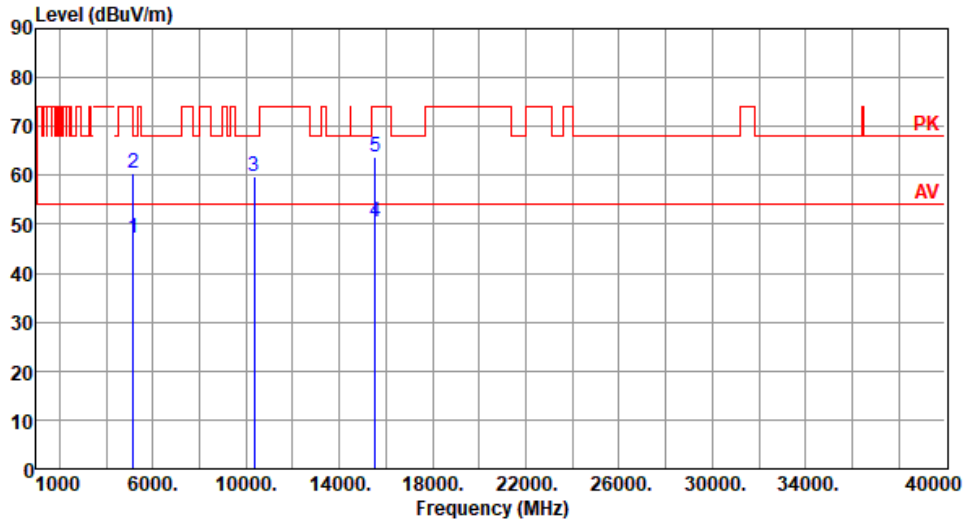

	Freq. MHz	Emission level dBuV/m	Limit dBuV/m	Margin dB	SA reading dBuV	Factor dB	Remark	ANT High cm	Turn Table deg
1	5150.00	47.10	54.00	-6.90	39.78	7.32	Average	211	282
2	5150.00	60.29	74.00	-13.71	52.97	7.32	Peak	211	282
3	10360.00	59.65	68.20	-8.55	43.56	16.09	Peak	100	30
4	15540.00	50.60	54.00	-3.40	33.23	17.37	Average	126	333
5	15540.00	63.75	74.00	-10.25	46.38	17.37	Peak	126	333

Note 1: Emission Level (dBuV/m) = SA Reading (dBuV/m) + Factor* (dB)

*Factor includes antenna factor , cable loss and amplifier gain

Note 2: Margin (dB) = Emission level (dBuV/m) – Limit (dBuV/m).

Modulation	11a	Test Freq. (MHz)	5240
Polarization	Horizontal		

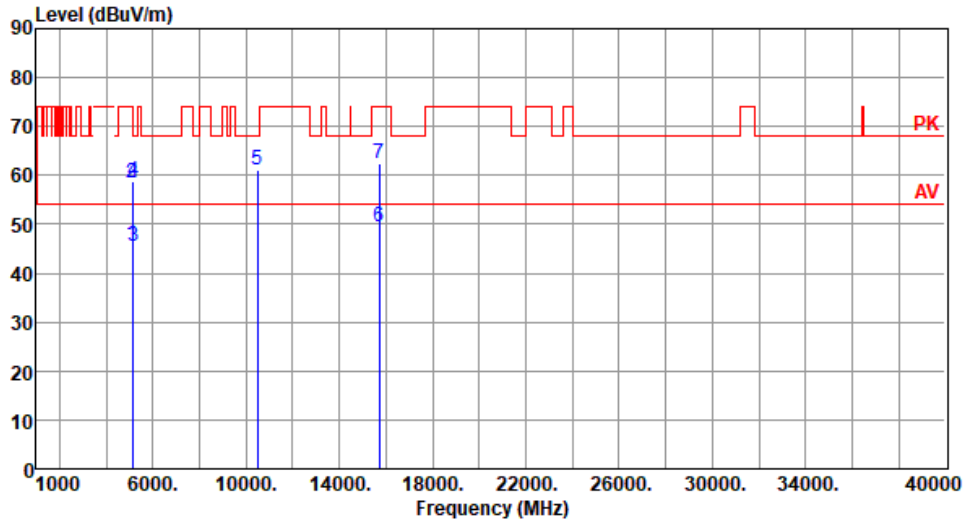

	Freq. MHz	Emission level dBuV/m	Limit dBuV/m	Margin dB	SA reading dBuV	Factor dB	Remark	ANT High cm	Turn Table deg
1	5120.00	45.87	54.00	-8.13	38.56	7.31	Average	111	245
2	5120.00	58.52	74.00	-15.48	51.21	7.31	Peak	111	245
3	5150.00	45.44	54.00	-8.56	38.12	7.32	Average	116	235
4	5150.00	58.65	74.00	-15.35	51.33	7.32	Peak	116	235
5	10480.00	61.21	68.20	-6.99	44.80	16.41	Peak	218	93
6	15720.00	49.47	54.00	-4.53	32.87	16.60	Average	156	5
7	15720.00	62.53	74.00	-11.47	45.93	16.60	Peak	156	5

Note 1: Emission Level (dBuV/m) = SA Reading (dBuV/m) + Factor* (dB)

*Factor includes antenna factor , cable loss and amplifier gain

Note 2: Margin (dB) = Emission level (dBuV/m) – Limit (dBuV/m).

Modulation	11a	Test Freq. (MHz)	5240
Polarization	Vertical		

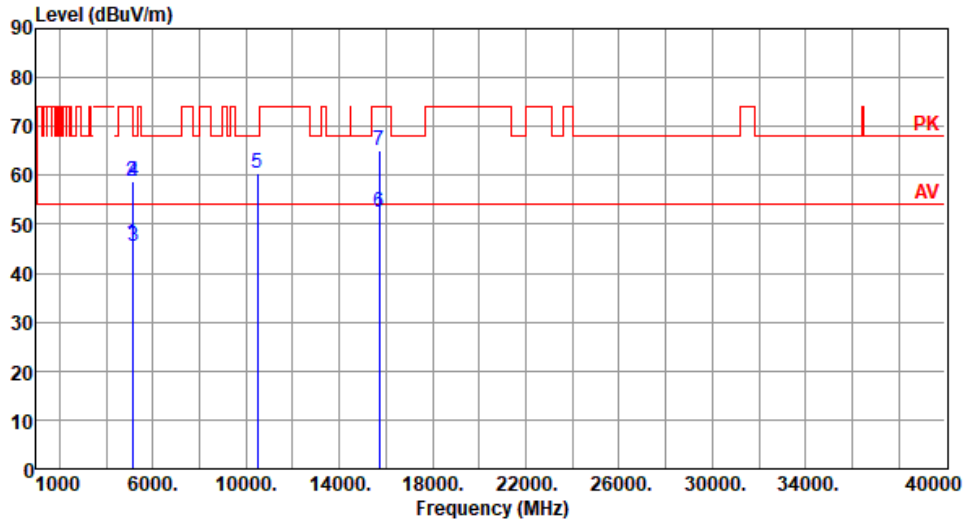

	Freq. MHz	Emission level dBuV/m	Limit dBuV/m	Margin dB	SA reading dBuV	Factor dB	Remark	ANT High cm	Turn Table deg
1	5120.00	46.21	54.00	-7.79	38.90	7.31	Average	212	285
2	5120.00	58.66	74.00	-15.34	51.35	7.31	Peak	212	285
3	5150.00	45.58	54.00	-8.42	38.26	7.32	Average	212	285
4	5150.00	58.77	74.00	-15.23	51.45	7.32	Peak	212	285
5	10480.00	60.43	68.20	-7.77	44.02	16.41	Peak	100	24
6	15720.00	52.34	54.00	-1.66	35.74	16.60	Average	131	332
7	15720.00	65.08	74.00	-8.92	48.48	16.60	Peak	131	332

Note 1: Emission Level (dBuV/m) = SA Reading (dBuV/m) + Factor* (dB)

*Factor includes antenna factor , cable loss and amplifier gain

Note 2: Margin (dB) = Emission level (dBuV/m) – Limit (dBuV/m).

Modulation	11a	Test Freq. (MHz)	5300
Polarization	Horizontal		

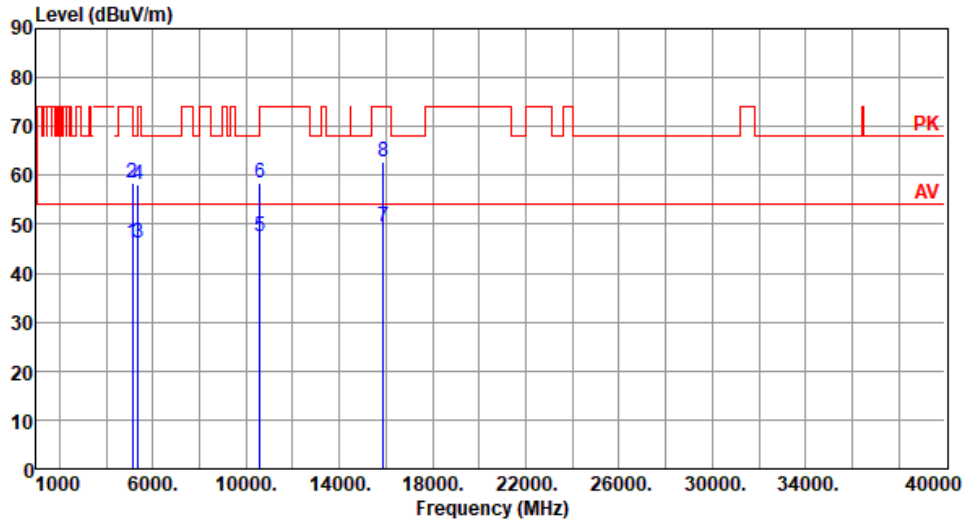

	Freq. MHz	Emission level dBuV/m	Limit dBuV/m	Margin dB	SA reading dBuV	Factor dB	Remark	ANT High cm	Turn Table deg
1	5120.00	46.06	54.00	-7.94	38.75	7.31	Average	111	238
2	5120.00	58.43	74.00	-15.57	51.12	7.31	Peak	111	238
3	5350.00	46.18	54.00	-7.82	39.33	6.85	Average	111	238
4	5350.00	58.05	74.00	-15.95	51.20	6.85	Peak	111	238
5	10600.00	47.62	54.00	-6.38	31.26	16.36	Average	100	50
6	10600.00	58.42	74.00	-15.58	42.06	16.36	Peak	100	50
7	15900.00	49.34	54.00	-4.66	32.65	16.69	Average	189	5
8	15900.00	62.87	74.00	-11.13	46.18	16.69	Peak	189	5

Note 1: Emission Level (dBuV/m) = SA Reading (dBuV/m) + Factor* (dB)

*Factor includes antenna factor , cable loss and amplifier gain

Note 2: Margin (dB) = Emission level (dBuV/m) – Limit (dBuV/m).

Modulation	11a	Test Freq. (MHz)	5300
Polarization	Vertical		

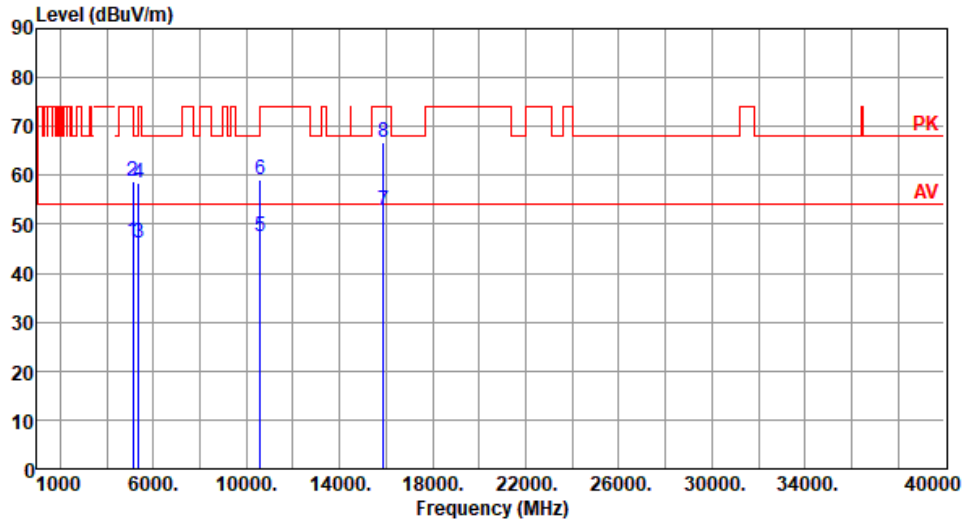

	Freq. MHz	Emission level dBuV/m	Limit dBuV/m	Margin dB	SA reading dBuV	Factor dB	Remark	ANT High cm	Turn Table deg
1	5120.00	46.43	54.00	-7.57	39.12	7.31	Average	213	265
2	5120.00	58.77	74.00	-15.23	51.46	7.31	Peak	213	265
3	5350.00	46.30	54.00	-7.70	39.45	6.85	Average	213	265
4	5350.00	58.31	74.00	-15.69	51.46	6.85	Peak	213	265
5	10600.00	47.61	54.00	-6.39	31.25	16.36	Average	100	30
6	10600.00	58.95	74.00	-15.05	42.59	16.36	Peak	100	30
7	15900.00	52.95	54.00	-1.05	36.26	16.69	Average	149	326
8	15900.00	66.77	74.00	-7.23	50.08	16.69	Peak	149	326

Note 1: Emission Level (dBuV/m) = SA Reading (dBuV/m) + Factor* (dB)

*Factor includes antenna factor , cable loss and amplifier gain

Note 2: Margin (dB) = Emission level (dBuV/m) – Limit (dBuV/m).

Modulation	11a	Test Freq. (MHz)	5500
Polarization	Horizontal		

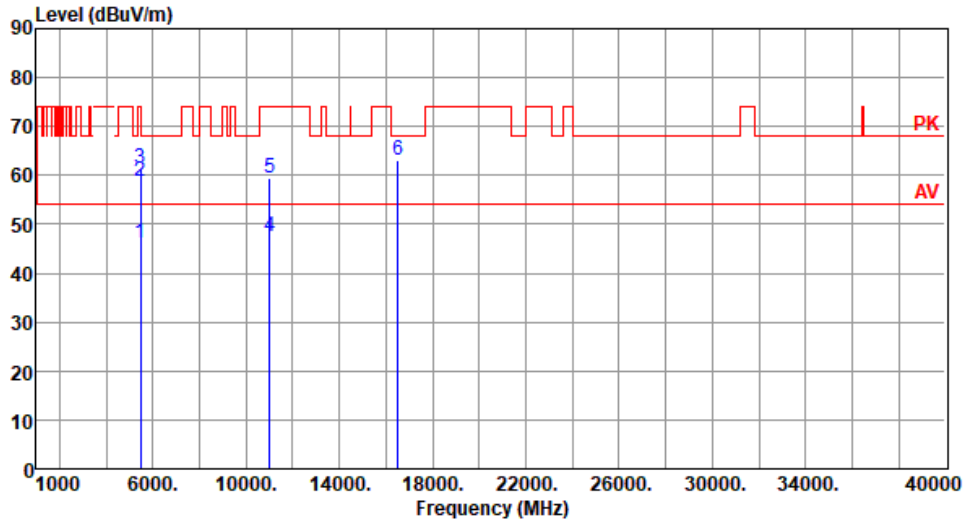

	Freq. MHz	Emission level dBuV/m	Limit dBuV/m	Margin dB	SA reading dBuV	Factor dB	Remark	ANT High cm	Turn Table deg
1	5460.00	46.21	54.00	-7.79	38.96	7.25	Average	110	209
2	5460.00	58.84	74.00	-15.16	51.59	7.25	Peak	110	209
3	5470.00	61.46	68.20	-6.74	54.18	7.28	Peak	110	209
4	11000.00	47.40	54.00	-6.60	30.56	16.84	Average	100	60
5	11000.00	59.33	74.00	-14.67	42.49	16.84	Peak	100	60
6	16500.00	63.10	68.20	-5.10	45.46	17.64	Peak	108	295

Note 1: Emission Level (dBuV/m) = SA Reading (dBuV/m) + Factor* (dB)

*Factor includes antenna factor , cable loss and amplifier gain

Note 2: Margin (dB) = Emission level (dBuV/m) – Limit (dBuV/m).

Modulation	11a	Test Freq. (MHz)	5500
Polarization	Vertical		

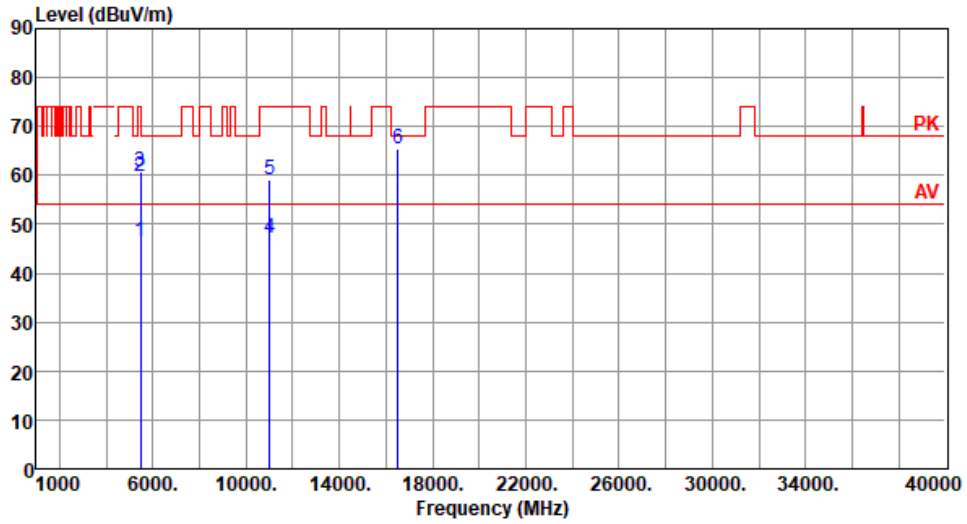

	Freq. MHz	Emission level dBuV/m	Limit dBuV/m	Margin dB	SA reading dBuV	Factor dB	Remark	ANT High cm	Turn Table deg
1	5460.00	46.37	54.00	-7.63	39.12	7.25	Average	195	272
2	5460.00	59.71	74.00	-14.29	52.46	7.25	Peak	195	272
3	5470.00	60.61	68.20	-7.59	53.33	7.28	Peak	195	272
4	11000.00	47.29	54.00	-6.71	30.45	16.84	Average	100	40
5	11000.00	59.19	74.00	-14.81	42.35	16.84	Peak	100	40
6	16500.00	65.55	68.20	-2.65	47.91	17.64	Peak	240	325

Note 1: Emission Level (dBuV/m) = SA Reading (dBuV/m) + Factor* (dB)

*Factor includes antenna factor , cable loss and amplifier gain

Note 2: Margin (dB) = Emission level (dBuV/m) – Limit (dBuV/m).

Modulation	11a	Test Freq. (MHz)	5580
Polarization	Horizontal		

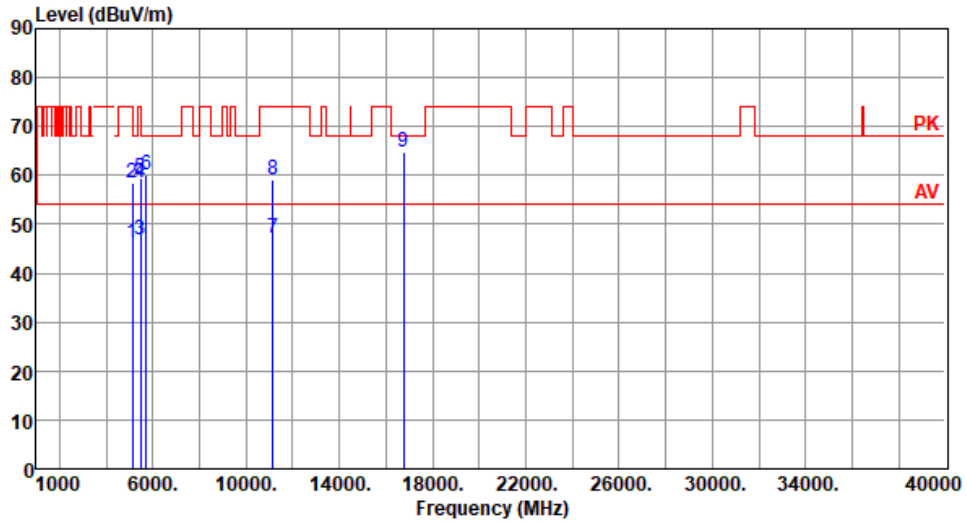

	Freq. MHz	Emission level dBuV/m	Limit dBuV/m	Margin dB	SA reading dBuV	Factor dB	Remark	ANT High cm	Turn Table deg
1	5120.00	46.28	54.00	-7.72	38.97	7.31	Average	111	205
2	5120.00	58.48	74.00	-15.52	51.17	7.31	Peak	111	205
3	5460.00	46.67	54.00	-7.33	39.42	7.25	Average	106	212
4	5460.00	58.38	74.00	-15.62	51.13	7.25	Peak	106	212
5	5470.00	59.57	68.20	-8.63	52.29	7.28	Peak	106	212
6	5725.00	60.06	68.20	-8.14	52.40	7.66	Peak	106	212
7	11160.00	47.13	54.00	-6.87	30.54	16.59	Average	100	8
8	11160.00	59.27	74.00	-14.73	42.68	16.59	Peak	100	8
9	16740.00	64.68	68.20	-3.52	46.45	18.23	Peak	106	298

Note 1: Emission Level (dBuV/m) = SA Reading (dBuV/m) + Factor* (dB)

*Factor includes antenna factor , cable loss and amplifier gain

Note 2: Margin (dB) = Emission level (dBuV/m) – Limit (dBuV/m).

Modulation	11a	Test Freq. (MHz)	5580
Polarization	Vertical		

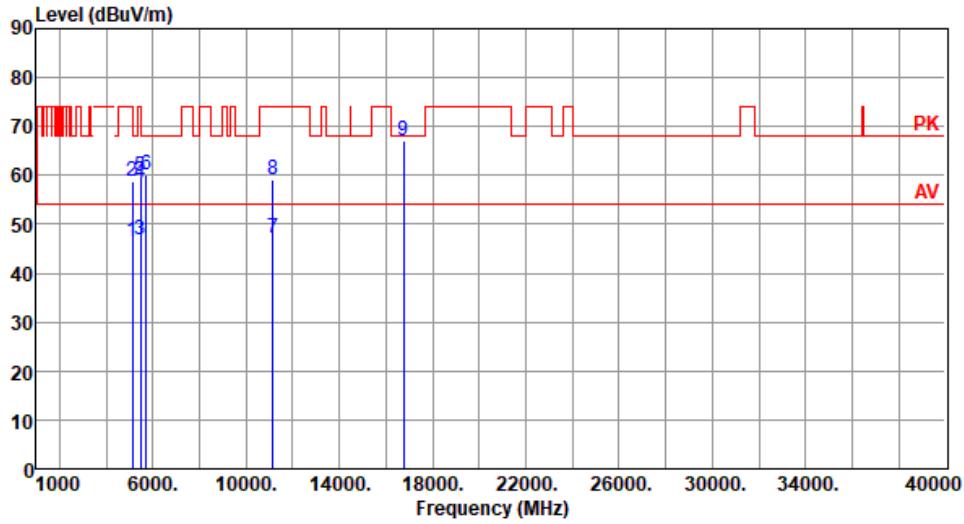

	Freq. MHz	Emission level dBuV/m	Limit dBuV/m	Margin dB	SA reading dBuV	Factor dB	Remark	ANT High cm	Turn Table deg
1	5120.00	46.61	54.00	-7.39	39.30	7.31	Average	321	275
2	5120.00	58.77	74.00	-15.23	51.46	7.31	Peak	321	275
3	5460.00	46.79	54.00	-7.21	39.54	7.25	Average	321	275
4	5460.00	58.51	74.00	-15.49	51.26	7.25	Peak	321	275
5	5470.00	59.75	68.20	-8.45	52.47	7.28	Peak	321	275
6	5725.00	60.21	68.20	-7.99	52.55	7.66	Peak	321	275
7	11160.00	47.28	54.00	-6.72	30.69	16.59	Average	100	50
8	11160.00	59.02	74.00	-14.98	42.43	16.59	Peak	100	50
9	16740.00	67.00	68.20	-1.20	48.77	18.23	Peak	235	321

Note 1: Emission Level (dBuV/m) = SA Reading (dBuV/m) + Factor* (dB)

*Factor includes antenna factor , cable loss and amplifier gain

Note 2: Margin (dB) = Emission level (dBuV/m) – Limit (dBuV/m).

Modulation	11a	Test Freq. (MHz)	5700
Polarization	Horizontal		

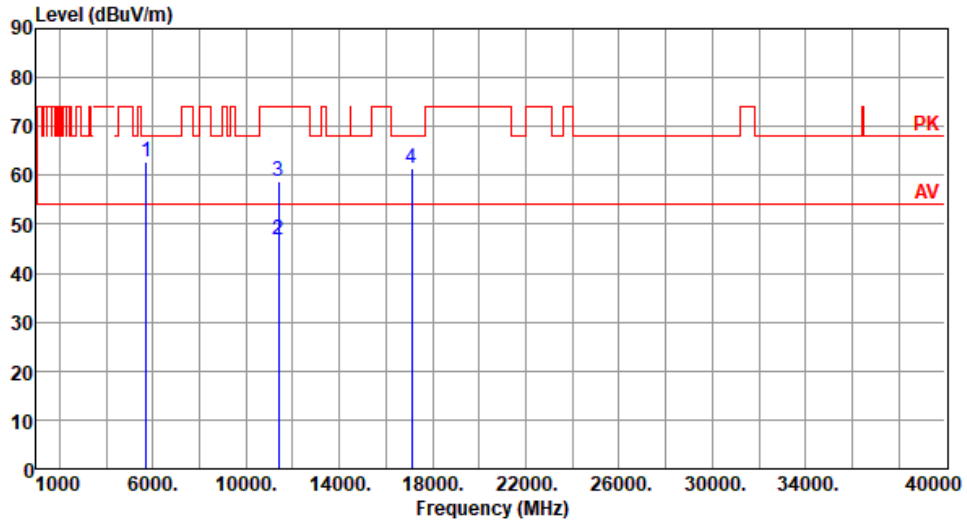

	Freq. MHz	Emission level dBuV/m	Limit dBuV/m	Margin dB	SA reading dBuV	Factor dB	Remark	ANT High cm	Turn Table deg
1	5725.00	62.91	68.20	-5.29	55.25	7.66	Peak	115	215
2	11400.00	46.97	54.00	-7.03	30.24	16.73	Average	100	40
3	11400.00	58.85	74.00	-15.15	42.12	16.73	Peak	100	40
4	17100.00	61.35	68.20	-6.85	43.11	18.24	Peak	108	296

Note 1: Emission Level (dBuV/m) = SA Reading (dBuV/m) + Factor* (dB)

*Factor includes antenna factor , cable loss and amplifier gain

Note 2: Margin (dB) = Emission level (dBuV/m) – Limit (dBuV/m).

Modulation	11a	Test Freq. (MHz)	5700
Polarization	Vertical		

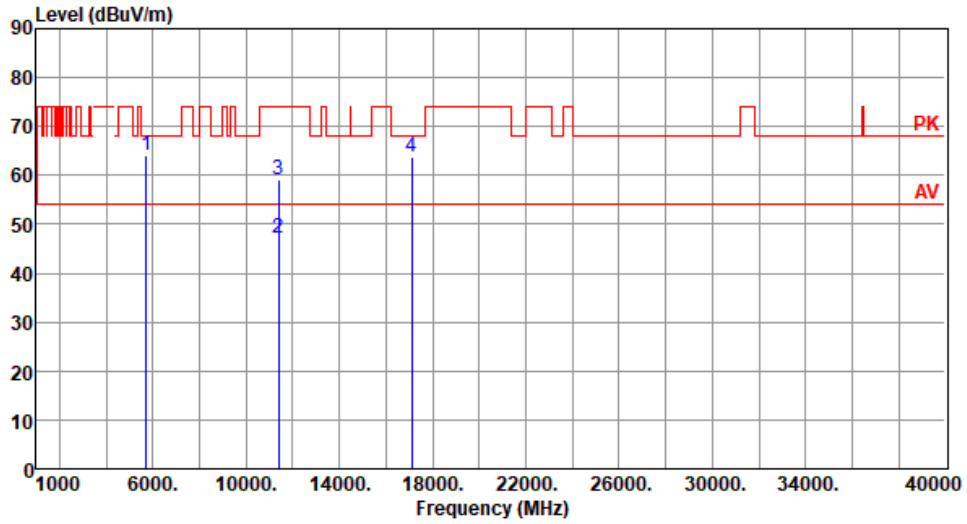

	Freq. MHz	Emission level dBuV/m	Limit dBuV/m	Margin dB	SA reading dBuV	Factor dB	Remark	ANT High cm	Turn Table deg
1	5725.00	64.11	68.20	-4.09	56.45	7.66	Peak	324	256
2	11400.00	47.17	54.00	-6.83	30.44	16.73	Average	100	20
3	11400.00	58.96	74.00	-15.04	42.23	16.73	Peak	100	20
4	17100.00	63.80	68.20	-4.40	45.56	18.24	Peak	241	323

Note 1: Emission Level (dBuV/m) = SA Reading (dBuV/m) + Factor* (dB)

*Factor includes antenna factor , cable loss and amplifier gain

Note 2: Margin (dB) = Emission level (dBuV/m) – Limit (dBuV/m).

Modulation	11a	Test Freq. (MHz)	5720
Polarization	Horizontal		

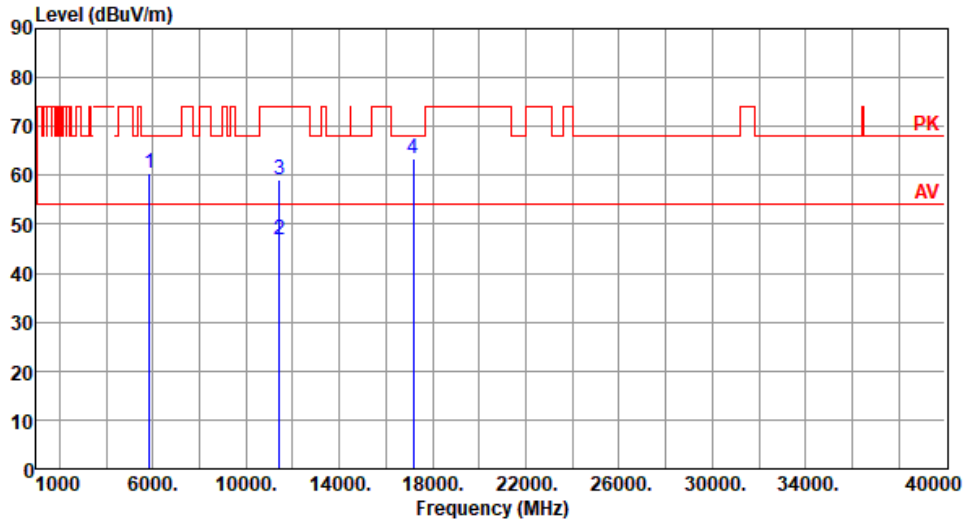

	Freq. MHz	Emission level dBuV/m	Limit dBuV/m	Margin dB	SA reading dBuV	Factor dB	Remark	ANT High cm	Turn Table deg
1	5850.00	60.41	68.20	-7.79	52.39	8.02	Peak	106	205
2	11440.00	46.95	54.00	-7.05	30.21	16.74	Average	100	56
3	11440.00	58.96	74.00	-15.04	42.22	16.74	Peak	100	56
4	17160.00	63.56	68.20	-4.64	45.18	18.38	Peak	100	309

Note 1: Emission Level (dBuV/m) = SA Reading (dBuV/m) + Factor* (dB)

*Factor includes antenna factor , cable loss and amplifier gain

Note 2: Margin (dB) = Emission level (dBuV/m) – Limit (dBuV/m).

Modulation	11a	Test Freq. (MHz)	5720
Polarization	Vertical		

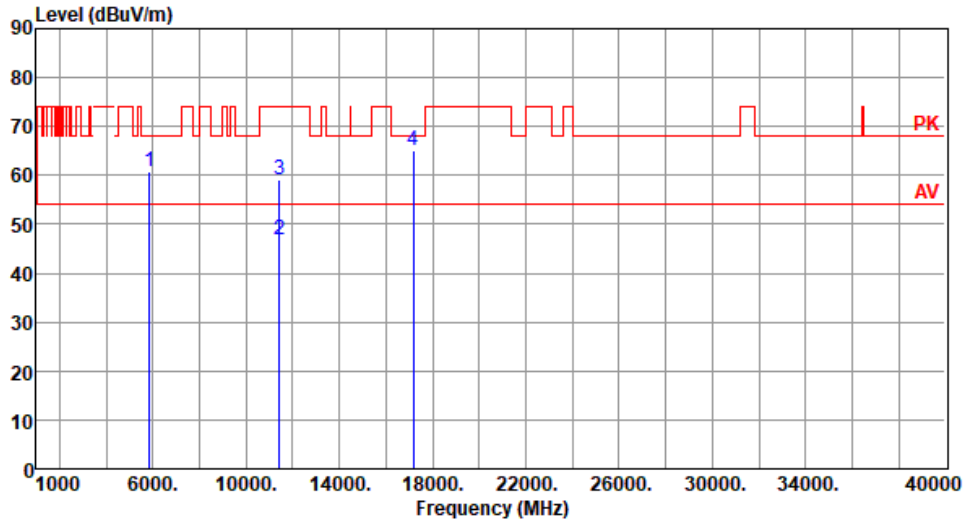

	Freq. MHz	Emission level dBuV/m	Limit dBuV/m	Margin dB	SA reading dBuV	Factor dB	Remark	ANT High cm	Turn Table deg
1	5850.00	60.61	68.20	-7.59	52.59	8.02	Peak	292	245
2	11440.00	46.95	54.00	-7.05	30.21	16.74	Average	100	38
3	11440.00	59.22	74.00	-14.78	42.48	16.74	Peak	100	38
4	17160.00	64.96	68.20	-3.24	46.58	18.38	Peak	241	326

Note 1: Emission Level (dBuV/m) = SA Reading (dBuV/m) + Factor* (dB)

*Factor includes antenna factor , cable loss and amplifier gain

Note 2: Margin (dB) = Emission level (dBuV/m) – Limit (dBuV/m).

Modulation	11a	Test Freq. (MHz)	5745
Polarization	Horizontal		

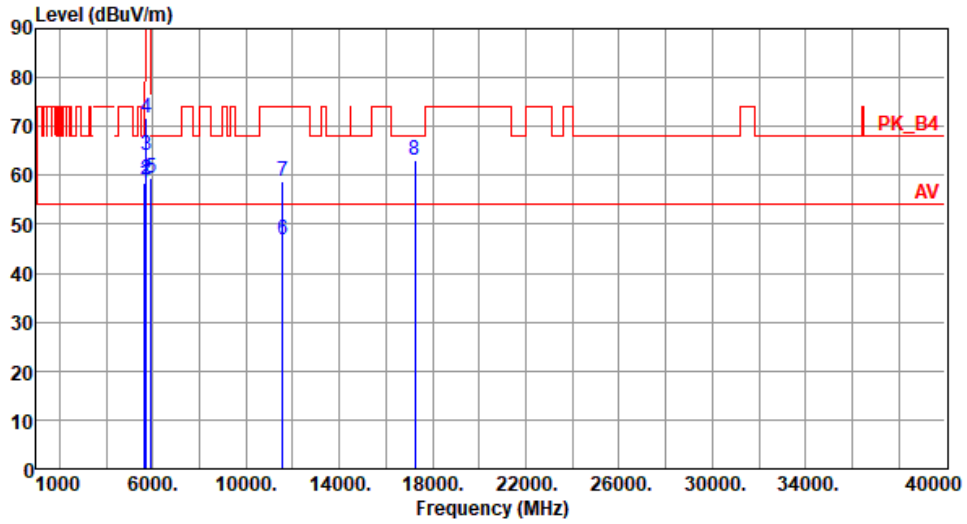

	Freq. MHz	Emission level dBuV/m	Limit dBuV/m	Margin dB	SA reading dBuV	Factor dB	Remark	ANT High cm	Turn Table deg
1	5650.00	58.44	68.20	-9.76	51.05	7.39	Peak	106	207
2	5700.00	59.06	105.20	-46.14	51.56	7.50	Peak	106	207
3	5720.00	64.21	110.80	-46.59	56.59	7.62	Peak	106	207
4	5725.00	71.77	122.20	-50.43	64.11	7.66	Peak	106	207
5	5925.00	59.34	68.20	-8.86	51.27	8.07	Peak	106	207
6	11570.00	46.86	54.00	-7.14	30.25	16.61	Average	100	50
7	11570.00	58.84	74.00	-15.16	42.23	16.61	Peak	100	50
8	17235.00	63.00	68.20	-5.20	44.36	18.64	Peak	100	305

Note 1: Emission Level (dBuV/m) = SA Reading (dBuV/m) + Factor* (dB)

*Factor includes antenna factor , cable loss and amplifier gain

Note 2: Margin (dB) = Emission level (dBuV/m) – Limit (dBuV/m).

Modulation	11a	Test Freq. (MHz)	5745
Polarization	Vertical		

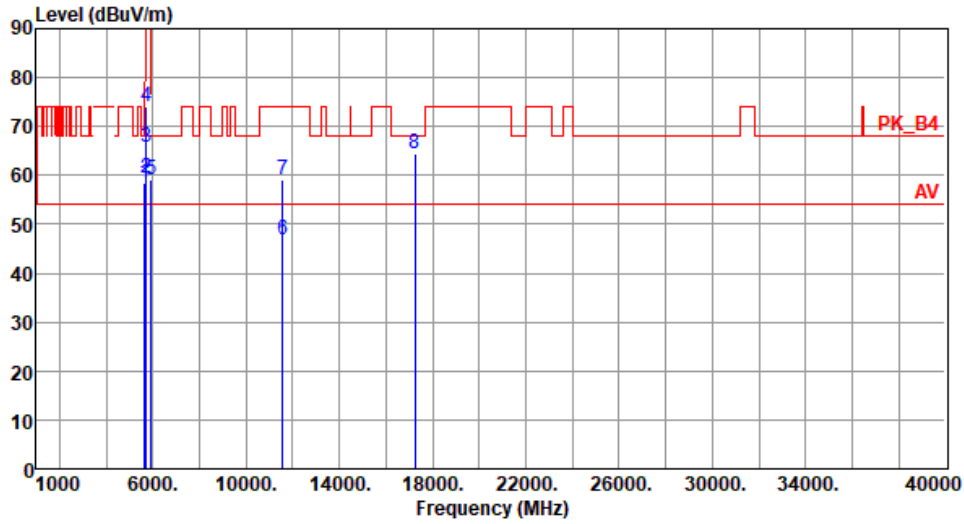

	Freq. MHz	Emission level dBuV/m	Limit dBuV/m	Margin dB	SA reading dBuV	Factor dB	Remark	ANT High cm	Turn Table deg
1	5650.00	58.55	68.20	-9.65	51.16	7.39	Peak	292	242
2	5700.00	59.40	105.20	-45.80	51.90	7.50	Peak	292	242
3	5720.00	65.85	110.80	-44.95	58.23	7.62	Peak	292	242
4	5725.00	74.00	122.20	-48.20	66.34	7.66	Peak	292	242
5	5925.00	59.24	68.20	-8.96	51.17	8.07	Peak	292	242
6	11570.00	46.93	54.00	-7.07	30.32	16.61	Average	100	40
7	11570.00	59.11	74.00	-14.89	42.50	16.61	Peak	100	40
8	17235.00	64.51	68.20	-3.69	45.87	18.64	Peak	244	325

Note 1: Emission Level (dBuV/m) = SA Reading (dBuV/m) + Factor* (dB)

*Factor includes antenna factor , cable loss and amplifier gain

Note 2: Margin (dB) = Emission level (dBuV/m) – Limit (dBuV/m).

Modulation	11a	Test Freq. (MHz)	5785
Polarization	Horizontal		

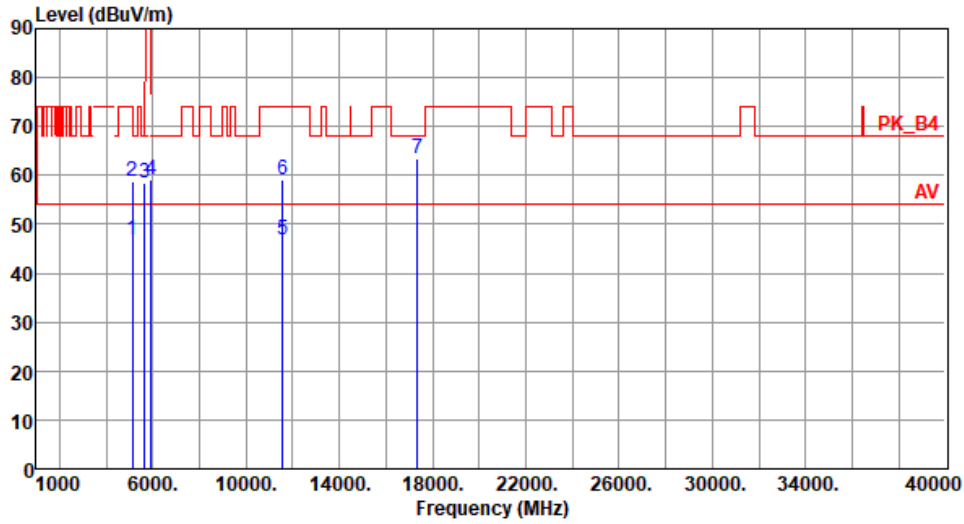

	Freq. MHz	Emission level dBuV/m	Limit dBuV/m	Margin dB	SA reading dBuV	Factor dB	Remark	ANT High cm	Turn Table deg
1	5120.00	46.76	54.00	-7.24	39.45	7.31	Average	102	208
2	5120.00	58.73	74.00	-15.27	51.42	7.31	Peak	102	208
3	5650.00	58.51	68.20	-9.69	51.12	7.39	Peak	102	208
4	5925.00	59.17	68.20	-9.03	51.10	8.07	Peak	102	208
5	11570.00	46.96	54.00	-7.04	30.35	16.61	Average	100	50
6	11570.00	59.07	74.00	-14.93	42.46	16.61	Peak	100	50
7	17355.00	63.37	68.20	-4.83	44.14	19.23	Peak	100	300

Note 1: Emission Level (dBuV/m) = SA Reading (dBuV/m) + Factor* (dB)

*Factor includes antenna factor , cable loss and amplifier gain

Note 2: Margin (dB) = Emission level (dBuV/m) – Limit (dBuV/m).

Modulation	11a	Test Freq. (MHz)	5785
Polarization	Vertical		

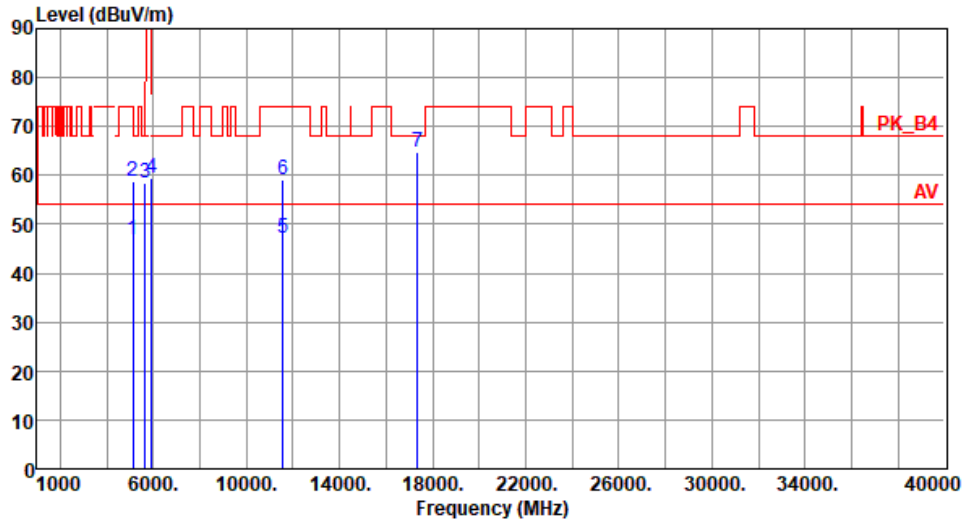

	Freq. MHz	Emission level dBuV/m	Limit dBuV/m	Margin dB	SA reading dBuV	Factor dB	Remark	ANT High cm	Turn Table deg
1	5120.00	46.94	54.00	-7.06	39.63	7.31	Average	339	233
2	5120.00	58.77	74.00	-15.23	51.46	7.31	Peak	339	233
3	5650.00	58.51	68.20	-9.69	51.12	7.39	Peak	339	233
4	5925.00	59.34	68.20	-8.86	51.27	8.07	Peak	339	233
5	11570.00	47.17	54.00	-6.83	30.56	16.61	Average	100	30
6	11570.00	59.06	74.00	-14.94	42.45	16.61	Peak	100	30
7	17355.00	64.70	68.20	-3.50	45.47	19.23	Peak	241	323

Note 1: Emission Level (dBuV/m) = SA Reading (dBuV/m) + Factor* (dB)

*Factor includes antenna factor , cable loss and amplifier gain

Note 2: Margin (dB) = Emission level (dBuV/m) – Limit (dBuV/m).

Modulation	11a	Test Freq. (MHz)	5825
Polarization	Horizontal		

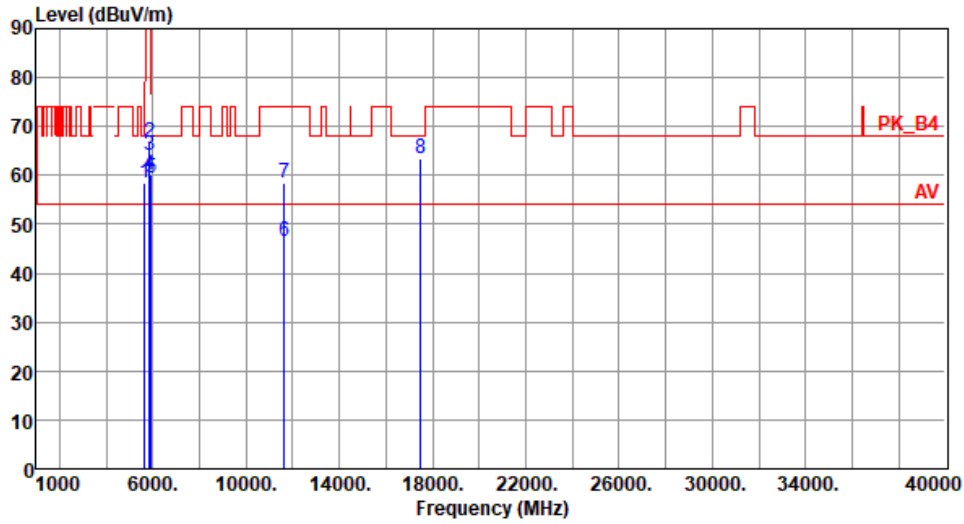

	Freq. MHz	Emission level dBuV/m	Limit dBuV/m	Margin dB	SA reading dBuV	Factor dB	Remark	ANT High cm	Turn Table deg
1	5650.00	58.48	68.20	-9.72	51.09	7.39	Peak	105	202
2	5850.00	66.71	122.20	-55.49	58.69	8.02	Peak	105	202
3	5855.00	64.25	110.80	-46.55	56.23	8.02	Peak	105	202
4	5875.00	60.15	105.20	-45.05	52.12	8.03	Peak	105	202
5	5925.00	59.34	68.20	-8.86	51.27	8.07	Peak	105	202
6	11650.00	46.63	54.00	-7.37	30.25	16.38	Average	100	30
7	11650.00	58.51	74.00	-15.49	42.13	16.38	Peak	100	30
8	17475.00	63.32	68.20	-4.88	43.58	19.74	Peak	100	297

Note 1: Emission Level (dBuV/m) = SA Reading (dBuV/m) + Factor* (dB)

*Factor includes antenna factor , cable loss and amplifier gain

Note 2: Margin (dB) = Emission level (dBuV/m) – Limit (dBuV/m).

Modulation	11a	Test Freq. (MHz)	5825
Polarization	Vertical		

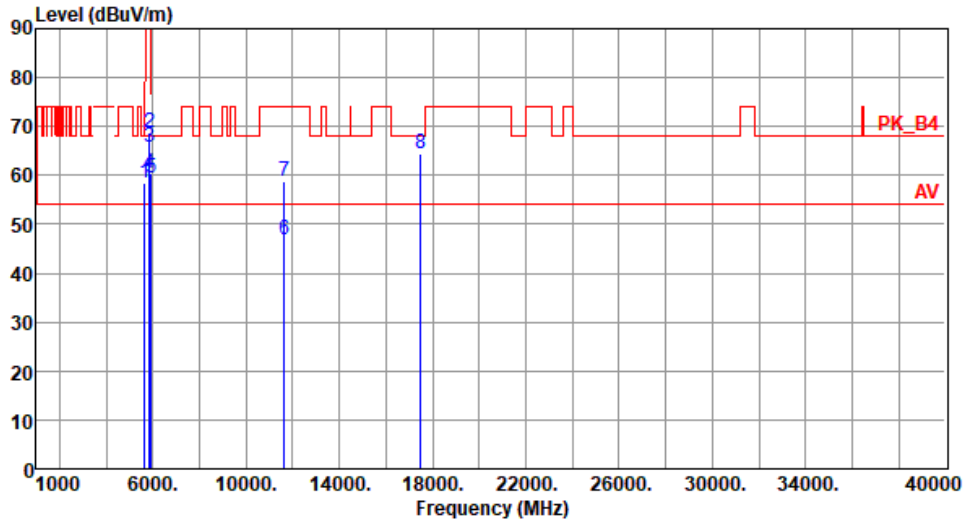

	Freq. MHz	Emission level dBuV/m	Limit dBuV/m	Margin dB	SA reading dBuV	Factor dB	Remark	ANT High cm	Turn Table deg
1	5650.00	58.53	68.20	-9.67	51.14	7.39	Peak	262	260
2	5850.00	68.73	122.20	-53.47	60.71	8.02	Peak	262	260
3	5855.00	65.77	110.80	-45.03	57.75	8.02	Peak	262	260
4	5875.00	60.48	105.20	-44.72	52.45	8.03	Peak	262	260
5	5925.00	59.47	68.20	-8.73	51.40	8.07	Peak	262	260
6	11650.00	46.76	54.00	-7.24	30.38	16.38	Average	100	25
7	11650.00	58.72	74.00	-15.28	42.34	16.38	Peak	100	25
8	17475.00	64.48	68.20	-3.72	44.74	19.74	Peak	240	329

Note 1: Emission Level (dBuV/m) = SA Reading (dBuV/m) + Factor* (dB)

*Factor includes antenna factor , cable loss and amplifier gain

Note 2: Margin (dB) = Emission level (dBuV/m) – Limit (dBuV/m).

3.5.14 Transmitter Radiated Unwanted Emissions (Above 1GHz) for HT20

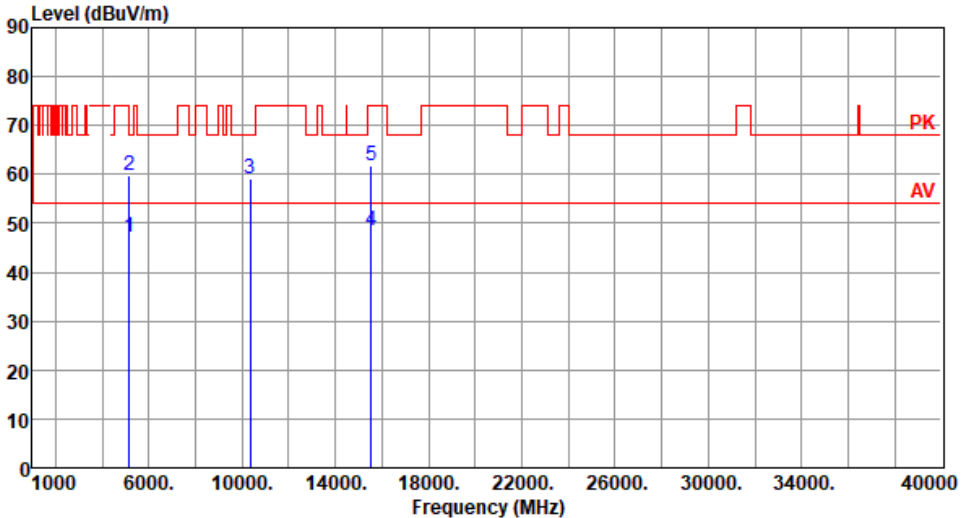
Modulation	HT20	Test Freq. (MHz)	5180						
Polarization	Horizontal								
									
	Freq. MHz	Emission level dBuV/m	Limit dBuV/m	Margin dB	SA reading dBuV	Factor dB	Remark	ANT High cm	Turn Table deg
1	5150.00	46.99	54.00	-7.01	39.67	7.32	Average	118	237
2	5150.00	59.77	74.00	-14.23	52.45	7.32	Peak	118	237
3	10360.00	59.22	68.20	-8.98	43.13	16.09	Peak	100	50
4	15540.00	48.63	54.00	-5.37	31.26	17.37	Average	155	6
5	15540.00	61.66	74.00	-12.34	44.29	17.37	Peak	155	6

Note 1: Emission Level (dBuV/m) = SA Reading (dBuV/m) + Factor* (dB)
*Factor includes antenna factor , cable loss and amplifier gain
Note 2: Margin (dB) = Emission level (dBuV/m) – Limit (dBuV/m).

Modulation	HT20	Test Freq. (MHz)	5180
Polarization	Vertical		

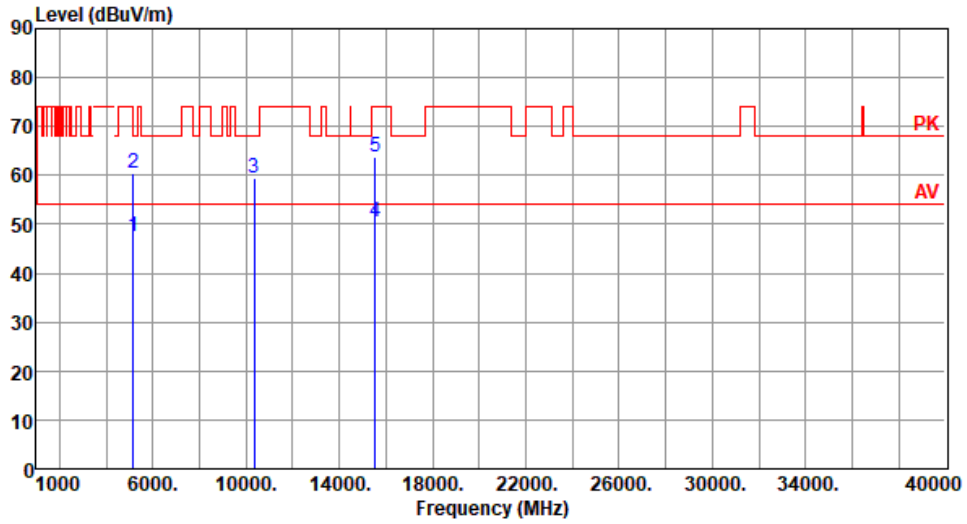

	Freq. MHz	Emission level dBuV/m	Limit dBuV/m	Margin dB	SA reading dBuV	Factor dB	Remark	ANT High cm	Turn Table deg
1	5150.00	47.43	54.00	-6.57	40.11	7.32	Average	213	279
2	5150.00	60.47	74.00	-13.53	53.15	7.32	Peak	213	279
3	10360.00	59.51	68.20	-8.69	43.42	16.09	Peak	100	20
4	15540.00	50.52	54.00	-3.48	33.15	17.37	Average	128	335
5	15540.00	63.78	74.00	-10.22	46.41	17.37	Peak	128	335

Note 1: Emission Level (dBuV/m) = SA Reading (dBuV/m) + Factor* (dB)

*Factor includes antenna factor , cable loss and amplifier gain

Note 2: Margin (dB) = Emission level (dBuV/m) – Limit (dBuV/m).

Modulation	HT20	Test Freq. (MHz)	5300
Polarization	Horizontal		

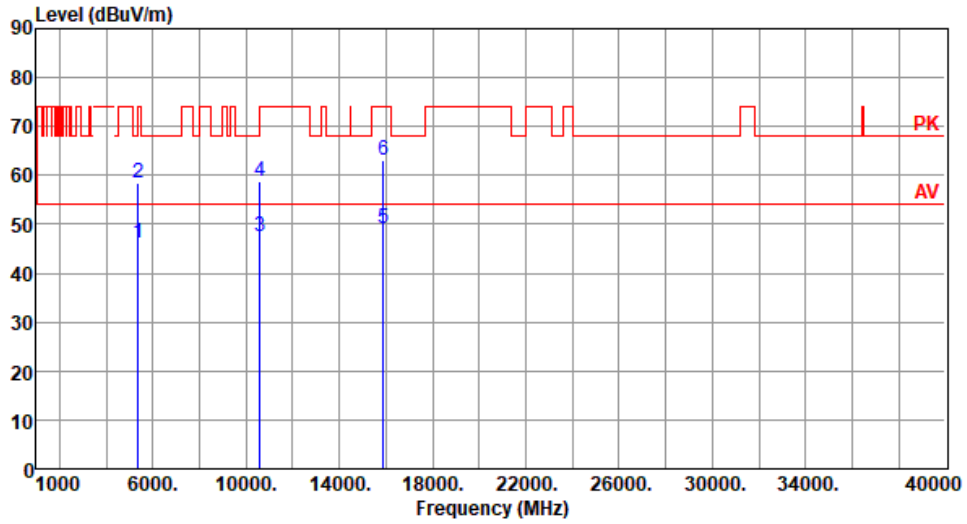

	Freq. MHz	Emission level dBuV/m	Limit dBuV/m	Margin dB	SA reading dBuV	Factor dB	Remark	ANT High cm	Turn Table deg
1	5350.00	46.30	54.00	-7.70	39.45	6.85	Average	111	239
2	5350.00	58.29	74.00	-15.71	51.44	6.85	Peak	111	239
3	10600.00	47.49	54.00	-6.51	31.13	16.36	Average	100	40
4	10600.00	58.62	74.00	-15.38	42.26	16.36	Peak	100	40
5	15900.00	49.24	54.00	-4.76	32.55	16.69	Average	191	6
6	15900.00	62.95	74.00	-11.05	46.26	16.69	Peak	191	6

Note 1: Emission Level (dBuV/m) = SA Reading (dBuV/m) + Factor* (dB)

*Factor includes antenna factor , cable loss and amplifier gain

Note 2: Margin (dB) = Emission level (dBuV/m) – Limit (dBuV/m).

Modulation	HT20	Test Freq. (MHz)	5300
Polarization	Vertical		

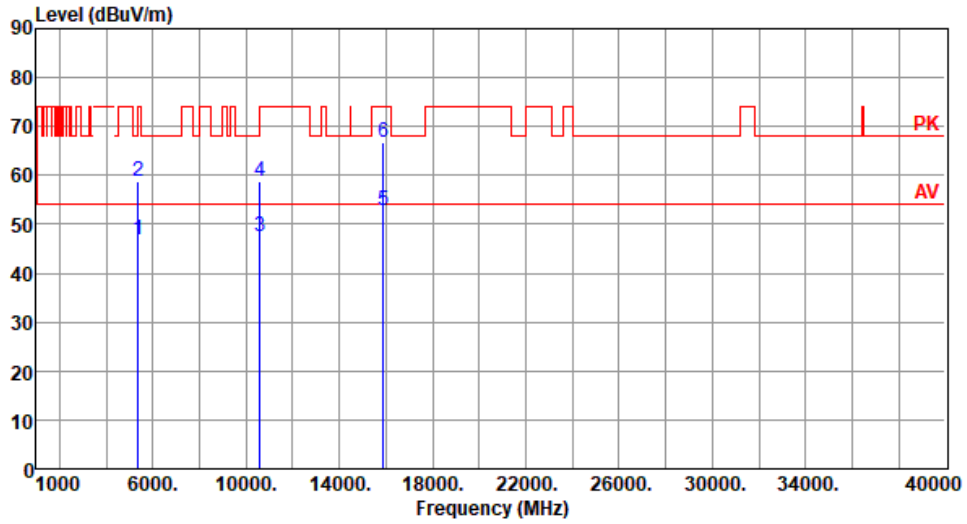

	Freq. MHz	Emission level dBuV/m	Limit dBuV/m	Margin dB	SA reading dBuV	Factor dB	Remark	ANT High cm	Turn Table deg
1	5350.00	46.71	54.00	-7.29	39.86	6.85	Average	215	261
2	5350.00	58.90	74.00	-15.10	52.05	6.85	Peak	215	261
3	10600.00	47.49	54.00	-6.51	31.13	16.36	Average	100	40
4	10600.00	58.77	74.00	-15.23	42.41	16.36	Peak	100	40
5	15900.00	52.83	54.00	-1.17	36.14	16.69	Average	151	328
6	15900.00	66.90	74.00	-7.10	50.21	16.69	Peak	151	328

Note 1: Emission Level (dBuV/m) = SA Reading (dBuV/m) + Factor* (dB)

*Factor includes antenna factor , cable loss and amplifier gain

Note 2: Margin (dB) = Emission level (dBuV/m) – Limit (dBuV/m).

Modulation	HT20	Test Freq. (MHz)	5320
Polarization	Horizontal		

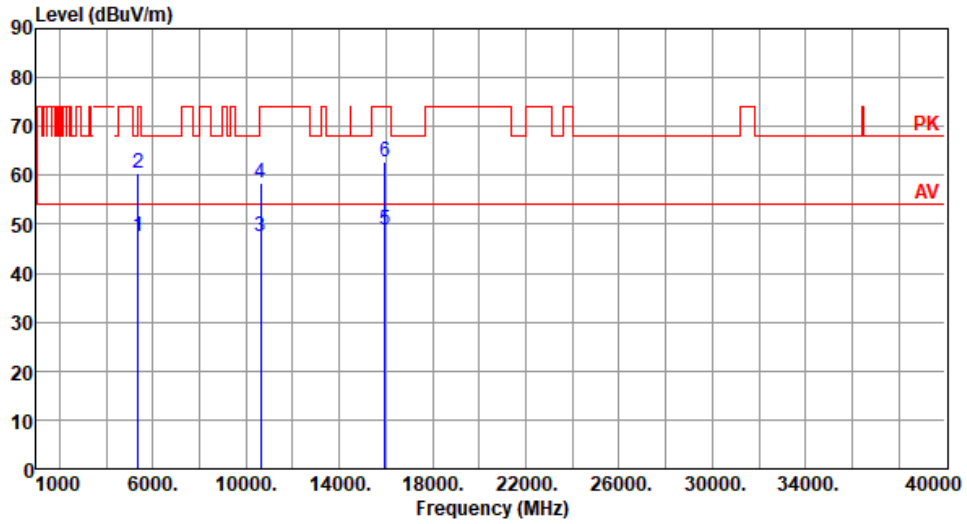

	Freq. MHz	Emission level dBuV/m	Limit dBuV/m	Margin dB	SA reading dBuV	Factor dB	Remark	ANT High cm	Turn Table deg
1	5350.00	47.41	54.00	-6.59	40.56	6.85	Average	118	239
2	5350.00	60.40	74.00	-13.60	53.55	6.85	Peak	118	239
3	10640.00	47.39	54.00	-6.61	31.02	16.37	Average	100	60
4	10640.00	58.53	74.00	-15.47	42.16	16.37	Peak	100	60
5	15960.00	48.65	54.00	-5.35	32.12	16.53	Average	144	327
6	15960.00	62.86	74.00	-11.14	46.33	16.53	Peak	144	327

Note 1: Emission Level (dBuV/m) = SA Reading (dBuV/m) + Factor* (dB)

*Factor includes antenna factor , cable loss and amplifier gain

Note 2: Margin (dB) = Emission level (dBuV/m) – Limit (dBuV/m).

Modulation	HT20	Test Freq. (MHz)	5320
Polarization	Vertical		

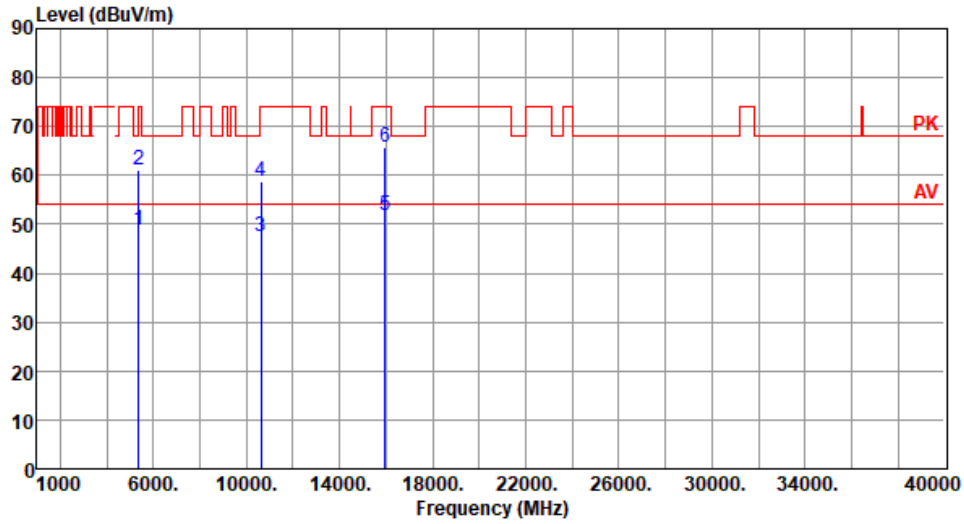

	Freq. MHz	Emission level dBuV/m	Limit dBuV/m	Margin dB	SA reading dBuV	Factor dB	Remark	ANT High cm	Turn Table deg
1	5350.00	48.86	54.00	-5.14	42.01	6.85	Average	200	243
2	5350.00	61.20	74.00	-12.80	54.35	6.85	Peak	200	243
3	10640.00	47.42	54.00	-6.58	31.05	16.37	Average	100	20
4	10640.00	58.70	74.00	-15.30	42.33	16.37	Peak	100	20
5	15960.00	51.68	54.00	-2.32	35.15	16.53	Average	146	325
6	15960.00	65.71	74.00	-8.29	49.18	16.53	Peak	146	325

Note 1: Emission Level (dBuV/m) = SA Reading (dBuV/m) + Factor* (dB)

*Factor includes antenna factor , cable loss and amplifier gain

Note 2: Margin (dB) = Emission level (dBuV/m) – Limit (dBuV/m).

Modulation	HT20	Test Freq. (MHz)	5500
Polarization	Horizontal		

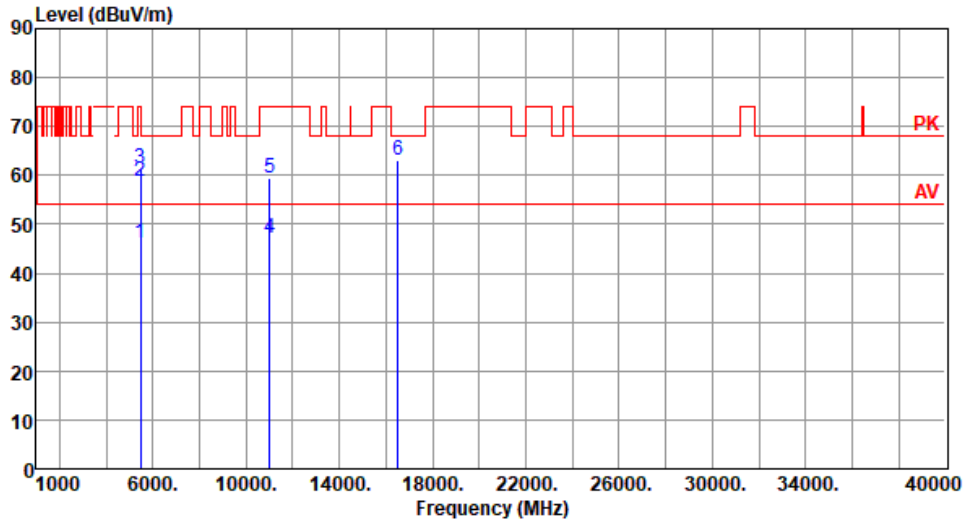

	Freq. MHz	Emission level dBuV/m	Limit dBuV/m	Margin dB	SA reading dBuV	Factor dB	Remark	ANT High cm	Turn Table deg
1	5460.00	46.13	54.00	-7.87	38.88	7.25	Average	111	206
2	5460.00	58.67	74.00	-15.33	51.42	7.25	Peak	111	206
3	5470.00	61.30	68.20	-6.90	54.02	7.28	Peak	111	206
4	11000.00	47.28	54.00	-6.72	30.44	16.84	Average	100	50
5	11000.00	59.40	74.00	-14.60	42.56	16.84	Peak	100	50
6	16500.00	63.19	68.20	-5.01	45.55	17.64	Peak	100	293

Note 1: Emission Level (dBuV/m) = SA Reading (dBuV/m) + Factor* (dB)

*Factor includes antenna factor , cable loss and amplifier gain

Note 2: Margin (dB) = Emission level (dBuV/m) – Limit (dBuV/m).

Modulation	HT20	Test Freq. (MHz)	5500
Polarization	Vertical		

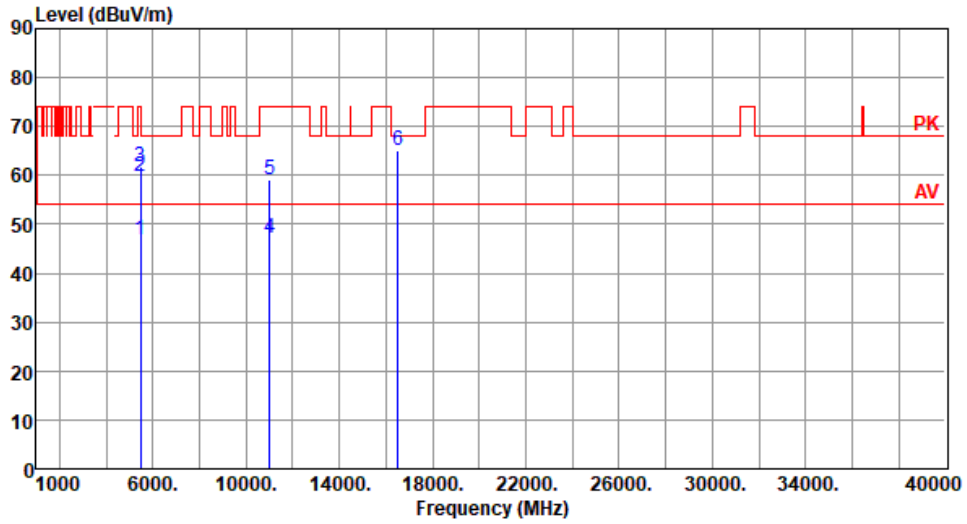

	Freq. MHz	Emission level dBuV/m	Limit dBuV/m	Margin dB	SA reading dBuV	Factor dB	Remark	ANT High cm	Turn Table deg
1	5460.00	46.70	54.00	-7.30	39.45	7.25	Average	193	275
2	5460.00	59.80	74.00	-14.20	52.55	7.25	Peak	193	275
3	5470.00	61.84	68.20	-6.36	54.56	7.28	Peak	193	275
4	11000.00	47.16	54.00	-6.84	30.32	16.84	Average	100	30
5	11000.00	59.05	74.00	-14.95	42.21	16.84	Peak	100	30
6	16500.00	65.23	68.20	-2.97	47.59	17.64	Peak	239	327

Note 1: Emission Level (dBuV/m) = SA Reading (dBuV/m) + Factor* (dB)

*Factor includes antenna factor , cable loss and amplifier gain

Note 2: Margin (dB) = Emission level (dBuV/m) – Limit (dBuV/m).

Modulation	HT20	Test Freq. (MHz)	5580
Polarization	Horizontal		

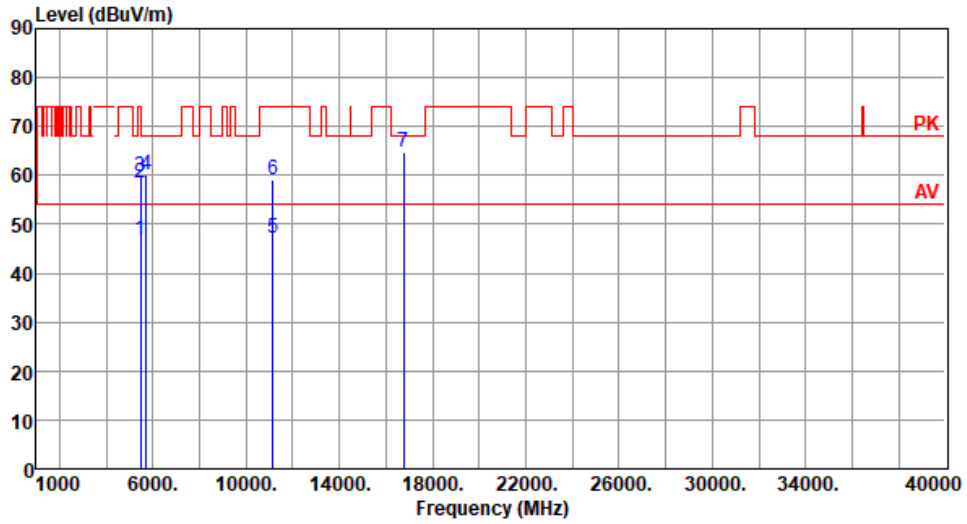

	Freq. MHz	Emission level dBuV/m	Limit dBuV/m	Margin dB	SA reading dBuV	Factor dB	Remark	ANT High cm	Turn Table deg
1	5460.00	46.70	54.00	-7.30	39.45	7.25	Average	105	213
2	5460.00	58.49	74.00	-15.51	51.24	7.25	Peak	105	213
3	5470.00	59.64	68.20	-8.56	52.36	7.28	Peak	105	213
4	5725.00	59.98	68.20	-8.22	52.32	7.66	Peak	105	213
5	11160.00	47.05	54.00	-6.95	30.46	16.59	Average	100	10
6	11160.00	59.18	74.00	-14.82	42.59	16.59	Peak	100	10
7	16740.00	64.72	68.20	-3.48	46.49	18.23	Peak	104	293

Note 1: Emission Level (dBuV/m) = SA Reading (dBuV/m) + Factor* (dB)

*Factor includes antenna factor , cable loss and amplifier gain

Note 2: Margin (dB) = Emission level (dBuV/m) – Limit (dBuV/m).

Modulation	HT20	Test Freq. (MHz)	5580
Polarization	Vertical		

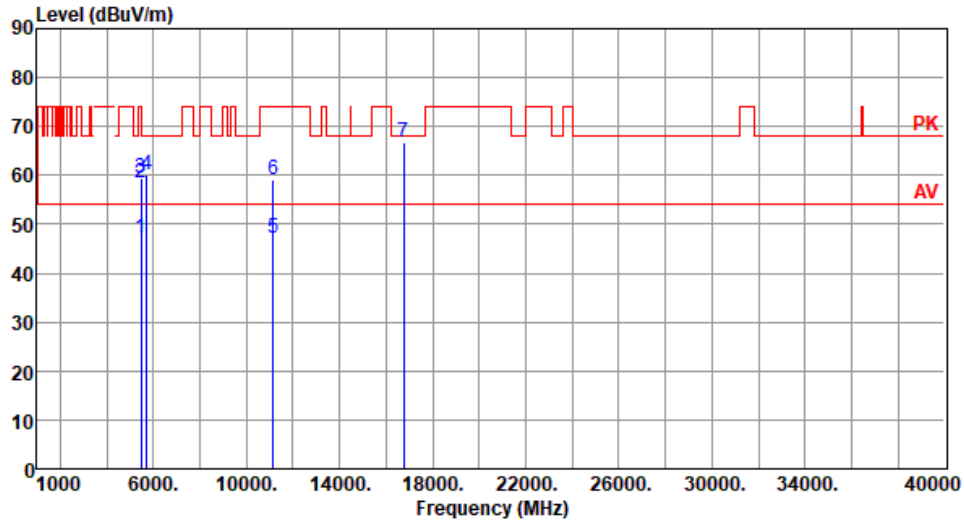

	Freq. MHz	Emission level dBuV/m	Limit dBuV/m	Margin dB	SA reading dBuV	Factor dB	Remark	ANT High cm	Turn Table deg
1	5460.00	47.11	54.00	-6.89	39.86	7.25	Average	319	272
2	5460.00	58.56	74.00	-15.44	51.31	7.25	Peak	319	272
3	5470.00	59.54	68.20	-8.66	52.26	7.28	Peak	319	272
4	5725.00	60.06	68.20	-8.14	52.40	7.66	Peak	319	272
5	11160.00	47.04	54.00	-6.96	30.45	16.59	Average	100	40
6	11160.00	58.98	74.00	-15.02	42.39	16.59	Peak	100	40
7	16740.00	66.87	68.20	-1.33	48.64	18.23	Peak	242	324

Note 1: Emission Level (dBuV/m) = SA Reading (dBuV/m) + Factor* (dB)

*Factor includes antenna factor , cable loss and amplifier gain

Note 2: Margin (dB) = Emission level (dBuV/m) – Limit (dBuV/m).

Modulation	HT20	Test Freq. (MHz)	5700
Polarization	Horizontal		

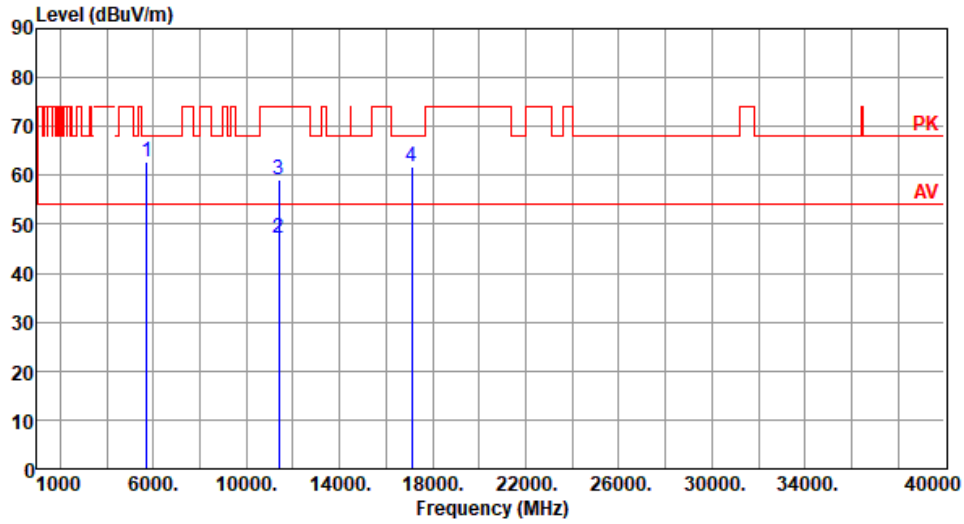

	Freq. MHz	Emission level dBuV/m	Limit dBuV/m	Margin dB	SA reading dBuV	Factor dB	Remark	ANT High cm	Turn Table deg
1	5725.00	62.77	68.20	-5.43	55.11	7.66	Peak	116	217
2	11400.00	47.03	54.00	-6.97	30.30	16.73	Average	100	25
3	11400.00	58.98	74.00	-15.02	42.25	16.73	Peak	100	25
4	17100.00	61.64	68.20	-6.56	43.40	18.24	Peak	100	299

Note 1: Emission Level (dBuV/m) = SA Reading (dBuV/m) + Factor* (dB)

*Factor includes antenna factor , cable loss and amplifier gain

Note 2: Margin (dB) = Emission level (dBuV/m) – Limit (dBuV/m).

Modulation	HT20	Test Freq. (MHz)	5700
Polarization	Vertical		

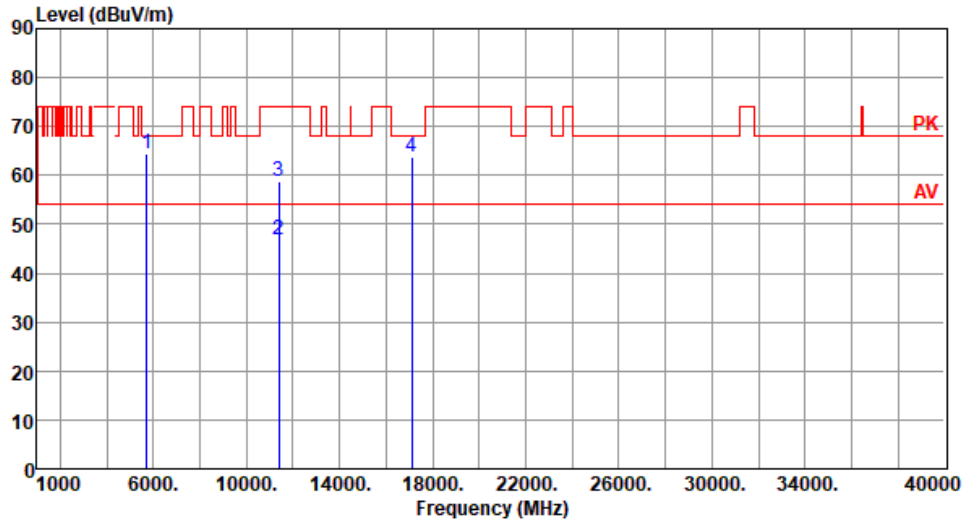

	Freq. MHz	Emission level dBuV/m	Limit dBuV/m	Margin dB	SA reading dBuV	Factor dB	Remark	ANT High cm	Turn Table deg
1	5725.00	64.40	68.20	-3.80	56.74	7.66	Peak	325	255
2	11400.00	46.98	54.00	-7.02	30.25	16.73	Average	100	30
3	11400.00	58.85	74.00	-15.15	42.12	16.73	Peak	100	30
4	17100.00	63.70	68.20	-4.50	45.46	18.24	Peak	242	326

Note 1: Emission Level (dBuV/m) = SA Reading (dBuV/m) + Factor* (dB)

*Factor includes antenna factor , cable loss and amplifier gain

Note 2: Margin (dB) = Emission level (dBuV/m) – Limit (dBuV/m).

Modulation	HT20	Test Freq. (MHz)	5720
Polarization	Horizontal		

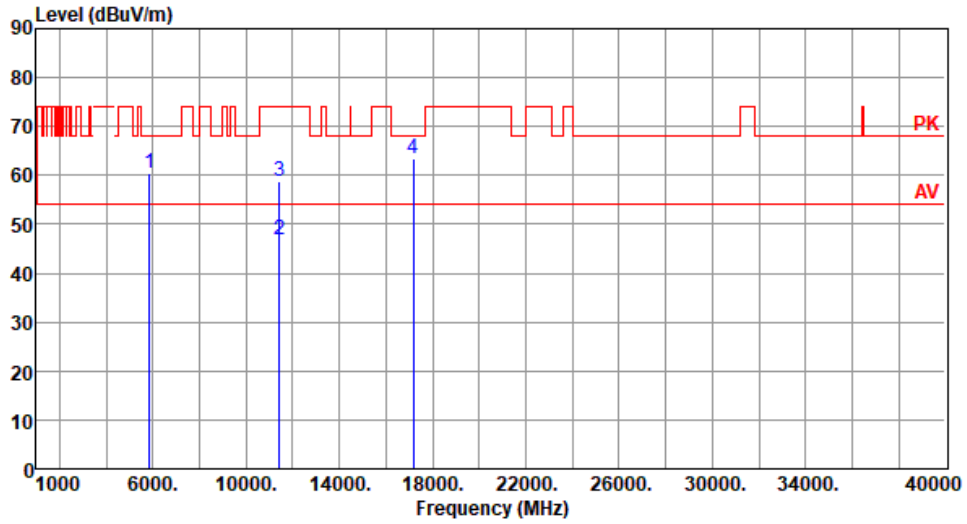

	Freq. MHz	Emission level dBuV/m	Limit dBuV/m	Margin dB	SA reading dBuV	Factor dB	Remark	ANT High cm	Turn Table deg
1	5850.00	60.36	68.20	-7.84	52.34	8.02	Peak	105	206
2	11440.00	46.91	54.00	-7.09	30.17	16.74	Average	100	63
3	11440.00	58.82	74.00	-15.18	42.08	16.74	Peak	100	63
4	17160.00	63.48	68.20	-4.72	45.10	18.38	Peak	105	311

Note 1: Emission Level (dBuV/m) = SA Reading (dBuV/m) + Factor* (dB)

*Factor includes antenna factor , cable loss and amplifier gain

Note 2: Margin (dB) = Emission level (dBuV/m) – Limit (dBuV/m).

Modulation	HT20	Test Freq. (MHz)	5720
Polarization	Vertical		

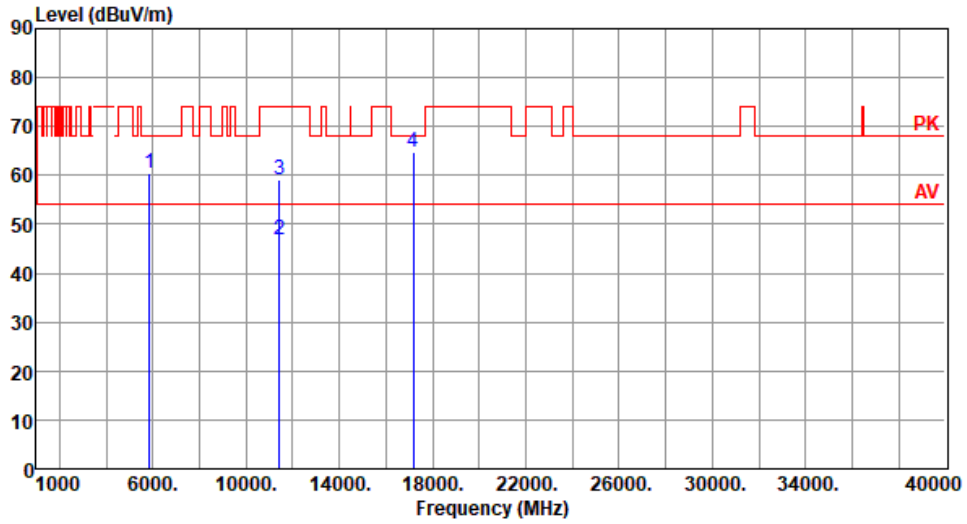

	Freq. MHz	Emission level dBuV/m	Limit dBuV/m	Margin dB	SA reading dBuV	Factor dB	Remark	ANT High cm	Turn Table deg
1	5850.00	60.59	68.20	-7.61	52.57	8.02	Peak	293	248
2	11440.00	46.91	54.00	-7.09	30.17	16.74	Average	100	33
3	11440.00	59.28	74.00	-14.72	42.54	16.74	Peak	100	33
4	17160.00	64.84	68.20	-3.36	46.46	18.38	Peak	242	335

Note 1: Emission Level (dBuV/m) = SA Reading (dBuV/m) + Factor* (dB)

*Factor includes antenna factor , cable loss and amplifier gain

Note 2: Margin (dB) = Emission level (dBuV/m) – Limit (dBuV/m).

Modulation	HT20	Test Freq. (MHz)	5785
Polarization	Horizontal		

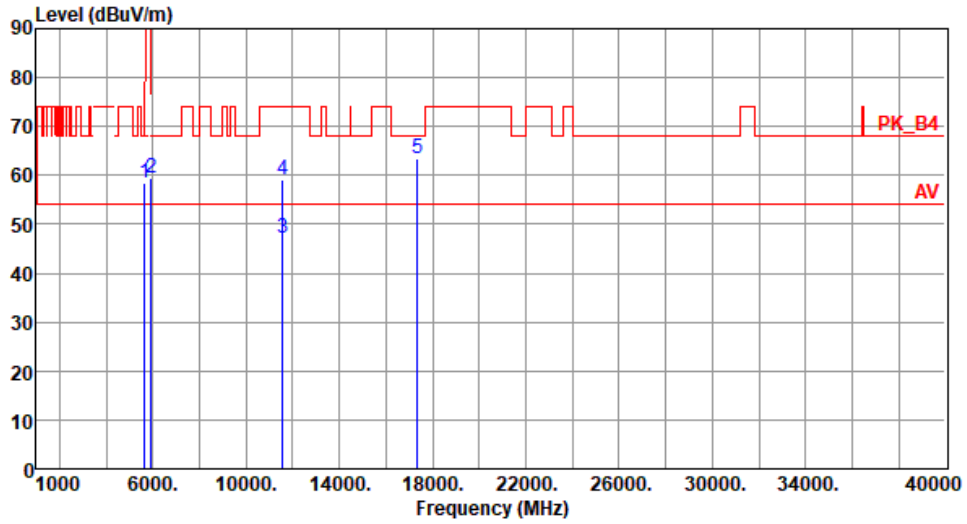

	Freq. MHz	Emission level dBuV/m	Limit dBuV/m	Margin dB	SA reading dBuV	Factor dB	Remark	ANT High cm	Turn Table deg
1	5650.00	58.54	68.20	-9.66	51.15	7.39	Peak	105	206
2	5925.00	59.30	68.20	-8.90	51.23	8.07	Peak	105	206
3	11570.00	47.03	54.00	-6.97	30.42	16.61	Average	100	40
4	11570.00	59.12	74.00	-14.88	42.51	16.61	Peak	100	40
5	17355.00	63.48	68.20	-4.72	44.25	19.23	Peak	100	305

Note 1: Emission Level (dBuV/m) = SA Reading (dBuV/m) + Factor* (dB)

*Factor includes antenna factor , cable loss and amplifier gain

Note 2: Margin (dB) = Emission level (dBuV/m) – Limit (dBuV/m).

Modulation	HT20	Test Freq. (MHz)	5785
Polarization	Vertical		

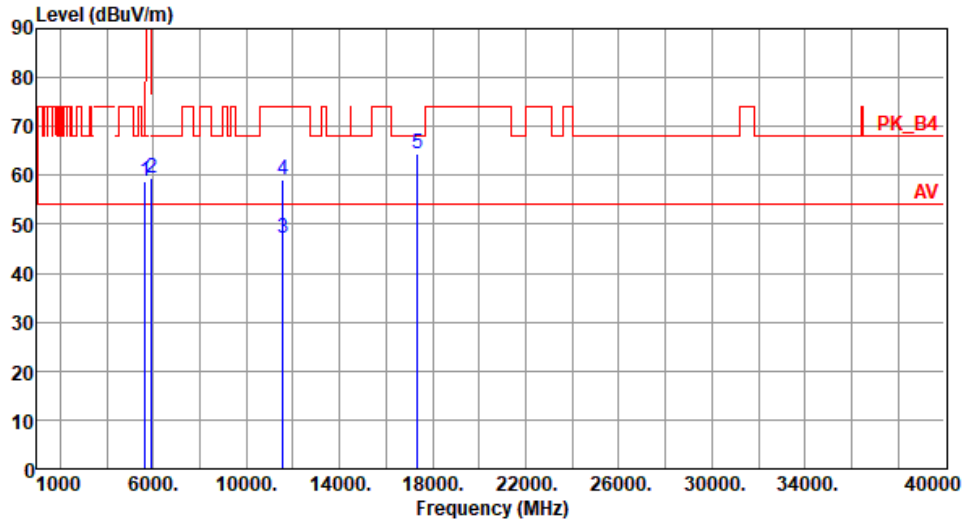

	Freq. MHz	Emission level dBuV/m	Limit dBuV/m	Margin dB	SA reading dBuV	Factor dB	Remark	ANT High cm	Turn Table deg
1	5650.00	58.65	68.20	-9.55	51.26	7.39	Peak	340	235
2	5925.00	59.42	68.20	-8.78	51.35	8.07	Peak	340	235
3	11570.00	47.03	54.00	-6.97	30.42	16.61	Average	100	40
4	11570.00	59.17	74.00	-14.83	42.56	16.61	Peak	100	40
5	17355.00	64.54	68.20	-3.66	45.31	19.23	Peak	245	328

Note 1: Emission Level (dBuV/m) = SA Reading (dBuV/m) + Factor* (dB)

*Factor includes antenna factor , cable loss and amplifier gain

Note 2: Margin (dB) = Emission level (dBuV/m) – Limit (dBuV/m).

Modulation	HT20	Test Freq. (MHz)	5825
Polarization	Horizontal		

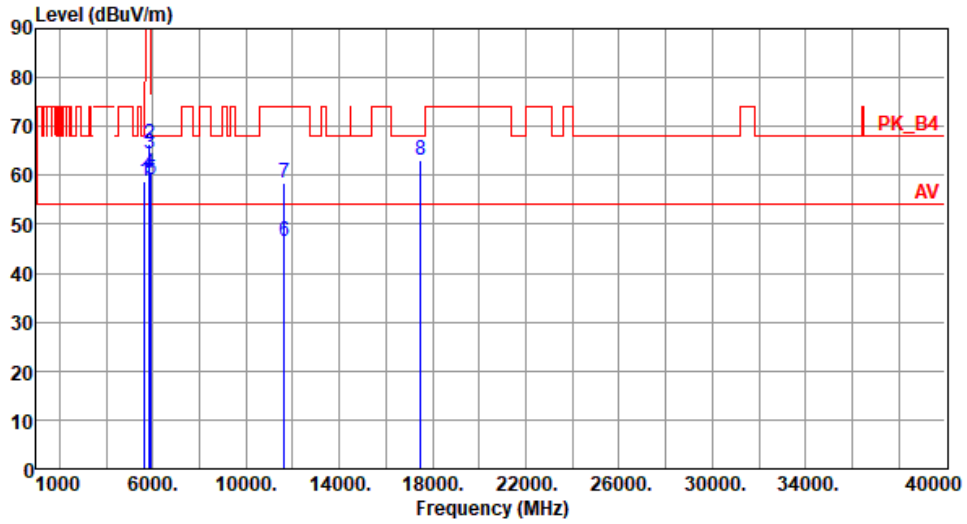

	Freq. MHz	Emission level dBuV/m	Limit dBuV/m	Margin dB	SA reading dBuV	Factor dB	Remark	ANT High cm	Turn Table deg
1	5650.00	58.70	68.20	-9.50	51.31	7.39	Peak	106	205
2	5850.00	66.57	122.20	-55.63	58.55	8.02	Peak	106	205
3	5855.00	64.33	110.80	-46.47	56.31	8.02	Peak	106	205
4	5875.00	60.30	105.20	-44.90	52.27	8.03	Peak	106	205
5	5925.00	59.21	68.20	-8.99	51.14	8.07	Peak	106	205
6	11650.00	46.51	54.00	-7.49	30.13	16.38	Average	100	40
7	11650.00	58.48	74.00	-15.52	42.10	16.38	Peak	100	40
8	17475.00	63.19	68.20	-5.01	43.45	19.74	Peak	100	298

Note 1: Emission Level (dBuV/m) = SA Reading (dBuV/m) + Factor* (dB)

*Factor includes antenna factor , cable loss and amplifier gain

Note 2: Margin (dB) = Emission level (dBuV/m) – Limit (dBuV/m).

Modulation	HT20	Test Freq. (MHz)	5825
Polarization	Vertical		

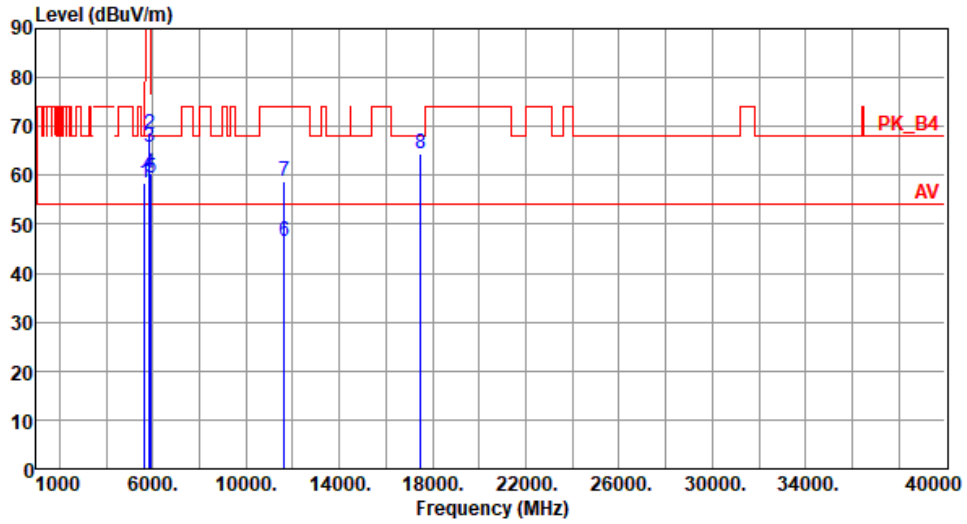

	Freq. MHz	Emission level dBuV/m	Limit dBuV/m	Margin dB	SA reading dBuV	Factor dB	Remark	ANT High cm	Turn Table deg
1	5650.00	58.50	68.20	-9.70	51.11	7.39	Peak	259	255
2	5850.00	68.55	122.20	-53.65	60.53	8.02	Peak	259	255
3	5855.00	65.68	110.80	-45.12	57.66	8.02	Peak	259	255
4	5875.00	60.32	105.20	-44.88	52.29	8.03	Peak	259	255
5	5925.00	59.47	68.20	-8.73	51.40	8.07	Peak	259	255
6	11650.00	46.63	54.00	-7.37	30.25	16.38	Average	100	20
7	11650.00	58.84	74.00	-15.16	42.46	16.38	Peak	100	20
8	17475.00	64.39	68.20	-3.81	44.65	19.74	Peak	235	331

Note 1: Emission Level (dBuV/m) = SA Reading (dBuV/m) + Factor* (dB)

*Factor includes antenna factor , cable loss and amplifier gain

Note 2: Margin (dB) = Emission level (dBuV/m) – Limit (dBuV/m).

3.5.15 Transmitter Radiated Unwanted Emissions (Above 1GHz) for HT40

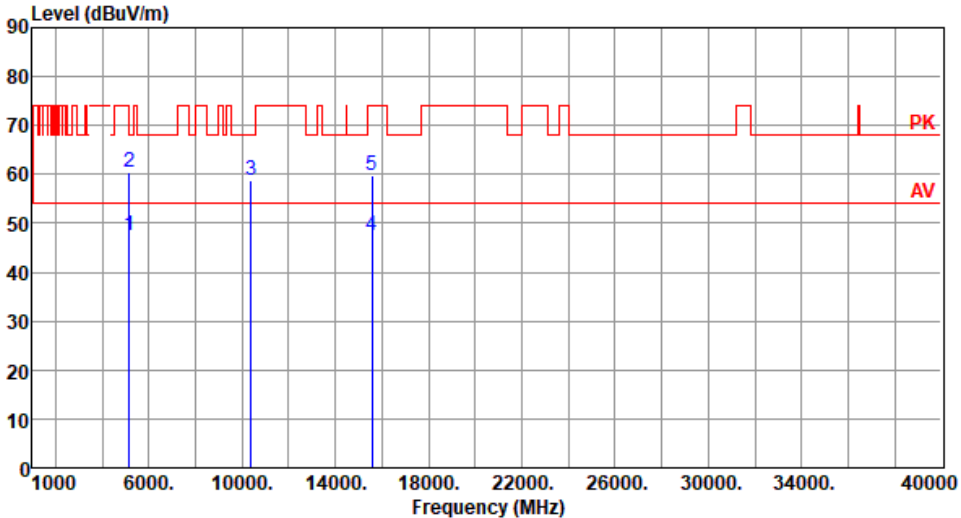
Modulation	HT40	Test Freq. (MHz)	5190																																																																										
Polarization	Horizontal																																																																												
																																																																													
	<table border="1"> <thead> <tr> <th>Freq.</th> <th>Emission level</th> <th>Limit</th> <th>Margin</th> <th>SA reading</th> <th>Factor</th> <th>Remark</th> <th>ANT High</th> <th>Turn Table</th> </tr> <tr> <th>MHz</th> <th>dBuV/m</th> <th>dBuV/m</th> <th>dB</th> <th>dBuV</th> <th>dB</th> <th></th> <th>cm</th> <th>deg</th> </tr> </thead> <tbody> <tr> <td>1</td> <td>5150.00</td> <td>47.47</td> <td>54.00</td> <td>-6.53</td> <td>40.15</td> <td>7.32</td> <td>Average</td> <td>119</td> <td>237</td> </tr> <tr> <td>2</td> <td>5150.00</td> <td>60.52</td> <td>74.00</td> <td>-13.48</td> <td>53.20</td> <td>7.32</td> <td>Peak</td> <td>119</td> <td>237</td> </tr> <tr> <td>3</td> <td>10380.00</td> <td>58.73</td> <td>68.20</td> <td>-9.47</td> <td>42.55</td> <td>16.18</td> <td>Peak</td> <td>100</td> <td>40</td> </tr> <tr> <td>4</td> <td>15570.00</td> <td>47.45</td> <td>54.00</td> <td>-6.55</td> <td>30.13</td> <td>17.32</td> <td>Average</td> <td>100</td> <td>60</td> </tr> <tr> <td>5</td> <td>15570.00</td> <td>59.93</td> <td>74.00</td> <td>-14.07</td> <td>42.61</td> <td>17.32</td> <td>Peak</td> <td>100</td> <td>60</td> </tr> </tbody> </table>	Freq.	Emission level	Limit	Margin	SA reading	Factor	Remark	ANT High	Turn Table	MHz	dBuV/m	dBuV/m	dB	dBuV	dB		cm	deg	1	5150.00	47.47	54.00	-6.53	40.15	7.32	Average	119	237	2	5150.00	60.52	74.00	-13.48	53.20	7.32	Peak	119	237	3	10380.00	58.73	68.20	-9.47	42.55	16.18	Peak	100	40	4	15570.00	47.45	54.00	-6.55	30.13	17.32	Average	100	60	5	15570.00	59.93	74.00	-14.07	42.61	17.32	Peak	100	60								
Freq.	Emission level	Limit	Margin	SA reading	Factor	Remark	ANT High	Turn Table																																																																					
MHz	dBuV/m	dBuV/m	dB	dBuV	dB		cm	deg																																																																					
1	5150.00	47.47	54.00	-6.53	40.15	7.32	Average	119	237																																																																				
2	5150.00	60.52	74.00	-13.48	53.20	7.32	Peak	119	237																																																																				
3	10380.00	58.73	68.20	-9.47	42.55	16.18	Peak	100	40																																																																				
4	15570.00	47.45	54.00	-6.55	30.13	17.32	Average	100	60																																																																				
5	15570.00	59.93	74.00	-14.07	42.61	17.32	Peak	100	60																																																																				
<p>Note 1: Emission Level (dBuV/m) = SA Reading (dBuV/m) + Factor* (dB) *Factor includes antenna factor , cable loss and amplifier gain Note 2: Margin (dB) = Emission level (dBuV/m) – Limit (dBuV/m).</p>																																																																													

Modulation	HT40	Test Freq. (MHz)	5190
Polarization	Vertical		

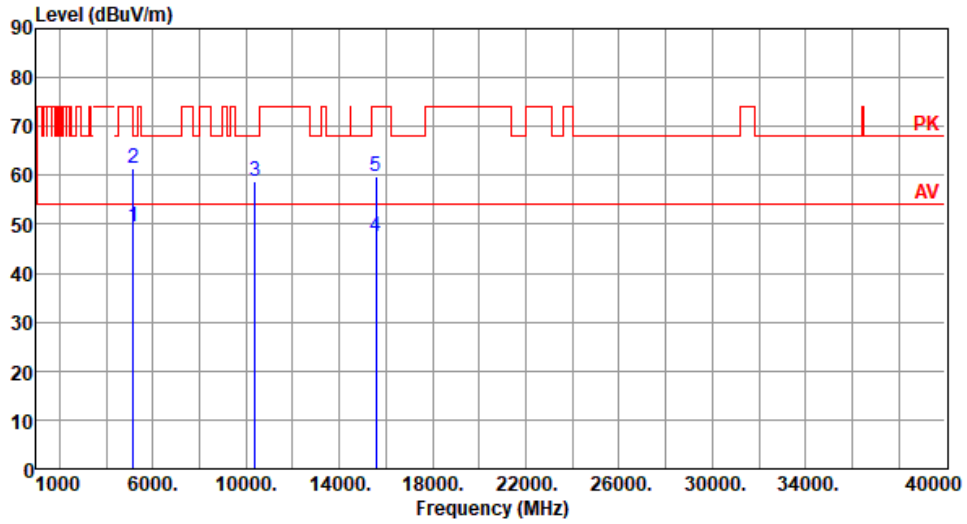

	Freq. MHz	Emission level dBuV/m	Limit dBuV/m	Margin dB	SA reading dBuV	Factor dB	Remark	ANT High cm	Turn Table deg
1	5150.00	49.32	54.00	-4.68	42.00	7.32	Average	208	250
2	5150.00	61.58	74.00	-12.42	54.26	7.32	Peak	208	250
3	10380.00	58.78	68.20	-9.42	42.60	16.18	Peak	100	30
4	15570.00	47.58	54.00	-6.42	30.26	17.32	Average	100	50
5	15570.00	59.86	74.00	-14.14	42.54	17.32	Peak	100	50

Note 1: Emission Level (dBuV/m) = SA Reading (dBuV/m) + Factor* (dB)

*Factor includes antenna factor , cable loss and amplifier gain

Note 2: Margin (dB) = Emission level (dBuV/m) – Limit (dBuV/m).

Modulation	HT40	Test Freq. (MHz)	5310
Polarization	Horizontal		

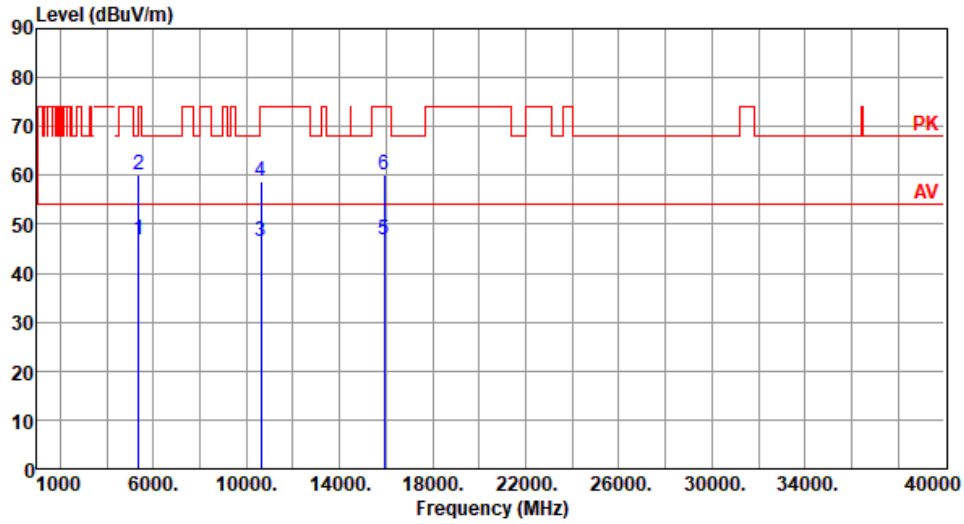

	Freq. MHz	Emission level dBuV/m	Limit dBuV/m	Margin dB	SA reading dBuV	Factor dB	Remark	ANT High cm	Turn Table deg
1	5350.00	46.88	54.00	-7.12	40.03	6.85	Average	111	239
2	5350.00	60.07	74.00	-13.93	53.22	6.85	Peak	111	239
3	10620.00	46.51	54.00	-7.49	30.14	16.37	Average	100	40
4	10620.00	58.62	74.00	-15.38	42.25	16.37	Peak	100	40
5	15930.00	46.84	54.00	-7.16	30.23	16.61	Average	100	80
6	15930.00	60.03	74.00	-13.97	43.42	16.61	Peak	100	80

Note 1: Emission Level (dBuV/m) = SA Reading (dBuV/m) + Factor* (dB)

*Factor includes antenna factor , cable loss and amplifier gain

Note 2: Margin (dB) = Emission level (dBuV/m) – Limit (dBuV/m).

Modulation	HT40	Test Freq. (MHz)	5310
Polarization	Vertical		

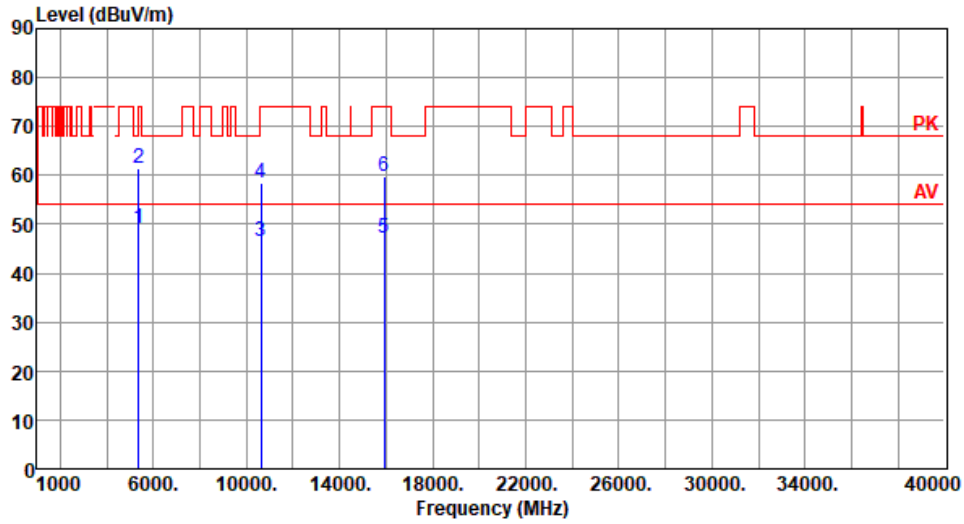

	Freq. MHz	Emission level dBuV/m	Limit dBuV/m	Margin dB	SA reading dBuV	Factor dB	Remark	ANT High cm	Turn Table deg
1	5350.00	49.06	54.00	-4.94	42.21	6.85	Average	214	271
2	5350.00	61.44	74.00	-12.56	54.59	6.85	Peak	214	271
3	10620.00	46.61	54.00	-7.39	30.24	16.37	Average	100	30
4	10620.00	58.51	74.00	-15.49	42.14	16.37	Peak	100	30
5	15930.00	47.06	54.00	-6.94	30.45	16.61	Average	100	50
6	15930.00	59.82	74.00	-14.18	43.21	16.61	Peak	100	50

Note 1: Emission Level (dBuV/m) = SA Reading (dBuV/m) + Factor* (dB)

*Factor includes antenna factor , cable loss and amplifier gain

Note 2: Margin (dB) = Emission level (dBuV/m) – Limit (dBuV/m).

Modulation	HT40	Test Freq. (MHz)	5510
Polarization	Horizontal		

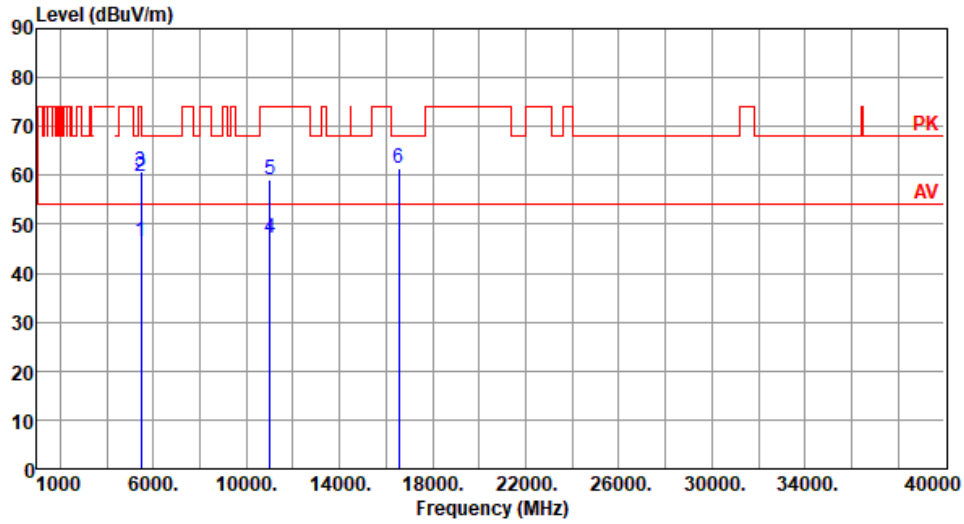

	Freq. MHz	Emission level dBuV/m	Limit dBuV/m	Margin dB	SA reading dBuV	Factor dB	Remark	ANT High cm	Turn Table deg
1	5460.00	46.53	54.00	-7.47	39.28	7.25	Average	108	205
2	5460.00	59.68	74.00	-14.32	52.43	7.25	Peak	108	205
3	5470.00	60.84	68.20	-7.36	53.56	7.28	Peak	108	205
4	11020.00	47.16	54.00	-6.84	30.35	16.81	Average	100	55
5	11020.00	59.27	74.00	-14.73	42.46	16.81	Peak	100	55
6	16530.00	61.29	68.20	-6.91	43.46	17.83	Peak	100	80

Note 1: Emission Level (dBuV/m) = SA Reading (dBuV/m) + Factor* (dB)

*Factor includes antenna factor , cable loss and amplifier gain

Note 2: Margin (dB) = Emission level (dBuV/m) – Limit (dBuV/m).

Modulation	HT40	Test Freq. (MHz)	5510
Polarization	Vertical		

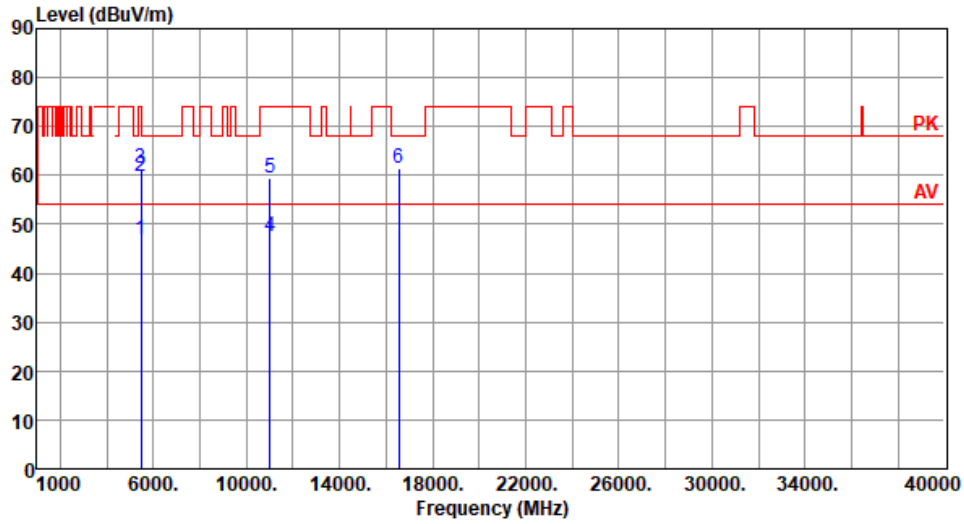

	Freq. MHz	Emission level dBuV/m	Limit dBuV/m	Margin dB	SA reading dBuV	Factor dB	Remark	ANT High cm	Turn Table deg
1	5460.00	46.70	54.00	-7.30	39.45	7.25	Average	216	255
2	5460.00	59.81	74.00	-14.19	52.56	7.25	Peak	216	255
3	5470.00	61.49	68.20	-6.71	54.21	7.28	Peak	216	255
4	11020.00	47.37	54.00	-6.63	30.56	16.81	Average	100	60
5	11020.00	59.39	74.00	-14.61	42.58	16.81	Peak	100	60
6	16530.00	61.41	68.20	-6.79	43.58	17.83	Peak	100	90

Note 1: Emission Level (dBuV/m) = SA Reading (dBuV/m) + Factor* (dB)

*Factor includes antenna factor , cable loss and amplifier gain

Note 2: Margin (dB) = Emission level (dBuV/m) – Limit (dBuV/m).

Modulation	HT40	Test Freq. (MHz)	5670
Polarization	Horizontal		

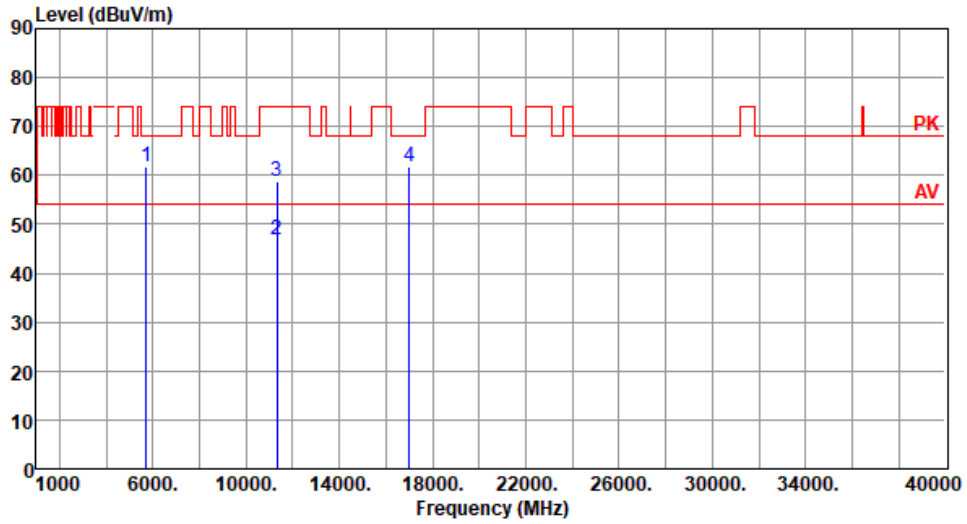

	Freq. MHz	Emission level dBuV/m	Limit dBuV/m	Margin dB	SA reading dBuV	Factor dB	Remark	ANT High cm	Turn Table deg
1	5700.00	61.82	68.20	-6.38	54.32	7.50	Peak	115	206
2	11340.00	46.74	54.00	-7.26	30.16	16.58	Average	100	60
3	11340.00	58.71	74.00	-15.29	42.13	16.58	Peak	100	60
4	17010.00	61.78	68.20	-6.42	43.12	18.66	Peak	100	80

Note 1: Emission Level (dBuV/m) = SA Reading (dBuV/m) + Factor* (dB)

*Factor includes antenna factor , cable loss and amplifier gain

Note 2: Margin (dB) = Emission level (dBuV/m) – Limit (dBuV/m).

Modulation	HT40	Test Freq. (MHz)	5670
Polarization	Vertical		

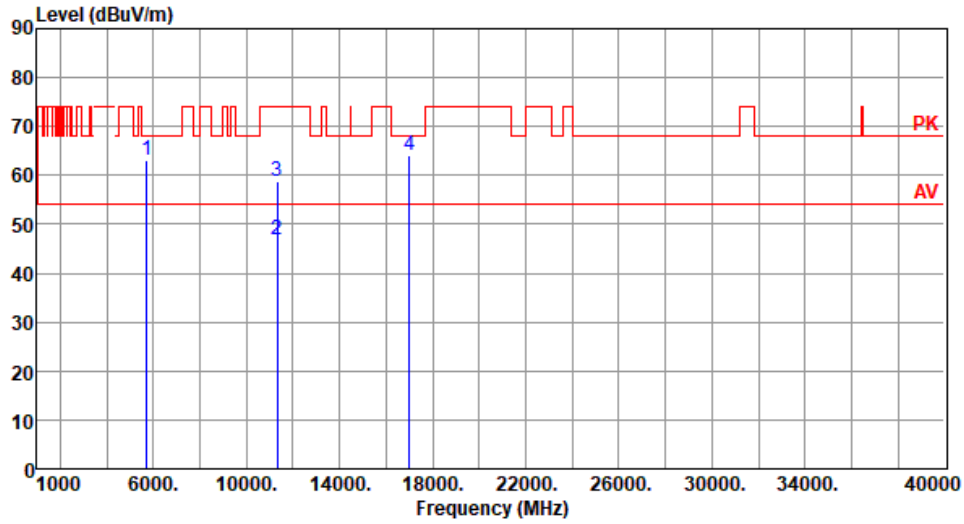

	Freq. MHz	Emission level dBuV/m	Limit dBuV/m	Margin dB	SA reading dBuV	Factor dB	Remark	ANT High cm	Turn Table deg
1	5725.00	63.11	68.20	-5.09	55.45	7.66	Peak	252	247
2	11340.00	46.84	54.00	-7.16	30.26	16.58	Average	100	50
3	11340.00	58.79	74.00	-15.21	42.21	16.58	Peak	100	50
4	17010.00	64.11	68.20	-4.09	45.45	18.66	Peak	244	326

Note 1: Emission Level (dBuV/m) = SA Reading (dBuV/m) + Factor* (dB)

*Factor includes antenna factor , cable loss and amplifier gain

Note 2: Margin (dB) = Emission level (dBuV/m) – Limit (dBuV/m).

Modulation	HT40	Test Freq. (MHz)	5710
Polarization	Horizontal		

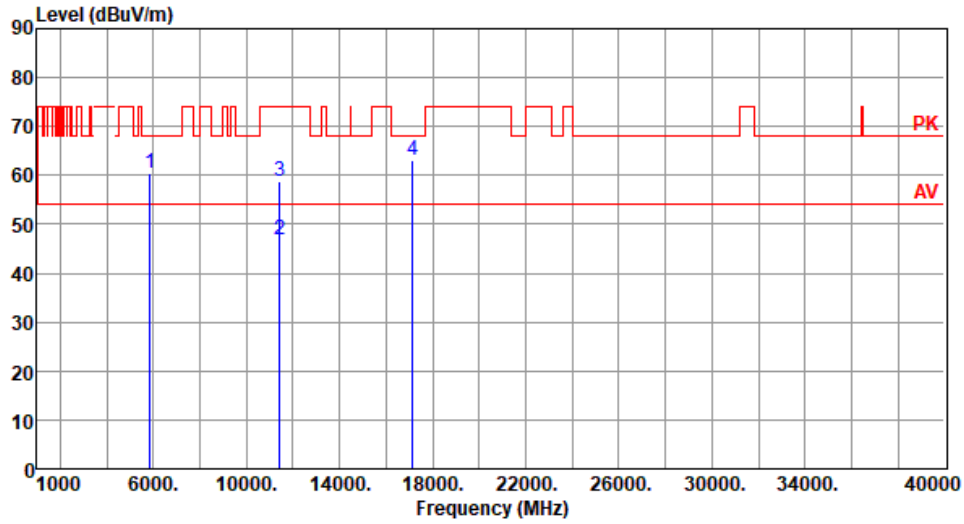

	Freq. MHz	Emission level dBuV/m	Limit dBuV/m	Margin dB	SA reading dBuV	Factor dB	Remark	ANT High cm	Turn Table deg
1	5850.00	60.56	68.20	-7.64	52.54	8.02	Peak	113	208
2	11420.00	46.82	54.00	-7.18	30.09	16.73	Average	100	29
3	11420.00	58.94	74.00	-15.06	42.21	16.73	Peak	100	29
4	17130.00	63.25	68.20	-4.95	44.95	18.30	Peak	100	305

Note 1: Emission Level (dBuV/m) = SA Reading (dBuV/m) + Factor* (dB)

*Factor includes antenna factor , cable loss and amplifier gain

Note 2: Margin (dB) = Emission level (dBuV/m) – Limit (dBuV/m).

Modulation	HT40	Test Freq. (MHz)	5710
Polarization	Vertical		

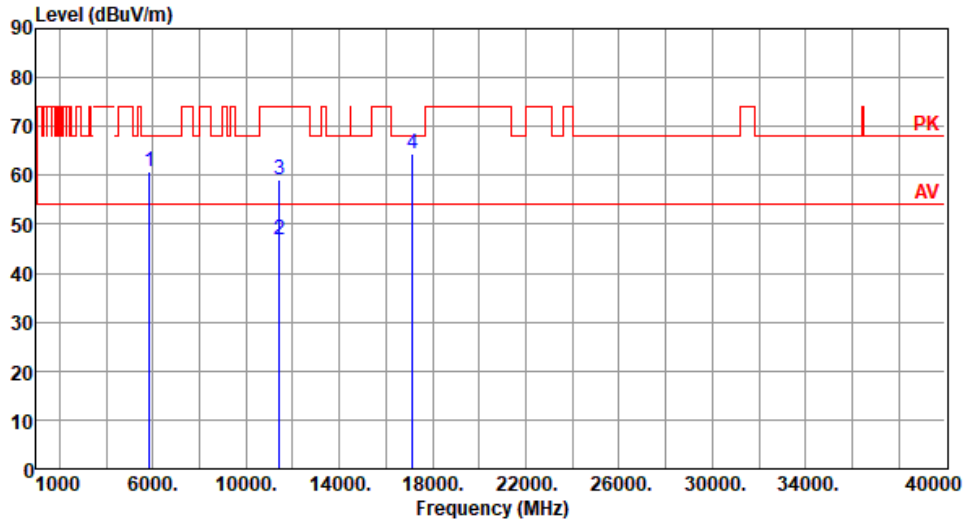

	Freq. MHz	Emission level dBuV/m	Limit dBuV/m	Margin dB	SA reading dBuV	Factor dB	Remark	ANT High cm	Turn Table deg
1	5850.00	60.74	68.20	-7.46	52.72	8.02	Peak	300	241
2	11420.00	46.98	54.00	-7.02	30.25	16.73	Average	100	58
3	11420.00	59.21	74.00	-14.79	42.48	16.73	Peak	100	58
4	17130.00	64.34	68.20	-3.86	46.04	18.30	Peak	252	322

Note 1: Emission Level (dBuV/m) = SA Reading (dBuV/m) + Factor* (dB)

*Factor includes antenna factor , cable loss and amplifier gain

Note 2: Margin (dB) = Emission level (dBuV/m) – Limit (dBuV/m).

Modulation	HT40	Test Freq. (MHz)	5795
Polarization	Horizontal		

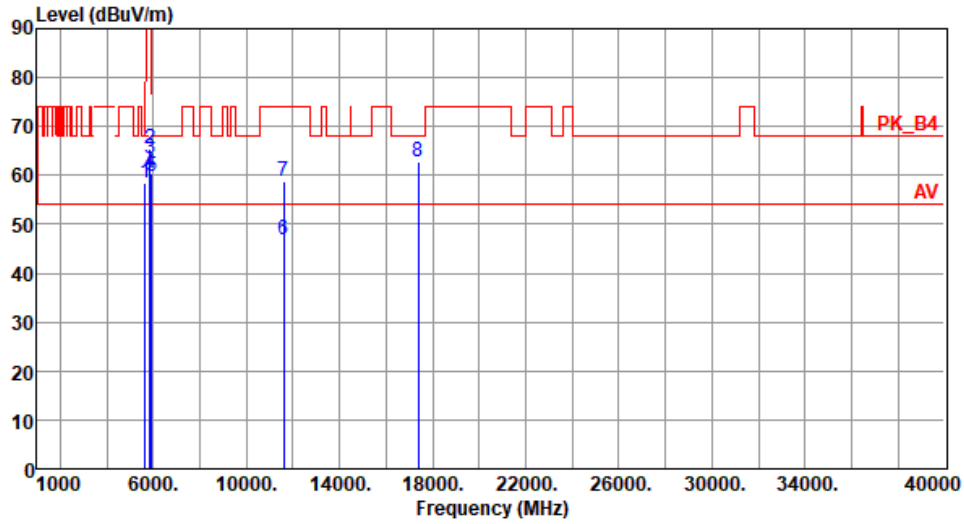

	Freq. MHz	Emission level dBuV/m	Limit dBuV/m	Margin dB	SA reading dBuV	Factor dB	Remark	ANT High cm	Turn Table deg
1	5650.00	58.52	68.20	-9.68	51.13	7.39	Peak	113	205
2	5850.00	65.48	122.20	-56.72	57.46	8.02	Peak	113	205
3	5855.00	63.35	110.80	-47.45	55.33	8.02	Peak	113	205
4	5875.00	60.58	105.20	-44.62	52.55	8.03	Peak	113	205
5	5925.00	59.63	68.20	-8.57	51.56	8.07	Peak	113	205
6	11590.00	46.69	54.00	-7.31	30.12	16.57	Average	100	55
7	11590.00	58.87	74.00	-15.13	42.30	16.57	Peak	100	55
8	17385.00	62.91	68.20	-5.29	43.56	19.35	Peak	100	302

Note 1: Emission Level (dBuV/m) = SA Reading (dBuV/m) + Factor* (dB)

*Factor includes antenna factor , cable loss and amplifier gain

Note 2: Margin (dB) = Emission level (dBuV/m) – Limit (dBuV/m).

Modulation	HT40	Test Freq. (MHz)	5795
Polarization	Vertical		

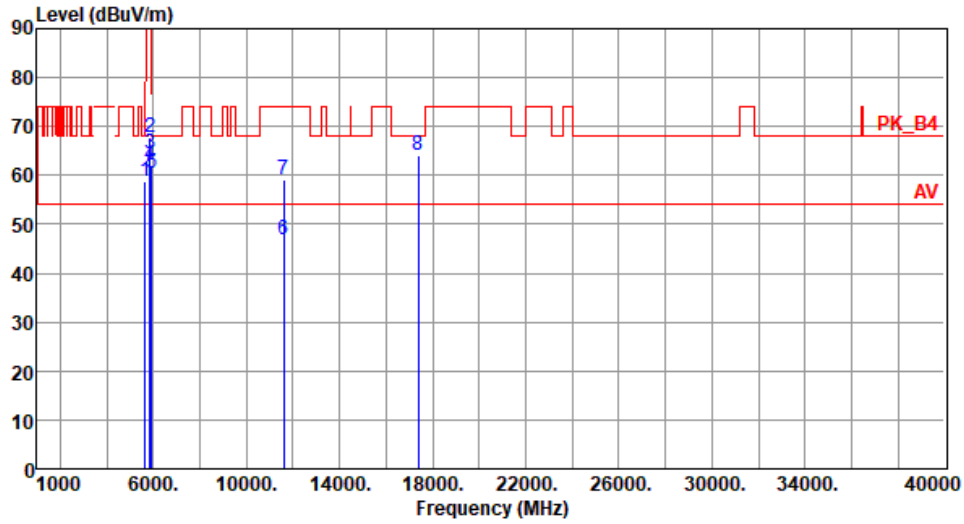

	Freq. MHz	Emission level dBuV/m	Limit dBuV/m	Margin dB	SA reading dBuV	Factor dB	Remark	ANT High cm	Turn Table deg
1	5650.00	58.65	68.20	-9.55	51.26	7.39	Peak	300	246
2	5850.00	67.87	122.20	-54.33	59.85	8.02	Peak	300	246
3	5855.00	64.57	110.80	-46.23	56.55	8.02	Peak	300	246
4	5875.00	61.99	105.20	-43.21	53.96	8.03	Peak	300	246
5	5925.00	60.54	68.20	-7.66	52.47	8.07	Peak	300	246
6	11590.00	46.82	54.00	-7.18	30.25	16.57	Average	100	60
7	11590.00	59.04	74.00	-14.96	42.47	16.57	Peak	100	60
8	17385.00	64.07	68.20	-4.13	44.72	19.35	Peak	252	324

Note 1: Emission Level (dBuV/m) = SA Reading (dBuV/m) + Factor* (dB)

*Factor includes antenna factor , cable loss and amplifier gain

Note 2: Margin (dB) = Emission level (dBuV/m) – Limit (dBuV/m).

Configuration 4 : Antenna 1004788 & 1004791

3.5.16 Transmitter Radiated Unwanted Emissions (Below 1GHz)

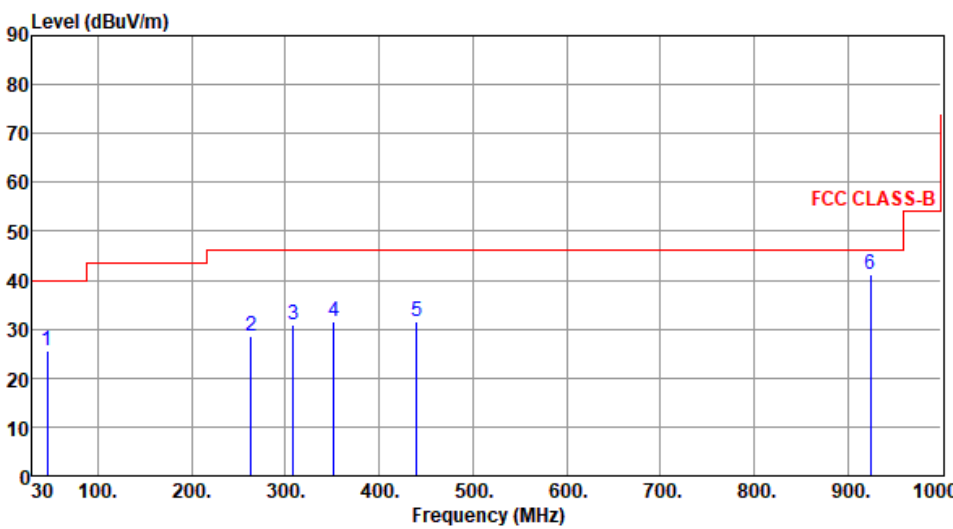
Modulation	11a	Test Freq. (MHz)	5240					
Polarization	Horizontal							
 <p>The graph plots Level (dBuV/m) on the y-axis (0 to 90) against Frequency (MHz) on the x-axis (30 to 1000). A red line represents the FCC CLASS-B limit, which is 40 dBuV/m from 30 to 100 MHz, 45 dBuV/m from 100 to 300 MHz, and 55 dBuV/m from 300 to 1000 MHz. Six blue vertical lines represent emission peaks labeled 1 through 6, with their respective frequencies and levels indicated in the table below.</p>								
Freq. MHz	Emission level dBuV/m	Limit dBuV/m	Margin dB	SA reading dBuV	Factor dB	Remark	ANT High cm	Turn Table deg
1	45.52	40.00	-14.44	34.32	-8.76	Peak	---	---
2	263.77	46.00	-17.60	38.14	-9.74	Peak	---	---
3	308.39	46.00	-15.19	39.03	-8.22	Peak	---	---
4	352.04	46.00	-14.31	38.89	-7.20	Peak	---	---
5	440.31	46.00	-14.35	35.94	-4.29	Peak	---	---
6	924.34	46.00	-4.86	36.20	4.94	Peak	---	---

Note 1: Emission Level (dBuV/m) = SA Reading (dBuV/m) + Factor* (dB)

*Factor includes antenna factor , cable loss and amplifier gain

Note 2: Margin (dB) = Emission level (dBuV/m) – Limit (dBuV/m).

Note 3: All spurious emissions below 30MHz are more than 20 dB below the limit.

Modulation	11a	Test Freq. (MHz)	5240
Polarization	Vertical		

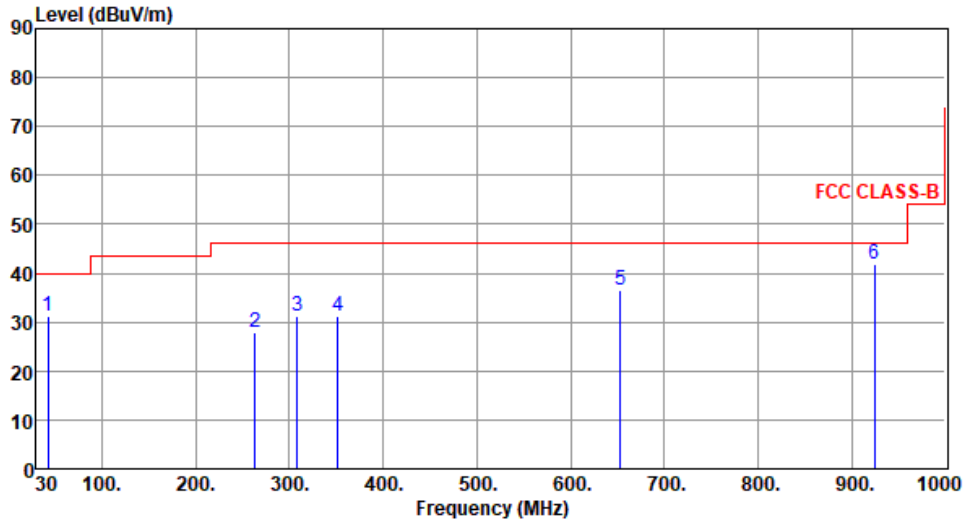

	Freq. MHz	Emission level dBuV/m	Limit dBuV/m	Margin dB	SA reading dBuV	Factor dB	Remark	ANT High cm	Turn Table deg
1	42.61	31.23	40.00	-8.77	40.05	-8.82	Peak	---	---
2	263.77	28.02	46.00	-17.98	37.76	-9.74	Peak	---	---
3	308.39	31.28	46.00	-14.72	39.50	-8.22	Peak	---	---
4	352.04	31.31	46.00	-14.69	38.51	-7.20	Peak	---	---
5	652.74	36.64	46.00	-9.36	36.00	0.64	Peak	---	---
6	924.34	41.91	46.00	-4.09	36.97	4.94	Peak	---	---

Note 1: Emission Level (dBuV/m) = SA Reading (dBuV/m) + Factor* (dB)

*Factor includes antenna factor , cable loss and amplifier gain

Note 2: Margin (dB) = Emission level (dBuV/m) – Limit (dBuV/m).

Note 3: All spurious emissions below 30MHz are more than 20 dB below the limit.

Modulation	HT40	Test Freq. (MHz)	5795
Polarization	Horizontal		

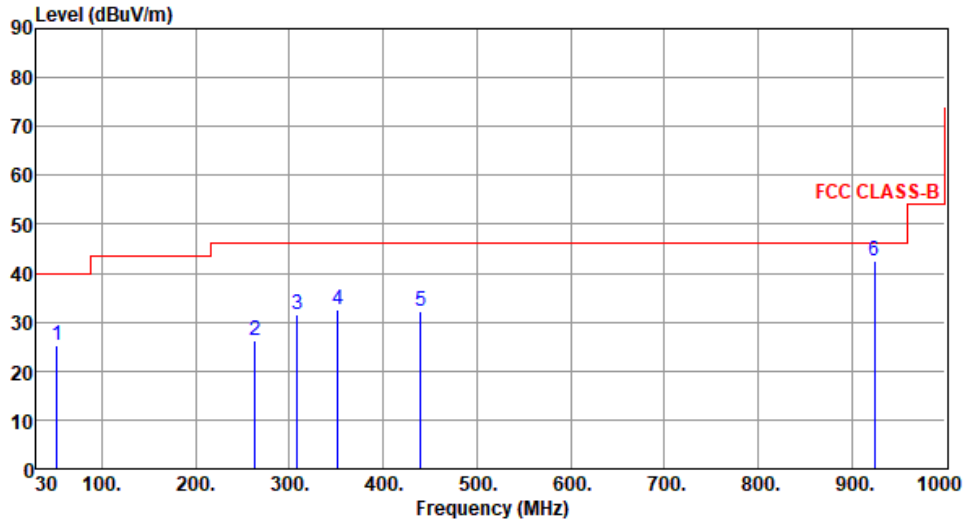

	Freq. MHz	Emission level dBuV/m	Limit dBuV/m	Margin dB	SA reading dBuV	Factor dB	Remark	ANT High cm	Turn Table deg
1	52.31	25.30	40.00	-14.70	34.23	-8.93	Peak	---	---
2	263.77	26.28	46.00	-19.72	36.02	-9.74	Peak	---	---
3	308.39	31.57	46.00	-14.43	39.79	-8.22	Peak	---	---
4	352.04	32.55	46.00	-13.45	39.75	-7.20	Peak	---	---
5	440.31	32.17	46.00	-13.83	36.46	-4.29	Peak	---	---
6	924.34	42.58	46.00	-3.42	37.64	4.94	Peak	---	---

Note 1: Emission Level (dBuV/m) = SA Reading (dBuV/m) + Factor* (dB)

*Factor includes antenna factor , cable loss and amplifier gain

Note 2: Margin (dB) = Emission level (dBuV/m) – Limit (dBuV/m).

Note 3: All spurious emissions below 30MHz are more than 20 dB below the limit.

Modulation	HT40	Test Freq. (MHz)	5795
Polarization	Vertical		

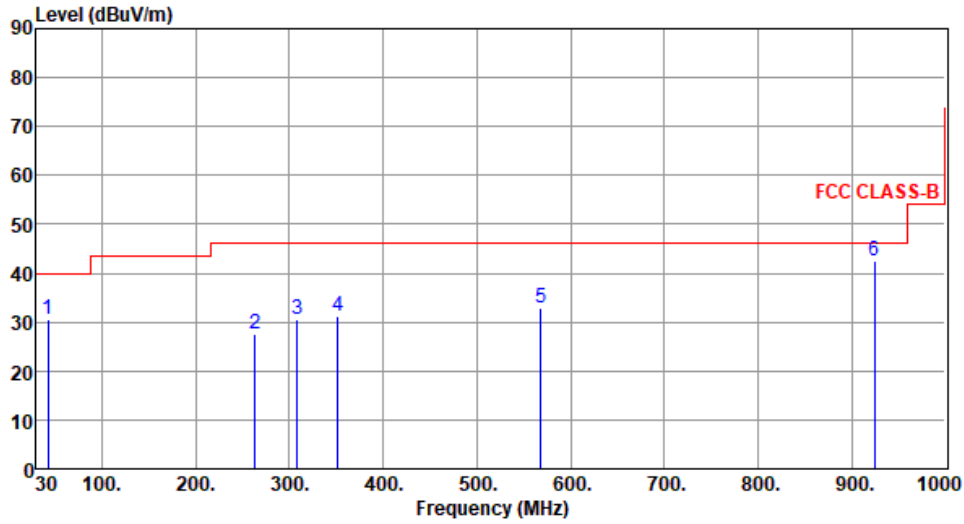

	Freq. MHz	Emission level dBuV/m	Limit dBuV/m	Margin dB	SA reading dBuV	Factor dB	Remark	ANT High cm	Turn Table deg
1	42.61	30.69	40.00	-9.31	39.51	-8.82	Peak	---	---
2	263.77	27.57	46.00	-18.43	37.31	-9.74	Peak	---	---
3	308.39	30.51	46.00	-15.49	38.73	-8.22	Peak	---	---
4	352.04	31.37	46.00	-14.63	38.57	-7.20	Peak	---	---
5	568.35	33.02	46.00	-12.98	34.89	-1.87	Peak	---	---
6	924.34	42.48	46.00	-3.52	37.54	4.94	Peak	---	---

Note 1: Emission Level (dBuV/m) = SA Reading (dBuV/m) + Factor* (dB)

*Factor includes antenna factor , cable loss and amplifier gain

Note 2: Margin (dB) = Emission level (dBuV/m) – Limit (dBuV/m).

Note 3: All spurious emissions below 30MHz are more than 20 dB below the limit.

3.5.17 Transmitter Radiated Unwanted Emissions (Above 1GHz) for 11a

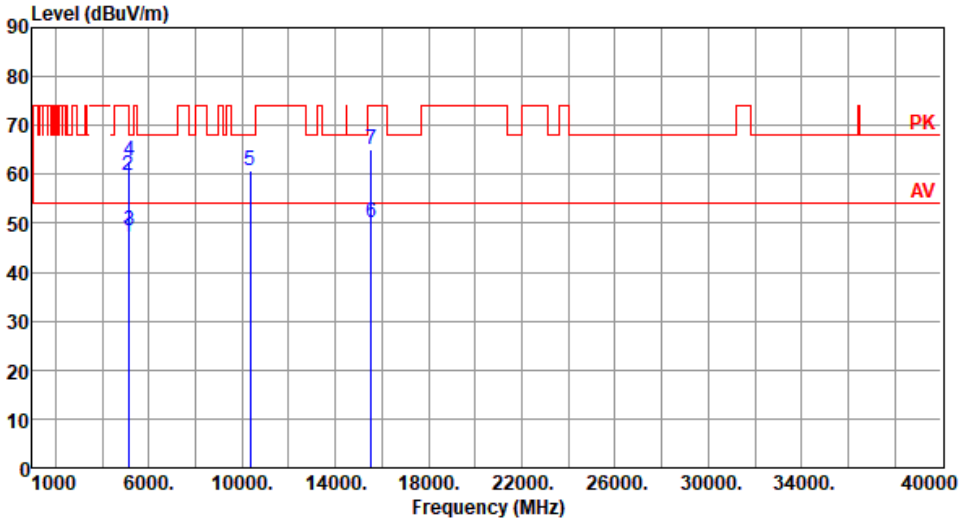
Modulation	11a	Test Freq. (MHz)	5180																																																																																														
Polarization	Horizontal																																																																																																
																																																																																																	
	<table border="1"> <thead> <tr> <th>Freq.</th> <th>Emission level</th> <th>Limit</th> <th>Margin</th> <th>SA reading</th> <th>Factor</th> <th>Remark</th> <th>ANT High</th> <th>Turn Table</th> </tr> <tr> <th>MHz</th> <th>dBuV/m</th> <th>dBuV/m</th> <th>dB</th> <th>dBuV</th> <th>dB</th> <th></th> <th>cm</th> <th>deg</th> </tr> </thead> <tbody> <tr> <td>1</td> <td>5120.00</td> <td>47.12</td> <td>54.00</td> <td>-6.88</td> <td>39.81</td> <td>7.31</td> <td>Average</td> <td>293</td> <td>150</td> </tr> <tr> <td>2</td> <td>5120.00</td> <td>59.77</td> <td>74.00</td> <td>-14.23</td> <td>52.46</td> <td>7.31</td> <td>Peak</td> <td>293</td> <td>150</td> </tr> <tr> <td>3</td> <td>5150.00</td> <td>48.47</td> <td>54.00</td> <td>-5.53</td> <td>41.15</td> <td>7.32</td> <td>Average</td> <td>293</td> <td>153</td> </tr> <tr> <td>4</td> <td>5150.00</td> <td>62.85</td> <td>74.00</td> <td>-11.15</td> <td>55.53</td> <td>7.32</td> <td>Peak</td> <td>293</td> <td>153</td> </tr> <tr> <td>5</td> <td>10360.00</td> <td>60.64</td> <td>68.20</td> <td>-7.56</td> <td>44.55</td> <td>16.09</td> <td>Peak</td> <td>100</td> <td>335</td> </tr> <tr> <td>6</td> <td>15540.00</td> <td>50.16</td> <td>54.00</td> <td>-3.84</td> <td>32.79</td> <td>17.37</td> <td>Average</td> <td>185</td> <td>21</td> </tr> <tr> <td>7</td> <td>15540.00</td> <td>65.08</td> <td>74.00</td> <td>-8.92</td> <td>47.71</td> <td>17.37</td> <td>Peak</td> <td>185</td> <td>21</td> </tr> </tbody> </table>	Freq.	Emission level	Limit	Margin	SA reading	Factor	Remark	ANT High	Turn Table	MHz	dBuV/m	dBuV/m	dB	dBuV	dB		cm	deg	1	5120.00	47.12	54.00	-6.88	39.81	7.31	Average	293	150	2	5120.00	59.77	74.00	-14.23	52.46	7.31	Peak	293	150	3	5150.00	48.47	54.00	-5.53	41.15	7.32	Average	293	153	4	5150.00	62.85	74.00	-11.15	55.53	7.32	Peak	293	153	5	10360.00	60.64	68.20	-7.56	44.55	16.09	Peak	100	335	6	15540.00	50.16	54.00	-3.84	32.79	17.37	Average	185	21	7	15540.00	65.08	74.00	-8.92	47.71	17.37	Peak	185	21								
Freq.	Emission level	Limit	Margin	SA reading	Factor	Remark	ANT High	Turn Table																																																																																									
MHz	dBuV/m	dBuV/m	dB	dBuV	dB		cm	deg																																																																																									
1	5120.00	47.12	54.00	-6.88	39.81	7.31	Average	293	150																																																																																								
2	5120.00	59.77	74.00	-14.23	52.46	7.31	Peak	293	150																																																																																								
3	5150.00	48.47	54.00	-5.53	41.15	7.32	Average	293	153																																																																																								
4	5150.00	62.85	74.00	-11.15	55.53	7.32	Peak	293	153																																																																																								
5	10360.00	60.64	68.20	-7.56	44.55	16.09	Peak	100	335																																																																																								
6	15540.00	50.16	54.00	-3.84	32.79	17.37	Average	185	21																																																																																								
7	15540.00	65.08	74.00	-8.92	47.71	17.37	Peak	185	21																																																																																								
<p>Note 1: Emission Level (dBuV/m) = SA Reading (dBuV/m) + Factor* (dB) *Factor includes antenna factor , cable loss and amplifier gain Note 2: Margin (dB) = Emission level (dBuV/m) – Limit (dBuV/m).</p>																																																																																																	

Modulation	11a	Test Freq. (MHz)	5180
Polarization	Vertical		

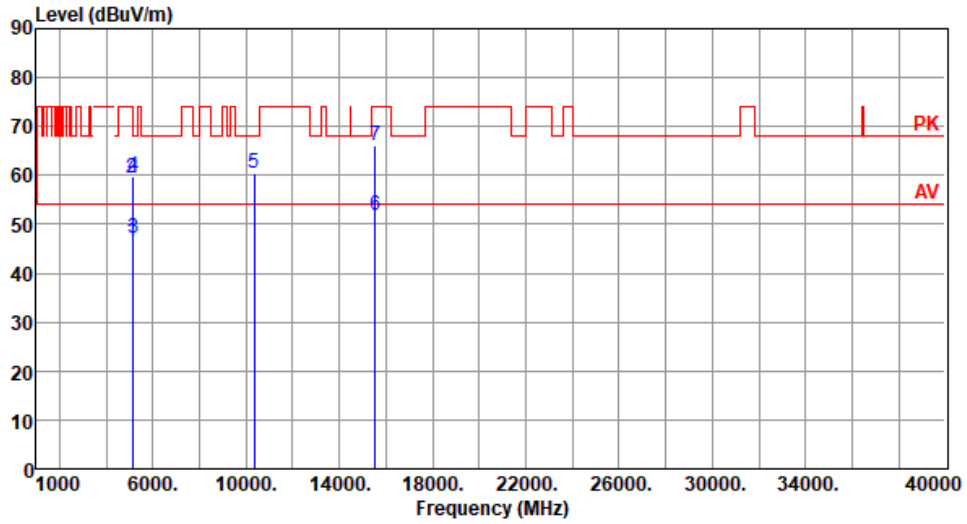

	Freq. MHz	Emission level dBuV/m	Limit dBuV/m	Margin dB	SA reading dBuV	Factor dB	Remark	ANT High cm	Turn Table deg
1	5120.00	46.47	54.00	-7.53	39.16	7.31	Average	249	102
2	5120.00	59.35	74.00	-14.65	52.04	7.31	Peak	249	102
3	5150.00	47.13	54.00	-6.87	39.81	7.32	Average	249	106
4	5150.00	59.77	74.00	-14.23	52.45	7.32	Peak	249	106
5	10360.00	60.28	68.20	-7.92	44.19	16.09	Peak	100	35
6	15540.00	51.69	54.00	-2.31	34.32	17.37	Average	189	326
7	15540.00	66.24	74.00	-7.76	48.87	17.37	Peak	189	326

Note 1: Emission Level (dBuV/m) = SA Reading (dBuV/m) + Factor* (dB)

*Factor includes antenna factor , cable loss and amplifier gain

Note 2: Margin (dB) = Emission level (dBuV/m) – Limit (dBuV/m).

Modulation	11a	Test Freq. (MHz)	5200
Polarization	Horizontal		

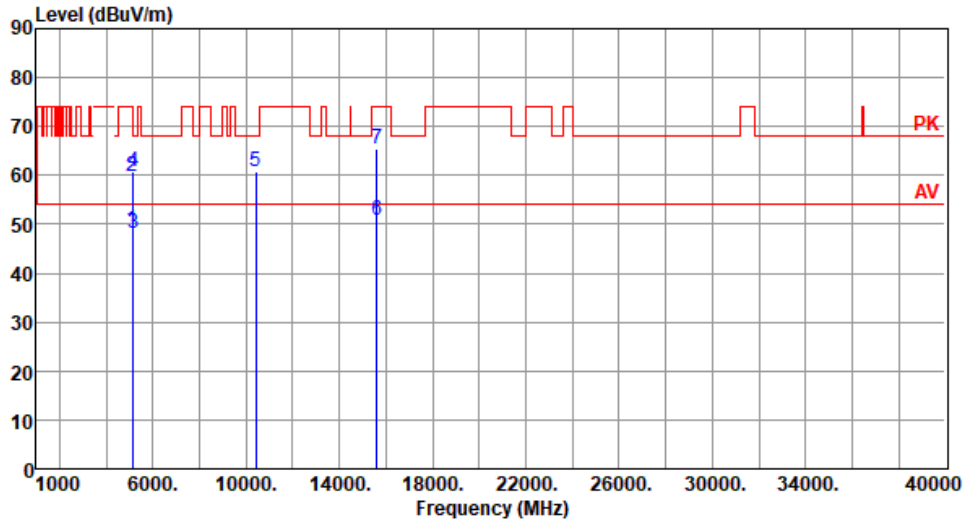

	Freq. MHz	Emission level dBuV/m	Limit dBuV/m	Margin dB	SA reading dBuV	Factor dB	Remark	ANT High cm	Turn Table deg
1	5120.00	48.85	54.00	-5.15	41.54	7.31	Average	293	143
2	5120.00	59.77	74.00	-14.23	52.46	7.31	Peak	293	143
3	5150.00	48.22	54.00	-5.78	40.90	7.32	Average	293	154
4	5150.00	60.65	74.00	-13.35	53.33	7.32	Peak	293	154
5	10400.00	60.93	68.20	-7.27	44.65	16.28	Peak	100	321
6	15600.00	50.69	54.00	-3.31	33.42	17.27	Average	188	14
7	15600.00	65.31	74.00	-8.69	48.04	17.27	Peak	188	14

Note 1: Emission Level (dBuV/m) = SA Reading (dBuV/m) + Factor* (dB)

*Factor includes antenna factor , cable loss and amplifier gain

Note 2: Margin (dB) = Emission level (dBuV/m) – Limit (dBuV/m).

Modulation	11a	Test Freq. (MHz)	5200
Polarization	Vertical		

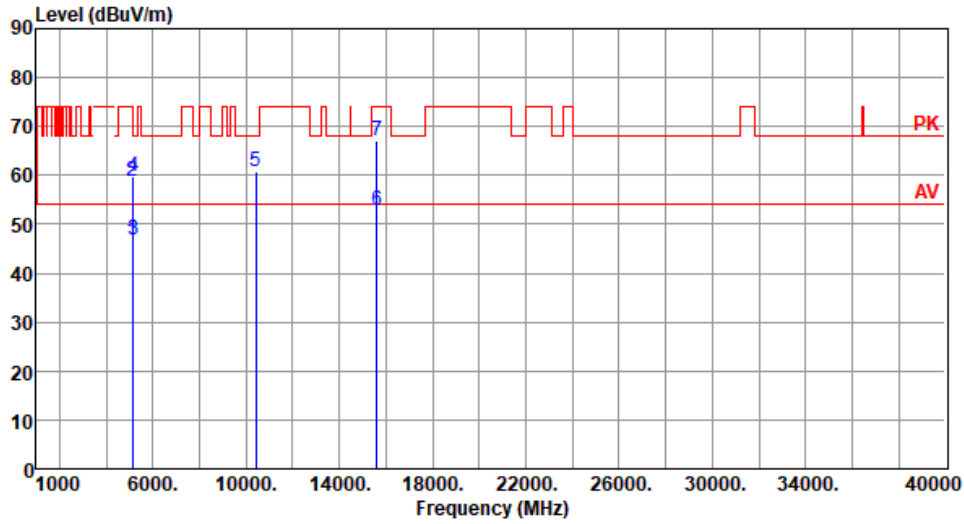

	Freq. MHz	Emission level dBuV/m	Limit dBuV/m	Margin dB	SA reading dBuV	Factor dB	Remark	ANT High cm	Turn Table deg
1	5120.00	46.46	54.00	-7.54	39.15	7.31	Average	245	100
2	5120.00	58.87	74.00	-15.13	51.56	7.31	Peak	245	100
3	5150.00	46.98	54.00	-7.02	39.66	7.32	Average	245	102
4	5150.00	59.72	74.00	-14.28	52.40	7.32	Peak	245	102
5	10400.00	60.71	68.20	-7.49	44.43	16.28	Peak	100	25
6	15600.00	52.86	54.00	-1.14	35.59	17.27	Average	188	322
7	15600.00	67.15	74.00	-6.85	49.88	17.27	Peak	188	322

Note 1: Emission Level (dBuV/m) = SA Reading (dBuV/m) + Factor* (dB)

*Factor includes antenna factor , cable loss and amplifier gain

Note 2: Margin (dB) = Emission level (dBuV/m) – Limit (dBuV/m).

Modulation	11a	Test Freq. (MHz)	5240
Polarization	Horizontal		

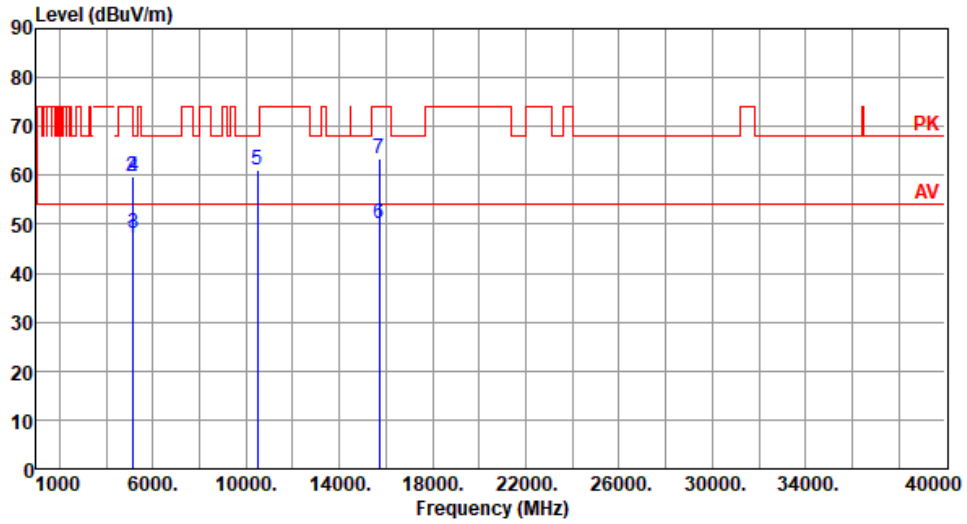

	Freq. MHz	Emission level dBuV/m	Limit dBuV/m	Margin dB	SA reading dBuV	Factor dB	Remark	ANT High cm	Turn Table deg
1	5120.00	47.03	54.00	-6.97	39.72	7.31	Average	267	142
2	5120.00	59.76	74.00	-14.24	52.45	7.31	Peak	267	142
3	5148.00	48.28	54.00	-5.72	40.97	7.31	Average	267	151
4	5148.00	59.77	74.00	-14.23	52.46	7.31	Peak	267	151
5	10480.00	61.22	68.20	-6.98	44.81	16.41	Peak	100	68
6	15720.00	50.04	54.00	-3.96	33.44	16.60	Average	194	5
7	15720.00	63.28	74.00	-10.72	46.68	16.60	Peak	194	5

Note 1: Emission Level (dBuV/m) = SA Reading (dBuV/m) + Factor* (dB)

*Factor includes antenna factor , cable loss and amplifier gain

Note 2: Margin (dB) = Emission level (dBuV/m) – Limit (dBuV/m).

Modulation	11a	Test Freq. (MHz)	5240
Polarization	Vertical		

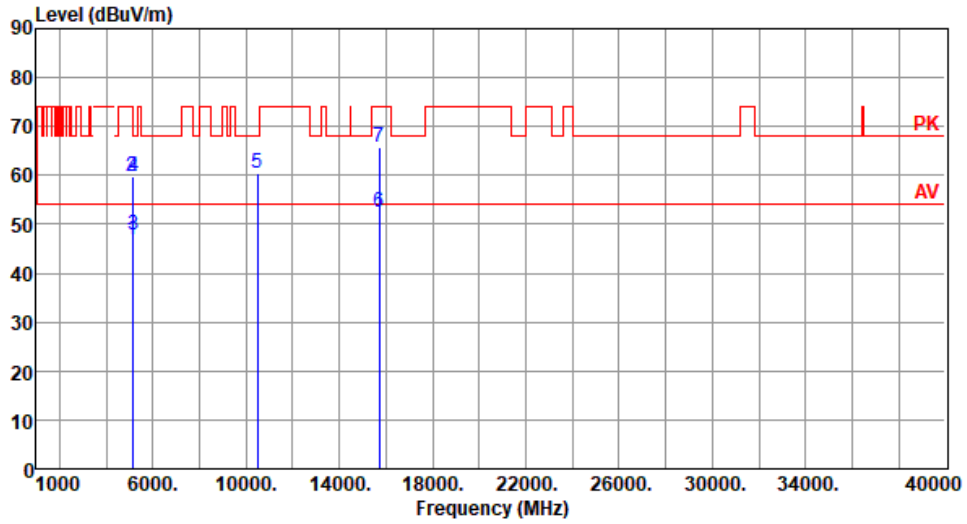

	Freq. MHz	Emission level dBuV/m	Limit dBuV/m	Margin dB	SA reading dBuV	Factor dB	Remark	ANT High cm	Turn Table deg
1	5120.00	46.96	54.00	-7.04	39.65	7.31	Average	245	105
2	5120.00	59.62	74.00	-14.38	52.31	7.31	Peak	245	105
3	5148.00	47.87	54.00	-6.13	40.56	7.31	Average	245	105
4	5148.00	59.64	74.00	-14.36	52.33	7.31	Peak	245	105
5	10480.00	60.33	68.20	-7.87	43.92	16.41	Peak	100	56
6	15720.00	52.35	54.00	-1.65	35.75	16.60	Average	235	316
7	15720.00	65.84	74.00	-8.16	49.24	16.60	Peak	235	316

Note 1: Emission Level (dBuV/m) = SA Reading (dBuV/m) + Factor* (dB)

*Factor includes antenna factor , cable loss and amplifier gain

Note 2: Margin (dB) = Emission level (dBuV/m) – Limit (dBuV/m).

Modulation	11a	Test Freq. (MHz)	5260
Polarization	Horizontal		

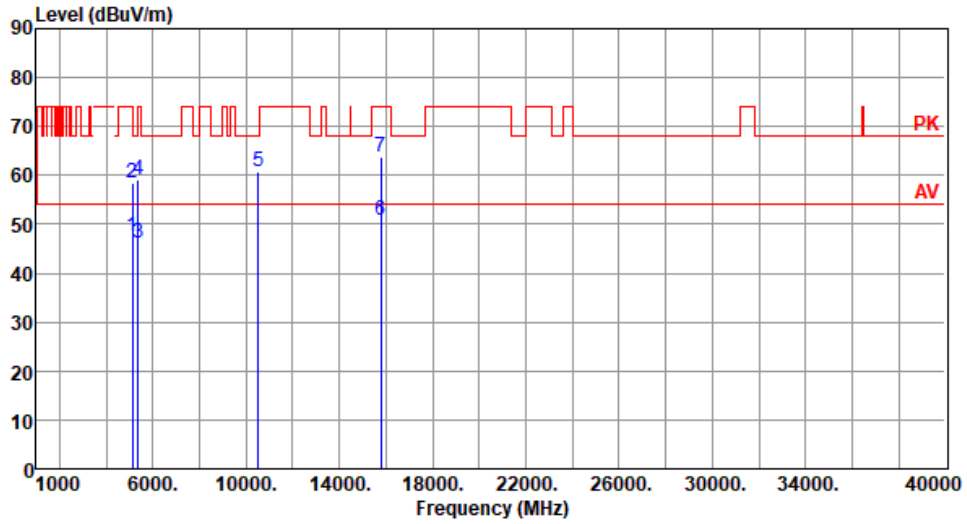

	Freq. MHz	Emission level dBuV/m	Limit dBuV/m	Margin dB	SA reading dBuV	Factor dB	Remark	ANT High cm	Turn Table deg
1	5120.00	47.45	54.00	-6.55	40.14	7.31	Average	253	144
2	5120.00	58.49	74.00	-15.51	51.18	7.31	Peak	253	144
3	5350.00	46.09	54.00	-7.91	39.24	6.85	Average	253	150
4	5350.00	58.99	74.00	-15.01	52.14	6.85	Peak	253	150
5	10520.00	60.84	68.20	-7.36	44.42	16.42	Peak	100	58
6	15780.00	50.97	54.00	-3.03	34.41	16.56	Average	212	321
7	15780.00	63.68	74.00	-10.32	47.12	16.56	Peak	212	321

Note 1: Emission Level (dBuV/m) = SA Reading (dBuV/m) + Factor* (dB)

*Factor includes antenna factor , cable loss and amplifier gain

Note 2: Margin (dB) = Emission level (dBuV/m) – Limit (dBuV/m).

Modulation	11a	Test Freq. (MHz)	5260
Polarization	Vertical		

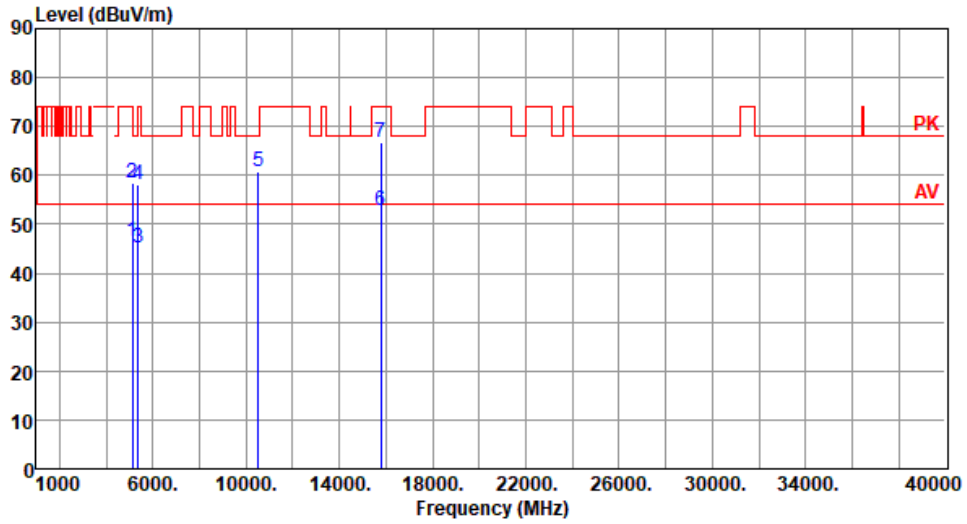

	Freq. MHz	Emission level dBuV/m	Limit dBuV/m	Margin dB	SA reading dBuV	Factor dB	Remark	ANT High cm	Turn Table deg
1	5120.00	46.46	54.00	-7.54	39.15	7.31	Average	248	95
2	5120.00	58.45	74.00	-15.55	51.14	7.31	Peak	248	95
3	5350.00	45.26	54.00	-8.74	38.41	6.85	Average	248	91
4	5350.00	57.97	74.00	-16.03	51.12	6.85	Peak	248	91
5	10520.00	60.84	68.20	-7.36	44.42	16.42	Peak	100	81
6	15780.00	52.81	54.00	-1.19	36.25	16.56	Average	234	315
7	15780.00	66.64	74.00	-7.36	50.08	16.56	Peak	234	315

Note 1: Emission Level (dBuV/m) = SA Reading (dBuV/m) + Factor* (dB)

*Factor includes antenna factor , cable loss and amplifier gain

Note 2: Margin (dB) = Emission level (dBuV/m) – Limit (dBuV/m).

Modulation	11a	Test Freq. (MHz)	5300
Polarization	Horizontal		

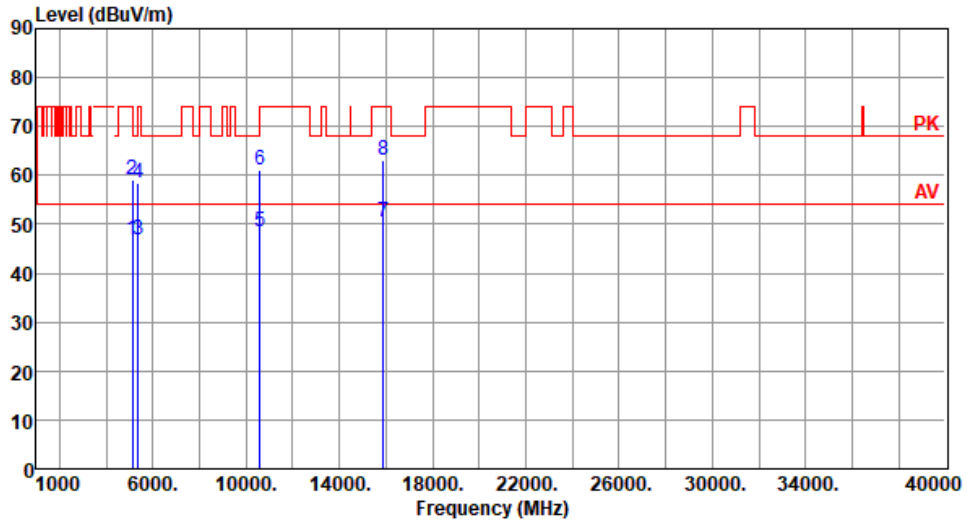

	Freq. MHz	Emission level dBuV/m	Limit dBuV/m	Margin dB	SA reading dBuV	Factor dB	Remark	ANT High cm	Turn Table deg
1	5120.00	46.74	54.00	-7.26	39.43	7.31	Average	253	148
2	5120.00	59.19	74.00	-14.81	51.88	7.31	Peak	253	148
3	5350.00	46.75	54.00	-7.25	39.90	6.85	Average	253	153
4	5350.00	58.49	74.00	-15.51	51.64	6.85	Peak	253	153
5	10600.00	48.34	54.00	-5.66	31.98	16.36	Average	100	15
6	10600.00	60.98	74.00	-13.02	44.62	16.36	Peak	100	15
7	15900.00	50.34	54.00	-3.66	33.65	16.69	Average	207	328
8	15900.00	63.21	74.00	-10.79	46.52	16.69	Peak	207	328

Note 1: Emission Level (dBuV/m) = SA Reading (dBuV/m) + Factor* (dB)

*Factor includes antenna factor , cable loss and amplifier gain

Note 2: Margin (dB) = Emission level (dBuV/m) – Limit (dBuV/m).

Modulation	11a	Test Freq. (MHz)	5300
Polarization	Vertical		

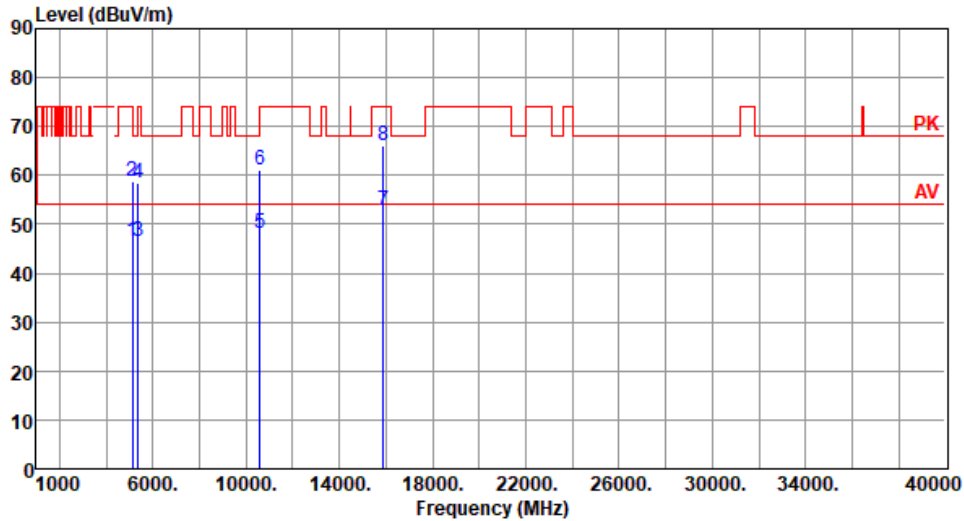

	Freq. MHz	Emission level dBuV/m	Limit dBuV/m	Margin dB	SA reading dBuV	Factor dB	Remark	ANT High cm	Turn Table deg
1	5120.00	46.53	54.00	-7.47	39.22	7.31	Average	244	92
2	5120.00	58.93	74.00	-15.07	51.62	7.31	Peak	244	92
3	5350.00	46.53	54.00	-7.47	39.68	6.85	Average	244	92
4	5350.00	58.41	74.00	-15.59	51.56	6.85	Peak	244	92
5	10600.00	48.25	54.00	-5.75	31.89	16.36	Average	100	54
6	10600.00	61.00	74.00	-13.00	44.64	16.36	Peak	100	54
7	15900.00	52.88	54.00	-1.12	36.19	16.69	Average	198	313
8	15900.00	66.14	74.00	-7.86	49.45	16.69	Peak	198	313

Note 1: Emission Level (dBuV/m) = SA Reading (dBuV/m) + Factor* (dB)

*Factor includes antenna factor , cable loss and amplifier gain

Note 2: Margin (dB) = Emission level (dBuV/m) – Limit (dBuV/m).

Modulation	11a	Test Freq. (MHz)	5320
Polarization	Horizontal		

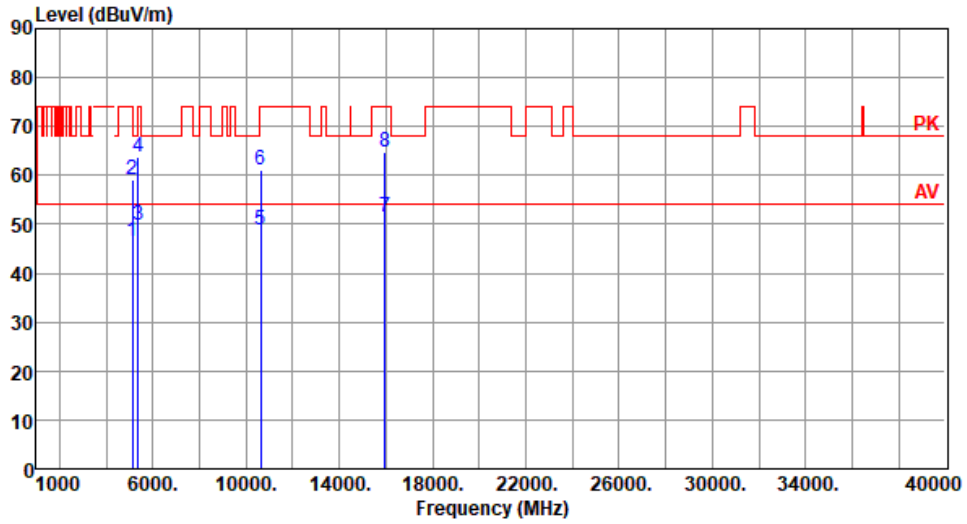

	Freq. MHz	Emission level dBuV/m	Limit dBuV/m	Margin dB	SA reading dBuV	Factor dB	Remark	ANT High cm	Turn Table deg
1	5120.00	46.47	54.00	-7.53	39.16	7.31	Average	260	148
2	5120.00	59.00	74.00	-15.00	51.69	7.31	Peak	260	148
3	5350.00	49.78	54.00	-4.22	42.93	6.85	Average	260	155
4	5350.00	63.80	74.00	-10.20	56.95	6.85	Peak	260	155
5	10640.00	48.86	54.00	-5.14	32.49	16.37	Average	100	58
6	10640.00	60.99	74.00	-13.01	44.62	16.37	Peak	100	58
7	15960.00	51.34	54.00	-2.66	34.81	16.53	Average	208	326
8	15960.00	64.65	74.00	-9.35	48.12	16.53	Peak	208	326

Note 1: Emission Level (dBuV/m) = SA Reading (dBuV/m) + Factor* (dB)

*Factor includes antenna factor , cable loss and amplifier gain

Note 2: Margin (dB) = Emission level (dBuV/m) – Limit (dBuV/m).

Modulation	11a	Test Freq. (MHz)	5320
Polarization	Vertical		

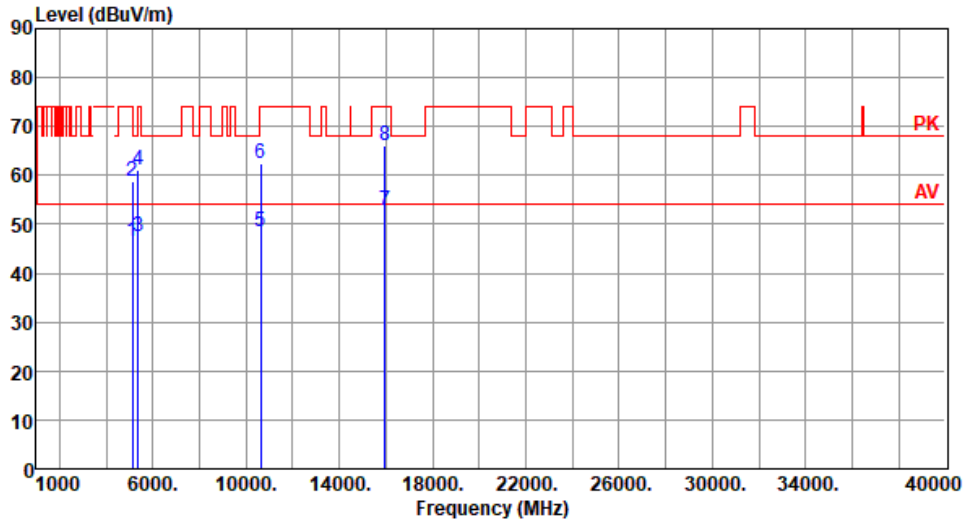

	Freq. MHz	Emission level dBuV/m	Limit dBuV/m	Margin dB	SA reading dBuV	Factor dB	Remark	ANT High cm	Turn Table deg
1	5120.00	46.42	54.00	-7.58	39.11	7.31	Average	245	95
2	5120.00	58.74	74.00	-15.26	51.43	7.31	Peak	245	95
3	5350.00	47.41	54.00	-6.59	40.56	6.85	Average	245	95
4	5350.00	61.17	74.00	-12.83	54.32	6.85	Peak	245	95
5	10640.00	48.61	54.00	-5.39	32.24	16.37	Average	100	86
6	10640.00	62.28	74.00	-11.72	45.91	16.37	Peak	100	86
7	15960.00	52.68	54.00	-1.32	36.15	16.53	Average	210	310
8	15960.00	66.21	74.00	-7.79	49.68	16.53	Peak	210	310

Note 1: Emission Level (dBuV/m) = SA Reading (dBuV/m) + Factor* (dB)

*Factor includes antenna factor , cable loss and amplifier gain

Note 2: Margin (dB) = Emission level (dBuV/m) – Limit (dBuV/m).

Modulation	11a	Test Freq. (MHz)	5500
Polarization	Horizontal		

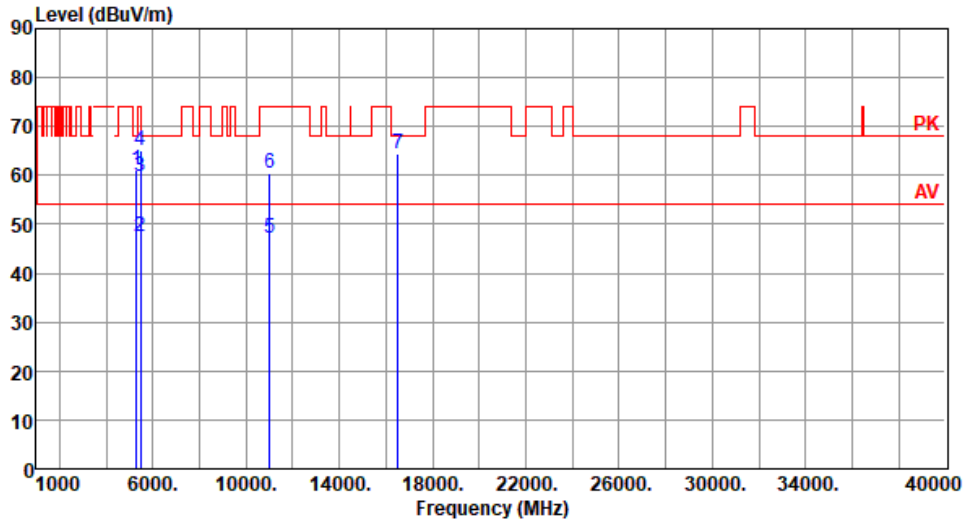

	Freq. MHz	Emission level dBuV/m	Limit dBuV/m	Margin dB	SA reading dBuV	Factor dB	Remark	ANT High cm	Turn Table deg
1	5280.00	61.01	68.20	-7.19	54.12	6.89	Peak	241	146
2	5460.00	47.36	54.00	-6.64	40.11	7.25	Average	241	146
3	5460.00	59.90	74.00	-14.10	52.65	7.25	Peak	241	146
4	5470.00	65.06	68.20	-3.14	57.78	7.28	Peak	241	146
5	11000.00	47.29	54.00	-6.71	30.45	16.84	Average	100	115
6	11000.00	60.46	74.00	-13.54	43.62	16.84	Peak	100	115
7	16500.00	64.45	68.20	-3.75	46.81	17.64	Peak	233	326

Note 1: Emission Level (dBuV/m) = SA Reading (dBuV/m) + Factor* (dB)

*Factor includes antenna factor , cable loss and amplifier gain

Note 2: Margin (dB) = Emission level (dBuV/m) – Limit (dBuV/m).

Modulation	11a	Test Freq. (MHz)	5500
Polarization	Vertical		

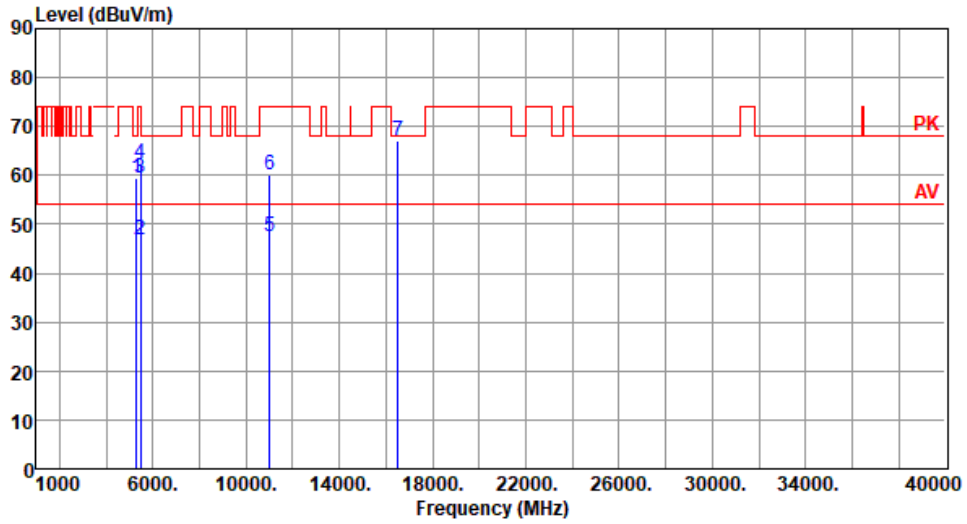

	Freq. MHz	Emission level dBuV/m	Limit dBuV/m	Margin dB	SA reading dBuV	Factor dB	Remark	ANT High cm	Turn Table deg
1	5280.00	59.45	68.20	-8.75	52.56	6.89	Peak	276	115
2	5460.00	46.90	54.00	-7.10	39.65	7.25	Average	276	115
3	5460.00	59.59	74.00	-14.41	52.34	7.25	Peak	276	115
4	5470.00	62.49	68.20	-5.71	55.21	7.28	Peak	276	115
5	11000.00	47.38	54.00	-6.62	30.54	16.84	Average	100	88
6	11000.00	60.10	74.00	-13.90	43.26	16.84	Peak	100	88
7	16500.00	67.14	68.20	-1.06	49.50	17.64	Peak	231	313

Note 1: Emission Level (dBuV/m) = SA Reading (dBuV/m) + Factor* (dB)

*Factor includes antenna factor , cable loss and amplifier gain

Note 2: Margin (dB) = Emission level (dBuV/m) – Limit (dBuV/m).

Modulation	11a	Test Freq. (MHz)	5580
Polarization	Horizontal		

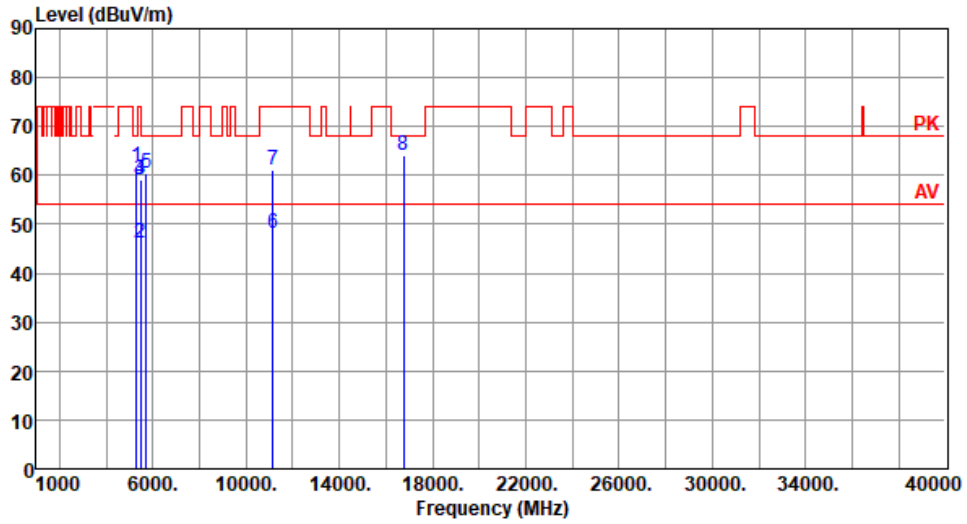

	Freq. MHz	Emission level dBuV/m	Limit dBuV/m	Margin dB	SA reading dBuV	Factor dB	Remark	ANT High cm	Turn Table deg
1	5280.00	61.79	68.20	-6.41	54.90	6.89	Peak	272	151
2	5460.00	46.18	54.00	-7.82	38.93	7.25	Average	245	151
3	5460.00	59.04	74.00	-14.96	51.79	7.25	Peak	245	151
4	5470.00	59.14	68.20	-9.06	51.86	7.28	Peak	245	151
5	5725.00	60.30	68.20	-7.90	52.64	7.66	Peak	245	151
6	11160.00	48.24	54.00	-5.76	31.65	16.59	Average	100	19
7	11160.00	61.17	74.00	-12.83	44.58	16.59	Peak	100	19
8	16740.00	64.24	68.20	-3.96	46.01	18.23	Peak	221	331

Note 1: Emission Level (dBuV/m) = SA Reading (dBuV/m) + Factor* (dB)

*Factor includes antenna factor , cable loss and amplifier gain

Note 2: Margin (dB) = Emission level (dBuV/m) – Limit (dBuV/m).

Modulation	11a	Test Freq. (MHz)	5580
Polarization	Vertical		

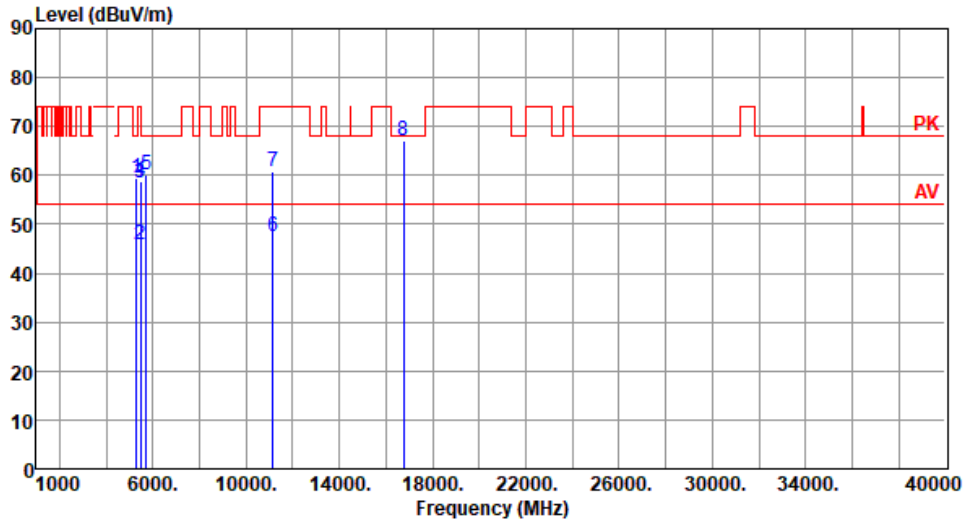

	Freq. MHz	Emission level dBuV/m	Limit dBuV/m	Margin dB	SA reading dBuV	Factor dB	Remark	ANT High cm	Turn Table deg
1	5280.00	59.53	68.20	-8.67	52.64	6.89	Peak	274	118
2	5460.00	45.90	54.00	-8.10	38.65	7.25	Average	274	118
3	5460.00	58.51	74.00	-15.49	51.26	7.25	Peak	274	118
4	5470.00	58.92	68.20	-9.28	51.64	7.28	Peak	274	118
5	5725.00	60.01	68.20	-8.19	52.35	7.66	Peak	274	118
6	11160.00	47.51	54.00	-6.49	30.92	16.59	Average	100	44
7	11160.00	60.74	74.00	-13.26	44.15	16.59	Peak	100	44
8	16740.00	67.18	68.20	-1.02	48.95	18.23	Peak	220	323

Note 1: Emission Level (dBuV/m) = SA Reading (dBuV/m) + Factor* (dB)

*Factor includes antenna factor , cable loss and amplifier gain

Note 2: Margin (dB) = Emission level (dBuV/m) – Limit (dBuV/m).

Modulation	11a	Test Freq. (MHz)	5700
Polarization	Horizontal		

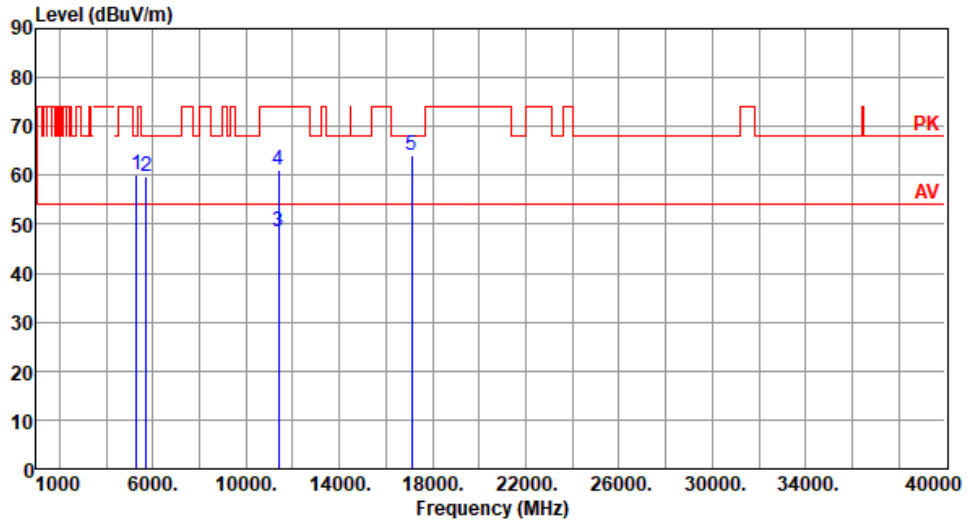

	Freq. MHz	Emission level dBuV/m	Limit dBuV/m	Margin dB	SA reading dBuV	Factor dB	Remark	ANT High cm	Turn Table deg
1	5280.00	60.05	68.20	-8.15	53.16	6.89	Peak	260	150
2	5725.00	59.93	68.20	-8.27	52.27	7.66	Peak	260	150
3	11400.00	48.36	54.00	-5.64	31.63	16.73	Average	100	25
4	11400.00	61.25	74.00	-12.75	44.52	16.73	Peak	100	25
5	17100.00	64.09	68.20	-4.11	45.85	18.24	Peak	213	316

Note 1: Emission Level (dBuV/m) = SA Reading (dBuV/m) + Factor* (dB)

*Factor includes antenna factor , cable loss and amplifier gain

Note 2: Margin (dB) = Emission level (dBuV/m) – Limit (dBuV/m).

Modulation	11a	Test Freq. (MHz)	5700
Polarization	Vertical		

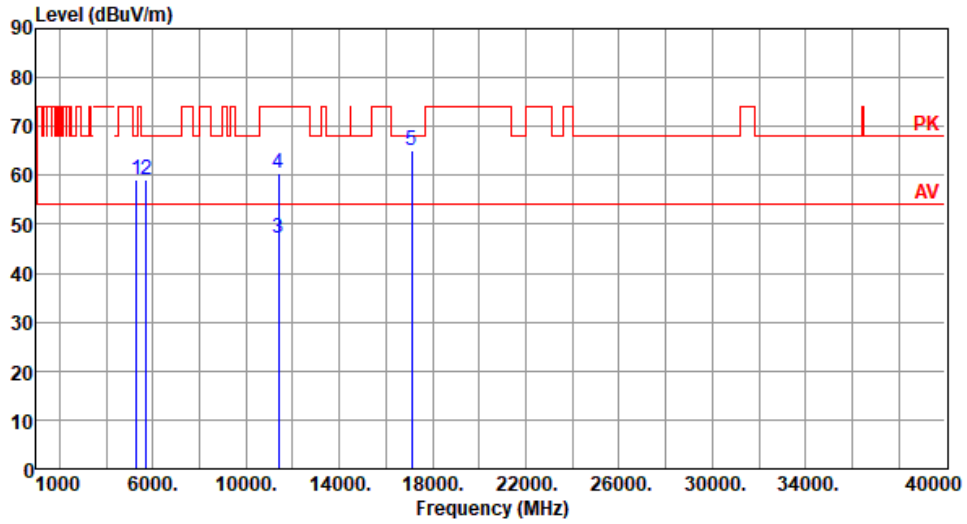

	Freq. MHz	Emission level dBuV/m	Limit dBuV/m	Margin dB	SA reading dBuV	Factor dB	Remark	ANT High cm	Turn Table deg
1	5280.00	59.03	68.20	-9.17	52.14	6.89	Peak	277	114
2	5725.00	59.21	68.20	-8.99	51.55	7.66	Peak	277	114
3	11400.00	47.24	54.00	-6.76	30.51	16.73	Average	100	58
4	11400.00	60.53	74.00	-13.47	43.80	16.73	Peak	100	58
5	17100.00	65.22	68.20	-2.98	46.98	18.24	Peak	215	323

Note 1: Emission Level (dBuV/m) = SA Reading (dBuV/m) + Factor* (dB)

*Factor includes antenna factor , cable loss and amplifier gain

Note 2: Margin (dB) = Emission level (dBuV/m) – Limit (dBuV/m).

Modulation	11a	Test Freq. (MHz)	5720
Polarization	Horizontal		

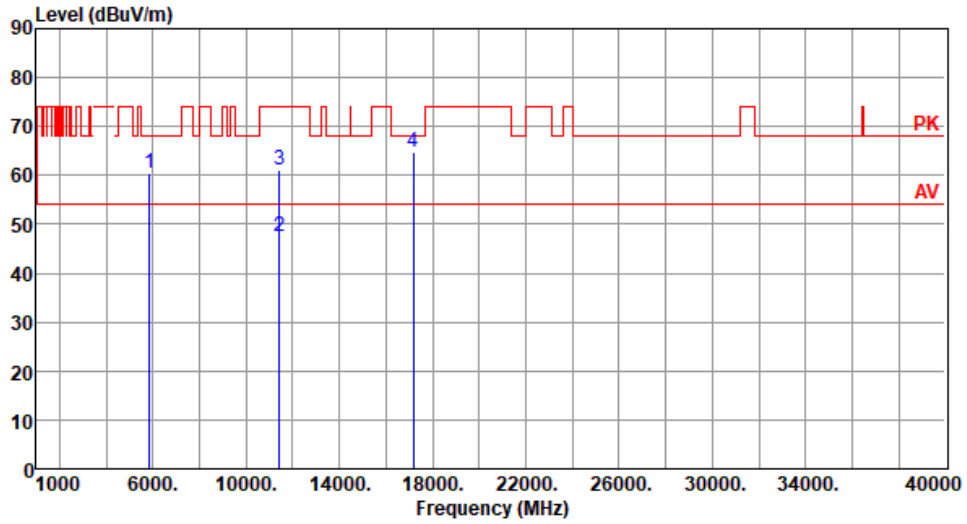

	Freq. MHz	Emission level dBuV/m	Limit dBuV/m	Margin dB	SA reading dBuV	Factor dB	Remark	ANT High cm	Turn Table deg
1	5850.00	60.39	68.20	-7.81	52.37	8.02	Peak	249	155
2	11440.00	47.64	54.00	-6.36	30.90	16.74	Average	100	39
3	11440.00	60.95	74.00	-13.05	44.21	16.74	Peak	100	39
4	17160.00	64.82	68.20	-3.38	46.44	18.38	Peak	216	325

Note 1: Emission Level (dBuV/m) = SA Reading (dBuV/m) + Factor* (dB)

*Factor includes antenna factor , cable loss and amplifier gain

Note 2: Margin (dB) = Emission level (dBuV/m) – Limit (dBuV/m).

Modulation	11a	Test Freq. (MHz)	5720
Polarization	Vertical		

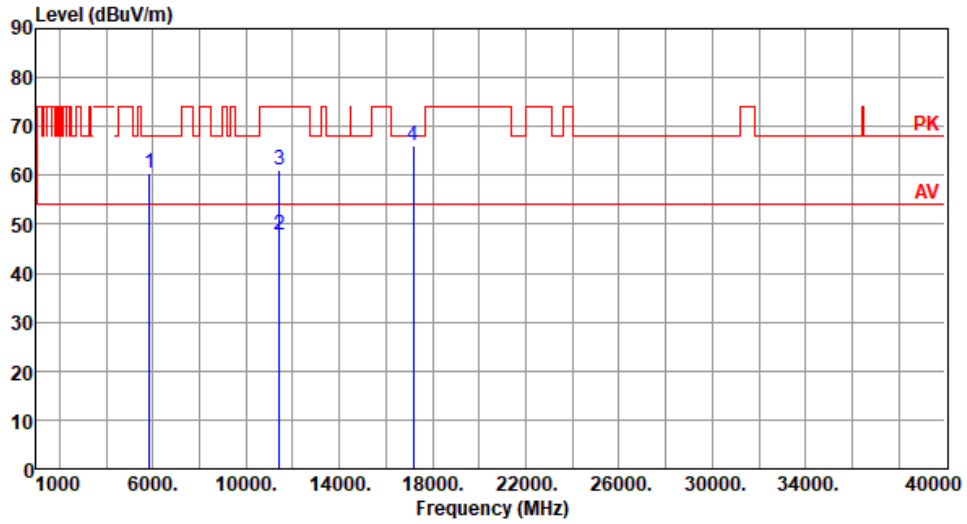

	Freq. MHz	Emission level dBuV/m	Limit dBuV/m	Margin dB	SA reading dBuV	Factor dB	Remark	ANT High cm	Turn Table deg
1	5850.00	60.28	68.20	-7.92	52.26	8.02	Peak	254	92
2	11440.00	47.85	54.00	-6.15	31.11	16.74	Average	100	56
3	11440.00	61.22	74.00	-12.78	44.48	16.74	Peak	100	56
4	17160.00	65.96	68.20	-2.24	47.58	18.38	Peak	210	325

Note 1: Emission Level (dBuV/m) = SA Reading (dBuV/m) + Factor* (dB)

*Factor includes antenna factor , cable loss and amplifier gain

Note 2: Margin (dB) = Emission level (dBuV/m) – Limit (dBuV/m).

Modulation	11a	Test Freq. (MHz)	5745
Polarization	Horizontal		

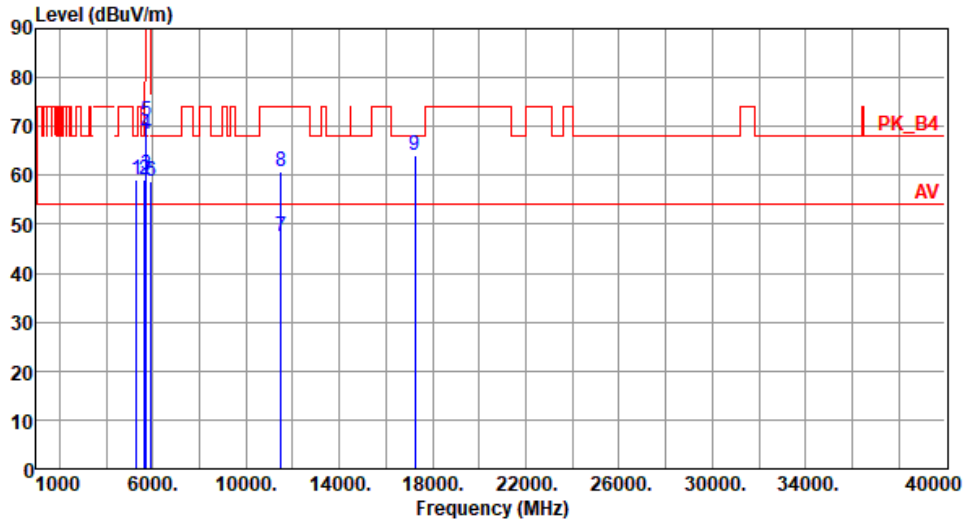

	Freq. MHz	Emission level dBuV/m	Limit dBuV/m	Margin dB	SA reading dBuV	Factor dB	Remark	ANT High cm	Turn Table deg
1	5280.00	58.95	68.20	-9.25	52.06	6.89	Peak	248	154
2	5650.00	59.20	68.20	-9.00	51.81	7.39	Peak	248	154
3	5700.00	59.96	105.20	-45.24	52.46	7.50	Peak	248	154
4	5720.00	68.51	110.80	-42.29	60.89	7.62	Peak	248	154
5	5725.00	71.16	122.20	-51.04	63.50	7.66	Peak	248	154
6	5925.00	58.64	68.20	-9.56	50.57	8.07	Peak	248	154
7	11490.00	47.58	54.00	-6.42	30.82	16.76	Average	100	33
8	11490.00	60.86	74.00	-13.14	44.10	16.76	Peak	100	33
9	17235.00	64.26	68.20	-3.94	45.62	18.64	Peak	216	324

Note 1: Emission Level (dBuV/m) = SA Reading (dBuV/m) + Factor* (dB)
 *Factor includes antenna factor , cable loss and amplifier gain
 Note 2: Margin (dB) = Emission level (dBuV/m) – Limit (dBuV/m).

Modulation	11a	Test Freq. (MHz)	5745
Polarization	Vertical		

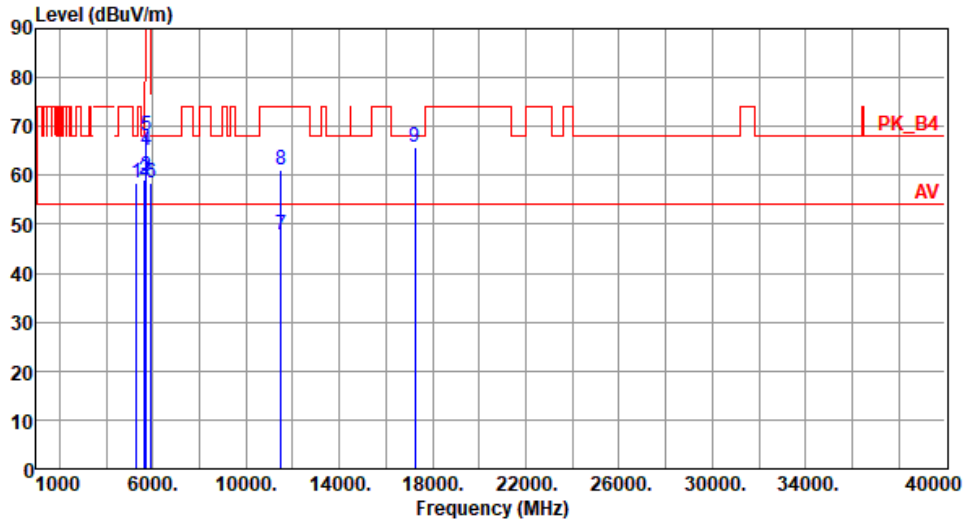

	Freq. MHz	Emission level dBuV/m	Limit dBuV/m	Margin dB	SA reading dBuV	Factor dB	Remark	ANT High cm	Turn Table deg
1	5280.00	58.44	68.20	-9.76	51.55	6.89	Peak	255	88
2	5650.00	58.95	68.20	-9.25	51.56	7.39	Peak	255	88
3	5700.00	59.81	105.20	-45.39	52.31	7.50	Peak	255	88
4	5720.00	65.08	110.80	-45.72	57.46	7.62	Peak	255	88
5	5725.00	68.09	122.20	-54.11	60.43	7.66	Peak	255	88
6	5925.00	58.51	68.20	-9.69	50.44	8.07	Peak	255	88
7	11490.00	47.72	54.00	-6.28	30.96	16.76	Average	100	52
8	11490.00	61.00	74.00	-13.00	44.24	16.76	Peak	100	52
9	17235.00	65.70	68.20	-2.50	47.06	18.64	Peak	210	323

Note 1: Emission Level (dBuV/m) = SA Reading (dBuV/m) + Factor* (dB)

*Factor includes antenna factor , cable loss and amplifier gain

Note 2: Margin (dB) = Emission level (dBuV/m) – Limit (dBuV/m).

Modulation	11a	Test Freq. (MHz)	5785
Polarization	Horizontal		

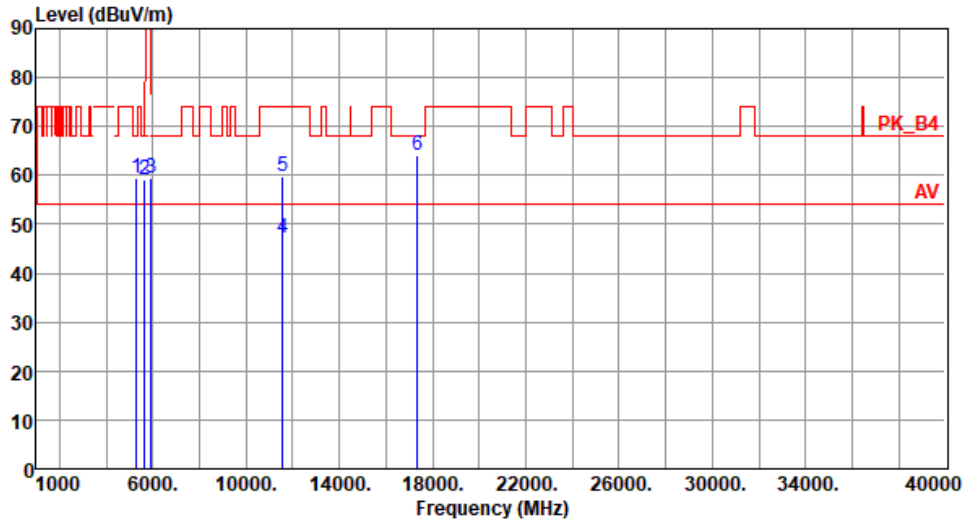

	Freq. MHz	Emission level dBuV/m	Limit dBuV/m	Margin dB	SA reading dBuV	Factor dB	Remark	ANT High cm	Turn Table deg
1	5280.00	59.40	68.20	-8.80	52.51	6.89	Peak	254	150
2	5650.00	59.25	68.20	-8.95	51.86	7.39	Peak	254	150
3	5925.00	59.44	68.20	-8.76	51.37	8.07	Peak	254	150
4	11570.00	47.07	54.00	-6.93	30.46	16.61	Average	100	88
5	11570.00	59.90	74.00	-14.10	43.29	16.61	Peak	100	88
6	17355.00	64.22	68.20	-3.98	44.99	19.23	Peak	215	323

Note 1: Emission Level (dBuV/m) = SA Reading (dBuV/m) + Factor* (dB)

*Factor includes antenna factor , cable loss and amplifier gain

Note 2: Margin (dB) = Emission level (dBuV/m) – Limit (dBuV/m).

Modulation	11a	Test Freq. (MHz)	5785
Polarization	Vertical		

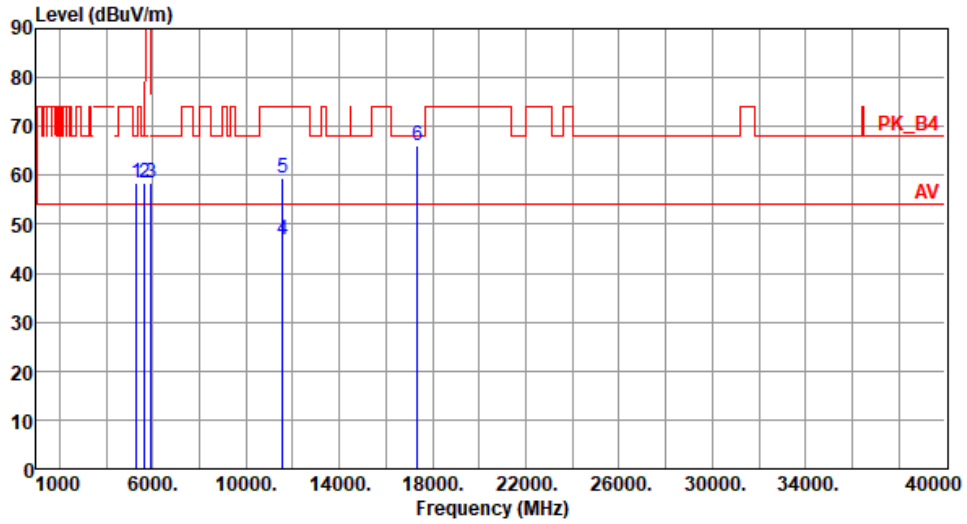

	Freq. MHz	Emission level dBuV/m	Limit dBuV/m	Margin dB	SA reading dBuV	Factor dB	Remark	ANT High cm	Turn Table deg
1	5280.00	58.34	68.20	-9.86	51.45	6.89	Peak	256	90
2	5650.00	58.44	68.20	-9.76	51.05	7.39	Peak	256	90
3	5925.00	58.43	68.20	-9.77	50.36	8.07	Peak	256	90
4	11570.00	46.72	54.00	-7.28	30.11	16.61	Average	100	48
5	11570.00	59.56	74.00	-14.44	42.95	16.61	Peak	100	48
6	17355.00	66.02	68.20	-2.18	46.79	19.23	Peak	208	334

Note 1: Emission Level (dBuV/m) = SA Reading (dBuV/m) + Factor* (dB)

*Factor includes antenna factor , cable loss and amplifier gain

Note 2: Margin (dB) = Emission level (dBuV/m) – Limit (dBuV/m).

Modulation	11a	Test Freq. (MHz)	5825
Polarization	Horizontal		

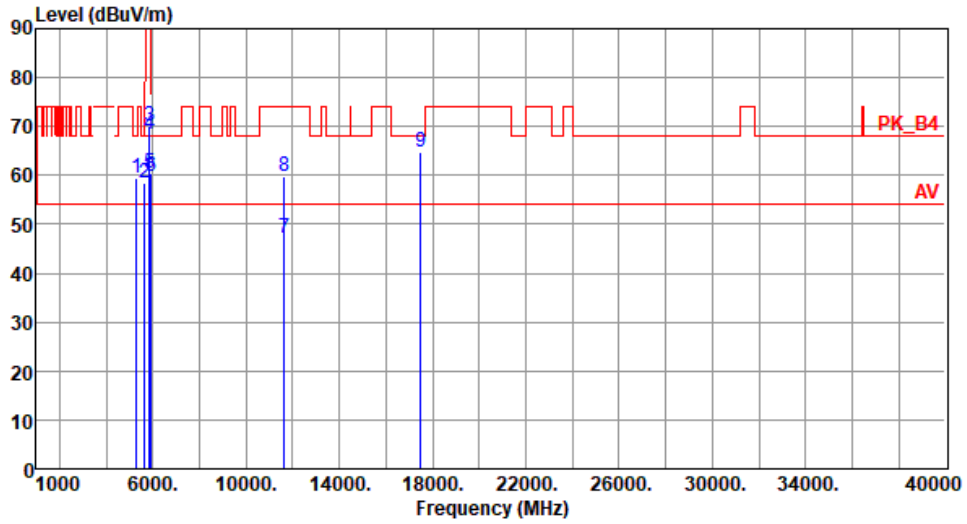

	Freq. MHz	Emission level dBuV/m	Limit dBuV/m	Margin dB	SA reading dBuV	Factor dB	Remark	ANT High cm	Turn Table deg
1	5280.00	59.35	68.20	-8.85	52.46	6.89	Peak	236	154
2	5650.00	58.60	68.20	-9.60	51.21	7.39	Peak	236	154
3	5850.00	69.94	122.20	-52.26	61.92	8.02	Peak	236	154
4	5855.00	68.41	110.80	-42.39	60.39	8.02	Peak	236	154
5	5875.00	60.47	105.20	-44.73	52.44	8.03	Peak	236	154
6	5925.00	59.90	68.20	-8.30	51.83	8.07	Peak	236	154
7	11650.00	47.14	54.00	-6.86	30.76	16.38	Average	100	23
8	11650.00	59.88	74.00	-14.12	43.50	16.38	Peak	100	23
9	17475.00	64.88	68.20	-3.32	45.14	19.74	Peak	226	335

Note 1: Emission Level (dBuV/m) = SA Reading (dBuV/m) + Factor* (dB)

*Factor includes antenna factor , cable loss and amplifier gain

Note 2: Margin (dB) = Emission level (dBuV/m) – Limit (dBuV/m).

Modulation	11a	Test Freq. (MHz)	5825
Polarization	Vertical		

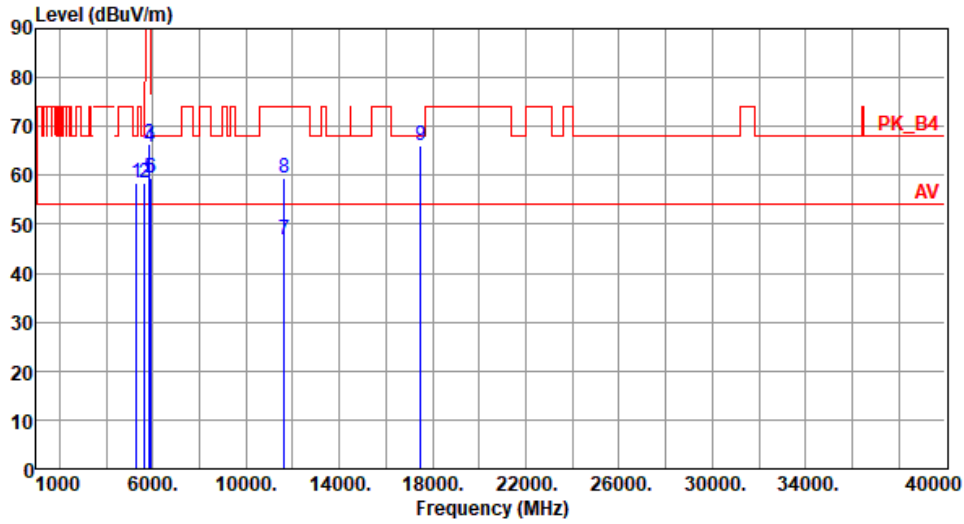

	Freq. MHz	Emission level dBuV/m	Limit dBuV/m	Margin dB	SA reading dBuV	Factor dB	Remark	ANT High cm	Turn Table deg
1	5280.00	58.53	68.20	-9.67	51.64	6.89	Peak	250	86
2	5650.00	58.52	68.20	-9.68	51.13	7.39	Peak	250	86
3	5850.00	66.48	122.20	-55.72	58.46	8.02	Peak	250	86
4	5855.00	65.63	110.80	-45.17	57.61	8.02	Peak	250	86
5	5875.00	59.35	105.20	-45.85	51.32	8.03	Peak	250	86
6	5925.00	59.53	68.20	-8.67	51.46	8.07	Peak	250	86
7	11650.00	46.83	54.00	-7.17	30.45	16.38	Average	100	40
8	11650.00	59.59	74.00	-14.41	43.21	16.38	Peak	100	40
9	17475.00	65.95	68.20	-2.25	46.21	19.74	Peak	209	320

Note 1: Emission Level (dBuV/m) = SA Reading (dBuV/m) + Factor* (dB)

*Factor includes antenna factor , cable loss and amplifier gain

Note 2: Margin (dB) = Emission level (dBuV/m) – Limit (dBuV/m).

3.5.18 Transmitter Radiated Unwanted Emissions (Above 1GHz) for HT20

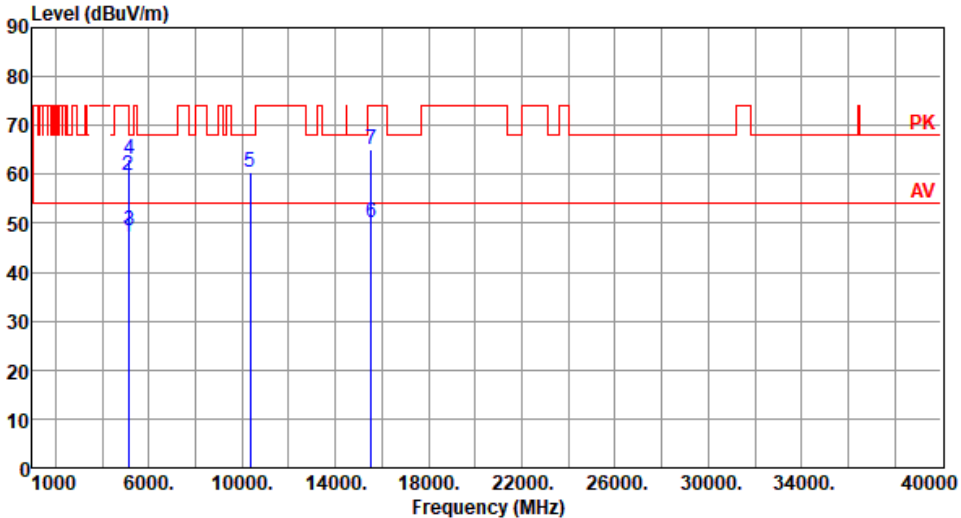
Modulation	HT20	Test Freq. (MHz)	5180																																																																															
Polarization	Horizontal																																																																																	
																																																																																		
	<table border="1"> <thead> <tr> <th>Freq.</th> <th>Emission level</th> <th>Limit</th> <th>Margin</th> <th>SA reading</th> <th>Factor</th> <th>Remark</th> <th>ANT High</th> <th>Turn Table</th> </tr> <tr> <th>MHz</th> <th>dBuV/m</th> <th>dBuV/m</th> <th>dB</th> <th>dBuV</th> <th>dB</th> <th></th> <th>cm</th> <th>deg</th> </tr> </thead> <tbody> <tr> <td>1</td> <td>5120.00</td> <td>47.22</td> <td>54.00</td> <td>-6.78</td> <td>39.91</td> <td>7.31</td> <td>Average</td> <td>294 151</td> </tr> <tr> <td>2</td> <td>5120.00</td> <td>59.81</td> <td>74.00</td> <td>-14.19</td> <td>52.50</td> <td>7.31</td> <td>Peak</td> <td>294 151</td> </tr> <tr> <td>3</td> <td>5150.00</td> <td>48.51</td> <td>54.00</td> <td>-5.49</td> <td>41.19</td> <td>7.32</td> <td>Average</td> <td>294 155</td> </tr> <tr> <td>4</td> <td>5150.00</td> <td>62.94</td> <td>74.00</td> <td>-11.06</td> <td>55.62</td> <td>7.32</td> <td>Peak</td> <td>294 155</td> </tr> <tr> <td>5</td> <td>10360.00</td> <td>60.59</td> <td>68.20</td> <td>-7.61</td> <td>44.50</td> <td>16.09</td> <td>Peak</td> <td>100 296</td> </tr> <tr> <td>6</td> <td>15540.00</td> <td>50.21</td> <td>54.00</td> <td>-3.79</td> <td>32.84</td> <td>17.37</td> <td>Average</td> <td>188 24</td> </tr> <tr> <td>7</td> <td>15540.00</td> <td>65.22</td> <td>74.00</td> <td>-8.78</td> <td>47.85</td> <td>17.37</td> <td>Peak</td> <td>188 24</td> </tr> </tbody> </table>	Freq.	Emission level	Limit	Margin	SA reading	Factor	Remark	ANT High	Turn Table	MHz	dBuV/m	dBuV/m	dB	dBuV	dB		cm	deg	1	5120.00	47.22	54.00	-6.78	39.91	7.31	Average	294 151	2	5120.00	59.81	74.00	-14.19	52.50	7.31	Peak	294 151	3	5150.00	48.51	54.00	-5.49	41.19	7.32	Average	294 155	4	5150.00	62.94	74.00	-11.06	55.62	7.32	Peak	294 155	5	10360.00	60.59	68.20	-7.61	44.50	16.09	Peak	100 296	6	15540.00	50.21	54.00	-3.79	32.84	17.37	Average	188 24	7	15540.00	65.22	74.00	-8.78	47.85	17.37	Peak	188 24
Freq.	Emission level	Limit	Margin	SA reading	Factor	Remark	ANT High	Turn Table																																																																										
MHz	dBuV/m	dBuV/m	dB	dBuV	dB		cm	deg																																																																										
1	5120.00	47.22	54.00	-6.78	39.91	7.31	Average	294 151																																																																										
2	5120.00	59.81	74.00	-14.19	52.50	7.31	Peak	294 151																																																																										
3	5150.00	48.51	54.00	-5.49	41.19	7.32	Average	294 155																																																																										
4	5150.00	62.94	74.00	-11.06	55.62	7.32	Peak	294 155																																																																										
5	10360.00	60.59	68.20	-7.61	44.50	16.09	Peak	100 296																																																																										
6	15540.00	50.21	54.00	-3.79	32.84	17.37	Average	188 24																																																																										
7	15540.00	65.22	74.00	-8.78	47.85	17.37	Peak	188 24																																																																										
<p>Note 1: Emission Level (dBuV/m) = SA Reading (dBuV/m) + Factor* (dB) *Factor includes antenna factor , cable loss and amplifier gain Note 2: Margin (dB) = Emission level (dBuV/m) – Limit (dBuV/m).</p>																																																																																		

Modulation	HT20	Test Freq. (MHz)	5180
Polarization	Vertical		

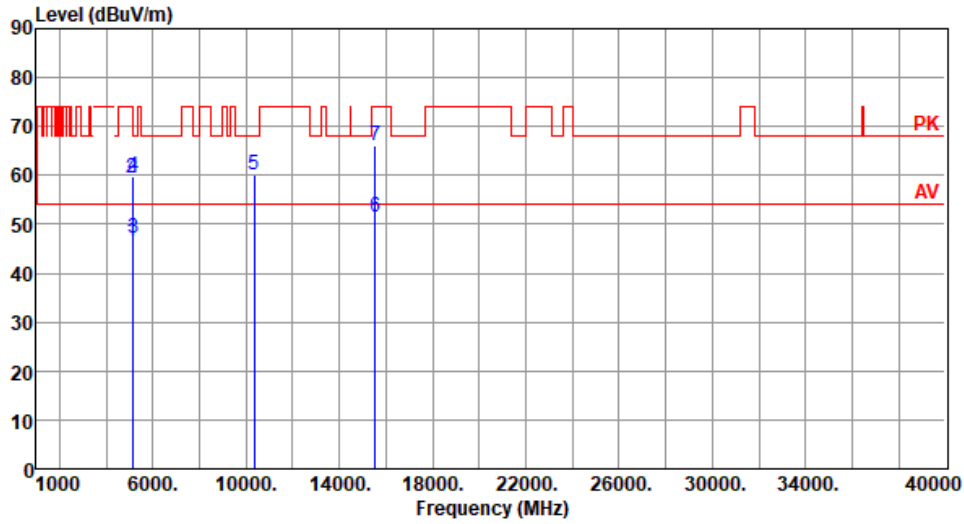

	Freq. MHz	Emission level dBuV/m	Limit dBuV/m	Margin dB	SA reading dBuV	Factor dB	Remark	ANT High cm	Turn Table deg
1	5120.00	46.54	54.00	-7.46	39.23	7.31	Average	248	103
2	5120.00	59.41	74.00	-14.59	52.10	7.31	Peak	248	103
3	5150.00	47.24	54.00	-6.76	39.92	7.32	Average	248	105
4	5150.00	59.86	74.00	-14.14	52.54	7.32	Peak	248	105
5	10360.00	60.22	68.20	-7.98	44.13	16.09	Peak	100	31
6	15540.00	51.56	54.00	-2.44	34.19	17.37	Average	191	328
7	15540.00	66.19	74.00	-7.81	48.82	17.37	Peak	191	328

Note 1: Emission Level (dBuV/m) = SA Reading (dBuV/m) + Factor* (dB)

*Factor includes antenna factor , cable loss and amplifier gain

Note 2: Margin (dB) = Emission level (dBuV/m) – Limit (dBuV/m).

Modulation	HT20	Test Freq. (MHz)	5200
Polarization	Horizontal		

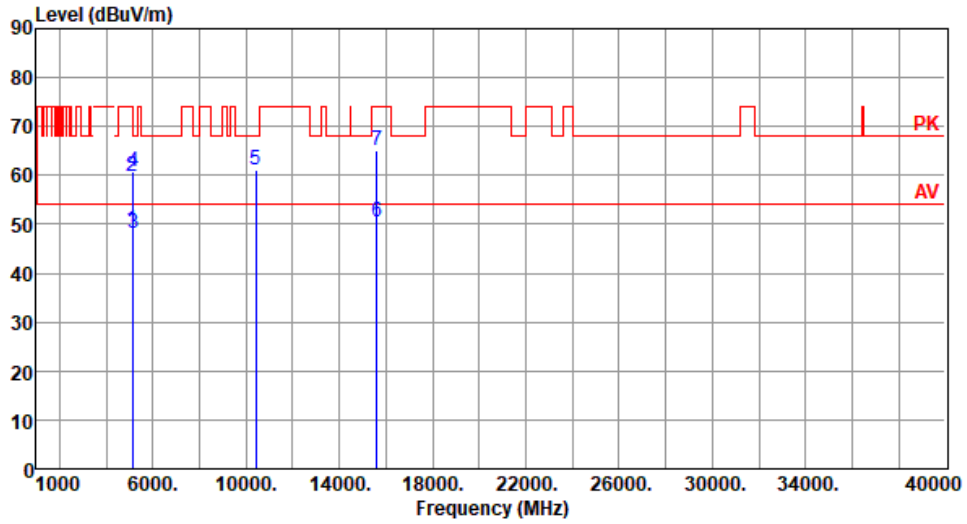

	Freq. MHz	Emission level dBuV/m	Limit dBuV/m	Margin dB	SA reading dBuV	Factor dB	Remark	ANT High cm	Turn Table deg
1	5120.00	48.91	54.00	-5.09	41.60	7.31	Average	294	144
2	5120.00	59.82	74.00	-14.18	52.51	7.31	Peak	294	144
3	5150.00	48.31	54.00	-5.69	40.99	7.32	Average	294	155
4	5150.00	60.74	74.00	-13.26	53.42	7.32	Peak	294	155
5	10400.00	60.98	68.20	-7.22	44.70	16.28	Peak	100	326
6	15600.00	50.61	54.00	-3.39	33.34	17.27	Average	189	21
7	15600.00	65.24	74.00	-8.76	47.97	17.27	Peak	189	21

Note 1: Emission Level (dBuV/m) = SA Reading (dBuV/m) + Factor* (dB)

*Factor includes antenna factor , cable loss and amplifier gain

Note 2: Margin (dB) = Emission level (dBuV/m) – Limit (dBuV/m).

Modulation	HT20	Test Freq. (MHz)	5200
Polarization	Vertical		

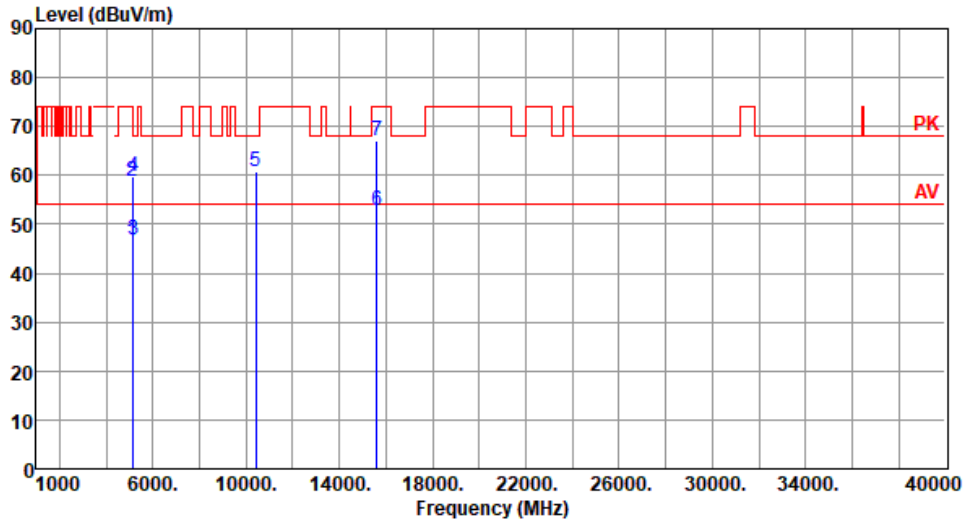

	Freq. MHz	Emission level dBuV/m	Limit dBuV/m	Margin dB	SA reading dBuV	Factor dB	Remark	ANT High cm	Turn Table deg
1	5120.00	46.41	54.00	-7.59	39.10	7.31	Average	244	103
2	5120.00	58.75	74.00	-15.25	51.44	7.31	Peak	244	103
3	5150.00	46.91	54.00	-7.09	39.59	7.32	Average	244	103
4	5150.00	59.68	74.00	-14.32	52.36	7.32	Peak	244	103
5	10400.00	60.69	68.20	-7.51	44.41	16.28	Peak	100	33
6	15600.00	52.74	54.00	-1.26	35.47	17.27	Average	188	315
7	15600.00	67.11	74.00	-6.89	49.84	17.27	Peak	188	315

Note 1: Emission Level (dBuV/m) = SA Reading (dBuV/m) + Factor* (dB)

*Factor includes antenna factor , cable loss and amplifier gain

Note 2: Margin (dB) = Emission level (dBuV/m) – Limit (dBuV/m).

Modulation	HT20	Test Freq. (MHz)	5240
Polarization	Horizontal		

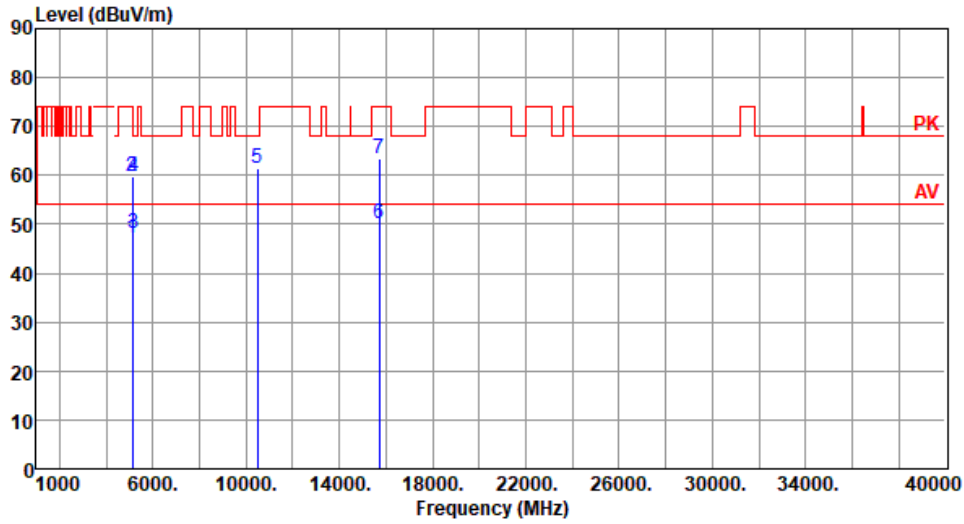

	Freq. MHz	Emission level dBuV/m	Limit dBuV/m	Margin dB	SA reading dBuV	Factor dB	Remark	ANT High cm	Turn Table deg
1	5120.00	47.15	54.00	-6.85	39.84	7.31	Average	265	143
2	5120.00	59.84	74.00	-14.16	52.53	7.31	Peak	265	143
3	5148.00	48.31	54.00	-5.69	41.00	7.31	Average	265	145
4	5148.00	59.86	74.00	-14.14	52.55	7.31	Peak	265	145
5	10480.00	61.35	68.20	-6.85	44.94	16.41	Peak	100	71
6	15720.00	50.21	54.00	-3.79	33.61	16.60	Average	196	8
7	15720.00	63.45	74.00	-10.55	46.85	16.60	Peak	196	8

Note 1: Emission Level (dBuV/m) = SA Reading (dBuV/m) + Factor* (dB)

*Factor includes antenna factor , cable loss and amplifier gain

Note 2: Margin (dB) = Emission level (dBuV/m) – Limit (dBuV/m).

Modulation	HT20	Test Freq. (MHz)	5240
Polarization	Vertical		

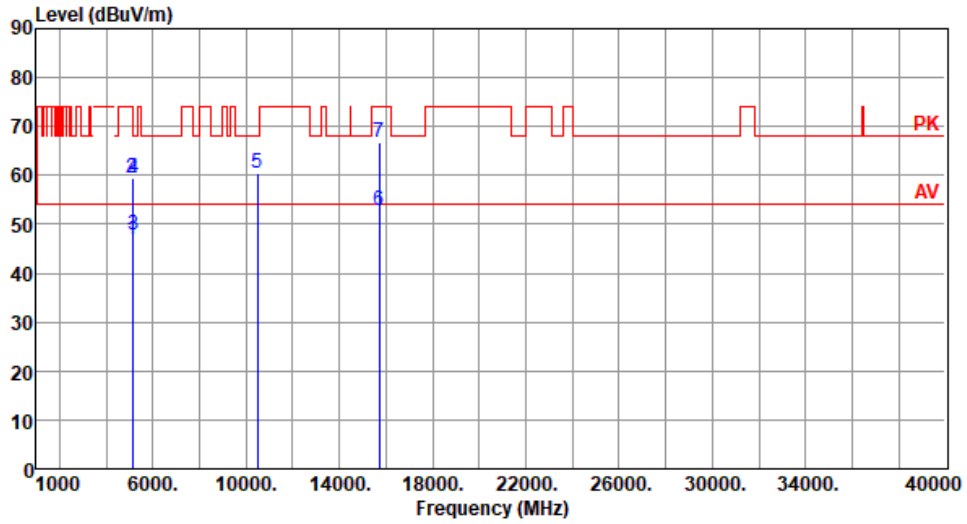

	Freq. MHz	Emission level dBuV/m	Limit dBuV/m	Margin dB	SA reading dBuV	Factor dB	Remark	ANT High cm	Turn Table deg
1	5120.00	46.78	54.00	-7.22	39.47	7.31	Average	246	107
2	5120.00	59.47	74.00	-14.53	52.16	7.31	Peak	246	107
3	5148.00	47.77	54.00	-6.23	40.46	7.31	Average	246	107
4	5148.00	59.57	74.00	-14.43	52.26	7.31	Peak	246	107
5	10480.00	60.45	68.20	-7.75	44.04	16.41	Peak	100	88
6	15720.00	52.76	54.00	-1.24	36.16	16.60	Average	241	316
7	15720.00	66.82	74.00	-7.18	50.22	16.60	Peak	241	316

Note 1: Emission Level (dBuV/m) = SA Reading (dBuV/m) + Factor* (dB)

*Factor includes antenna factor , cable loss and amplifier gain

Note 2: Margin (dB) = Emission level (dBuV/m) – Limit (dBuV/m).

Modulation	HT20	Test Freq. (MHz)	5260
Polarization	Horizontal		

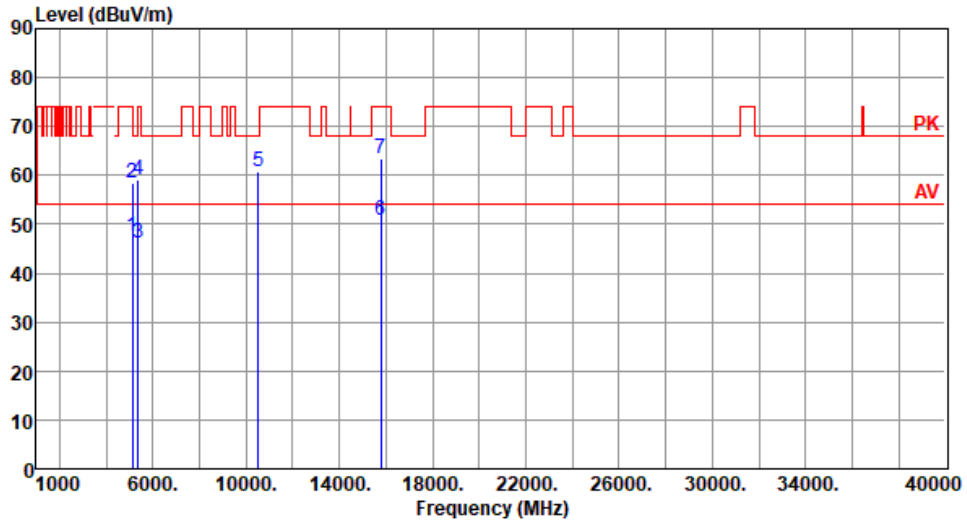

	Freq. MHz	Emission level dBuV/m	Limit dBuV/m	Margin dB	SA reading dBuV	Factor dB	Remark	ANT High cm	Turn Table deg
1	5120.00	47.64	54.00	-6.36	40.33	7.31	Average	254	151
2	5120.00	58.56	74.00	-15.44	51.25	7.31	Peak	254	151
3	5350.00	46.15	54.00	-7.85	39.30	6.85	Average	254	151
4	5350.00	59.04	74.00	-14.96	52.19	6.85	Peak	254	151
5	10520.00	60.75	68.20	-7.45	44.33	16.42	Peak	100	81
6	15780.00	50.86	54.00	-3.14	34.30	16.56	Average	211	325
7	15780.00	63.54	74.00	-10.46	46.98	16.56	Peak	211	325

Note 1: Emission Level (dBuV/m) = SA Reading (dBuV/m) + Factor* (dB)

*Factor includes antenna factor , cable loss and amplifier gain

Note 2: Margin (dB) = Emission level (dBuV/m) – Limit (dBuV/m).

Modulation	HT20	Test Freq. (MHz)	5260
Polarization	Vertical		

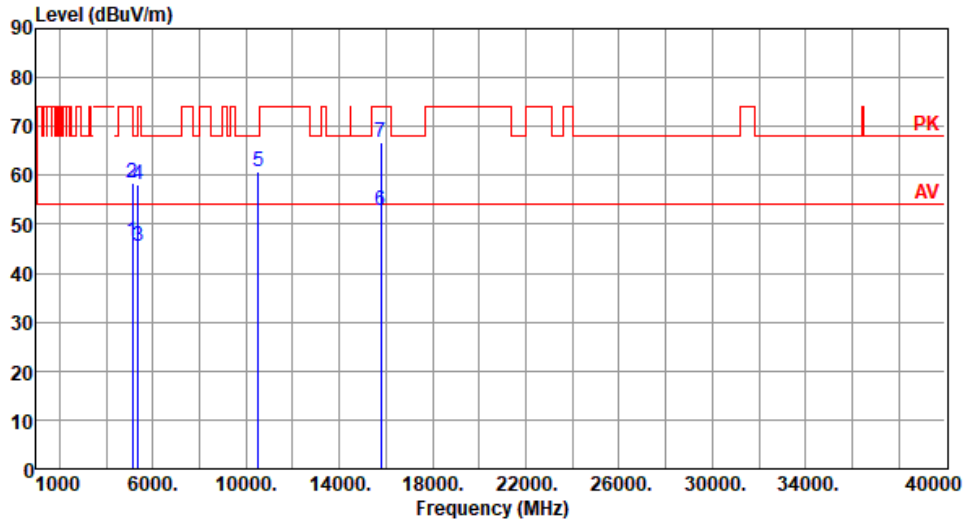

	Freq. MHz	Emission level dBuV/m	Limit dBuV/m	Margin dB	SA reading dBuV	Factor dB	Remark	ANT High cm	Turn Table deg
1	5120.00	46.55	54.00	-7.45	39.24	7.31	Average	246	96
2	5120.00	58.51	74.00	-15.49	51.20	7.31	Peak	246	96
3	5350.00	45.38	54.00	-8.62	38.53	6.85	Average	246	96
4	5350.00	58.16	74.00	-15.84	51.31	6.85	Peak	246	96
5	10520.00	60.69	68.20	-7.51	44.27	16.42	Peak	100	88
6	15780.00	52.64	54.00	-1.36	36.08	16.56	Average	235	316
7	15780.00	66.59	74.00	-7.41	50.03	16.56	Peak	235	316

Note 1: Emission Level (dBuV/m) = SA Reading (dBuV/m) + Factor* (dB)

*Factor includes antenna factor , cable loss and amplifier gain

Note 2: Margin (dB) = Emission level (dBuV/m) – Limit (dBuV/m).

Modulation	HT20	Test Freq. (MHz)	5300
Polarization	Horizontal		

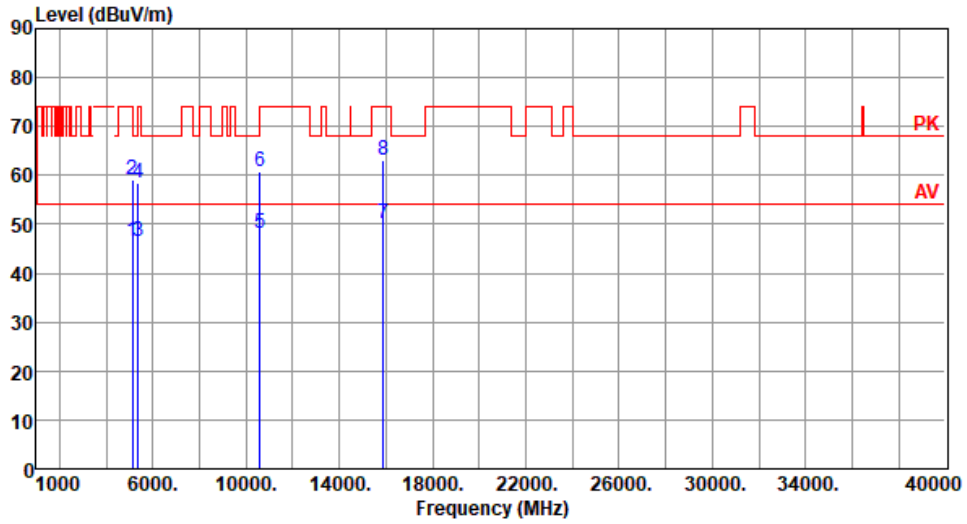

	Freq. MHz	Emission level dBuV/m	Limit dBuV/m	Margin dB	SA reading dBuV	Factor dB	Remark	ANT High cm	Turn Table deg
1	5120.00	46.58	54.00	-7.42	39.27	7.31	Average	253	149
2	5120.00	59.12	74.00	-14.88	51.81	7.31	Peak	253	149
3	5350.00	46.64	54.00	-7.36	39.79	6.85	Average	253	152
4	5350.00	58.31	74.00	-15.69	51.46	6.85	Peak	253	152
5	10600.00	48.25	54.00	-5.75	31.89	16.36	Average	100	18
6	10600.00	60.82	74.00	-13.18	44.46	16.36	Peak	100	18
7	15900.00	50.24	54.00	-3.76	33.55	16.69	Average	206	324
8	15900.00	63.15	74.00	-10.85	46.46	16.69	Peak	206	324

Note 1: Emission Level (dBuV/m) = SA Reading (dBuV/m) + Factor* (dB)

*Factor includes antenna factor , cable loss and amplifier gain

Note 2: Margin (dB) = Emission level (dBuV/m) – Limit (dBuV/m).

Modulation	HT20	Test Freq. (MHz)	5300
Polarization	Vertical		

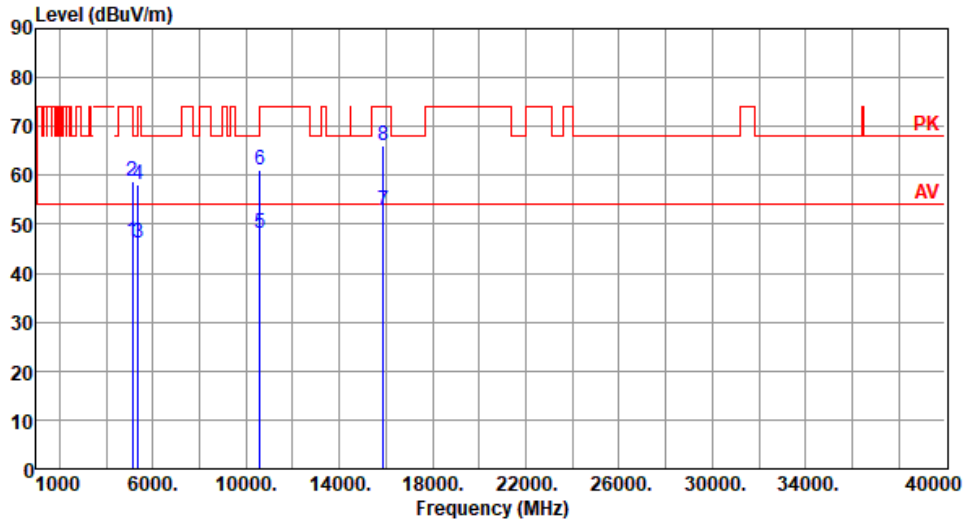

	Freq. MHz	Emission level dBuV/m	Limit dBuV/m	Margin dB	SA reading dBuV	Factor dB	Remark	ANT High cm	Turn Table deg
1	5120.00	46.66	54.00	-7.34	39.35	7.31	Average	245	99
2	5120.00	58.87	74.00	-15.13	51.56	7.31	Peak	245	99
3	5350.00	46.30	54.00	-7.70	39.45	6.85	Average	245	99
4	5350.00	58.19	74.00	-15.81	51.34	6.85	Peak	245	99
5	10600.00	48.14	54.00	-5.86	31.78	16.36	Average	105	55
6	10600.00	60.95	74.00	-13.05	44.59	16.36	Peak	105	55
7	15900.00	52.64	54.00	-1.36	35.95	16.69	Average	199	314
8	15900.00	66.02	74.00	-7.98	49.33	16.69	Peak	199	314

Note 1: Emission Level (dBuV/m) = SA Reading (dBuV/m) + Factor* (dB)

*Factor includes antenna factor , cable loss and amplifier gain

Note 2: Margin (dB) = Emission level (dBuV/m) – Limit (dBuV/m).

Modulation	HT20	Test Freq. (MHz)	5320
Polarization	Horizontal		

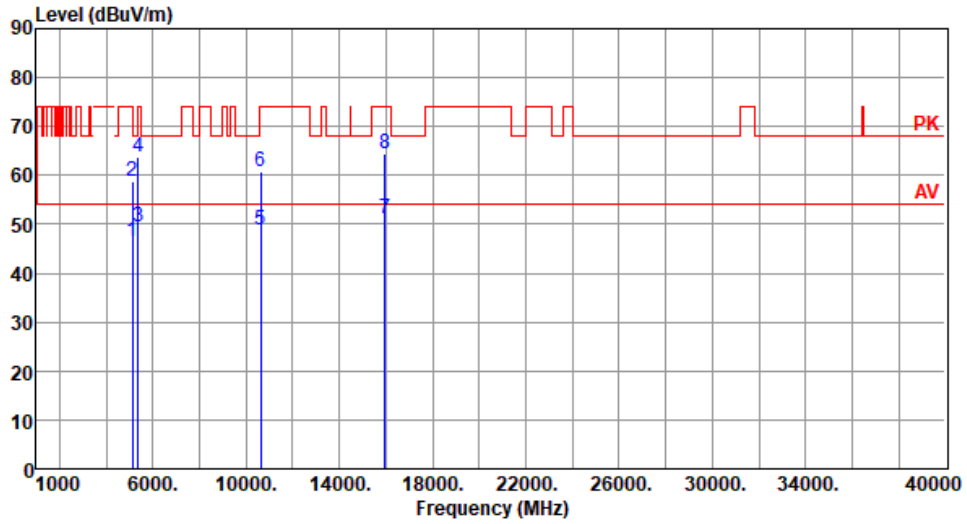

	Freq. MHz	Emission level dBuV/m	Limit dBuV/m	Margin dB	SA reading dBuV	Factor dB	Remark	ANT High cm	Turn Table deg
1	5120.00	46.42	54.00	-7.58	39.11	7.31	Average	261	149
2	5120.00	58.91	74.00	-15.09	51.60	7.31	Peak	261	149
3	5350.00	49.62	54.00	-4.38	42.77	6.85	Average	261	156
4	5350.00	63.65	74.00	-10.35	56.80	6.85	Peak	261	156
5	10640.00	48.77	54.00	-5.23	32.40	16.37	Average	100	61
6	10640.00	60.87	74.00	-13.13	44.50	16.37	Peak	100	61
7	15960.00	51.26	54.00	-2.74	34.73	16.53	Average	210	324
8	15960.00	64.58	74.00	-9.42	48.05	16.53	Peak	210	324

Note 1: Emission Level (dBuV/m) = SA Reading (dBuV/m) + Factor* (dB)

*Factor includes antenna factor , cable loss and amplifier gain

Note 2: Margin (dB) = Emission level (dBuV/m) – Limit (dBuV/m).

Modulation	HT20	Test Freq. (MHz)	5320
Polarization	Vertical		

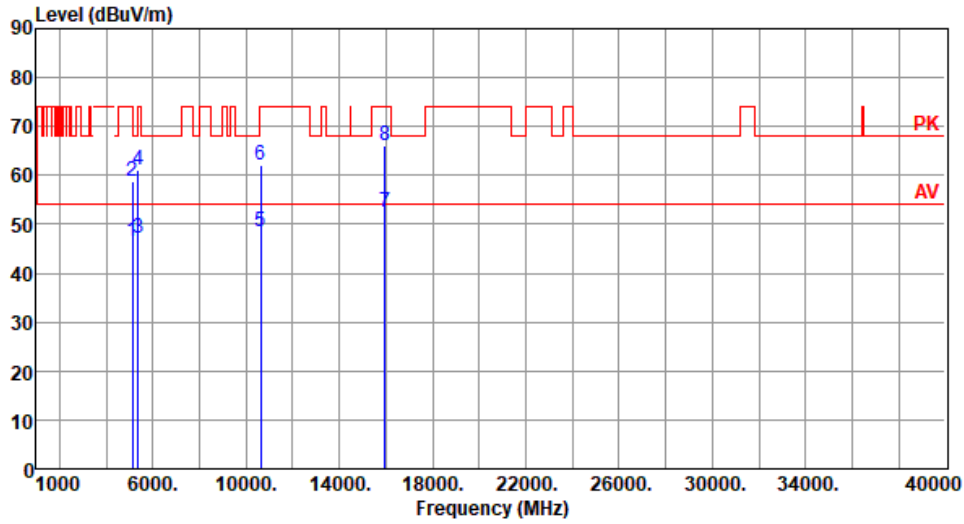

	Freq. MHz	Emission level dBuV/m	Limit dBuV/m	Margin dB	SA reading dBuV	Factor dB	Remark	ANT High cm	Turn Table deg
1	5120.00	46.56	54.00	-7.44	39.25	7.31	Average	248	97
2	5120.00	58.85	74.00	-15.15	51.54	7.31	Peak	248	97
3	5350.00	47.31	54.00	-6.69	40.46	6.85	Average	248	97
4	5350.00	60.97	74.00	-13.03	54.12	6.85	Peak	248	97
5	10640.00	48.55	54.00	-5.45	32.18	16.37	Average	100	91
6	10640.00	62.13	74.00	-11.87	45.76	16.37	Peak	100	91
7	15960.00	52.35	54.00	-1.65	35.82	16.53	Average	211	314
8	15960.00	66.04	74.00	-7.96	49.51	16.53	Peak	211	314

Note 1: Emission Level (dBuV/m) = SA Reading (dBuV/m) + Factor* (dB)

*Factor includes antenna factor , cable loss and amplifier gain

Note 2: Margin (dB) = Emission level (dBuV/m) – Limit (dBuV/m).

Modulation	HT20	Test Freq. (MHz)	5500
Polarization	Horizontal		

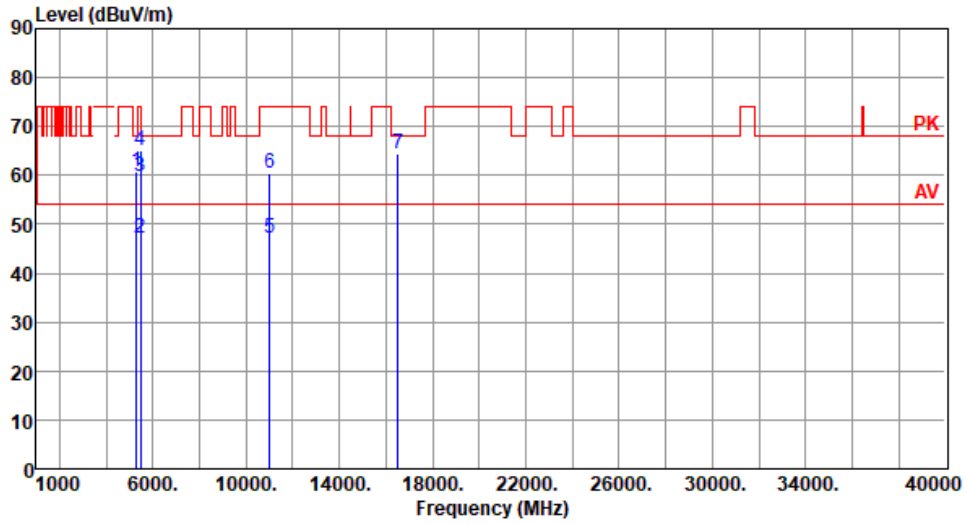

	Freq. MHz	Emission level dBuV/m	Limit dBuV/m	Margin dB	SA reading dBuV	Factor dB	Remark	ANT High cm	Turn Table deg
1	5280.00	60.94	68.20	-7.26	54.05	6.89	Peak	244	145
2	5460.00	47.29	54.00	-6.71	40.04	7.25	Average	244	145
3	5460.00	59.86	74.00	-14.14	52.61	7.25	Peak	244	145
4	5470.00	64.98	68.20	-3.22	57.70	7.28	Peak	244	145
5	11000.00	47.12	54.00	-6.88	30.28	16.84	Average	100	96
6	11000.00	60.34	74.00	-13.66	43.50	16.84	Peak	100	96
7	16500.00	64.28	68.20	-3.92	46.64	17.64	Peak	231	328

Note 1: Emission Level (dBuV/m) = SA Reading (dBuV/m) + Factor* (dB)

*Factor includes antenna factor , cable loss and amplifier gain

Note 2: Margin (dB) = Emission level (dBuV/m) – Limit (dBuV/m).

Modulation	HT20	Test Freq. (MHz)	5500
Polarization	Vertical		

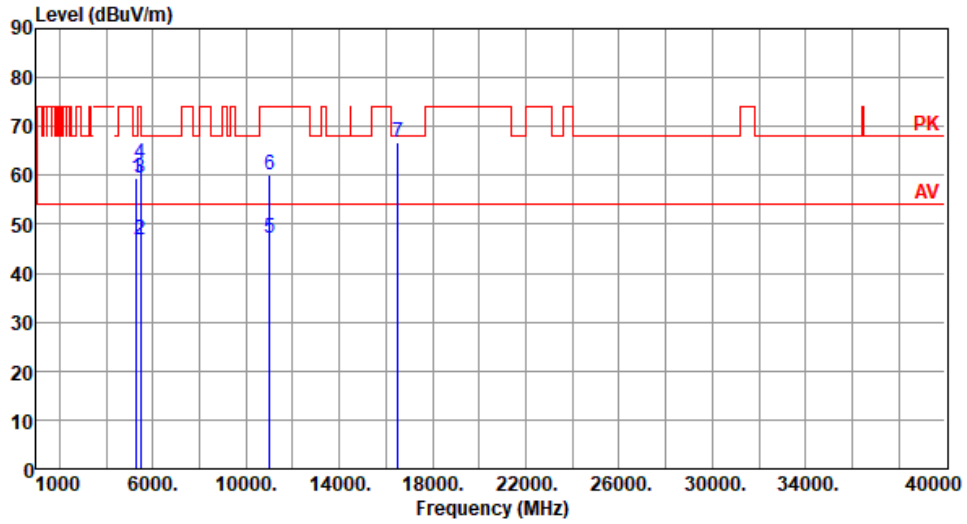

	Freq. MHz	Emission level dBUV/m	Limit dBUV/m	Margin dB	SA reading dBUV	Factor dB	Remark	ANT High cm	Turn Table deg
1	5280.00	59.29	68.20	-8.91	52.40	6.89	Peak	277	119
2	5460.00	46.80	54.00	-7.20	39.55	7.25	Average	277	119
3	5460.00	59.51	74.00	-14.49	52.26	7.25	Peak	277	119
4	5470.00	62.41	68.20	-5.79	55.13	7.28	Peak	277	119
5	11000.00	47.21	54.00	-6.79	30.37	16.84	Average	100	69
6	11000.00	60.04	74.00	-13.96	43.20	16.84	Peak	100	69
7	16500.00	66.85	68.20	-1.35	49.21	17.64	Peak	233	315

Note 1: Emission Level (dBUV/m) = SA Reading (dBUV/m) + Factor* (dB)

*Factor includes antenna factor , cable loss and amplifier gain

Note 2: Margin (dB) = Emission level (dBUV/m) – Limit (dBUV/m).

Modulation	HT20	Test Freq. (MHz)	5580
Polarization	Horizontal		

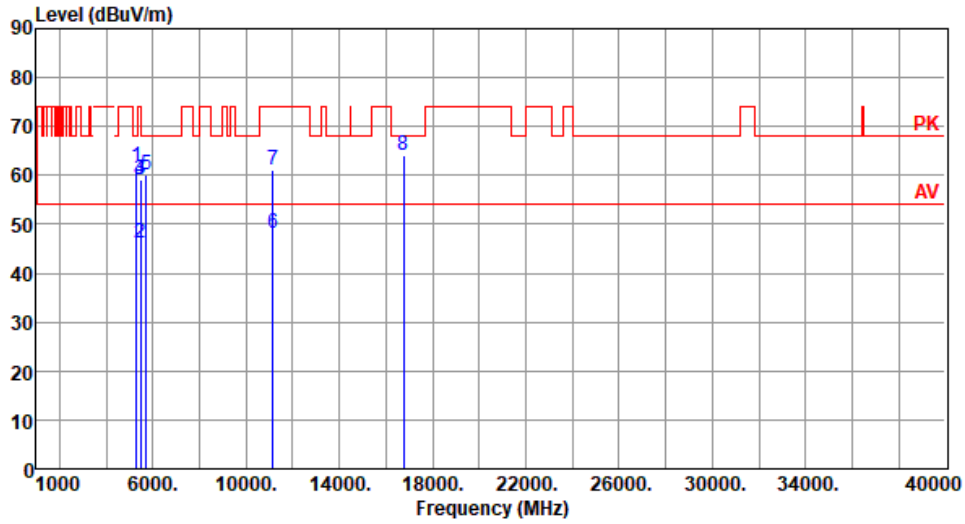

	Freq. MHz	Emission level dBuV/m	Limit dBuV/m	Margin dB	SA reading dBuV	Factor dB	Remark	ANT High cm	Turn Table deg
1	5280.00	61.69	68.20	-6.51	54.80	6.89	Peak	246	152
2	5460.00	46.12	54.00	-7.88	38.87	7.25	Average	246	155
3	5460.00	58.95	74.00	-15.05	51.70	7.25	Peak	246	155
4	5470.00	59.03	68.20	-9.17	51.75	7.28	Peak	246	155
5	5725.00	60.24	68.20	-7.96	52.58	7.66	Peak	246	155
6	11160.00	48.17	54.00	-5.83	31.58	16.59	Average	100	25
7	11160.00	61.04	74.00	-12.96	44.45	16.59	Peak	100	25
8	16740.00	64.13	68.20	-4.07	45.90	18.23	Peak	226	335

Note 1: Emission Level (dBuV/m) = SA Reading (dBuV/m) + Factor* (dB)

*Factor includes antenna factor , cable loss and amplifier gain

Note 2: Margin (dB) = Emission level (dBuV/m) – Limit (dBuV/m).

Modulation	HT20	Test Freq. (MHz)	5580
Polarization	Vertical		

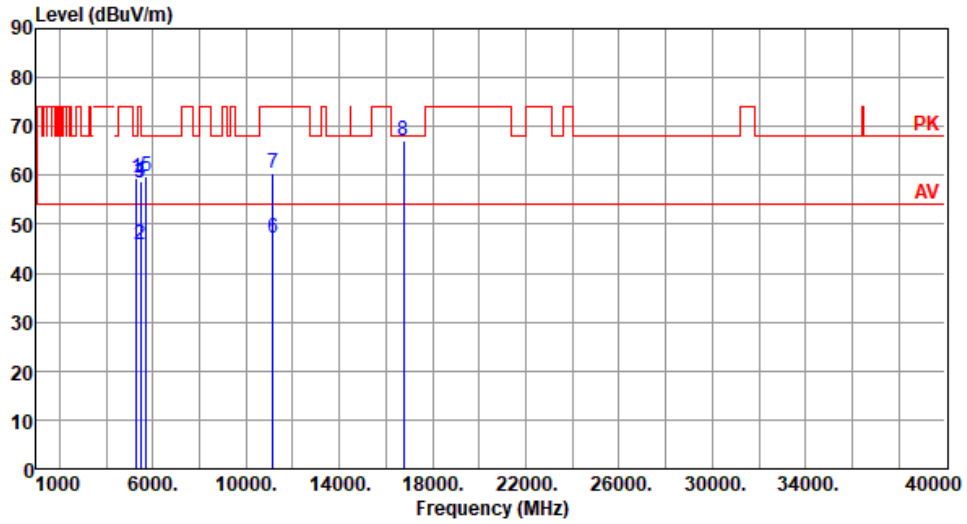

	Freq. MHz	Emission level dBuV/m	Limit dBuV/m	Margin dB	SA reading dBuV	Factor dB	Remark	ANT High cm	Turn Table deg
1	5280.00	59.45	68.20	-8.75	52.56	6.89	Peak	275	119
2	5460.00	45.75	54.00	-8.25	38.50	7.25	Average	275	119
3	5460.00	58.42	74.00	-15.58	51.17	7.25	Peak	275	119
4	5470.00	58.89	68.20	-9.31	51.61	7.28	Peak	275	119
5	5725.00	59.94	68.20	-8.26	52.28	7.66	Peak	275	119
6	11160.00	47.29	54.00	-6.71	30.70	16.59	Average	100	35
7	11160.00	60.52	74.00	-13.48	43.93	16.59	Peak	100	35
8	16740.00	67.02	68.20	-1.18	48.79	18.23	Peak	223	326

Note 1: Emission Level (dBuV/m) = SA Reading (dBuV/m) + Factor* (dB)

*Factor includes antenna factor , cable loss and amplifier gain

Note 2: Margin (dB) = Emission level (dBuV/m) – Limit (dBuV/m).

Modulation	HT20	Test Freq. (MHz)	5700
Polarization	Horizontal		

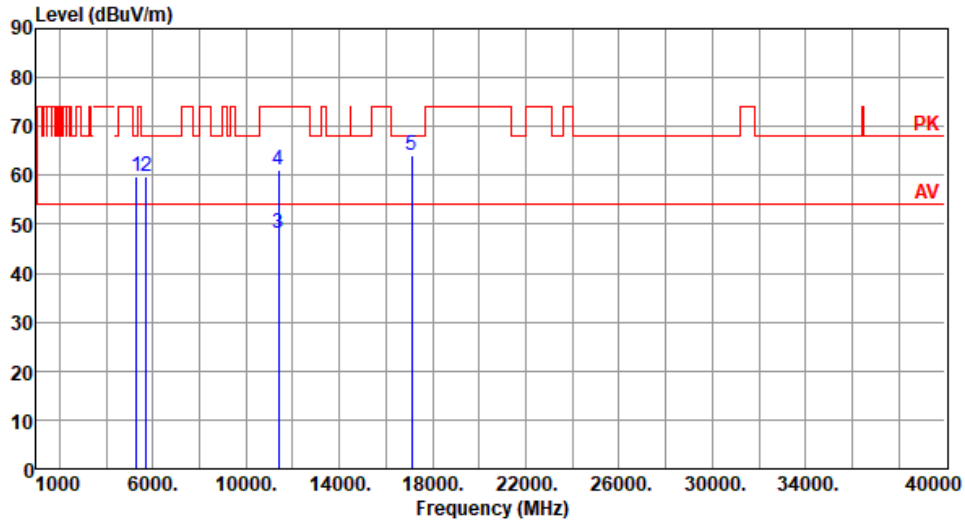

	Freq. MHz	Emission level dBuV/m	Limit dBuV/m	Margin dB	SA reading dBuV	Factor dB	Remark	ANT High cm	Turn Table deg
1	5280.00	59.86	68.20	-8.34	52.97	6.89	Peak	258	149
2	5725.00	59.81	68.20	-8.39	52.15	7.66	Peak	258	149
3	11400.00	48.29	54.00	-5.71	31.56	16.73	Average	100	42
4	11400.00	61.16	74.00	-12.84	44.43	16.73	Peak	100	42
5	17100.00	63.98	68.20	-4.22	45.74	18.24	Peak	216	330

Note 1: Emission Level (dBuV/m) = SA Reading (dBuV/m) + Factor* (dB)

*Factor includes antenna factor , cable loss and amplifier gain

Note 2: Margin (dB) = Emission level (dBuV/m) – Limit (dBuV/m).

Modulation	HT20	Test Freq. (MHz)	5700
Polarization	Vertical		

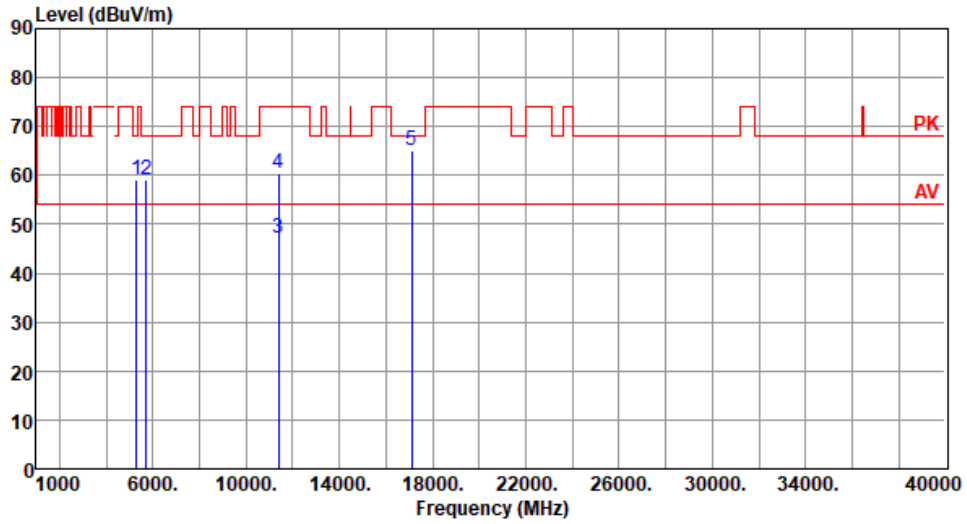

	Freq. MHz	Emission level dBuV/m	Limit dBuV/m	Margin dB	SA reading dBuV	Factor dB	Remark	ANT High cm	Turn Table deg
1	5280.00	59.00	68.20	-9.20	52.11	6.89	Peak	277	116
2	5725.00	59.11	68.20	-9.09	51.45	7.66	Peak	277	116
3	11400.00	47.16	54.00	-6.84	30.43	16.73	Average	100	42
4	11400.00	60.48	74.00	-13.52	43.75	16.73	Peak	100	42
5	17100.00	65.05	68.20	-3.15	46.81	18.24	Peak	219	321

Note 1: Emission Level (dBuV/m) = SA Reading (dBuV/m) + Factor* (dB)

*Factor includes antenna factor , cable loss and amplifier gain

Note 2: Margin (dB) = Emission level (dBuV/m) – Limit (dBuV/m).

Modulation	HT20	Test Freq. (MHz)	5720
Polarization	Horizontal		

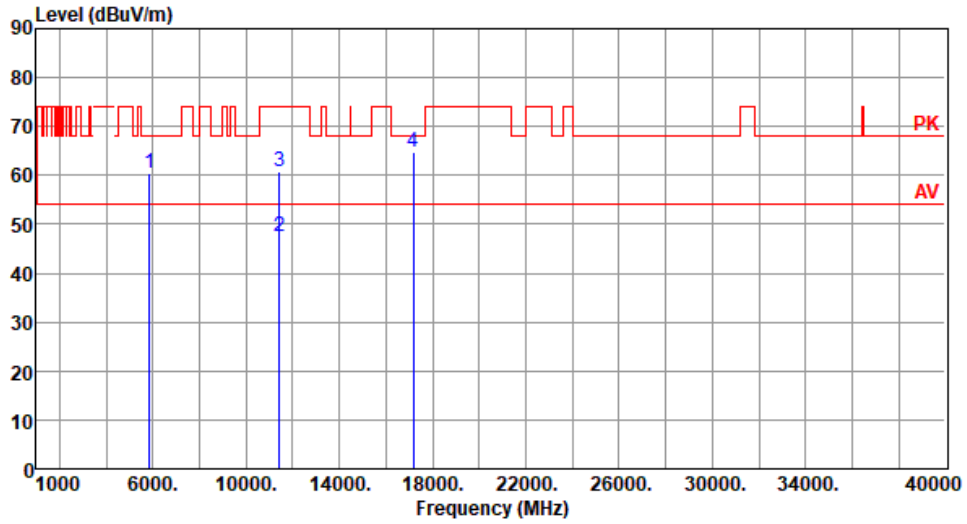

	Freq. MHz	Emission level dBuV/m	Limit dBuV/m	Margin dB	SA reading dBuV	Factor dB	Remark	ANT High cm	Turn Table deg
1	5850.00	60.46	68.20	-7.74	52.44	8.02	Peak	249	156
2	11440.00	47.58	54.00	-6.42	30.84	16.74	Average	100	42
3	11440.00	60.89	74.00	-13.11	44.15	16.74	Peak	100	42
4	17160.00	64.79	68.20	-3.41	46.41	18.38	Peak	216	323

Note 1: Emission Level (dBuV/m) = SA Reading (dBuV/m) + Factor* (dB)

*Factor includes antenna factor , cable loss and amplifier gain

Note 2: Margin (dB) = Emission level (dBuV/m) – Limit (dBuV/m).

Modulation	HT20	Test Freq. (MHz)	5720
Polarization	Vertical		

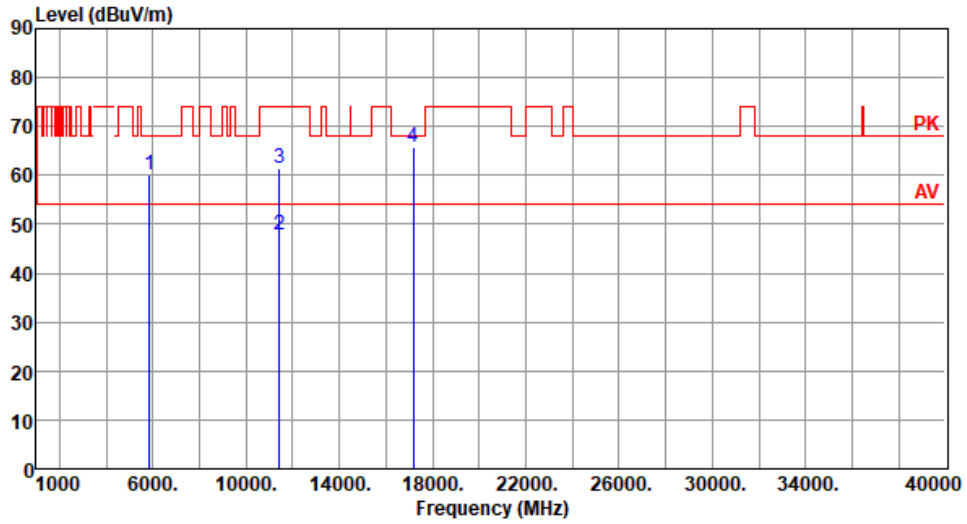

	Freq. MHz	Emission level dBuV/m	Limit dBuV/m	Margin dB	SA reading dBuV	Factor dB	Remark	ANT High cm	Turn Table deg
1	5850.00	60.15	68.20	-8.05	52.13	8.02	Peak	254	95
2	11440.00	47.94	54.00	-6.06	31.20	16.74	Average	100	44
3	11440.00	61.28	74.00	-12.72	44.54	16.74	Peak	100	44
4	17160.00	65.88	68.20	-2.32	47.50	18.38	Peak	210	326

Note 1: Emission Level (dBuV/m) = SA Reading (dBuV/m) + Factor* (dB)

*Factor includes antenna factor , cable loss and amplifier gain

Note 2: Margin (dB) = Emission level (dBuV/m) – Limit (dBuV/m).

Modulation	HT20	Test Freq. (MHz)	5745
Polarization	Horizontal		

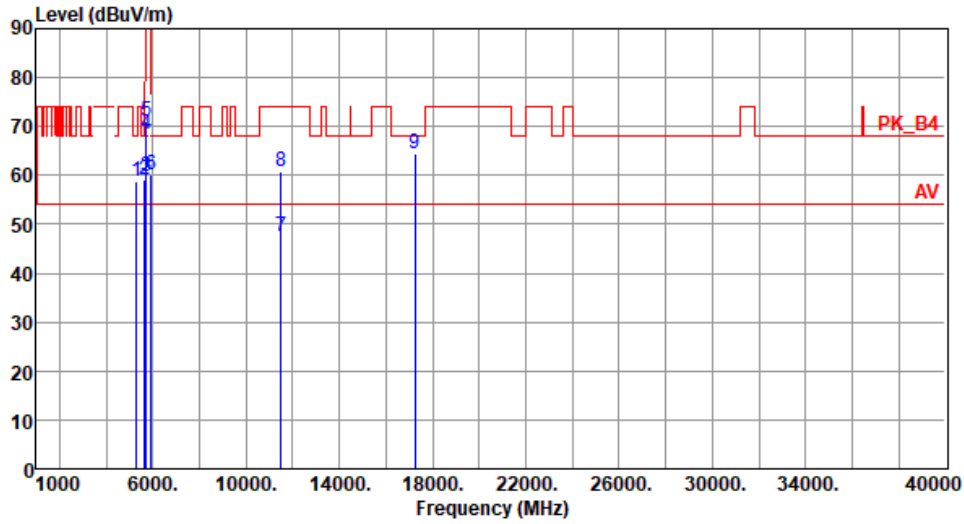

	Freq. MHz	Emission level dBuV/m	Limit dBuV/m	Margin dB	SA reading dBuV	Factor dB	Remark	ANT High cm	Turn Table deg
1	5280.00	58.84	68.20	-9.36	51.95	6.89	Peak	248	155
2	5650.00	59.14	68.20	-9.06	51.75	7.39	Peak	248	155
3	5700.00	59.88	105.20	-45.32	52.38	7.50	Peak	248	155
4	5720.00	68.45	110.80	-42.35	60.83	7.62	Peak	248	155
5	5725.00	71.06	122.20	-51.14	63.40	7.66	Peak	248	155
6	5925.00	60.16	68.20	-8.04	52.09	8.07	Peak	248	155
7	11490.00	47.50	54.00	-6.50	30.74	16.76	Average	100	58
8	11490.00	60.62	74.00	-13.38	43.86	16.76	Peak	100	58
9	17235.00	64.35	68.20	-3.85	45.71	18.64	Peak	215	326

Note 1: Emission Level (dBuV/m) = SA Reading (dBuV/m) + Factor* (dB)

*Factor includes antenna factor , cable loss and amplifier gain

Note 2: Margin (dB) = Emission level (dBuV/m) – Limit (dBuV/m).

Modulation	HT20	Test Freq. (MHz)	5745
Polarization	Vertical		

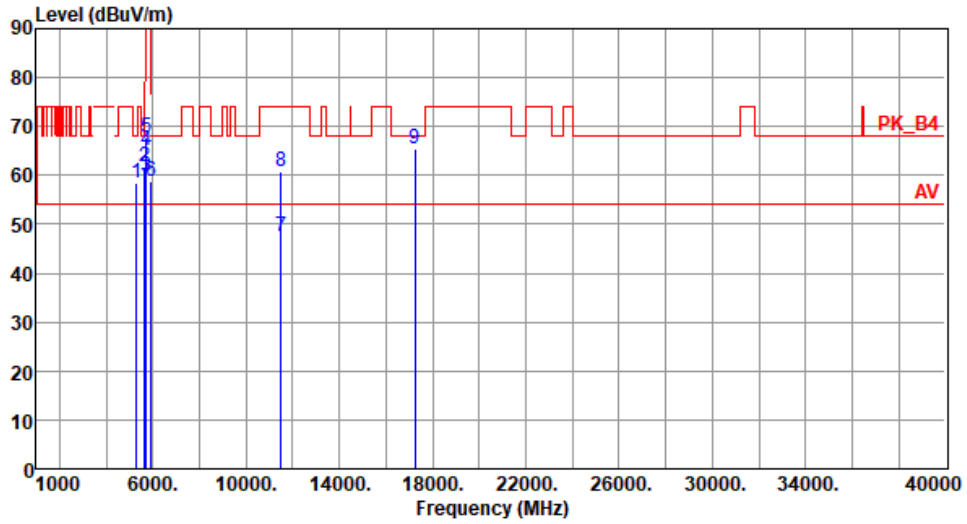

	Freq. MHz	Emission level dBuV/m	Limit dBuV/m	Margin dB	SA reading dBuV	Factor dB	Remark	ANT High cm	Turn Table deg
1	5280.00	58.35	68.20	-9.85	51.46	6.89	Peak	255	90
2	5650.00	61.81	68.20	-6.39	54.42	7.39	Peak	255	90
3	5700.00	59.75	105.20	-45.45	52.25	7.50	Peak	255	90
4	5720.00	64.95	110.80	-45.85	57.33	7.62	Peak	255	90
5	5725.00	67.90	122.20	-54.30	60.24	7.66	Peak	255	90
6	5925.00	58.67	68.20	-9.53	50.60	8.07	Peak	255	90
7	11490.00	47.63	54.00	-6.37	30.87	16.76	Average	102	61
8	11490.00	60.89	74.00	-13.11	44.13	16.76	Peak	102	61
9	17235.00	65.46	68.20	-2.74	46.82	18.64	Peak	211	325

Note 1: Emission Level (dBuV/m) = SA Reading (dBuV/m) + Factor* (dB)

*Factor includes antenna factor , cable loss and amplifier gain

Note 2: Margin (dB) = Emission level (dBuV/m) – Limit (dBuV/m).

Modulation	HT20	Test Freq. (MHz)	5785
Polarization	Horizontal		

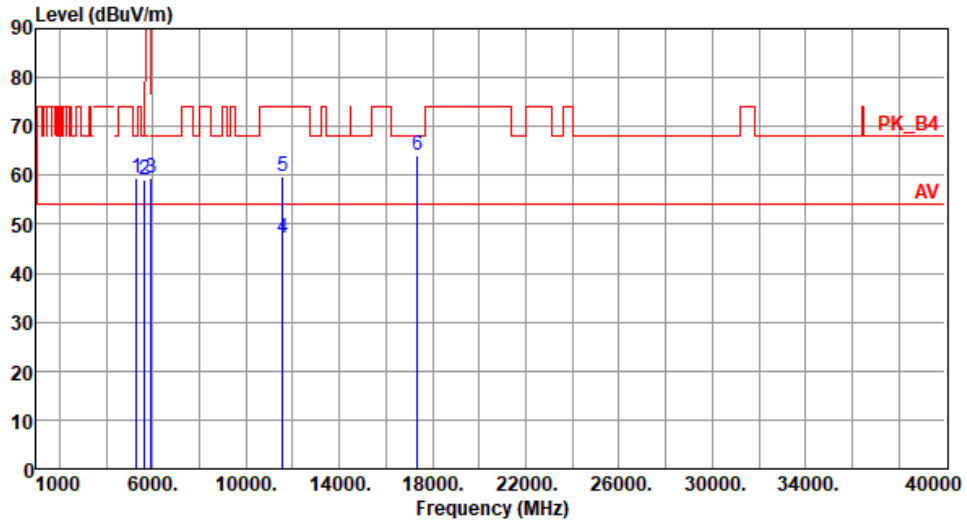

	Freq. MHz	Emission level dBuV/m	Limit dBuV/m	Margin dB	SA reading dBuV	Factor dB	Remark	ANT High cm	Turn Table deg
1	5280.00	59.36	68.20	-8.84	52.47	6.89	Peak	255	151
2	5650.00	59.18	68.20	-9.02	51.79	7.39	Peak	255	151
3	5925.00	59.35	68.20	-8.85	51.28	8.07	Peak	255	151
4	11570.00	47.05	54.00	-6.95	30.44	16.61	Average	100	64
5	11570.00	59.82	74.00	-14.18	43.21	16.61	Peak	100	64
6	17355.00	64.13	68.20	-4.07	44.90	19.23	Peak	211	325

Note 1: Emission Level (dBuV/m) = SA Reading (dBuV/m) + Factor* (dB)

*Factor includes antenna factor , cable loss and amplifier gain

Note 2: Margin (dB) = Emission level (dBuV/m) – Limit (dBuV/m).

Modulation	HT20	Test Freq. (MHz)	5785
Polarization	Vertical		

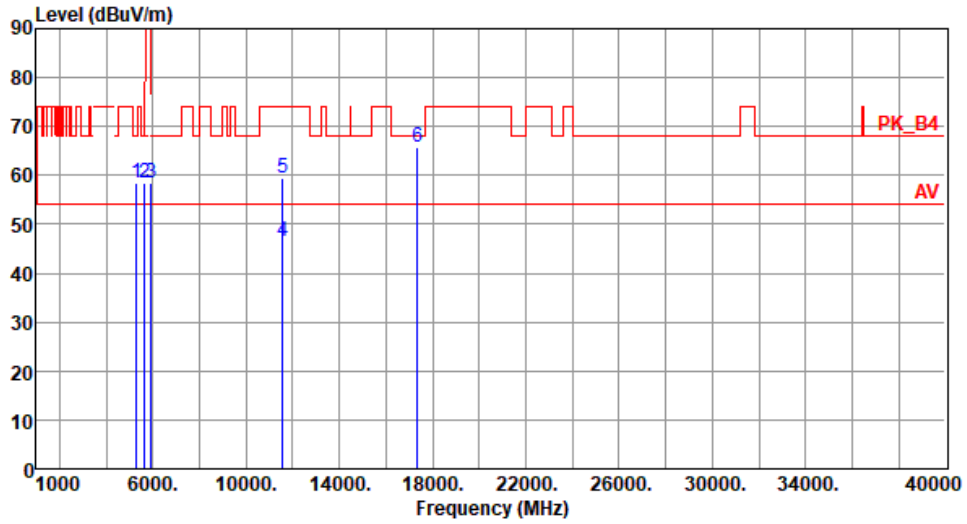

	Freq. MHz	Emission level dBuV/m	Limit dBuV/m	Margin dB	SA reading dBuV	Factor dB	Remark	ANT High cm	Turn Table deg
1	5280.00	58.29	68.20	-9.91	51.40	6.89	Peak	255	91
2	5650.00	58.36	68.20	-9.84	50.97	7.39	Peak	255	91
3	5925.00	58.39	68.20	-9.81	50.32	8.07	Peak	255	91
4	11570.00	46.58	54.00	-7.42	29.97	16.61	Average	100	33
5	11570.00	59.41	74.00	-14.59	42.80	16.61	Peak	100	33
6	17355.00	65.92	68.20	-2.28	46.69	19.23	Peak	205	336

Note 1: Emission Level (dBuV/m) = SA Reading (dBuV/m) + Factor* (dB)

*Factor includes antenna factor , cable loss and amplifier gain

Note 2: Margin (dB) = Emission level (dBuV/m) – Limit (dBuV/m).

Modulation	HT20	Test Freq. (MHz)	5825
Polarization	Horizontal		

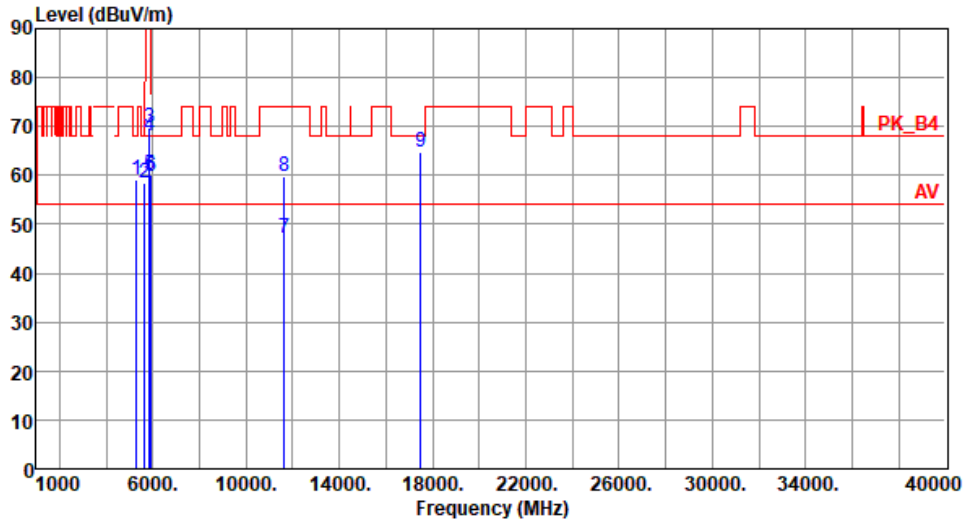

	Freq. MHz	Emission level dBuV/m	Limit dBuV/m	Margin dB	SA reading dBuV	Factor dB	Remark	ANT High cm	Turn Table deg
1	5280.00	59.26	68.20	-8.94	52.37	6.89	Peak	235	155
2	5650.00	58.59	68.20	-9.61	51.20	7.39	Peak	235	155
3	5850.00	69.86	122.20	-52.34	61.84	8.02	Peak	235	155
4	5855.00	68.21	110.80	-42.59	60.19	8.02	Peak	235	155
5	5875.00	60.24	105.20	-44.96	52.21	8.03	Peak	235	155
6	5925.00	59.88	68.20	-8.32	51.81	8.07	Peak	235	155
7	11650.00	47.06	54.00	-6.94	30.68	16.38	Average	100	51
8	11650.00	59.84	74.00	-14.16	43.46	16.38	Peak	100	51
9	17475.00	64.75	68.20	-3.45	45.01	19.74	Peak	225	331

Note 1: Emission Level (dBuV/m) = SA Reading (dBuV/m) + Factor* (dB)

*Factor includes antenna factor , cable loss and amplifier gain

Note 2: Margin (dB) = Emission level (dBuV/m) – Limit (dBuV/m).

Modulation	HT20	Test Freq. (MHz)	5825
Polarization	Vertical		

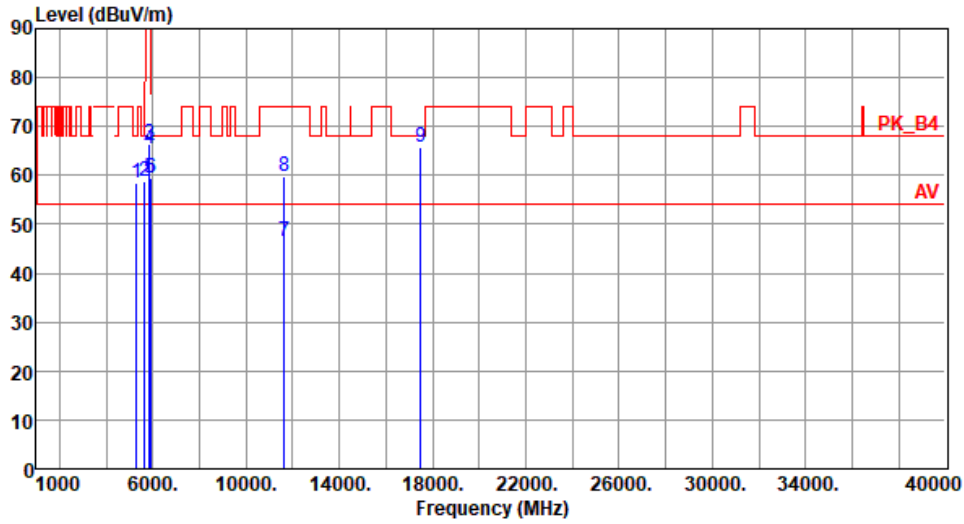

	Freq. MHz	Emission level dBuV/m	Limit dBuV/m	Margin dB	SA reading dBuV	Factor dB	Remark	ANT High cm	Turn Table deg
1	5280.00	58.42	68.20	-9.78	51.53	6.89	Peak	250	89
2	5650.00	58.65	68.20	-9.55	51.26	7.39	Peak	250	89
3	5850.00	66.34	122.20	-55.86	58.32	8.02	Peak	250	89
4	5855.00	65.48	110.80	-45.32	57.46	8.02	Peak	250	89
5	5875.00	59.28	105.20	-45.92	51.25	8.03	Peak	250	89
6	5925.00	59.29	68.20	-8.91	51.22	8.07	Peak	250	89
7	11650.00	46.63	54.00	-7.37	30.25	16.38	Average	100	30
8	11650.00	59.64	74.00	-14.36	43.26	16.38	Peak	100	30
9	17475.00	65.84	68.20	-2.36	46.10	19.74	Peak	210	316

Note 1: Emission Level (dBuV/m) = SA Reading (dBuV/m) + Factor* (dB)

*Factor includes antenna factor , cable loss and amplifier gain

Note 2: Margin (dB) = Emission level (dBuV/m) – Limit (dBuV/m).

3.5.19 Transmitter Radiated Unwanted Emissions (Above 1GHz) for HT40

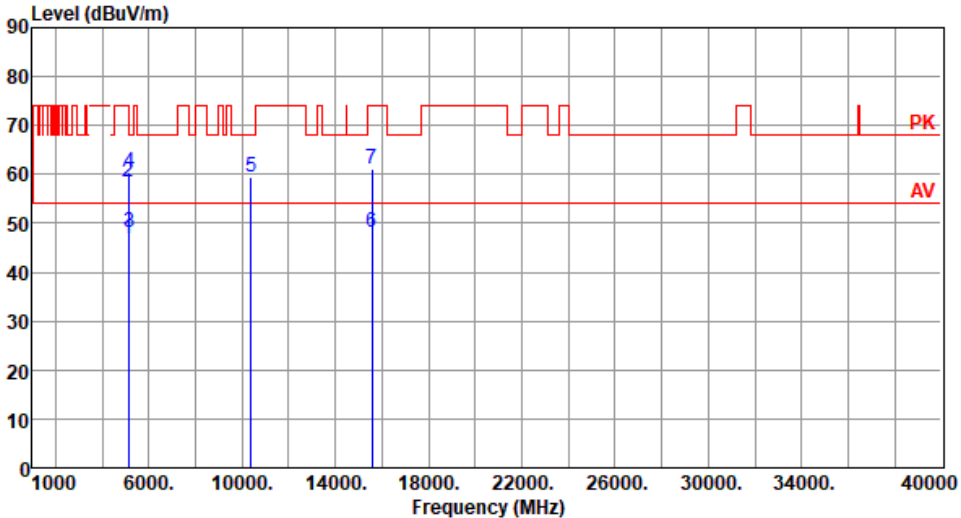
Modulation	HT40	Test Freq. (MHz)	5190																																																																																									
Polarization	Horizontal																																																																																											
																																																																																												
	<table border="1"> <thead> <tr> <th>Freq.</th> <th>Emission level</th> <th>Limit</th> <th>Margin</th> <th>SA reading</th> <th>Factor</th> <th>Remark</th> <th>ANT High</th> <th>Turn Table</th> </tr> <tr> <th>MHz</th> <th>dBuV/m</th> <th>dBuV/m</th> <th>dB</th> <th>dBuV</th> <th>dB</th> <th></th> <th>cm</th> <th>deg</th> </tr> </thead> <tbody> <tr> <td>1</td> <td>5120.00</td> <td>46.93</td> <td>54.00</td> <td>-7.07</td> <td>39.62</td> <td>7.31</td> <td>Average</td> <td>292</td> <td>155</td> </tr> <tr> <td>2</td> <td>5120.00</td> <td>58.62</td> <td>74.00</td> <td>-15.38</td> <td>51.31</td> <td>7.31</td> <td>Peak</td> <td>292</td> <td>155</td> </tr> <tr> <td>3</td> <td>5150.00</td> <td>48.00</td> <td>54.00</td> <td>-6.00</td> <td>40.68</td> <td>7.32</td> <td>Average</td> <td>292</td> <td>155</td> </tr> <tr> <td>4</td> <td>5150.00</td> <td>60.33</td> <td>74.00</td> <td>-13.67</td> <td>53.01</td> <td>7.32</td> <td>Peak</td> <td>292</td> <td>155</td> </tr> <tr> <td>5</td> <td>10380.00</td> <td>59.42</td> <td>68.20</td> <td>-8.78</td> <td>43.24</td> <td>16.18</td> <td>Peak</td> <td>100</td> <td>291</td> </tr> <tr> <td>6</td> <td>15570.00</td> <td>48.06</td> <td>54.00</td> <td>-5.94</td> <td>30.74</td> <td>17.32</td> <td>Average</td> <td>189</td> <td>26</td> </tr> <tr> <td>7</td> <td>15570.00</td> <td>61.02</td> <td>74.00</td> <td>-12.98</td> <td>43.70</td> <td>17.32</td> <td>Peak</td> <td>189</td> <td>26</td> </tr> </tbody> </table>	Freq.	Emission level	Limit	Margin	SA reading	Factor	Remark	ANT High	Turn Table	MHz	dBuV/m	dBuV/m	dB	dBuV	dB		cm	deg	1	5120.00	46.93	54.00	-7.07	39.62	7.31	Average	292	155	2	5120.00	58.62	74.00	-15.38	51.31	7.31	Peak	292	155	3	5150.00	48.00	54.00	-6.00	40.68	7.32	Average	292	155	4	5150.00	60.33	74.00	-13.67	53.01	7.32	Peak	292	155	5	10380.00	59.42	68.20	-8.78	43.24	16.18	Peak	100	291	6	15570.00	48.06	54.00	-5.94	30.74	17.32	Average	189	26	7	15570.00	61.02	74.00	-12.98	43.70	17.32	Peak	189	26			
Freq.	Emission level	Limit	Margin	SA reading	Factor	Remark	ANT High	Turn Table																																																																																				
MHz	dBuV/m	dBuV/m	dB	dBuV	dB		cm	deg																																																																																				
1	5120.00	46.93	54.00	-7.07	39.62	7.31	Average	292	155																																																																																			
2	5120.00	58.62	74.00	-15.38	51.31	7.31	Peak	292	155																																																																																			
3	5150.00	48.00	54.00	-6.00	40.68	7.32	Average	292	155																																																																																			
4	5150.00	60.33	74.00	-13.67	53.01	7.32	Peak	292	155																																																																																			
5	10380.00	59.42	68.20	-8.78	43.24	16.18	Peak	100	291																																																																																			
6	15570.00	48.06	54.00	-5.94	30.74	17.32	Average	189	26																																																																																			
7	15570.00	61.02	74.00	-12.98	43.70	17.32	Peak	189	26																																																																																			
<p>Note 1: Emission Level (dBuV/m) = SA Reading (dBuV/m) + Factor* (dB) *Factor includes antenna factor , cable loss and amplifier gain Note 2: Margin (dB) = Emission level (dBuV/m) – Limit (dBuV/m).</p>																																																																																												

Modulation	HT40	Test Freq. (MHz)	5190
Polarization	Vertical		

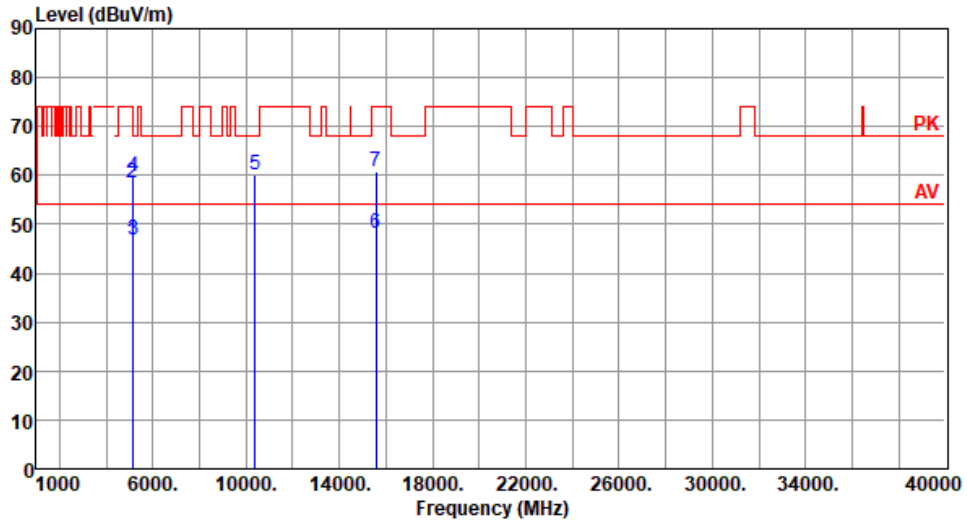

	Freq. MHz	Emission level dBuV/m	Limit dBuV/m	Margin dB	SA reading dBuV	Factor dB	Remark	ANT High cm	Turn Table deg
1	5120.00	46.56	54.00	-7.44	39.25	7.31	Average	206	213
2	5120.00	58.46	74.00	-15.54	51.15	7.31	Peak	206	213
3	5150.00	46.88	54.00	-7.12	39.56	7.32	Average	206	213
4	5150.00	59.88	74.00	-14.12	52.56	7.32	Peak	206	213
5	10380.00	60.11	68.20	-8.09	43.93	16.18	Peak	100	58
6	15570.00	48.02	54.00	-5.98	30.70	17.32	Average	199	321
7	15570.00	60.74	74.00	-13.26	43.42	17.32	Peak	199	321

Note 1: Emission Level (dBuV/m) = SA Reading (dBuV/m) + Factor* (dB)

*Factor includes antenna factor , cable loss and amplifier gain

Note 2: Margin (dB) = Emission level (dBuV/m) – Limit (dBuV/m).

Modulation	HT40	Test Freq. (MHz)	5230
Polarization	Horizontal		

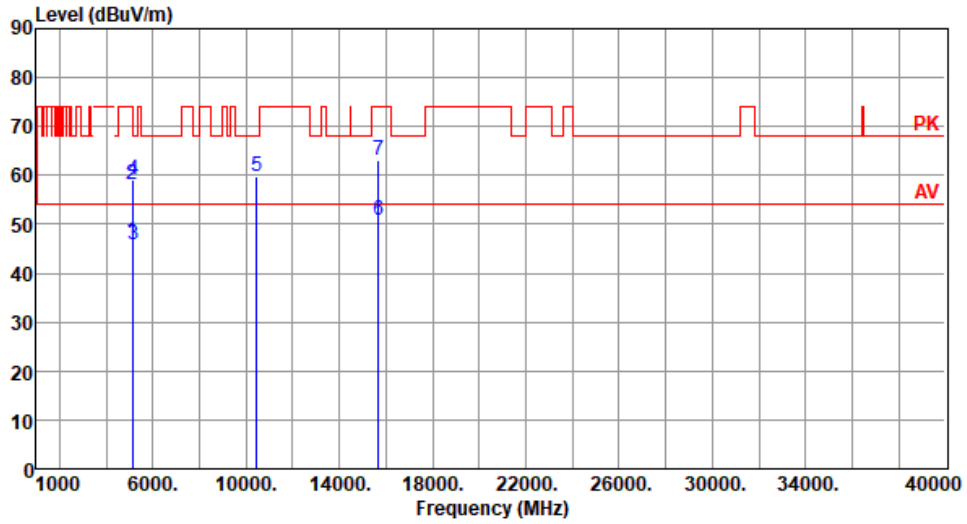

	Freq. MHz	Emission level dBuV/m	Limit dBuV/m	Margin dB	SA reading dBuV	Factor dB	Remark	ANT High cm	Turn Table deg
1	5120.00	46.36	54.00	-7.64	39.05	7.31	Average	289	156
2	5120.00	58.23	74.00	-15.77	50.92	7.31	Peak	289	156
3	5150.00	45.72	54.00	-8.28	38.40	7.32	Average	289	156
4	5150.00	59.16	74.00	-14.84	51.84	7.32	Peak	289	156
5	10460.00	59.94	68.20	-8.26	43.57	16.37	Peak	100	50
6	15690.00	50.84	54.00	-3.16	34.16	16.68	Average	185	15
7	15690.00	63.03	74.00	-10.97	46.35	16.68	Peak	185	15

Note 1: Emission Level (dBuV/m) = SA Reading (dBuV/m) + Factor* (dB)

*Factor includes antenna factor , cable loss and amplifier gain

Note 2: Margin (dB) = Emission level (dBuV/m) – Limit (dBuV/m).

Modulation	HT40	Test Freq. (MHz)	5230
Polarization	Vertical		

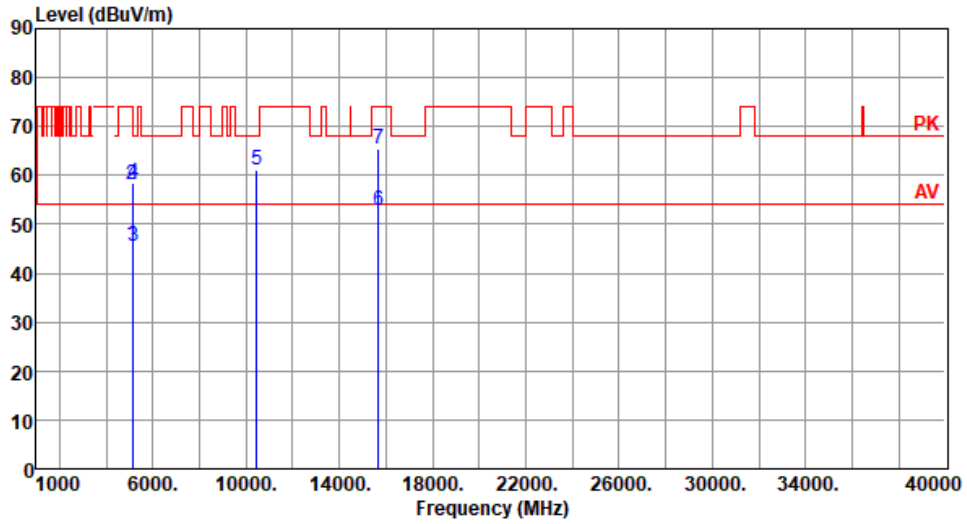

	Freq. MHz	Emission level dBuV/m	Limit dBuV/m	Margin dB	SA reading dBuV	Factor dB	Remark	ANT High cm	Turn Table deg
1	5120.00	45.96	54.00	-8.04	38.65	7.31	Average	244	103
2	5120.00	58.19	74.00	-15.81	50.88	7.31	Peak	244	103
3	5150.00	45.58	54.00	-8.42	38.26	7.32	Average	244	103
4	5150.00	58.58	74.00	-15.42	51.26	7.32	Peak	244	103
5	10460.00	61.07	68.20	-7.13	44.70	16.37	Peak	100	78
6	15690.00	52.89	54.00	-1.11	36.21	16.68	Average	234	312
7	15690.00	65.59	74.00	-8.41	48.91	16.68	Peak	234	312

Note 1: Emission Level (dBuV/m) = SA Reading (dBuV/m) + Factor* (dB)

*Factor includes antenna factor , cable loss and amplifier gain

Note 2: Margin (dB) = Emission level (dBuV/m) – Limit (dBuV/m).

Modulation	HT40	Test Freq. (MHz)	5270
Polarization	Horizontal		

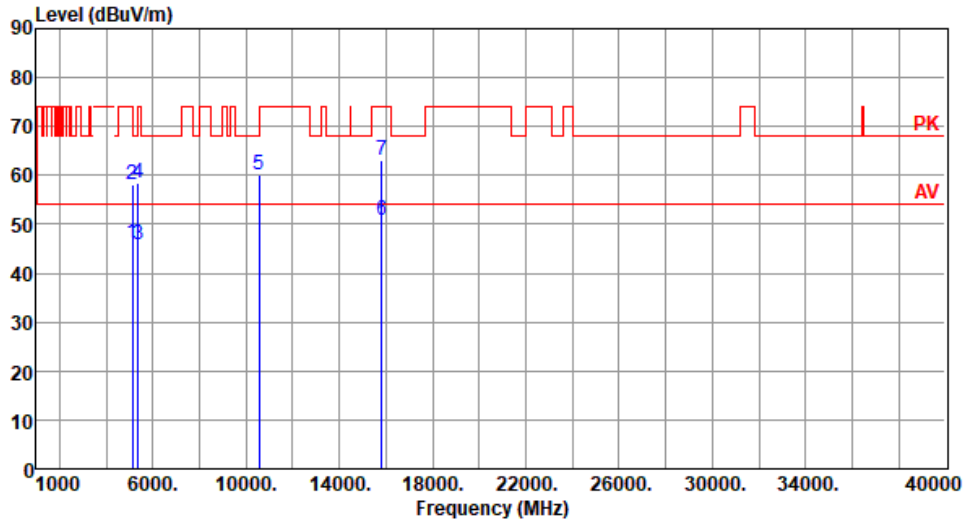

	Freq. MHz	Emission level dBuV/m	Limit dBuV/m	Margin dB	SA reading dBuV	Factor dB	Remark	ANT High cm	Turn Table deg
1	5120.00	46.32	54.00	-7.68	39.01	7.31	Average	288	150
2	5120.00	57.96	74.00	-16.04	50.65	7.31	Peak	288	150
3	5350.00	45.87	54.00	-8.13	39.02	6.85	Average	288	150
4	5350.00	58.29	74.00	-15.71	51.44	6.85	Peak	288	150
5	10540.00	59.97	68.20	-8.23	43.56	16.41	Peak	100	20
6	15810.00	50.81	54.00	-3.19	34.25	16.56	Average	213	323
7	15810.00	63.12	74.00	-10.88	46.56	16.56	Peak	213	323

Note 1: Emission Level (dBuV/m) = SA Reading (dBuV/m) + Factor* (dB)

*Factor includes antenna factor , cable loss and amplifier gain

Note 2: Margin (dB) = Emission level (dBuV/m) – Limit (dBuV/m).

Modulation	HT40	Test Freq. (MHz)	5270
Polarization	Vertical		

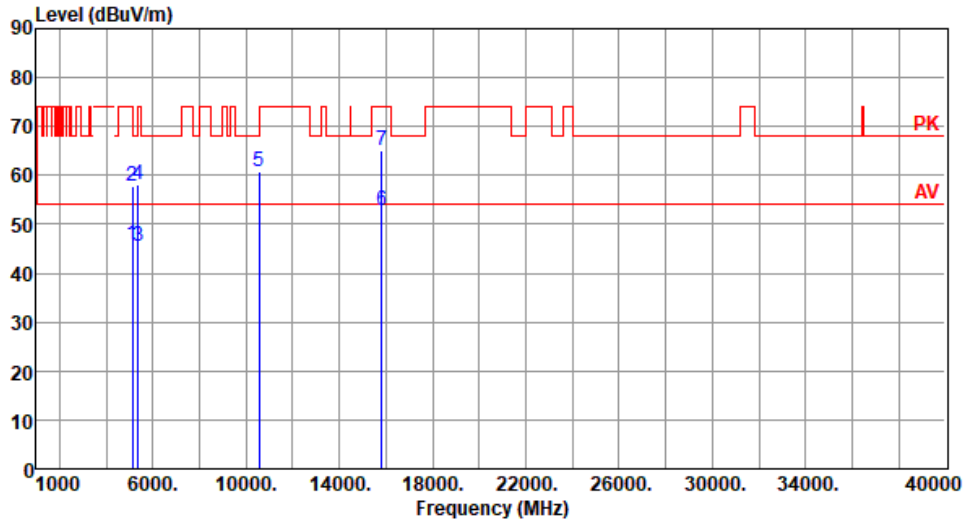

	Freq. MHz	Emission level dBuV/m	Limit dBuV/m	Margin dB	SA reading dBuV	Factor dB	Remark	ANT High cm	Turn Table deg
1	5120.00	46.00	54.00	-8.00	38.69	7.31	Average	246	95
2	5120.00	57.73	74.00	-16.27	50.42	7.31	Peak	246	95
3	5350.00	45.50	54.00	-8.50	38.65	6.85	Average	246	95
4	5350.00	57.96	74.00	-16.04	51.11	6.85	Peak	246	95
5	10540.00	60.77	68.20	-7.43	44.36	16.41	Peak	100	58
6	15810.00	52.89	54.00	-1.11	36.33	16.56	Average	238	314
7	15810.00	65.19	74.00	-8.81	48.63	16.56	Peak	238	314

Note 1: Emission Level (dBuV/m) = SA Reading (dBuV/m) + Factor* (dB)

*Factor includes antenna factor , cable loss and amplifier gain

Note 2: Margin (dB) = Emission level (dBuV/m) – Limit (dBuV/m).

Modulation	HT40	Test Freq. (MHz)	5310
Polarization	Horizontal		

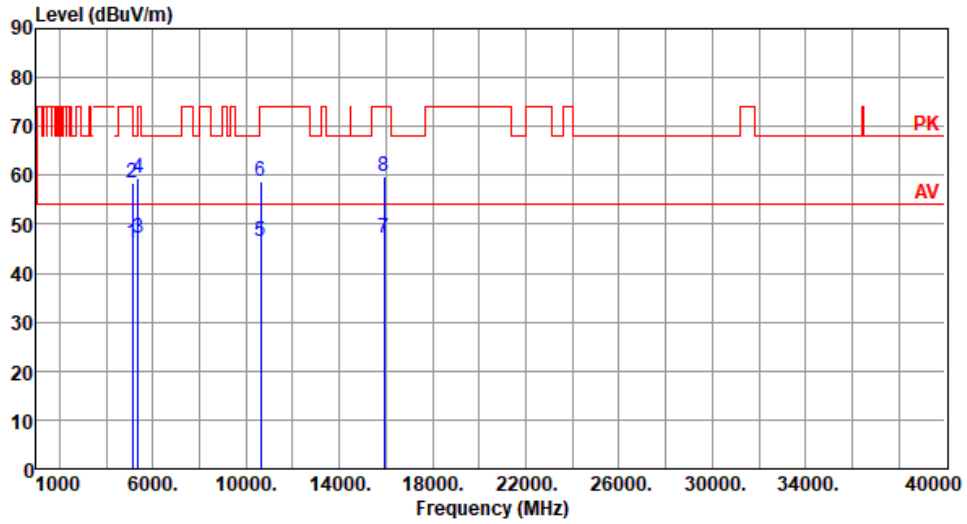

	Freq. MHz	Emission level dBuV/m	Limit dBuV/m	Margin dB	SA reading dBuV	Factor dB	Remark	ANT High cm	Turn Table deg
1	5120.00	46.26	54.00	-7.74	38.95	7.31	Average	273	152
2	5120.00	58.60	74.00	-15.40	51.29	7.31	Peak	273	152
3	5350.00	47.09	54.00	-6.91	40.24	6.85	Average	273	152
4	5350.00	59.36	74.00	-14.64	52.51	6.85	Peak	273	152
5	10620.00	46.62	54.00	-7.38	30.25	16.37	Average	100	40
6	10620.00	58.93	74.00	-15.07	42.56	16.37	Peak	100	40
7	15930.00	47.18	54.00	-6.82	30.57	16.61	Average	100	20
8	15930.00	59.86	74.00	-14.14	43.25	16.61	Peak	100	20

Note 1: Emission Level (dBuV/m) = SA Reading (dBuV/m) + Factor* (dB)

*Factor includes antenna factor , cable loss and amplifier gain

Note 2: Margin (dB) = Emission level (dBuV/m) – Limit (dBuV/m).

Modulation	HT40	Test Freq. (MHz)	5310
Polarization	Vertical		

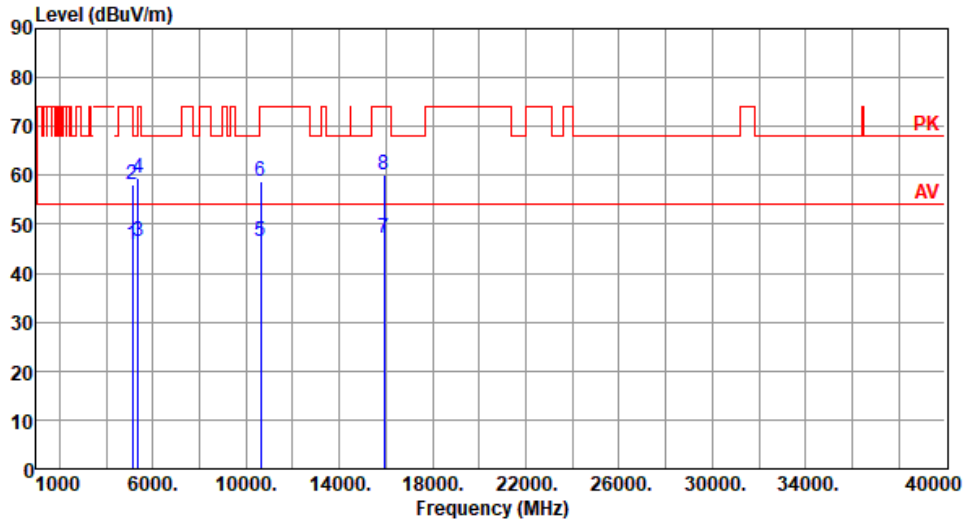

	Freq. MHz	Emission level dBuV/m	Limit dBuV/m	Margin dB	SA reading dBuV	Factor dB	Remark	ANT High cm	Turn Table deg
1	5120.00	45.85	54.00	-8.15	38.54	7.31	Average	246	92
2	5120.00	58.05	74.00	-15.95	50.74	7.31	Peak	246	92
3	5350.00	46.53	54.00	-7.47	39.68	6.85	Average	246	92
4	5350.00	59.31	74.00	-14.69	52.46	6.85	Peak	246	92
5	10620.00	46.52	54.00	-7.48	30.15	16.37	Average	100	30
6	10620.00	58.82	74.00	-15.18	42.45	16.37	Peak	100	30
7	15930.00	47.26	54.00	-6.74	30.65	16.61	Average	100	50
8	15930.00	59.97	74.00	-14.03	43.36	16.61	Peak	100	50

Note 1: Emission Level (dBuV/m) = SA Reading (dBuV/m) + Factor* (dB)

*Factor includes antenna factor , cable loss and amplifier gain

Note 2: Margin (dB) = Emission level (dBuV/m) – Limit (dBuV/m).

Modulation	HT40	Test Freq. (MHz)	5510
Polarization	Horizontal		

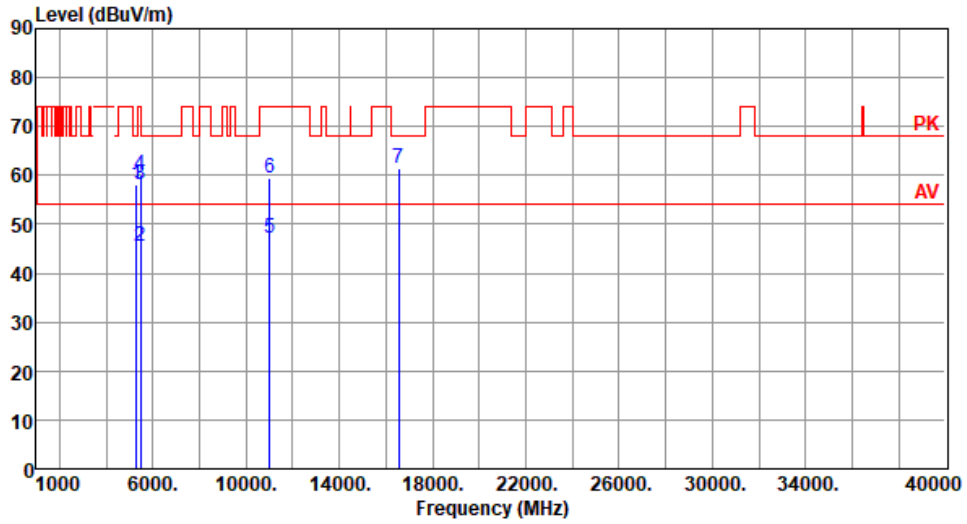

	Freq. MHz	Emission level dBuV/m	Limit dBuV/m	Margin dB	SA reading dBuV	Factor dB	Remark	ANT High cm	Turn Table deg
1	5280.00	58.25	68.20	-9.95	51.36	6.89	Peak	276	150
2	5460.00	45.39	54.00	-8.61	38.14	7.25	Average	276	150
3	5460.00	58.17	74.00	-15.83	50.92	7.25	Peak	276	150
4	5470.00	60.22	68.20	-7.98	52.94	7.28	Peak	276	150
5	11020.00	47.07	54.00	-6.93	30.26	16.81	Average	100	40
6	11020.00	59.34	74.00	-14.66	42.53	16.81	Peak	100	40
7	16530.00	61.39	68.20	-6.81	43.56	17.83	Peak	100	90

Note 1: Emission Level (dBuV/m) = SA Reading (dBuV/m) + Factor* (dB)

*Factor includes antenna factor , cable loss and amplifier gain

Note 2: Margin (dB) = Emission level (dBuV/m) – Limit (dBuV/m).

Modulation	HT40	Test Freq. (MHz)	5510
Polarization	Vertical		

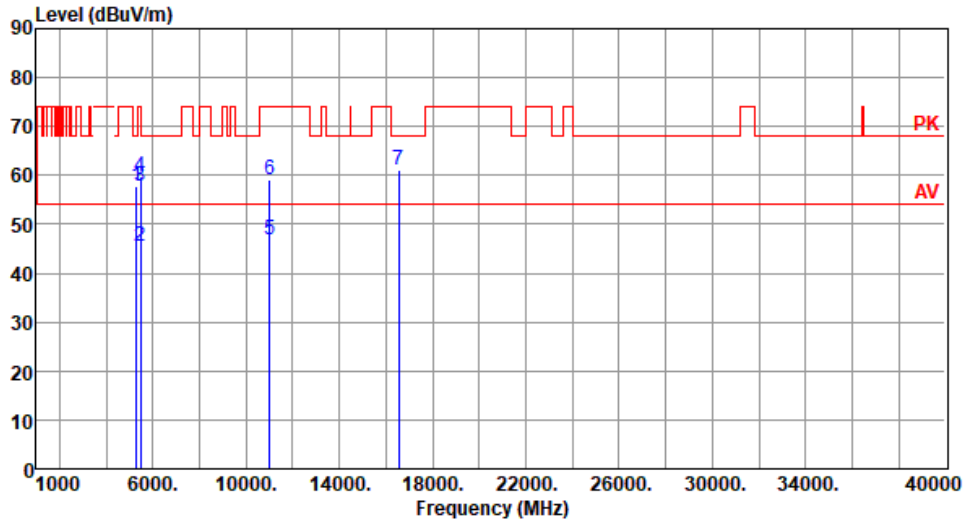

	Freq. MHz	Emission level dBuV/m	Limit dBuV/m	Margin dB	SA reading dBuV	Factor dB	Remark	ANT High cm	Turn Table deg
1	5280.00	57.91	68.20	-10.29	51.02	6.89	Peak	276	117
2	5460.00	45.34	54.00	-8.66	38.09	7.25	Average	276	117
3	5460.00	57.92	74.00	-16.08	50.67	7.25	Peak	276	117
4	5470.00	59.73	68.20	-8.47	52.45	7.28	Peak	276	117
5	11020.00	46.94	54.00	-7.06	30.13	16.81	Average	100	50
6	11020.00	59.27	74.00	-14.73	42.46	16.81	Peak	100	50
7	16530.00	61.25	68.20	-6.95	43.42	17.83	Peak	100	70

Note 1: Emission Level (dBuV/m) = SA Reading (dBuV/m) + Factor* (dB)

*Factor includes antenna factor , cable loss and amplifier gain

Note 2: Margin (dB) = Emission level (dBuV/m) – Limit (dBuV/m).

Modulation	HT40	Test Freq. (MHz)	5590
Polarization	Horizontal		

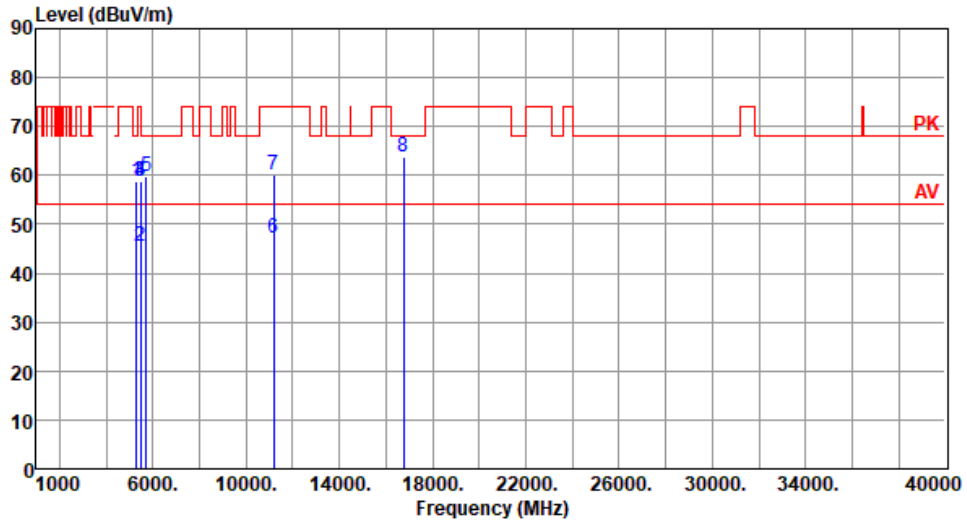

	Freq. MHz	Emission level dBuV/m	Limit dBuV/m	Margin dB	SA reading dBuV	Factor dB	Remark	ANT High cm	Turn Table deg
1	5280.00	58.93	68.20	-9.27	52.04	6.89	Peak	264	154
2	5460.00	45.50	54.00	-8.50	38.25	7.25	Average	264	154
3	5460.00	58.77	74.00	-15.23	51.52	7.25	Peak	264	154
4	5470.00	58.94	68.20	-9.26	51.66	7.28	Peak	264	154
5	5725.00	59.78	68.20	-8.42	52.12	7.66	Peak	264	154
6	11180.00	47.02	54.00	-6.98	30.46	16.56	Average	100	40
7	11180.00	60.09	74.00	-13.91	43.53	16.56	Peak	100	40
8	16770.00	63.85	68.20	-4.35	45.62	18.23	Peak	215	326

Note 1: Emission Level (dBuV/m) = SA Reading (dBuV/m) + Factor* (dB)

*Factor includes antenna factor , cable loss and amplifier gain

Note 2: Margin (dB) = Emission level (dBuV/m) – Limit (dBuV/m).

Modulation	HT40	Test Freq. (MHz)	5590
Polarization	Vertical		

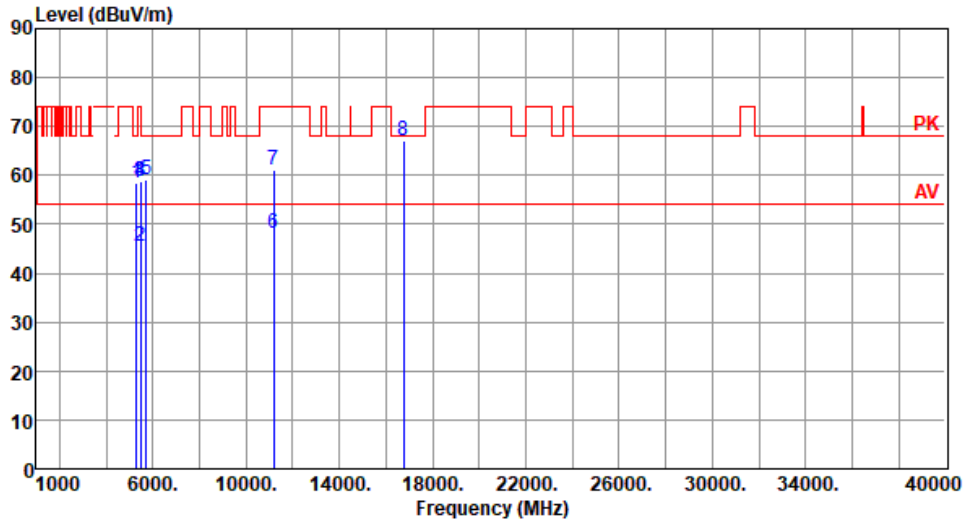

	Freq. MHz	Emission level dBuV/m	Limit dBuV/m	Margin dB	SA reading dBuV	Factor dB	Remark	ANT High cm	Turn Table deg
1	5280.00	58.44	68.20	-9.76	51.55	6.89	Peak	277	116
2	5460.00	45.39	54.00	-8.61	38.14	7.25	Average	277	116
3	5460.00	58.71	74.00	-15.29	51.46	7.25	Peak	277	116
4	5470.00	58.74	68.20	-9.46	51.46	7.28	Peak	277	116
5	5725.00	59.21	68.20	-8.99	51.55	7.66	Peak	277	116
6	11180.00	48.11	54.00	-5.89	31.55	16.56	Average	100	25
7	11180.00	61.10	74.00	-12.90	44.54	16.56	Peak	100	25
8	16770.00	67.12	68.20	-1.08	48.89	18.23	Peak	226	325

Note 1: Emission Level (dBuV/m) = SA Reading (dBuV/m) + Factor* (dB)

*Factor includes antenna factor , cable loss and amplifier gain

Note 2: Margin (dB) = Emission level (dBuV/m) – Limit (dBuV/m).

Modulation	HT40	Test Freq. (MHz)	5670
Polarization	Horizontal		

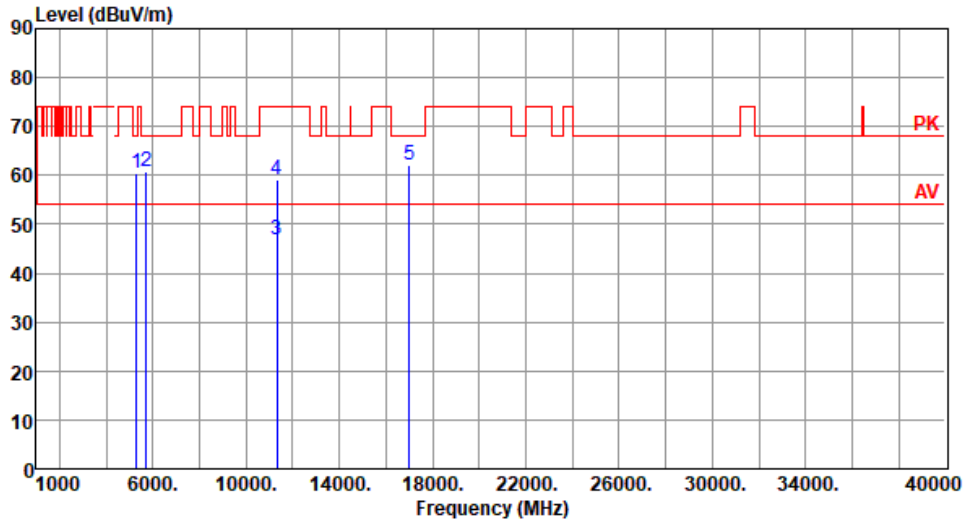

	Freq. MHz	Emission level dBuV/m	Limit dBuV/m	Margin dB	SA reading dBuV	Factor dB	Remark	ANT High cm	Turn Table deg
1	5280.00	60.41	68.20	-7.79	53.52	6.89	Peak	263	151
2	5725.00	60.91	68.20	-7.29	53.25	7.66	Peak	263	151
3	11340.00	46.82	54.00	-7.18	30.24	16.58	Average	100	50
4	11340.00	59.12	74.00	-14.88	42.54	16.58	Peak	100	50
5	17010.00	62.11	68.20	-6.09	43.45	18.66	Peak	100	327

Note 1: Emission Level (dBuV/m) = SA Reading (dBuV/m) + Factor* (dB)

*Factor includes antenna factor , cable loss and amplifier gain

Note 2: Margin (dB) = Emission level (dBuV/m) – Limit (dBuV/m).

Modulation	HT40	Test Freq. (MHz)	5670
Polarization	Vertical		

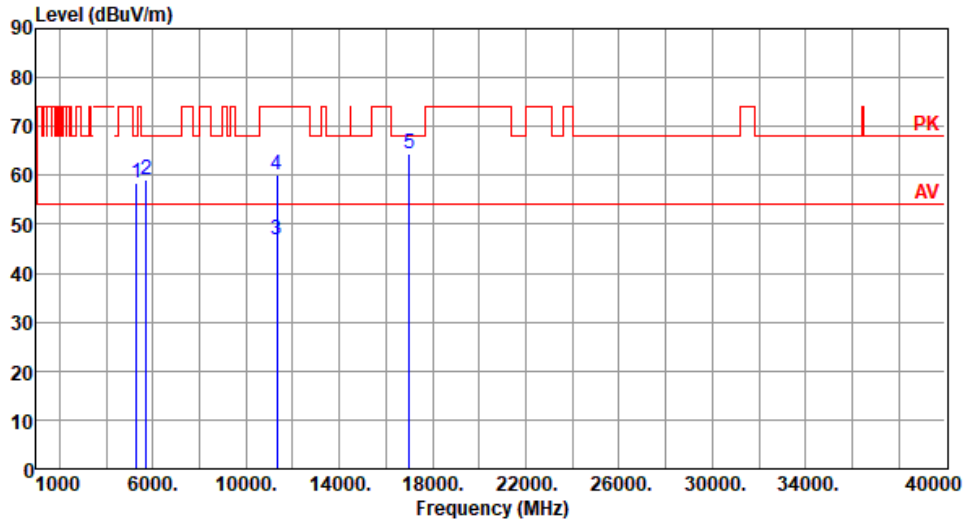

	Freq. MHz	Emission level dBuV/m	Limit dBuV/m	Margin dB	SA reading dBuV	Factor dB	Remark	ANT High cm	Turn Table deg
1	5280.00	58.45	68.20	-9.75	51.56	6.89	Peak	277	114
2	5725.00	59.21	68.20	-8.99	51.55	7.66	Peak	277	114
3	11340.00	46.71	54.00	-7.29	30.13	16.58	Average	100	40
4	11340.00	60.12	74.00	-13.88	43.54	16.58	Peak	100	40
5	17010.00	64.35	68.20	-3.85	45.69	18.66	Peak	229	323

Note 1: Emission Level (dBuV/m) = SA Reading (dBuV/m) + Factor* (dB)

*Factor includes antenna factor , cable loss and amplifier gain

Note 2: Margin (dB) = Emission level (dBuV/m) – Limit (dBuV/m).

Modulation	HT40	Test Freq. (MHz)	5710
Polarization	Horizontal		

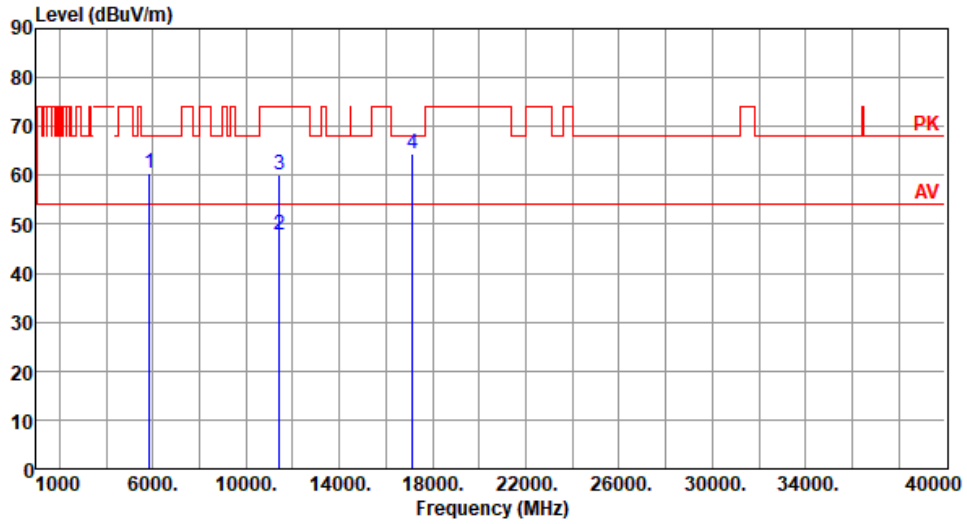

	Freq. MHz	Emission level dBuV/m	Limit dBuV/m	Margin dB	SA reading dBuV	Factor dB	Remark	ANT High cm	Turn Table deg
1	5850.00	60.59	68.20	-7.61	52.57	8.02	Peak	275	174
2	11420.00	47.96	54.00	-6.04	31.23	16.73	Average	100	65
3	11420.00	60.14	74.00	-13.86	43.41	16.73	Peak	100	65
4	17130.00	64.52	68.20	-3.68	46.22	18.30	Peak	205	339

Note 1: Emission Level (dBuV/m) = SA Reading (dBuV/m) + Factor* (dB)

*Factor includes antenna factor , cable loss and amplifier gain

Note 2: Margin (dB) = Emission level (dBuV/m) – Limit (dBuV/m).

Modulation	HT40	Test Freq. (MHz)	5710
Polarization	Vertical		

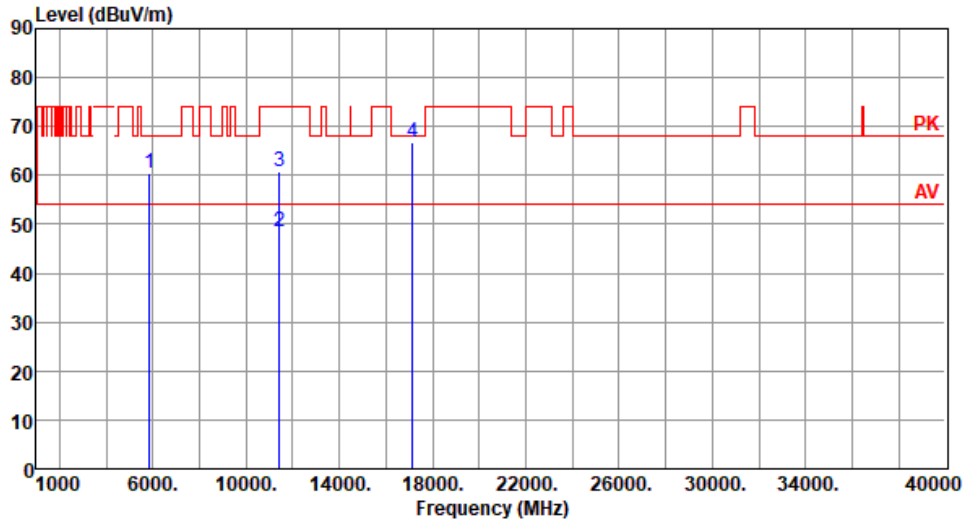

	Freq. MHz	Emission level dBuV/m	Limit dBuV/m	Margin dB	SA reading dBuV	Factor dB	Remark	ANT High cm	Turn Table deg
1	5850.00	60.39	68.20	-7.81	52.37	8.02	Peak	255	89
2	11420.00	48.56	54.00	-5.44	31.83	16.73	Average	100	58
3	11420.00	60.82	74.00	-13.18	44.09	16.73	Peak	100	58
4	17130.00	66.68	68.20	-1.52	48.38	18.30	Peak	219	325

Note 1: Emission Level (dBuV/m) = SA Reading (dBuV/m) + Factor* (dB)

*Factor includes antenna factor , cable loss and amplifier gain

Note 2: Margin (dB) = Emission level (dBuV/m) – Limit (dBuV/m).

Modulation	HT40	Test Freq. (MHz)	5755
Polarization	Horizontal		

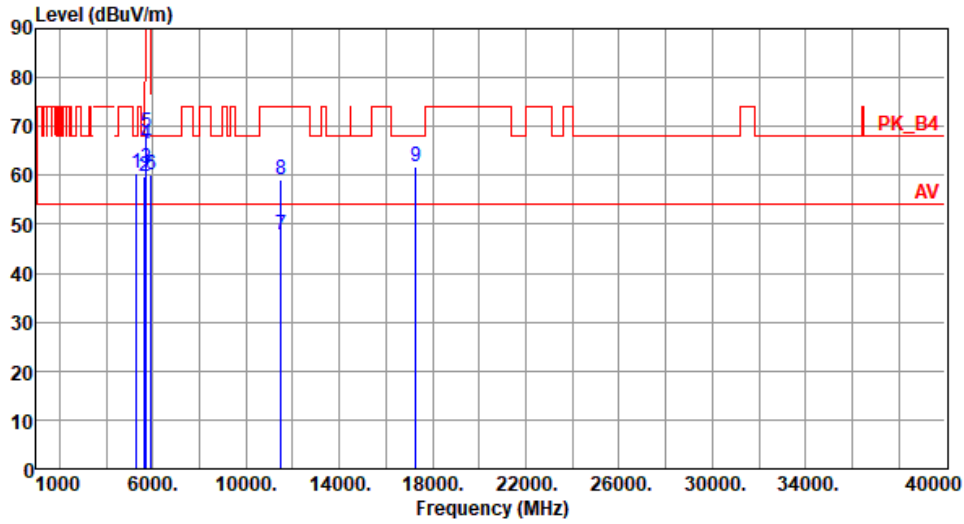

	Freq. MHz	Emission level dBuV/m	Limit dBuV/m	Margin dB	SA reading dBuV	Factor dB	Remark	ANT High cm	Turn Table deg
1	5280.00	60.58	68.20	-7.62	53.69	6.89	Peak	276	174
2	5650.00	59.67	68.20	-8.53	52.28	7.39	Peak	276	174
3	5700.00	61.56	105.20	-43.64	54.06	7.50	Peak	276	174
4	5720.00	66.53	110.80	-44.27	58.91	7.62	Peak	276	174
5	5725.00	68.86	122.20	-53.34	61.20	7.66	Peak	276	174
6	5925.00	60.14	68.20	-8.06	52.07	8.07	Peak	276	174
7	11510.00	47.77	54.00	-6.23	31.02	16.75	Average	100	30
8	11510.00	59.21	74.00	-14.79	42.46	16.75	Peak	100	30
9	17265.00	61.92	68.20	-6.28	43.11	18.81	Peak	100	333

Note 1: Emission Level (dBuV/m) = SA Reading (dBuV/m) + Factor* (dB)

*Factor includes antenna factor , cable loss and amplifier gain

Note 2: Margin (dB) = Emission level (dBuV/m) – Limit (dBuV/m).

Modulation	HT40	Test Freq. (MHz)	5755
Polarization	Vertical		

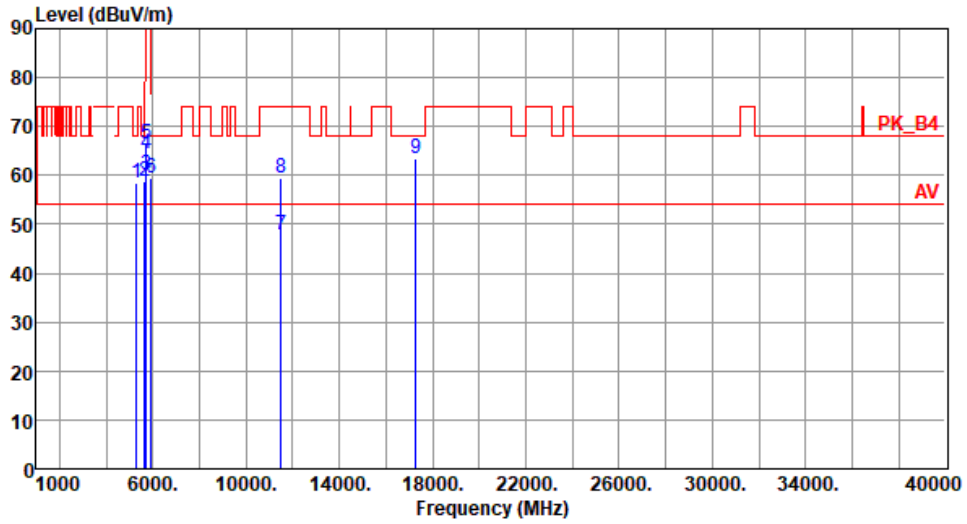

	Freq. MHz	Emission level dBuV/m	Limit dBuV/m	Margin dB	SA reading dBuV	Factor dB	Remark	ANT High cm	Turn Table deg
1	5280.00	58.45	68.20	-9.75	51.56	6.89	Peak	254	87
2	5650.00	58.94	68.20	-9.26	51.55	7.39	Peak	254	87
3	5700.00	60.06	105.20	-45.14	52.56	7.50	Peak	254	87
4	5720.00	64.48	110.80	-46.32	56.86	7.62	Peak	254	87
5	5725.00	66.41	122.20	-55.79	58.75	7.66	Peak	254	87
6	5925.00	59.54	68.20	-8.66	51.47	8.07	Peak	254	87
7	11510.00	47.98	54.00	-6.02	31.23	16.75	Average	100	40
8	11510.00	59.34	74.00	-14.66	42.59	16.75	Peak	100	40
9	17265.00	63.36	68.20	-4.84	44.55	18.81	Peak	211	326

Note 1: Emission Level (dBuV/m) = SA Reading (dBuV/m) + Factor* (dB)

*Factor includes antenna factor , cable loss and amplifier gain

Note 2: Margin (dB) = Emission level (dBuV/m) – Limit (dBuV/m).

Modulation	HT40	Test Freq. (MHz)	5795
Polarization	Horizontal		

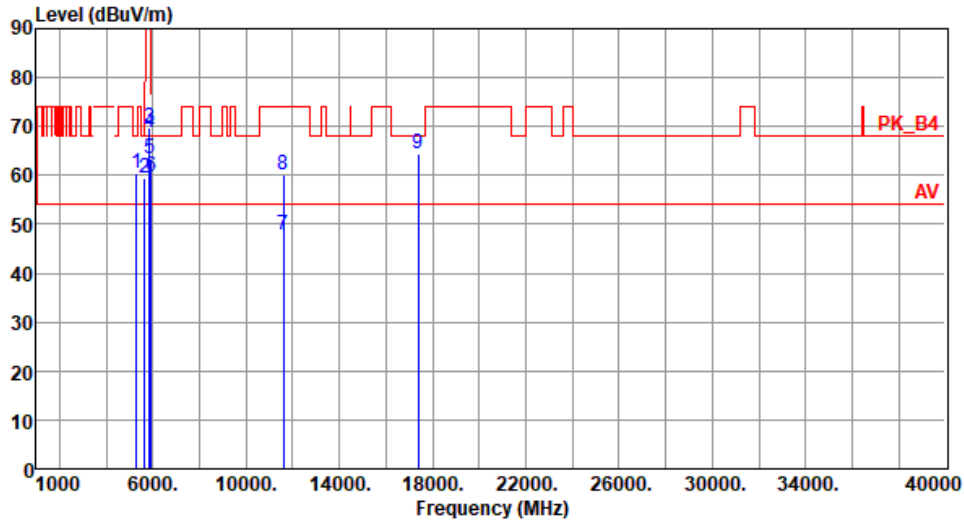

	Freq. MHz	Emission level dBuV/m	Limit dBuV/m	Margin dB	SA reading dBuV	Factor dB	Remark	ANT High cm	Turn Table deg
1	5280.00	60.30	68.20	-7.90	53.41	6.89	Peak	275	173
2	5650.00	59.55	68.20	-8.65	52.16	7.39	Peak	275	173
3	5850.00	69.90	122.20	-52.30	61.88	8.02	Peak	275	173
4	5855.00	68.81	110.80	-41.99	60.79	8.02	Peak	275	173
5	5875.00	63.53	105.20	-41.67	55.50	8.03	Peak	275	173
6	5925.00	59.77	68.20	-8.43	51.70	8.07	Peak	275	173
7	11590.00	47.82	54.00	-6.18	31.25	16.57	Average	100	60
8	11590.00	60.01	74.00	-13.99	43.44	16.57	Peak	100	60
9	17385.00	64.38	68.20	-3.82	45.03	19.35	Peak	205	336

Note 1: Emission Level (dBuV/m) = SA Reading (dBuV/m) + Factor* (dB)

*Factor includes antenna factor , cable loss and amplifier gain

Note 2: Margin (dB) = Emission level (dBuV/m) – Limit (dBuV/m).

Modulation	HT40	Test Freq. (MHz)	5795
Polarization	Vertical		

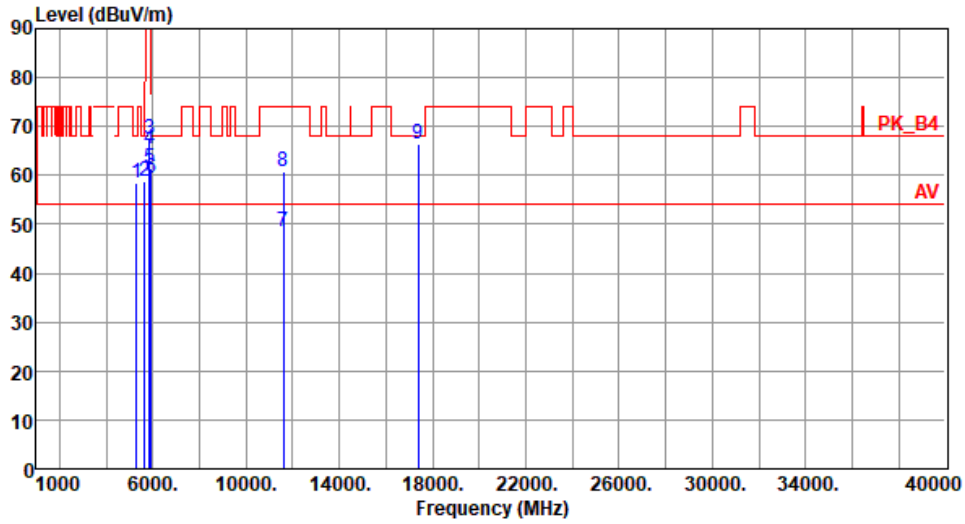

	Freq. MHz	Emission level dBuV/m	Limit dBuV/m	Margin dB	SA reading dBuV	Factor dB	Remark	ANT High cm	Turn Table deg
1	5280.00	58.45	68.20	-9.75	51.56	6.89	Peak	255	88
2	5650.00	58.84	68.20	-9.36	51.45	7.39	Peak	255	88
3	5850.00	67.27	122.20	-54.93	59.25	8.02	Peak	255	88
4	5855.00	65.48	110.80	-45.32	57.46	8.02	Peak	255	88
5	5875.00	61.48	105.20	-43.72	53.45	8.03	Peak	255	88
6	5925.00	59.53	68.20	-8.67	51.46	8.07	Peak	255	88
7	11590.00	48.42	54.00	-5.58	31.85	16.57	Average	100	55
8	11590.00	60.77	74.00	-13.23	44.20	16.57	Peak	100	55
9	17385.00	66.54	68.20	-1.66	47.19	19.35	Peak	219	327

Note 1: Emission Level (dBuV/m) = SA Reading (dBuV/m) + Factor* (dB)

*Factor includes antenna factor , cable loss and amplifier gain

Note 2: Margin (dB) = Emission level (dBuV/m) – Limit (dBuV/m).

3.6 Frequency Stability

3.6.1 Limit of Frequency Stability

Manufacturers of U-NII devices are responsible for ensuring frequency stability such that an emission is maintained within the band of operation under all conditions of normal operation as specified in the user's manual.

3.6.2 Test Procedures

1. The EUT is installed in an environment test chamber with external power source.
2. Set the chamber to operate at 20 centigrade and external power source to output at nominal voltage of EUT.
3. A sufficient stabilization period at each temperature is used prior to each frequency measurement.
4. When temperature is stabled, measure the frequency stability.
5. The test shall be performed under normal and extreme condition for temperature and voltage.

3.6.3 Test Setup

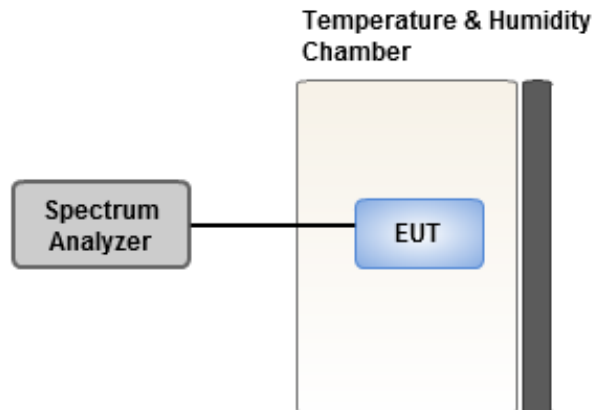

3.6.4 Test Result of Frequency Stability

Frequency: 5260 MHz	Frequency Drift (ppm)			
Temperature (°C)	0 minute	2 minutes	5 minutes	10 minutes
T20°CVmax	-8.25	-7.68	-8.10	-8.51
T20°CVmin	-7.58	-7.38	-7.56	-7.04
T85°CVnom	16.77	16.83	16.55	16.89
T80°CVnom	12.95	13.38	13.52	13.42
T70°CVnom	8.63	8.41	8.84	9.12
T60°CVnom	6.00	6.39	5.84	6.47
T50°CVnom	4.47	4.41	3.93	4.49
T40°CVnom	3.09	3.00	3.91	3.45
T30°CVnom	-7.66	-7.73	-7.29	-7.53
T20°CVnom	-8.43	-8.10	-8.31	-8.68
T10°CVnom	-9.60	-9.48	-9.25	-9.26
T0°CVnom	-11.47	-11.51	-11.11	-11.30
T-10°CVnom	-14.25	-14.40	-14.46	-13.46
T-20°CVnom	-11.78	-12.05	-11.66	-11.78
T-30°CVnom	-7.13	-6.95	-6.88	-6.68
T-40°CVnom	-4.24	-3.90	-3.99	-3.82
Vnom [Vac]: 3.3		Vmax [Vac]: 3.795		Vmin [Vac]: 2.805
Tnom [°C]: 20		Tmax [°C]: 85		Tmin [°C]: -40

Frequency: 5785 MHz	Frequency Drift (ppm)			
Temperature (°C)	0 minute	2 minutes	5 minutes	10 minutes
T20°CVmax	-7.80	-7.20	-7.66	-8.06
T20°CVmin	-7.58	-8.01	-7.51	-7.72
T85°CVnom	14.87	15.55	15.31	14.99
T80°CVnom	11.58	11.54	11.89	11.65
T70°CVnom	7.43	7.60	7.37	7.70
T60°CVnom	5.75	5.60	5.64	5.95
T50°CVnom	4.25	4.56	4.61	4.35
T40°CVnom	2.39	2.54	2.91	2.91
T30°CVnom	-7.26	-6.90	-7.21	-6.97
T20°CVnom	-7.77	-7.76	-7.99	-7.53
T10°CVnom	-8.85	-8.74	-8.74	-8.83
T0°CVnom	-11.01	-11.49	-11.35	-10.30
T-10°CVnom	-12.84	-12.58	-12.31	-12.71
T-20°CVnom	-10.89	-10.90	-10.97	-10.74
T-30°CVnom	-6.38	-6.22	-5.96	-6.61
T-40°CVnom	-4.10	-4.05	-4.13	-3.60
Vnom [Vac]: 3.3	Vmax [Vac]: 3.795		Vmin [Vac]: 2.805	
Tnom [°C]: 20	Tmax [°C]: 85		Tmin [°C]: -40	

4 Test laboratory information

Established in 2012, ICC provides foremost EMC & RF Testing and advisory consultation services by our skilled engineers and technicians. Our services employ a wide variety of advanced edge test equipment and one of the widest certification extents in the business.

International Certification Corp (EMC and Wireless Communication Laboratory), it is our definitive objective is to institute long term, trust-based associations with our clients. The expectation we set up with our clients is based on outstanding service, practical expertise and devotion to a certified value structure. Our passion is to grant our clients with best EMC / RF services by oriented knowledgeable and accommodating staff.

Our Test sites are located at Linkou District and Kwei Shan District. Location map can be found on our website <http://www.icertifi.com.tw>.

Linkou

Tel: 886-2-2601-1640

No. 30-2, Ding Fwu Tsuen, Lin
Kou District, New Taipei City,
Taiwan, R.O.C.

Kwei Shan

Tel: 886-3-271-8666

No. 3-1, Lane 6, Wen San 3rd St.,
Kwei Shan District, Tao Yuan City
333, Taiwan, R.O.C.

Kwei Shan Site II

Tel: 886-3-271-8640

No. 14-1, Lane 19, Wen San 3rd
St., Kwei Shan District, Tao Yuan
City 333, Taiwan, R.O.C.

If you have any suggestion, please feel free to contact us as below information.

Tel: 886-3-271-8666

Fax: 886-3-318-0155

Email: ICC_Service@icertifi.com.tw

==END==