

FCC C2PC Test Report

FCC ID : SQG-WB45NBT
Equipment : 45 Series WB module with Bluetooth
Model No. : WB45NBT
Brand Name : Laird Technologies
Applicant : Laird Technologies
Address : 11160 Thompson Ave. / Lenexa, Kansas /
66219 / USA
Standard : 47 CFR FCC Part 15.407
Received Date : Jul. 29, 2015
Tested Date : Aug. 12 ~ Aug. 17, 2015

We, International Certification Corp., would like to declare that the tested sample has been evaluated and in compliance with the requirement of the above standards. The test results contained in this report refer exclusively to the product. It may be duplicated completely for legal use with the approval of the applicant. It shall not be reproduced except in full without the written approval of our laboratory.

Approved & Reviewed by:



Gary Chang / Manager



Table of Contents

1	GENERAL DESCRIPTION	5
1.1	Information.....	5
1.2	Local Support Equipment List	8
1.3	Test Setup Chart	8
1.4	The Equipment List	9
1.5	Testing Applied Standards	10
1.6	Measurement Uncertainty	10
2	TEST CONFIGURATION	11
2.1	Testing Condition	11
2.2	The Worst Test Modes and Channel Details	11
3	TRANSMITTER TEST RESULTS.....	12
3.1	Conducted Emissions.....	12
3.2	Transmitter Radiated and Band Edge Emissions	15
4	TEST LABORATORY INFORMATION	38

Release Record

Report No.	Version	Description	Issued Date
FR350301-01AN	Rev. 01	Initial issue	Sep. 15, 2015

Summary of Test Results

FCC Rules	Test Items	Measured	Result
15.207	AC Power Line Conducted Emissions	[dBuV]: 0.153MHz 50.09 (Margin -15.73dB) - QP	Pass
15.407(b) 15.209	Radiated Emissions	[dBuV/m at 3m]: 5725.00MHz 52.98 (Margin -1.02dB) - AV	Pass

1 General Description

1.1 Information

This report is prepared for FCC class II permissive change.

This report is issued as a supplementary report to original ICC report no. FR350301AN. The modification is concerned with following:

- ✧ Complying with New U-NII rule requirement.
- ✧ Additional Dipole antennas.
- ✧ Replacing carrier board with different components.

For original antennas

Only radiated emission below 1GHz tests had been tested and presented in following section

For additional antennas

Only conducted emission and radiated emission tests for 5470-5725MHz band had been tested and presented in following section since antenna gain in 5470~5725MHz band is higher than original antenna.

1.1.1 Specification of the Equipment under Test (EUT)

RF General Information					
Frequency Range (MHz)	IEEE Std. 802.11	Ch. Freq. (MHz)	Channel Number	Transmit Chains (N_{TX})	Data Rate / MCS
5150-5250 5250-5350 5470-5725	a	5180-5240 5260-5320 5500-5700	36-48 [4] 52-64 [4] 100-140 [8]	1	6-54 Mbps
5150-5250 5250-5350 5470-5725	n (HT20)	5180-5240 5260-5320 5500-5700	36-48 [4] 52-64 [4] 100-140 [8]	1	MCS 0-7

Note 1: RF output power specifies that Maximum Conducted Output Power.
 Note 2: 802.11a/n uses a combination of OFDM-BPSK, QPSK, 16QAM, 64QAM modulation.
 Note 3: 802.11n supports HT20 only.

1.1.2 Antenna Details (The additional antenna were marked in boldface.)

Ant. No.	Brand /Model	Type	Connector	Operating Frequencies (MHz) / Antenna Gain (dBi)				
				2400~2483.5	5150~5250	5250~5350	5470~5725	5725~5850
1	MAG.LAYERS EDA-1513-25GR2-B2-CY	Dipole	SMA Jack Reverse	2	2	2	2	2
2	MAG.LAYERS PCA-4606-2G4C1-A13-CY	PCB Dipole	UFL	2.21	2.21	2.21	2.21	2.21
3	Larid NanoBlade-IP04	PCB Dipole	UFL	2	3.9	3.9	4	4
4	Larid MAF95310 Mini NanoBlade Flex	PCB Dipole	UFL	2.79	3.38	3.38	3.38	3.38
5	Larid NanoBlue-IP04	PCB Dipole	UFL	2	---	---	---	---
6	Ethertronics WLAN_1000146	PIFA	UFL	2.5	3.5	3.5	3.5	3.5
7	SAA MG7018-41-000-R	Dipole	UFL	1.87	0.85	0.6	0.94	0.92
8	SAA MG7324-41-000-R	Dipole	UFL	1.32	1.04	1.6	2.75	2.24

1.1.3 Power Supply Type of Equipment under Test (EUT)

Power Supply Type	3.3Vdc or 1.8Vdc from host.
--------------------------	-----------------------------

1.1.4 Accessories

N/A

1.1.5 Channel List

Frequency band (MHz)	
802.11 a / n HT20	
Channel	Frequency(MHz)
36	5180
40	5200
44	5220
48	5240
52	5260
56	5280
60	5300
64	5320
100	5500
104	5520
108	5540
112	5560
116	5580
132	5660
136	5680
140	5700

1.2 Local Support Equipment List

Support Equipment List					
No.	Equipment	Brand	Model	FCC ID	Signal cable / Length (m)
1	Fixture	---	---	---	---

Note: No.1 was provided by applicant

1.3 Test Setup Chart

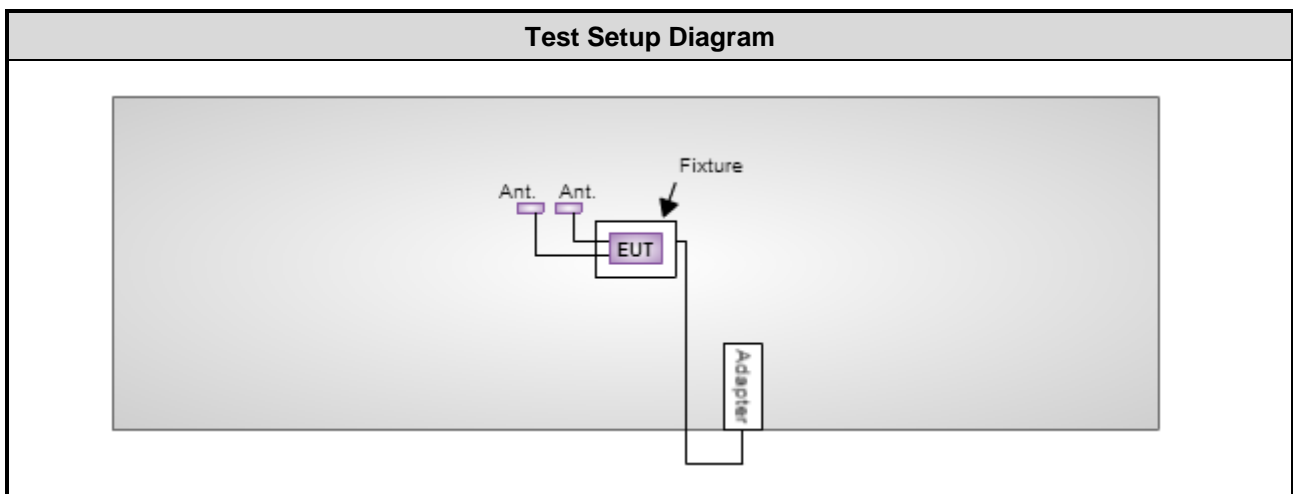

1.4 The Equipment List

Test Item	Conducted Emission				
Test Site	Conduction room 1 / (CO01-WS)				
Instrument	Manufacturer	Model No.	Serial No.	Calibration Date	Calibration Until
EMC Receiver	R&S	ESCS 30	100169	Oct. 17, 2014	Oct. 16, 2015
LISN	SCHWARZBECK	Schwarzbeck 8127	8127-667	Nov. 17, 2014	Nov. 16, 2015
RF Cable-CON	Woken	CFD200-NL	CFD200-NL-001	Dec. 31, 2014	Dec. 30, 2015
Measurement Software	AUDIX	e3	6.120210k	NA	NA

Note: Calibration Interval of instruments listed above is one year.

Test Item	Radiated Emission				
Test Site	966 chamber 2 / (03CH02-WS)				
Instrument	Manufacturer	Model No.	Serial No.	Calibration Date	Calibration Until
Spectrum Analyzer	R&S	FSV40	101499	Dec. 31, 2014	Dec. 30, 2015
Receiver	R&S	ESR3	101657	Jan. 15, 2015	Jan. 14, 2016
Bilog Antenna	SCHWARZBECK	VULB9168	VULB9168-524	Oct. 16, 2014	Oct. 15, 2015
Horn Antenna 1G-18G	SCHWARZBECK	BBHA 9120 D	BBHA 9120 D 1095	Oct. 14, 2014	Oct. 13, 2015
Horn Antenna 18G-40G	SCHWARZBECK	BBHA 9170	BBHA 9170517	Nov. 10, 2014	Nov. 09, 2015
Loop Antenna	R&S	HFH2-Z2	11900	Nov. 10, 2014	Nov. 09, 2015
Preamplifier	Burgeon	BPA-530	100218	Nov. 10, 2014	Nov. 09, 2015
Preamplifier	Agilent	83017A	MY39501309	Sep. 29, 2014	Sep. 28, 2015
Preamplifier	EMC	EMC184045B	980192	Aug. 26, 2014	Aug. 25, 2015
RF Cable	HUBER+SUHNER	SUCOFLEX104	MY16140/4	Dec. 16, 2014	Dec. 15, 2015
RF Cable	HUBER+SUHNER	SUCOFLEX104	MY16018/4	Dec. 16, 2014	Dec. 15, 2015
RF Cable	HUBER+SUHNER	SUCOFLEX104	MY16015/4	Dec. 16, 2014	Dec. 15, 2015
LF cable 3M	Woken	CFD400NL-LW	CFD400NL-003	Dec. 16, 2014	Dec. 15, 2015
LF cable 10M	Woken	CFD400NL-LW	CFD400NL-004	Dec. 16, 2014	Dec. 15, 2015
Measurement Software	AUDIX	e3	6.120210g	NA	NA

Note: Calibration Interval of instruments listed above is one year.

1.5 Testing Applied Standards

According to the specification of EUT, the EUT must comply with following standards and KDB documents.

47 CFR FCC Part 15.407

ANSI C63.10-2013

FCC KDB 789033 D02 General UNII Test Procedures New Rules v01

FCC KDB 644545 D03 Guidance for IEEE 802 11ac New Rules v01

FCC KDB 412172 D01 Determining ERP and EIRP v01r01

1.6 Measurement Uncertainty

ISO/IEC 17025 requires that an estimate of the measurement uncertainties associated with the emissions test results be included in the report. The measurement uncertainties given below are based on a 95% confidence level (based on a coverage factor (k=2))

Measurement Uncertainty	
Parameters	Uncertainty
AC conducted emission	±2.92 dB
Radiated emission ≤ 1GHz	±3.62 dB
Radiated emission > 1GHz	±5.6 dB

2 Test Configuration

2.1 Testing Condition

Test Item	Test Site	Ambient Condition	Tested By
AC Conduction	CO01-WS	22°C / 59%	Kevin Ma
Radiated Emissions	03CH02-WS	21-22°C / 61-63%	Anderson Hung

➤ FCC site registration No.: 657002

➤ IC site registration No.: 10807A-2

2.2 The Worst Test Modes and Channel Details

Test item	Modulation Mode	Test Frequency (MHz)	Data Rate (Mbps) / MCS	Test Configuration
Conducted Emissions	11a	5500	6 Mbps	4
Radiated Emissions ≤1GHz	11a	5500	6 Mbps	1, 2, 3, 4
Radiated Emissions >1GHz	11a	5500 / 5580 / 5700	6 Mbps	4
	HT20	5500 / 5580 / 5700	MCS 0	

NOTE:

1. 3 types antenna are used for this device.
2. For original antennas, the highest gain antenna of each type is selected to perform related test item as below test configuration.
3. For additional antennas, the highest gain antenna is selected to perform all test items as configuration 4.
4. Test configurations are listed as below:
 - 1) Configuration 1: Dipole antenna (Antenna No.1), Y-plane.
 - 2) Configuration 2 : PCB Dipole antenna (Antenna No.3) , Y-plane
 - 3) Configuration 3 : PIFA antenna (Antenna No.6) , Y-plane
 - 4) Configuration 4 : Dipole antenna (Antenna No.8) , Y-plane
5. The EUT supports two DC voltage options, 3.3Vdc and 1.8Vdc. Both options were assessed and 3.3Vdc was found to be the worst case and was selected for the final test.

3 Transmitter Test Results

3.1 Conducted Emissions

3.1.1 Limit of Conducted Emissions

Conducted Emissions Limit		
Frequency Emission (MHz)	Quasi-Peak	Average
0.15-0.5	66 - 56 *	56 - 46 *
0.5-5	56	46
5-30	60	50

Note 1: * Decreases with the logarithm of the frequency.

3.1.2 Test Procedures

1. The device is placed on a test table, raised 80 cm above the reference ground plane. The vertical conducting plane is located 40 cm to the rear of the device.
2. The device is connected to line impedance stabilization network (LISN) and other accessories are connected to other LISN. Measured levels of AC power line conducted emission are across the 50 Ω LISN port.
3. AC conducted emission measurements is made over frequency range from 150 kHz to 30 MHz.
4. This measurement was performed with AC 120V/60Hz

3.1.3 Test Setup



- Note: 1. Support units were connected to second LISN.
 2. Both of LISNs (AMN) are 80 cm from EUT and at least 80 cm from other units and other metal planes

3.1.4 Test Result of Conducted Emissions

Modulation	11a	Test Freq. (MHz)	5500
Power Phase	Line	Test Configuration	4

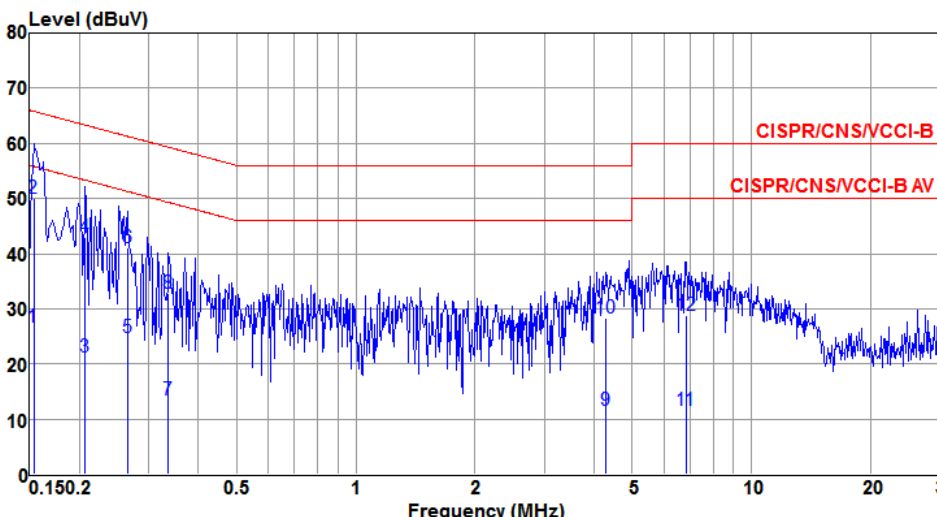

	Freq MHz	Level dBuV	Limit Line dBuV	Over Limit dB	Read Level dBuV	LISN factor dB	cable loss dB	Remark
1	0.153	26.72	55.82	-29.10	25.76	0.88	0.08	Average
2*	0.153	50.09	65.82	-15.73	49.13	0.88	0.08	QP
3	0.207	21.19	53.32	-32.13	20.85	0.25	0.09	Average
4	0.207	43.04	63.32	-20.28	42.70	0.25	0.09	QP
5	0.264	24.88	51.29	-26.41	24.56	0.22	0.10	Average
6	0.264	40.96	61.29	-20.33	40.64	0.22	0.10	QP
7	0.336	13.40	49.31	-35.91	13.10	0.20	0.10	Average
8	0.336	32.90	59.31	-26.41	32.60	0.20	0.10	QP
9	4.292	11.56	46.00	-34.44	10.96	0.29	0.31	Average
10	4.292	28.29	56.00	-27.71	27.69	0.29	0.31	QP
11	6.841	11.64	50.00	-38.36	10.84	0.50	0.30	Average
12	6.841	28.78	60.00	-31.22	27.98	0.50	0.30	QP

Note 1: Level (dBuV) = Read Level (dBuV) + LISN Factor (dB) + Cable Loss (dB).
 2: Over Limit (dB) = Level (dBuV) – Limit Line (dBuV).

Modulation	11a	Test Freq. (MHz)	5500
Power Phase	Neutral	Test Configuration	4

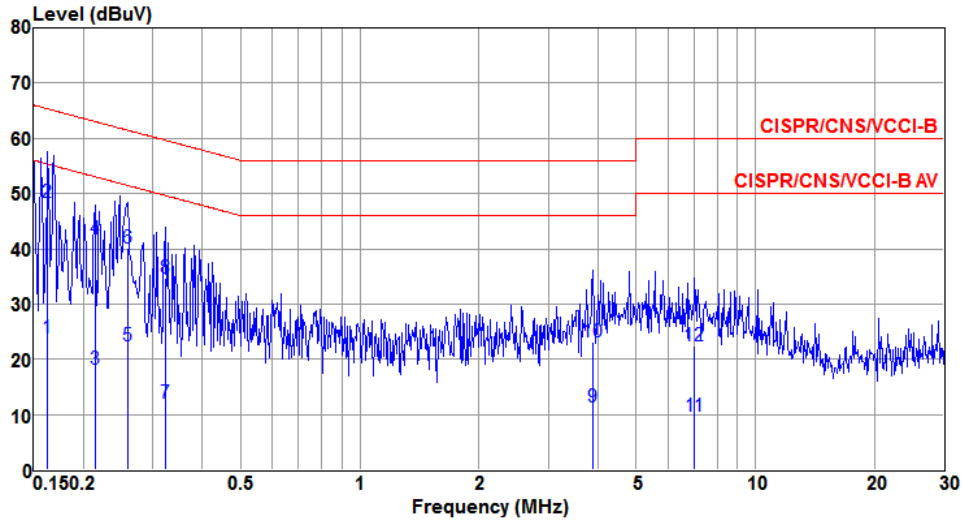

	Freq MHz	Level dBuV	Limit Line dBuV	Over Limit dB	Read Level dBuV	LISN factor dB	cable loss dB	Remark
1	0.162	23.82	55.34	-31.52	23.06	0.68	0.08	Average
2*	0.162	48.50	65.34	-16.84	47.74	0.68	0.08	QP
3	0.214	18.28	53.05	-34.77	17.96	0.23	0.09	Average
4	0.214	41.71	63.05	-21.34	41.39	0.23	0.09	QP
5	0.259	22.35	51.47	-29.12	22.05	0.20	0.10	Average
6	0.259	40.19	61.47	-21.28	39.89	0.20	0.10	QP
7	0.322	12.07	49.66	-37.59	11.81	0.16	0.10	Average
8	0.322	34.68	59.66	-24.98	34.42	0.16	0.10	QP
9	3.881	11.42	46.00	-34.58	10.39	0.72	0.31	Average
10	3.881	23.19	56.00	-32.81	22.16	0.72	0.31	QP
11	7.025	9.73	50.00	-40.27	8.82	0.61	0.30	Average
12	7.025	22.52	60.00	-37.48	21.61	0.61	0.30	QP

Note 1: Level (dBuV) = Read Level (dBuV) + LISN Factor (dB) + Cable Loss (dB).
 2: Over Limit (dB) = Level (dBuV) – Limit Line (dBuV).

3.2 Transmitter Radiated and Band Edge Emissions

3.2.1 Limit of Transmitter Radiated and Band Edge Emissions

Restricted Band Emissions Limit			
Frequency Range (MHz)	Field Strength (uV/m)	Field Strength (dBuV/m)	Measure Distance (m)
0.009~0.490	2400/F(kHz)	48.5 - 13.8	300
0.490~1.705	24000/F(kHz)	33.8 - 23	30
1.705~30.0	30	29	30
30~88	100	40	3
88~216	150	43.5	3
216~960	200	46	3
Above 960	500	54	3

Note 1:
Qusai-Peak value is measured for frequency below 1GHz except for 9–90 kHz, 110–490 kHz frequency band. Peak and average value are measured for frequency above 1GHz. The limit on average radio frequency emission is as above table. The limit on peak radio frequency emissions is 20 dB above the maximum permitted average emission limit

Note 2:
Measurements may be performed at a distance other than what is specified provided. When performing measurements at a distance other than that specified, the results shall be extrapolated to the specified distance using an extrapolation factor as below, Frequency at or above 30 MHz: 20 dB/decade Frequency below 30 MHz: 40 dB/decade.

Un-restricted band emissions above 1GHz Limit	
Operating Band	Limit
5.15 - 5.25 GHz	e.i.r.p. -27 dBm [68.2 dBuV/m@3m]
5.25 - 5.35 GHz	e.i.r.p. -27 dBm [68.2 dBuV/m@3m]
5.47 - 5.725 GHz	e.i.r.p. -27 dBm [68.2 dBuV/m@3m]
5.725 - 5.850 GHz	5.715 5.725 GHz: e.i.r.p. -17 dBm [78.2 dBuV/m@3m] 5.85 5.86 GHz: e.i.r.p. -17 dBm [78.2 dBuV/m@3m] Other un-restricted band: e.i.r.p. -27 dBm [68.2 dBuV/m@3m]

Note 1: Measurements may be performed at a distance other than the limit distance provided they are not performed in the near field and the emissions to be measured can be detected by the measurement equipment. When performing measurements at a distance other than that specified, the results shall be extrapolated to the specified distance using an extrapolation factor of 20 dB/decade (inverse of linear distance for field-strength measurements, inverse of linear distance-squared for power-density measurements).

3.2.2 Test Procedures

1. Measurement is made at a semi-anechoic chamber that incorporates a turntable allowing a EUT rotation of 360°. A continuously-rotating, remotely-controlled turntable is installed at the test site to support the EUT and facilitate determination of the direction of maximum radiation for each EUT emission frequency. The EUT is placed at test table. For emissions testing at or below 1 GHz, the table height is 80 cm above the reference ground plane. For emission measurements above 1 GHz, the table height is 1.5 m
2. Measurement is made with the antenna positioned in both the horizontal and vertical planes of polarization. The measurement antenna is varied in height (1m ~ 4m) above the reference ground plane to obtain the maximum signal strength. Distance between EUT and antenna is 3 m.
3. This investigation is performed with the EUT rotated 360°, the antenna height scanned between 1 m and 4 m, and the antenna rotated to repeat the measurements for both the horizontal and vertical antenna polarizations.

Note:

1. 120kHz measurement bandwidth of test receiver and Quasi-peak detector is for radiated emission below 1GHz.
2. RBW=1MHz, VBW=3MHz and Peak detector is for peak measured value of radiated emission above 1GHz.
3. RBW=1MHz, VBW=1/T and Peak detector is for average measured value of radiated emission above 1GHz.

3.2.3 Test Setup

Radiated Emissions below 1 GHz

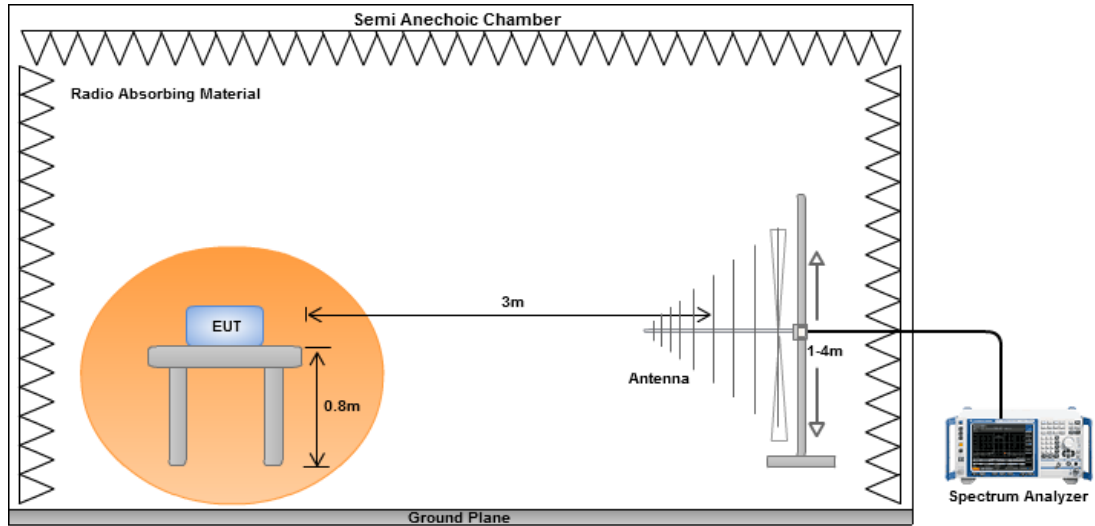

Radiated Emissions above 1 GHz

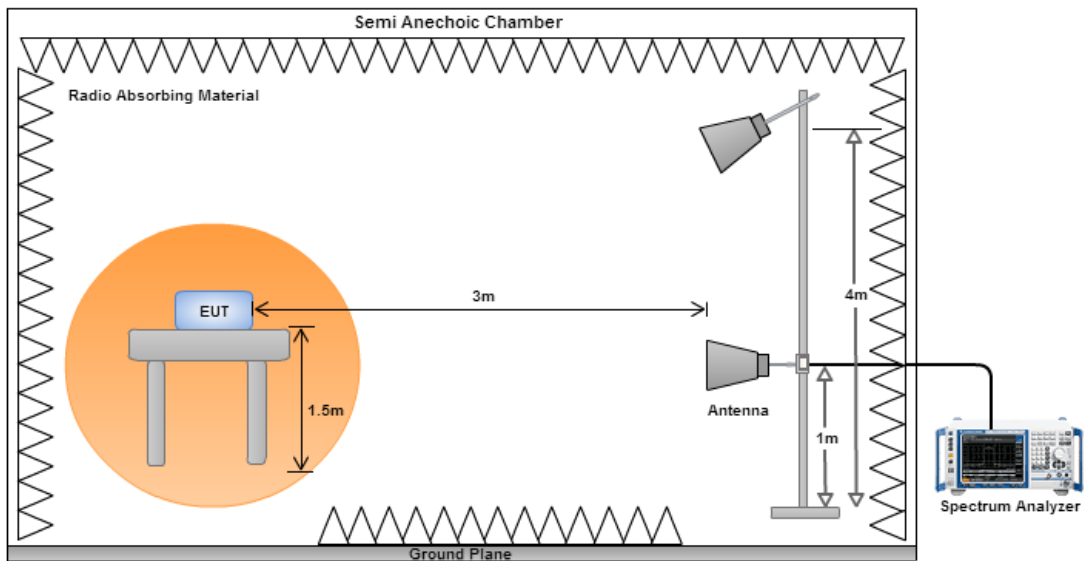

3.2.4 Transmitter Radiated Unwanted Emissions (Below 1GHz)

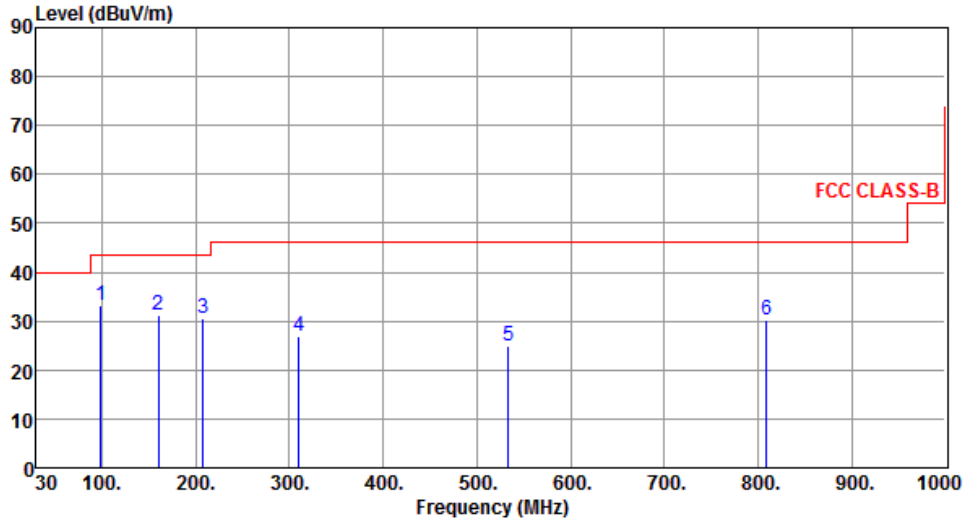
Modulation	11a	Test Freq. (MHz)	5500																																																																								
Polarization	Horizontal	Test Configuration	1																																																																								
 <p>The graph displays the radiated unwanted emissions for a transmitter. The y-axis represents the emission level in dBuV/m, ranging from 0 to 90. The x-axis represents the frequency in MHz, ranging from 30 to 1000. A red line indicates the FCC CLASS-B limit, which is constant at 43.50 dBuV/m from 30 MHz to 1000 MHz. Six emission peaks are identified and labeled with numbers 1 through 6. The peak levels are significantly below the limit, with margins ranging from -6.77 dB to -22.07 dB.</p>																																																																											
	<table border="1"> <thead> <tr> <th>Freq.</th> <th>Emission level</th> <th>Limit</th> <th>Margin</th> <th>SA reading</th> <th>Factor</th> <th>Remark</th> <th>ANT High cm</th> <th>Turn Table deg</th> </tr> <tr> <th>MHz</th> <th>dBuV/m</th> <th>dBuV/m</th> <th>dB</th> <th>dBuV</th> <th>dB</th> <th></th> <th></th> <th></th> </tr> </thead> <tbody> <tr> <td>1</td> <td>33.34</td> <td>43.50</td> <td>-10.16</td> <td>55.41</td> <td>-22.07</td> <td>Peak</td> <td>---</td> <td>---</td> </tr> <tr> <td>2</td> <td>31.12</td> <td>43.50</td> <td>-12.38</td> <td>48.07</td> <td>-16.95</td> <td>Peak</td> <td>---</td> <td>---</td> </tr> <tr> <td>3</td> <td>30.52</td> <td>43.50</td> <td>-12.98</td> <td>50.01</td> <td>-19.49</td> <td>Peak</td> <td>---</td> <td>---</td> </tr> <tr> <td>4</td> <td>26.89</td> <td>46.00</td> <td>-19.11</td> <td>42.73</td> <td>-15.84</td> <td>Peak</td> <td>---</td> <td>---</td> </tr> <tr> <td>5</td> <td>24.82</td> <td>46.00</td> <td>-21.18</td> <td>35.83</td> <td>-11.01</td> <td>Peak</td> <td>---</td> <td>---</td> </tr> <tr> <td>6</td> <td>30.14</td> <td>46.00</td> <td>-15.86</td> <td>36.91</td> <td>-6.77</td> <td>Peak</td> <td>---</td> <td>---</td> </tr> </tbody> </table>	Freq.	Emission level	Limit	Margin	SA reading	Factor	Remark	ANT High cm	Turn Table deg	MHz	dBuV/m	dBuV/m	dB	dBuV	dB				1	33.34	43.50	-10.16	55.41	-22.07	Peak	---	---	2	31.12	43.50	-12.38	48.07	-16.95	Peak	---	---	3	30.52	43.50	-12.98	50.01	-19.49	Peak	---	---	4	26.89	46.00	-19.11	42.73	-15.84	Peak	---	---	5	24.82	46.00	-21.18	35.83	-11.01	Peak	---	---	6	30.14	46.00	-15.86	36.91	-6.77	Peak	---	---		
Freq.	Emission level	Limit	Margin	SA reading	Factor	Remark	ANT High cm	Turn Table deg																																																																			
MHz	dBuV/m	dBuV/m	dB	dBuV	dB																																																																						
1	33.34	43.50	-10.16	55.41	-22.07	Peak	---	---																																																																			
2	31.12	43.50	-12.38	48.07	-16.95	Peak	---	---																																																																			
3	30.52	43.50	-12.98	50.01	-19.49	Peak	---	---																																																																			
4	26.89	46.00	-19.11	42.73	-15.84	Peak	---	---																																																																			
5	24.82	46.00	-21.18	35.83	-11.01	Peak	---	---																																																																			
6	30.14	46.00	-15.86	36.91	-6.77	Peak	---	---																																																																			
<p>Note 1: Emission Level (dBuV/m) = SA Reading (dBuV/m) + Factor* (dB) *Factor includes antenna factor , cable loss and amplifier gain Note 2: Margin (dB) = Emission level (dBuV/m) – Limit (dBuV/m). Note 3: All spurious emissions below 30MHz are more than 20 dB below the limit.</p>																																																																											

Modulation	11a	Test Freq. (MHz)	5500
Polarization	Vertical	Test Configuration	1

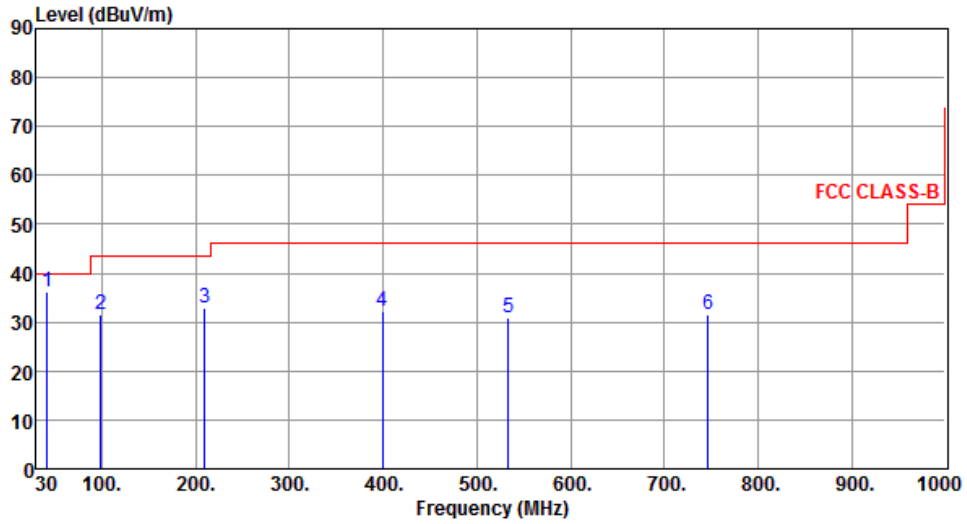

	Freq. MHz	Emission level dBuV/m	Limit dBuV/m	Margin dB	SA reading dBuV	Factor dB	Remark	ANT High cm	Turn Table deg
1	41.64	36.29	40.00	-3.71	53.37	-17.08	QP	---	---
2	98.87	31.67	43.50	-11.83	53.74	-22.07	Peak	---	---
3	209.45	32.96	43.50	-10.54	52.38	-19.42	Peak	---	---
4	399.57	32.36	46.00	-13.64	46.03	-13.67	Peak	---	---
5	533.43	30.74	46.00	-15.26	41.75	-11.01	Peak	---	---
6	746.83	31.41	46.00	-14.59	38.76	-7.35	Peak	---	---

Note 1: Emission Level (dBuV/m) = SA Reading (dBuV/m) + Factor* (dB)

*Factor includes antenna factor , cable loss and amplifier gain

Note 2: Margin (dB) = Emission level (dBuV/m) – Limit (dBuV/m).

Note 3: All spurious emissions below 30MHz are more than 20 dB below the limit.

Modulation	11a	Test Freq. (MHz)	5500
Polarization	Horizontal	Test Configuration	2

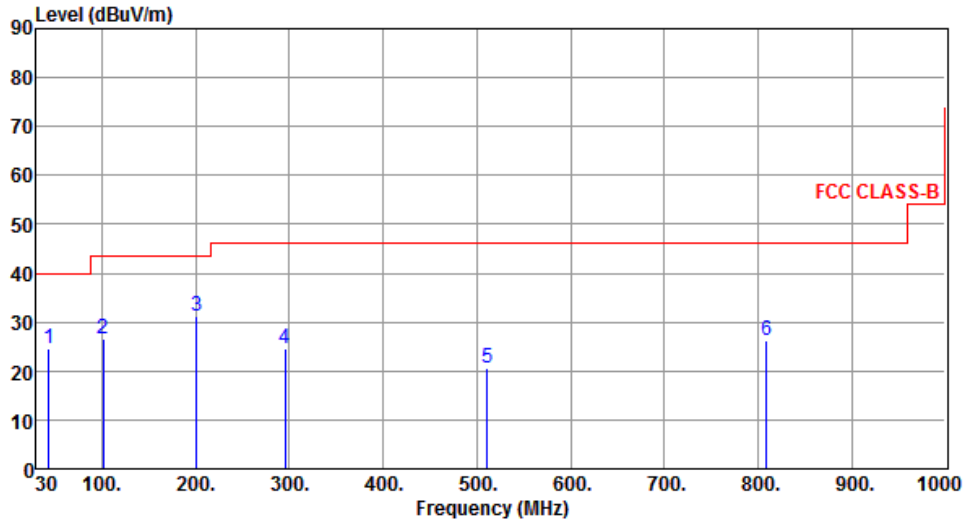

	Freq. MHz	Emission level dBuV/m	Limit dBuV/m	Margin dB	SA reading dBuV	Factor dB	Remark	ANT High cm	Turn Table deg
1	43.58	24.59	40.00	-15.41	41.49	-16.90	Peak	---	---
2	101.78	26.45	43.50	-17.05	48.11	-21.66	Peak	---	---
3	200.72	31.11	43.50	-12.39	50.83	-19.72	Peak	---	---
4	295.78	24.58	46.00	-21.42	40.80	-16.22	Peak	---	---
5	511.12	20.59	46.00	-25.41	32.07	-11.48	Peak	---	---
6	808.91	26.15	46.00	-19.85	32.92	-6.77	Peak	---	---

Note 1: Emission Level (dBuV/m) = SA Reading (dBuV/m) + Factor* (dB)

*Factor includes antenna factor , cable loss and amplifier gain

Note 2: Margin (dB) = Emission level (dBuV/m) – Limit (dBuV/m).

Note 3: All spurious emissions below 30MHz are more than 20 dB below the limit.

Modulation	11a	Test Freq. (MHz)	5500
Polarization	Vertical	Test Configuration	2

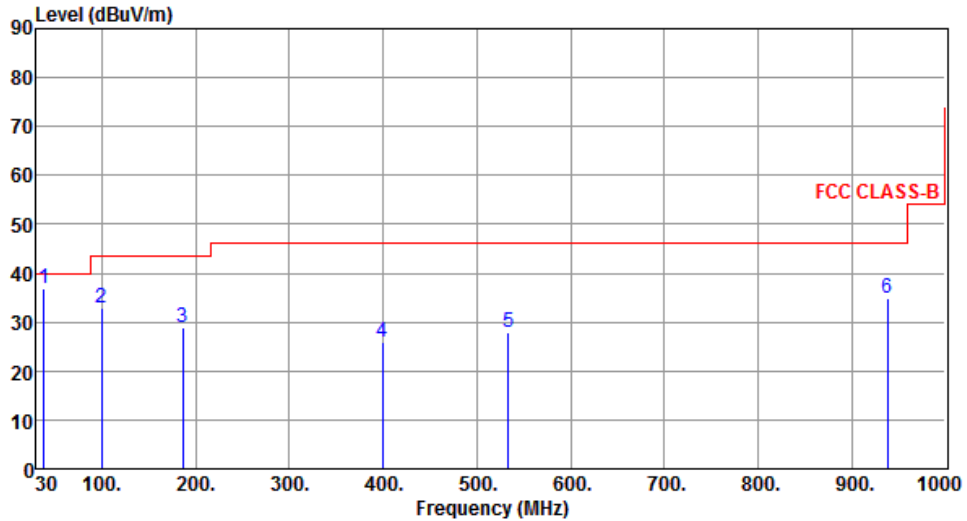

	Freq. MHz	Emission level dBuV/m	Limit dBuV/m	Margin dB	SA reading dBuV	Factor dB	Remark	ANT High cm	Turn Table deg
1	37.76	36.92	40.00	-3.08	54.34	-17.42	QP	---	---
2	99.84	32.98	43.50	-10.52	54.92	-21.94	Peak	---	---
3	186.17	28.85	43.50	-14.65	47.91	-19.06	Peak	---	---
4	399.57	25.96	46.00	-20.04	39.63	-13.67	Peak	---	---
5	533.43	27.80	46.00	-18.20	38.81	-11.01	Peak	---	---
6	937.92	34.76	46.00	-11.24	39.63	-4.87	Peak	---	---

Note 1: Emission Level (dBuV/m) = SA Reading (dBuV/m) + Factor* (dB)

*Factor includes antenna factor , cable loss and amplifier gain

Note 2: Margin (dB) = Emission level (dBuV/m) – Limit (dBuV/m).

Note 3: All spurious emissions below 30MHz are more than 20 dB below the limit.

Modulation	11a	Test Freq. (MHz)	5500
Polarization	Horizontal	Test Configuration	3

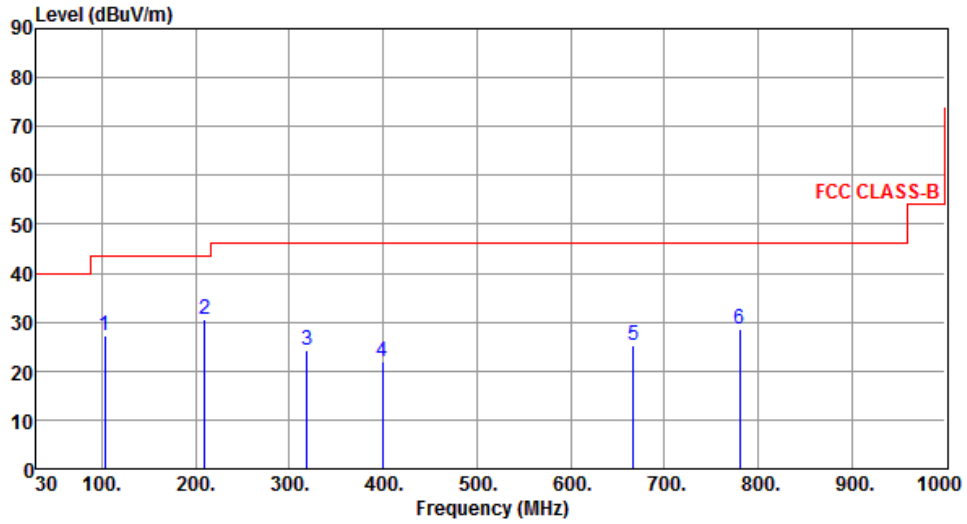

	Freq. MHz	Emission level dBuV/m	Limit dBuV/m	Margin dB	SA reading dBuV	Factor dB	Remark	ANT High cm	Turn Table deg
1	102.75	27.34	43.50	-16.16	48.85	-21.51	Peak	---	---
2	209.45	30.57	43.50	-12.93	49.99	-19.42	Peak	---	---
3	319.06	24.38	46.00	-21.62	40.04	-15.66	Peak	---	---
4	399.57	21.91	46.00	-24.09	35.58	-13.67	Peak	---	---
5	667.29	25.14	46.00	-20.86	33.90	-8.76	Peak	---	---
6	780.78	28.65	46.00	-17.35	35.72	-7.07	Peak	---	---

Note 1: Emission Level (dBuV/m) = SA Reading (dBuV/m) + Factor* (dB)

*Factor includes antenna factor , cable loss and amplifier gain

Note 2: Margin (dB) = Emission level (dBuV/m) – Limit (dBuV/m).

Note 3: All spurious emissions below 30MHz are more than 20 dB below the limit.

Modulation	11a	Test Freq. (MHz)	5500
Polarization	Vertical	Test Configuration	3

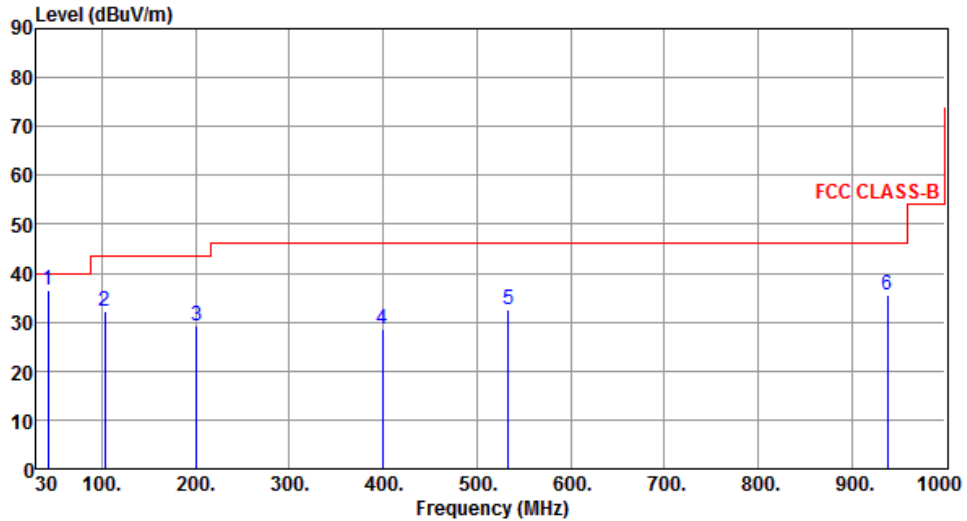

	Freq. MHz	Emission level dBuV/m	Limit dBuV/m	Margin dB	SA reading dBuV	Factor dB	Remark	ANT High cm	Turn Table deg
1	42.61	36.57	40.00	-3.43	53.56	-16.99	QP	---	---
2	102.75	32.31	43.50	-11.19	53.82	-21.51	Peak	---	---
3	200.72	29.23	43.50	-14.27	48.95	-19.72	Peak	---	---
4	399.57	28.59	46.00	-17.41	42.26	-13.67	Peak	---	---
5	533.43	32.53	46.00	-13.47	43.54	-11.01	Peak	---	---
6	937.92	35.66	46.00	-10.34	40.53	-4.87	Peak	---	---

Note 1: Emission Level (dBuV/m) = SA Reading (dBuV/m) + Factor* (dB)

*Factor includes antenna factor , cable loss and amplifier gain

Note 2: Margin (dB) = Emission level (dBuV/m) – Limit (dBuV/m).

Note 3: All spurious emissions below 30MHz are more than 20 dB below the limit.

Modulation	11a	Test Freq. (MHz)	5500
Polarization	Horizontal	Test Configuration	4

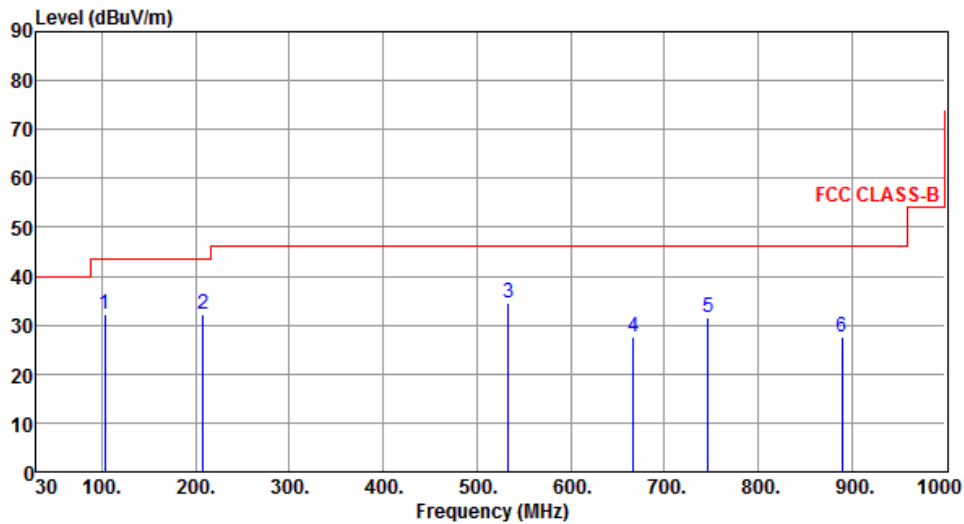

	Freq. MHz	Emission level dBuV/m	Limit dBuV/m	Margin dB	SA reading dBuV	Factor dB	Remark	ANT High cm	Turn Table deg
1	102.75	32.18	43.50	-11.32	53.69	-21.51	Peak	---	---
2	207.51	32.33	43.50	-11.17	51.82	-19.49	Peak	---	---
3	533.43	34.49	46.00	-11.51	45.50	-11.01	Peak	---	---
4	667.29	27.42	46.00	-18.58	36.18	-8.76	Peak	---	---
5	746.83	31.71	46.00	-14.29	39.06	-7.35	Peak	---	---
6	889.42	27.71	46.00	-18.29	33.10	-5.39	Peak	---	---

Note 1: Emission Level (dBuV/m) = SA Reading (dBuV/m) + Factor* (dB)

*Factor includes antenna factor , cable loss and amplifier gain

Note 2: Margin (dB) = Emission level (dBuV/m) – Limit (dBuV/m).

Note 3: All spurious emissions below 30MHz are more than 20 dB below the limit.

Modulation	11a	Test Freq. (MHz)	5500
Polarization	Vertical	Test Configuration	4

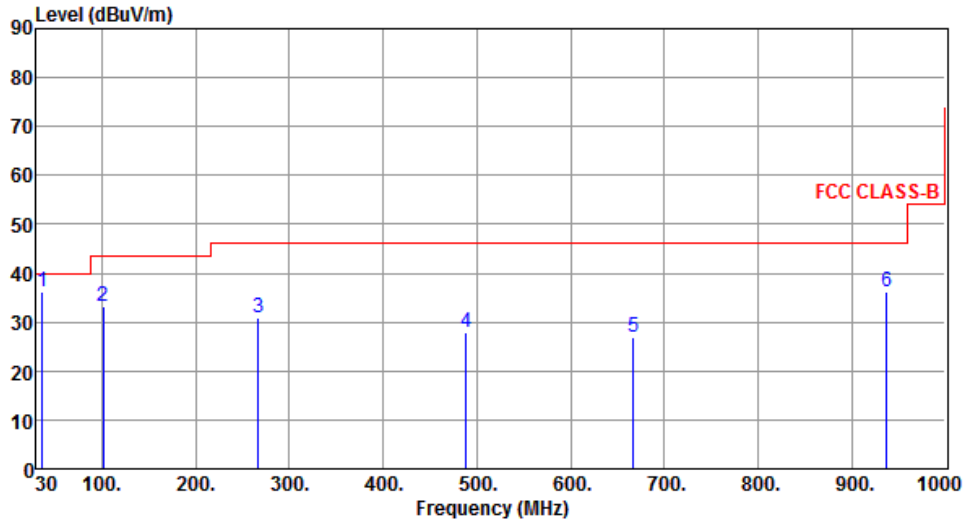

	Freq. MHz	Emission level dBuV/m	Limit dBuV/m	Margin dB	SA reading dBuV	Factor dB	Remark	ANT High cm	Turn Table deg
1	36.79	36.30	40.00	-3.70	53.80	-17.50	QP	---	---
2	101.78	33.16	43.50	-10.34	54.82	-21.66	Peak	---	---
3	266.68	30.94	46.00	-15.06	48.24	-17.30	Peak	---	---
4	488.81	27.84	46.00	-18.16	39.74	-11.90	Peak	---	---
5	667.29	26.76	46.00	-19.24	35.52	-8.76	Peak	---	---
6	936.95	36.12	46.00	-9.88	41.00	-4.88	Peak	---	---

Note 1: Emission Level (dBuV/m) = SA Reading (dBuV/m) + Factor* (dB)

*Factor includes antenna factor , cable loss and amplifier gain

Note 2: Margin (dB) = Emission level (dBuV/m) – Limit (dBuV/m).

Note 3: All spurious emissions below 30MHz are more than 20 dB below the limit.

3.2.5 Transmitter Radiated Unwanted Emissions (Above 1GHz) for 11a

Modulation	11a	Test Freq. (MHz)	5500
Polarization	Horizontal	Test Configuration	4

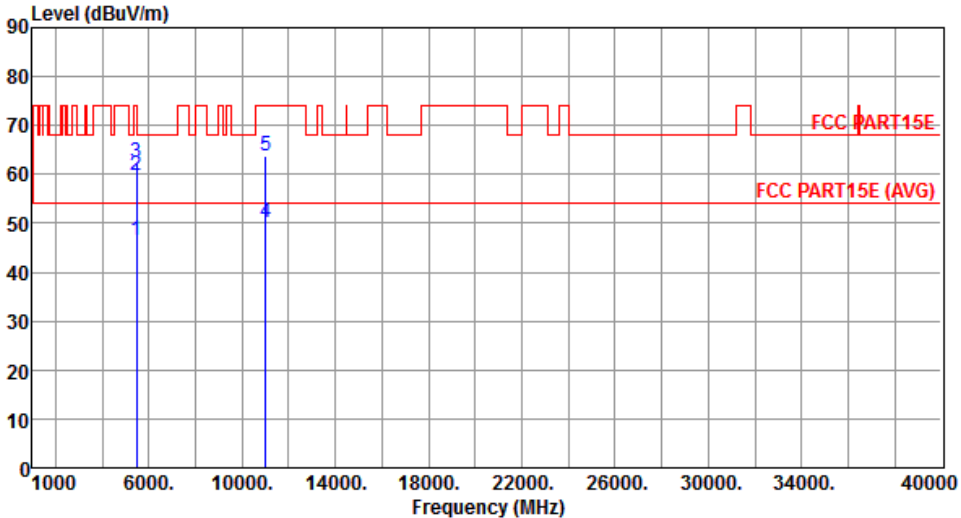

	Freq. MHz	Emission level dBuV/m	Limit dBuV/m	Margin dB	SA reading dBuV	Factor dB	Remark	ANT High cm	Turn Table deg
1	5460.00	46.51	54.00	-7.49	40.31	6.20	Average	182	219
2	5460.00	59.89	74.00	-14.11	53.69	6.20	Peak	182	219
3	5470.00	62.36	68.20	-5.84	56.14	6.22	Peak	182	219
4	11000.00	50.27	54.00	-3.73	34.17	16.10	Average	271	109
5	11000.00	63.68	74.00	-10.32	47.58	16.10	Peak	271	109

Note 1: Emission Level (dBuV/m) = SA Reading (dBuV/m) + Factor* (dB)
*Factor includes antenna factor , cable loss and amplifier gain
Note 2: Margin (dB) = Emission level (dBuV/m) – Limit (dBuV/m).

Modulation	11a	Test Freq. (MHz)	5500
Polarization	Vertical	Test Configuration	4

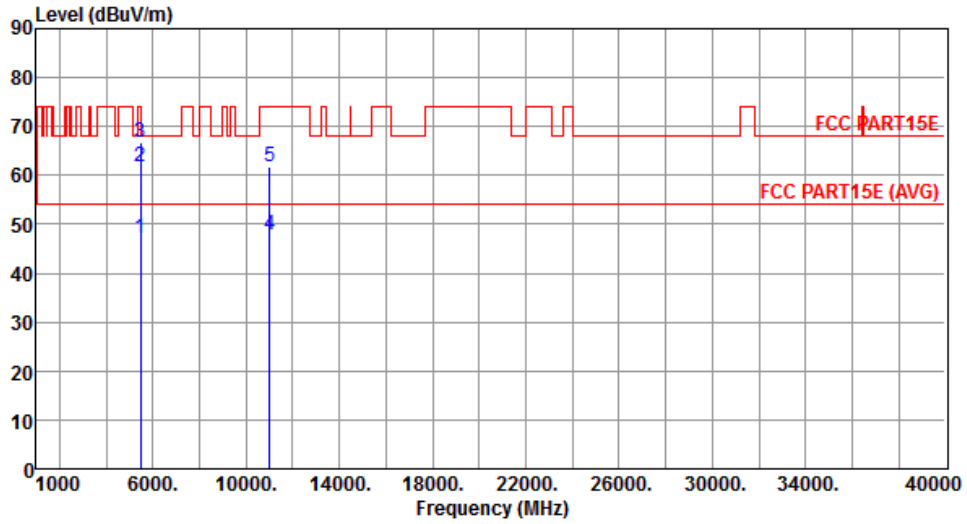

	Freq. MHz	Emission level dBuV/m	Limit dBuV/m	Margin dB	SA reading dBuV	Factor dB	Remark	ANT High cm	Turn Table deg
1	5460.00	47.08	54.00	-6.92	40.88	6.20	Average	198	87
2	5460.00	61.67	74.00	-12.33	55.47	6.20	Peak	198	87
3	5470.00	66.87	68.20	-1.33	60.65	6.22	Peak	198	87
4	11000.00	47.95	54.00	-6.05	31.85	16.10	Average	202	153
5	11000.00	61.72	74.00	-12.28	45.62	16.10	Peak	202	153

Note 1: Emission Level (dBuV/m) = SA Reading (dBuV/m) + Factor* (dB)

*Factor includes antenna factor , cable loss and amplifier gain

Note 2: Margin (dB) = Emission level (dBuV/m) – Limit (dBuV/m).

Modulation	11a	Test Freq. (MHz)	5580
Polarization	Horizontal	Test Configuration	4

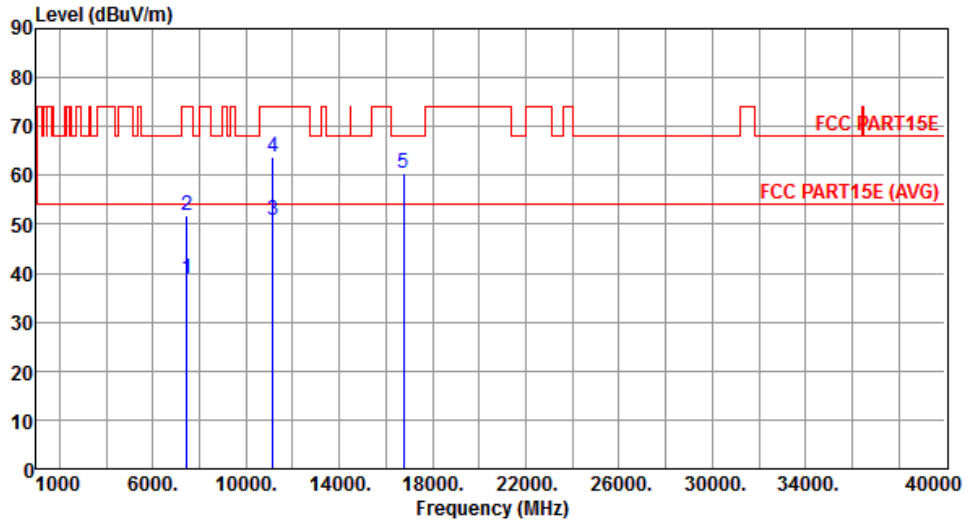

	Freq. MHz	Emission level dBuV/m	Limit dBuV/m	Margin dB	SA reading dBuV	Factor dB	Remark	ANT High cm	Turn Table deg
1	7440.00	38.87	54.00	-15.13	28.46	10.41	Average	188	327
2	7440.00	51.70	74.00	-22.30	41.29	10.41	Peak	188	327
3	11160.00	50.69	54.00	-3.31	34.55	16.14	Average	284	123
4	11160.00	63.82	74.00	-10.18	47.68	16.14	Peak	284	123
5	16740.00	60.58	68.20	-7.62	42.10	18.48	Peak	209	131

Note 1: Emission Level (dBuV/m) = SA Reading (dBuV/m) + Factor* (dB)

*Factor includes antenna factor , cable loss and amplifier gain

Note 2: Margin (dB) = Emission level (dBuV/m) – Limit (dBuV/m).

Modulation	11a	Test Freq. (MHz)	5580
Polarization	Vertical	Test Configuration	4

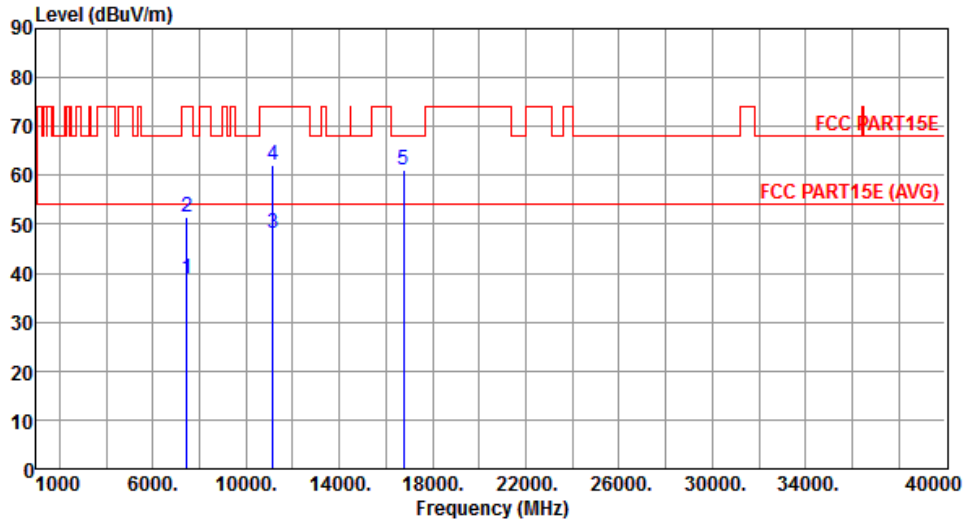

	Freq. MHz	Emission level dBuV/m	Limit dBuV/m	Margin dB	SA reading dBuV	Factor dB	Remark	ANT High cm	Turn Table deg
1	7440.00	38.98	54.00	-15.02	28.57	10.41	Average	228	37
2	7440.00	51.54	74.00	-22.46	41.13	10.41	Peak	228	37
3	11160.00	48.06	54.00	-5.94	31.92	16.14	Average	211	158
4	11160.00	62.09	74.00	-11.91	45.95	16.14	Peak	211	158
5	16740.00	61.06	68.20	-7.14	42.58	18.48	Peak	151	342

Note 1: Emission Level (dBuV/m) = SA Reading (dBuV/m) + Factor* (dB)

*Factor includes antenna factor , cable loss and amplifier gain

Note 2: Margin (dB) = Emission level (dBuV/m) – Limit (dBuV/m).

Modulation	11a	Test Freq. (MHz)	5700
Polarization	Horizontal	Test Configuration	4

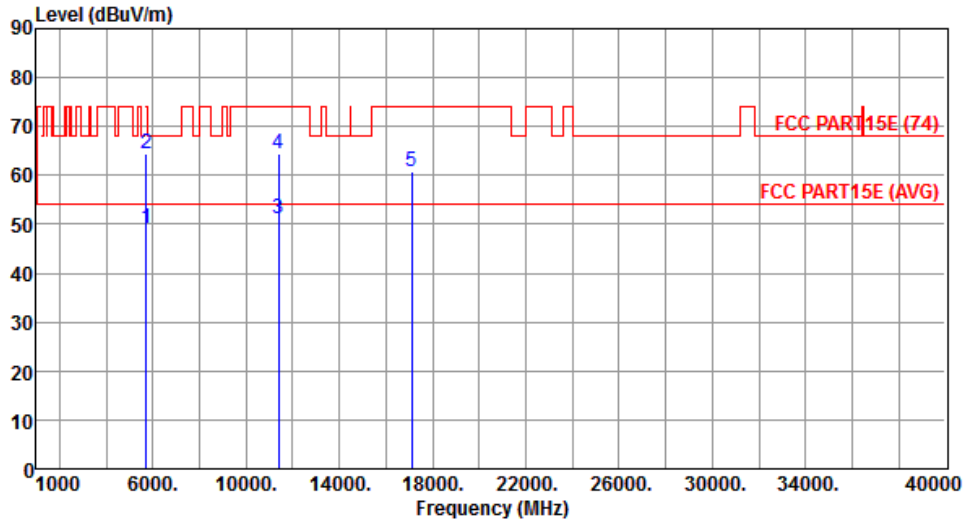

	Freq. MHz	Emission level dBuV/m	Limit dBuV/m	Margin dB	SA reading dBuV	Factor dB	Remark	ANT High cm	Turn Table deg
1	5725.00	49.21	54.00	-4.79	42.50	6.71	Average	187	218
2	5725.00	64.46	74.00	-9.54	57.75	6.71	Peak	187	218
3	11400.00	51.02	54.00	-2.98	34.83	16.19	Average	275	136
4	11400.00	64.35	74.00	-9.65	48.16	16.19	Peak	275	136
5	17100.00	60.89	74.00	-13.11	40.73	20.16	Peak	217	140

Note 1: Emission Level (dBuV/m) = SA Reading (dBuV/m) + Factor* (dB)

*Factor includes antenna factor , cable loss and amplifier gain

Note 2: Margin (dB) = Emission level (dBuV/m) – Limit (dBuV/m).

Modulation	11a	Test Freq. (MHz)	5700
Polarization	Vertical	Test Configuration	4

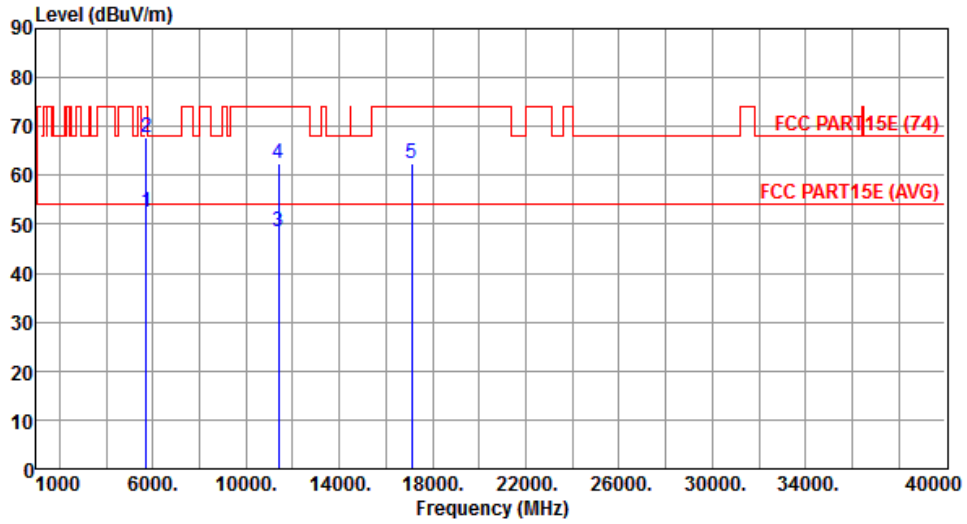

	Freq. MHz	Emission level dBuV/m	Limit dBuV/m	Margin dB	SA reading dBuV	Factor dB	Remark	ANT High cm	Turn Table deg
1	5725.00	52.51	54.00	-1.49	45.80	6.71	Average	192	98
2	5725.00	67.91	74.00	-6.09	61.20	6.71	Peak	192	98
3	11400.00	48.42	54.00	-5.58	32.23	16.19	Average	216	162
4	11400.00	62.28	74.00	-11.72	46.09	16.19	Peak	216	162
5	17100.00	62.34	74.00	-11.66	42.18	20.16	Peak	154	349

Note 1: Emission Level (dBuV/m) = SA Reading (dBuV/m) + Factor* (dB)

*Factor includes antenna factor , cable loss and amplifier gain

Note 2: Margin (dB) = Emission level (dBuV/m) – Limit (dBuV/m).

3.2.6 Transmitter Radiated Unwanted Emissions (Above 1GHz) for HT20

Modulation	HT20	Test Freq. (MHz)	5500																																																																					
Polarization	Horizontal	Test Configuration	4																																																																					
	<table border="1"> <thead> <tr> <th>Freq.</th> <th>Emission level</th> <th>Limit</th> <th>Margin</th> <th>SA reading</th> <th>Factor</th> <th>Remark</th> <th>ANT High</th> <th>Turn Table</th> </tr> <tr> <th>MHz</th> <th>dBuV/m</th> <th>dBuV/m</th> <th>dB</th> <th>dBuV</th> <th>dB</th> <th></th> <th>cm</th> <th>deg</th> </tr> </thead> <tbody> <tr> <td>1</td> <td>5460.00</td> <td>46.72</td> <td>54.00</td> <td>-7.28</td> <td>40.52</td> <td>6.20</td> <td>Average</td> <td>180</td> <td>222</td> </tr> <tr> <td>2</td> <td>5460.00</td> <td>60.13</td> <td>74.00</td> <td>-13.87</td> <td>53.93</td> <td>6.20</td> <td>Peak</td> <td>180</td> <td>222</td> </tr> <tr> <td>3</td> <td>5470.00</td> <td>62.89</td> <td>68.20</td> <td>-5.31</td> <td>56.67</td> <td>6.22</td> <td>Peak</td> <td>180</td> <td>222</td> </tr> <tr> <td>4</td> <td>11000.00</td> <td>49.93</td> <td>54.00</td> <td>-4.07</td> <td>33.83</td> <td>16.10</td> <td>Average</td> <td>269</td> <td>116</td> </tr> <tr> <td>5</td> <td>11000.00</td> <td>63.33</td> <td>74.00</td> <td>-10.67</td> <td>47.23</td> <td>16.10</td> <td>Peak</td> <td>269</td> <td>116</td> </tr> </tbody> </table>	Freq.	Emission level	Limit	Margin	SA reading	Factor	Remark	ANT High	Turn Table	MHz	dBuV/m	dBuV/m	dB	dBuV	dB		cm	deg	1	5460.00	46.72	54.00	-7.28	40.52	6.20	Average	180	222	2	5460.00	60.13	74.00	-13.87	53.93	6.20	Peak	180	222	3	5470.00	62.89	68.20	-5.31	56.67	6.22	Peak	180	222	4	11000.00	49.93	54.00	-4.07	33.83	16.10	Average	269	116	5	11000.00	63.33	74.00	-10.67	47.23	16.10	Peak	269	116			
Freq.	Emission level	Limit	Margin	SA reading	Factor	Remark	ANT High	Turn Table																																																																
MHz	dBuV/m	dBuV/m	dB	dBuV	dB		cm	deg																																																																
1	5460.00	46.72	54.00	-7.28	40.52	6.20	Average	180	222																																																															
2	5460.00	60.13	74.00	-13.87	53.93	6.20	Peak	180	222																																																															
3	5470.00	62.89	68.20	-5.31	56.67	6.22	Peak	180	222																																																															
4	11000.00	49.93	54.00	-4.07	33.83	16.10	Average	269	116																																																															
5	11000.00	63.33	74.00	-10.67	47.23	16.10	Peak	269	116																																																															
<p>Note 1: Emission Level (dBuV/m) = SA Reading (dBuV/m) + Factor* (dB) *Factor includes antenna factor , cable loss and amplifier gain Note 2: Margin (dB) = Emission level (dBuV/m) – Limit (dBuV/m).</p>																																																																								

Modulation	HT20	Test Freq. (MHz)	5500
Polarization	Vertical	Test Configuration	4

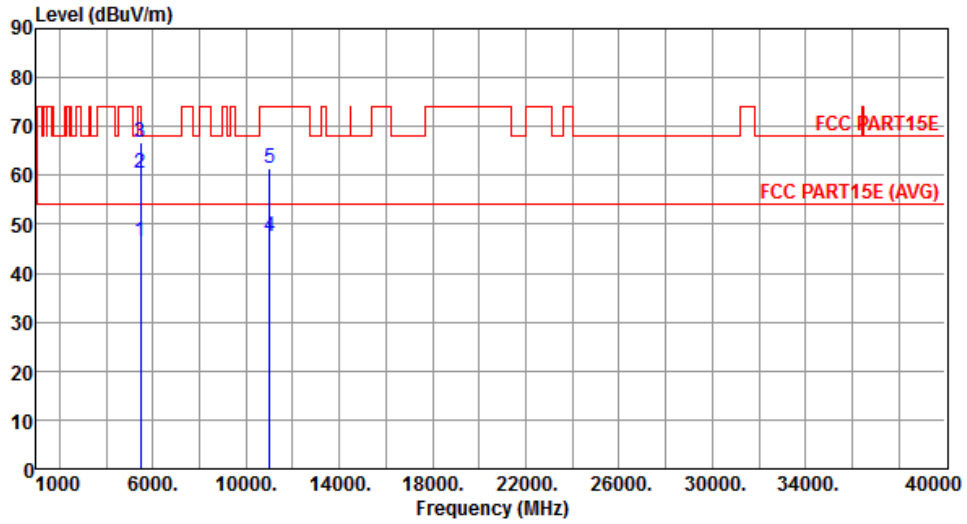

	Freq. MHz	Emission level dBuV/m	Limit dBuV/m	Margin dB	SA reading dBuV	Factor dB	Remark	ANT High cm	Turn Table deg
1	5460.00	46.64	54.00	-7.36	40.44	6.20	Average	186	79
2	5460.00	60.30	74.00	-13.70	54.10	6.20	Peak	186	79
3	5470.00	66.60	68.20	-1.60	60.38	6.22	Peak	186	79
4	11000.00	47.43	54.00	-6.57	31.33	16.10	Average	205	159
5	11000.00	61.35	74.00	-12.65	45.25	16.10	Peak	205	159

Note 1: Emission Level (dBuV/m) = SA Reading (dBuV/m) + Factor* (dB)

*Factor includes antenna factor , cable loss and amplifier gain

Note 2: Margin (dB) = Emission level (dBuV/m) – Limit (dBuV/m).

Modulation	HT20	Test Freq. (MHz)	5580
Polarization	Horizontal	Test Configuration	4

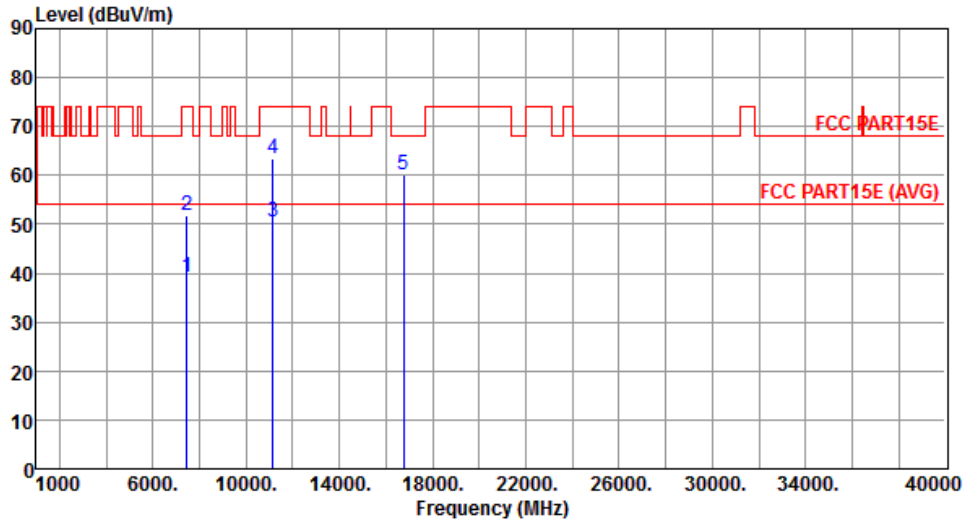

	Freq. MHz	Emission level dBuV/m	Limit dBuV/m	Margin dB	SA reading dBuV	Factor dB	Remark	ANT High cm	Turn Table deg
1	7440.00	39.10	54.00	-14.90	28.69	10.41	Average	185	333
2	7440.00	51.96	74.00	-22.04	41.55	10.41	Peak	185	333
3	11160.00	50.32	54.00	-3.68	34.18	16.14	Average	281	115
4	11160.00	63.48	74.00	-10.52	47.34	16.14	Peak	281	115
5	16740.00	60.12	68.20	-8.08	41.64	18.48	Peak	200	137

Note 1: Emission Level (dBuV/m) = SA Reading (dBuV/m) + Factor* (dB)

*Factor includes antenna factor , cable loss and amplifier gain

Note 2: Margin (dB) = Emission level (dBuV/m) – Limit (dBuV/m).

Modulation	HT20	Test Freq. (MHz)	5580
Polarization	Vertical	Test Configuration	4

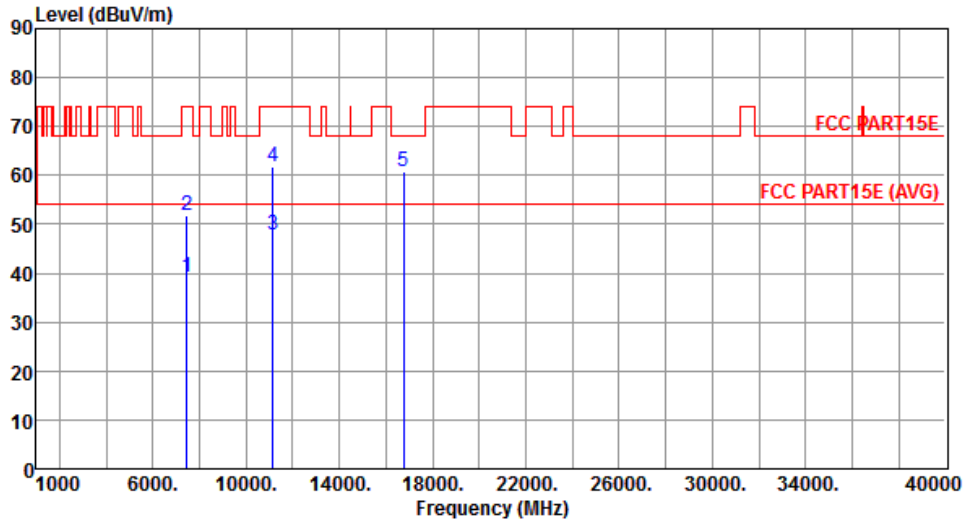

	Freq. MHz	Emission level dBuV/m	Limit dBuV/m	Margin dB	SA reading dBuV	Factor dB	Remark	ANT High cm	Turn Table deg
1	7440.00	39.24	54.00	-14.76	28.83	10.41	Average	221	46
2	7440.00	51.92	74.00	-22.08	41.51	10.41	Peak	221	46
3	11160.00	47.72	54.00	-6.28	31.58	16.14	Average	200	161
4	11160.00	61.78	74.00	-12.22	45.64	16.14	Peak	200	161
5	16740.00	60.88	68.20	-7.32	42.40	18.48	Peak	148	350

Note 1: Emission Level (dBuV/m) = SA Reading (dBuV/m) + Factor* (dB)

*Factor includes antenna factor , cable loss and amplifier gain

Note 2: Margin (dB) = Emission level (dBuV/m) – Limit (dBuV/m).

Modulation	HT20	Test Freq. (MHz)	5700
Polarization	Horizontal	Test Configuration	4

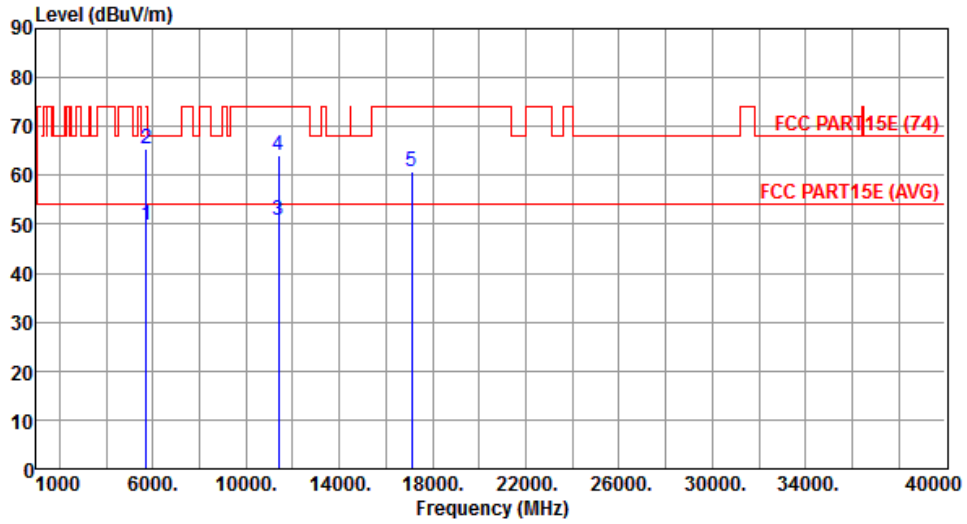

	Freq. MHz	Emission level dBuV/m	Limit dBuV/m	Margin dB	SA reading dBuV	Factor dB	Remark	ANT High cm	Turn Table deg
1	5725.00	49.79	54.00	-4.21	43.08	6.71	Average	145	221
2	5725.00	65.44	74.00	-8.56	58.73	6.71	Peak	145	221
3	11400.00	50.87	54.00	-3.13	34.68	16.19	Average	271	130
4	11400.00	64.03	74.00	-9.97	47.84	16.19	Peak	271	130
5	17100.00	60.75	74.00	-13.25	40.59	20.16	Peak	223	146

Note 1: Emission Level (dBuV/m) = SA Reading (dBuV/m) + Factor* (dB)

*Factor includes antenna factor , cable loss and amplifier gain

Note 2: Margin (dB) = Emission level (dBuV/m) – Limit (dBuV/m).

Modulation	HT20	Test Freq. (MHz)	5700
Polarization	Vertical	Test Configuration	4

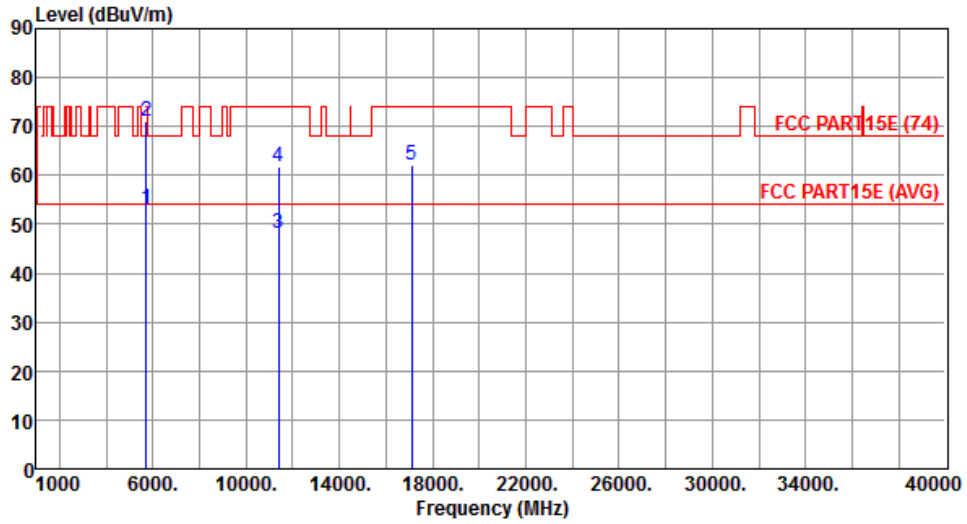

	Freq. MHz	Emission level dBuV/m	Limit dBuV/m	Margin dB	SA reading dBuV	Factor dB	Remark	ANT High cm	Turn Table deg
1	5725.00	52.98	54.00	-1.02	46.27	6.71	Average	219	177
2	5725.00	71.13	74.00	-2.87	64.42	6.71	Peak	219	177
3	11400.00	48.12	54.00	-5.88	31.93	16.19	Average	210	169
4	11400.00	61.83	74.00	-12.17	45.64	16.19	Peak	210	169
5	17100.00	62.00	74.00	-12.00	41.84	20.16	Peak	148	342

Note 1: Emission Level (dBuV/m) = SA Reading (dBuV/m) + Factor* (dB)

*Factor includes antenna factor , cable loss and amplifier gain

Note 2: Margin (dB) = Emission level (dBuV/m) – Limit (dBuV/m).

4 Test laboratory information

Established in 2012, ICC provides foremost EMC & RF Testing and advisory consultation services by our skilled engineers and technicians. Our services employ a wide variety of advanced edge test equipment and one of the widest certification extents in the business.

International Certification Corp, it is our definitive objective is to institute long term, trust-based associations with our clients. The expectation we set up with our clients is based on outstanding service, practical expertise and devotion to a certified value structure. Our passion is to grant our clients with best EMC / RF services by oriented knowledgeable and accommodating staff.

Our Test sites are located at Linkou District and Kwei Shan Hsiang. Location map can be found on our website <http://www.icertifi.com.tw>.

Linkou

Tel: 886-2-2601-1640

No. 30-2, Ding Fwu Tsuen, Lin
Kou District, New Taipei City,
Taiwan, R.O.C.

Kwei Shan

Tel: 886-3-271-8666

No. 3-1, Lane 6, Wen San 3rd St.,
Kwei Shan Hsiang, Tao Yuan
Hsien 333, Taiwan, R.O.C.

Kwei Shan Site II

Tel: 886-3-271-8640

No. 14-1, Lane 19, Wen San 3rd
St., Kwei Shan Hsiang, Tao Yuan
Hsien 333, Taiwan, R.O.C.

If you have any suggestion, please feel free to contact us as below information

Tel: 886-3-271-8666

Fax: 886-3-318-0155

Email: ICC_Service@icertifi.com.tw

==END==