

FCC Test Report

FCC ID : SQG-SSD50NBT
Equipment : 802.11abgn 2x2 and Bluetooth 4.0 module
Model No. : SSD50NBT
Brand Name : Laird Technologies
Applicant : Laird Technologies
Address : 11160 Thompson Ave., Lenexa, Kansas 66219,
USA
Standard : 47 CFR FCC Part 15.247
Received Date : Sep. 11, 2015
Tested Date : Dec. 11, 2015 ~ Jan. 12, 2016

We, International Certification Corp., would like to declare that the tested sample has been evaluated and in compliance with the requirement of the above standards. The test results contained in this report refer exclusively to the product. It may be duplicated completely for legal use with the approval of the applicant. It shall not be reproduced except in full without the written approval of our laboratory.

Approved & Reviewed by:



Gary Chang / Manager



Table of Contents

1	GENERAL DESCRIPTION	5
1.1	Information.....	5
1.2	Local Support Equipment List	7
1.3	Test Setup Chart	7
1.4	The Equipment List	8
1.5	Test Standards	9
1.6	Measurement Uncertainty	9
2	TEST CONFIGURATION	10
2.1	Testing Condition	10
2.2	The Worst Test Modes and Channel Details	10
3	TRANSMITTER TEST RESULTS.....	11
3.1	Conducted Emissions.....	11
3.2	Unwanted Emissions into Restricted Frequency Bands	14
3.3	Unwanted Emissions into Non-Restricted Frequency Bands	58
3.4	Conducted Output Power	63
3.5	Number of Hopping Frequency	65
3.6	20dB and Occupied Bandwidth	67
3.7	Channel Separation.....	69
3.8	Number of Dwell Time.....	71
4	TEST LABORATORY INFORMATION	74

Release Record

Report No.	Version	Description	Issued Date
FR5D1002AD	Rev. 01	Initial issue	Feb. 16, 2016

Summary of Test Results

FCC Rules	Test Items	Measured	Result
15.207	Conducted Emissions	[dBuV]: 20.056MHz 21.64 (Margin -28.36dB) - AV	Pass
15.247(d) 15.209	Radiated Emissions	[dBuV/m at 3m]: 2483.50MHz 50.48 (Margin -3.52dB) - AV	Pass
15.247(d)	Band Edge	Meet the requirement of limit	Pass
15.247(b)(1)	Conducted Output Power	Power [dBm]: 7.56	Pass
15.247(a)(1)(iii)	Number of Hopping Channels	Meet the requirement of limit	Pass
15.247(a)(1)	Hopping Channel Separation	Meet the requirement of limit	Pass
15.247(a)(1)(iii)	Dwell Time	Meet the requirement of limit	Pass
15.203	Antenna Requirement	Meet the requirement of limit	Pass

1 General Description

1.1 Information

1.1.1 Specification of the Equipment under Test (EUT)

RF General Information				
Frequency Range (MHz)	Bluetooth Mode	Ch. Frequency (MHz)	Channel Number	Data Rate
2400-2483.5	BR	2402-2480	0-78 [79]	1 Mbps
2400-2483.5	EDR	2402-2480	0-78 [79]	2 Mbps
2400-2483.5	EDR	2402-2480	0-78 [79]	3 Mbps

Note 1: RF output power specifies that Maximum Peak Conducted Output Power.
 Note 2: Bluetooth BR uses a GFSK.
 Note 3: Bluetooth EDR uses a combination of $\pi/4$ -DQPSK and 8DPSK.

1.1.2 Antenna Details

Ant. No.	Model	Type	Connector	Operating Frequencies (MHz) / Antenna Gain (dBi)				
				2400~2483.5	5150~5250	5250~5350	5470~5725	5725~5850
1	Laird MAF94051	Dipole	RP-SMA	2.1	2.4	2.6	3.4	3.4
2	Laird NanoBlade-IP04	PCB Dipole	IPEX MHF	2	3.9	3.9	4	4
3	Laird MAF95310 Mini NanoBlade Flex	PCB Dipole	IPEX MHF	2.79	3.38	3.38	3.38	3.38
4	Laird NanoBlue-IP04	PCB Dipole	IPEX MHF	2	---	---	---	---
5	Ethertronics WLAN_1000146	Isolated Magnetic Dipole	IPEX MHF	2.5	3.5	3.5	3.5	3.5

Note: Ant. No. 1, 3 & 5 were for 2.4G final test.

Ant. No. 1, 2 & 5 were for 5G final test.

1.1.3 Power Supply Type of Equipment under Test (EUT)

Power Supply Type	3.3Vdc from host
--------------------------	------------------

1.1.4 Channel List

Frequency band (MHz)				2400~2483.5			
Channel	Frequency (MHz)	Channel	Frequency (MHz)	Channel	Frequency (MHz)	Channel	Frequency (MHz)
0	2402	20	2422	40	2442	60	2462
1	2403	21	2423	41	2443	61	2463
2	2404	22	2424	42	2444	62	2464
3	2405	23	2425	43	2445	63	2465
4	2406	24	2426	44	2446	64	2466
5	2407	25	2427	45	2447	65	2467
6	2408	26	2428	46	2448	66	2468
7	2409	27	2429	47	2449	67	2469
8	2410	28	2430	48	2450	68	2470
9	2411	29	2431	49	2451	69	2471
10	2412	30	2432	50	2452	70	2472
11	2413	31	2433	51	2453	71	2473
12	2414	32	2434	52	2454	72	2474
13	2415	33	2435	53	2455	73	2475
14	2416	34	2436	54	2456	74	2476
15	2417	35	2437	55	2457	75	2477
16	2418	36	2438	56	2458	76	2478
17	2419	37	2439	57	2459	77	2479
18	2420	38	2440	58	2460	78	2480
19	2421	39	2441	59	2461	---	---

1.1.5 Test Tool and Duty Cycle

Test Tool	BlueSuite, V2.5.8
-----------	-------------------

1.1.6 Power Setting

Modulation Mode	Test Frequency (MHz)		
	2402	2441	2480
GFSK/1Mbps	63	63	63
$\pi/4$ -DQPSK/2Mbps	63	63	63
8DPSK/3Mbps	63	63	63

1.2 Local Support Equipment List

Support Equipment List						
No.	Equipment	Brand	Model	S/N	FCC ID	Signal cable / Length (m)
1	DC Power Supply	GW INSTEK	GPC-3060D	EM884797	---	---
2	Notebook	DELL	Latitude E6430	9ZFB4X1	DoC	---
3	Fixture	---	---	---	---	---

Note: Fixture is provided by applicant.

1.3 Test Setup Chart

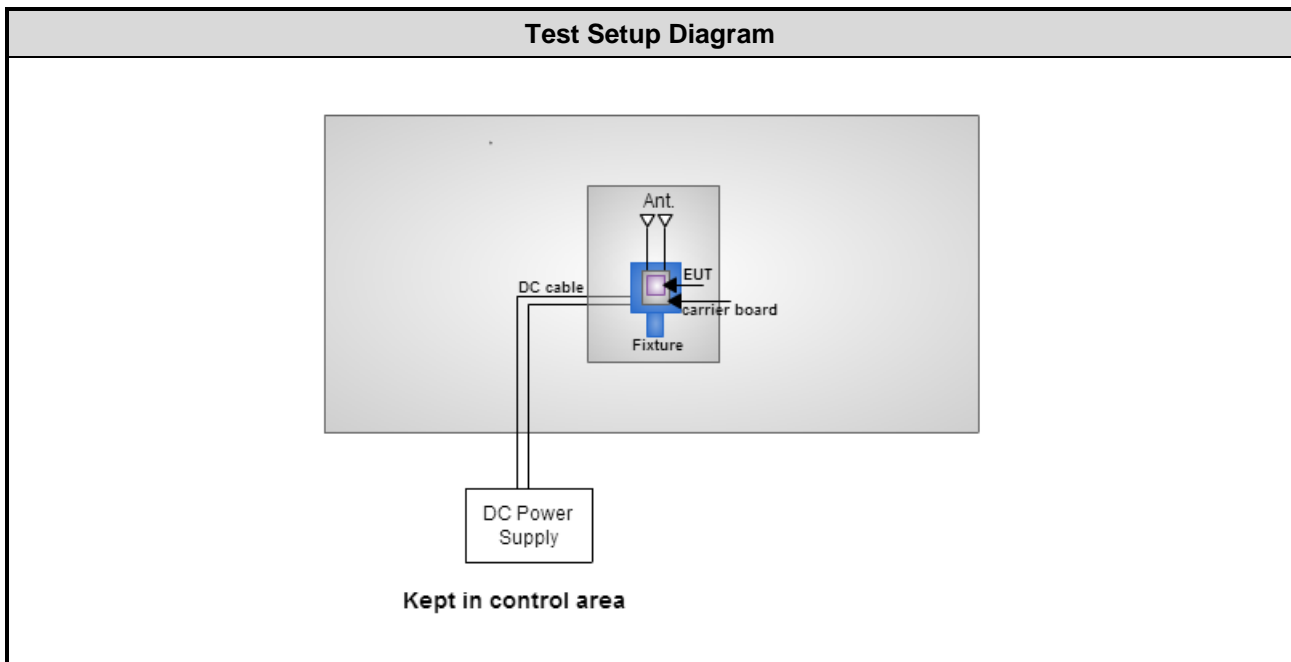

Note: The support notebook was disconnected from EUT and removed from test table when EUT is set to transmit continuously.

1.4 The Equipment List

Test Item	Conducted Emission				
Test Site	Conduction room 1 / (CO01-WS)				
Tested Date	Jan. 06, 2016				
Instrument	Manufacturer	Model No.	Serial No.	Calibration Date	Calibration Until
EMC Receiver	R&S	ESCS 30	100169	Oct. 21, 2015	Oct. 20, 2016
LISN	SCHWARZBECK	Schwarzbeck 8127	8127-667	Nov. 13, 2015	Nov. 12, 2016
RF Cable-CON	EMC	EMCCFD300-BM-BM-6000	50821	Dec. 21, 2015	Dec. 20, 2016
Measurement Software	AUDIX	e3	6.120210k	NA	NA
Note: Calibration Interval of instruments listed above is one year.					

Test Item	Radiated Emission				
Test Site	966 chamber 3 / (03CH03-WS)				
Tested Date	Dec. 11 ~ Dec. 28, 2015				
Instrument	Manufacturer	Model No.	Serial No.	Calibration Date	Calibration Until
Spectrum Analyzer	Agilent	N9010A	MY53400091	Sep. 14, 2015	Sep. 13, 2016
Receiver	Agilent	N9038A	MY53290044	Oct. 14, 2015	Oct. 13, 2016
Bilog Antenna	SCHWARZBECK	VULB9168	VULB9168-563	Dec. 30, 2014	Dec. 29, 2015
Horn Antenna 1G-18G	SCHWARZBECK	BBHA 9120 D	BBHA 9120 D 1206	Feb. 03, 2015	Feb. 02, 2016
Horn Antenna 18G-40G	SCHWARZBECK	BBHA 9170	BBHA 9170517	Nov. 04, 2015	Nov. 03, 2016
Preamplifier	EMC	EMC02325	980187	Sep. 21, 2015	Sep. 20, 2016
Preamplifier	Agilent	83017A	MY53270014	Sep. 07, 2015	Sep. 06, 2016
Preamplifier	EMC	EMC184045B	980192	Sep. 01, 2015	Aug. 31, 2016
RF cable-3M	HUBER+SUHNER	SUCOFLEX104	MY22620/4	Feb. 09, 2015	Feb. 08, 2016
RF cable-8M	HUBER+SUHNER	SUCOFLEX104	MY22600/4	Feb. 09, 2015	Feb. 08, 2016
RF cable-1M	HUBER+SUHNER	SUCOFLEX104	MY22624/4	Feb. 09, 2015	Feb. 08, 2016
LF cable-0.8M	EMC	EMC8D-NM-NM-800	EMC8D-NM-NM-800-001	Feb. 09, 2015	Feb. 08, 2016
LF cable-3M	EMC	EMC8D-NM-NM-3000	131103	Feb. 09, 2015	Feb. 08, 2016
LF cable-13M	EMC	EMC8D-NM-NM-13000	131104	Feb. 09, 2015	Feb. 08, 2016
Measurement Software	AUDIX	e3	6.120210g	NA	NA
Note: Calibration Interval of instruments listed above is one year.					

Test Item	RF Conducted				
Test Site	(TH01-WS)				
Tested Date	Jan. 12, 2016				
Instrument	Manufacturer	Model No.	Serial No.	Calibration Date	Calibration Until
Spectrum Analyzer	R&S	FSV40	101063	Feb. 03, 2015	Feb. 02, 2016
Power Meter	Anritsu	ML2495A	1241002	Sep. 21, 2015	Sep. 20, 2016
Power Sensor	Anritsu	MA2411B	1207366	Sep. 21, 2015	Sep. 20, 2016
DC POWER SOURCE	GW INSTEK	GPC-3060D	EM884797	Oct. 20, 2015	Oct. 19, 2016
Measurement Software	Sporton	Sporton_1	1.3.30	NA	NA
Note: Calibration Interval of instruments listed above is one year.					

1.5 Test Standards

According to the specification of EUT, the EUT must comply with following standards and KDB documents.

47 CFR FCC Part 15.247

FCC Public notice DA 00-705

ANSI C63.10-2013

1.6 Measurement Uncertainty

ISO/IEC 17025 requires that an estimate of the measurement uncertainties associated with the emissions test results be included in the report. The measurement uncertainties given below are based on a 95% confidence level (based on a coverage factor (k=2))

Measurement Uncertainty	
Parameters	Uncertainty
Bandwidth	±34.134 Hz
Conducted power	±0.808 dB
Power density	±0.463 dB
Conducted emission	±2.670 dB
AC conducted emission	±2.90 dB
Radiated emission ≤ 1GHz	±3.66 dB
Radiated emission > 1GHz	±5.37 dB

2 Test Configuration

2.1 Testing Condition

Test Item	Test Site	Ambient Condition	Tested By
AC Conduction	CO01-WS	20°C / 60%	Peter Lin
Radiated Emissions	03CH03-WS	20-22°C / 64-65%	Warren Lee Felix Sung
RF Conducted	TH01-WS	23°C / 65%	Alex Huang

➤ FCC site registration No.: 390588

➤ IC site registration No.: 10807C-1

2.2 The Worst Test Modes and Channel Details

Test item	Mode	Test Frequency (MHz)	Data Rate (Mbps)	Test Configuration
Conducted Emissions	GFSK	2441	1Mbps	2
Radiated Emissions ≤ 1GHz	GFSK	2441	1Mbps	1, 2, 3
Radiated Emissions > 1GHz	GFSK 8DPSK	2402, 2441, 2480 2402, 2441, 2480	1Mbps 3Mbps	1, 2, 3
Conducted Output Power	GFSK π/4 QDPSK 8DPSK	2402, 2441, 2480 2402, 2441, 2480 2402, 2441, 2480	1Mbps 2Mbps 3Mbps	2
Number of Hopping Channels	GFSK 8DPSK	2402~2480 2402~2480	1Mbps 3Mbps	2
Hopping Channel Separation	GFSK 8DPSK	2402, 2441, 2480 2402, 2441, 2480	1Mbps 3Mbps	2
Dwell Time	GFSK 8DPSK	2402 2402	1Mbps 3Mbps	2

NOTE:

- The EUT was pretested with 3 orientations placed on the table for the radiated emission measurement – X, Y, and Z-plane. The **Y-plane** results were found as the worst case and were shown in this report.
- The following antennas are used for final testing for this module: (See item 1.1.2 for more details.)
 - Configuration 1 : Dipole antenna
 - Configuration 2 : PCB Dipole antenna
 - Configuration 3 : Isolated Magnetic Dipole antenna

3 Transmitter Test Results

3.1 Conducted Emissions

3.1.1 Limit of Conducted Emissions

Conducted Emissions Limit		
Frequency Emission (MHz)	Quasi-Peak	Average
0.15-0.5	66 - 56 *	56 - 46 *
0.5-5	56	46
5-30	60	50

Note 1: * Decreases with the logarithm of the frequency.

3.1.2 Test Procedures

1. The device is placed on a test table, raised 80 cm above the reference ground plane. The vertical conducting plane is located 40 cm to the rear of the device.
2. The device is connected to line impedance stabilization network (LISN) and other accessories are connected to other LISN. Measured levels of AC power line conducted emission are across the 50 Ω LISN port.
3. AC conducted emission measurements is made over frequency range from 150 kHz to 30 MHz.
4. This measurement was performed with AC 120V/60Hz

3.1.3 Test Setup

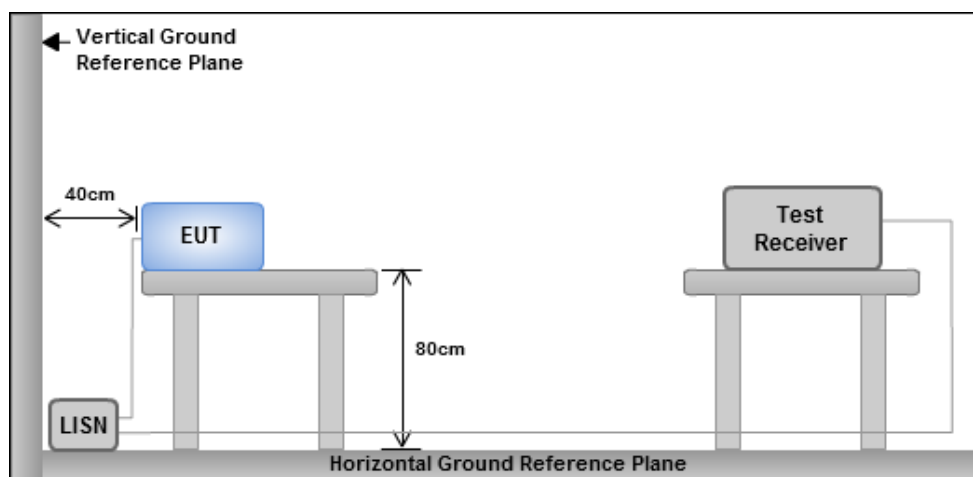

Note: 1. Support units were connected to second LISN.

2. Both of LISNs (AMN) are 80 cm from EUT and at least 80 cm from other units and other metal planes

3.1.4 Test Result of Conducted Emissions

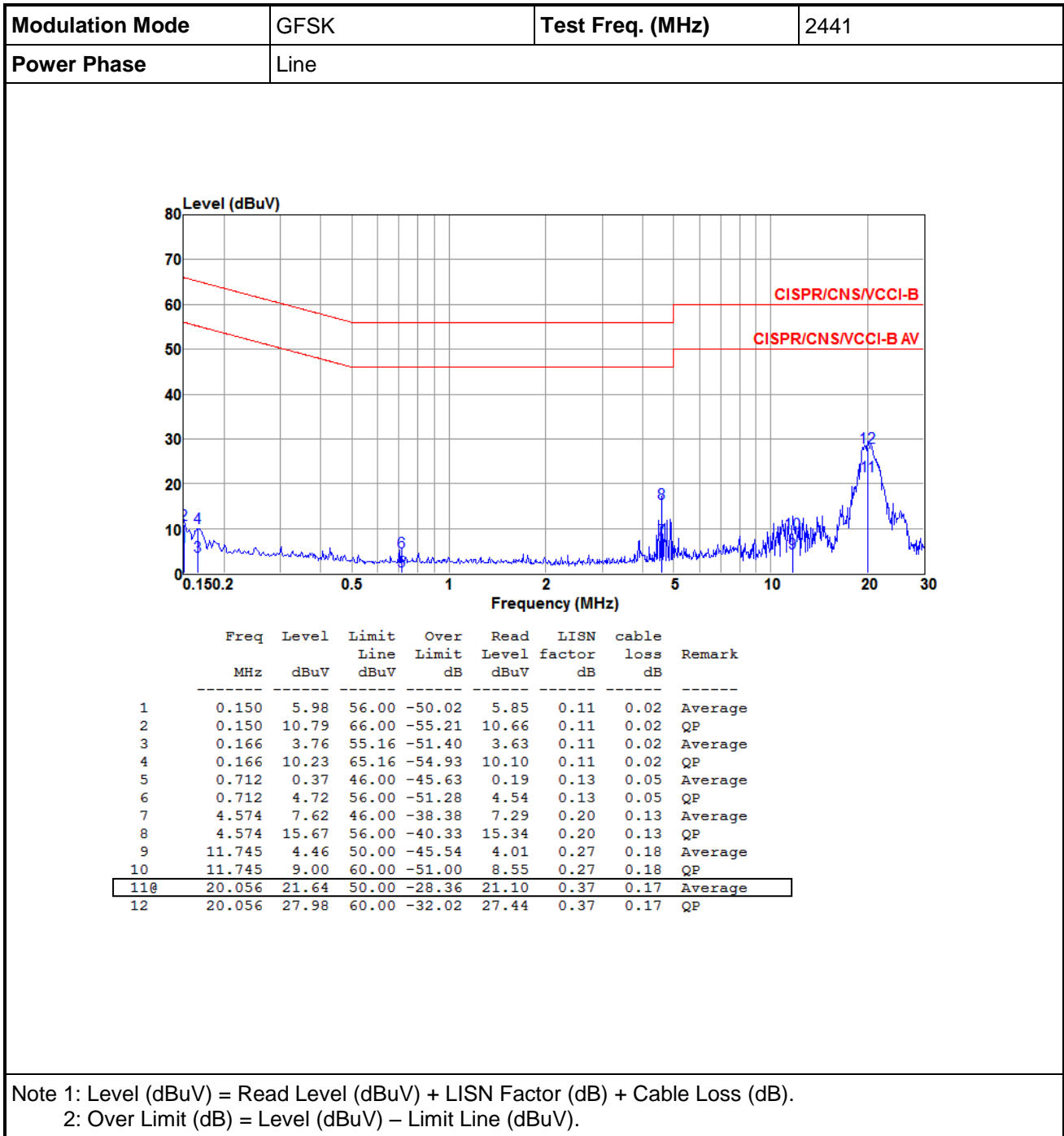

Modulation Mode	GFSK	Test Freq. (MHz)	2441
Power Phase	Neutral		

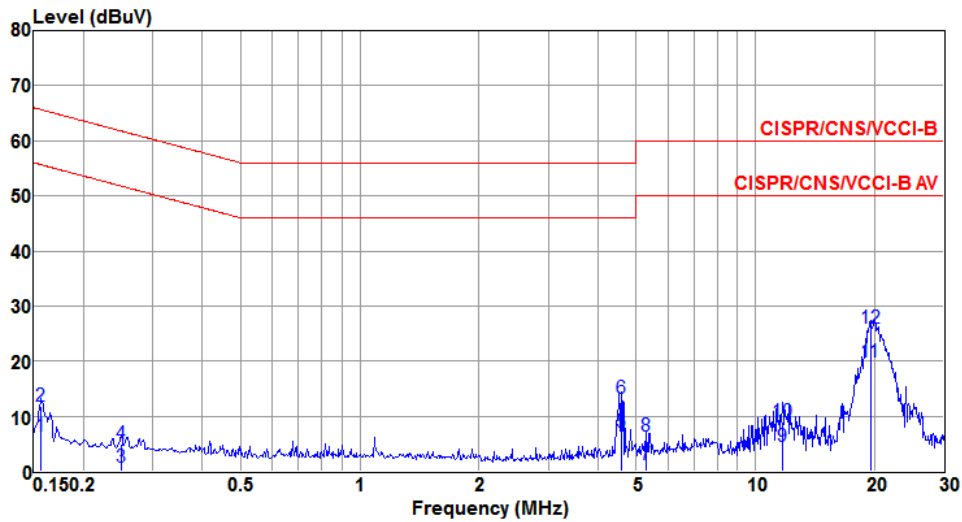

	Freq	Level	Limit	Over	Read	LISN	cable	Remark
	MHz	dBuV	Line	Limit	Level	factor	loss	
			dBuV	dB	dBuV	dB	dB	
1	0.156	6.28	55.65	-49.37	6.13	0.13	0.02	Average
2	0.156	11.70	65.65	-53.95	11.55	0.13	0.02	QP
3	0.249	0.67	51.78	-51.11	0.54	0.11	0.02	Average
4	0.249	4.99	61.78	-56.79	4.86	0.11	0.02	QP
5	4.598	7.04	46.00	-38.96	6.72	0.19	0.13	Average
6	4.598	13.24	56.00	-42.76	12.92	0.19	0.13	QP
7	5.277	1.12	50.00	-48.88	0.79	0.20	0.13	Average
8	5.277	6.49	60.00	-53.51	6.16	0.20	0.13	QP
9	11.745	4.43	50.00	-45.57	3.95	0.30	0.18	Average
10	11.745	8.89	60.00	-51.11	8.41	0.30	0.18	QP
11@	19.532	19.94	50.00	-30.06	19.37	0.40	0.17	Average
12	19.532	25.86	60.00	-34.14	25.29	0.40	0.17	QP

Note 1: Level (dBuV) = Read Level (dBuV) + LISN Factor (dB) + Cable Loss (dB).
 2: Over Limit (dB) = Level (dBuV) – Limit Line (dBuV).

3.2 Unwanted Emissions into Restricted Frequency Bands

3.2.1 Limit of Unwanted Emissions into Restricted Frequency Bands

Restricted Band Emissions Limit			
Frequency Range (MHz)	Field Strength (uV/m)	Field Strength (dBuV/m)	Measure Distance (m)
0.009~0.490	2400/F(kHz)	48.5 - 13.8	300
0.490~1.705	24000/F(kHz)	33.8 - 23	30
1.705~30.0	30	29	30
30~88	100	40	3
88~216	150	43.5	3
216~960	200	46	3
Above 960	500	54	3

Note 1:
Qusai-Peak value is measured for frequency below 1GHz except for 9–90 kHz, 110–490 kHz frequency band. Peak and average value are measured for frequency above 1GHz. The limit on average radio frequency emission is as above table. The limit on peak radio frequency emissions is 20 dB above the maximum permitted average emission limit

Note 2:
Measurements may be performed at a distance other than what is specified provided. When performing measurements at a distance other than that specified, the results shall be extrapolated to the specified distance using an extrapolation factor as below, Frequency at or above 30 MHz: 20 dB/decade Frequency below 30 MHz: 40 dB/decade.

3.2.2 Test Procedures

1. Measurement is made at a semi-anechoic chamber that incorporates a turntable allowing a EUT rotation of 360°. A continuously-rotating, remotely-controlled turntable is installed at the test site to support the EUT and facilitate determination of the direction of maximum radiation for each EUT emission frequency. The EUT is placed at test table. For emissions testing at or below 1 GHz, the table height is 80 cm above the reference ground plane. For emission measurements above 1 GHz, the table height is 1.5 m
2. Measurement is made with the antenna positioned in both the horizontal and vertical planes of polarization. The measurement antenna is varied in height (1m ~ 4m) above the reference ground plane to obtain the maximum signal strength. Distance between EUT and antenna is 3 m.
3. This investigation is performed with the EUT rotated 360°, the antenna height scanned between 1 m and 4 m, and the antenna rotated to repeat the measurements for both the horizontal and vertical antenna polarizations.

Note:

1. 120kHz measurement bandwidth of test receiver and Quasi-peak detector is for radiated emission below 1GHz.
2. Radiated emission above 1GHz / Peak value
RBW=1MHz, VBW=3MHz and Peak detector
Radiated emission above 1GHz / Average value for harmonics
The average value is: Average = Peak value + 20log(Duty cycle) Where the duty factor is calculated from following formula for DH5 packet type which has worst duty factor:
3.
$$20\log (\text{Duty cycle}) = 20\log \frac{1\text{s} / 1600 * 5}{100 \text{ ms}} = -30.1\text{dB}$$
4. Radiated emission above 1GHz / Average value for other emissions
RBW=1MHz, VBW=1/T and Peak detector

3.2.3 Test Setup

Radiated Emissions below 1 GHz

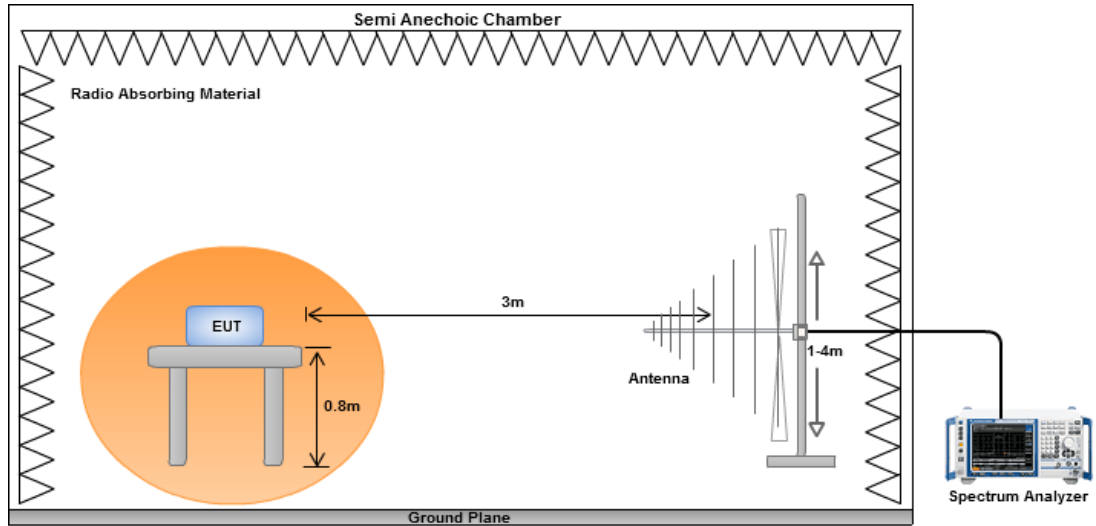

Radiated Emissions above 1 GHz

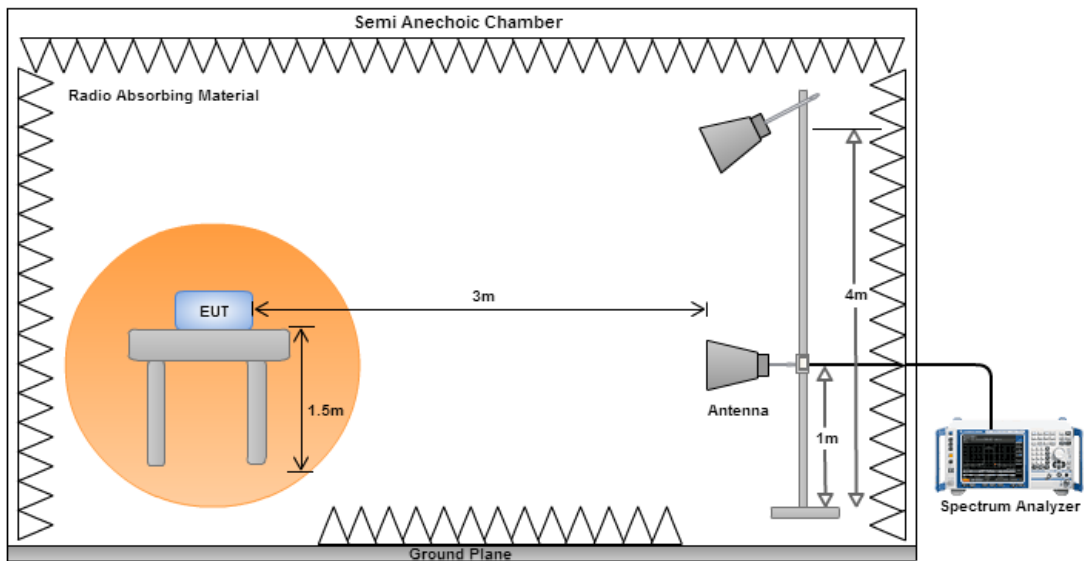

Test Configuration 1: Dipole antenna

3.2.4 Transmitter Radiated Unwanted Emissions (Below 1GHz)

Modulation	GFSK	Test Freq. (MHz)	2441
Polarization	Horizontal	Test Configuration	1

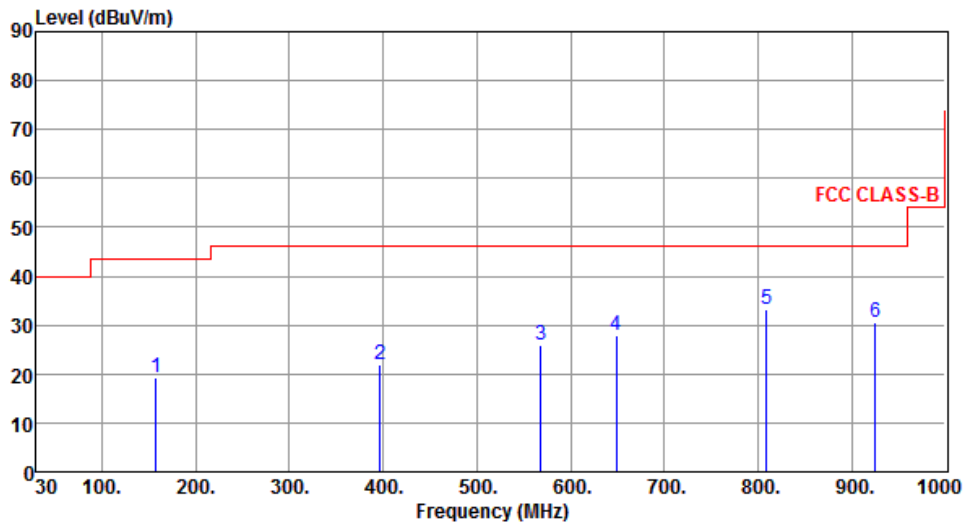

	Freq. MHz	Emission level dBuV/m	Limit dBuV/m	Margin dB	SA reading dBuV	Factor dB	Remark	ANT High cm	Turn Table deg
1	158.06	19.11	43.50	-24.39	32.69	-13.58	Peak	---	---
2	396.54	21.78	46.00	-24.22	31.91	-10.13	Peak	---	---
3	568.31	25.96	46.00	-20.04	32.59	-6.63	Peak	---	---
4	648.75	28.05	46.00	-17.95	33.12	-5.07	Peak	---	---
5	808.68	33.32	46.00	-12.68	35.81	-2.49	Peak	---	---
6	925.34	30.40	46.00	-15.60	30.67	-0.27	Peak	---	---

Note 1: Emission Level (dBuV/m) = SA Reading (dBuV/m) + Factor* (dB)

*Factor includes antenna factor , cable loss and amplifier gain

Note 2: Margin (dB) = Emission level (dBuV/m) – Limit (dBuV/m).

Note 3: All spurious emissions below 30MHz are more than 20 dB below the limit.

Modulation	GFSK	Test Freq. (MHz)	2441
Polarization	Vertical	Test Configuration	1

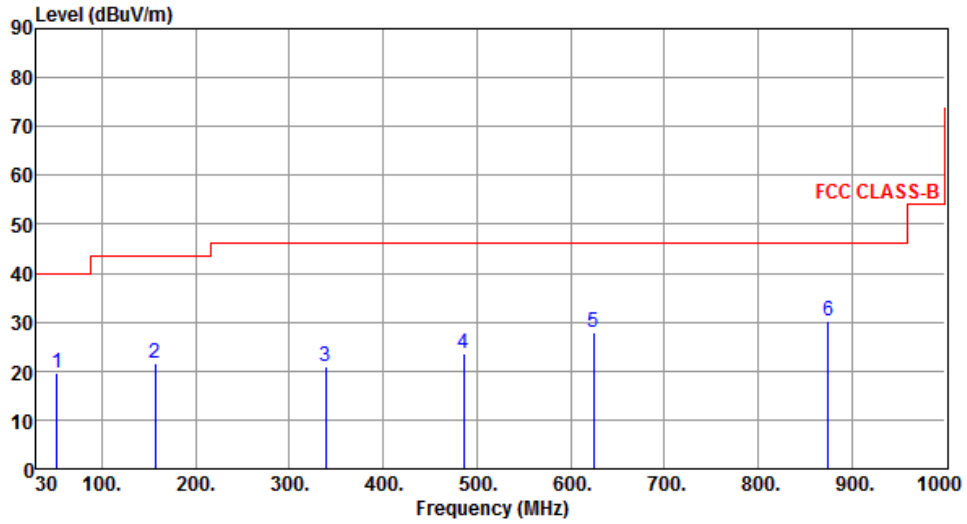

	Freq. MHz	Emission level dBuV/m	Limit dBuV/m	Margin dB	SA reading dBuV	Factor dB	Remark	ANT High cm	Turn Table deg
1	51.65	19.55	40.00	-20.45	32.73	-13.18	Peak	---	---
2	157.13	21.70	43.50	-21.80	35.27	-13.57	Peak	---	---
3	338.42	20.88	46.00	-25.12	32.65	-11.77	Peak	---	---
4	485.96	23.52	46.00	-22.48	31.49	-7.97	Peak	---	---
5	624.68	27.74	46.00	-18.26	33.18	-5.44	Peak	---	---
6	874.92	30.17	46.00	-15.83	31.43	-1.26	Peak	---	---

Note 1: Emission Level (dBuV/m) = SA Reading (dBuV/m) + Factor* (dB)

*Factor includes antenna factor , cable loss and amplifier gain

Note 2: Margin (dB) = Emission level (dBuV/m) – Limit (dBuV/m).

Note 3: All spurious emissions below 30MHz are more than 20 dB below the limit.

3.2.5 Transmitter Radiated Unwanted Emissions (Above 1GHz) for GFSK

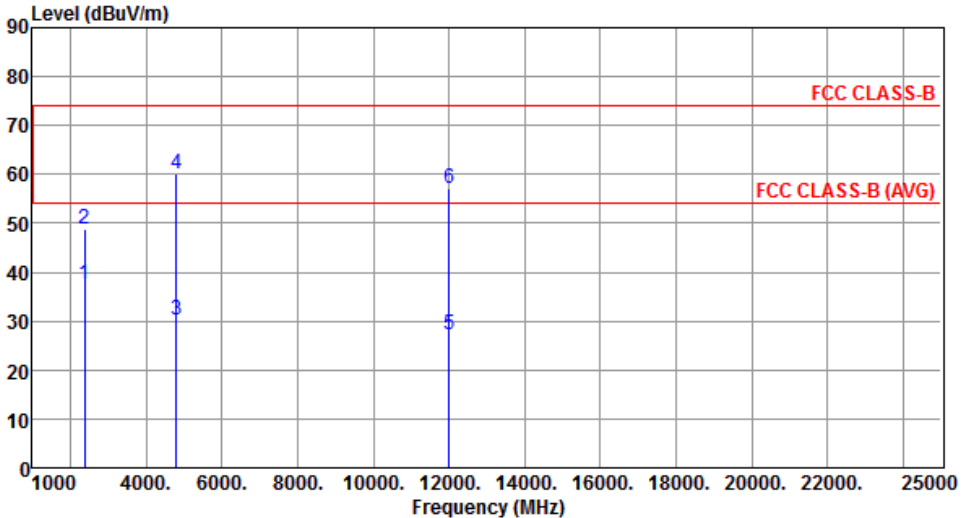
Modulation	GFSK	Test Freq. (MHz)	2402						
Polarization	Horizontal	Test Configuration	1						
									
	Freq.	Emission level	Limit	Margin	SA reading	Factor	Remark	ANT High	Turn Table
	MHz	dBuV/m	dBuV/m	dB	dBuV	dB		cm	deg
1	2390.00	37.53	54.00	-16.47	38.89	-1.36	Average	130	40
2	2390.00	48.89	74.00	-25.11	50.25	-1.36	Peak	130	40
3	4804.00	30.09	54.00	-23.91	24.16	5.93	Average	179	267
4	4804.00	60.19	74.00	-13.81	54.26	5.93	Peak	179	267
5	12010.00	27.16	54.00	-26.84	11.14	16.02	Average	278	150
6	12010.00	57.26	74.00	-16.74	41.24	16.02	Peak	278	150
<p>Note 1: Emission Level (dBuV/m) = SA Reading (dBuV/m) + Factor* (dB) *Factor includes antenna factor , cable loss and amplifier gain Note 2: Margin (dB) = Emission level (dBuV/m) – Limit (dBuV/m).</p>									

Modulation	GFSK	Test Freq. (MHz)	2402
Polarization	Vertical	Test Configuration	1

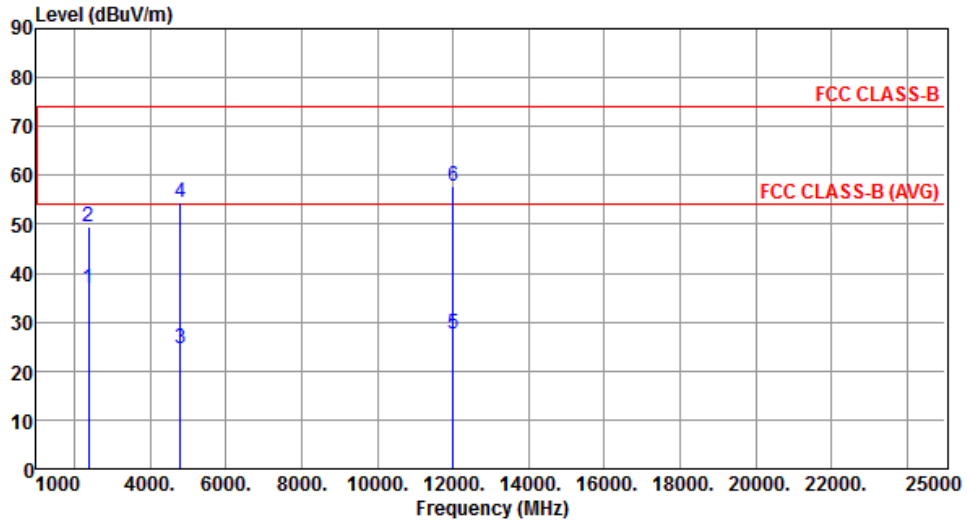

	Freq. MHz	Emission level dBuV/m	Limit dBuV/m	Margin dB	SA reading dBuV	Factor dB	Remark	ANT High cm	Turn Table deg
1	2390.00	36.92	54.00	-17.08	38.28	-1.36	Average	170	295
2	2390.00	49.48	74.00	-24.52	50.84	-1.36	Peak	170	295
3	4804.00	24.53	54.00	-29.47	18.60	5.93	Average	367	204
4	4804.00	54.63	74.00	-19.37	48.70	5.93	Peak	367	204
5	12010.00	27.59	54.00	-26.41	11.57	16.02	Average	293	177
6	12010.00	57.69	74.00	-16.31	41.67	16.02	Peak	293	177

Note 1: Emission Level (dBuV/m) = SA Reading (dBuV/m) + Factor* (dB)

*Factor includes antenna factor , cable loss and amplifier gain

Note 2: Margin (dB) = Emission level (dBuV/m) – Limit (dBuV/m).

Modulation	GFSK	Test Freq. (MHz)	2441
Polarization	Horizontal	Test Configuration	1

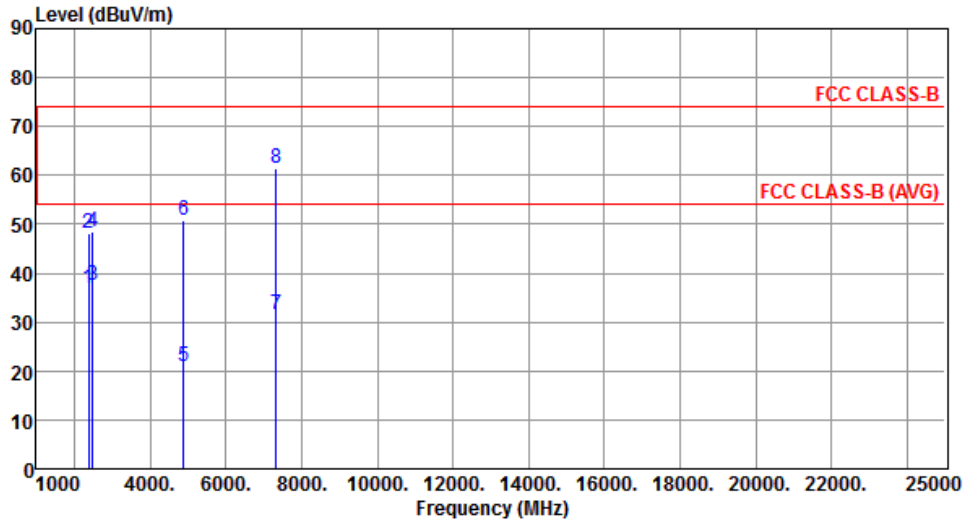

	Freq. MHz	Emission level dBuV/m	Limit dBuV/m	Margin dB	SA reading dBuV	Factor dB	Remark	ANT High cm	Turn Table deg
1	2390.00	36.89	54.00	-17.11	38.25	-1.36	Average	164	145
2	2390.00	47.99	74.00	-26.01	49.35	-1.36	Peak	164	145
3	2483.50	37.67	54.00	-16.33	38.69	-1.02	Average	164	145
4	2483.50	48.60	74.00	-25.40	49.62	-1.02	Peak	164	145
5	4882.00	20.80	54.00	-33.20	14.82	5.98	Average	327	65
6	4882.00	50.90	74.00	-23.10	44.92	5.98	Peak	327	65
7	7323.00	31.46	54.00	-22.54	20.69	10.77	Average	154	340
8	7323.00	61.56	74.00	-12.44	50.79	10.77	Peak	154	340

Note 1: Emission Level (dBuV/m) = SA Reading (dBuV/m) + Factor* (dB)

*Factor includes antenna factor , cable loss and amplifier gain

Note 2: Margin (dB) = Emission level (dBuV/m) – Limit (dBuV/m).

Modulation	GFSK	Test Freq. (MHz)	2441
Polarization	Vertical	Test Configuration	1

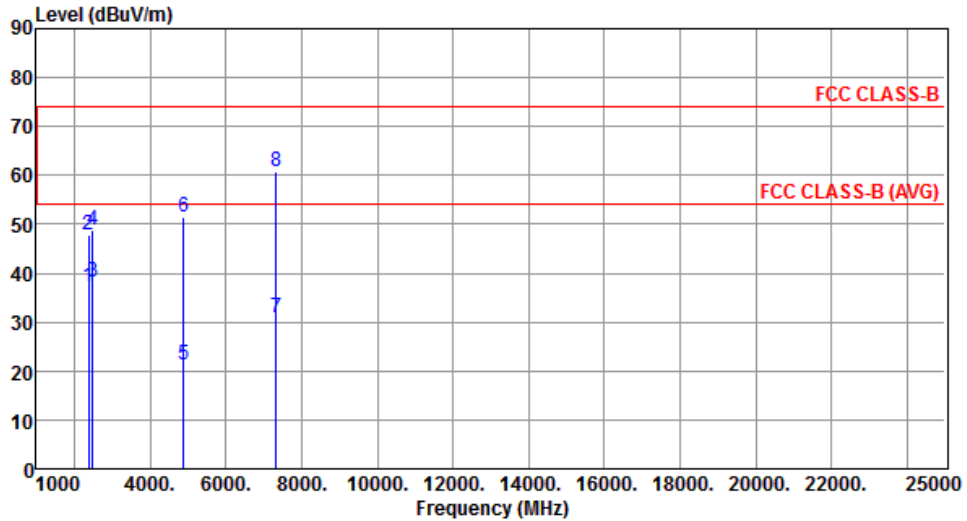

	Freq. MHz	Emission level dBuV/m	Limit dBuV/m	Margin dB	SA reading dBuV	Factor dB	Remark	ANT High cm	Turn Table deg
1	2390.00	37.19	54.00	-16.81	38.55	-1.36	Average	392	284
2	2390.00	47.84	74.00	-26.16	49.20	-1.36	Peak	392	284
3	2483.50	38.23	54.00	-15.77	39.25	-1.02	Average	392	284
4	2483.50	48.96	74.00	-25.04	49.98	-1.02	Peak	392	284
5	4882.00	21.27	54.00	-32.73	15.29	5.98	Average	180	226
6	4882.00	51.37	74.00	-22.63	45.39	5.98	Peak	180	226
7	7323.00	30.73	54.00	-23.27	19.65	11.08	Average	196	106
8	7323.00	60.83	74.00	-13.17	50.06	10.77	Peak	196	106

Note 1: Emission Level (dBuV/m) = SA Reading (dBuV/m) + Factor* (dB)

*Factor includes antenna factor , cable loss and amplifier gain

Note 2: Margin (dB) = Emission level (dBuV/m) – Limit (dBuV/m).

Modulation	GFSK	Test Freq. (MHz)	2480
Polarization	Horizontal	Test Configuration	1

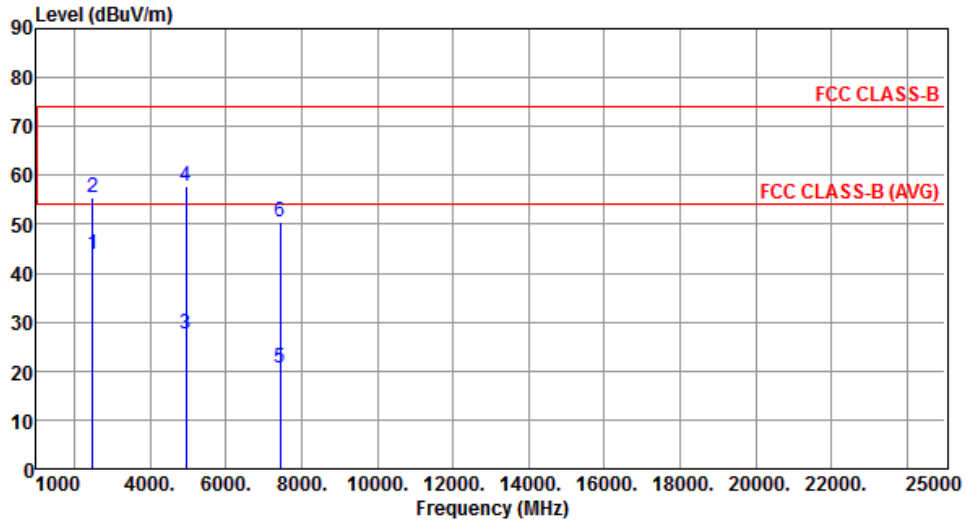

	Freq. MHz	Emission level dBuV/m	Limit dBuV/m	Margin dB	SA reading dBuV	Factor dB	Remark	ANT High cm	Turn Table deg
1	2483.50	43.74	54.00	-10.26	44.76	-1.02	Average	123	154
2	2483.50	55.57	74.00	-18.43	56.59	-1.02	Peak	123	154
3	4960.00	27.62	54.00	-26.38	21.59	6.03	Average	177	274
4	4960.00	57.72	74.00	-16.28	51.69	6.03	Peak	177	274
5	7440.00	20.50	54.00	-33.50	9.48	11.02	Average	274	269
6	7440.00	50.60	74.00	-23.40	39.58	11.02	Peak	274	269

Note 1: Emission Level (dBuV/m) = SA Reading (dBuV/m) + Factor* (dB)

*Factor includes antenna factor , cable loss and amplifier gain

Note 2: Margin (dB) = Emission level (dBuV/m) – Limit (dBuV/m).

Modulation	GFSK	Test Freq. (MHz)	2480
Polarization	Vertical	Test Configuration	1

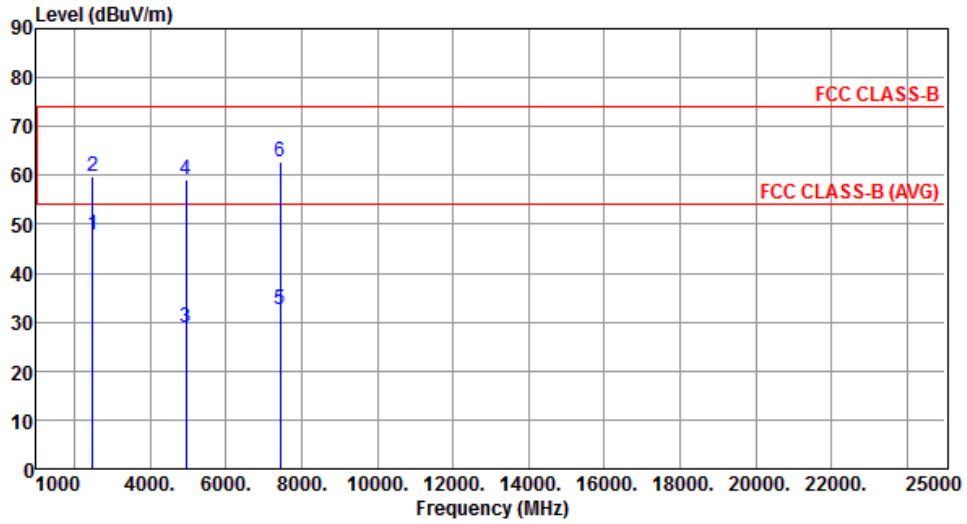

	Freq. MHz	Emission level dBuV/m	Limit dBuV/m	Margin dB	SA reading dBuV	Factor dB	Remark	ANT High cm	Turn Table deg
1	2483.50	47.97	54.00	-6.03	48.99	-1.02	Average	400	291
2	2483.50	59.70	74.00	-14.30	60.72	-1.02	Peak	400	291
3	4960.00	29.03	54.00	-24.97	23.00	6.03	Average	273	199
4	4960.00	59.13	74.00	-14.87	53.10	6.03	Peak	273	199
5	7440.00	32.68	54.00	-21.32	21.66	11.02	Average	198	206
6	7440.00	62.78	74.00	-11.22	51.76	11.02	Peak	198	206

Note 1: Emission Level (dBuV/m) = SA Reading (dBuV/m) + Factor* (dB)

*Factor includes antenna factor , cable loss and amplifier gain

Note 2: Margin (dB) = Emission level (dBuV/m) – Limit (dBuV/m).

3.2.6 Transmitter Radiated Unwanted Emissions (Above 1GHz) for 8DPSK

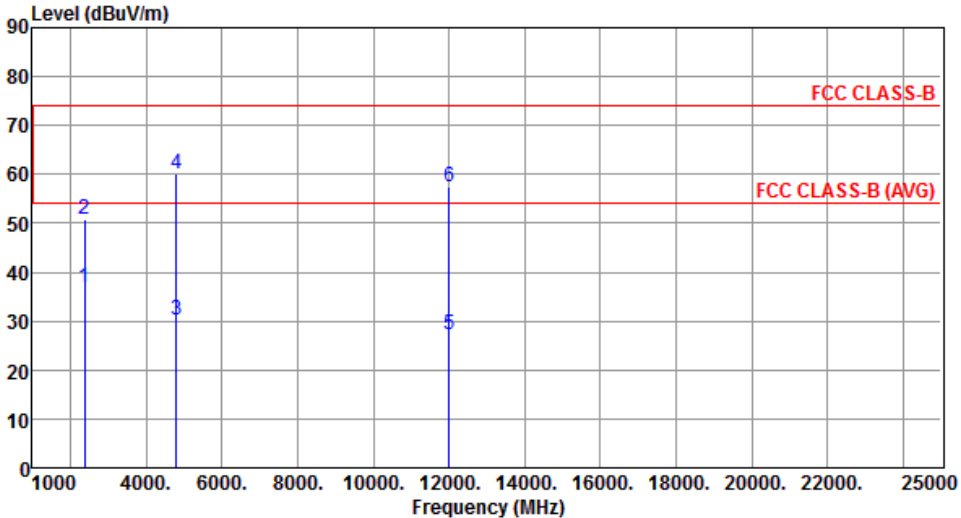
Modulation	8DPSK	Test Freq. (MHz)	2402						
Polarization	Horizontal	Test Configuration	1						
									
	Freq.	Emission level	Limit	Margin	SA reading	Factor	Remark	ANT High	Turn Table
	MHz	dBuV/m	dBuV/m	dB	dBuV	dB		cm	deg
1	2390.00	36.89	54.00	-17.11	38.25	-1.36	Average	131	41
2	2390.00	50.81	74.00	-23.19	52.17	-1.36	Peak	131	41
3	4804.00	30.09	54.00	-23.91	24.16	5.93	Average	179	267
4	4804.00	60.19	74.00	-13.81	54.26	5.93	Peak	179	267
5	12010.00	27.25	54.00	-26.75	10.58	16.67	Average	278	150
6	12010.00	57.35	74.00	-16.65	41.33	16.02	Peak	278	150
<p>Note 1: Emission Level (dBuV/m) = SA Reading (dBuV/m) + Factor* (dB) *Factor includes antenna factor , cable loss and amplifier gain Note 2: Margin (dB) = Emission level (dBuV/m) – Limit (dBuV/m).</p>									

Modulation	8DPSK	Test Freq. (MHz)	2402
Polarization	Vertical	Test Configuration	1

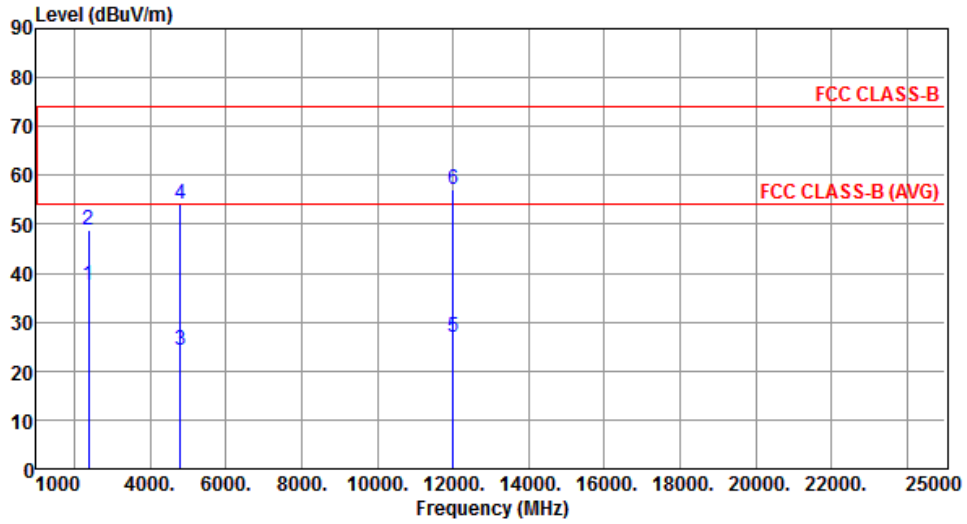

	Freq. MHz	Emission level dBuV/m	Limit dBuV/m	Margin dB	SA reading dBuV	Factor dB	Remark	ANT High cm	Turn Table deg
1	2390.00	37.53	54.00	-16.47	38.89	-1.36	Average	169	297
2	2390.00	48.92	74.00	-25.08	50.28	-1.36	Peak	169	297
3	4804.00	24.19	54.00	-29.81	18.26	5.93	Average	351	194
4	4804.00	54.29	74.00	-19.71	48.36	5.93	Peak	351	194
5	12010.00	26.89	54.00	-27.11	10.87	16.02	Average	358	182
6	12010.00	56.99	74.00	-17.01	40.97	16.02	Peak	358	182

Note 1: Emission Level (dBuV/m) = SA Reading (dBuV/m) + Factor* (dB)

*Factor includes antenna factor , cable loss and amplifier gain

Note 2: Margin (dB) = Emission level (dBuV/m) – Limit (dBuV/m).

Modulation	8DPSK	Test Freq. (MHz)	2441
Polarization	Horizontal	Test Configuration	1

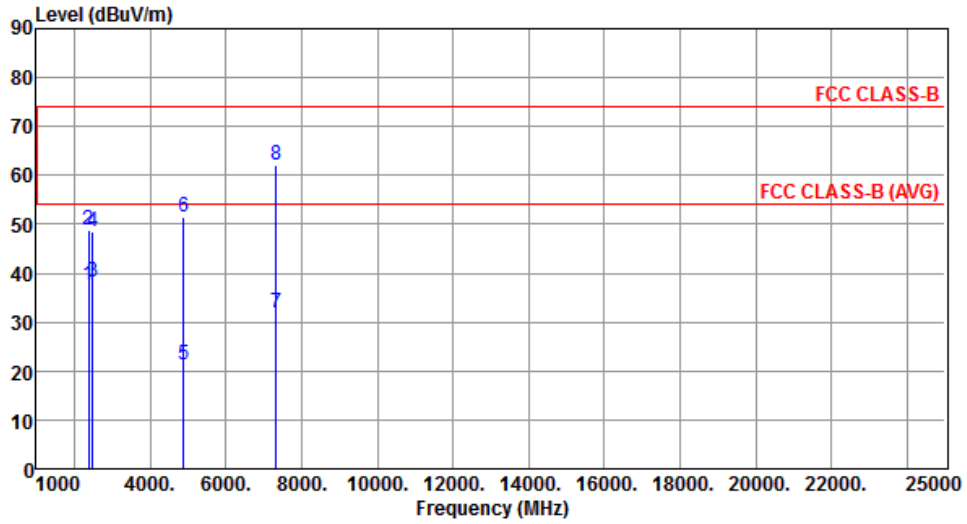

	Freq. MHz	Emission level dBuV/m	Limit dBuV/m	Margin dB	SA reading dBuV	Factor dB	Remark	ANT High cm	Turn Table deg
1	2390.00	37.37	54.00	-16.63	38.73	-1.36	Average	164	144
2	2390.00	48.83	74.00	-25.17	50.19	-1.36	Peak	164	144
3	2483.50	38.04	54.00	-15.96	39.06	-1.02	Average	164	144
4	2483.50	48.48	74.00	-25.52	49.50	-1.02	Peak	164	144
5	4882.00	21.24	54.00	-32.76	15.26	5.98	Average	326	261
6	4882.00	51.34	74.00	-22.66	45.36	5.98	Peak	326	261
7	7323.00	31.93	54.00	-22.07	21.16	10.77	Average	247	51
8	7323.00	62.03	74.00	-11.97	51.26	10.77	Peak	247	51

Note 1: Emission Level (dBuV/m) = SA Reading (dBuV/m) + Factor* (dB)

*Factor includes antenna factor , cable loss and amplifier gain

Note 2: Margin (dB) = Emission level (dBuV/m) – Limit (dBuV/m).

Modulation	8DPSK	Test Freq. (MHz)	2441
Polarization	Vertical	Test Configuration	1

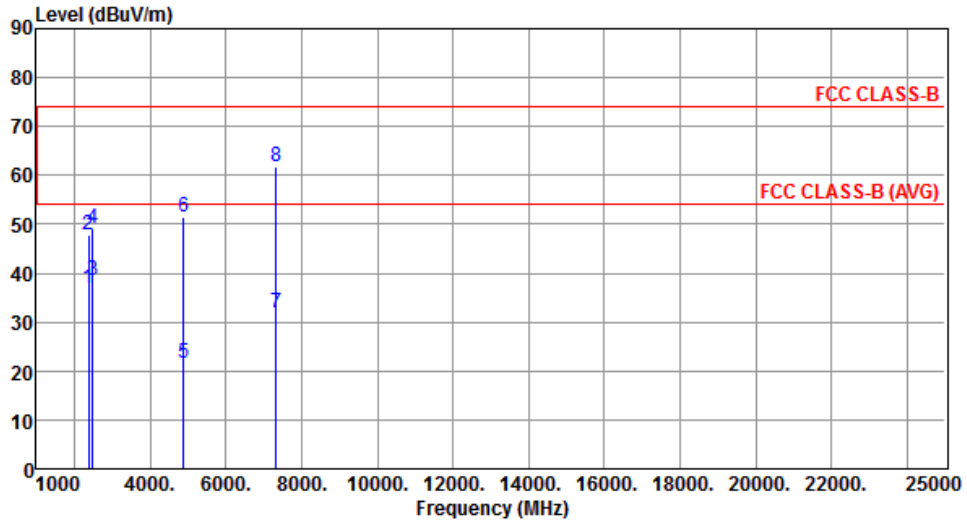

	Freq. MHz	Emission level dBuV/m	Limit dBuV/m	Margin dB	SA reading dBuV	Factor dB	Remark	ANT High cm	Turn Table deg
1	2390.00	36.89	54.00	-17.11	38.25	-1.36	Average	292	283
2	2390.00	47.98	74.00	-26.02	49.34	-1.36	Peak	392	283
3	2483.50	38.42	54.00	-15.58	39.44	-1.02	Average	392	283
4	2483.50	49.23	74.00	-24.77	50.25	-1.02	Peak	392	283
5	4882.00	21.49	54.00	-32.51	15.51	5.98	Average	196	274
6	4882.00	51.59	74.00	-22.41	45.61	5.98	Peak	196	274
7	7323.00	31.73	54.00	-22.27	20.96	10.77	Average	217	325
8	7323.00	61.83	74.00	-12.17	51.06	10.77	Peak	217	325

Note 1: Emission Level (dBuV/m) = SA Reading (dBuV/m) + Factor* (dB)

*Factor includes antenna factor , cable loss and amplifier gain

Note 2: Margin (dB) = Emission level (dBuV/m) – Limit (dBuV/m).

Modulation	8DPSK	Test Freq. (MHz)	2480
Polarization	Horizontal	Test Configuration	1

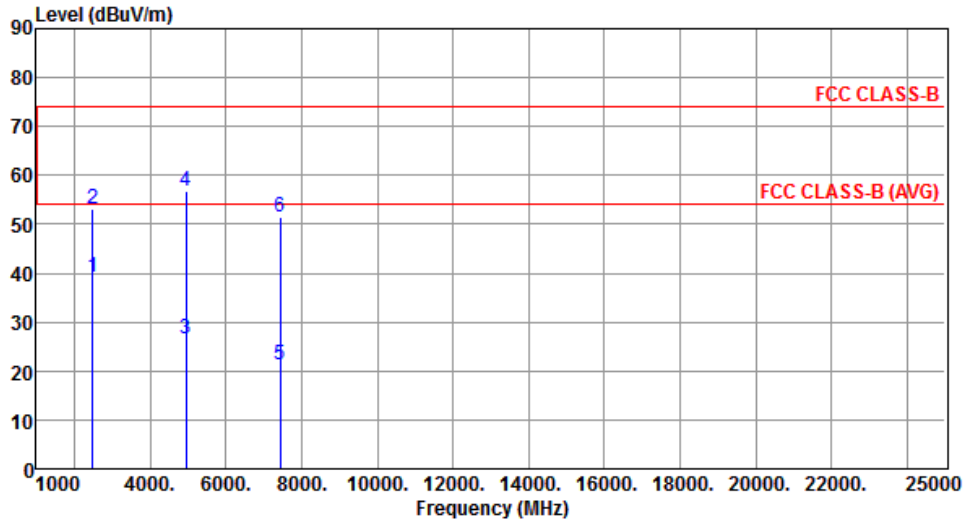

	Freq. MHz	Emission level dBuV/m	Limit dBuV/m	Margin dB	SA reading dBuV	Factor dB	Remark	ANT High cm	Turn Table deg
1	2483.50	39.27	54.00	-14.73	40.29	-1.02	Average	123	155
2	2483.50	53.17	74.00	-20.83	54.19	-1.02	Peak	123	155
3	4960.00	26.60	54.00	-27.40	20.57	6.03	Average	241	265
4	4960.00	56.70	74.00	-17.30	50.67	6.03	Peak	241	265
5	7440.00	21.28	54.00	-32.72	10.26	11.02	Average	283	179
6	7440.00	51.38	74.00	-22.62	40.36	11.02	Peak	283	179

Note 1: Emission Level (dBuV/m) = SA Reading (dBuV/m) + Factor* (dB)

*Factor includes antenna factor , cable loss and amplifier gain

Note 2: Margin (dB) = Emission level (dBuV/m) – Limit (dBuV/m).

Modulation	8DPSK	Test Freq. (MHz)	2480
Polarization	Vertical	Test Configuration	1

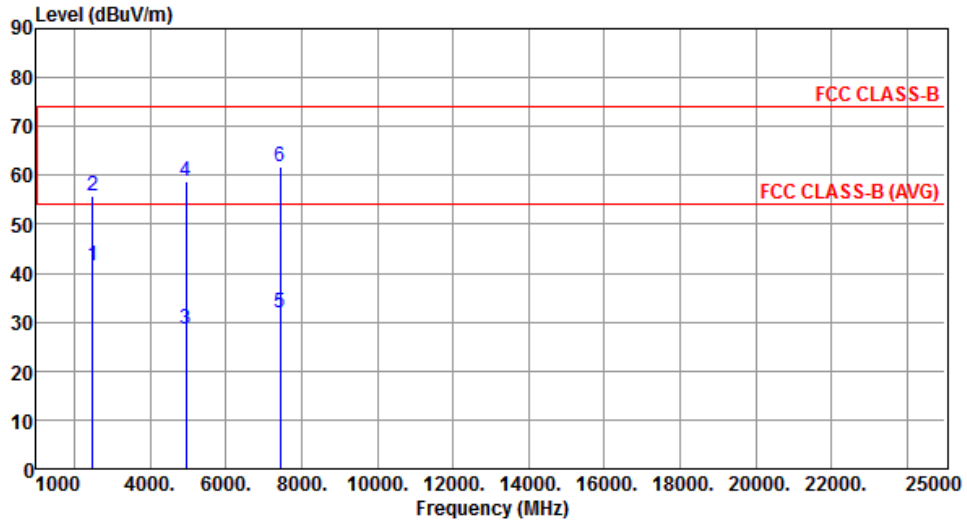

	Freq. MHz	Emission level dBuV/m	Limit dBuV/m	Margin dB	SA reading dBuV	Factor dB	Remark	ANT High cm	Turn Table deg
1	2483.50	41.47	54.00	-12.53	42.49	-1.02	Average	400	291
2	2483.50	55.85	74.00	-18.15	56.87	-1.02	Peak	400	291
3	4960.00	28.72	54.00	-25.28	22.69	6.03	Average	267	219
4	4960.00	58.82	74.00	-15.18	52.79	6.03	Peak	267	219
5	7440.00	31.83	54.00	-22.17	20.81	11.02	Average	217	165
6	7440.00	61.93	74.00	-12.07	50.91	11.02	Peak	217	165

Note 1: Emission Level (dBuV/m) = SA Reading (dBuV/m) + Factor* (dB)

*Factor includes antenna factor , cable loss and amplifier gain

Note 2: Margin (dB) = Emission level (dBuV/m) – Limit (dBuV/m).

Test Configuration 2: PCB Dipole antenna

3.2.7 Transmitter Radiated Unwanted Emissions (Below 1GHz)

Modulation	GFSK	Test Freq. (MHz)	2441
Polarization	Horizontal	Test Configuration	2

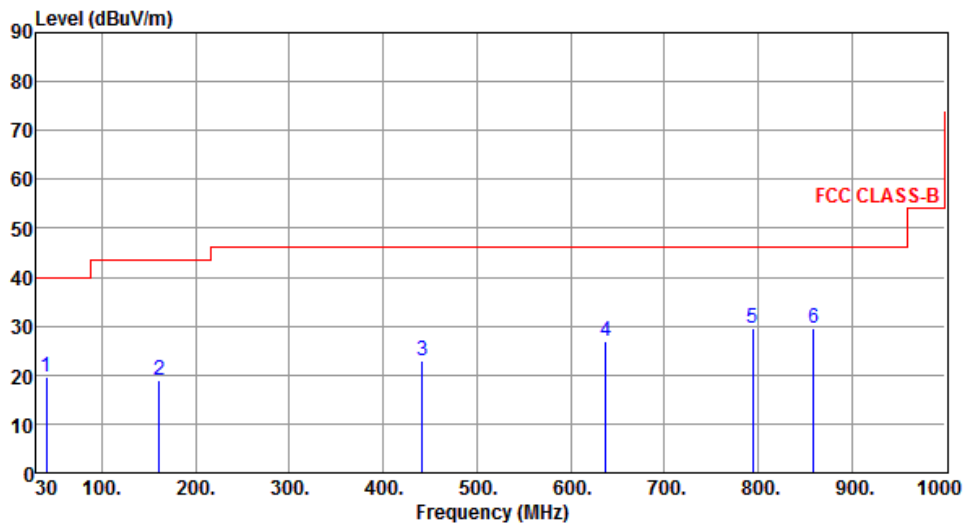

	Freq. MHz	Emission level dBuV/m	Limit dBuV/m	Margin dB	SA reading dBuV	Factor dB	Remark	ANT High cm	Turn Table deg
1	40.74	19.43	40.00	-20.57	32.55	-13.12	Peak	---	---
2	160.89	18.86	43.50	-24.64	32.52	-13.66	Peak	---	---
3	442.23	22.76	46.00	-23.24	31.74	-8.98	Peak	---	---
4	637.21	26.91	46.00	-19.09	32.16	-5.25	Peak	---	---
5	794.32	29.63	46.00	-16.37	32.34	-2.71	Peak	---	---
6	859.40	29.55	46.00	-16.45	31.14	-1.59	Peak	---	---

Note 1: Emission Level (dBuV/m) = SA Reading (dBuV/m) + Factor* (dB)

*Factor includes antenna factor , cable loss and amplifier gain

Note 2: Margin (dB) = Emission level (dBuV/m) – Limit (dBuV/m).

Note 3: All spurious emissions below 30MHz are more than 20 dB below the limit.

Modulation	GFSK	Test Freq. (MHz)	2441
Polarization	Vertical	Test Configuration	2

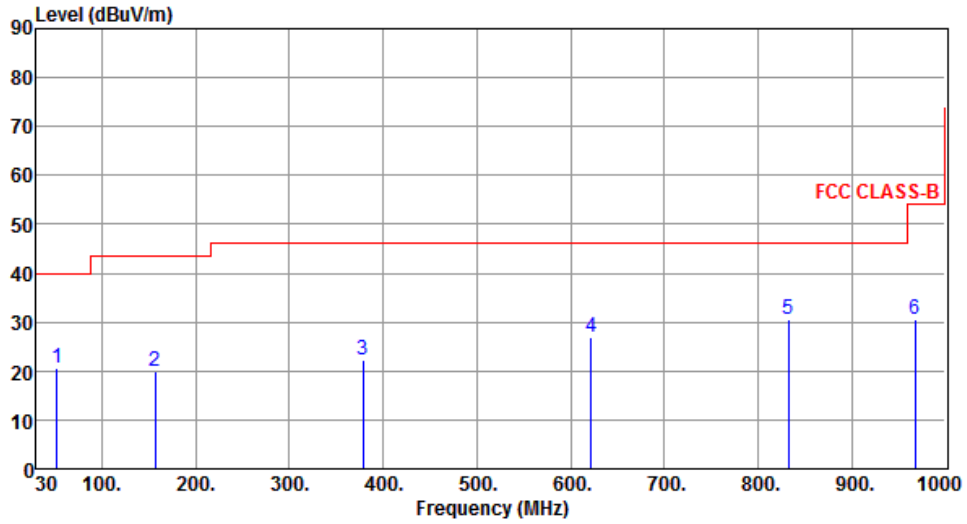

	Freq. MHz	Emission level dBuV/m	Limit dBuV/m	Margin dB	SA reading dBuV	Factor dB	Remark	ANT High cm	Turn Table deg
1	52.35	20.65	40.00	-19.35	33.93	-13.28	Peak	---	---
2	157.09	19.84	43.50	-23.66	33.41	-13.57	Peak	---	---
3	378.24	22.11	46.00	-23.89	32.77	-10.66	Peak	---	---
4	621.78	26.78	46.00	-19.22	32.26	-5.48	Peak	---	---
5	832.13	30.66	46.00	-15.34	32.75	-2.09	Peak	---	---
6	967.95	30.56	54.00	-23.44	30.26	0.30	Peak	---	---

Note 1: Emission Level (dBuV/m) = SA Reading (dBuV/m) + Factor* (dB)

*Factor includes antenna factor , cable loss and amplifier gain

Note 2: Margin (dB) = Emission level (dBuV/m) – Limit (dBuV/m).

Note 3: All spurious emissions below 30MHz are more than 20 dB below the limit.

3.2.8 Transmitter Radiated Unwanted Emissions (Above 1GHz) for GFSK

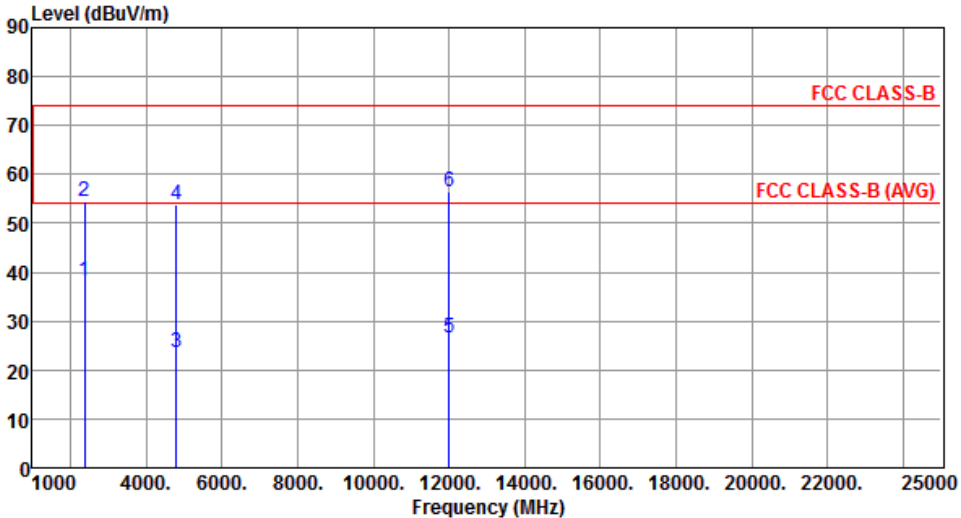
Modulation	GFSK	Test Freq. (MHz)	2402																																																																																				
Polarization	Horizontal	Test Configuration	2																																																																																				
																																																																																							
	<table border="1"> <thead> <tr> <th>Freq.</th> <th>Emission level</th> <th>Limit</th> <th>Margin</th> <th>SA reading</th> <th>Factor</th> <th>Remark</th> <th>ANT High</th> <th>Turn Table</th> </tr> <tr> <th>MHz</th> <th>dBuV/m</th> <th>dBuV/m</th> <th>dB</th> <th>dBuV</th> <th>dB</th> <th></th> <th>cm</th> <th>deg</th> </tr> </thead> <tbody> <tr> <td>1</td> <td>2390.00</td> <td>38.06</td> <td>54.00</td> <td>-15.94</td> <td>39.42</td> <td>-1.36</td> <td>Average</td> <td>150</td> <td>357</td> </tr> <tr> <td>2</td> <td>2390.00</td> <td>54.59</td> <td>74.00</td> <td>-19.41</td> <td>55.95</td> <td>-1.36</td> <td>Peak</td> <td>150</td> <td>357</td> </tr> <tr> <td>3</td> <td>4804.00</td> <td>23.72</td> <td>54.00</td> <td>-30.28</td> <td>17.79</td> <td>5.93</td> <td>Average</td> <td>163</td> <td>184</td> </tr> <tr> <td>4</td> <td>4804.00</td> <td>53.82</td> <td>74.00</td> <td>-20.18</td> <td>47.89</td> <td>5.93</td> <td>Peak</td> <td>163</td> <td>184</td> </tr> <tr> <td>5</td> <td>12010.00</td> <td>26.45</td> <td>54.00</td> <td>-27.55</td> <td>10.43</td> <td>16.02</td> <td>Average</td> <td>166</td> <td>215</td> </tr> <tr> <td>6</td> <td>12010.00</td> <td>56.55</td> <td>74.00</td> <td>-17.45</td> <td>40.53</td> <td>16.02</td> <td>Peak</td> <td>166</td> <td>215</td> </tr> </tbody> </table>	Freq.	Emission level	Limit	Margin	SA reading	Factor	Remark	ANT High	Turn Table	MHz	dBuV/m	dBuV/m	dB	dBuV	dB		cm	deg	1	2390.00	38.06	54.00	-15.94	39.42	-1.36	Average	150	357	2	2390.00	54.59	74.00	-19.41	55.95	-1.36	Peak	150	357	3	4804.00	23.72	54.00	-30.28	17.79	5.93	Average	163	184	4	4804.00	53.82	74.00	-20.18	47.89	5.93	Peak	163	184	5	12010.00	26.45	54.00	-27.55	10.43	16.02	Average	166	215	6	12010.00	56.55	74.00	-17.45	40.53	16.02	Peak	166	215								
Freq.	Emission level	Limit	Margin	SA reading	Factor	Remark	ANT High	Turn Table																																																																															
MHz	dBuV/m	dBuV/m	dB	dBuV	dB		cm	deg																																																																															
1	2390.00	38.06	54.00	-15.94	39.42	-1.36	Average	150	357																																																																														
2	2390.00	54.59	74.00	-19.41	55.95	-1.36	Peak	150	357																																																																														
3	4804.00	23.72	54.00	-30.28	17.79	5.93	Average	163	184																																																																														
4	4804.00	53.82	74.00	-20.18	47.89	5.93	Peak	163	184																																																																														
5	12010.00	26.45	54.00	-27.55	10.43	16.02	Average	166	215																																																																														
6	12010.00	56.55	74.00	-17.45	40.53	16.02	Peak	166	215																																																																														
<p>Note 1: Emission Level (dBuV/m) = SA Reading (dBuV/m) + Factor* (dB) *Factor includes antenna factor , cable loss and amplifier gain Note 2: Margin (dB) = Emission level (dBuV/m) – Limit (dBuV/m).</p>																																																																																							

Modulation	GFSK	Test Freq. (MHz)	2402
Polarization	Vertical	Test Configuration	2

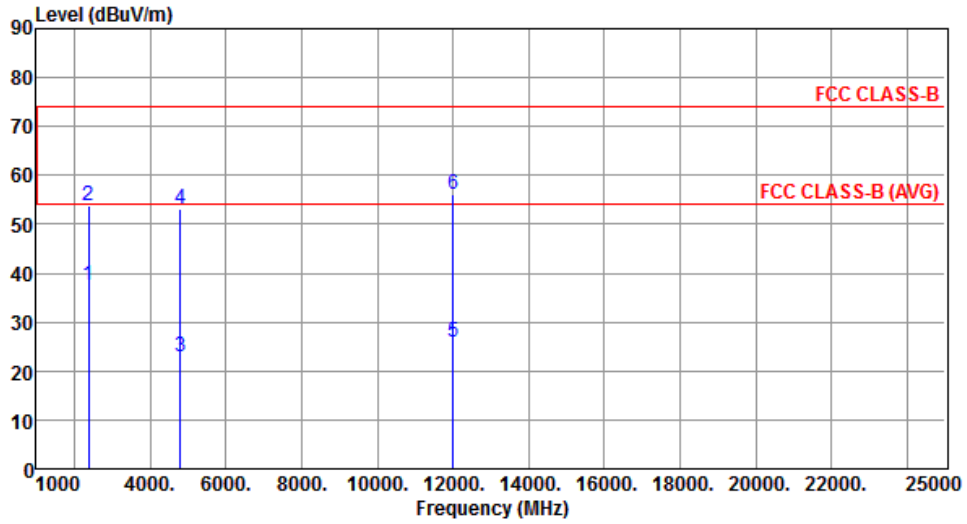

	Freq. MHz	Emission level dBuV/m	Limit dBuV/m	Margin dB	SA reading dBuV	Factor dB	Remark	ANT High cm	Turn Table deg
1	2390.00	37.66	54.00	-16.34	39.02	-1.36	Average	166	58
2	2390.00	53.85	74.00	-20.15	55.21	-1.36	Peak	166	58
3	4804.00	22.94	54.00	-31.06	17.01	5.93	Average	150	189
4	4804.00	53.04	74.00	-20.96	47.11	5.93	Peak	150	189
5	12010.00	25.98	54.00	-28.02	9.96	16.02	Average	222	123
6	12010.00	56.08	74.00	-17.92	40.06	16.02	Peak	222	123

Note 1: Emission Level (dBuV/m) = SA Reading (dBuV/m) + Factor* (dB)

*Factor includes antenna factor , cable loss and amplifier gain

Note 2: Margin (dB) = Emission level (dBuV/m) – Limit (dBuV/m).

Modulation	GFSK	Test Freq. (MHz)	2441
Polarization	Horizontal	Test Configuration	2

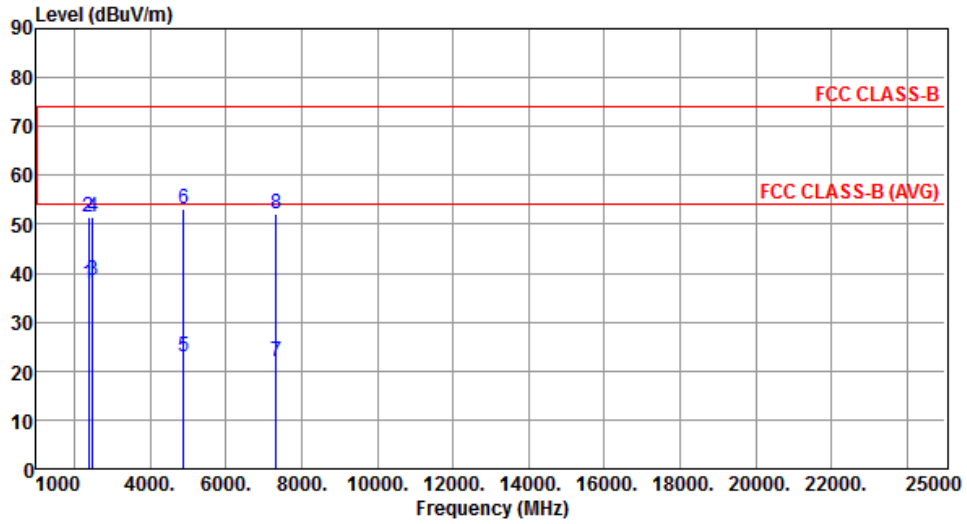

	Freq. MHz	Emission level dBuV/m	Limit dBuV/m	Margin dB	SA reading dBuV	Factor dB	Remark	ANT High cm	Turn Table deg
1	2390.00	37.95	54.00	-16.05	39.31	-1.36	Average	168	0
2	2390.00	51.38	74.00	-22.62	52.74	-1.36	Peak	168	0
3	2483.50	38.36	54.00	-15.64	39.38	-1.02	Average	168	0
4	2483.50	51.38	74.00	-22.62	52.40	-1.02	Peak	168	0
5	4882.00	22.91	54.00	-31.09	16.93	5.98	Average	152	186
6	4882.00	53.01	74.00	-20.99	47.03	5.98	Peak	152	186
7	7323.00	21.96	54.00	-32.04	11.19	10.77	Average	152	143
8	7323.00	52.06	74.00	-21.94	41.29	10.77	Peak	152	143

Note 1: Emission Level (dBuV/m) = SA Reading (dBuV/m) + Factor* (dB)

*Factor includes antenna factor , cable loss and amplifier gain

Note 2: Margin (dB) = Emission level (dBuV/m) – Limit (dBuV/m).

Modulation	GFSK	Test Freq. (MHz)	2441
Polarization	Vertical	Test Configuration	2

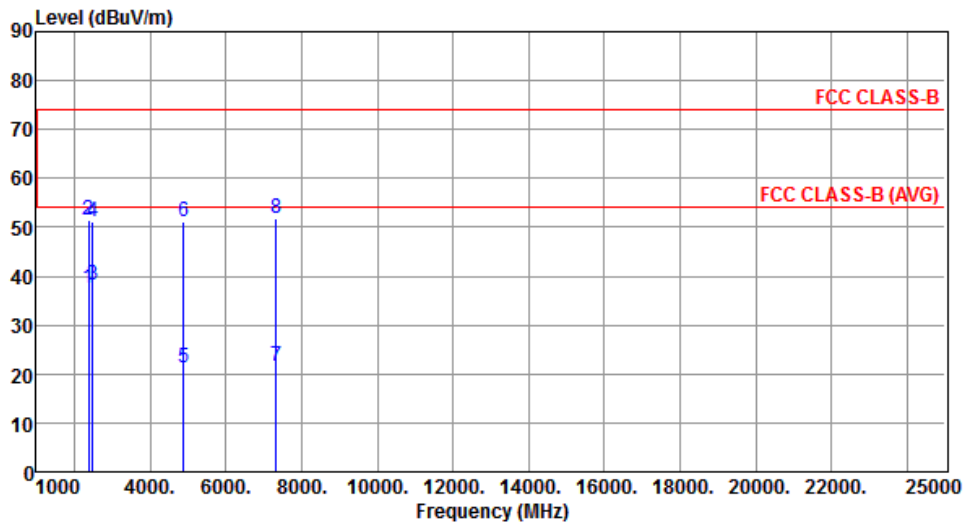

	Freq. MHz	Emission level dBuV/m	Limit dBuV/m	Margin dB	SA reading dBuV	Factor dB	Remark	ANT High cm	Turn Table deg
1	2390.00	37.69	54.00	-16.31	39.05	-1.36	Average	150	49
2	2390.00	51.32	74.00	-22.68	52.68	-1.36	Peak	150	49
3	2483.50	38.04	54.00	-15.96	39.06	-1.02	Average	150	49
4	2483.50	50.98	74.00	-23.02	52.00	-1.02	Peak	150	49
5	4882.00	21.10	54.00	-32.90	15.12	5.98	Average	150	169
6	4882.00	51.20	74.00	-22.80	45.22	5.98	Peak	150	169
7	7323.00	21.67	54.00	-32.33	10.90	10.77	Average	166	212
8	7323.00	51.77	74.00	-22.23	41.00	10.77	Peak	166	212

Note 1: Emission Level (dBuV/m) = SA Reading (dBuV/m) + Factor* (dB)

*Factor includes antenna factor , cable loss and amplifier gain

Note 2: Margin (dB) = Emission level (dBuV/m) – Limit (dBuV/m).

Modulation	GFSK	Test Freq. (MHz)	2480
Polarization	Horizontal	Test Configuration	2

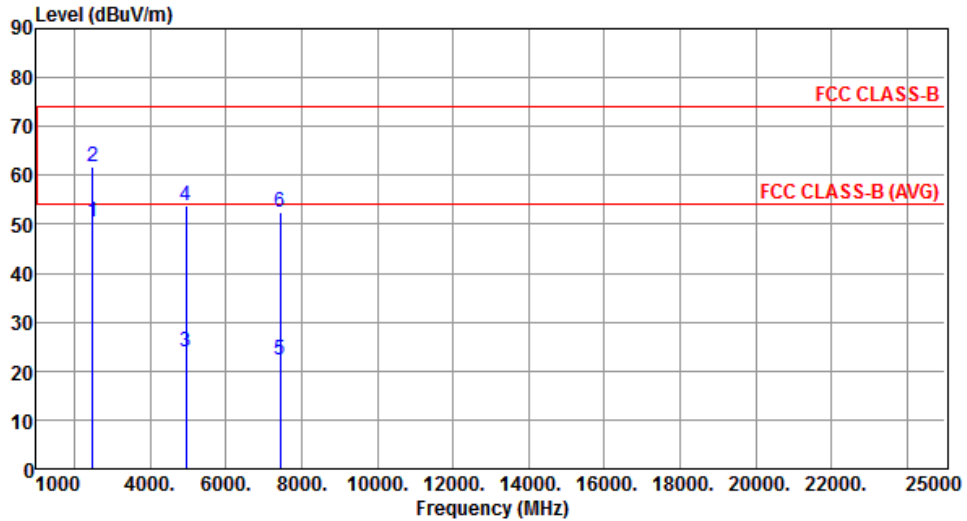

	Freq. MHz	Emission level dBuV/m	Limit dBuV/m	Margin dB	SA reading dBuV	Factor dB	Remark	ANT High cm	Turn Table deg
1	2483.50	50.48	54.00	-3.52	51.50	-1.02	Average	180	5
2	2483.50	61.80	74.00	-12.20	62.82	-1.02	Peak	180	5
3	4960.00	23.86	54.00	-30.14	17.83	6.03	Average	184	182
4	4960.00	53.96	74.00	-20.04	47.93	6.03	Peak	184	182
5	7440.00	22.27	54.00	-31.73	11.25	11.02	Average	184	200
6	7440.00	52.37	74.00	-21.63	41.35	11.02	Peak	184	200

Note 1: Emission Level (dBuV/m) = SA Reading (dBuV/m) + Factor* (dB)

*Factor includes antenna factor , cable loss and amplifier gain

Note 2: Margin (dB) = Emission level (dBuV/m) – Limit (dBuV/m).

Modulation	GFSK	Test Freq. (MHz)	2480
Polarization	Vertical	Test Configuration	2

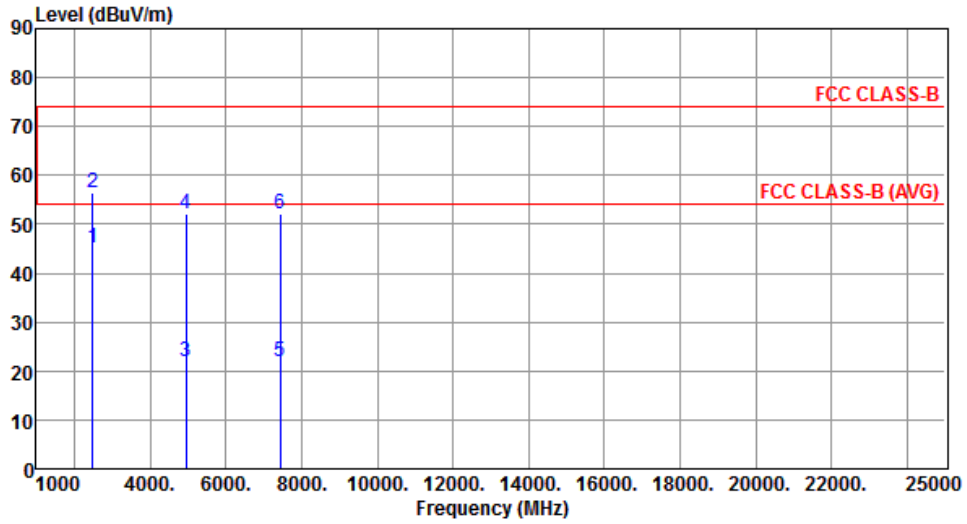

	Freq. MHz	Emission level dBuV/m	Limit dBuV/m	Margin dB	SA reading dBuV	Factor dB	Remark	ANT High cm	Turn Table deg
1	2483.50	45.08	54.00	-8.92	46.10	-1.02	Average	150	56
2	2483.50	56.46	74.00	-17.54	57.48	-1.02	Peak	150	56
3	4960.00	22.06	54.00	-31.94	16.03	6.03	Average	150	173
4	4960.00	52.16	74.00	-21.84	46.13	6.03	Peak	150	173
5	7440.00	21.95	54.00	-32.05	10.93	11.02	Average	166	321
6	7440.00	52.05	74.00	-21.95	41.03	11.02	Peak	166	321

Note 1: Emission Level (dBuV/m) = SA Reading (dBuV/m) + Factor* (dB)

*Factor includes antenna factor , cable loss and amplifier gain

Note 2: Margin (dB) = Emission level (dBuV/m) – Limit (dBuV/m).

3.2.9 Transmitter Radiated Unwanted Emissions (Above 1GHz) for 8DPSK

Modulation	8DPSK	Test Freq. (MHz)	2402
Polarization	Horizontal	Test Configuration	2

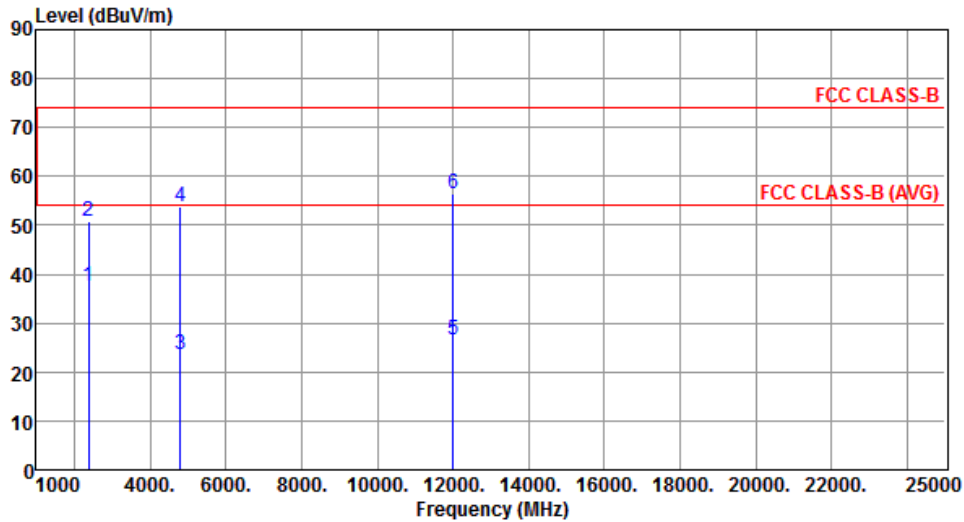

	Freq. MHz	Emission level dBuV/m	Limit dBuV/m	Margin dB	SA reading dBuV	Factor dB	Remark	ANT High cm	Turn Table deg
1	2390.00	37.48	54.00	-16.52	38.84	-1.36	Average	150	359
2	2390.00	50.66	74.00	-23.34	52.02	-1.36	Peak	150	359
3	4804.00	23.59	54.00	-30.41	17.66	5.93	Average	160	181
4	4804.00	53.69	74.00	-20.31	47.76	5.93	Peak	160	181
5	12010.00	26.45	54.00	-27.55	10.43	16.02	Average	166	215
6	12010.00	56.55	74.00	-17.45	40.53	16.02	Peak	166	215

Note 1: Emission Level (dBuV/m) = SA Reading (dBuV/m) + Factor* (dB)

*Factor includes antenna factor , cable loss and amplifier gain

Note 2: Margin (dB) = Emission level (dBuV/m) – Limit (dBuV/m).

Modulation	8DPSK	Test Freq. (MHz)	2402
Polarization	Vertical	Test Configuration	2

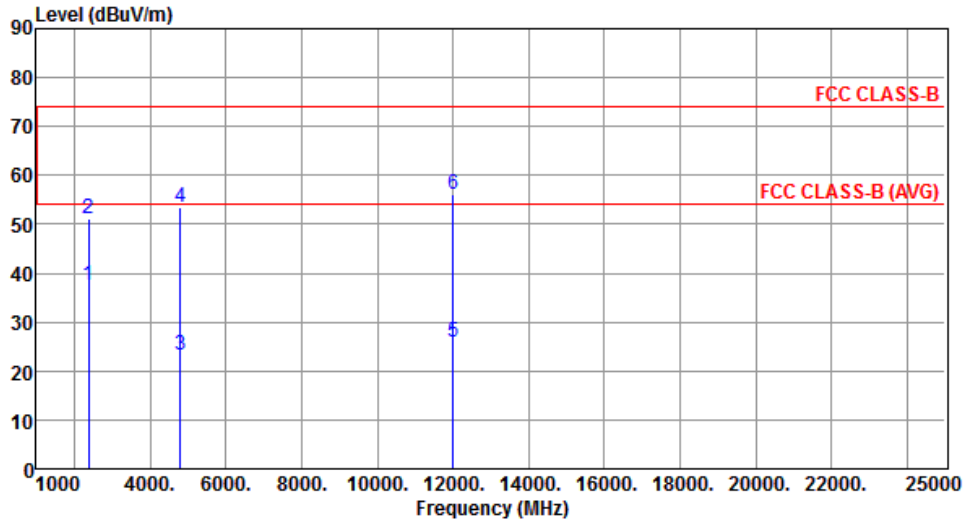

	Freq. MHz	Emission level dBuV/m	Limit dBuV/m	Margin dB	SA reading dBuV	Factor dB	Remark	ANT High cm	Turn Table deg
1	2390.00	37.55	54.00	-16.45	38.91	-1.36	Average	150	48
2	2390.00	51.06	74.00	-22.94	52.42	-1.36	Peak	150	48
3	4804.00	23.34	54.00	-30.66	17.41	5.93	Average	154	189
4	4804.00	53.44	74.00	-20.56	47.51	5.93	Peak	154	189
5	12010.00	26.01	54.00	-27.99	9.99	16.02	Average	166	221
6	12010.00	56.11	74.00	-17.89	40.09	16.02	Peak	166	221

Note 1: Emission Level (dBuV/m) = SA Reading (dBuV/m) + Factor* (dB)

*Factor includes antenna factor , cable loss and amplifier gain

Note 2: Margin (dB) = Emission level (dBuV/m) – Limit (dBuV/m).

Modulation	8DPSK	Test Freq. (MHz)	2441
Polarization	Horizontal	Test Configuration	2

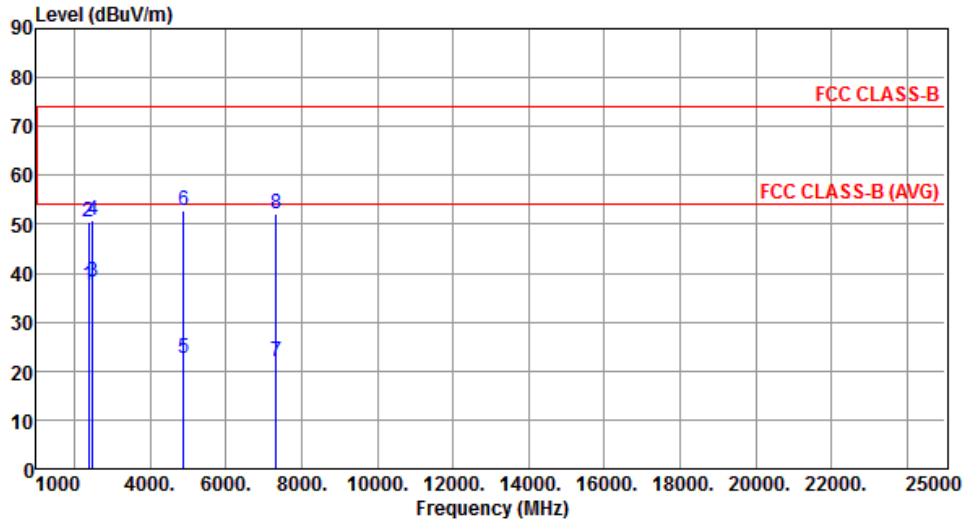

	Freq. MHz	Emission level dBuV/m	Limit dBuV/m	Margin dB	SA reading dBuV	Factor dB	Remark	ANT High cm	Turn Table deg
1	2390.00	37.55	54.00	-16.45	38.91	-1.36	Average	167	358
2	2390.00	50.39	74.00	-23.61	51.75	-1.36	Peak	167	358
3	2483.50	38.08	54.00	-15.92	39.10	-1.02	Average	167	358
4	2483.50	50.83	74.00	-23.17	51.85	-1.02	Peak	167	358
5	4882.00	22.72	54.00	-31.28	16.74	5.98	Average	155	185
6	4882.00	52.82	74.00	-21.18	46.84	5.98	Peak	155	185
7	7323.00	21.93	54.00	-32.07	11.16	10.77	Average	159	163
8	7323.00	52.03	74.00	-21.97	41.26	10.77	Peak	159	163

Note 1: Emission Level (dBuV/m) = SA Reading (dBuV/m) + Factor* (dB)

*Factor includes antenna factor , cable loss and amplifier gain

Note 2: Margin (dB) = Emission level (dBuV/m) – Limit (dBuV/m).

Modulation	8DPSK	Test Freq. (MHz)	2441
Polarization	Vertical	Test Configuration	2

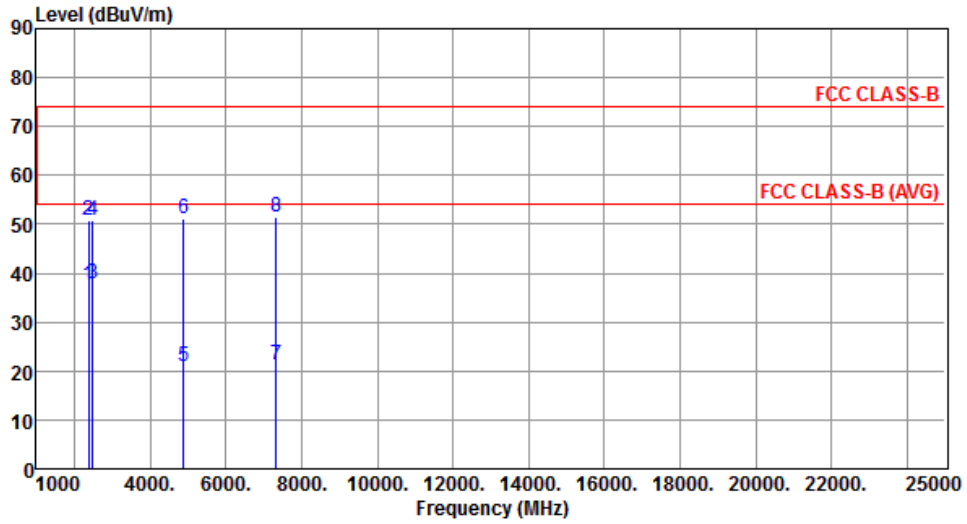

	Freq. MHz	Emission level dBuV/m	Limit dBuV/m	Margin dB	SA reading dBuV	Factor dB	Remark	ANT High cm	Turn Table deg
1	2390.00	37.59	54.00	-16.41	38.95	-1.36	Average	150	48
2	2390.00	50.96	74.00	-23.04	52.32	-1.36	Peak	150	48
3	2483.50	37.89	54.00	-16.11	38.91	-1.02	Average	150	49
4	2483.50	50.95	74.00	-23.05	51.97	-1.02	Peak	150	49
5	4882.00	21.04	54.00	-32.96	15.06	5.98	Average	150	166
6	4882.00	51.14	74.00	-22.86	45.16	5.98	Peak	150	166
7	7323.00	21.35	54.00	-32.65	10.58	10.77	Average	166	222
8	7323.00	51.45	74.00	-22.55	40.68	10.77	Peak	166	222

Note 1: Emission Level (dBuV/m) = SA Reading (dBuV/m) + Factor* (dB)

*Factor includes antenna factor , cable loss and amplifier gain

Note 2: Margin (dB) = Emission level (dBuV/m) – Limit (dBuV/m).

Modulation	8DPSK	Test Freq. (MHz)	2480
Polarization	Horizontal	Test Configuration	2

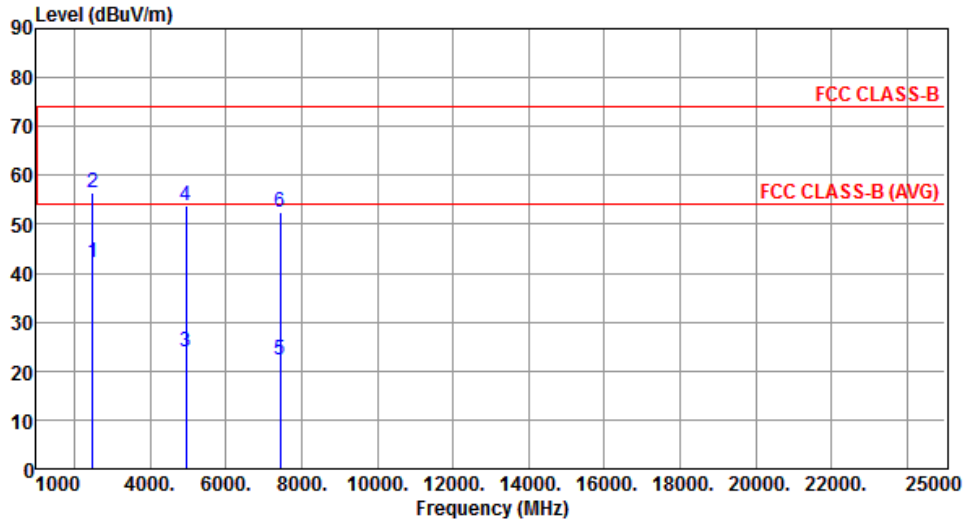

	Freq. MHz	Emission level dBuV/m	Limit dBuV/m	Margin dB	SA reading dBuV	Factor dB	Remark	ANT High cm	Turn Table deg
1	2483.50	42.29	54.00	-11.71	43.31	-1.02	Average	163	356
2	2483.50	56.46	74.00	-17.54	57.48	-1.02	Peak	163	356
3	4960.00	23.82	54.00	-30.18	17.25	6.57	Average	188	173
4	4960.00	53.92	74.00	-20.08	47.89	6.03	Peak	188	173
5	7440.00	22.21	54.00	-31.79	11.19	11.02	Average	184	221
6	7440.00	52.31	74.00	-21.69	41.29	11.02	Peak	184	221

Note 1: Emission Level (dBuV/m) = SA Reading (dBuV/m) + Factor* (dB)

*Factor includes antenna factor , cable loss and amplifier gain

Note 2: Margin (dB) = Emission level (dBuV/m) – Limit (dBuV/m).

Modulation	8DPSK	Test Freq. (MHz)	2480
Polarization	Vertical	Test Configuration	2

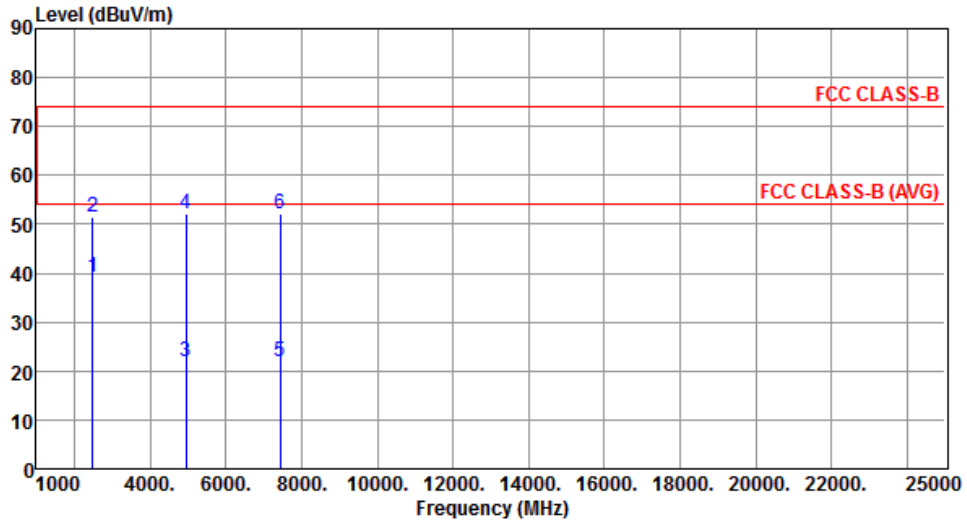

	Freq. MHz	Emission level dBuV/m	Limit dBuV/m	Margin dB	SA reading dBuV	Factor dB	Remark	ANT High cm	Turn Table deg
1	2483.50	39.08	54.00	-14.92	40.10	-1.02	Average	150	55
2	2483.50	51.40	74.00	-22.60	52.42	-1.02	Peak	150	55
3	4960.00	22.01	54.00	-31.99	15.98	6.03	Average	150	171
4	4960.00	52.11	74.00	-21.89	46.08	6.03	Peak	150	171
5	7440.00	22.06	54.00	-31.94	11.04	11.02	Average	166	226
6	7440.00	52.16	74.00	-21.84	41.14	11.02	Peak	166	226

Note 1: Emission Level (dBuV/m) = SA Reading (dBuV/m) + Factor* (dB)

*Factor includes antenna factor , cable loss and amplifier gain

Note 2: Margin (dB) = Emission level (dBuV/m) – Limit (dBuV/m).

Test Configuration 3: Isolated Magnetic Dipole antenna

3.2.10 Transmitter Radiated Unwanted Emissions (Below 1GHz)

Modulation	GFSK	Test Freq. (MHz)	2441
Polarization	Horizontal	Test Configuration	3

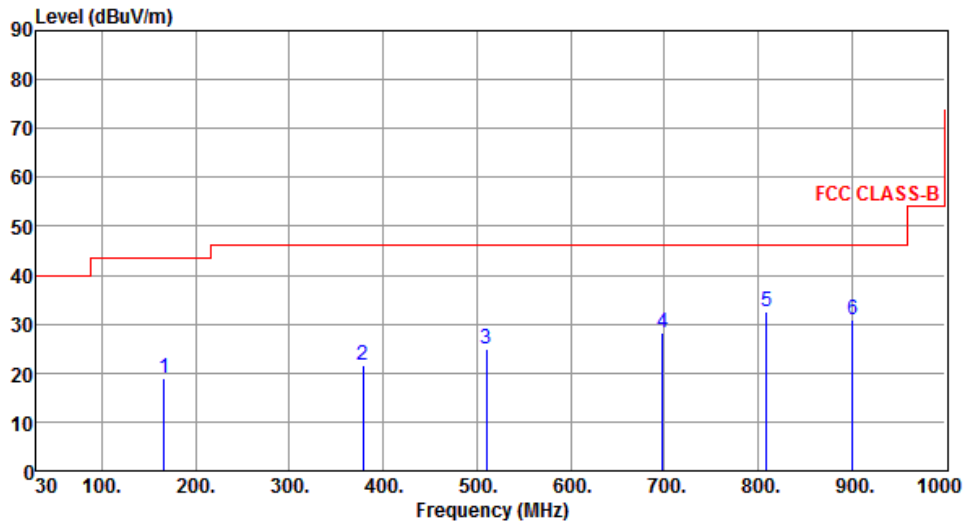

	Freq. MHz	Emission level dBuV/m	Limit dBuV/m	Margin dB	SA reading dBuV	Factor dB	Remark	ANT High cm	Turn Table deg
1	166.64	18.86	43.50	-24.64	32.79	-13.93	Peak	---	---
2	378.30	21.64	46.00	-24.36	32.29	-10.65	Peak	---	---
3	510.17	24.78	46.00	-21.22	32.33	-7.55	Peak	---	---
4	698.36	28.14	46.00	-17.86	32.58	-4.44	Peak	---	---
5	808.96	32.63	46.00	-13.37	35.11	-2.48	Peak	---	---
6	901.15	30.75	46.00	-15.25	31.45	-0.70	Peak	---	---

Note 1: Emission Level (dBuV/m) = SA Reading (dBuV/m) + Factor* (dB)

*Factor includes antenna factor, cable loss and amplifier gain

Note 2: Margin (dB) = Emission level (dBuV/m) – Limit (dBuV/m).

Note 3: All spurious emissions below 30MHz are more than 20 dB below the limit.

Modulation	GFSK	Test Freq. (MHz)	2441
Polarization	Vertical	Test Configuration	3

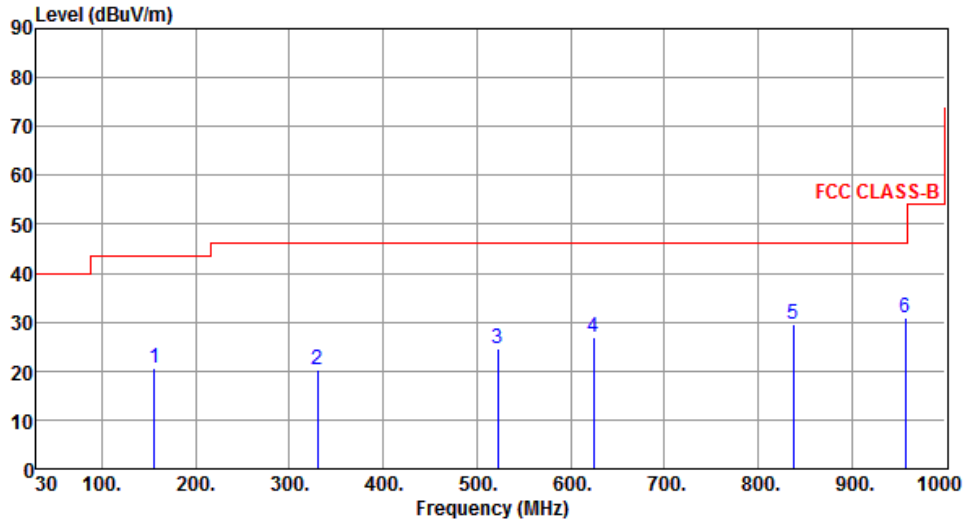

	Freq. MHz	Emission level dBuV/m	Limit dBuV/m	Margin dB	SA reading dBuV	Factor dB	Remark	ANT High cm	Turn Table deg
1	156.15	20.52	43.50	-22.98	34.07	-13.55	Peak	---	---
2	329.76	20.20	46.00	-25.80	32.17	-11.97	Peak	---	---
3	522.73	24.54	46.00	-21.46	31.94	-7.40	Peak	---	---
4	624.68	26.96	46.00	-19.04	32.40	-5.44	Peak	---	---
5	838.08	29.63	46.00	-16.37	31.62	-1.99	Peak	---	---
6	957.15	30.98	46.00	-15.02	30.75	0.23	Peak	---	---

Note 1: Emission Level (dBuV/m) = SA Reading (dBuV/m) + Factor* (dB)

*Factor includes antenna factor , cable loss and amplifier gain

Note 2: Margin (dB) = Emission level (dBuV/m) – Limit (dBuV/m).

Note 3: All spurious emissions below 30MHz are more than 20 dB below the limit.

3.2.11 Transmitter Radiated Unwanted Emissions (Above 1GHz) for GFSK

Modulation	GFSK	Test Freq. (MHz)	2402
Polarization	Horizontal	Test Configuration	3

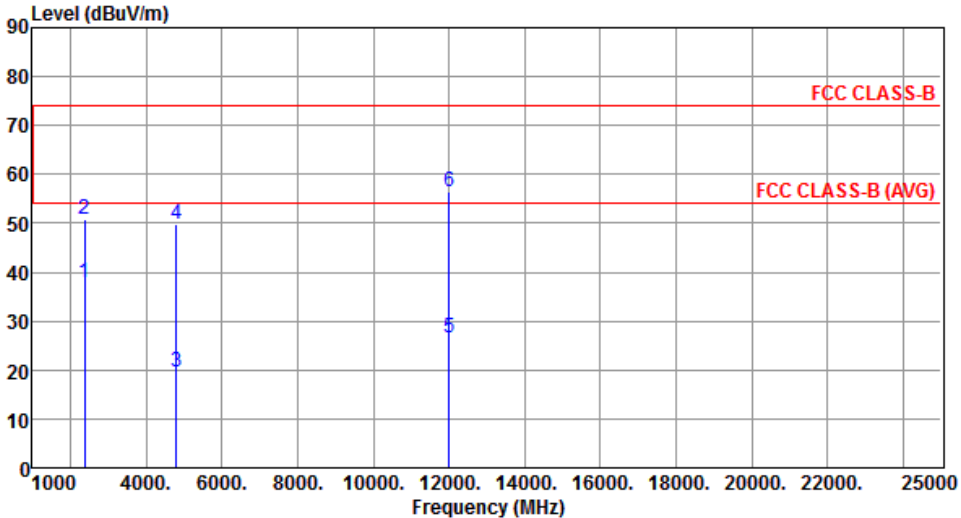

	Freq. MHz	Emission level dBuV/m	Limit dBuV/m	Margin dB	SA reading dBuV	Factor dB	Remark	ANT High cm	Turn Table deg
1	2390.00	37.88	54.00	-16.12	39.24	-1.36	Average	150	173
2	2390.00	50.92	74.00	-23.08	52.28	-1.36	Peak	150	173
3	4804.00	19.71	54.00	-34.29	13.78	5.93	Average	150	188
4	4804.00	49.81	74.00	-24.19	43.88	5.93	Peak	150	188
5	12010.00	26.47	54.00	-27.53	10.45	16.02	Average	166	199
6	12010.00	56.57	74.00	-17.43	40.55	16.02	Peak	166	199

Note 1: Emission Level (dBuV/m) = SA Reading (dBuV/m) + Factor* (dB)
*Factor includes antenna factor , cable loss and amplifier gain
Note 2: Margin (dB) = Emission level (dBuV/m) – Limit (dBuV/m).

Modulation	GFSK	Test Freq. (MHz)	2402
Polarization	Vertical	Test Configuration	3

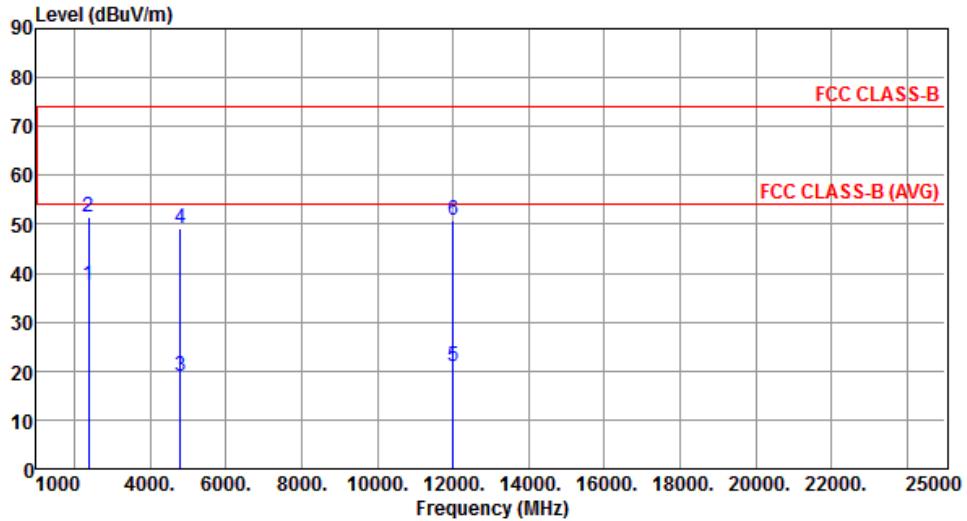

	Freq. MHz	Emission level dBuV/m	Limit dBuV/m	Margin dB	SA reading dBuV	Factor dB	Remark	ANT High cm	Turn Table deg
1	2390.00	37.55	54.00	-16.45	38.91	-1.36	Average	186	115
2	2390.00	51.52	74.00	-22.48	52.88	-1.36	Peak	186	115
3	4804.00	18.96	54.00	-35.04	13.03	5.93	Average	150	188
4	4804.00	49.06	74.00	-24.94	43.13	5.93	Peak	150	188
5	12010.00	20.76	54.00	-33.24	4.09	16.67	Average	166	196
6	12010.00	50.86	74.00	-23.14	34.19	16.67	Peak	166	196

Note 1: Emission Level (dBuV/m) = SA Reading (dBuV/m) + Factor* (dB)

*Factor includes antenna factor , cable loss and amplifier gain

Note 2: Margin (dB) = Emission level (dBuV/m) – Limit (dBuV/m).

Modulation	GFSK	Test Freq. (MHz)	2441
Polarization	Horizontal	Test Configuration	3

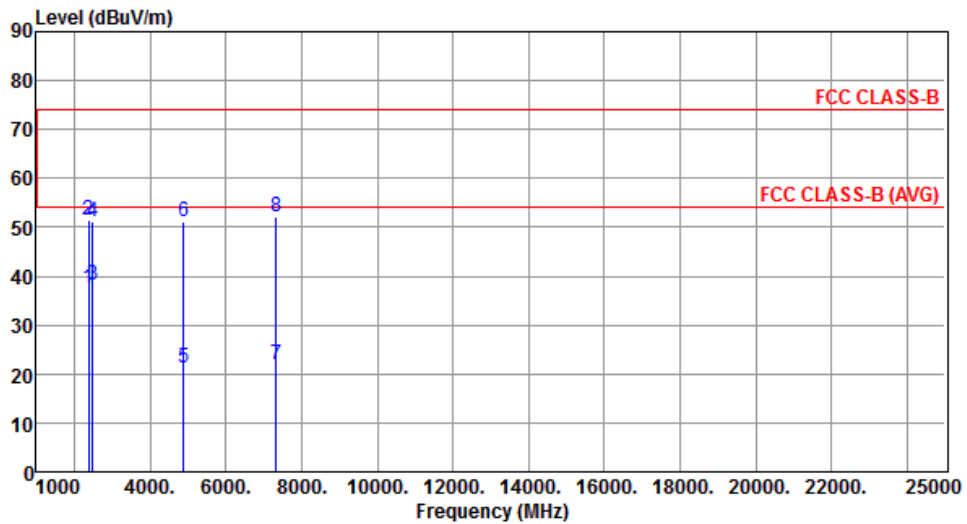

	Freq. MHz	Emission level dBuV/m	Limit dBuV/m	Margin dB	SA reading dBuV	Factor dB	Remark	ANT High cm	Turn Table deg
1	2390.00	37.66	54.00	-16.34	39.02	-1.36	Average	152	183
2	2390.00	51.52	74.00	-22.48	52.88	-1.36	Peak	152	183
3	2483.50	38.22	54.00	-15.78	39.24	-1.02	Average	152	183
4	2483.50	51.06	74.00	-22.94	52.08	-1.02	Peak	152	183
5	4882.00	21.10	54.00	-32.90	15.12	5.98	Average	150	187
6	4882.00	51.20	74.00	-22.80	45.22	5.98	Peak	150	187
7	7323.00	21.96	54.00	-32.04	11.19	10.77	Average	155	243
8	7323.00	52.06	74.00	-21.94	41.29	10.77	Peak	155	243

Note 1: Emission Level (dBuV/m) = SA Reading (dBuV/m) + Factor* (dB)

*Factor includes antenna factor , cable loss and amplifier gain

Note 2: Margin (dB) = Emission level (dBuV/m) – Limit (dBuV/m).

Modulation	GFSK	Test Freq. (MHz)	2441
Polarization	Vertical	Test Configuration	3

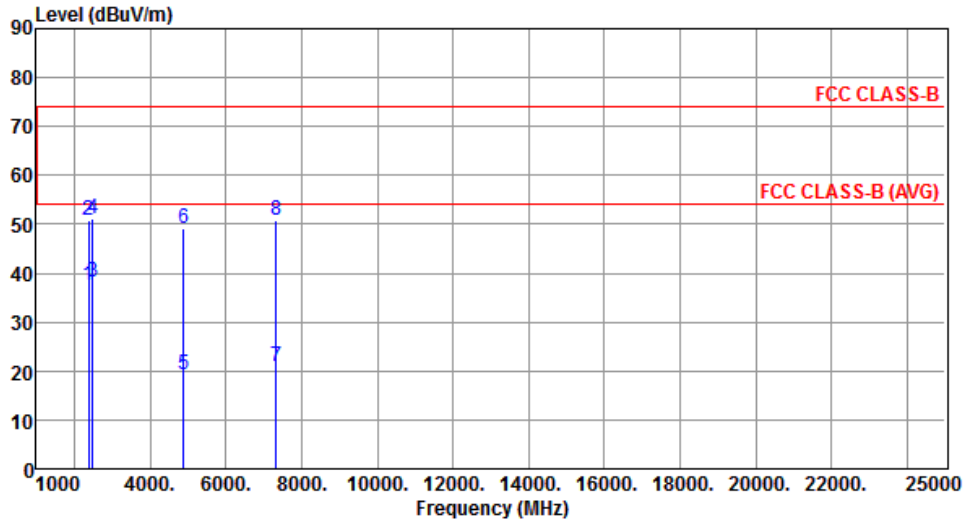

	Freq. MHz	Emission level dBuV/m	Limit dBuV/m	Margin dB	SA reading dBuV	Factor dB	Remark	ANT High cm	Turn Table deg
1	2390.00	37.64	54.00	-16.36	39.00	-1.36	Average	183	102
2	2390.00	50.96	74.00	-23.04	52.32	-1.36	Peak	183	102
3	2483.50	38.03	54.00	-15.97	39.05	-1.02	Average	183	102
4	2483.50	51.26	74.00	-22.74	52.28	-1.02	Peak	183	102
5	4882.00	19.10	54.00	-34.90	13.12	5.98	Average	150	186
6	4882.00	49.20	74.00	-24.80	43.22	5.98	Peak	150	186
7	7323.00	20.86	54.00	-33.14	10.09	10.77	Average	150	199
8	7323.00	50.96	74.00	-23.04	40.19	10.77	Peak	150	199

Note 1: Emission Level (dBuV/m) = SA Reading (dBuV/m) + Factor* (dB)

*Factor includes antenna factor , cable loss and amplifier gain

Note 2: Margin (dB) = Emission level (dBuV/m) – Limit (dBuV/m).

Modulation	GFSK	Test Freq. (MHz)	2480
Polarization	Horizontal	Test Configuration	3

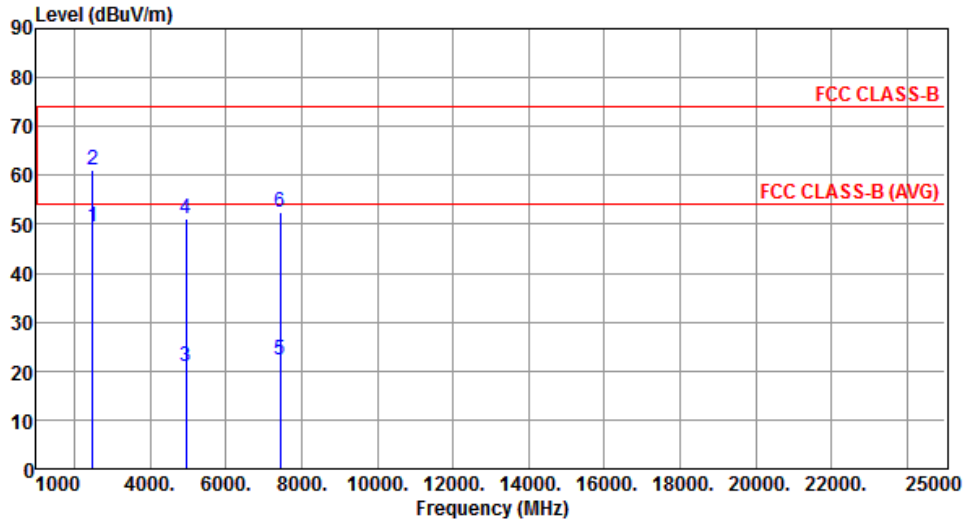

	Freq. MHz	Emission level dBuV/m	Limit dBuV/m	Margin dB	SA reading dBuV	Factor dB	Remark	ANT High cm	Turn Table deg
1	2483.50	49.39	54.00	-4.61	50.41	-1.02	Average	150	182
2	2483.50	61.16	74.00	-12.84	62.18	-1.02	Peak	150	182
3	4960.00	20.89	54.00	-33.11	14.86	6.03	Average	150	188
4	4960.00	50.99	74.00	-23.01	44.96	6.03	Peak	150	188
5	7440.00	22.24	54.00	-31.76	11.22	11.02	Average	150	188
6	7440.00	52.34	74.00	-21.66	41.32	11.02	Peak	150	188

Note 1: Emission Level (dBuV/m) = SA Reading (dBuV/m) + Factor* (dB)

*Factor includes antenna factor , cable loss and amplifier gain

Note 2: Margin (dB) = Emission level (dBuV/m) – Limit (dBuV/m).

Modulation	GFSK	Test Freq. (MHz)	2480
Polarization	Vertical	Test Configuration	3

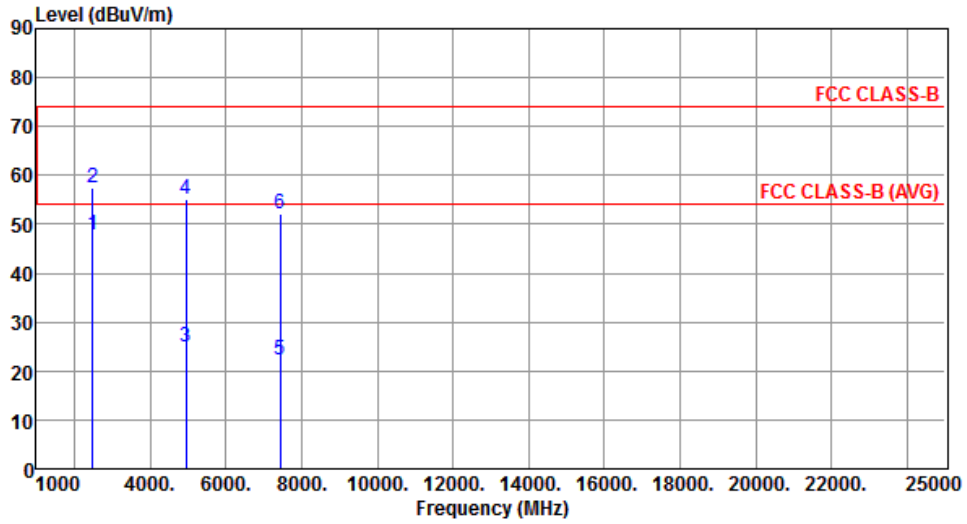

	Freq. MHz	Emission level dBuV/m	Limit dBuV/m	Margin dB	SA reading dBuV	Factor dB	Remark	ANT High cm	Turn Table deg
1	2483.50	47.83	54.00	-6.17	48.85	-1.02	Average	182	109
2	2483.50	57.60	74.00	-16.40	58.62	-1.02	Peak	182	109
3	4960.00	25.04	54.00	-28.96	19.01	6.03	Average	150	188
4	4960.00	55.14	74.00	-18.86	49.11	6.03	Peak	150	188
5	7440.00	22.15	54.00	-31.85	11.13	11.02	Average	166	163
6	7440.00	52.25	74.00	-21.75	41.23	11.02	Peak	166	163

Note 1: Emission Level (dBuV/m) = SA Reading (dBuV/m) + Factor* (dB)

*Factor includes antenna factor , cable loss and amplifier gain

Note 2: Margin (dB) = Emission level (dBuV/m) – Limit (dBuV/m).

3.2.12 Transmitter Radiated Unwanted Emissions (Above 1GHz) for 8DPSK

Modulation	8DPSK	Test Freq. (MHz)	2402
Polarization	Horizontal	Test Configuration	3

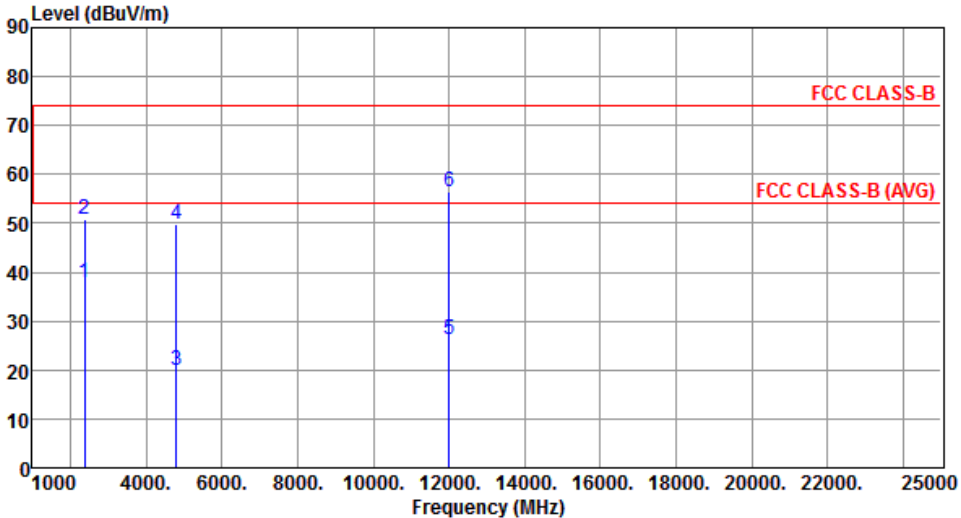

	Freq. MHz	Emission level dBuV/m	Limit dBuV/m	Margin dB	SA reading dBuV	Factor dB	Remark	ANT High cm	Turn Table deg
1	2390.00	37.79	54.00	-16.21	39.15	-1.36	Average	150	179
2	2390.00	50.81	74.00	-23.19	52.17	-1.36	Peak	150	179
3	4804.00	19.88	54.00	-34.12	13.95	5.93	Average	150	183
4	4804.00	49.98	74.00	-24.02	44.05	5.93	Peak	150	183
5	12010.00	26.31	54.00	-27.69	10.29	16.02	Average	188	212
6	12010.00	56.41	74.00	-17.59	40.39	16.02	Peak	188	212

Note 1: Emission Level (dBuV/m) = SA Reading (dBuV/m) + Factor* (dB)
 *Factor includes antenna factor , cable loss and amplifier gain
 Note 2: Margin (dB) = Emission level (dBuV/m) – Limit (dBuV/m).

Modulation	8DPSK	Test Freq. (MHz)	2402
Polarization	Vertical	Test Configuration	3

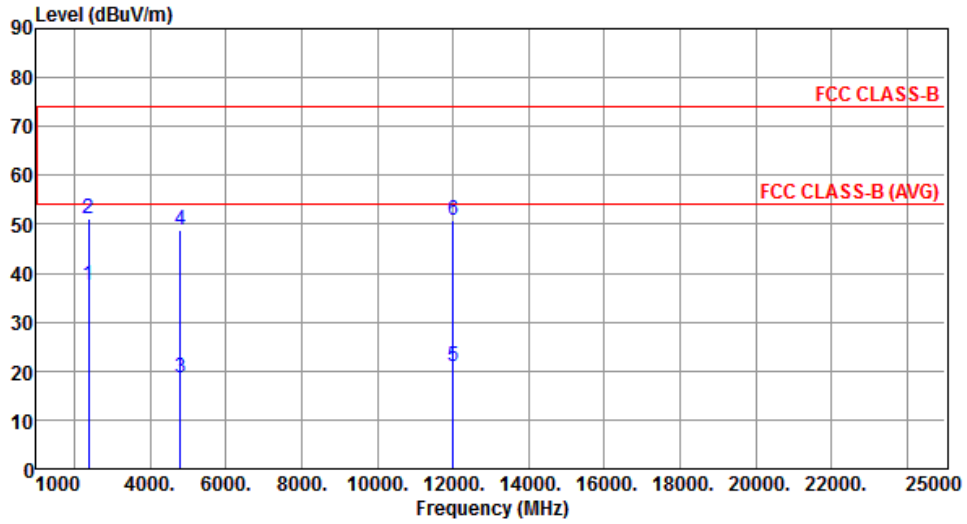

	Freq. MHz	Emission level dBuV/m	Limit dBuV/m	Margin dB	SA reading dBuV	Factor dB	Remark	ANT High cm	Turn Table deg
1	2390.00	37.41	54.00	-16.59	38.77	-1.36	Average	187	109
2	2390.00	51.09	74.00	-22.91	52.45	-1.36	Peak	187	109
3	4804.00	18.72	54.00	-35.28	12.79	5.93	Average	150	184
4	4804.00	48.82	74.00	-25.18	42.89	5.93	Peak	150	184
5	12010.00	20.78	54.00	-33.22	4.11	16.67	Average	179	221
6	12010.00	50.88	74.00	-23.12	34.21	16.67	Peak	179	221

Note 1: Emission Level (dBuV/m) = SA Reading (dBuV/m) + Factor* (dB)

*Factor includes antenna factor , cable loss and amplifier gain

Note 2: Margin (dB) = Emission level (dBuV/m) – Limit (dBuV/m).

Modulation	8DPSK	Test Freq. (MHz)	2441
Polarization	Horizontal	Test Configuration	3

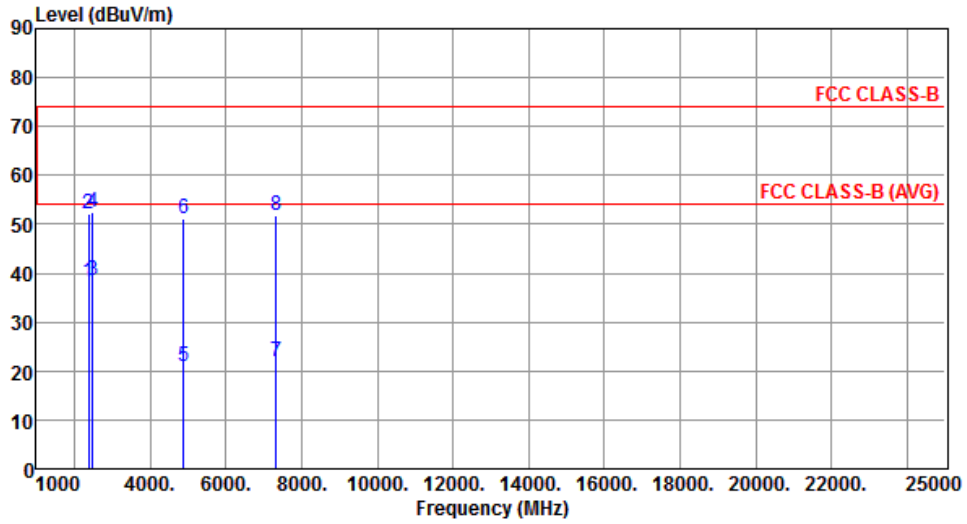

	Freq. MHz	Emission level dBuV/m	Limit dBuV/m	Margin dB	SA reading dBuV	Factor dB	Remark	ANT High cm	Turn Table deg
1	2390.00	38.11	54.00	-15.89	39.47	-1.36	Average	151	182
2	2390.00	52.21	74.00	-21.79	53.57	-1.36	Peak	151	182
3	2483.50	38.53	54.00	-15.47	39.55	-1.02	Average	151	182
4	2483.50	52.34	74.00	-21.66	53.36	-1.02	Peak	151	182
5	4882.00	20.93	54.00	-33.07	14.95	5.98	Average	150	184
6	4882.00	51.03	74.00	-22.97	45.05	5.98	Peak	150	184
7	7323.00	21.76	54.00	-32.24	10.99	10.77	Average	155	222
8	7323.00	51.86	74.00	-22.14	41.09	10.77	Peak	155	222

Note 1: Emission Level (dBuV/m) = SA Reading (dBuV/m) + Factor* (dB)

*Factor includes antenna factor , cable loss and amplifier gain

Note 2: Margin (dB) = Emission level (dBuV/m) – Limit (dBuV/m).

Modulation	8DPSK	Test Freq. (MHz)	2441
Polarization	Vertical	Test Configuration	3

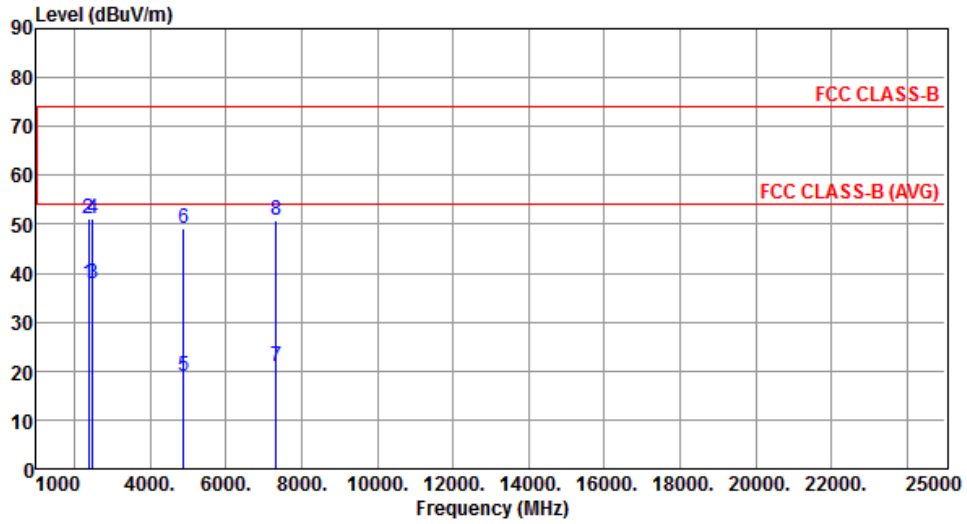

	Freq. MHz	Emission level dBuV/m	Limit dBuV/m	Margin dB	SA reading dBuV	Factor dB	Remark	ANT High cm	Turn Table deg
1	2390.00	37.96	54.00	-16.04	39.32	-1.36	Average	183	101
2	2390.00	51.25	74.00	-22.75	52.61	-1.36	Peak	183	101
3	2483.50	37.86	54.00	-16.14	38.88	-1.02	Average	183	101
4	2483.50	51.19	74.00	-22.81	52.21	-1.02	Peak	183	101
5	4882.00	19.05	54.00	-34.95	13.07	5.98	Average	150	188
6	4882.00	49.15	74.00	-24.85	43.17	5.98	Peak	150	188
7	7323.00	20.80	54.00	-33.20	10.03	10.77	Average	150	222
8	7323.00	50.90	74.00	-23.10	40.13	10.77	Peak	150	222

Note 1: Emission Level (dBuV/m) = SA Reading (dBuV/m) + Factor* (dB)

*Factor includes antenna factor , cable loss and amplifier gain

Note 2: Margin (dB) = Emission level (dBuV/m) – Limit (dBuV/m).

Modulation	8DPSK	Test Freq. (MHz)	2480
Polarization	Horizontal	Test Configuration	3

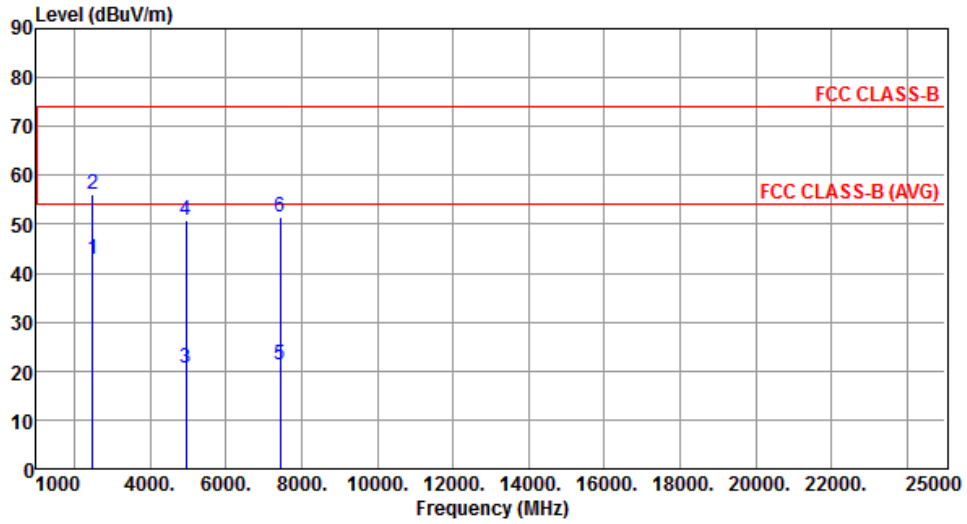

	Freq. MHz	Emission level dBuV/m	Limit dBuV/m	Margin dB	SA reading dBuV	Factor dB	Remark	ANT High cm	Turn Table deg
1	2483.50	42.73	54.00	-11.27	43.75	-1.02	Average	150	186
2	2483.50	56.01	74.00	-17.99	57.03	-1.02	Peak	150	186
3	4960.00	20.66	54.00	-33.34	14.63	6.03	Average	150	184
4	4960.00	50.76	74.00	-23.24	44.73	6.03	Peak	150	184
5	7440.00	21.39	54.00	-32.61	10.37	11.02	Average	150	199
6	7440.00	51.49	74.00	-22.51	40.47	11.02	Peak	150	199

Note 1: Emission Level (dBuV/m) = SA Reading (dBuV/m) + Factor* (dB)

*Factor includes antenna factor , cable loss and amplifier gain

Note 2: Margin (dB) = Emission level (dBuV/m) – Limit (dBuV/m).

Modulation	8DPSK	Test Freq. (MHz)	2480
Polarization	Vertical	Test Configuration	3

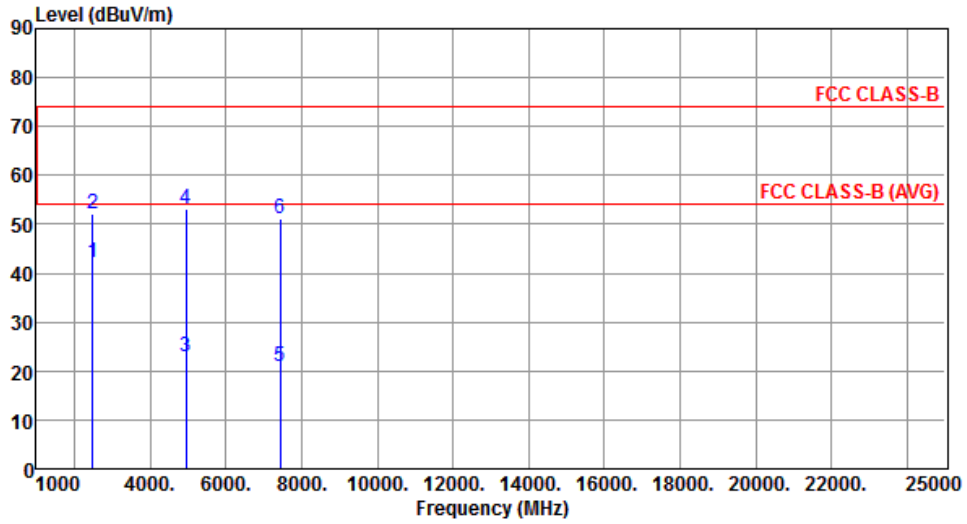

	Freq. MHz	Emission level dBuV/m	Limit dBuV/m	Margin dB	SA reading dBuV	Factor dB	Remark	ANT High cm	Turn Table deg
1	2483.50	42.25	54.00	-11.75	43.27	-1.02	Average	181	105
2	2483.50	52.26	74.00	-21.74	53.28	-1.02	Peak	181	105
3	4960.00	23.06	54.00	-30.94	17.03	6.03	Average	150	184
4	4960.00	53.16	74.00	-20.84	47.13	6.03	Peak	150	184
5	7440.00	20.91	54.00	-33.09	9.89	11.02	Average	168	166
6	7440.00	51.01	74.00	-22.99	39.99	11.02	Peak	168	166

Note 1: Emission Level (dBuV/m) = SA Reading (dBuV/m) + Factor* (dB)

*Factor includes antenna factor , cable loss and amplifier gain

Note 2: Margin (dB) = Emission level (dBuV/m) – Limit (dBuV/m).

3.3 Unwanted Emissions into Non-Restricted Frequency Bands

3.3.1 Limit of Unwanted Emissions into Non-Restricted Frequency Bands

The peak output power measured in any 100 kHz bandwidth outside of the authorized frequency band shall be attenuated by at least 20 dB relative to the maximum in-band peak PSD level in 100 kHz.

3.3.2 Test Procedures

Reference Level Measurement

1. Set the RBW = 100 kHz, VBW = 300 kHz, Detector = peak.
2. Set Sweep time = auto couple, Trace mode = max hold.
3. Allow trace to fully stabilize.
4. Use the peak marker function to determine the maximum amplitude level.

Unwanted Emissions Level Measurement

1. Set RBW = 100 kHz, VBW = 300 kHz, Detector = peak.
2. Trace Mode = max hold, Sweep = auto couple.
3. Allow the trace to stabilize.
4. Use peak marker function to determine maximum amplitude of all unwanted emissions within any 100 kHz bandwidth.

3.3.3 Test Setup

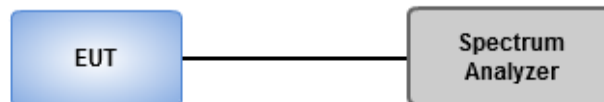

3.3.4 Unwanted Emissions into Non-Restricted Frequency Bands

GFSK

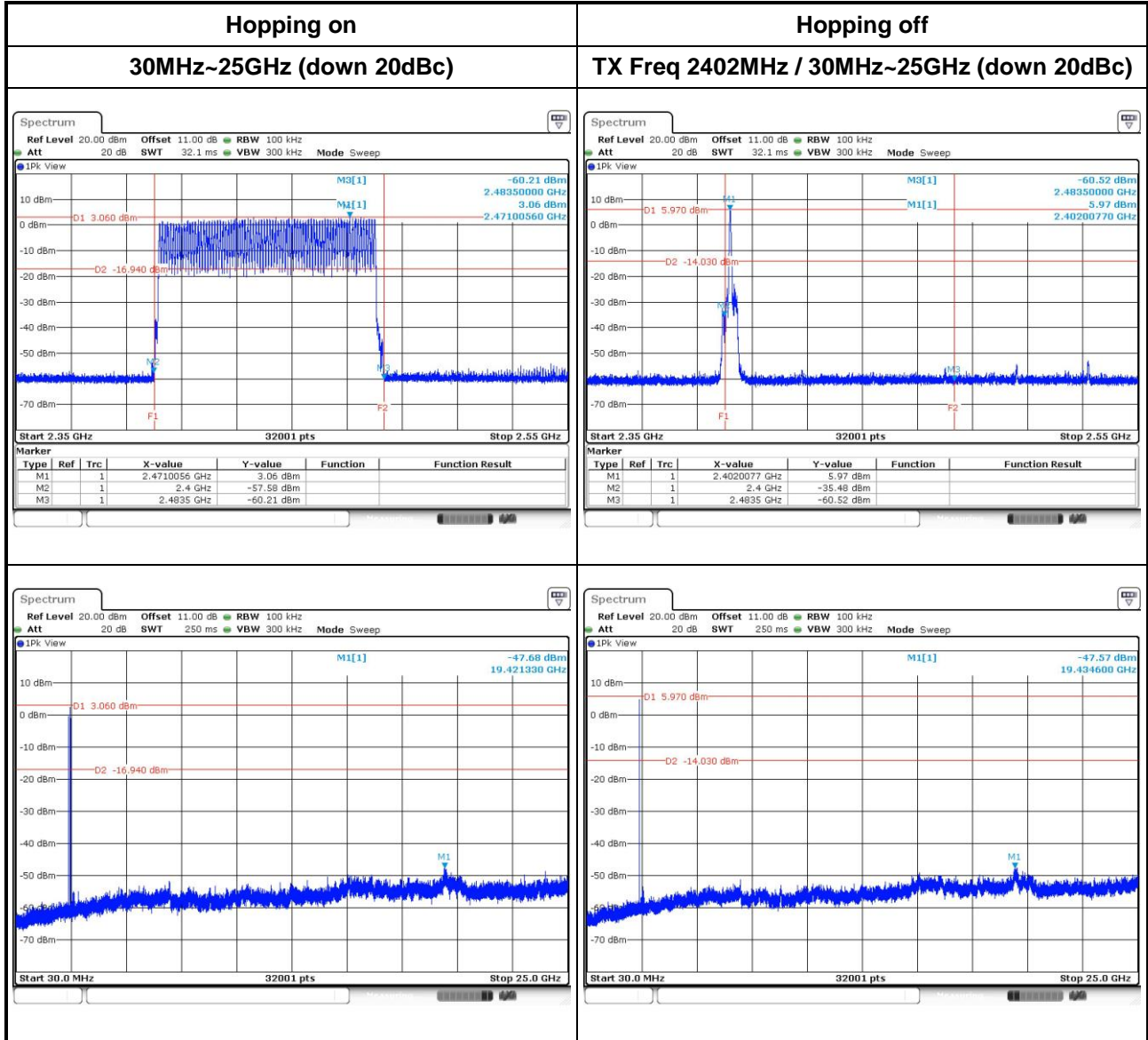

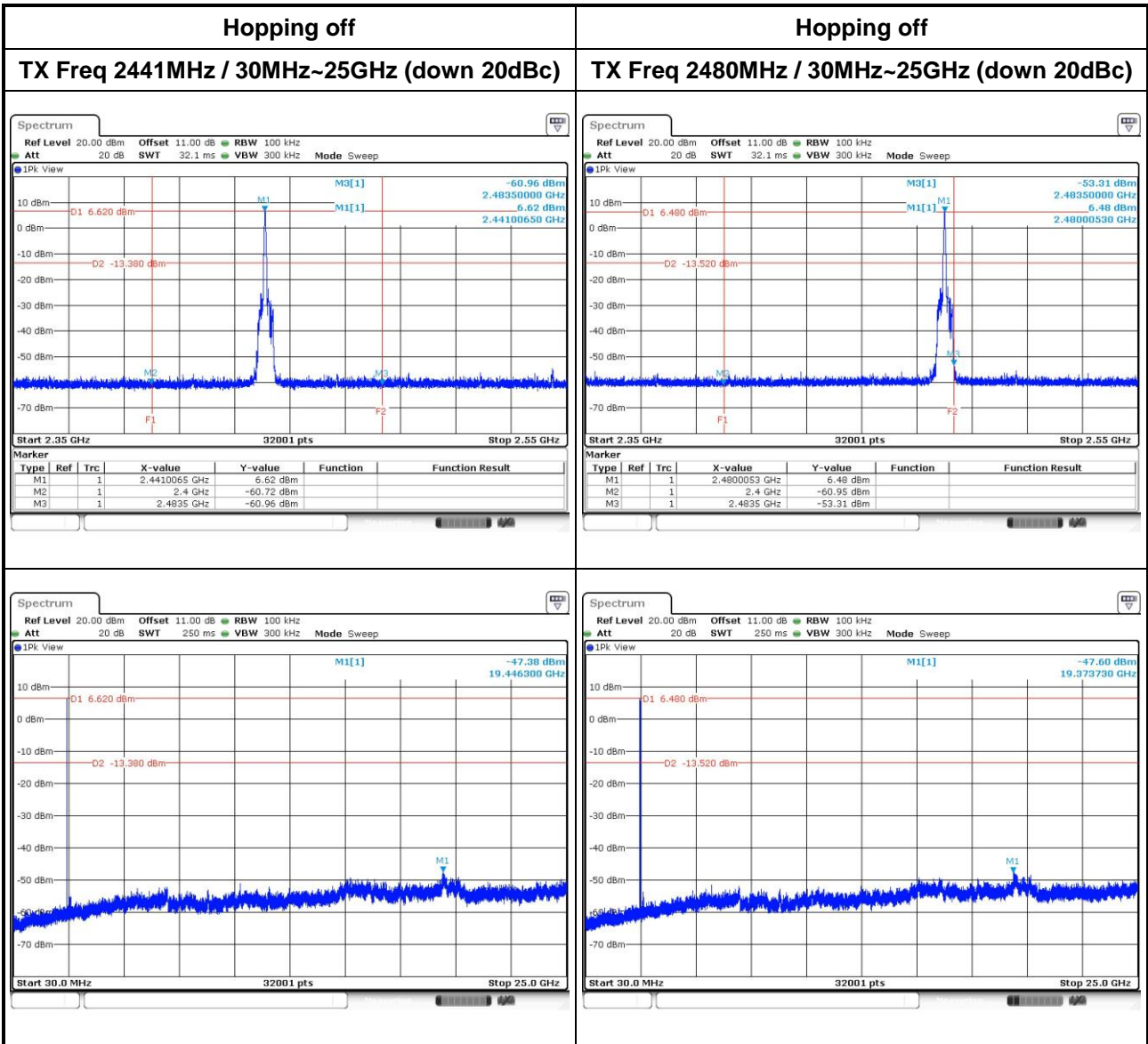

8DPSK

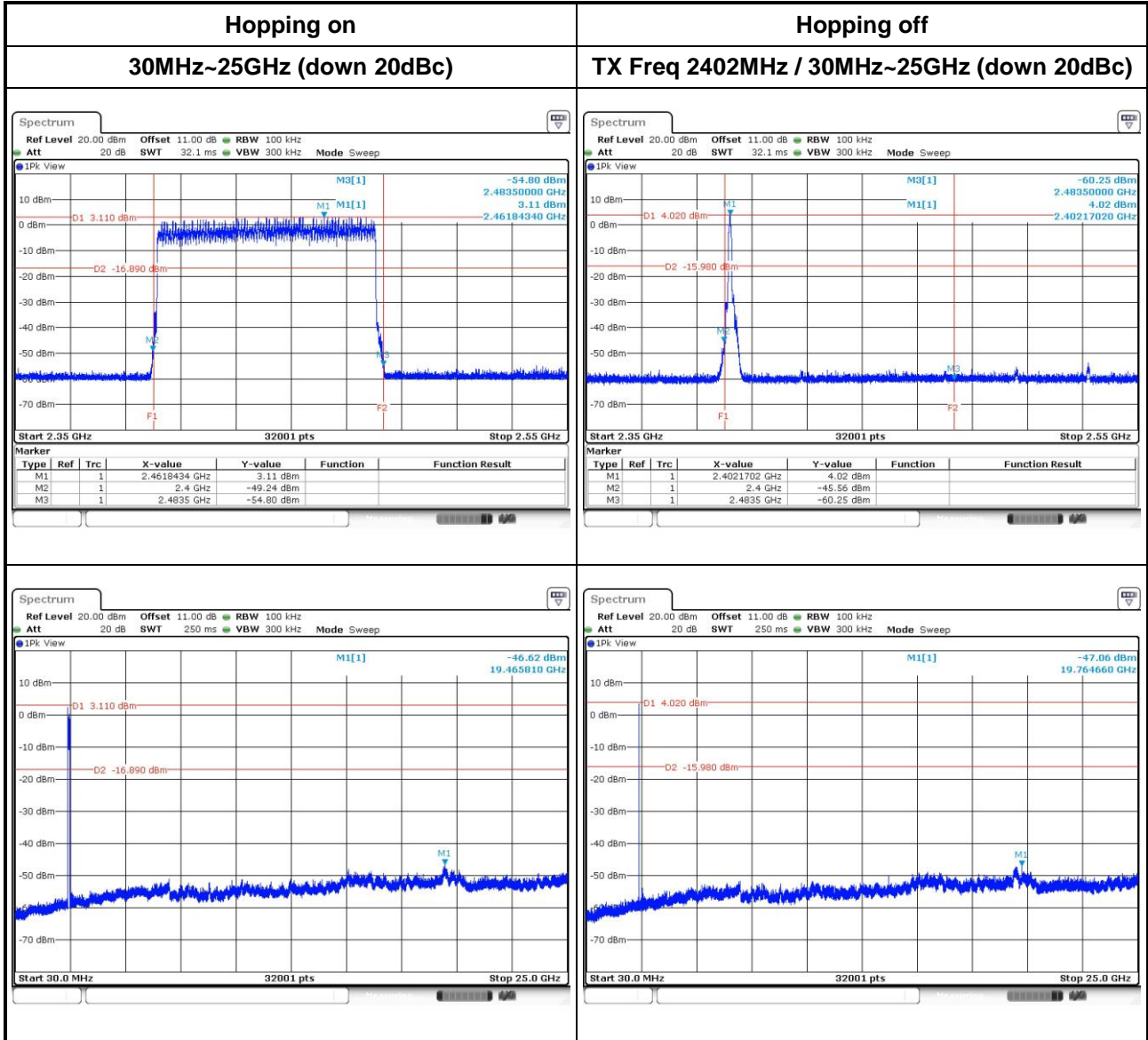

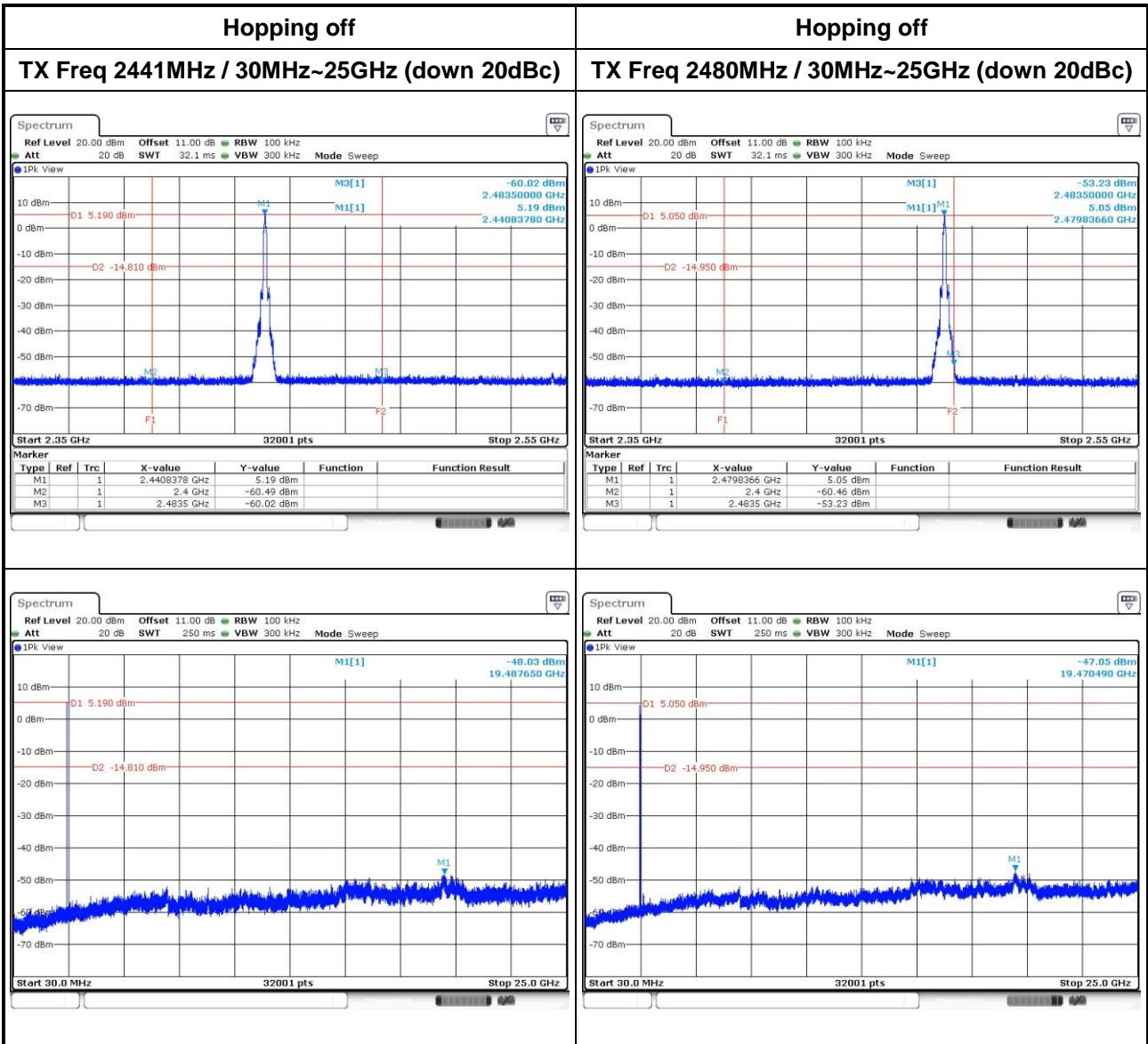

3.4 Conducted Output Power

3.4.1 Limit of Conducted Output Power

- 1 Watt
For frequency hopping systems operating in the 2400–2483.5 MHz band employing at least 75 non overlapping hopping channels, and all frequency hopping systems in the 5725–5850 MHz band.
- 0.125 Watt
For all other frequency hopping systems in the 2400–2483.5 MHz band.
- 0.125 Watt
For Frequency hopping systems operating in the 2400–2483.5 MHz band have hopping channel carrier frequencies that are separated by two-thirds of the 20 dB bandwidth of the hopping channel.

3.4.2 Test Procedures

1. A wideband power meter is used for power measurement. Bandwidth of power sensor and meter is 50MHz
2. If duty cycle of test signal is not 100 %, trigger and gating function of power meter will be enabled to capture transmission burst for measuring output power

3.4.3 Test Setup

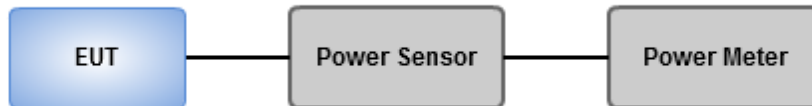

3.4.4 Test Result of Conducted Output Power

Modulation Mode	Freq. (MHz)	Output Power (mW)	Output Power (dBm)	Limit (mW)
GFSK	2402	4.69	6.71	125
GFSK	2441	5.70	7.56	125
GFSK	2480	5.68	7.54	125
π/4 DQPSK	2402	3.62	5.59	125
π/4 DQPSK	2441	4.59	6.62	125
π/4 DQPSK	2480	4.56	6.59	125
8DPSK	2402	3.88	5.89	125
8DPSK	2441	4.83	6.84	125
8DPSK	2480	4.79	6.80	125

Modulation Mode	Freq. (MHz)	AV Output Power (mW)	AV Output Power (dBm)
GFSK	2402	4.47	6.50
GFSK	2441	5.48	7.39
GFSK	2480	5.43	7.35
π/4 DQPSK	2402	2.48	3.94
π/4 DQPSK	2441	3.37	5.27
π/4 DQPSK	2480	3.35	5.25
8DPSK	2402	2.47	3.92
8DPSK	2441	3.35	5.25
8DPSK	2480	3.33	5.23

Note: Average power is for reference only.

3.5 Number of Hopping Frequency

3.5.1 Limit of Number of Hopping Frequency

Frequency hopping systems in the 2400–2483.5 MHz band shall use at least 15 channels.

3.5.2 Test Procedures

1. Set RBW = 100kHz, VBW = 300kHz, Sweep time = Auto, Detector = Peak Trace max hold.
2. Allow trace to stabilize.

3.5.3 Test Setup

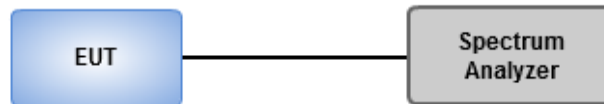

3.5.4 Test Result of Number of Hopping Frequency

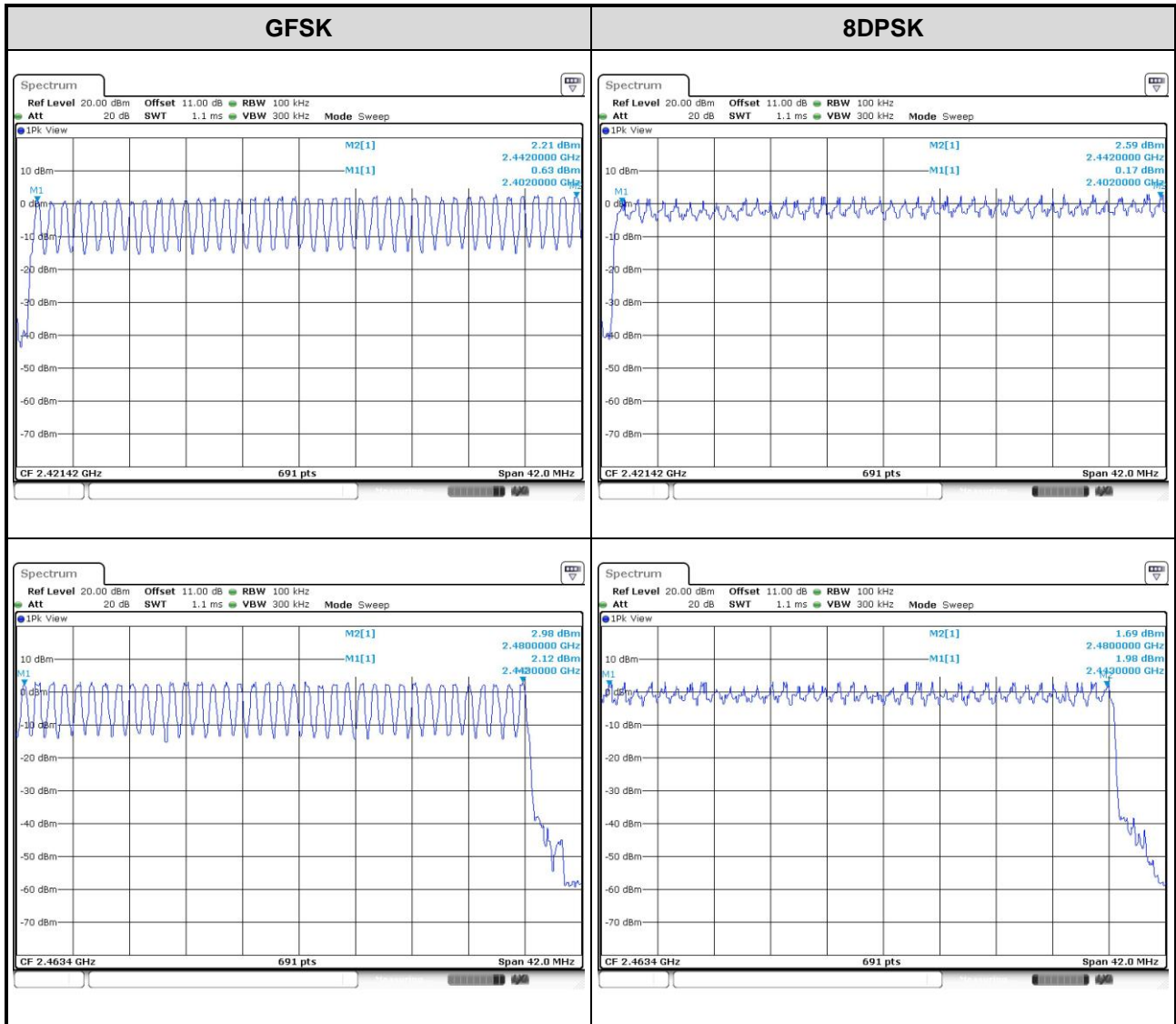

3.6 20dB and Occupied Bandwidth

3.6.1 Test Procedures

20dB Bandwidth

1. Set RBW=30kHz, VBW=100kHz, Sweep time = Auto, Detector=Peak, Trace max hold
2. Allow trace to stabilize
3. Measure the maximum width of the emission that is constrained by the frequencies associated with the two outermost amplitude points (upper and lower) that are attenuated by 20 dB relative to the maximum level measured in the fundamental emission.

Occupied Bandwidth

1. Set RBW=30kHz, VBW=100kHz, Sweep time = Auto, Detector=Sample, Trace max hold
2. Allow trace to stabilize
3. Use Occupied bandwidth function of spectrum analyzer to measuring 99% occupied bandwidth

3.6.2 Test Setup

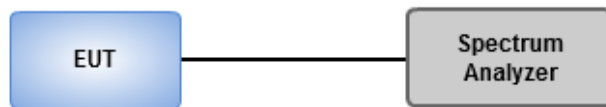

3.6.3 Test result of 20dB and Occupied Bandwidth

Modulation Mode	Freq. (MHz)	20dB Bandwidth (MHz)	Occupied Bandwidth (MHz)
GFSK	2402	0.957	0.886
GFSK	2441	0.952	0.877
GFSK	2480	0.957	0.881
8DPSK	2402	1.287	1.172
8DPSK	2441	1.283	1.190
8DPSK	2480	1.287	1.203

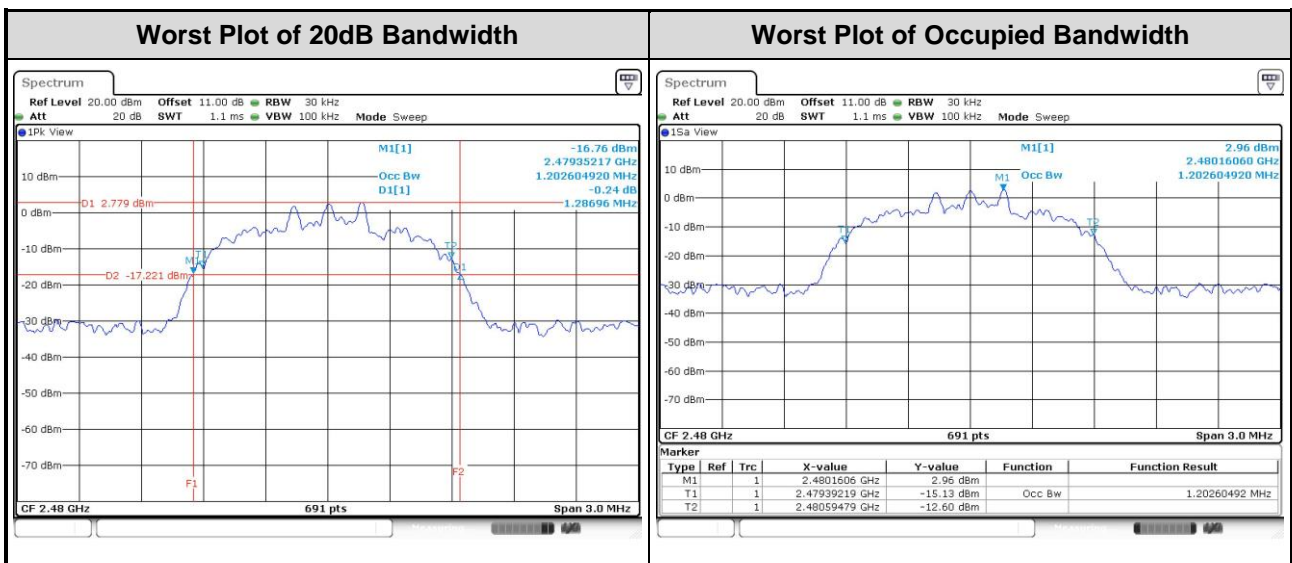

3.7 Channel Separation

3.7.1 Limit of Channel Separation

- Frequency hopping systems shall have hopping channel carrier frequencies separated by a minimum of 25 kHz or the 20 dB bandwidth of the hopping channel, whichever is greater.
- Frequency hopping systems operating in the 2400–2483.5 MHz band may have hopping channel carrier frequencies that are separated by 25 kHz or two-thirds of the 20 dB bandwidth of the hopping channel, whichever is greater.

3.7.2 Test Procedures

1. Set RBW=100kHz, VBW=300kHz, Sweep time = Auto, Detector=Peak Trace max hold
2. Allow trace to stabilize
3. Use the marker-delta function to determine the separation between the peaks of the adjacent channels. The EUT shall show compliance with the appropriate regulatory limit

3.7.3 Test Setup

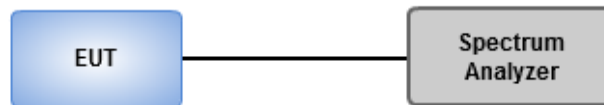

3.7.4 Test result of Channel Separation

Modulation Mode	Freq. (MHz)	Channel Separation (MHz)	20dB Bandwidth (MHz)	Minimum Limit (MHz)
GFSK	2402	1.003	0.957	0.638
GFSK	2441	1.003	0.952	0.635
GFSK	2480	1.003	0.957	0.638
8DPSK	2402	1.003	1.287	0.858
8DPSK	2441	1.003	1.283	0.855
8DPSK	2480	1.003	1.287	0.858

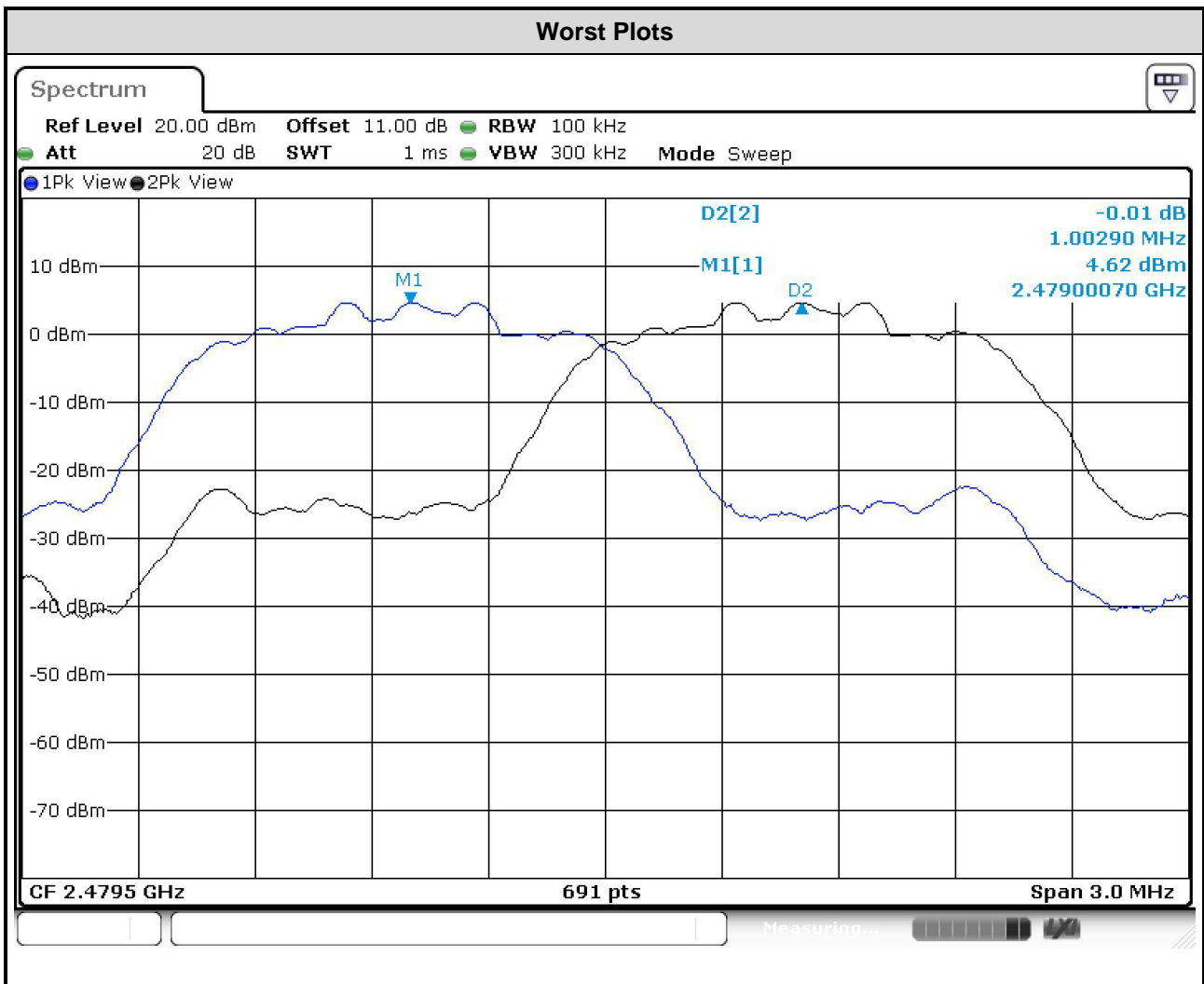

3.8 Number of Dwell Time

3.8.1 Limit of Dwell time

The average time of occupancy on any channel shall not be greater than 0.4 seconds within a period of 0.4 seconds multiplied by the number of hopping channels employed.

3.8.2 Test Procedures

1. Set RBW=100kHz,VBW=300kHz,Sweep time = 500us(DH1),2ms(DH3),4ms(DH5), Detector=Peak, Span=0Hz,Trace max hold
2. Enable gating and trigger function of spectrum analyzer to measure burst on time.
3. The DH1 packet can cover a single time slot. A maximum length packet has duration of 1 time slots. The hopping rate is 1600 hops/second so the maximum dwell time is 1/1600 seconds, or 0.625ms. DH1 Packet permit maximum $1600 / 79 / 2 = 10.12$ hops per second in each channel (1 time slot TX, 1 time slot RX). So, the dwell time is the time duration of the pulse times $10.12 \times 31.6 = 320$ within 31.6 seconds.
4. The DH3 packet can cover up to 3 time slots. A maximum length packet has duration of 3 time slots. The hopping rate is 1600 hops/second so the maximum dwell time is 3/1600 seconds, or 1.875ms. DH3 Packet permit maximum $1600 / 79 / 4 = 5.06$ hops per second in each channel (3 time slots TX, 1 time slot RX). So, the dwell time is the time duration of the pulse times $5.06 \times 31.6 = 160$ within 31.6 seconds.
5. The DH5 packet can cover up to 5 time slots. Operate DH5 at maximum dwell time and maximum duty cycle. A maximum length packet has duration of 5 time slots. The hopping rate is 1600 hops/second so the maximum dwell time is 5/1600 seconds, or 3.125ms. DH5 Packet permit maximum $1600 / 79 / 6 = 3.37$ hops per second in each channel (5 time slots TX, 1 time slot RX). So, the dwell time is the time duration of the pulse times $3.37 \times 31.6 = 106.6$ within 31.6 seconds

3.8.3 Test Setup

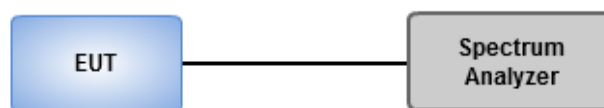

3.8.4 Test Result of Dwell Time

Modulation Mode	Freq. (MHz)	Length of Transmission Time (msec)	Number of Transmission in a 31.6 (79 Hopping*0.4)	Result (s)	Limit (s)
GFSK-DH1	2402	0.43333	320	0.139	0.4
GFSK-DH3	2402	1.69420	160	0.271	0.4
GFSK-DH5	2402	2.94638	106.6	0.314	0.4
8DPSK-DH1	2402	0.44058	320	0.141	0.4
8DPSK-DH3	2402	1.71014	160	0.274	0.4
8DPSK-DH5	2402	2.97246	106.6	0.317	0.4

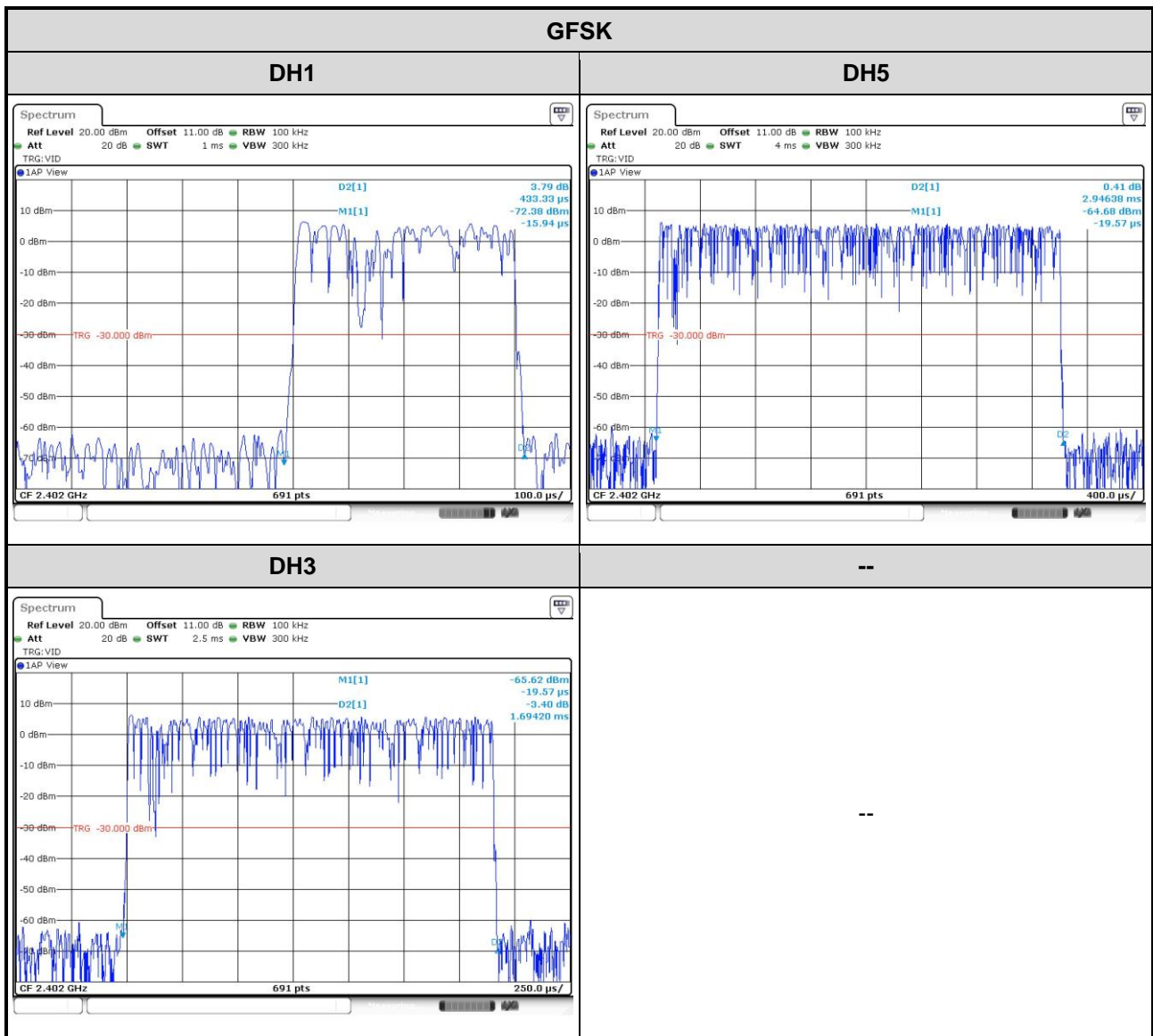

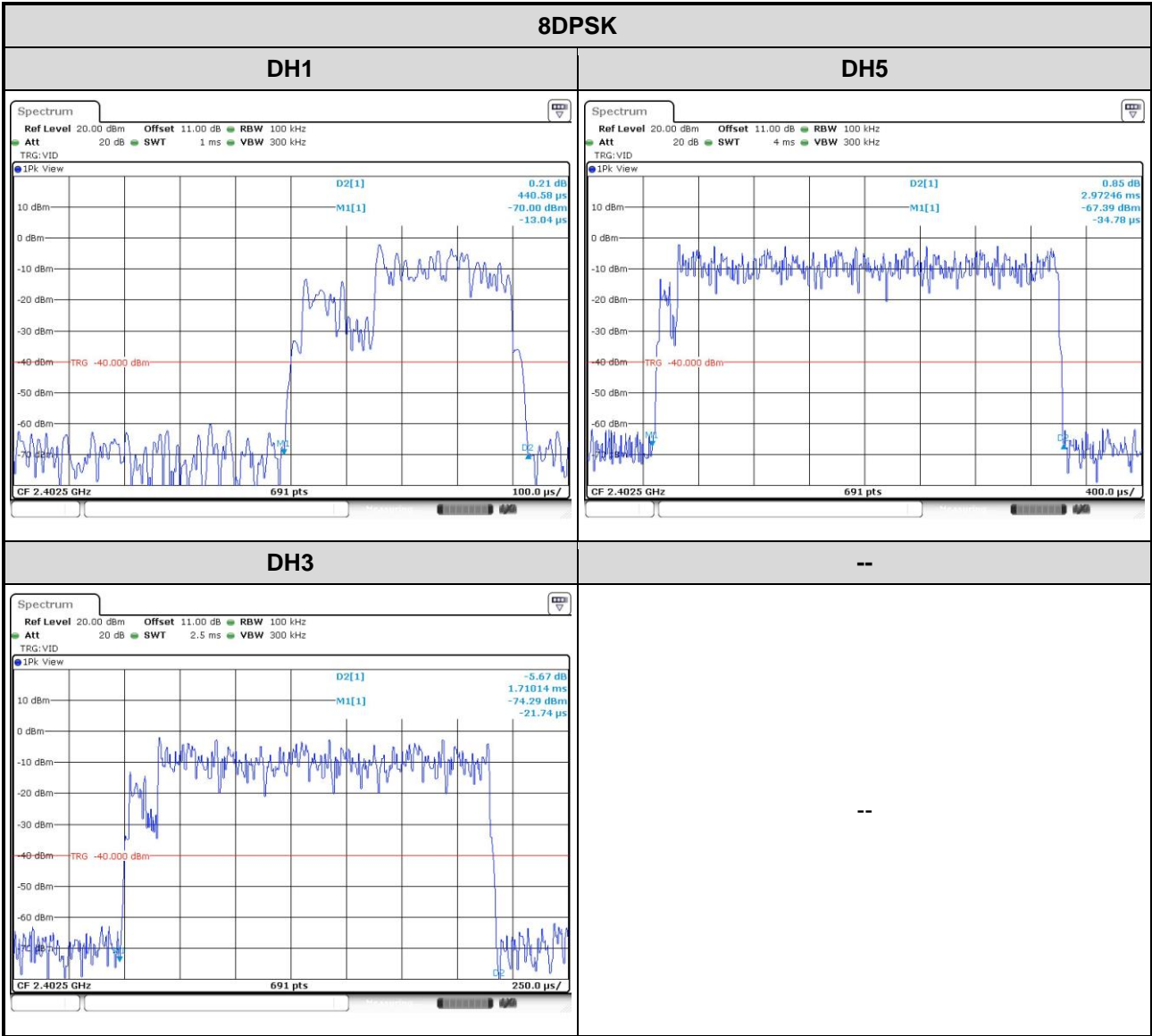

4 Test laboratory information

Established in 2012, ICC provides foremost EMC & RF Testing and advisory consultation services by our skilled engineers and technicians. Our services employ a wide variety of advanced edge test equipment and one of the widest certification extents in the business.

International Certification Corp, it is our definitive objective is to institute long term, trust-based associations with our clients. The expectation we set up with our clients is based on outstanding service, practical expertise and devotion to a certified value structure. Our passion is to grant our clients with best EMC / RF services by oriented knowledgeable and accommodating staff.

Our Test sites are located at Linkou District and Kwei Shan Hsiang. Location map can be found on our website <http://www.icertifi.com.tw>.

Linkou

Tel: 886-2-2601-1640

No. 30-2, Ding Fwu Tsuen, Lin Kou
District, New Taipei City, Taiwan,
R.O.C.

Kwei Shan

Tel: 886-3-271-8666

No. 3-1, Lane 6, Wen San 3rd
St., Kwei Shan Hsiang, Tao Yuan
Hsien 333, Taiwan, R.O.C.

Kwei Shan Site II

Tel: 886-3-271-8640

No. 14-1, Lane 19, Wen San 3rd
St., Kwei Shan Hsiang, Tao Yuan
Hsien 333, Taiwan, R.O.C.

If you have any suggestion, please feel free to contact us as below information

Tel: 886-3-271-8666

Fax: 886-3-318-0155

Email: ICC_Service@icertifi.com.tw

==END==