

FCC Test Report

FCC ID : **SQG-SOM8MPLUS**
Equipment : **Summit SOM 8M Plus System-on-Module - WiFi 5 + Bluetooth 5.3**
Model No. : **Summit SOM 8M Plus**
Brand Name : **Laird Connectivity**
Applicant : **Laird Connectivity LLC**
Address : **W66N220 Commerce Court, Cedarburg, WI 53012 United States Of America**
Standard : **47 CFR FCC Part 15.247**
Received Date : **Oct. 28, 2021**
Tested Date : **Feb. 23 ~ Mar. 07, 2022**

We, International Certification Corporation, would like to declare that the tested sample has been evaluated and in compliance with the requirement of the above standards. The test results contained in this report refer exclusively to the product. It shall not be reproduced except in full without the written approval of our laboratory.

Reviewed by:

Approved by:



Along Chen / Assistant Manager



Gary Chang / Manager

Table of Contents

1	GENERAL DESCRIPTION	5
1.1	Information.....	5
1.2	Local Support Equipment List	7
1.3	Test Setup Chart	7
1.4	Test Equipment List and Calibration Data.....	8
1.5	Test Standards	10
1.6	Reference Guidance	10
1.7	Deviation from Test Standard and Measurement Procedure.....	10
1.8	Measurement Uncertainty	10
2	TEST CONFIGURATION.....	11
2.1	Testing Facility.....	11
2.2	The Worst Test Modes and Channel Details	11
3	TRANSMITTER TEST RESULTS.....	12
3.1	Conducted Emissions.....	12
3.2	6dB and Occupied Bandwidth	15
3.3	RF Output Power	20
3.4	Power Spectral Density	22
3.5	Emissions in Restricted Frequency Bands.....	27
3.6	Emissions in non-restricted Frequency Bands.....	60
4	TEST LABORATORY INFORMATION	64

Release Record

Report No.	Version	Description	Issued Date
FR1O2803AE	Rev. 01	Initial issue	Mar. 24, 2022

Summary of Test Results

FCC Rules	Test Items	Measured	Result
15.207	AC Power Line Conducted Emissions	[dBuV]: 0.365MHz 21.97 (Margin -26.64dB) - AV	Pass
15.247(d) 15.209	Radiated Emissions	[dBuV/m at 3m]: 51.34MHz 36.95 (Margin -3.05dB) - PK	Pass
15.247(b)(3)	Maximum Output Power	Power [dBm]: 7.05	Pass
15.247(a)(2)	6dB Bandwidth	Meet the requirement of limit	Pass
15.247(e)	Power Spectral Density	Meet the requirement of limit	Pass
15.203	Antenna Requirement	Meet the requirement of limit	Pass

Declaration of Conformity:

The test results with all measurement uncertainty excluded are presented in accordance with the regulation limits or requirements declared by manufacturers.

Comments and Explanations:

The declared of product specification for EUT presented in the report are provided by the manufacturer, and the manufacturer takes all the responsibilities for the accuracy of product specification.

1 General Description

1.1 Information

The device has 3 hardware configurations as below:

No.	Brand name	Model Name	Part Number	Description
1	Laird Connectivity	Summit SOM 8M Plus	453-00070	512MB LPDDR4 and 8GB eMMC
2			453-00071	1GB LPDDR4 and 8GB eMMC
3			453-00072	2GB LPDDR4 and 16GB eMMC

1.1.1 Specification of the Equipment under Test (EUT)

RF General Information				
Frequency Range (MHz)	Bluetooth Mode	Ch. Freq. (MHz)	Channel Number	Data Rate
2400-2483.5	V5.3 LE	2402-2480	0-39 [40]	1 Mbps
2400-2483.5	V5.3 LE	2402-2480	0-39 [40]	2 Mbps

Note: Bluetooth LE (Low energy) uses GFSK modulation.

1.1.2 Antenna Details

Ant. No.	Model	Part Number	Type	Connector	Gain (dBi)
1	Nanoblade	CAF94505	PCB Dipole	IPEX U.FL	2.0
2	Mini NanoBlade Flex	MAF95310	PCB Dipole	IPEX U.FL	2.8
3	FlexMIMO	EFD2455A3S-10MHF1	PCB Dipole	IPEX U.FL	2.0
4	2.4/5.5 GHz FlexPIFA	001-0016	PIFA	IPEX U.FL	2.5
5	001-0009	001-0009	Dipole	RP-SMA	2.0

Note: Antenna 2 with highest gain was chosen for final test

1.1.3 Power Supply Type of Equipment under Test (EUT)

Power Supply Type	5Vdc from host
--------------------------	----------------

1.1.4 Accessories

N/A

1.1.5 Channel List

Frequency band (MHz)				2400~2483.5			
Channel	Frequency (MHz)	Channel	Frequency (MHz)	Channel	Frequency (MHz)	Channel	Frequency (MHz)
37	2402	9	2422	18	2442	28	2462
0	2404	10	2424	19	2444	29	2464
1	2406	38	2426	20	2446	30	2466
2	2408	11	2428	21	2448	31	2468
3	2410	12	2430	22	2450	32	2470
4	2412	13	2432	23	2452	33	2472
5	2414	14	2434	24	2454	34	2474
6	2416	15	2436	25	2456	35	2476
7	2418	16	2438	26	2458	36	2478
8	2420	17	2440	27	2460	39	2480

1.1.6 Test Tool and Duty Cycle

Test Tool	Tera Term, Version: V4.94	
Modulation Mode	Duty Cycle Of Test Signal (%)	Duty Factor (dB)
GFSK-1Mbps	64.52	1.90
GFSK-2Mbps	35.65	4.48

1.1.7 Power Index of Test Tool

Modulation Mode	Test Frequency (MHz)		
	2402	2440	2480
GFSK/1Mbps	default	default	default
GFSK/2Mbps	default	default	default

1.2 Local Support Equipment List

Support Equipment List					
No.	Equipment	Brand	Model	FCC ID	Remarks
1	Notebook	DELL	Latitude 5400	DoC	---
2	Carrier Board	---	---	---	Provided by applicant.
3	USB Cable	ICC	micro to A	---	---
4	USB console cable	---	---	---	Provided by applicant.

1.3 Test Setup Chart

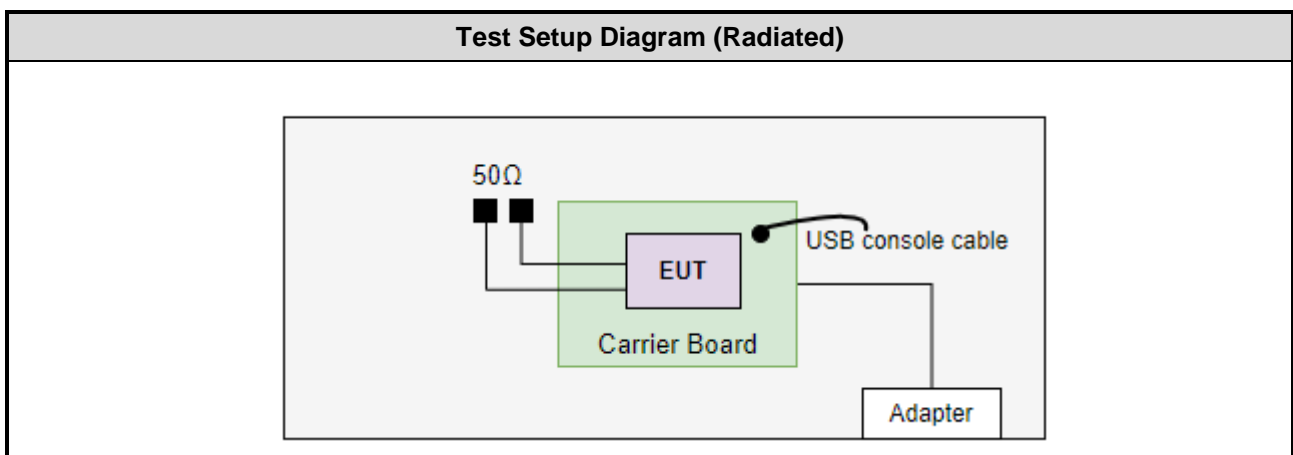
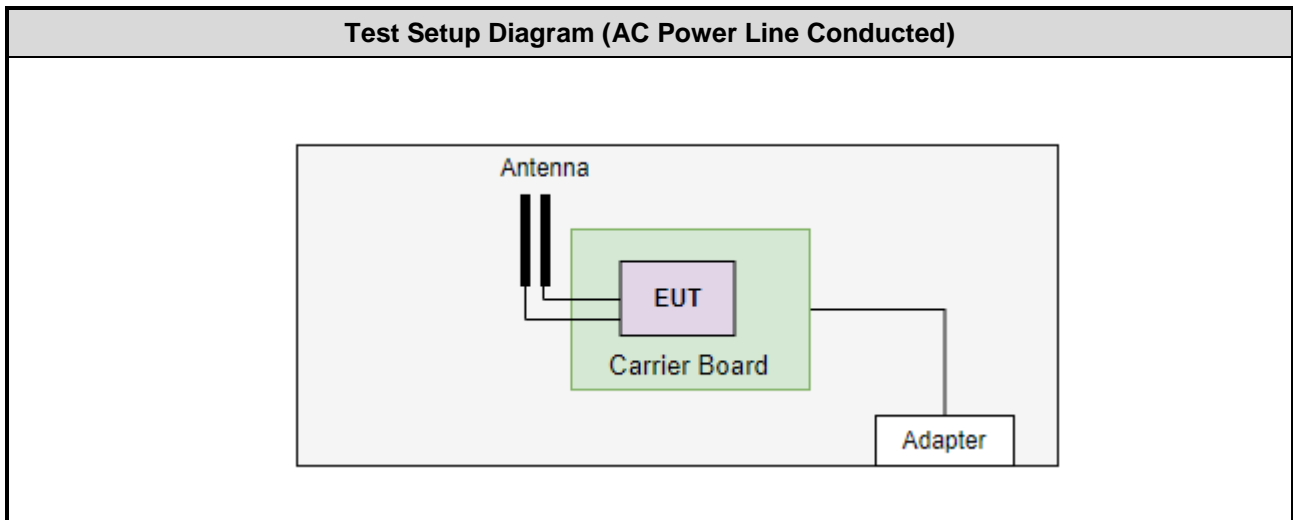

Note: The support notebook and USB cable were disconnected from EUT and removed from test table when EUT is set to transmit continuously.

1.4 Test Equipment List and Calibration Data

Test Item	Conducted Emission				
Test Site	Conduction room 1 / (CO01-WS)				
Tested Date	Mar. 03, 2022				
Instrument	Brand	Model No.	Serial No.	Calibration Date	Calibration Until
Receiver	R&S	ESR3	101658	Feb. 16, 2022	Feb. 15, 2023
LISN	R&S	ENV216	101579	Mar. 17, 2021	Mar. 16, 2022
LISN (Support Unit)	SCHWARZBECK MESS-ELEKTRONIK	NSLK 8127	8127667	Jan .07, 2022	Jan .06, 2023
RF Cable-CON	Woken	CFD200-NL	CFD200-NL-001	Oct. 19, 2021	Oct. 18, 2022
50 ohm terminal (Support Unit)	NA	50	04	May 25, 2021	May 24, 2022
Measurement Software	AUDIX	e3	6.120210k	NA	NA
Note: Calibration Interval of instruments listed above is one year.					

Test Item	RF Conducted				
Test Site	(TH01-WS)				
Tested Date	Mar. 07, 2022				
Instrument	Brand	Model No.	Serial No.	Calibration Date	Calibration Until
Spectrum Analyzer	R&S	FSV40	101498	Nov. 29, 2021	Nov. 28, 2022
Power Meter	Anritsu	ML2495A	1241002	Nov. 07, 2021	Nov. 06, 2022
Power Sensor	Anritsu	MA2411B	1207366	Nov. 07, 2021	Nov. 06, 2022
Measurement Software	Sporton	SENSE-15247_FS	V5.10.7.11	NA	NA
Note: Calibration Interval of instruments listed above is one year.					

Test Item	Radiated Emission				
Test Site	966 chamber1 / (03CH01-WS)				
Tested Date	Feb. 23 ~ Feb. 25, 2022				
Instrument	Brand	Model No.	Serial No.	Calibration Date	Calibration Until
Receiver	R&S	ESR3	101657	Mar. 12, 2021	Mar. 11, 2022
Spectrum Analyzer	R&S	FSV40	101063	Apr. 19, 2021	Apr. 18, 2022
Loop Antenna	R&S	HFH2-Z2	100330	Nov. 08, 2021	Nov. 07, 2022
Bilog Antenna	SCHWARZBECK	VULB9168	VULB9168-522	Jun. 30, 2021	Jun. 29, 2022
Horn Antenna 1G-18G	SCHWARZBECK	BBHA 9120 D	BBHA 9120 D 1096	Dec. 03, 2021	Dec. 02, 2022
Horn Antenna 18G-40G	SCHWARZBECK	BBHA 9170	BBHA 9170508	Jan. 11, 2022	Jan. 10, 2023
Preamplifier	EMC	EMC02325	980225	Jun. 29, 2021	Jun. 28, 2022
Preamplifier	Agilent	83017A	MY39501308	Sep. 28, 2021	Sep. 27, 2022
Preamplifier	EMC	EMC184045B	980192	Jul. 14, 2021	Jul. 13, 2022
Loop Antenna Cable	KOAX KABEL	101354-BW	101354-BW	Oct. 05, 2021	Oct. 04, 2022
LF cable 3M	Woken	CFD400NL-LW	CFD400NL-001	Oct. 05, 2021	Oct. 04, 2022
LF cable 11M	EMC	EMCCFD400-NW-N W-11000	200801	Oct. 05, 2021	Oct. 04, 2022
LF cable 1M	EMC	EMCCFD400-NM-N M-1000	160502	Oct. 05, 2021	Oct. 04, 2022
RF Cable	EMC	EMC104-35M-35M- 8000	210920	Oct. 05, 2021	Oct. 04, 2022
RF Cable	HUBER+SUHNER	SUCOFLEX104	MY16019/4	Oct. 05, 2021	Oct. 04, 2022
Measurement Software	AUDIX	e3	6.120210g	NA	NA
Wireless connectivity tester	R&S	CMW270	100856	Nov. 01, 2021	Oct. 31, 2022
Note: Calibration Interval of instruments listed above is one year.					

1.5 Test Standards

47 CFR FCC Part 15.247

ANSI C63.10-2013

1.6 Reference Guidance

FCC KDB 558074 D01 15.247 Meas Guidance v05r02

1.7 Deviation from Test Standard and Measurement Procedure

None

1.8 Measurement Uncertainty

The measurement uncertainties given below are based on a 95% confidence level (based on a coverage factor ($k=2$)).

Measurement Uncertainty	
Parameters	Uncertainty
Bandwidth	± 34.130 Hz
Conducted power	± 0.808 dB
Power density	± 0.583 dB
Conducted emission	± 2.715 dB
AC conducted emission	± 2.92 dB
Radiated emission ≤ 1 GHz	± 3.41 dB
Radiated emission > 1 GHz	± 4.59 dB

2 Test Configuration

2.1 Testing Facility

Test Laboratory	International Certification Corporation
Test Site	CO01-WS, 03CH01-WS, TH01-WS
Address of Test Site	No.3-1, Lane 6, Wen San 3rd St., Kwei Shan Dist., Tao Yuan City 33381, Taiwan (R.O.C.)

- FCC Designation No.: TW2732
- FCC site registration No.: 181692
- ISED#: 10807A
- CAB identifier: TW2732

2.2 The Worst Test Modes and Channel Details

Test item	Mode	Test Frequency (MHz)	Data Rate	Test Configuration
AC Power Line Conducted Emissions Radiated Emissions \leq 1GHz	BT LE	2440	1Mbps	---
Maximum Output Power 6dB bandwidth Power spectral density Radiated Emissions > 1GHz	BT LE BT LE	2402, 2440, 2480 2402, 2440, 2480	1Mbps 2Mbps	---

NOTE:

1. The EUT was pretested with 3 orientations placed on the table for the radiated emission measurement – X, Y, and Z-plane. The **Z-plane** result was found as the worst case and was shown in this report.
2. The 50 Ω terminators are connected to antenna port of EUT for radiated emission measurement.

3 Transmitter Test Results

3.1 Conducted Emissions

3.1.1 Limit of Conducted Emissions

Conducted Emissions Limit		
Frequency Emission (MHz)	Quasi-Peak	Average
0.15-0.5	66 - 56 *	56 - 46 *
0.5-5	56	46
5-30	60	50

Note 1: * Decreases with the logarithm of the frequency.

3.1.2 Test Procedures

1. The device is placed on a test table, raised 80 cm above the reference ground plane. The vertical conducting plane is located 40 cm to the rear of the device.
2. The device is connected to line impedance stabilization network (LISN) and other accessories are connected to other LISN. Measured levels of AC power line conducted emission are across the 50 Ω LISN port.
3. AC conducted emission measurements is made over frequency range from 150 kHz to 30 MHz.
4. This measurement was performed with AC 120V/60Hz

3.1.3 Test Setup



- Note: 1. Support units were connected to second LISN.
 2. Both of LISNs (AMN) are 80 cm from EUT and at least 80 cm from other units and other metal planes

3.1.4 Test Result of Conducted Emissions

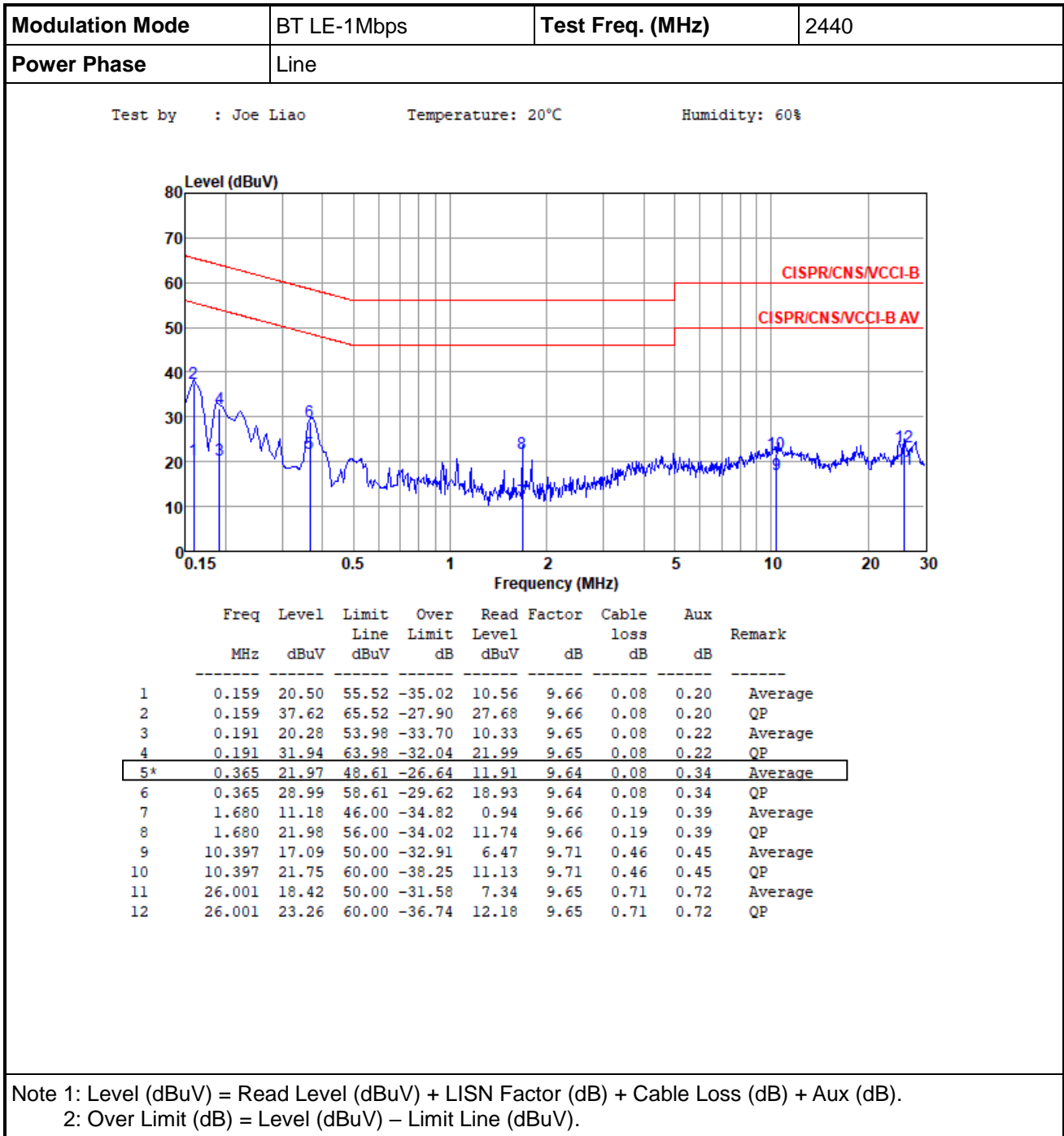

Modulation Mode	BT LE-1Mbps	Test Freq. (MHz)	2440
Power Phase	Neutral		

Test by : Joe Liao Temperature: 20°C Humidity: 60%

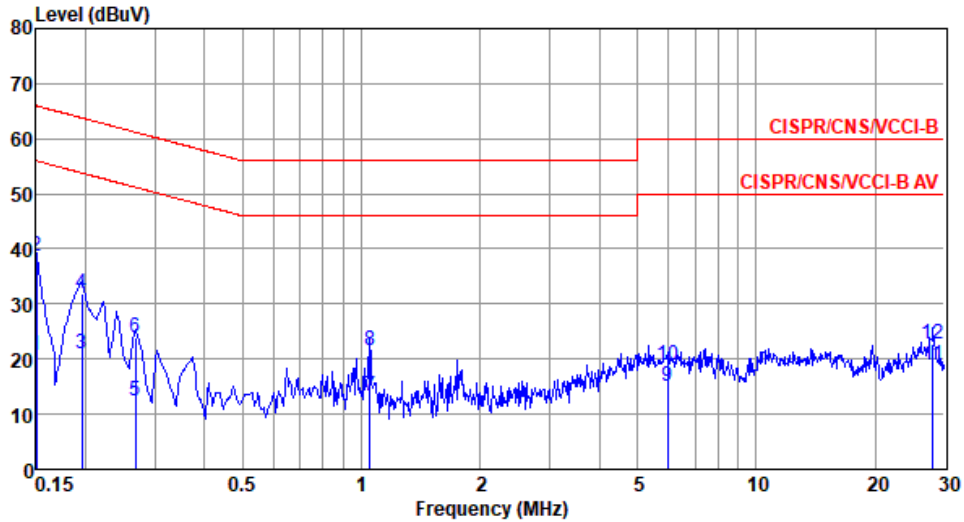

	Freq MHz	Level dBuV	Limit Line dBuV	Over Limit dB	Read Level dBuV	Factor dB	Cable loss dB	Aux dB	Remark
1	0.150	20.73	56.00	-35.27	10.80	9.69	0.08	0.16	Average
2*	0.150	38.68	66.00	-27.32	28.75	9.69	0.08	0.16	QP
3	0.195	20.91	53.80	-32.89	10.97	9.68	0.08	0.18	Average
4	0.195	32.01	63.80	-31.79	22.07	9.68	0.08	0.18	QP
5	0.267	12.42	51.20	-38.78	2.48	9.68	0.08	0.18	Average
6	0.267	23.91	61.20	-37.29	13.97	9.68	0.08	0.18	QP
7	1.049	13.31	46.00	-32.69	3.19	9.68	0.16	0.28	Average
8	1.049	21.69	56.00	-34.31	11.57	9.68	0.16	0.28	QP
9	5.961	15.14	50.00	-34.86	4.75	9.73	0.31	0.35	Average
10	5.961	18.92	60.00	-41.08	8.53	9.73	0.31	0.35	QP
11	28.003	18.80	50.00	-31.20	7.46	9.85	0.76	0.73	Average
12	28.003	22.64	60.00	-37.36	11.30	9.85	0.76	0.73	QP

Note 1: Level (dBuV) = Read Level (dBuV) + LISN Factor (dB) + Cable Loss (dB) + Aux (dB).
 Note 2: Over Limit (dB) = Level (dBuV) – Limit Line (dBuV).

3.2 6dB and Occupied Bandwidth

3.2.1 Limit of 6dB Bandwidth

The minimum 6dB bandwidth shall be at least 500 kHz.

3.2.2 Test Procedures

6dB Bandwidth

1. Set resolution bandwidth (RBW) = 100 kHz, Video bandwidth = 300 kHz.
2. Detector = Peak, Trace mode = max hold.
3. Sweep = auto couple, Allow the trace to stabilize.
4. Measure the maximum width of the emission that is constrained by the frequencies associated with the two outermost amplitude points (upper and lower) that are attenuated by 6dB relative to the maximum level measured in the fundamental emission.

Occupied Bandwidth

1. Set resolution bandwidth (RBW) = 1% ~ 5 % of OBW, Video bandwidth = 3 x RBW
2. Detector = Sample, Trace mode = max hold.
3. Sweep = auto couple, Allow the trace to stabilize.
4. Use the OBW measurement function of spectrum analyzer to measure the occupied bandwidth.

3.2.3 Test Setup

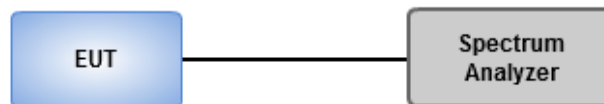

3.2.4 Test Result of 6dB and Occupied Bandwidth

Ambient Condition	20°C / 66%	Tested By	Aska Huang
--------------------------	------------	------------------	------------

Summary

Mode	Max-N dB (Hz)	Max-OBW (Hz)	ITU-Code	Min-N dB (Hz)	Min-OBW (Hz)
2.4-2.4835GHz	-	-	-	-	-
BT-LE(1Mbps)	684.783k	1.024M	1M02F1D	673.913k	1.024M
BT-LE(2Mbps)	1.159M	2.033M	2M03F1D	1.152M	2.026M

Max-N dB = Maximum 6dB down bandwidth; Max-OBW = Maximum 99% occupied bandwidth;
Min-N dB = Minimum 6dB down bandwidth; Min-OBW = Minimum 99% occupied bandwidth

Result

Mode	Result	Limit (Hz)	Port 1-N dB (Hz)	Port 1-OBW (Hz)
BT-LE(1Mbps)	-	-	-	-
2402MHz	Pass	500k	673.913k	1.024M
2440MHz	Pass	500k	684.783k	1.024M
2480MHz	Pass	500k	684.783k	1.024M
BT-LE(2Mbps)	-	-	-	-
2402MHz	Pass	500k	1.159M	2.033M
2440MHz	Pass	500k	1.159M	2.026M
2480MHz	Pass	500k	1.152M	2.033M

Port X-N dB = Port X 6dB down bandwidth;
Port X-OBW = Port X 99% occupied bandwidth

BT-LE(1Mbps)

EBW-DTS

2402MHz

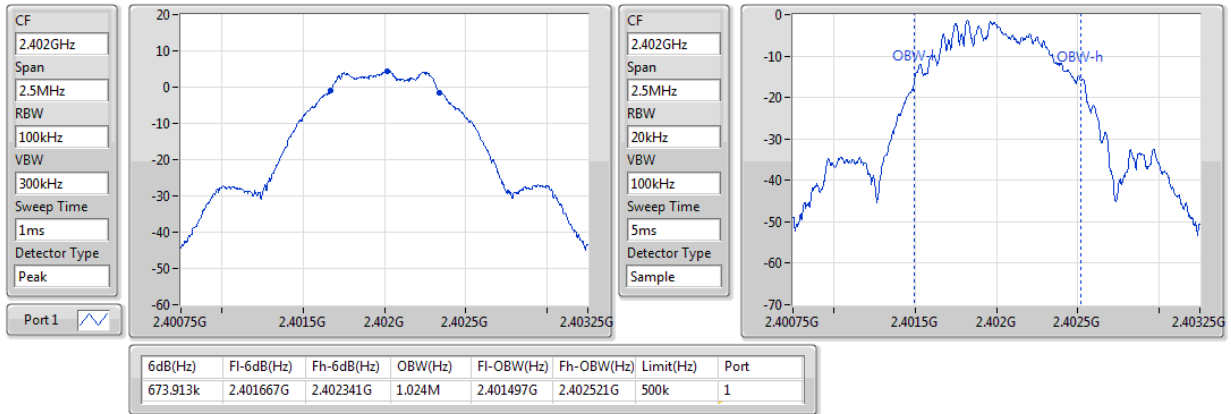

BT-LE(1Mbps)

EBW-DTS

2440MHz

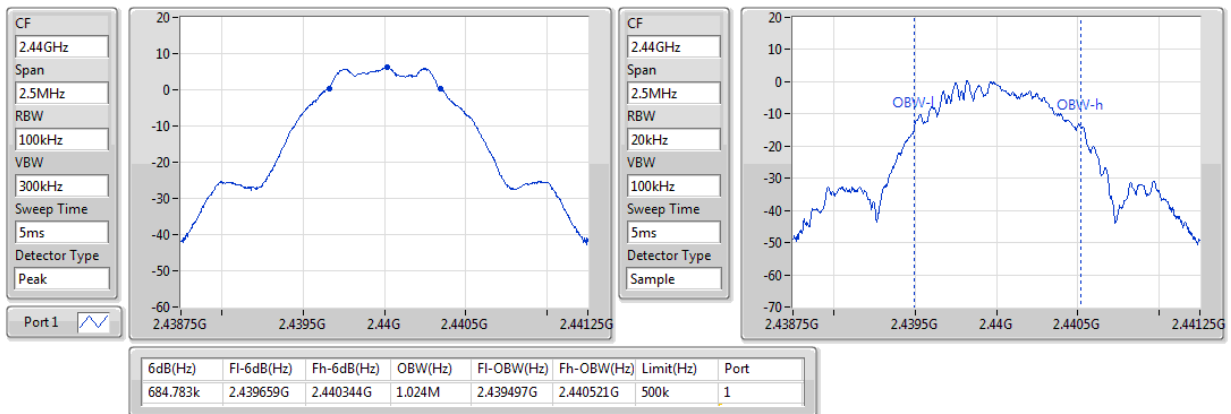

BT-LE(1Mbps)

EBW-DTS

2480MHz

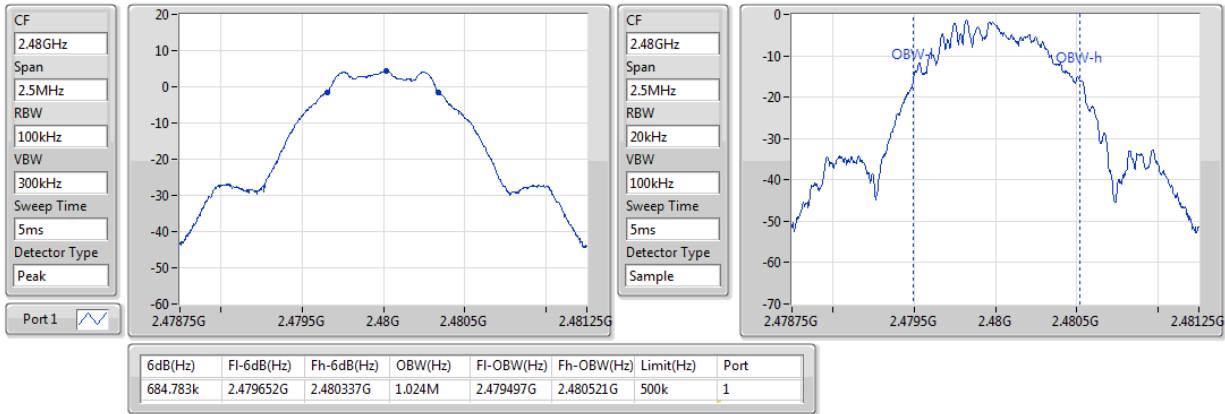

BT-LE(2Mbps)

EBW-DTS

2402MHz

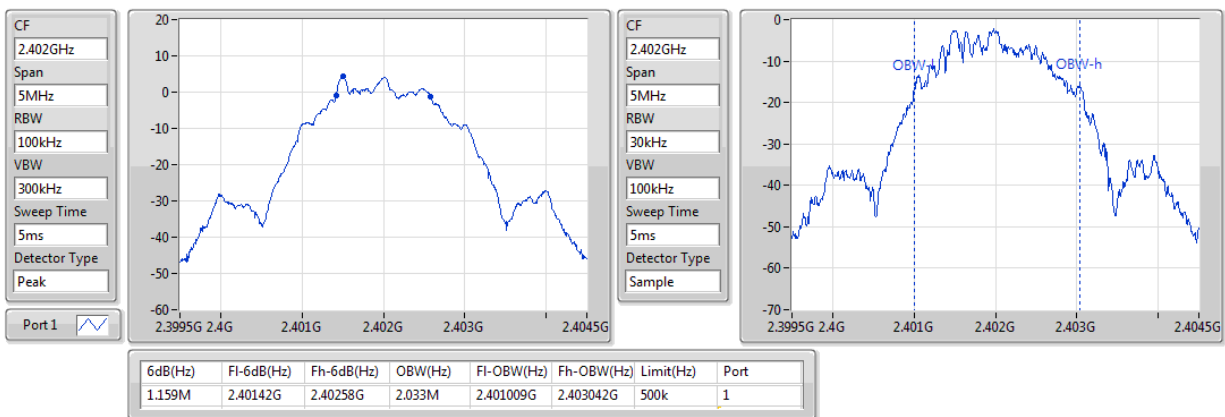

BT-LE(2Mbps)

EBW-DTS

2440MHz

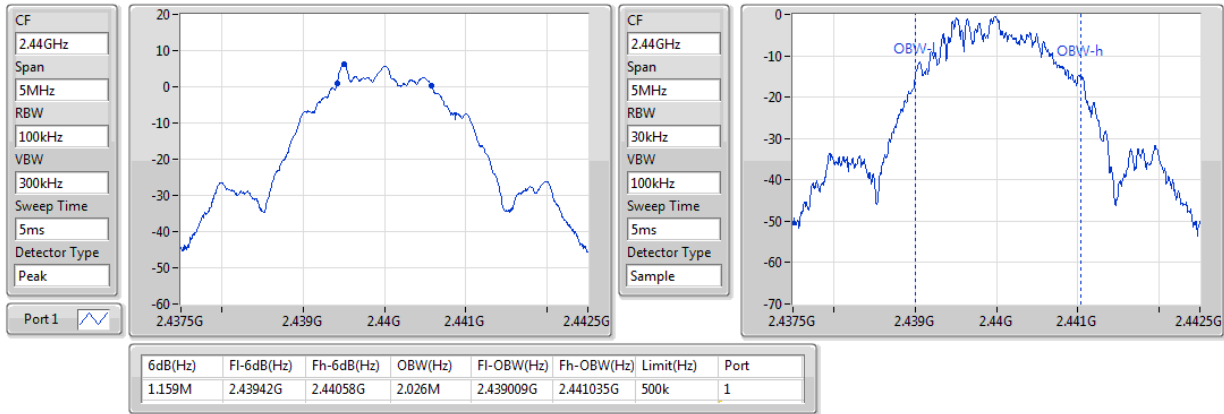

BT-LE(2Mbps)

EBW-DTS

2480MHz

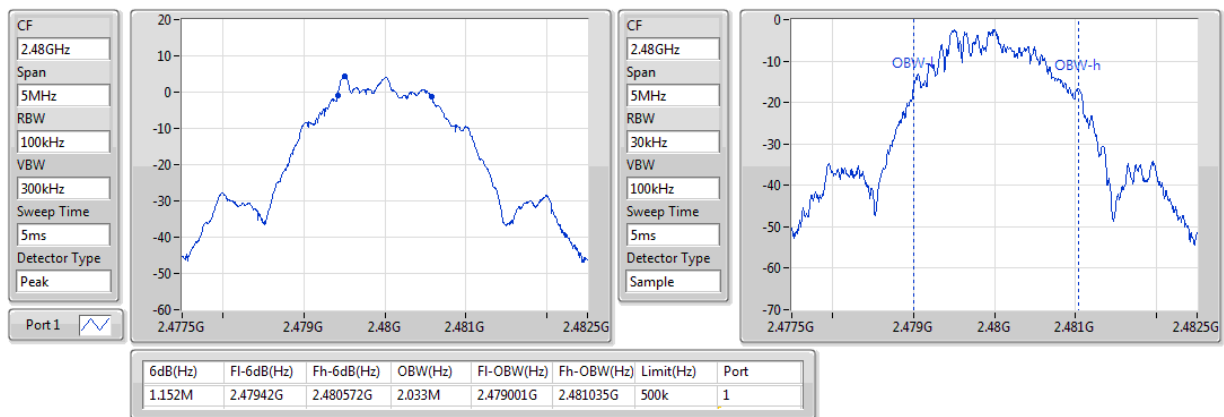

3.3 RF Output Power

3.3.1 Limit of RF Output Power

Conducted power shall not exceed 1Watt.

Antenna gain $\leq 6\text{dBi}$, no any corresponding reduction is in output power limit.

3.3.2 Test Procedures

A broadband RF power meter is used for output power measurement. The video bandwidth of power meter is greater than DTS bandwidth of EUT. If duty cycle of test signal is not 100 %, trigger and gating function of power meter will be enabled to capture transmission burst for measuring output power.

3.3.3 Test Setup

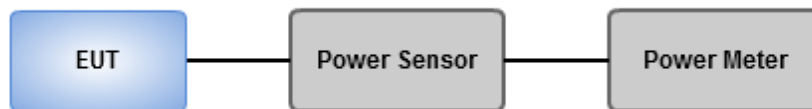

3.3.4 Test Result of Maximum Output Power

Ambient Condition	20°C / 66%	Tested By	Aska Huang
--------------------------	------------	------------------	------------

Summary of Peak Conducted Output Power

Mode	Power (dBm)	Power (W)
2.4-2.4835GHz	-	-
BT-LE(1Mbps)	7.05	0.00507
BT-LE(2Mbps)	7.02	0.00504

Result

Mode	Result	Antenna Gain (dBi)	Power (dBm)	Power Limit (dBm)
BT-LE(1Mbps)	-	-	-	-
2402MHz	Pass	2.80	5.51	30.00
2440MHz	Pass	2.80	7.05	30.00
2480MHz	Pass	2.80	5.77	30.00
BT-LE(2Mbps)	-	-	-	-
2402MHz	Pass	2.80	5.49	30.00
2440MHz	Pass	2.80	7.02	30.00
2480MHz	Pass	2.80	5.75	30.00

Summary of Conducted (Average) Output Power

Mode	Power (dBm)	Power (W)
2.4-2.4835GHz	-	-
BT-LE(1Mbps)	6.95	0.00495
BT-LE(2Mbps)	6.92	0.00492

Result

Mode	Result	Antenna Gain (dBi)	Power (dBm)	Power Limit (dBm)
BT-LE(1Mbps)	-	-	-	-
2402MHz	Pass	2.80	5.36	-
2440MHz	Pass	2.80	6.95	-
2480MHz	Pass	2.80	5.63	-
BT-LE(2Mbps)	-	-	-	-
2402MHz	Pass	2.80	5.35	-
2440MHz	Pass	2.80	6.92	-
2480MHz	Pass	2.80	5.62	-

Note: Average power is for reference only.

3.4 Power Spectral Density

3.4.1 Limit of Power Spectral Density

Power spectral density shall not be greater than 8 dBm in any 3 kHz band.

3.4.2 Test Procedures

Peak PSD

1. Set the RBW = 3 kHz, VBW = 10 kHz.
2. Detector = Peak, Sweep time = auto couple.
3. Trace mode = max hold, allow trace to fully stabilize.
4. Use the peak marker function to determine the maximum amplitude level.

Average PSD, duty cycle $\geq 98\%$

1. Set the RBW = 30 kHz, VBW = 100 kHz.
2. Detector = RMS, Sweep time = auto couple.
3. Sweep time = auto couple.
4. Employ trace averaging (RMS) mode over a minimum of 100 traces.
5. Use the peak marker function to determine the maximum amplitude level.

Average PSD, duty cycle $< 98\%$

1. Set the RBW = 30 kHz, VBW = 100 kHz. Detector = RMS.
2. Set the sweep time to: ≥ 10 (number of measurement points in sweep) \times (total on/off period of the transmitted signal).
3. Perform the measurement over a single sweep.
4. Use the peak marker function to determine the maximum amplitude level.
5. Add $10 \log (1/x)$, where x is the duty cycle.

3.4.3 Test Setup

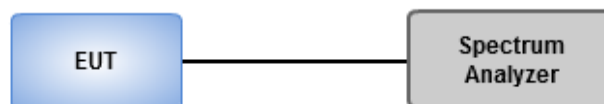

3.4.4 Test Result of Power Spectral Density

Ambient Condition	20°C / 66%	Tested By	Aska Huang
--------------------------	------------	------------------	------------

Summary

Mode	PD (dBm/3kHz)
2.4-2.4835GHz	-
BT-LE(1Mbps)	-8.73
BT-LE(2Mbps)	-11.73

Result

Mode	Result	Antenna Gain (dBi)	Power Density (dBm/3kHz)	Power Density Limit (dBm/3kHz)
BT-LE(1Mbps)	-	-	-	-
2402MHz	Pass	2.80	-10.46	8.00
2440MHz	Pass	2.80	-8.73	8.00
2480MHz	Pass	2.80	-10.41	8.00
BT-LE(2Mbps)	-	-	-	-
2402MHz	Pass	2.80	-13.51	8.00
2440MHz	Pass	2.80	-11.73	8.00
2480MHz	Pass	2.80	-13.44	8.00

BT-LE(1Mbps)

PSD

2402MHz

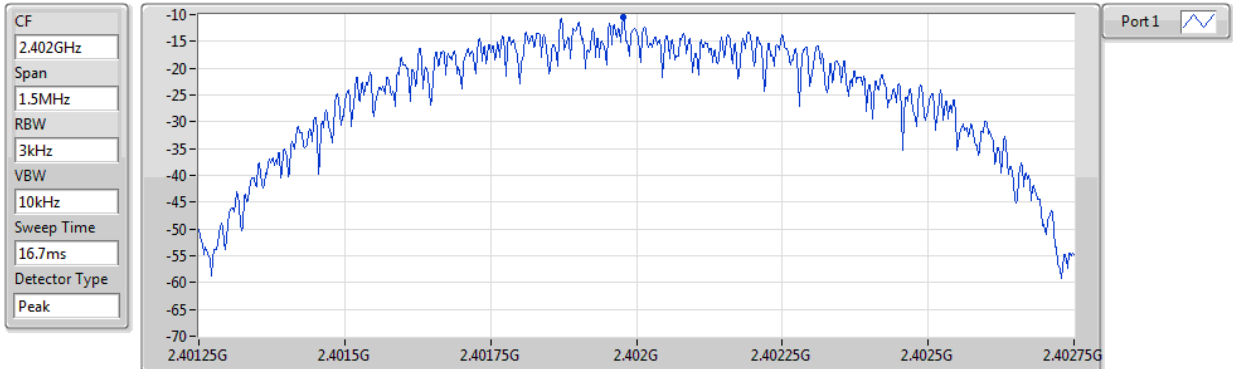

Sum	PD	Port 1
(dBm/RBW)	(dBm/RBW)	(dBm/RBW)
-10.46	-10.46	-10.46

BT-LE(1Mbps)

PSD

2440MHz

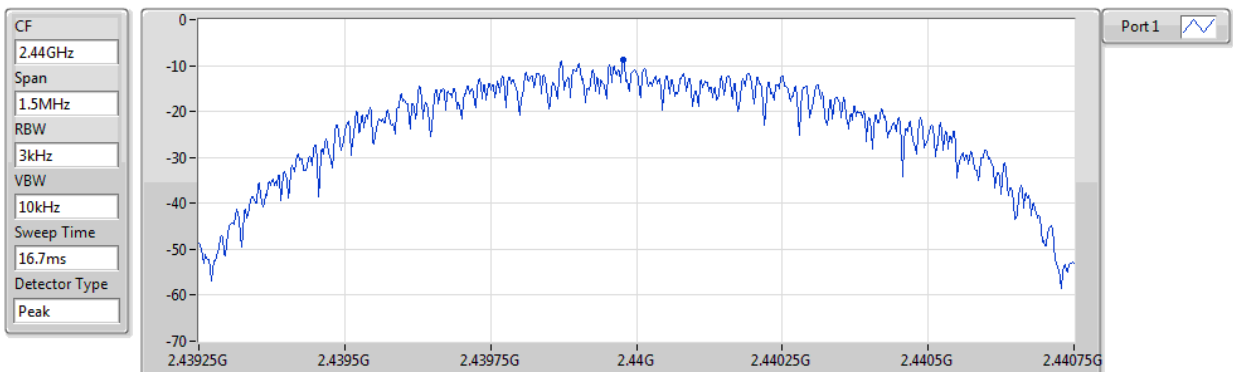

Sum	PD	Port 1
(dBm/RBW)	(dBm/RBW)	(dBm/RBW)
-8.73	-8.73	-8.73

BT-LE(1Mbps)

PSD

2480MHz

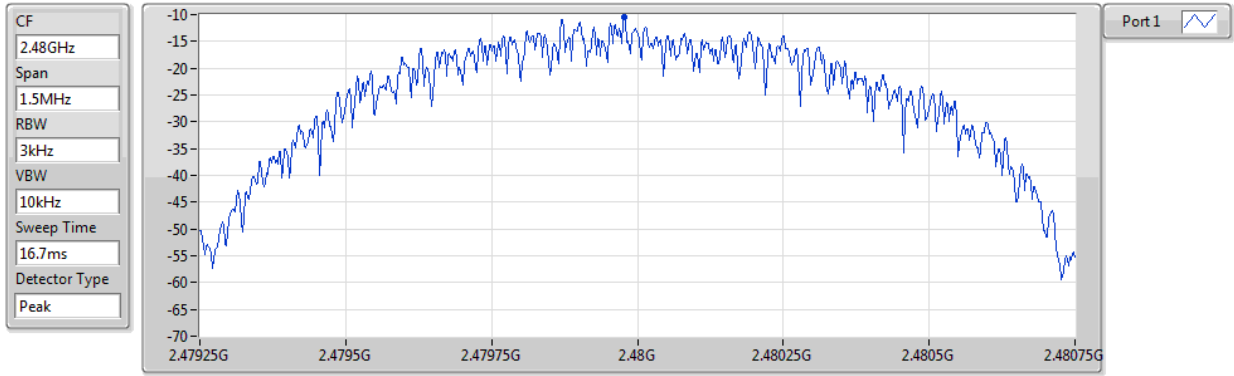

Sum	PD	Port 1
(dBm/RBW)	(dBm/RBW)	(dBm/RBW)
-10.41	-10.41	-10.41

BT-LE(2Mbps)

PSD

2402MHz

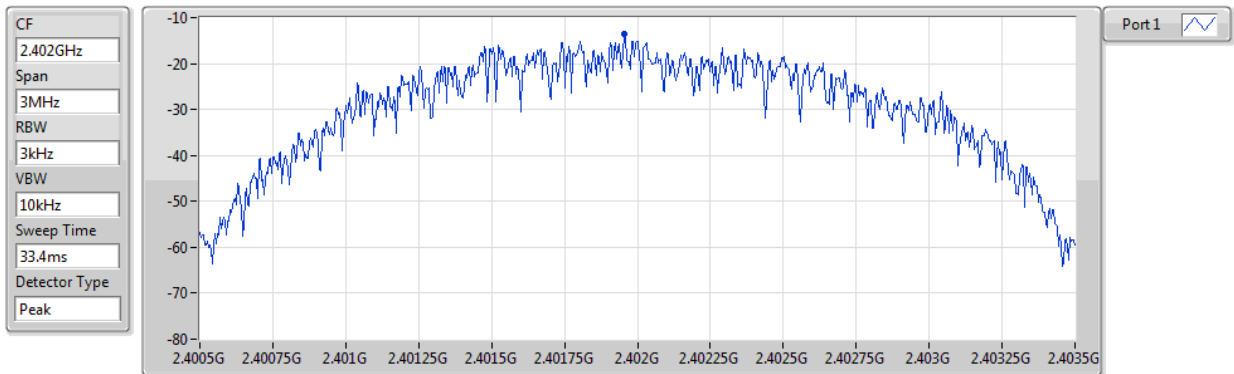

Sum	PD	Port 1
(dBm/RBW)	(dBm/RBW)	(dBm/RBW)
-13.51	-13.51	-13.51

BT-LE(2Mbps)

PSD

2440MHz

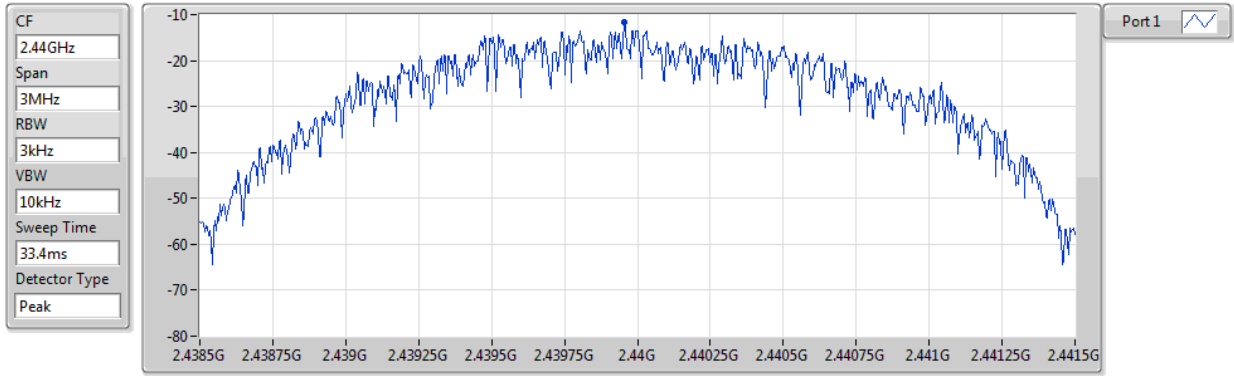

Sum	PD	Port 1
(dBm/RBW)	(dBm/RBW)	(dBm/RBW)
-11.73	-11.73	-11.73

BT-LE(2Mbps)

PSD

2480MHz

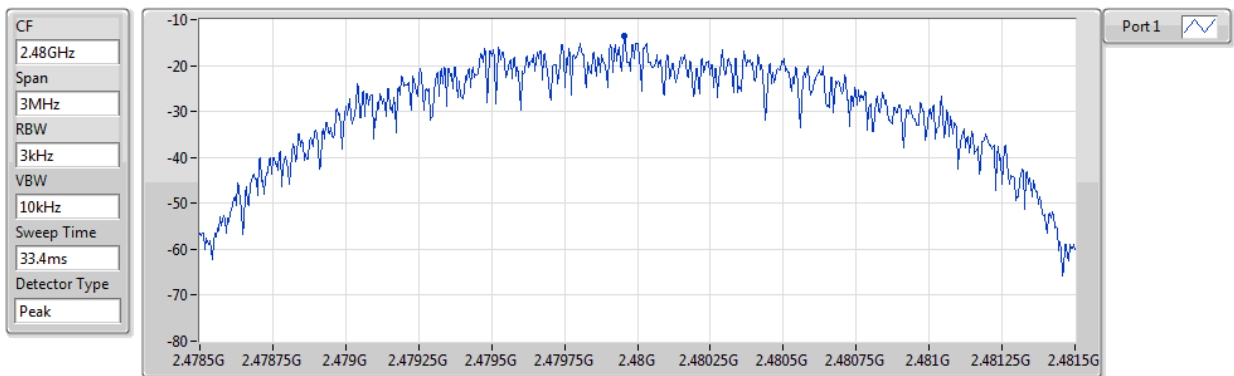

Sum	PD	Port 1
(dBm/RBW)	(dBm/RBW)	(dBm/RBW)
-13.44	-13.44	-13.44

3.5 Emissions in Restricted Frequency Bands

3.5.1 Limit of Emissions in Restricted Frequency Bands

Restricted Band Emissions Limit			
Frequency Range (MHz)	Field Strength (uV/m)	Field Strength (dBuV/m)	Measure Distance (m)
0.009~0.490	2400/F(kHz)	48.5 - 13.8	300
0.490~1.705	24000/F(kHz)	33.8 - 23	30
1.705~30.0	30	29	30
30~88	100	40	3
88~216	150	43.5	3
216~960	200	46	3
Above 960	500	54	3

Note 1:
Quasi-Peak value is measured for frequency below 1GHz except for 9–90 kHz, 110–490 kHz frequency band. Peak and average value are measured for frequency above 1GHz. The limit on average radio frequency emission is as above table. The limit on peak radio frequency emissions is 20 dB above the maximum permitted average emission limit

Note 2:
Measurements may be performed at a distance other than what is specified provided. When performing measurements at a distance other than that specified, the results shall be extrapolated to the specified distance using an extrapolation factor as below, Frequency at or above 30 MHz: 20 dB/decade Frequency below 30 MHz: 40 dB/decade.

3.5.2 Test Procedures

1. Measurement is made at a semi-anechoic chamber that incorporates a turntable allowing a EUT rotation of 360°. A continuously-rotating, remotely-controlled turntable is installed at the test site to support the EUT and facilitate determination of the direction of maximum radiation for each EUT emission frequency. The EUT is placed at test table. For emissions testing at or below 1 GHz, the table height is 80 cm above the reference ground plane. For emission measurements above 1 GHz, the table height is 1.5 m
2. Measurement is made with the antenna positioned in both the horizontal and vertical planes of polarization. The measurement antenna is varied in height (1m ~ 4m) above the reference ground plane to obtain the maximum signal strength. Distance between EUT and antenna is 3 m.
3. This investigation is performed with the EUT rotated 360°, the antenna height scanned between 1 m and 4 m, and the antenna rotated to repeat the measurements for both the horizontal and vertical antenna polarizations.

Note:

1. 120kHz measurement bandwidth of test receiver and Quasi-peak detector is for radiated emission below 1GHz.
2. RBW=1MHz, VBW=3MHz and Peak detector is for peak measured value of radiated emission above 1GHz.
3. RBW=1MHz, VBW=1/T and Peak detector is for average measured value of radiated emission above 1GHz.

3.5.3 Test Setup

Radiated Emissions below 1 GHz

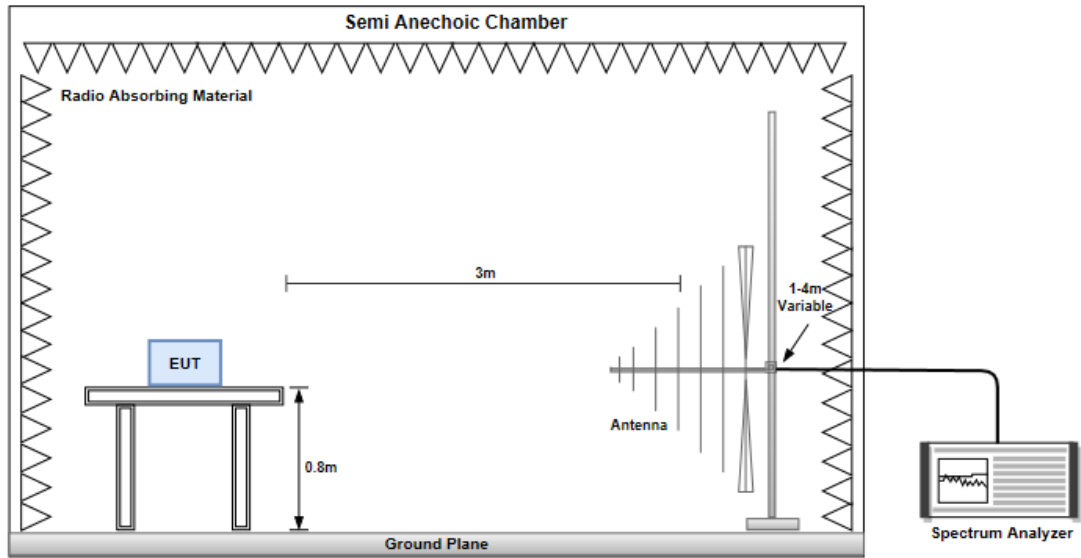

Radiated Emissions above 1 GHz

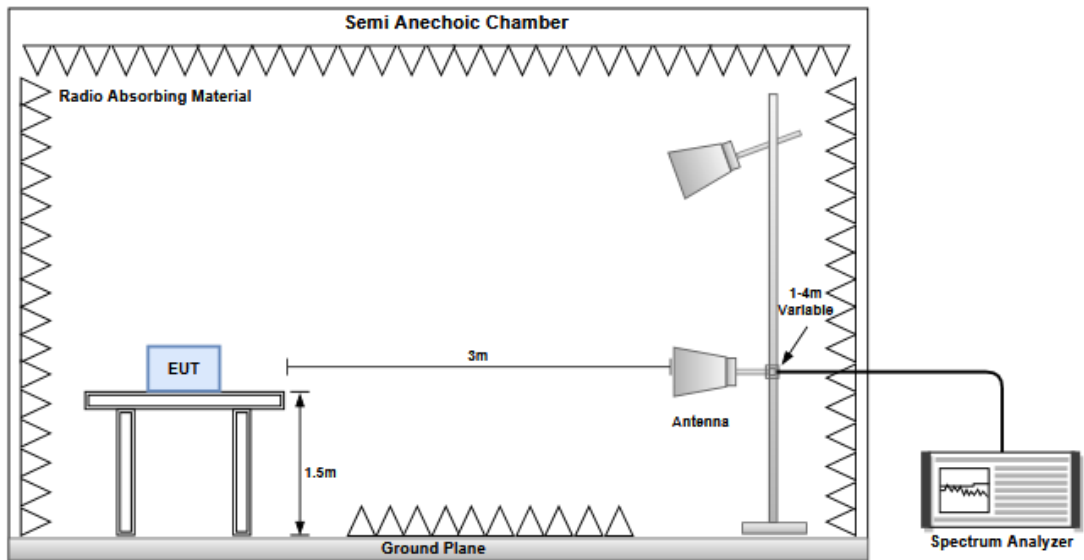

Transmitter Conducted Unwanted Emissions (30MHz~40GHz)

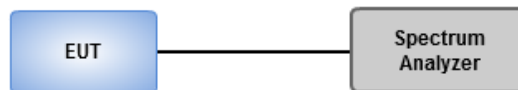

3.5.4 Transmitter Radiated Unwanted Emissions (Below 1GHz)

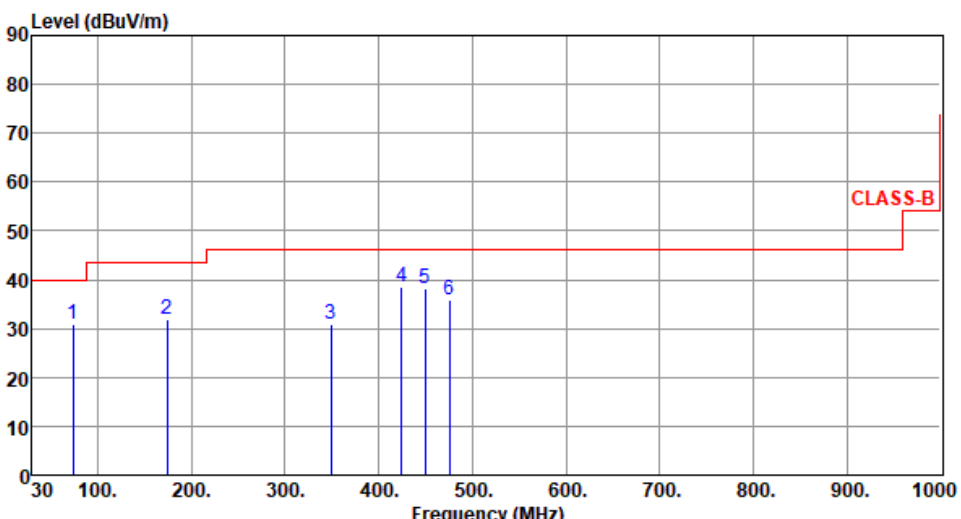
Modulation	BT-LE (1Mbps)	Test Freq. (MHz)	2440						
Polarization	Horizontal								
Test By :Brad Wu Temperature(°C):23 Humidity(%):64									
									
	Freq. MHz	Emission level dBuV/m	Limit dBuV/m	Margin dB	SA reading dBuV	Factor dB/m	Remark	ANT High cm	Turn Table deg
1	73.65	30.96	40.00	-9.04	42.82	-11.86	Peak	---	---
2	174.53	31.83	43.50	-11.67	41.42	-9.59	Peak	---	---
3	349.13	30.91	46.00	-15.09	38.02	-7.11	Peak	---	---
4	424.79	38.67	46.00	-7.33	43.69	-5.02	Peak	---	---
5	450.01	38.06	46.00	-7.94	42.30	-4.24	Peak	---	---
6	475.23	35.71	46.00	-10.29	39.57	-3.86	Peak	---	---
<p>Note 1: Emission Level (dBuV/m) = SA Reading (dBuV) + Factor* (dB/m) *Factor includes antenna factor , cable loss and amplifier gain Note 2: Margin (dB) = Emission level (dBuV/m) – Limit (dBuV/m). Note 3: All spurious emissions below 30MHz are more than 20 dB below the limit.</p>									

Modulation	BT-LE (1Mbps)	Test Freq. (MHz)	2440
Polarization	Vertical		

Test By :Brad Wu Temperature(°C):23 Humidity(%):64

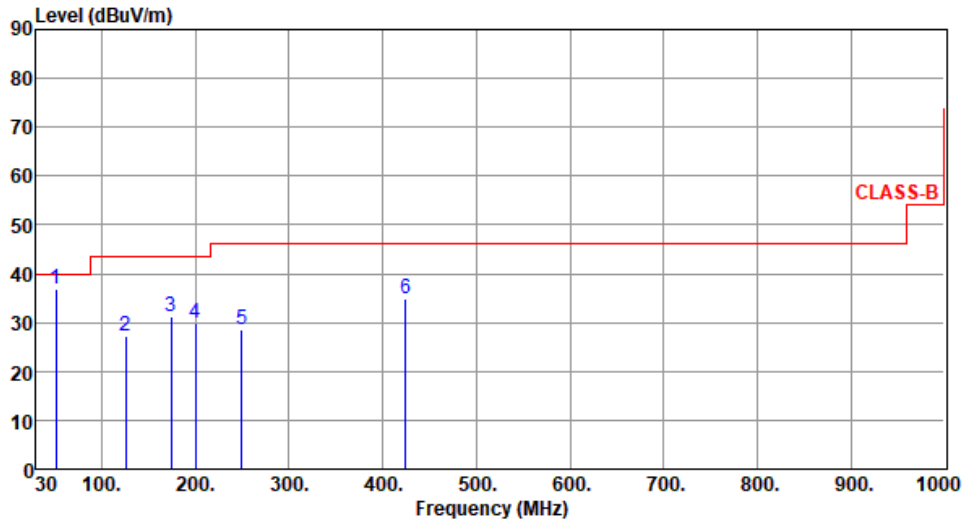

	Freq. MHz	Emission level dBuV/m	Limit dBuV/m	Margin dB	SA reading dBuV	Factor dB/m	Remark	ANT High cm	Turn Table deg
1	51.34	36.95	40.00	-3.05	45.73	-8.78	Peak	---	---
2	126.03	27.18	43.50	-16.32	37.35	-10.17	Peak	---	---
3	174.53	31.17	43.50	-12.33	40.76	-9.59	Peak	---	---
4	199.75	29.74	43.50	-13.76	41.59	-11.85	Peak	---	---
5	249.22	28.43	46.00	-17.57	38.51	-10.08	Peak	---	---
6	424.79	34.72	46.00	-11.28	39.74	-5.02	Peak	---	---

Note 1: Emission Level (dBuV/m) = SA Reading (dBuV) + Factor* (dB/m)

*Factor includes antenna factor , cable loss and amplifier gain

Note 2: Margin (dB) = Emission level (dBuV/m) – Limit (dBuV/m).

Note 3: All spurious emissions below 30MHz are more than 20 dB below the limit.

3.5.5 Transmitter Radiated Unwanted Emissions (Above 1GHz)

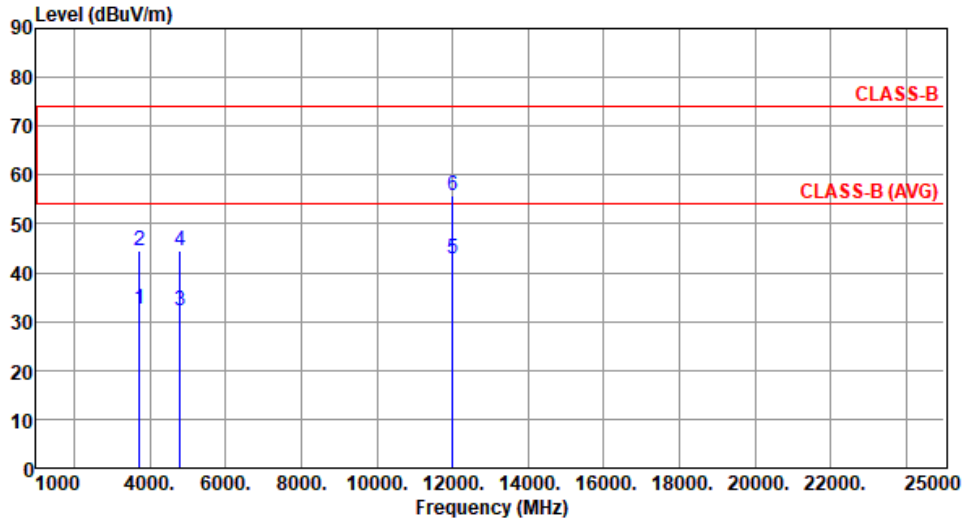
Modulation	BT-LE (1Mbps)	Test Freq. (MHz)	2402						
Polarization	Horizontal								
Test By : Roger Lu Temperature(°C):22 Humidity(%):68									
 <p>The graph plots Level (dBuV/m) on the y-axis (0 to 90) against Frequency (MHz) on the x-axis (1000 to 25000). Two horizontal red lines represent the CLASS-B limit at approximately 74 dBuV/m and the CLASS-B (AVG) limit at approximately 54 dBuV/m. Six vertical blue lines with markers 1 through 6 indicate specific emission points. Markers 1, 2, 3, and 4 are clustered between 3700 and 4900 MHz, while markers 5 and 6 are at 12010 MHz.</p>									
	Freq.	Emission level	Limit	Margin	SA reading	Factor	Remark	ANT High	Turn Table
	MHz	dBuV/m	dBuV/m	dB	dBuV	dB/m		cm	deg
1	3732.00	32.69	54.00	-21.31	31.87	0.82	Average	100	318
2	3732.00	44.37	74.00	-29.63	43.55	0.82	Peak	100	318
3	4804.00	32.23	54.00	-21.77	28.10	4.13	Average	100	50
4	4804.00	44.36	74.00	-29.64	40.23	4.13	Peak	100	50
5	12010.00	42.71	54.00	-11.29	29.09	13.62	Average	100	70
6	12010.00	55.78	74.00	-18.22	42.16	13.62	Peak	100	70
<p>Note 1: Emission Level (dBuV/m) = SA Reading (dBuV) + Factor* (dB/m) *Factor includes antenna factor , cable loss and amplifier gain Note 2: Margin (dB) = Emission level (dBuV/m) – Limit (dBuV/m).</p>									

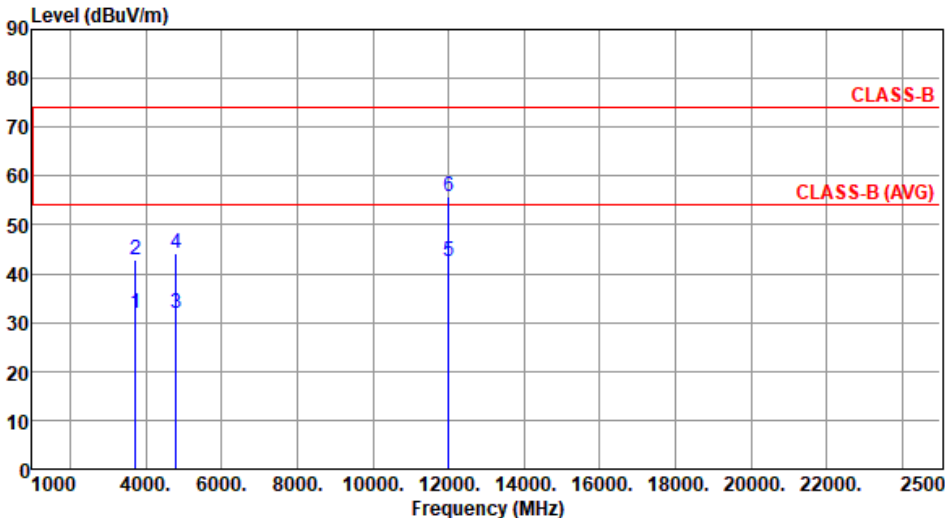
Modulation	BT-LE (1Mbps)	Test Freq. (MHz)	2402						
Polarization	Vertical								
Test By :Roger Lu		Temperature(°C):22			Humidity(%):68				
									
	Freq.	Emission level	Limit	Margin	SA reading	Factor	Remark	ANT High	Turn Table
	MHz	dBuV/m	dBuV/m	dB	dBuV	dB/m		cm	deg
1	3732.00	31.83	54.00	-22.17	31.01	0.82	Average	100	1
2	3732.00	42.93	74.00	-31.07	42.11	0.82	Peak	100	1
3	4804.00	31.93	54.00	-22.07	27.80	4.13	Average	100	60
4	4804.00	44.31	74.00	-29.69	40.18	4.13	Peak	100	60
5	12010.00	42.66	54.00	-11.34	29.04	13.62	Average	100	20
6	12010.00	55.74	74.00	-18.26	42.12	13.62	Peak	100	20
<p>Note 1: Emission Level (dBuV/m) = SA Reading (dBuV) + Factor* (dB/m) *Factor includes antenna factor , cable loss and amplifier gain Note 2: Margin (dB) = Emission level (dBuV/m) – Limit (dBuV/m).</p>									

Modulation	BT-LE (1Mbps)	Test Freq. (MHz)	2440
Polarization	Horizontal		

Test By :Roger Lu Temperature(°C):22 Humidity(%):68

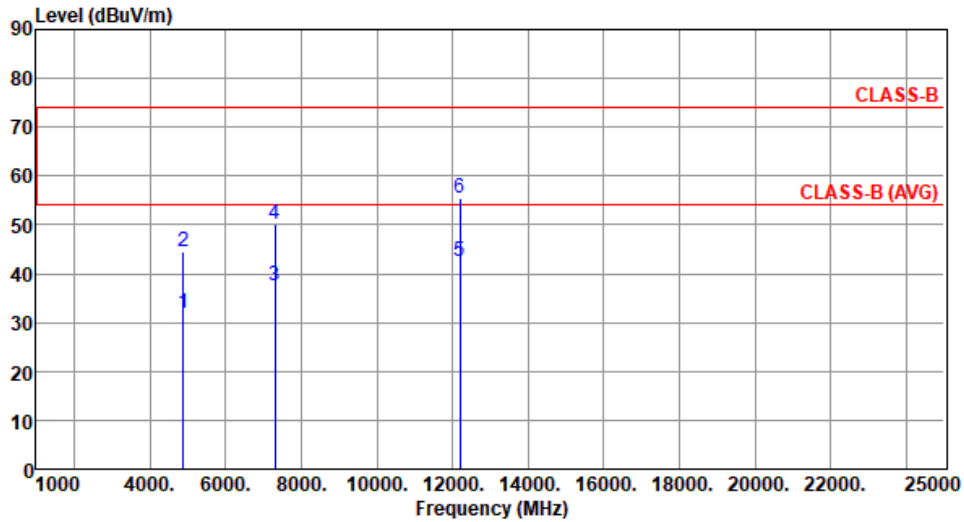

	Freq. MHz	Emission level dBuV/m	Limit dBuV/m	Margin dB	SA reading dBuV	Factor dB/m	Remark	ANT High cm	Turn Table deg
1	4880.00	32.03	54.00	-21.97	27.91	4.12	Average	100	60
2	4880.00	44.40	74.00	-29.60	40.28	4.12	Peak	100	60
3	7320.00	37.50	54.00	-16.50	28.22	9.28	Average	100	40
4	7320.00	50.03	74.00	-23.97	40.75	9.28	Peak	100	40
5	12200.00	42.51	54.00	-11.49	28.88	13.63	Average	100	70
6	12200.00	55.59	74.00	-18.41	41.96	13.63	Peak	100	70

Note 1: Emission Level (dBuV/m) = SA Reading (dBuV) + Factor* (dB/m)

*Factor includes antenna factor , cable loss and amplifier gain

Note 2: Margin (dB) = Emission level (dBuV/m) – Limit (dBuV/m).

Modulation	BT-LE (1Mbps)	Test Freq. (MHz)	2440
Polarization	Vertical		

Test By :Roger Lu Temperature(°C):22 Humidity(%):68

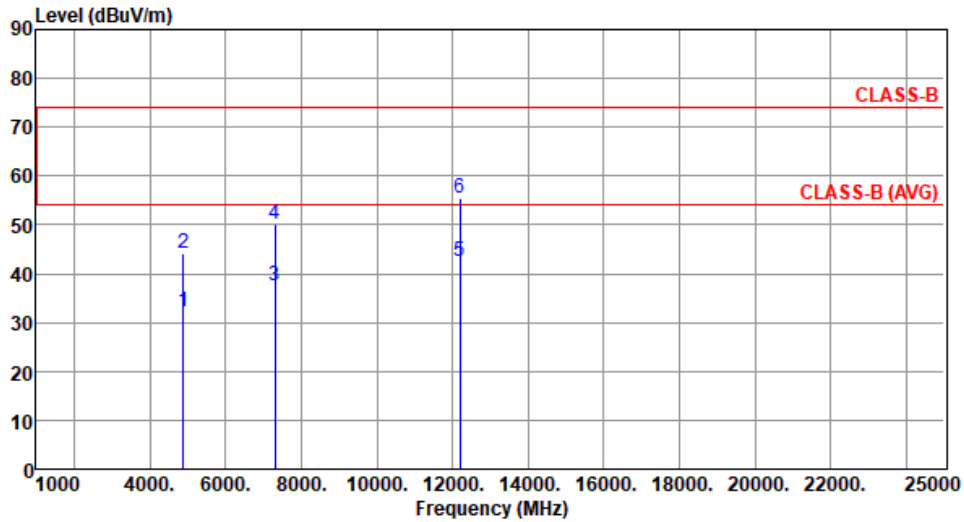

	Freq. MHz	Emission level dBuV/m	Limit dBuV/m	Margin dB	SA reading dBuV	Factor dB/m	Remark	ANT High cm	Turn Table deg
1	4880.00	32.29	54.00	-21.71	28.17	4.12	Average	100	55
2	4880.00	44.31	74.00	-29.69	40.19	4.12	Peak	100	55
3	7320.00	37.49	54.00	-16.51	28.21	9.28	Average	100	90
4	7320.00	50.07	74.00	-23.93	40.79	9.28	Peak	100	90
5	12200.00	42.40	54.00	-11.60	28.77	13.63	Average	100	100
6	12200.00	55.53	74.00	-18.47	41.90	13.63	Peak	100	100

Note 1: Emission Level (dBuV/m) = SA Reading (dBuV) + Factor* (dB/m)

*Factor includes antenna factor , cable loss and amplifier gain

Note 2: Margin (dB) = Emission level (dBuV/m) – Limit (dBuV/m).

Modulation	BT-LE (1Mbps)	Test Freq. (MHz)	2480
Polarization	Horizontal		

Test By :Roger Lu Temperature(°C):22 Humidity(%):68

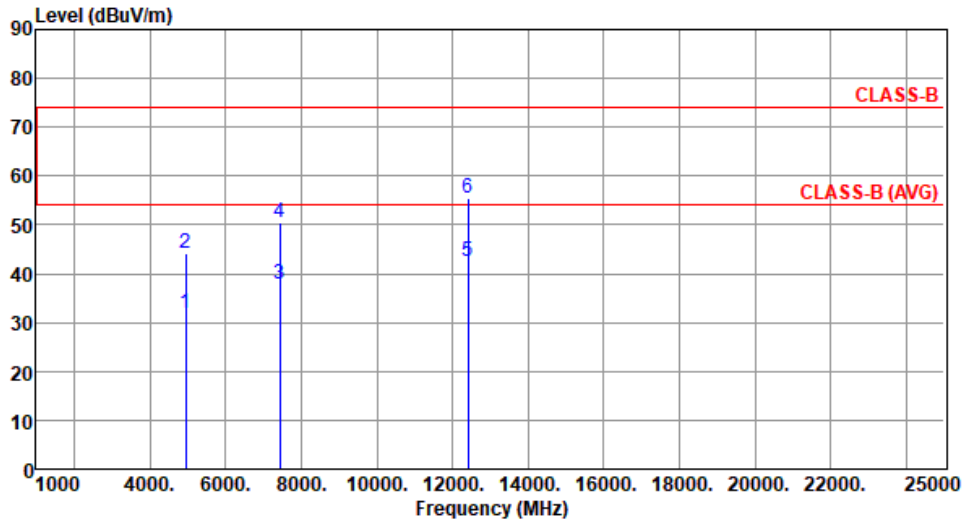

	Freq. MHz	Emission level dBuV/m	Limit dBuV/m	Margin dB	SA reading dBuV	Factor dB/m	Remark	ANT High cm	Turn Table deg
1	4960.00	32.02	54.00	-21.98	27.99	4.03	Average	100	30
2	4960.00	44.23	74.00	-29.77	40.20	4.03	Peak	100	30
3	7440.00	37.94	54.00	-16.06	28.57	9.37	Average	100	90
4	7440.00	50.62	74.00	-23.38	41.25	9.37	Peak	100	90
5	12400.00	42.49	54.00	-11.51	28.91	13.58	Average	100	40
6	12400.00	55.62	74.00	-18.38	42.04	13.58	Peak	100	40

Note 1: Emission Level (dBuV/m) = SA Reading (dBuV) + Factor* (dB/m)

*Factor includes antenna factor , cable loss and amplifier gain

Note 2: Margin (dB) = Emission level (dBuV/m) – Limit (dBuV/m).

Modulation	BT-LE (1Mbps)	Test Freq. (MHz)	2480
Polarization	Vertical		

Test By :Roger Lu Temperature(°C):22 Humidity(%):68

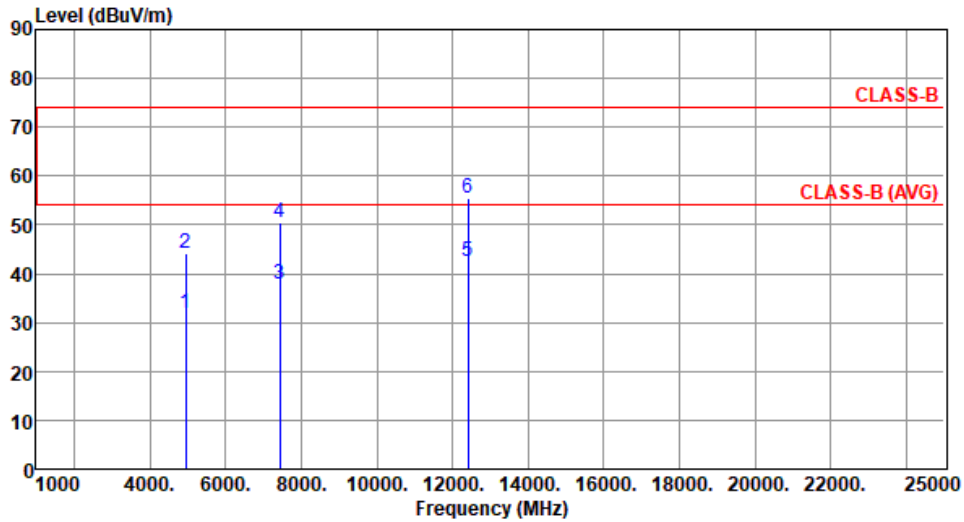

	Freq. MHz	Emission level dBuV/m	Limit dBuV/m	Margin dB	SA reading dBuV	Factor dB/m	Remark	ANT High cm	Turn Table deg
1	4960.00	31.80	54.00	-22.20	27.77	4.03	Average	100	25
2	4960.00	44.14	74.00	-29.86	40.11	4.03	Peak	100	25
3	7440.00	37.75	54.00	-16.25	28.38	9.37	Average	100	60
4	7440.00	50.38	74.00	-23.62	41.01	9.37	Peak	100	60
5	12400.00	42.42	54.00	-11.58	28.84	13.58	Average	100	20
6	12400.00	55.51	74.00	-18.49	41.93	13.58	Peak	100	20

Note 1: Emission Level (dBuV/m) = SA Reading (dBuV) + Factor* (dB/m)

*Factor includes antenna factor , cable loss and amplifier gain

Note 2: Margin (dB) = Emission level (dBuV/m) – Limit (dBuV/m).

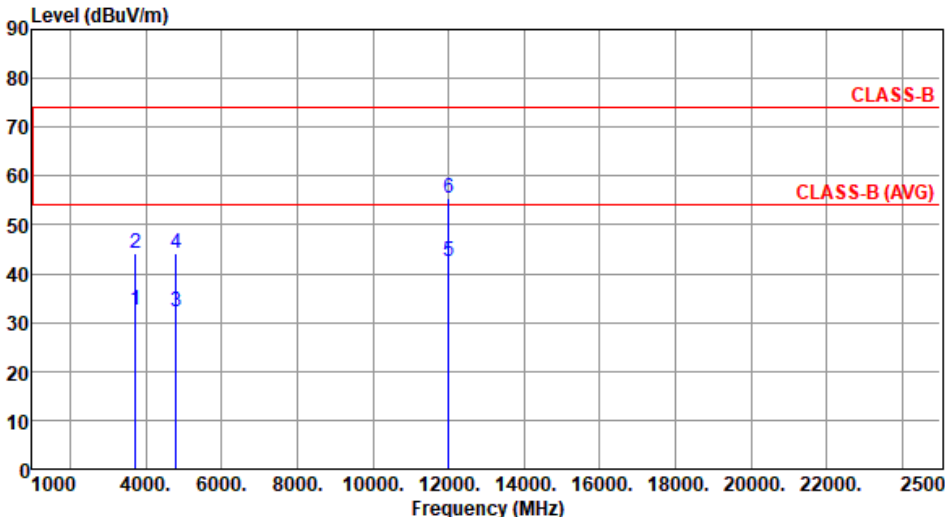
Modulation	BT-LE (2Mbps)	Test Freq. (MHz)	2402						
Polarization	Horizontal								
Test By :Roger Lu		Temperature(°C):22			Humidity(%):68				
 <p>The graph displays emission levels in dBuV/m against frequency in MHz. Two horizontal red lines represent the CLASS-B limit at approximately 74 dBuV/m and the CLASS-B (AVG) limit at approximately 54 dBuV/m. Six vertical blue lines indicate measured emission levels at various frequencies, labeled 1 through 6. The measured levels are: 1 (3732 MHz, 32.63 dBuV/m), 2 (3732 MHz, 44.20 dBuV/m), 3 (4804 MHz, 32.12 dBuV/m), 4 (4804 MHz, 44.22 dBuV/m), 5 (12010 MHz, 42.64 dBuV/m), and 6 (12010 MHz, 55.62 dBuV/m).</p>									
	Freq.	Emission	Limit	Margin	SA	Factor	Remark	ANT	Turn
	MHz	level	dBuV/m	dB	reading	dB/m		High	Table
		dBuV/m			dBuV			cm	deg
1	3732.00	32.63	54.00	-21.37	31.81	0.82	Average	100	315
2	3732.00	44.20	74.00	-29.80	43.38	0.82	Peak	100	315
3	4804.00	32.12	54.00	-21.88	27.99	4.13	Average	100	40
4	4804.00	44.22	74.00	-29.78	40.09	4.13	Peak	100	40
5	12010.00	42.64	54.00	-11.36	29.02	13.62	Average	100	50
6	12010.00	55.62	74.00	-18.38	42.00	13.62	Peak	100	50
<p>Note 1: Emission Level (dBuV/m) = SA Reading (dBuV) + Factor* (dB/m) *Factor includes antenna factor , cable loss and amplifier gain Note 2: Margin (dB) = Emission level (dBuV/m) – Limit (dBuV/m).</p>									

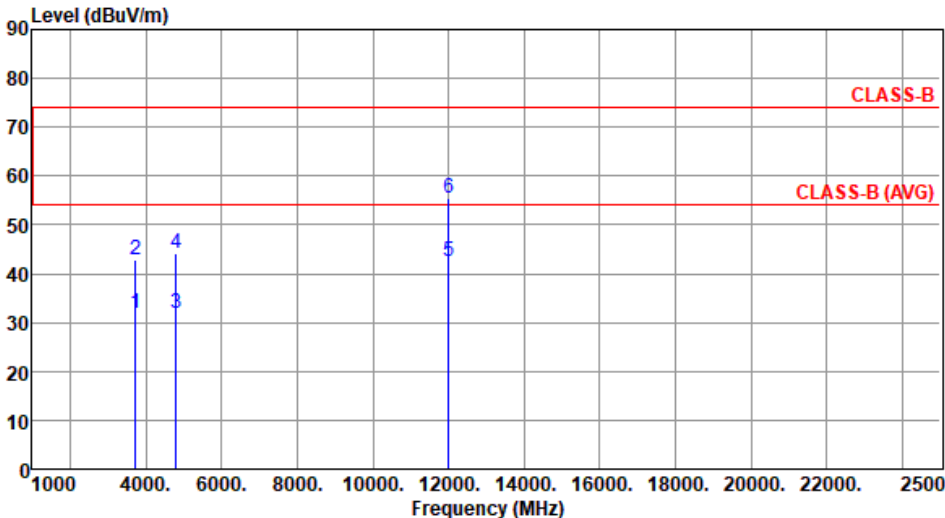
Modulation	BT-LE (2Mbps)	Test Freq. (MHz)	2402						
Polarization	Vertical								
Test By :Roger Lu		Temperature(°C):22			Humidity(%):68				
									
	Freq.	Emission	Limit	Margin	SA	Factor	Remark	ANT	Turn
	MHz	level	dBuV/m	dB	reading	dB/m		High	Table
		dBuV/m			dBuV			cm	deg
1	3732.00	31.76	54.00	-22.24	30.94	0.82	Average	100	5
2	3732.00	42.83	74.00	-31.17	42.01	0.82	Peak	100	5
3	4804.00	31.93	54.00	-22.07	27.80	4.13	Average	100	70
4	4804.00	44.16	74.00	-29.84	40.03	4.13	Peak	100	70
5	12010.00	42.51	54.00	-11.49	28.89	13.62	Average	100	40
6	12010.00	55.56	74.00	-18.44	41.94	13.62	Peak	100	40
<p>Note 1: Emission Level (dBuV/m) = SA Reading (dBuV) + Factor* (dB/m)</p> <p>*Factor includes antenna factor , cable loss and amplifier gain</p> <p>Note 2: Margin (dB) = Emission level (dBuV/m) – Limit (dBuV/m).</p>									

Modulation	BT-LE (2Mbps)	Test Freq. (MHz)	2440
Polarization	Horizontal		

Test By :Roger Lu Temperature(°C):22 Humidity(%):68

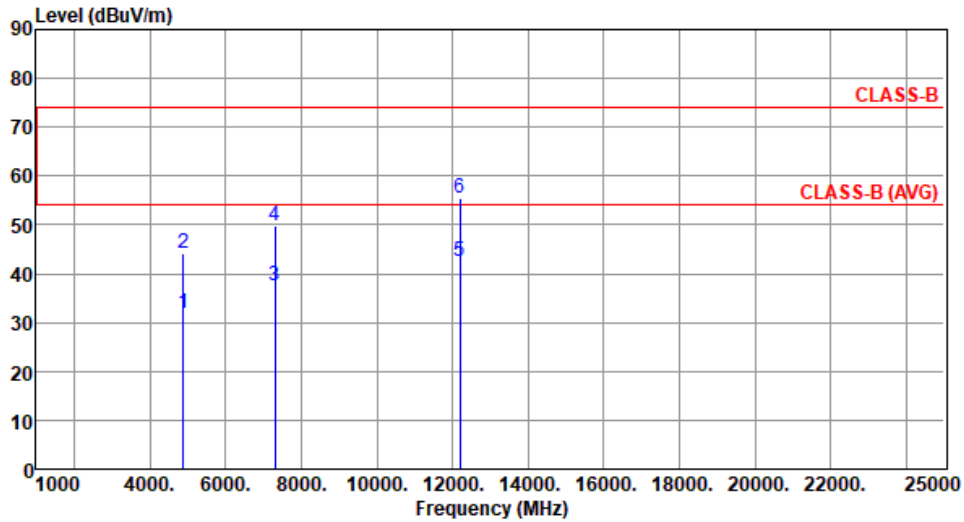

	Freq. MHz	Emission level dBuV/m	Limit dBuV/m	Margin dB	SA reading dBuV	Factor dB/m	Remark	ANT High cm	Turn Table deg
1	4880.00	31.97	54.00	-22.03	27.85	4.12	Average	100	15
2	4880.00	44.17	74.00	-29.83	40.05	4.12	Peak	100	15
3	7320.00	37.39	54.00	-16.61	28.11	9.28	Average	100	90
4	7320.00	49.96	74.00	-24.04	40.68	9.28	Peak	100	90
5	12200.00	42.43	54.00	-11.57	28.80	13.63	Average	100	30
6	12200.00	55.52	74.00	-18.48	41.89	13.63	Peak	100	30

Note 1: Emission Level (dBuV/m) = SA Reading (dBuV) + Factor* (dB/m)

*Factor includes antenna factor , cable loss and amplifier gain

Note 2: Margin (dB) = Emission level (dBuV/m) – Limit (dBuV/m).

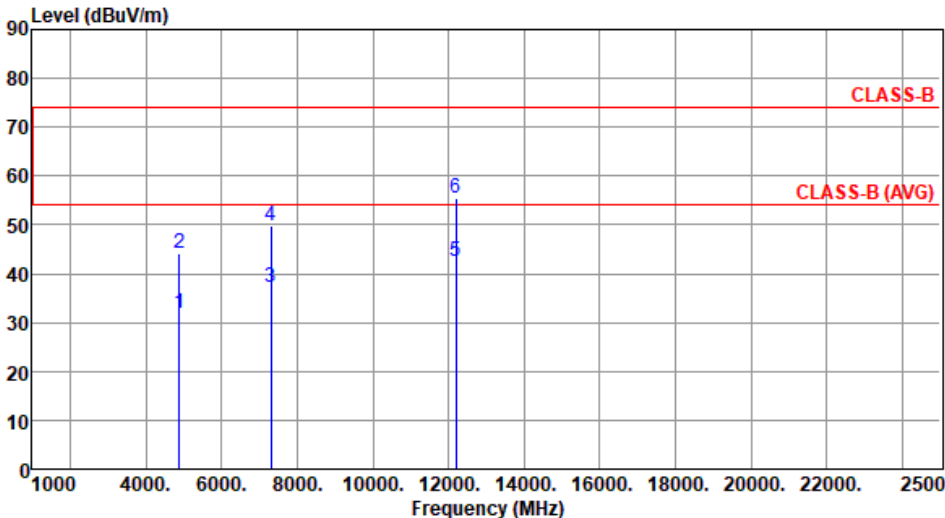
Modulation	BT-LE (2Mbps)	Test Freq. (MHz)	2440						
Polarization	Vertical								
Test By :Roger Lu		Temperature(°C):22			Humidity(%):68				
 <p>The graph displays emission levels in dBuV/m on the y-axis (0 to 90) against frequency in MHz on the x-axis (1000 to 25000). Two horizontal red lines represent the CLASS-B limit at approximately 74 dBuV/m and the CLASS-B (AVG) limit at approximately 54 dBuV/m. Six vertical blue lines indicate measured emission levels at specific frequencies, labeled 1 through 6. The measured levels are: 1 (4880 MHz, 31.90 dBuV/m), 2 (4880 MHz, 44.01 dBuV/m), 3 (7320 MHz, 37.26 dBuV/m), 4 (7320 MHz, 49.87 dBuV/m), 5 (12200 MHz, 42.53 dBuV/m), and 6 (12200 MHz, 55.61 dBuV/m).</p>									
	Freq.	Emission level	Limit	Margin	SA reading	Factor	Remark	ANT High	Turn Table
	MHz	dBuV/m	dBuV/m	dB	dBuV	dB/m		cm	deg
1	4880.00	31.90	54.00	-22.10	27.78	4.12	Average	100	60
2	4880.00	44.01	74.00	-29.99	39.89	4.12	Peak	100	60
3	7320.00	37.26	54.00	-16.74	27.98	9.28	Average	100	70
4	7320.00	49.87	74.00	-24.13	40.59	9.28	Peak	100	70
5	12200.00	42.53	54.00	-11.47	28.90	13.63	Average	100	40
6	12200.00	55.61	74.00	-18.39	41.98	13.63	Peak	100	40
<p>Note 1: Emission Level (dBuV/m) = SA Reading (dBuV) + Factor* (dB/m) *Factor includes antenna factor , cable loss and amplifier gain Note 2: Margin (dB) = Emission level (dBuV/m) – Limit (dBuV/m).</p>									

Modulation	BT-LE (2Mbps)	Test Freq. (MHz)	2480
Polarization	Horizontal		

Test By :Roger Lu Temperature(°C):22 Humidity(%):68

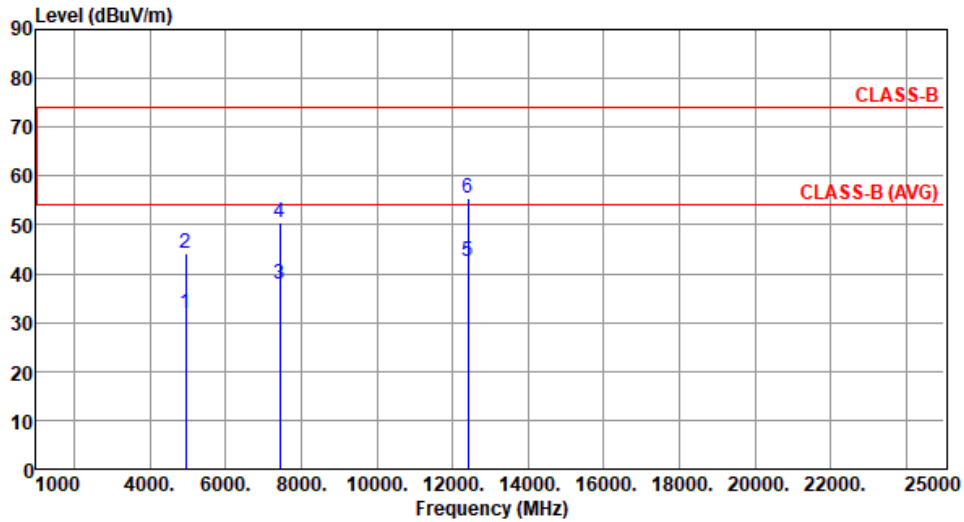

	Freq. MHz	Emission level dBuV/m	Limit dBuV/m	Margin dB	SA reading dBuV	Factor dB/m	Remark	ANT High cm	Turn Table deg
1	4960.00	31.89	54.00	-22.11	27.86	4.03	Average	100	20
2	4960.00	44.11	74.00	-29.89	40.08	4.03	Peak	100	20
3	7440.00	37.85	54.00	-16.15	28.48	9.37	Average	100	60
4	7440.00	50.55	74.00	-23.45	41.18	9.37	Peak	100	60
5	12400.00	42.44	54.00	-11.56	28.86	13.58	Average	100	30
6	12400.00	55.53	74.00	-18.47	41.95	13.58	Peak	100	30

Note 1: Emission Level (dBuV/m) = SA Reading (dBuV) + Factor* (dB/m)

*Factor includes antenna factor , cable loss and amplifier gain

Note 2: Margin (dB) = Emission level (dBuV/m) – Limit (dBuV/m).

Modulation	BT-LE (2Mbps)	Test Freq. (MHz)	2480
Polarization	Vertical		

Test By :Roger Lu Temperature(°C):22 Humidity(%):68

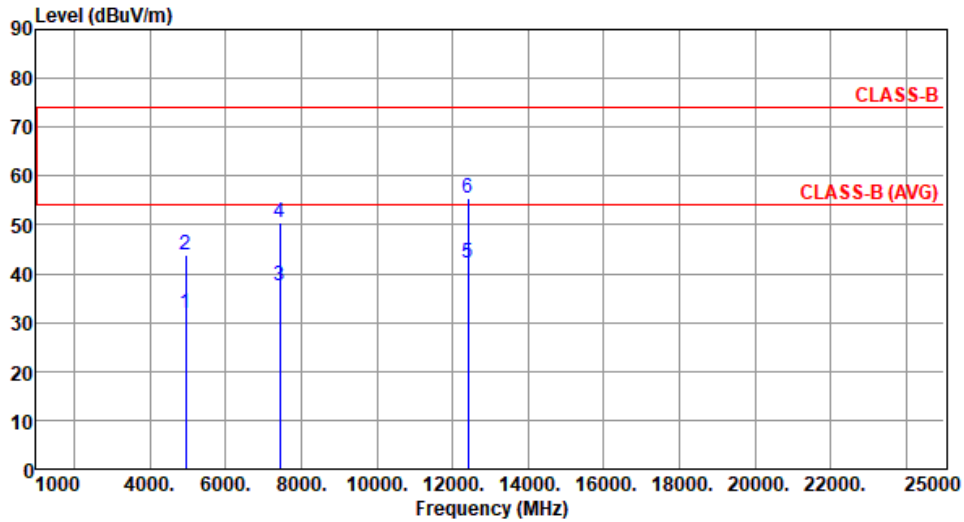

	Freq. MHz	Emission level dBuV/m	Limit dBuV/m	Margin dB	SA reading dBuV	Factor dB/m	Remark	ANT High cm	Turn Table deg
1	4960.00	31.80	54.00	-22.20	27.77	4.03	Average	100	110
2	4960.00	44.00	74.00	-30.00	39.97	4.03	Peak	100	110
3	7440.00	37.69	54.00	-16.31	28.32	9.37	Average	100	50
4	7440.00	50.40	74.00	-23.60	41.03	9.37	Peak	100	50
5	12400.00	42.29	54.00	-11.71	28.71	13.58	Average	100	60
6	12400.00	55.40	74.00	-18.60	41.82	13.58	Peak	100	60

Note 1: Emission Level (dBuV/m) = SA Reading (dBuV) + Factor* (dB/m)

*Factor includes antenna factor , cable loss and amplifier gain

Note 2: Margin (dB) = Emission level (dBuV/m) – Limit (dBuV/m).

3.5.6 Transmitter Conducted Unwanted Emissions (Below 1 GHz)

Summary

Mode	Result	F-Start (Hz)	F-Stop (Hz)	Type	Freq (Hz)	DG (dBi)	Psum (dBm)	GRF (dB)	EIRP (dBm)	Limit (dBm)	Margin (dB)
2.4-2.4835GHz	-	-	-	-	-	-	-	-	-	-	-
BT-LE(1Mbps)	Pass	30M	1G	PK	74.38M	2.80	-73.25	4.7	-65.75	-55.20	-10.55

DG = Directional Gain ; PX=Port X; Psum=P1+P2+...PX

Result

Mode	Result	F-Start (Hz)	F-Stop (Hz)	Type	Freq (Hz)	DG (dBi)	Psum (dBm)	GRF (dB)	EIRP (dBm)	Limit (dBm)	Margin (dB)
BT-LE(1Mbps)	-	-	-	-	-	-	-	-	-	-	-
2440MHz	Pass	30M	1G	PK	74.38M	2.80	-73.25	4.7	-65.75	-55.20	-10.55

DG = Directional Gain ; PX=Port X; Psum=P1+P2+...PX

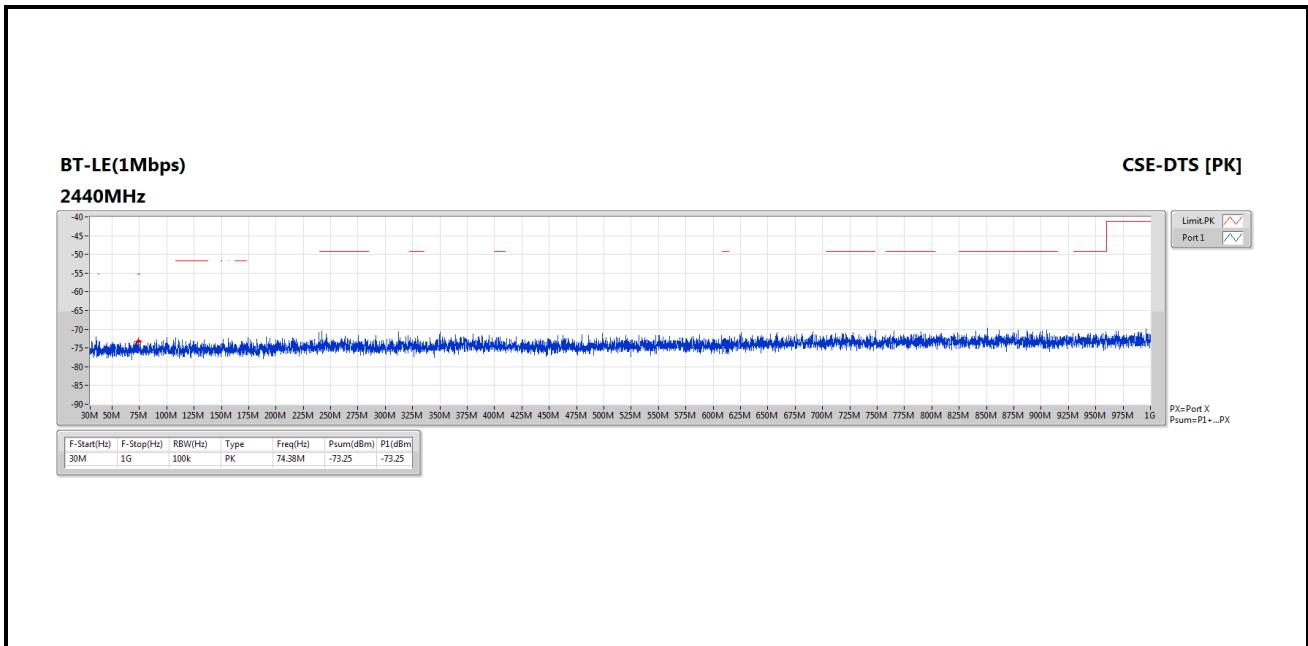

3.5.7 Transmitter Conducted Unwanted Emissions (Above 1GHz)

Summary

Mode	Result	F-Start (Hz)	F-Stop (Hz)	Type	Freq (Hz)	DG (dBi)	Psum (dBm)	EIRP (dBm)	Limit (dBm)	Margin (dB)
2.4-2.4835GHz	-	-	-	-	-	-	-	-	-	-
BT-LE(1Mbps)	Pass	2.4835G	2.5G	AV	2.4876G	2.80	-59.35	-56.55	-41.20	-15.35
BT-LE(2Mbps)	Pass	2.4835G	2.5G	AV	2.48694G	2.80	-58.22	-55.42	-41.20	-14.22

DG = Directional Gain ; PX=Port X; Psum=P1+P2+...PX

Result

Mode	Result	F-Start (Hz)	F-Stop (Hz)	Type	Freq (Hz)	DG (dBi)	Psum (dBm)	EIRP (dBm)	Limit (dBm)	Margin (dB)
BT-LE(1Mbps)	-	-	-	-	-	-	-	-	-	-
2402MHz	Pass	1G	2.31G	AV	2.29559G	2.80	-68.86	-66.06	-41.20	-24.86
2402MHz	Pass	2.31G	2.39G	AV	2.38984G	2.80	-68.07	-65.27	-41.20	-24.07
2402MHz	Pass	2.4835G	2.5G	AV	2.48367G	2.80	-64.80	-62.00	-41.20	-20.80
2402MHz	Pass	2.5G	3.1G	AV	2.68585G	2.80	-67.56	-64.76	-41.20	-23.56
2402MHz	Pass	1G	2.31G	PK	2.25629G	2.80	-58.50	-55.70	-21.20	-34.50
2402MHz	Pass	2.31G	2.39G	PK	2.31324G	2.80	-57.87	-55.07	-21.20	-33.87
2402MHz	Pass	2.4835G	2.5G	PK	2.4841G	2.80	-53.11	-50.31	-21.20	-29.11
2402MHz	Pass	2.5G	3.1G	PK	2.6344G	2.80	-57.67	-54.87	-21.20	-33.67
2440MHz	Pass	1G	2.31G	AV	2.26988G	2.80	-68.97	-66.17	-41.20	-24.97
2440MHz	Pass	2.31G	2.39G	AV	2.31908G	2.80	-68.70	-65.90	-41.20	-24.70
2440MHz	Pass	2.4835G	2.5G	AV	2.48899G	2.80	-66.51	-63.71	-41.20	-22.51
2440MHz	Pass	2.5G	3.1G	AV	2.69605G	2.80	-67.40	-64.60	-41.20	-23.40
2440MHz	Pass	1G	2.31G	PK	1.94582G	2.80	-59.06	-56.26	-21.20	-35.06
2440MHz	Pass	2.31G	2.39G	PK	2.32944G	2.80	-58.27	-55.47	-21.20	-34.27
2440MHz	Pass	2.4835G	2.5G	PK	2.48699G	2.80	-56.56	-53.76	-21.20	-32.56
2440MHz	Pass	2.5G	3.1G	PK	2.8198G	2.80	-57.56	-54.76	-21.20	-33.56
2480MHz	Pass	1G	2.31G	AV	2.14134G	2.80	-69.04	-66.24	-41.20	-25.04
2480MHz	Pass	2.31G	2.39G	AV	2.39G	2.80	-67.52	-64.72	-41.20	-23.52
2480MHz	Pass	2.4835G	2.5G	AV	2.4876G	2.80	-59.35	-56.55	-41.20	-15.35
2480MHz	Pass	2.5G	3.1G	AV	2.64565G	2.80	-67.45	-64.65	-41.20	-23.45
2480MHz	Pass	1G	2.31G	PK	2.24974G	2.80	-59.15	-56.35	-21.20	-35.15
2480MHz	Pass	2.31G	2.39G	PK	2.38996G	2.80	-56.88	-54.08	-21.20	-32.88
2480MHz	Pass	2.4835G	2.5G	PK	2.48361G	2.80	-49.61	-46.81	-21.20	-25.61
2480MHz	Pass	2.5G	3.1G	PK	2.644G	2.80	-57.53	-54.73	-21.20	-33.53
BT-LE(2Mbps)	-	-	-	-	-	-	-	-	-	-
2402MHz	Pass	1G	2.31G	AV	2.12889G	2.80	-68.36	-65.56	-41.20	-24.36
2402MHz	Pass	2.31G	2.39G	AV	2.38696G	2.80	-66.86	-64.06	-41.20	-22.86
2402MHz	Pass	2.4835G	2.5G	AV	2.48475G	2.80	-59.82	-57.02	-41.20	-15.82
2402MHz	Pass	2.5G	3.1G	AV	2.66365G	2.80	-67.10	-64.30	-41.20	-23.10
2402MHz	Pass	1G	2.31G	PK	2.22485G	2.80	-58.26	-55.46	-21.20	-34.26
2402MHz	Pass	2.31G	2.39G	PK	2.38728G	2.80	-57.14	-54.34	-21.20	-33.14
2402MHz	Pass	2.4835G	2.5G	PK	2.48473G	2.80	-52.37	-49.57	-21.20	-28.37
2402MHz	Pass	2.5G	3.1G	PK	2.8633G	2.80	-57.26	-54.46	-21.20	-33.26
2440MHz	Pass	1G	2.31G	AV	2.11301G	2.80	-68.07	-65.27	-41.20	-24.07

Mode	Result	F-Start (Hz)	F-Stop (Hz)	Type	Freq (Hz)	DG (dBi)	Psum (dBm)	EIRP (dBm)	Limit (dBm)	Margin (dB)
2440MHz	Pass	2.31G	2.39G	AV	2.38952G	2.80	-64.99	-62.19	-41.20	-20.99
2440MHz	Pass	2.4835G	2.5G	AV	2.4848G	2.80	-61.87	-59.07	-41.20	-17.87
2440MHz	Pass	2.5G	3.1G	AV	2.6569G	2.80	-67.27	-64.47	-41.20	-23.27
2440MHz	Pass	1G	2.31G	PK	2.24581G	2.80	-58.81	-56.01	-21.20	-34.81
2440MHz	Pass	2.31G	2.39G	PK	2.38988G	2.80	-55.09	-52.29	-21.20	-31.09
2440MHz	Pass	2.4835G	2.5G	PK	2.48452G	2.80	-52.81	-50.01	-21.20	-28.81
2440MHz	Pass	2.5G	3.1G	PK	2.6761G	2.80	-57.40	-54.60	-21.20	-33.40
2480MHz	Pass	1G	2.31G	AV	2.12676G	2.80	-68.54	-65.74	-41.20	-24.54
2480MHz	Pass	2.31G	2.39G	AV	2.38952G	2.80	-66.70	-63.90	-41.20	-22.70
2480MHz	Pass	2.4835G	2.5G	AV	2.48694G	2.80	-58.22	-55.42	-41.20	-14.22
2480MHz	Pass	2.5G	3.1G	AV	2.6572G	2.80	-67.27	-64.47	-41.20	-23.27
2480MHz	Pass	1G	2.31G	PK	1.84233G	2.80	-58.85	-56.05	-21.20	-34.85
2480MHz	Pass	2.31G	2.39G	PK	2.38932G	2.80	-58.06	-55.26	-21.20	-34.06
2480MHz	Pass	2.4835G	2.5G	PK	2.48352G	2.80	-47.68	-44.88	-21.20	-23.68
2480MHz	Pass	2.5G	3.1G	PK	2.6509G	2.80	-57.64	-54.84	-21.20	-33.64

DG = Directional Gain ; PX=Port X; Psum=P1+P2+...PX

BT-LE(1Mbps)

CSE-DTS [PK]

2402MHz

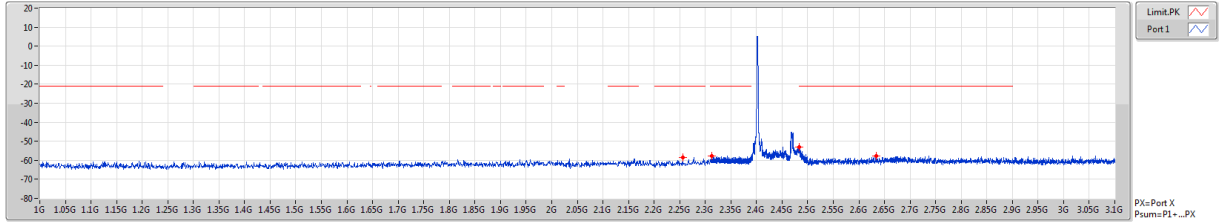

F-Start(Hz)	F-Stop(Hz)	RBW(Hz)	Type	Freq(Hz)	Psum(dBm)	P1(dBm)
1G	2.31G	1M	PK	2.25629G	-58.50	-58.50
2.31G	2.39G	1M	PK	2.31324G	-57.87	-57.87
2.4835G	2.5G	1M	PK	2.4841G	-53.11	-53.11
2.5G	3.1G	1M	PK	2.6344G	-57.67	-57.67

BT-LE(1Mbps)

CSE-DTS [AV]

2402MHz

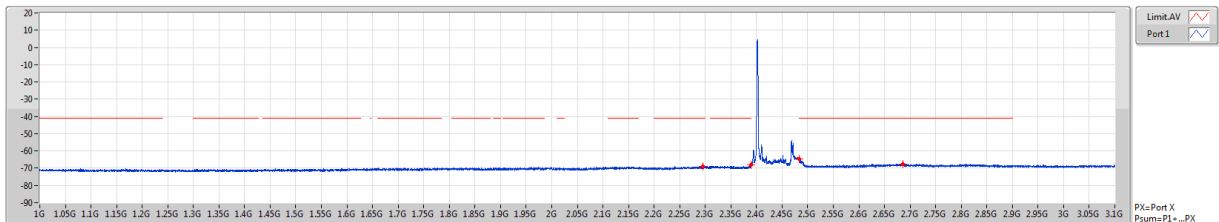

F-Start(Hz)	F-Stop(Hz)	RBW(Hz)	Type	Freq(Hz)	Psum(dBm)	P1(dBm)
1G	2.31G	1M	AV	2.2959G	-68.86	-68.86
2.31G	2.39G	1M	AV	2.38984G	-68.07	-68.07
2.4835G	2.5G	1M	AV	2.48367G	-64.80	-64.80
2.5G	3.1G	1M	AV	2.68585G	-67.56	-67.56

BT-LE(1Mbps)

CSE-DTS [PK]

2440MHz

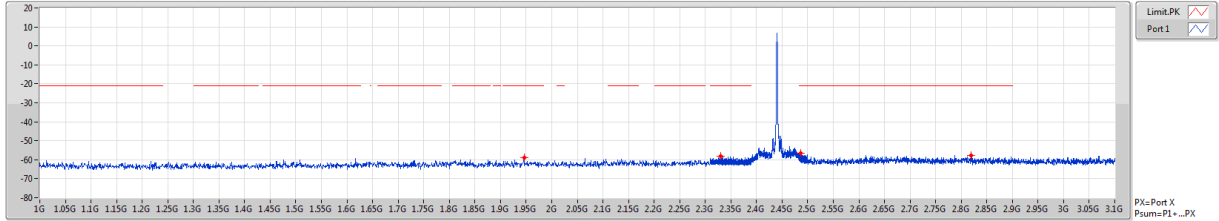

F-Start(Hz)	F-Stop(Hz)	RBW(Hz)	Type	Freq(Hz)	Psum(dBm)	P1(dBm)
1G	2.31G	1M	PK	1.94582G	-59.06	-59.06
2.31G	2.39G	1M	PK	2.32844G	-58.27	-58.27
2.4835G	2.5G	1M	PK	2.48699G	-56.56	-56.56
2.5G	3.1G	1M	PK	2.8198G	-57.56	-57.56

BT-LE(1Mbps)

CSE-DTS [AV]

2440MHz

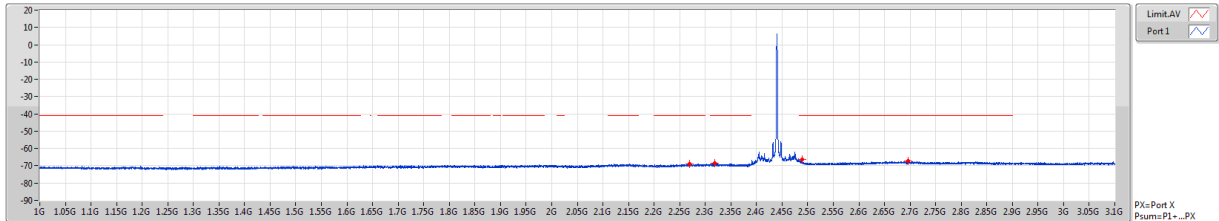

F-Start(Hz)	F-Stop(Hz)	RBW(Hz)	Type	Freq(Hz)	Psum(dBm)	P1(dBm)
1G	2.31G	1M	AV	2.25988G	-68.97	-68.97
2.31G	2.39G	1M	AV	2.31908G	-68.70	-68.70
2.4835G	2.5G	1M	AV	2.48899G	-66.51	-66.51
2.5G	3.1G	1M	AV	2.69605G	-67.40	-67.40

BT-LE(1Mbps)

CSE-DTS [PK]

2480MHz

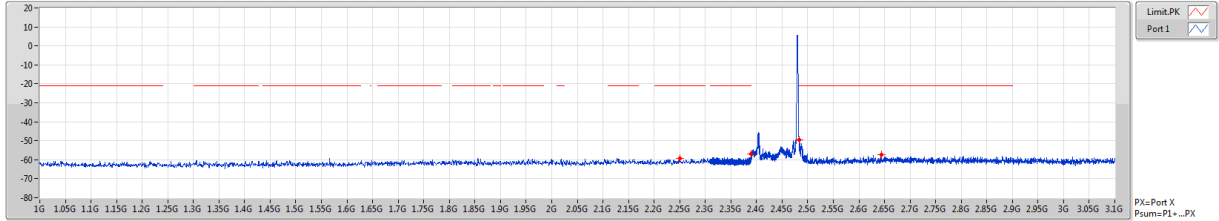

F-Start(Hz)	F-Stop(Hz)	RBW(Hz)	Type	Freq(Hz)	Psum(dBm)	P1(dBm)
1G	2.31G	1M	PK	2.24974G	-59.15	-59.15
2.31G	2.39G	1M	PK	2.38996G	-56.88	-56.88
2.4835G	2.5G	1M	PK	2.48361G	-49.61	-49.61
2.5G	3.1G	1M	PK	2.644G	-57.53	-57.53

BT-LE(1Mbps)

CSE-DTS [AV]

2480MHz

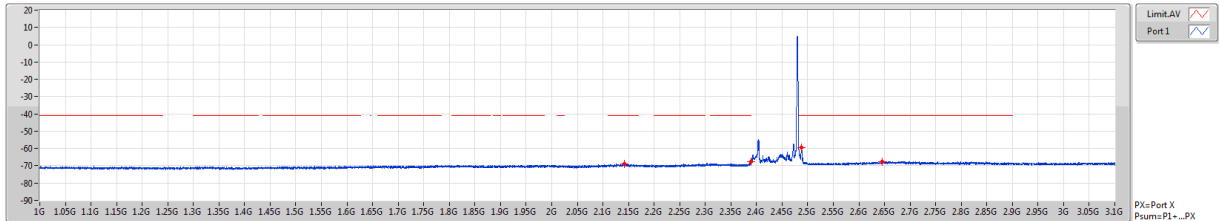

F-Start(Hz)	F-Stop(Hz)	RBW(Hz)	Type	Freq(Hz)	Psum(dBm)	P1(dBm)
1G	2.31G	1M	AV	2.14134G	-69.04	-69.04
2.31G	2.39G	1M	AV	2.39G	-67.52	-67.52
2.4835G	2.5G	1M	AV	2.4876G	-59.35	-59.35
2.5G	3.1G	1M	AV	2.64565G	-67.45	-67.45

BT-LE(2Mbps)

CSE-DTS [PK]

2402MHz

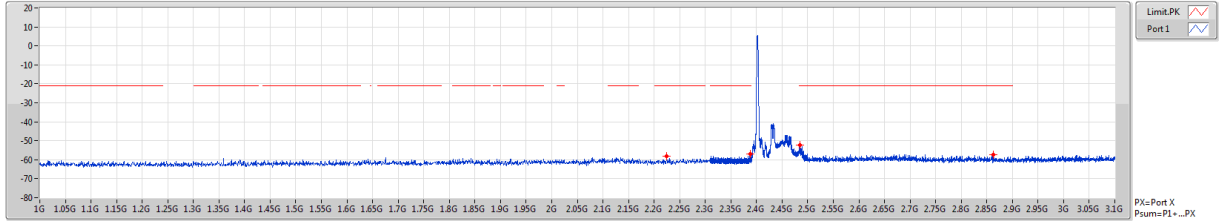

F-Start(Hz)	F-Stop(Hz)	RBW(Hz)	Type	Freq(Hz)	Psum(dBm)	P1(dBm)
1G	2.31G	1M	PK	2.22485G	-58.26	-58.26
2.31G	2.39G	1M	PK	2.38728G	-57.14	-57.14
2.4835G	2.5G	1M	PK	2.48473G	-52.37	-52.37
2.5G	3.1G	1M	PK	2.8633G	-57.26	-57.26

BT-LE(2Mbps)

CSE-DTS [AV]

2402MHz

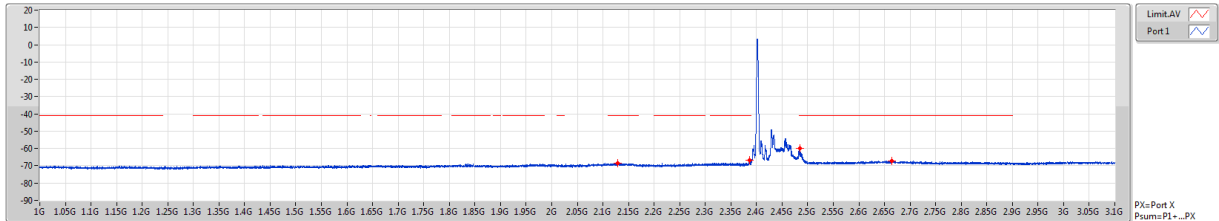

F-Start(Hz)	F-Stop(Hz)	RBW(Hz)	Type	Freq(Hz)	Psum(dBm)	P1(dBm)
1G	2.31G	1M	AV	2.12889G	-68.36	-68.36
2.31G	2.39G	1M	AV	2.38696G	-66.86	-66.86
2.4835G	2.5G	1M	AV	2.48475G	-59.82	-59.82
2.5G	3.1G	1M	AV	2.66365G	-67.10	-67.10

BT-LE(2Mbps)

CSE-DTS [PK]

2440MHz

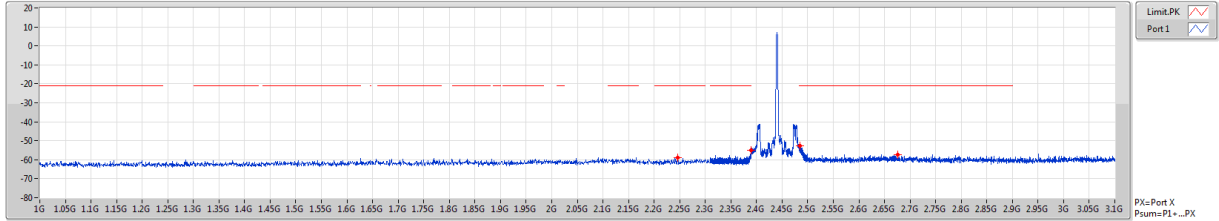

F-Start(Hz)	F-Stop(Hz)	RBW(Hz)	Type	Freq(Hz)	Psum(dBm)	P1(dBm)
1G	2.31G	1M	PK	2.24581G	-58.81	-58.81
2.31G	2.39G	1M	PK	2.38988G	-55.09	-55.09
2.4835G	2.5G	1M	PK	2.48452G	-52.81	-52.81
2.5G	3.1G	1M	PK	2.6761G	-57.40	-57.40

BT-LE(2Mbps)

CSE-DTS [AV]

2440MHz

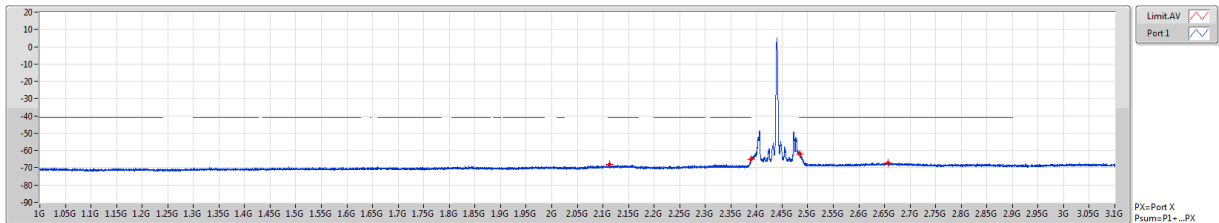

F-Start(Hz)	F-Stop(Hz)	RBW(Hz)	Type	Freq(Hz)	Psum(dBm)	P1(dBm)
1G	2.31G	1M	AV	2.11301G	-68.07	-68.07
2.31G	2.39G	1M	AV	2.38952G	-64.99	-64.99
2.4835G	2.5G	1M	AV	2.4848G	-61.87	-61.87
2.5G	3.1G	1M	AV	2.6569G	-67.27	-67.27

BT-LE(2Mbps)

CSE-DTS [PK]

2480MHz

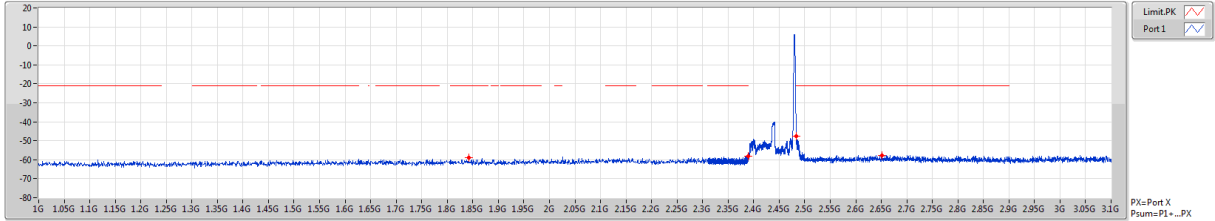

F.Start(Hz)	F.Stop(Hz)	RBW(Hz)	Type	Freq(Hz)	Psum(dBm)	P1(dBm)
1G	2.31G	1M	PK	1.84232G	-58.85	-58.85
2.31G	2.39G	1M	PK	2.38932G	-58.06	-58.06
2.4835G	2.5G	1M	PK	2.48352G	-47.68	-47.68
2.5G	3.1G	1M	PK	2.6509G	-57.64	-57.64

BT-LE(2Mbps)

CSE-DTS [AV]

2480MHz

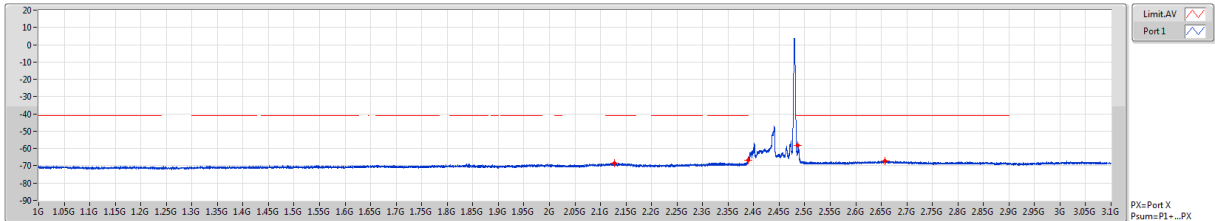

F.Start(Hz)	F.Stop(Hz)	RBW(Hz)	Type	Freq(Hz)	Psum(dBm)	P1(dBm)
1G	2.31G	1M	AV	2.12676G	-68.54	-68.54
2.31G	2.39G	1M	AV	2.38952G	-66.70	-66.70
2.4835G	2.5G	1M	AV	2.48694G	-58.22	-58.22
2.5G	3.1G	1M	AV	2.6572G	-67.27	-67.27

3.5.8 Transmitter Conducted Unwanted Emissions (Below 25GHz)

Summary

Mode	Result	F-Start (Hz)	F-Stop (Hz)	Type	Freq (Hz)	DG (dBi)	Psum (dBm)	EIRP (dBm)	Limit (dBm)	Margin (dB)
2.4-2.4835GHz	-	-	-	-	-	-	-	-	-	-
BT-LE(1Mbps)	Pass	8G	25G	AV	19.42613G	2.80	-64.12	-61.32	-41.20	-20.12
BT-LE(2Mbps)	Pass	8G	25G	AV	19.37672G	2.80	-63.55	-60.75	-41.20	-19.55

DG = Directional Gain ; PX=Port X; Psum=P1+P2+...PX

Result

Mode	Result	F-Start (Hz)	F-Stop (Hz)	Type	Freq (Hz)	DG (dBi)	Psum (dBm)	EIRP (dBm)	Limit (dBm)	Margin (dB)
BT-LE(1Mbps)	-	-	-	-	-	-	-	-	-	-
2402MHz	Pass	3.1G	4G	AV	3.98065G	2.80	-76.06	-73.26	-41.20	-32.06
2402MHz	Pass	4G	5G	AV	4.804G	2.80	-68.97	-66.17	-41.20	-24.97
2402MHz	Pass	5G	7G	AV	5.115G	2.80	-73.64	-70.84	-41.20	-29.64
2402MHz	Pass	7G	8G	AV	7.39275G	2.80	-72.32	-69.52	-41.20	-28.32
2402MHz	Pass	8G	25G	AV	19.43356G	2.80	-64.50	-61.70	-41.20	-20.50
2402MHz	Pass	3.1G	4G	PK	3.94083G	2.80	-65.81	-63.01	-21.20	-41.81
2402MHz	Pass	4G	5G	PK	4.8045G	2.80	-62.59	-59.79	-21.20	-38.59
2402MHz	Pass	4G	5G	PK	4.805G	2.80	-62.12	-59.32	-21.20	-38.12
2402MHz	Pass	5G	7G	PK	5.099G	2.80	-64.35	-61.55	-21.20	-40.35
2402MHz	Pass	7G	8G	PK	7.317G	2.80	-62.87	-60.07	-21.20	-38.87
2402MHz	Pass	8G	25G	PK	19.46278G	2.80	-54.49	-51.69	-21.20	-30.49
2440MHz	Pass	3.1G	4G	AV	3.96783G	2.80	-76.37	-73.57	-41.20	-32.37
2440MHz	Pass	4G	5G	AV	4.87975G	2.80	-69.76	-66.96	-41.20	-25.76
2440MHz	Pass	4G	5G	AV	4.88025G	2.80	-69.76	-66.96	-41.20	-25.76
2440MHz	Pass	5G	7G	AV	5.105G	2.80	-74.19	-71.39	-41.20	-30.19
2440MHz	Pass	7G	8G	AV	7.37575G	2.80	-72.52	-69.72	-41.20	-28.52
2440MHz	Pass	8G	25G	AV	19.42613G	2.80	-64.12	-61.32	-41.20	-20.12
2440MHz	Pass	3.1G	4G	PK	3.99438G	2.80	-66.28	-63.48	-21.20	-42.28
2440MHz	Pass	4G	5G	PK	4.87975G	2.80	-62.60	-59.80	-21.20	-38.60
2440MHz	Pass	5G	7G	PK	5.0965G	2.80	-63.13	-60.33	-21.20	-39.13
2440MHz	Pass	7G	8G	PK	7.29525G	2.80	-62.34	-59.54	-21.20	-38.34
2440MHz	Pass	8G	25G	PK	20.16031G	2.80	-55.60	-52.80	-21.20	-31.60
2480MHz	Pass	3.1G	4G	AV	3.95838G	2.80	-76.22	-73.42	-41.20	-32.22
2480MHz	Pass	4G	5G	AV	4.96025G	2.80	-70.15	-67.35	-41.20	-26.15
2480MHz	Pass	5G	7G	AV	5.096G	2.80	-74.22	-71.42	-41.20	-30.22
2480MHz	Pass	7G	8G	AV	7.405G	2.80	-72.65	-69.85	-41.20	-28.65
2480MHz	Pass	8G	25G	AV	19.41656G	2.80	-64.56	-61.76	-41.20	-20.56
2480MHz	Pass	3.1G	4G	PK	3.80245G	2.80	-66.00	-63.20	-21.20	-42.00
2480MHz	Pass	4G	5G	PK	4.96025G	2.80	-62.96	-60.16	-21.20	-38.96
2480MHz	Pass	4G	5G	PK	4.96075G	2.80	-62.81	-60.01	-21.20	-38.81
2480MHz	Pass	5G	7G	PK	5.1265G	2.80	-63.99	-61.19	-21.20	-39.99
2480MHz	Pass	7G	8G	PK	7.38525G	2.80	-63.08	-60.28	-21.20	-39.08
2480MHz	Pass	8G	25G	PK	19.39478G	2.80	-55.02	-52.22	-21.20	-31.02
BT-LE(2Mbps)	-	-	-	-	-	-	-	-	-	-
2402MHz	Pass	3.1G	4G	AV	3.96648G	2.80	-75.56	-72.76	-41.20	-31.56
2402MHz	Pass	4G	5G	AV	4.803G	2.80	-69.52	-66.72	-41.20	-25.52

Mode	Result	F-Start (Hz)	F-Stop (Hz)	Type	Freq (Hz)	DG (dBi)	Psum (dBm)	EIRP (dBm)	Limit (dBm)	Margin (dB)
2402MHz	Pass	4G	5G	AV	4.80325G	2.80	-69.87	-67.07	-41.20	-25.87
2402MHz	Pass	5G	7G	AV	5.131G	2.80	-73.44	-70.64	-41.20	-29.44
2402MHz	Pass	7G	8G	AV	7.41275G	2.80	-72.14	-69.34	-41.20	-28.14
2402MHz	Pass	8G	25G	AV	19.39744G	2.80	-63.84	-61.04	-41.20	-19.84
2402MHz	Pass	3.1G	4G	PK	3.6706G	2.80	-65.76	-62.96	-21.20	-41.76
2402MHz	Pass	4G	5G	PK	4.80325G	2.80	-62.84	-60.04	-21.20	-38.84
2402MHz	Pass	4G	5G	PK	4.80525G	2.80	-62.50	-59.70	-21.20	-38.50
2402MHz	Pass	5G	7G	PK	5.114G	2.80	-64.29	-61.49	-21.20	-40.29
2402MHz	Pass	7G	8G	PK	7.299G	2.80	-62.17	-59.37	-21.20	-38.17
2402MHz	Pass	8G	25G	PK	19.39425G	2.80	-55.15	-52.35	-21.20	-31.15
2440MHz	Pass	3.1G	4G	AV	3.98695G	2.80	-75.61	-72.81	-41.20	-31.61
2440MHz	Pass	4G	5G	AV	4.87925G	2.80	-70.12	-67.32	-41.20	-26.12
2440MHz	Pass	5G	7G	AV	5.091G	2.80	-73.85	-71.05	-41.20	-29.85
2440MHz	Pass	7G	8G	AV	7.3885G	2.80	-71.98	-69.18	-41.20	-27.98
2440MHz	Pass	8G	25G	AV	19.37672G	2.80	-63.55	-60.75	-41.20	-19.55
2440MHz	Pass	3.1G	4G	PK	3.9199G	2.80	-66.04	-63.24	-21.20	-42.04
2440MHz	Pass	4G	5G	PK	4.8795G	2.80	-63.31	-60.51	-21.20	-39.31
2440MHz	Pass	4G	5G	PK	4.881G	2.80	-63.11	-60.31	-21.20	-39.11
2440MHz	Pass	5G	7G	PK	5.2085G	2.80	-64.30	-61.50	-21.20	-40.30
2440MHz	Pass	7G	8G	PK	7.7435G	2.80	-62.73	-59.93	-21.20	-38.73
2440MHz	Pass	8G	25G	PK	19.44153G	2.80	-55.38	-52.58	-21.20	-31.38
2480MHz	Pass	3.1G	4G	AV	3.97188G	2.80	-75.52	-72.72	-41.20	-31.52
2480MHz	Pass	4G	5G	AV	4.95925G	2.80	-70.39	-67.59	-41.20	-26.39
2480MHz	Pass	5G	7G	AV	5.114G	2.80	-73.44	-70.64	-41.20	-29.44
2480MHz	Pass	7G	8G	AV	7.3915G	2.80	-72.15	-69.35	-41.20	-28.15
2480MHz	Pass	8G	25G	AV	19.42666G	2.80	-63.73	-60.93	-41.20	-19.73
2480MHz	Pass	3.1G	4G	PK	3.9667G	2.80	-65.79	-62.99	-21.20	-41.79
2480MHz	Pass	4G	5G	PK	4.9595G	2.80	-62.90	-60.10	-21.20	-38.90
2480MHz	Pass	5G	7G	PK	5.178G	2.80	-64.83	-62.03	-21.20	-40.83
2480MHz	Pass	7G	8G	PK	7.69425G	2.80	-63.06	-60.26	-21.20	-39.06
2480MHz	Pass	8G	25G	PK	19.40541G	2.80	-54.81	-52.01	-21.20	-30.81

DG = Directional Gain ; PX=Port X; Psum=P1+P2+...PX

BT-LE(1Mbps)

CSE-DTS [PK]

2402MHz

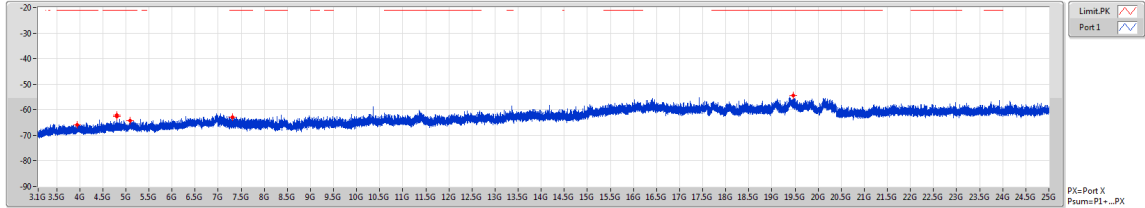

F-Start(Hz)	F-Stop(Hz)	RBW(Hz)	Type	Freq(Hz)	Psum(dBm)	P1(dBm)
3.1G	4G	1M	PK	3.94083G	-65.81	-65.81
4G	5G	1M	PK	4.8045G	-62.59	-62.59
4G	5G	1M	PK	4.805G	-62.12	-62.12
5G	7G	1M	PK	5.009G	-64.35	-64.35
7G	8G	1M	PK	7.317G	-62.87	-62.87
8G	25G	1M	PK	19.46278G	-54.49	-54.49

BT-LE(1Mbps)

CSE-DTS [AV]

2402MHz

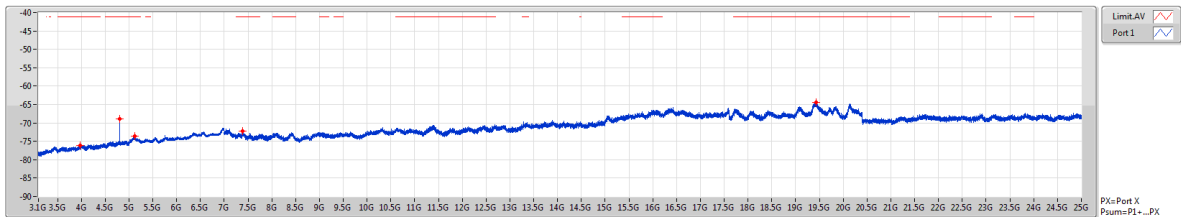

F-Start(Hz)	F-Stop(Hz)	RBW(Hz)	Type	Freq(Hz)	Psum(dBm)	P1(dBm)
3.1G	4G	1M	AV	3.98096G	-76.06	-76.06
4G	5G	1M	AV	4.804G	-68.97	-68.97
5G	7G	1M	AV	5.115G	-73.64	-73.64
7G	8G	1M	AV	7.39275G	-72.32	-72.32
8G	25G	1M	AV	19.43356G	-64.50	-64.50

BT-LE(1Mbps)
2440MHz

CSE-DTS [PK]

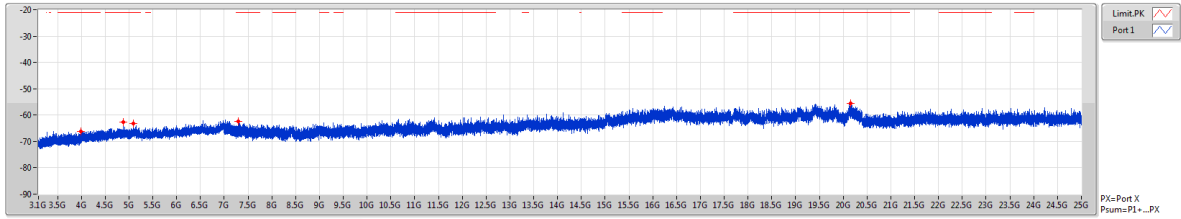

F-Start(Hz)	F-Stop(Hz)	RBW(Hz)	Type	Freq(Hz)	Psum(dBm)	P1(dBm)
3.1G	4G	1M	PK	3.99438G	-66.28	-66.28
4G	5G	1M	PK	4.87975G	-62.60	-62.60
5G	7G	1M	PK	5.9065G	-63.13	-63.13
7G	8G	1M	PK	7.29525G	-62.34	-62.34
8G	2.5G	1M	PK	20.16031G	-55.60	-55.60

BT-LE(1Mbps)
2440MHz

CSE-DTS [AV]

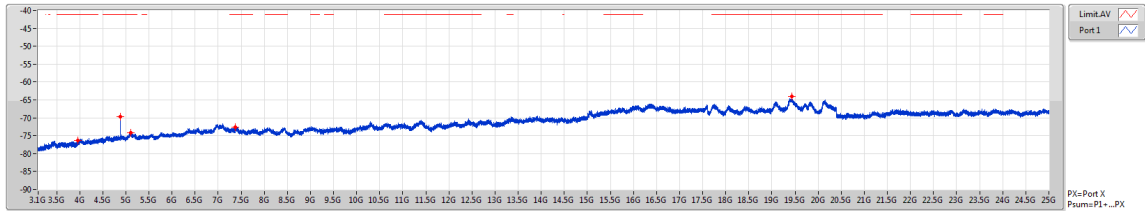

F-Start(Hz)	F-Stop(Hz)	RBW(Hz)	Type	Freq(Hz)	Psum(dBm)	P1(dBm)
3.1G	4G	1M	AV	3.96783G	-76.37	-76.37
4G	5G	1M	AV	4.87975G	-69.76	-69.76
4G	5G	1M	AV	4.88025G	-69.76	-69.76
5G	7G	1M	AV	5.189G	-74.19	-74.19
7G	8G	1M	AV	7.23795G	-72.52	-72.52
8G	2.5G	1M	AV	19.42613G	-64.12	-64.12

BT-LE(1Mbps)
2480MHz

CSE-DTS [PK]

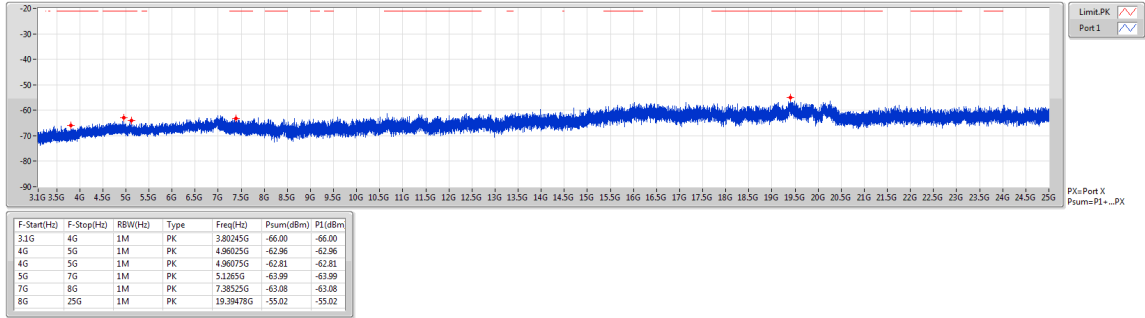

BT-LE(1Mbps)
2480MHz

CSE-DTS [AV]

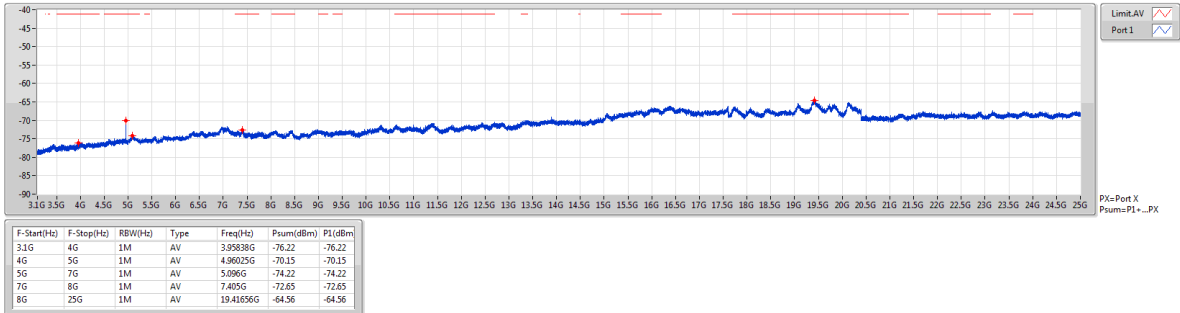

BT-LE(2Mbps)
2402MHz

CSE-DTS [PK]

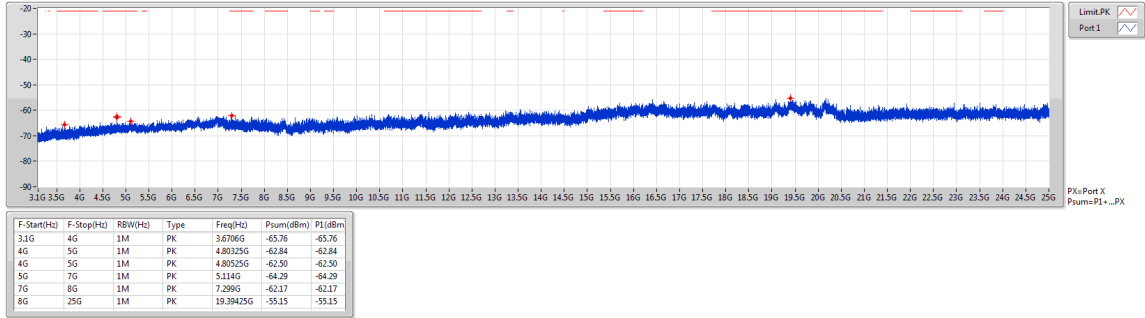

BT-LE(2Mbps)
2402MHz

CSE-DTS [AV]

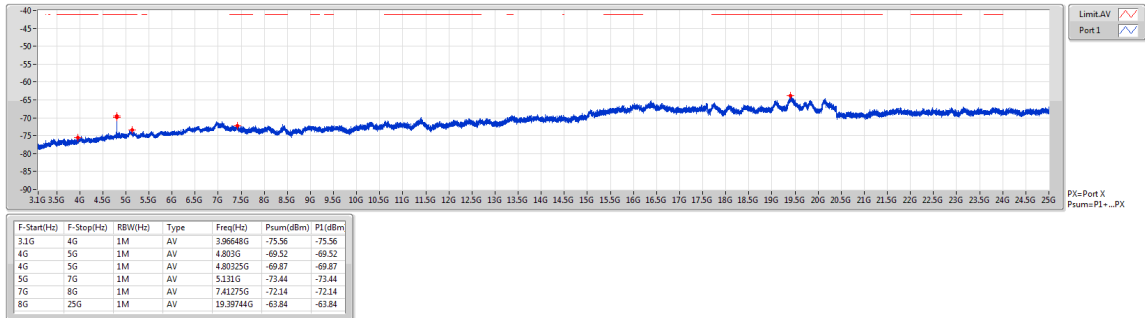

BT-LE(2Mbps)

CSE-DTS [PK]

2440MHz

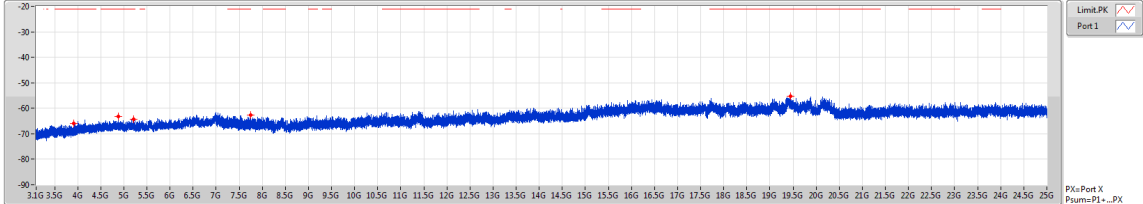

F-Start(Hz)	F-Stop(Hz)	RBW(Hz)	Type	Freq(Hz)	Psum(dBm)	P1(dBm)
3.1G	4G	1M	PK	3.9199G	-66.04	-66.04
4G	5G	1M	PK	4.8795G	-63.31	-63.31
4G	5G	1M	PK	4.881G	-63.11	-63.11
5G	7G	1M	PK	5.2085G	-64.30	-64.30
7G	8G	1M	PK	7.7335G	-62.73	-62.73
8G	25G	1M	PK	19.44153G	-55.38	-55.38

BT-LE(2Mbps)

CSE-DTS [AV]

2440MHz

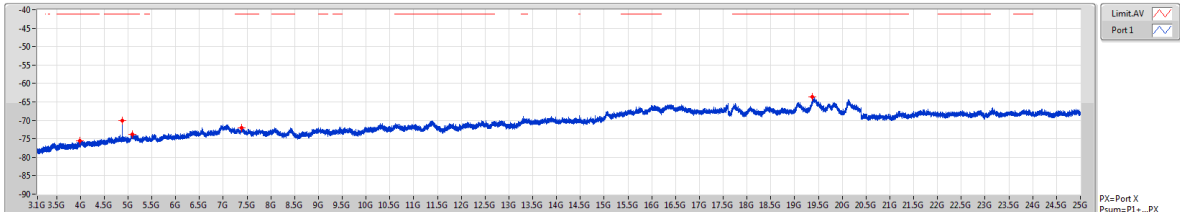

F-Start(Hz)	F-Stop(Hz)	RBW(Hz)	Type	Freq(Hz)	Psum(dBm)	P1(dBm)
3.1G	4G	1M	AV	3.98695G	-75.61	-75.61
4G	5G	1M	AV	4.87925G	-70.12	-70.12
5G	7G	1M	AV	5.091G	-73.85	-73.85
7G	8G	1M	AV	7.3885G	-71.98	-71.98
8G	25G	1M	AV	19.37672G	-63.55	-63.55

BT-LE(2Mbps)
2480MHz

CSE-DTS [PK]

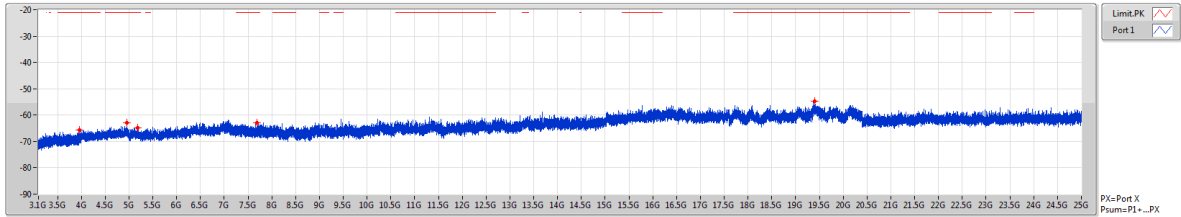

BT-LE(2Mbps)
2480MHz

CSE-DTS [AV]

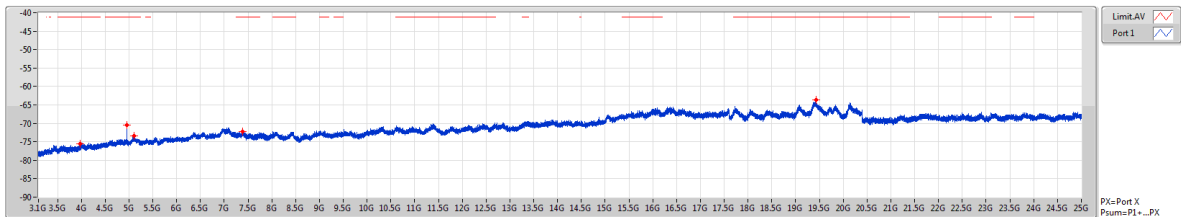

3.6 Emissions in non-restricted Frequency Bands

3.6.1 Emissions in non-restricted frequency bands limit

Peak power in any 100 kHz bandwidth outside of the authorized frequency band shall be attenuated by at least 20 dB relative to the maximum in-band peak PSD level in 100 kHz.

3.6.2 Test Procedures

Reference level measurement

1. Set RBW=100kHz, VBW = 300kHz , Detector = Peak, Sweep time = Auto
2. Trace = max hold , Allow Trace to fully stabilize
3. Use the peak marker function to determine the maximum PSD level

Emission level measurement

1. Set RBW=100kHz, VBW = 300kHz , Detector = Peak, Sweep time = Auto
2. Trace = max hold , Allow Trace to fully stabilize
3. Scan Frequency range is up to 25GHz
4. Use the peak marker function to determine the maximum amplitude level

3.6.3 Test Setup

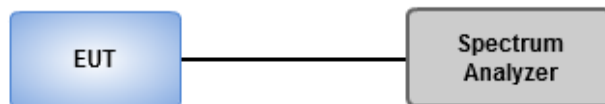

3.6.4 Test Result of Emissions in non-restricted Frequency Bands

Ambient Condition	20°C / 66%	Tested By	Aska Huang
--------------------------	------------	------------------	------------

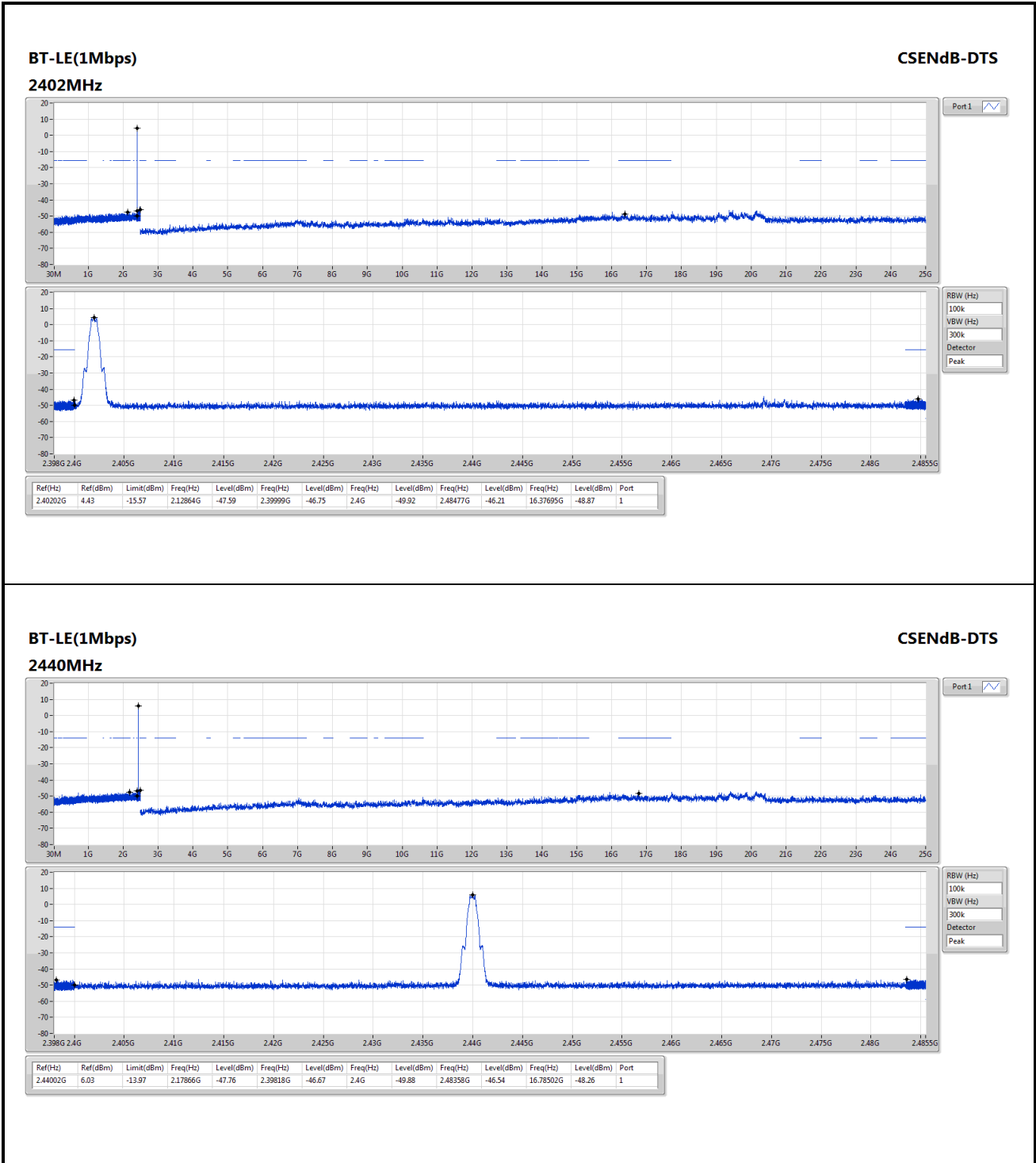

BT-LE(1Mbps)

CSEndB-DTS

2480MHz

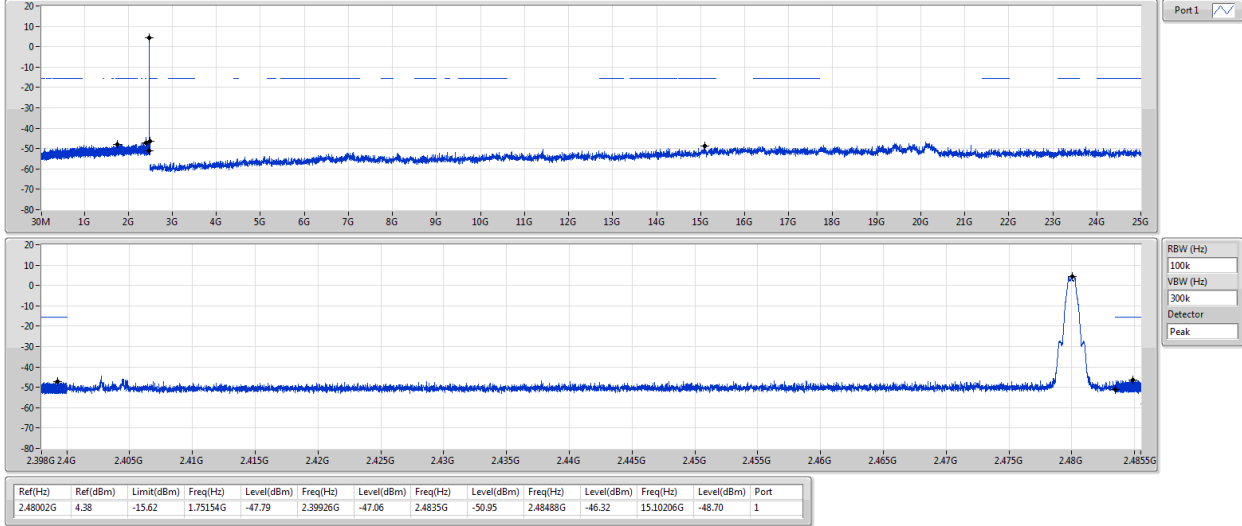

BT-LE(2Mbps)

CSEndB-DTS

2402MHz

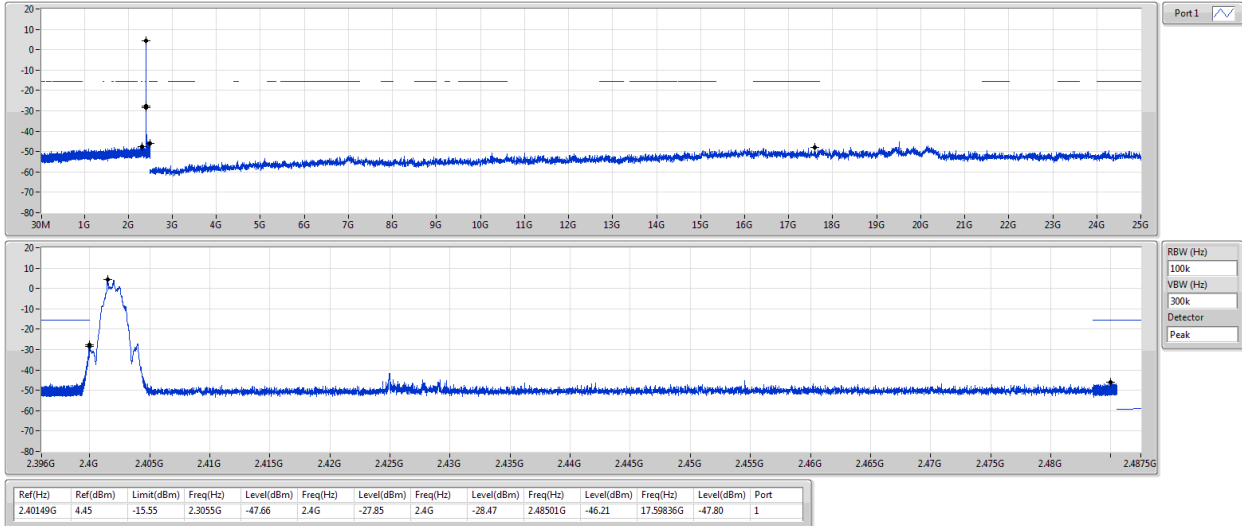

BT-LE(2Mbps)

CSEndB-DTS

2440MHz

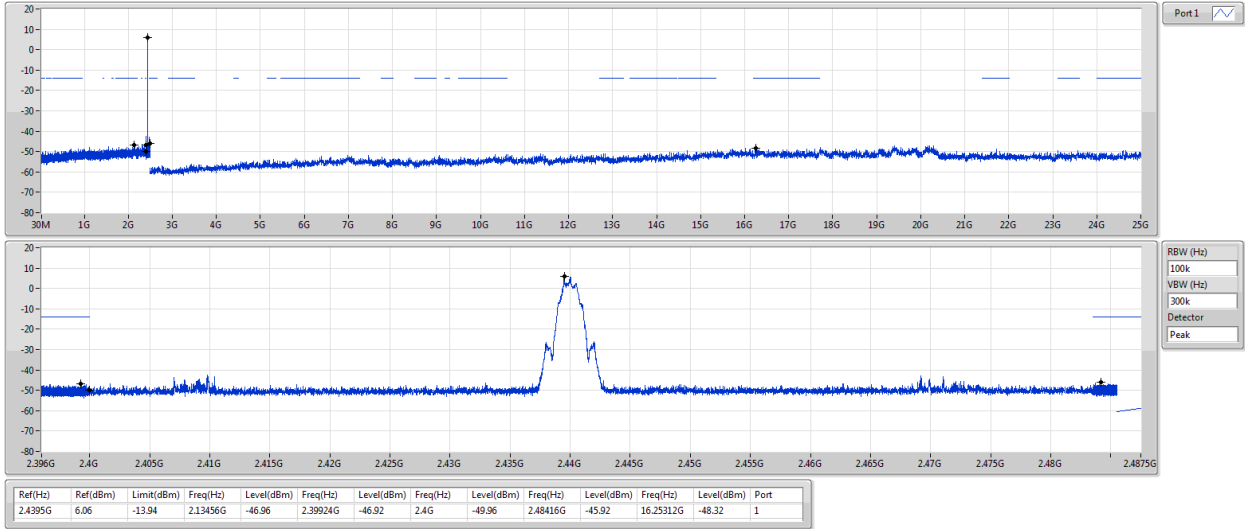

BT-LE(2Mbps)

CSEndB-DTS

2480MHz

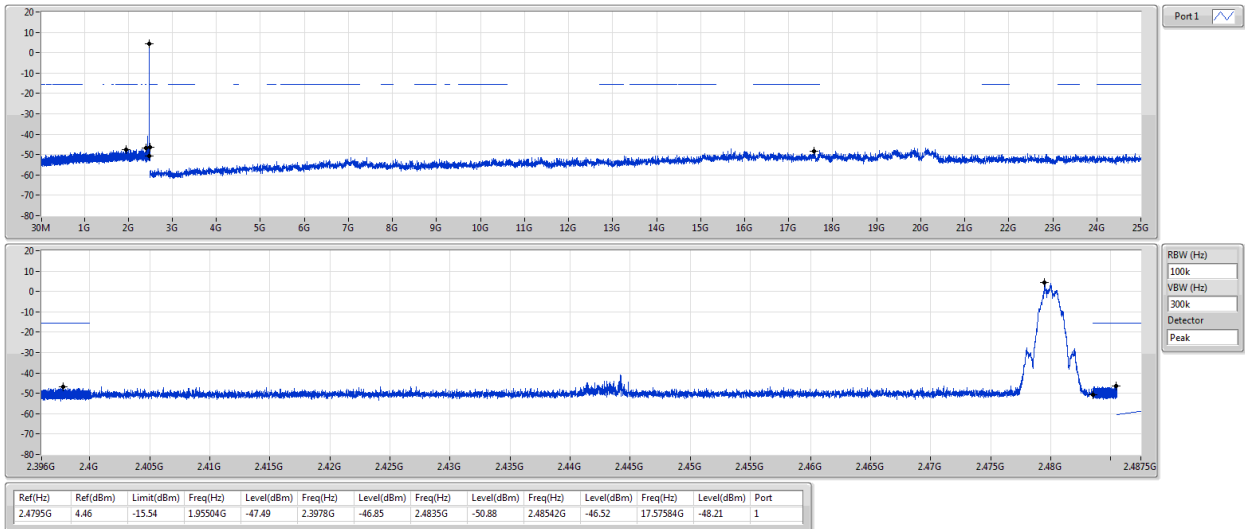

4 Test laboratory information

Established in 2012, ICC provides foremost EMC & RF Testing and advisory consultation services by our skilled engineers and technicians. Our services employ a wide variety of advanced edge test equipment and one of the widest certification extents in the business.

International Certification Corp (EMC and Wireless Communication Laboratory), it is our definitive objective is to institute long term, trust-based associations with our clients. The expectation we set up with our clients is based on outstanding service, practical expertise and devotion to a certified value structure. Our passion is to grant our clients with best EMC / RF services by oriented knowledgeable and accommodating staff.

Our Test sites are located at Linkou District and Kwei Shan District. Location map can be found on our website <http://www.icertifi.com.tw>.

Linkou

Tel: 886-2-2601-1640

No.30-2, Ding Fwu Tsuen, Lin Kou
District, New Taipei City, Taiwan
(R.O.C.)

Kwei Shan

Tel: 886-3-271-8666

No.3-1, Lane 6, Wen San 3rd
St., Kwei Shan Dist., Tao Yuan
City 33381, Taiwan (R.O.C.)

No.2-1, Lane 6, Wen San 3rd
St., Kwei Shan Dist., Tao Yuan
City 33381, Taiwan (R.O.C.)

Kwei Shan Site II

Tel: 886-3-271-8640

No.14-1, Lane 19, Wen San 3rd
St., Kwei Shan Dist., Tao Yuan
City 333, Taiwan (R.O.C.)

If you have any suggestion, please feel free to contact us as below information.

Tel: 886-3-271-8666

Fax: 886-3-318-0345

Email: ICC_Service@icertifi.com.tw

==END==