

Application For Grant of Certification

FOR

FOR

Model: RMB024

2412-2462 MHz

Broadband Digital Transmission System

FCC ID: SQG-RMB024

IC: 3147A-RMB024

FOR

Laird Technologies

11160 Thompson Avenue

Lenexa, KS 66219

Test Report Number: 140728

Authorized Signatory: *Scot D Rogers*

Scot D. Rogers

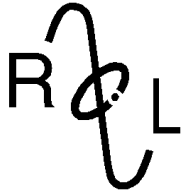

ROGERS LABS, INC.

4405 West 259th Terrace
Louisburg, KS 66053
Phone / Fax (913) 837-3214

Engineering Test Report For Grant of Certification Application

FOR
CFR 47, PART 15C - Intentional Radiators
CFR 47 Paragraph 15.247 and
Industry Canada RSS-210
License Exempt Intentional Radiator Module

For

Laird Technologies

11160 Thompson Avenue
Lenexa, KS 66219

Broadband Digital Transmission System
Model: RMB024
Frequency Range 2412-2462 MHz
FCC ID#: SQG-RMB024
IC: 3147A-RMB024

Test Date: July 28, 2014

Certifying Engineer: *Scot D. Rogers*

Scot D. Rogers
Rogers Labs, Inc.
4405 West 259th Terrace
Louisburg, KS 66053
Telephone/Facsimile: (913) 837-3214

This report shall not be reproduced except in full, without the written approval of the laboratory. This report must not be used by the client to claim product certification, approval, or endorsement by NVLAP, NIST, or any agency of the Federal Government.



Table Of Contents

TABLE OF CONTENTS..... 3

REVISIONS..... 4

FORWARD 5

OPINION / INTERPRETATION OF RESULTS 5

EQUIPMENT TESTED..... 5

EQUIPMENT FUNCTION AND CONFIGURATION..... 6

 Equipment Configuration.....6

APPLICATION FOR CERTIFICATION..... 7

APPLICABLE STANDARDS & TEST PROCEDURES 8

EQUIPMENT TESTING PROCEDURES 8

 AC Line Conducted Emission Test Procedure8

 Radiated Emission Test Procedure.....8

 Diagram 1 Test arrangement for Conducted emissions9

 Diagram 2 Test arrangement for radiated emissions of tabletop equipment.....10

 Diagram 3 Test arrangement for radiated emissions tested on Open Area Test Site (OATS).....11

TEST SITE LOCATIONS 11

LIST OF TEST EQUIPMENT 12

UNITS OF MEASUREMENTS 13

ENVIRONMENTAL CONDITIONS..... 13

INTENTIONAL RADIATORS..... 13

 Antenna Requirements13

 Restricted Bands of Operation.....13

 Table 1 Radiated Emissions in Restricted Bands Data (worst-case)14

 Summary of Results for Radiated Emissions in Restricted Bands15

 AC Line Conducted Emissions Procedure15

 Figure 1 AC Line Conducted Emissions Line 116

 Figure 2 AC Line Conducted Emissions Line 216

 Table 2 AC Line Conducted Emissions Data (Highest Emissions Line L1)17



Table 3 AC Line Conducted Emissions Data (Highest Emissions Line L2)17

Summary of Results for AC Line Conducted Emissions17

General Radiated Emissions Procedure18

Table 4 General Radiated Emissions from EUT Data (Highest Emissions)19

Summary of Results for General Radiated Emissions19

Operation in the Band 2400 – 2483.5 MHz20

Figure 3 Plot of Transmitter Emissions in Operational Frequency (802.11b Mode).....21

Figure 4 Plot of Transmitter Emissions in Operational Frequency (802.11g Mode).....21

Figure 5 Plot of Transmitter Emissions in Operational Frequency (802.11b Mode).....22

Figure 6 Plot of Transmitter Emissions in Operational Frequency (802.11g Mode).....22

Figure 7 Plot of Transmitter Emissions Low Band Edge (802.11 b-mode).....23

Figure 8 Plot of Transmitter Low Band Edge (802.11 g-mode).....23

Figure 9 Plot of Transmitter High Band Edge (802.11 b-mode)24

Figure 10 Plot of Transmitter High Band Edge (802.11 g-mode)24

Transmitter Emissions Data.....25

Table 5 Transmitter Radiated Emission (worst-case)25

Table 6 Transmitter Power and Operational Characteristics26

Summary of Results for Transmitter Radiated Emissions of Intentional Radiator26

STATEMENT OF MODIFICATIONS AND DEVIATIONS 26

ANNEX..... 27

Annex A Measurement Uncertainty Calculations.....28

Annex B Rogers Labs Test Equipment List.....29

Annex C Rogers Qualifications30

Annex D FCC Site Registration Letter.....31

Annex E Industry Canada Site Registration Letter32

Revisions

Revision 1 Issued August 6, 2014



Forward

The following information is submitted for consideration in obtaining Grant of Certification for License Exempt Digital Transmission System Intentional Radiator module operating under Code of Federal Regulations Title 47 (CFR 47) Paragraph 15.247 and Industry Canada RSS-210, operation in the 2400 – 2483.5 MHz band.

Name of Applicant: Laird Technologies
11160 Thompson Avenue
Lenexa, KS 66219

Model: RMB024

FCC ID.: SQG-RMB024 Industry Canada ID: 3147A-RMB024

Frequency Range (W-Fi, 802.11): 2412-2462 MHz with power level 1 Watt,

Occupied Bandwidth: occupied bandwidth 16,660 kHz,

Opinion / Interpretation of Results

Tests Performed	Margin (dB)	Results
Emissions as per CFR 47 paragraphs 2 and 15.205	-7.9	Complies
Emissions as per CFR 47 paragraphs 2 and 15.207	-2.7	Complies
Emissions as per CFR 47 paragraphs 2 and 15.209	-8.7	Complies
Harmonic Emissions per CFR 47 15.247	-7.9	Complies
Peak Power Spectral Density per CFR 47 15.247	-6..2	Complies

Equipment Tested

<u>Equipment</u>	<u>Model / PN</u>	<u>Serial Number</u>
EUT	RMB024	PP7
Laptop computer	Lenovo / 4290	R9-LWW3M12/02

Test results in this report relate only to the items tested.

Equipment Function and Configuration

The EUT is a 2412-2462 MHz Digital Transmission System used to transmit data in applications offering broadband wireless connectivity. The design utilizes fixed internal antenna providing 5dBi of gain and offers no provision for antenna replacement by the end user. The design requires power direct current power for operation. DC power may be supplied over the network lines by an 802.3af compliant Power Over Ethernet (POE) injector. The equipment is marketed for use to incorporate a wireless link to exchange data information from one point to another. For testing purposes, the RMB024 transceiver was connected to the manufacturer supplied POE and communicating to the laptop computer through Ethernet network interface. Test software was used to configure and control the transmitter during testing. This configuration offered operational control of the transmitter and communications over the network interface between the EUT and supporting computer system. A test sample was provided without internal antenna connected providing testing personnel opportunity to complete antenna port conducted measurements. No other interfacing options are provided.

Equipment Configuration

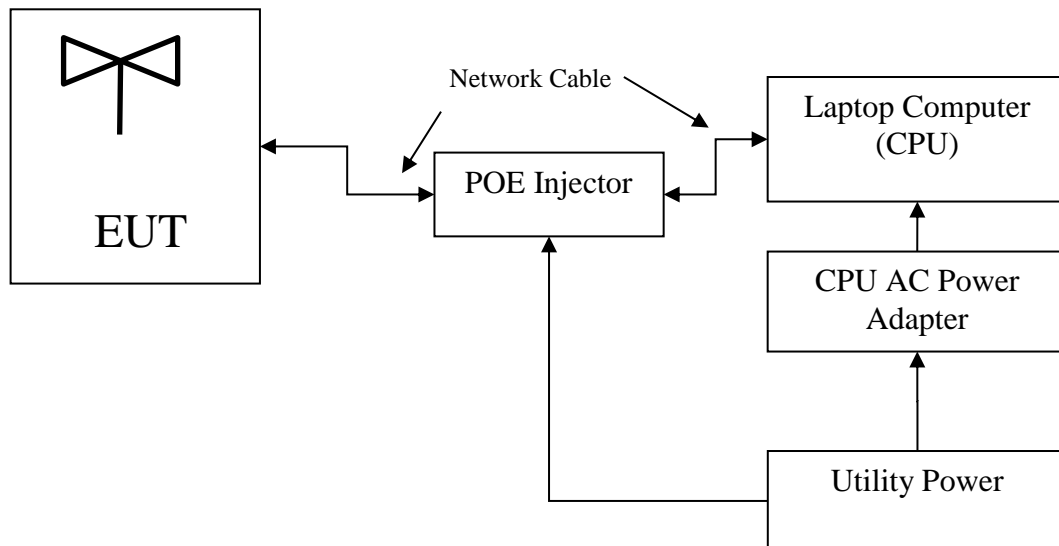



Application for Certification

- (1) Manufacturer: Laird Technologies
11160 Thompson Avenue
Lenexa, KS 66219
- (2) Identification: Model: RMB024
FCC I.D.: SQG-RMB024 IC ID: 3147A-RMB024
- (3) Instruction Book:
Refer to Exhibit for Instruction Manual.
- (4) Description of Circuit Functions:
Refer to Exhibit of Operational Description.
- (5) Block Diagram with Frequencies:
Refer to Exhibit of Operational Description.
- (6) Report of Measurements:
Report of measurements follows in this Report.
- (7) Photographs: Construction, Component Placement, etc.:
Refer to Exhibit for photographs of equipment.
- (8) List of Peripheral Equipment Necessary for operation. The equipment requires direct current power for operation. The EUT offers single Ethernet network connection port for input output interface. The EUT offers no other connection ports than those presented in this filing.
- (9) Transition Provisions of CFR47 15.37 are not requested.
- (10) Not Applicable. The unit is not a scanning receiver.
- (11) Not Applicable. The EUT does not operate in the 59 – 64 GHz frequency band.
- (12) The equipment is not software defined and this section is not applicable.

Applicable Standards & Test Procedures

In accordance with the Federal Communications Code of Federal Regulations, dated October 1, 2013, Part 2, Subpart J, Paragraphs 2.907, 2.911, 2.913, 2.925, 2.926, 2.1031 through 2.1057, and applicable parts of paragraph 15, Part 15C Paragraphs 15.212, 15.247, and RSS-210 the following information is submitted. Test procedures used are the established Methods of Measurement of Radio-Noise Emissions as described in ANSI C63.10-2009, FCC KDB documents KDB 558074 D01 v03r02 and KDB 913591.

Equipment Testing Procedures

AC Line Conducted Emission Test Procedure

Testing for the AC line-conducted emissions was performed as defined in ANSI C63.10-2009. The test setup, including the EUT, was arranged in the test configurations as presented during testing. The test configuration was placed on a 1 x 1.5-meter wooden bench, 0.8 meters high located in a screen room. The power lines of the system were isolated from the power source using a standard LISN with a 50- μ Hy choke. EMI was coupled to the spectrum analyzer through a 0.1 μ F capacitor internal to the LISN. The LISN was positioned on the floor beneath the wooden bench supporting the EUT. The power lines and cables were draped over the back edge of the table. Refer to diagram 1 showing typical test arrangement and photographs in exhibits for EUT placement used during testing.

Radiated Emission Test Procedure

The EUT was placed on a rotating 1 x 1.5-meter wooden platform, 0.8 meters above the ground plane at a distance of 3 meters from the FSM antenna. Radiated emissions testing was performed as required in CFR47 15, RSS-210 and specified in section 6 of ANSI C63.10-2009. EMI energy was maximized by equipment placement, raising and lowering the FSM antenna, changing the antenna polarization, and by rotating the turntable. Each emission was maximized before data was taken using a spectrum analyzer. The frequency spectrum from 9 kHz to 25,000 MHz was searched for during preliminary investigation. Refer to diagrams 2 and 3 showing typical test arrangement and photographs in the test setup exhibits for specific EUT placement during testing.

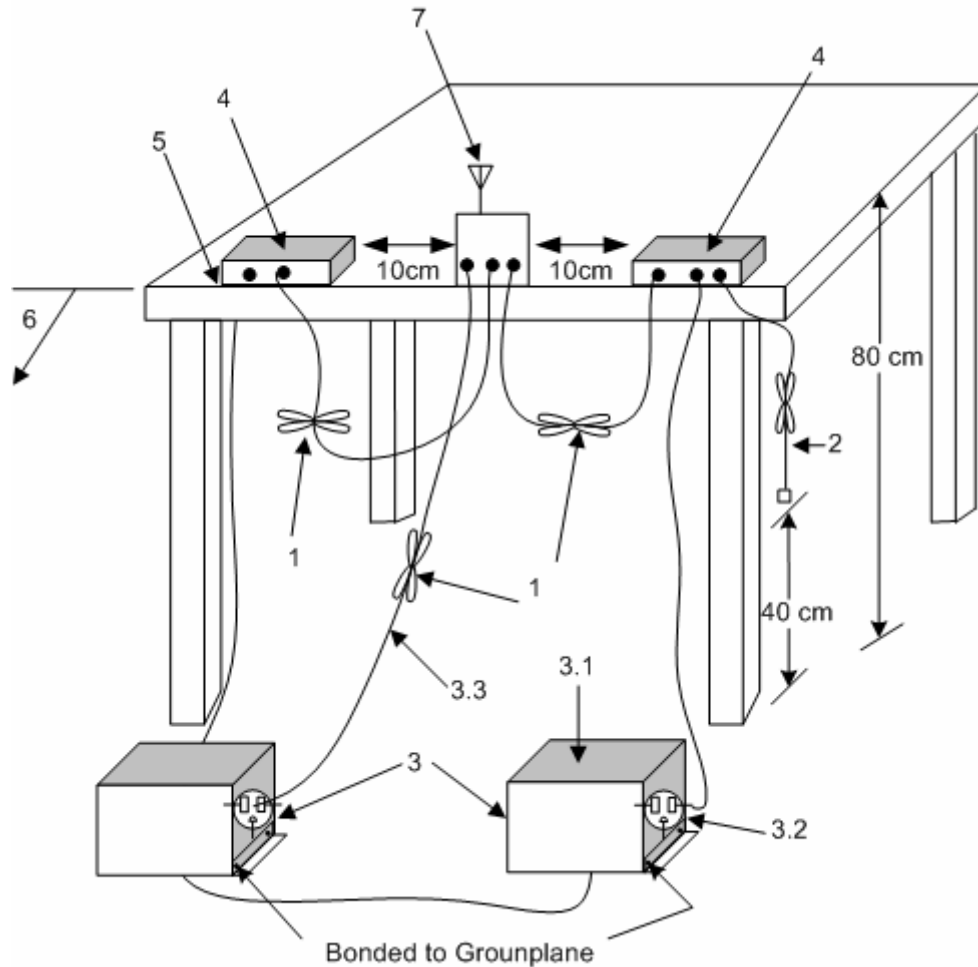

1. Interconnecting cables that hang closer than 40 cm to the ground plane shall be folded back and forth in the center forming a bundle 30 cm to 40 cm long see (see 6.2.3.1).
2. I/O cables that are not connected to an accessory shall be bundled in the center. The end of the cable may be terminated, if required, using the correct terminating impedance. The overall length shall not exceed 1 m (see 6.2.2).
3. EUT connected to one LISN. Unused LISN measuring port connectors shall be terminated in 50 Ω loads. LISN can be placed on top of, or immediately beneath, reference ground plane (see 6.2.2 and 6.2.3).
 - 3.1 All other equipment powered from additional LISN(s).
 - 3.2 Multiple-outlet strip can be used for multiple power cords of non-EUT equipment.
 - 3.3 LISN at least 80 cm from nearest part of EUT chassis.
4. Non-EUT components of EUT system being tested.
5. Rear of EUT, including peripherals, shall all be aligned and flush with rear of tabletop (see 6.2.3.1).
6. Edge of tabletop shall be 40 cm removed from a vertical conducting plane that is bonded to the ground plane (see 6.2.2 for options).
7. Antenna may be integral or detachable. If detachable, the antenna shall be attached for this test.

Diagram 1 Test arrangement for Conducted emissions

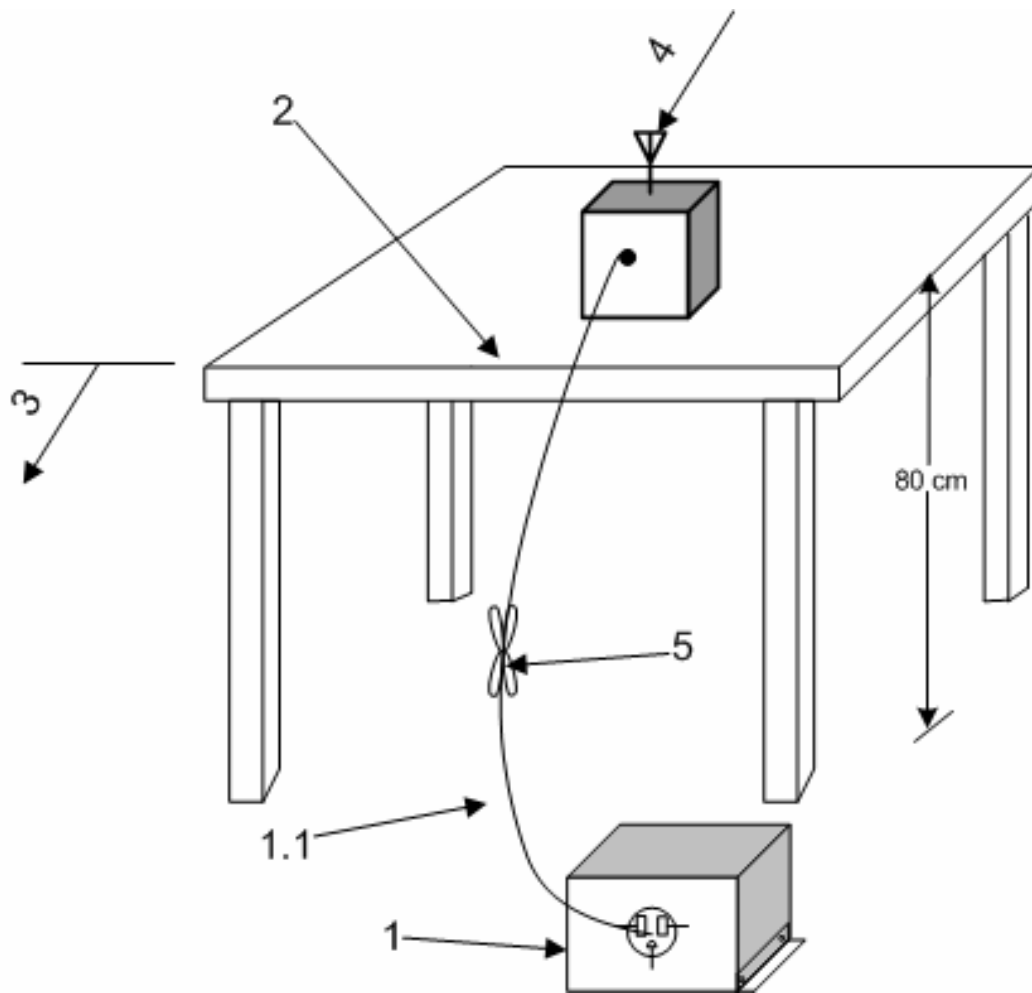

1. A LISN is optional for radiated measurements between 30 MHz to 1000 MHz, but not allowed for measurements below 30 MHz and above 1000 MHz. (See 6.4.3, 6.5.1, and 6.6.3.) If used, connect EUT to one LISN. Unused LISN measuring port connectors shall be terminated in 50Ω. LISN can be placed on top of, or immediately beneath, reference ground plane (see 6.2.2 and 6.2.3.1).
 - 1.1 LISN spaced at least 80 cm from nearest part of EUT chassis.
2. The EUT shall be placed in the center of the table to the extent possible. (See 6.2.3.1 and 6.3.4).
3. A vertical conducting plane, if used for conducted tests per 6.2.2, shall be removed for radiated emission tests.
4. Antenna may be integral or detachable, depending on the EUT.
5. Interconnecting cables that hang closer than 40 cm to the ground plane shall be folded back and forth in the center forming a bundle 30 cm to 40 cm long.

Diagram 2 Test arrangement for radiated emissions of tabletop equipment

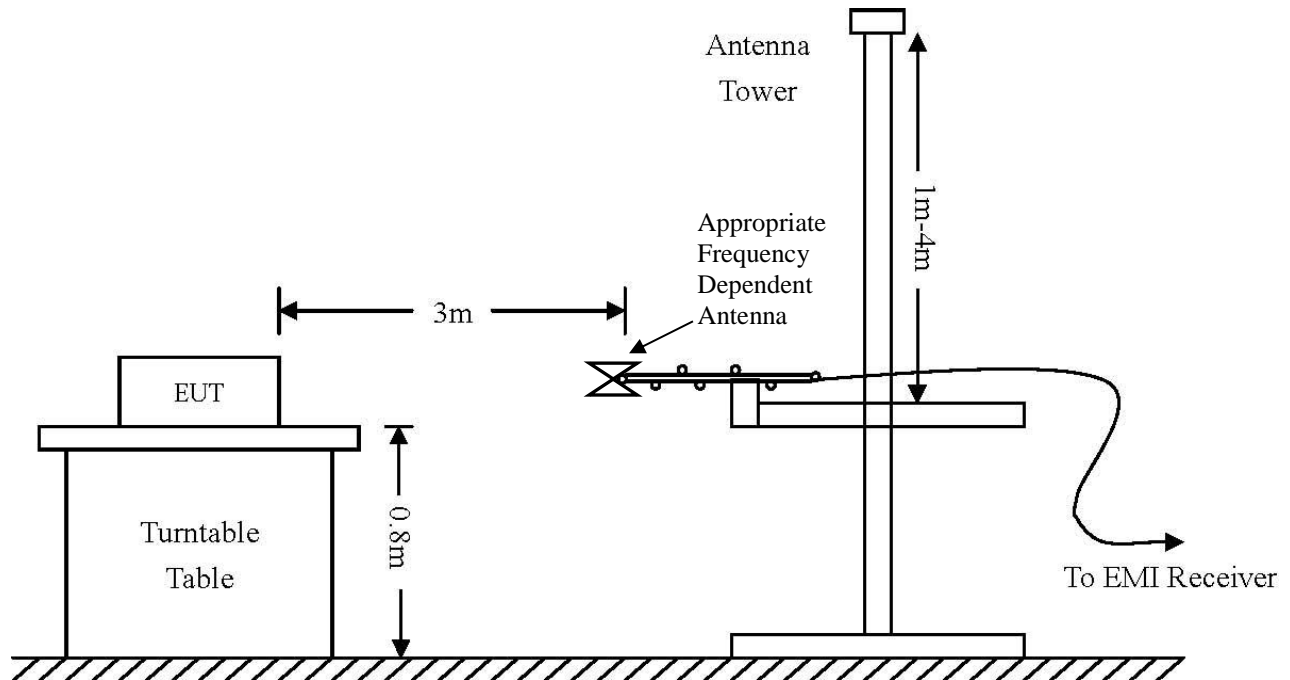

Frequency: 9 kHz-30 MHz	Frequency: 30 MHz- 1 GHZ	Frequency: Above 1 GHZ
RBW = 9 kHz	RBW = 120 kHz	RBW = 1 MHz
VBW = 30 kHz	VBW = 120 kHz	VBW = 1 MHz
Sweep time = Auto	Sweep time = Auto	Sweep time = Auto
Detector = PK, QP	Detector = PK, QP	Detector = PK, AV

Diagram 3 Test arrangement for radiated emissions tested on Open Area Test Site (OATS)

Test Site Locations

Conducted EMI The AC power line conducted emissions testing performed in a shielded screen room located at Rogers Labs, Inc., 4405 W. 259th Terrace, Louisburg, KS

Radiated EMI The radiated emissions tests were performed at the 3 meters, Open Area Test Site (OATS) located at Rogers Labs, Inc., 4405 W. 259th Terrace, Louisburg, KS

Site Registration Refer to Annex for Site Registration Letters

NVLAP Accreditation Lab code 200087-0

Rogers Labs, Inc.
4405 W. 259th Terrace
Louisburg, KS 66053
Phone/Fax: (913) 837-3214
Revision 1

Laird Technologies
Model: RMB024
Test #: 140728
Test to: CFR47 (15.247), RSS-210 (DTS)
File: Laird RMB024 TstRpt 140728

SN: PP7
FCC ID#: SQG-RMB024
IC: 3147A-RMB024
Date: August 6, 2014
Page 11 of 32

List of Test Equipment

A Rohde and Schwarz ESU40 and/or Hewlett Packard 8591EM was used as the measuring device for the emissions testing of frequencies below 1 GHz. A Rohde and Schwarz ESU40 and/or Hewlett Packard 8562A Spectrum Analyzer was used as the measuring device for testing the emissions at frequencies above 1 GHz. The analyzer settings used are described in the following table. Refer to the appendix for a complete list of test equipment.

AC Line Conducted Emissions (0.150 -30 MHz)		
RBW	AVG. BW	Detector Function
9 kHz	30 kHz	Peak / Quasi Peak
Emissions (30-1000 MHz)		
RBW	AVG. BW	Detector Function
120 kHz	300 kHz	Peak / Quasi Peak
Emissions (Above 1000 MHz)		
RBW	Video BW	Detector Function
100 kHz	100 kHz	Peak
1 MHz	1 MHz	Peak / Average

<u>Equipment</u>	<u>Manufacturer</u>	<u>Model (SN)</u>	<u>Band</u>	<u>Cal Date</u>	<u>Due</u>
<input checked="" type="checkbox"/> LISN	Comp. Design	FCC-LISN-2-MOD.CD(126)	0.15-30MHz	10/13	10/14
<input checked="" type="checkbox"/> Cable	Time Microwave	750HF290-750 (L10M)	9kHz-40 GHz	10/13	10/14
<input checked="" type="checkbox"/> Cable	Belden	RG-58 (L1-CAT3-11509)	9kHz-30 MHz	10/13	10/14
<input checked="" type="checkbox"/> Cable	Belden	RG-58 (L2-CAT3-11509)	9kHz-30 MHz	10/13	10/14
<input type="checkbox"/> Antenna	ARA	BCD-235-B (169)	20-350MHz	10/13	10/14
<input type="checkbox"/> Antenna	EMCO	3147 (40582)	200-1000MHz	10/13	10/14
<input checked="" type="checkbox"/> Antenna	Com Power	AH-118 (10110)	1-18 GHz	10/13	10/14
<input checked="" type="checkbox"/> Antenna	Com Power	AH-840 (101046)	18-40 GHz	5/14	5/15
<input checked="" type="checkbox"/> Antenna	EMCO	6509 (9502-1374)	.001-30 MHz	10/13	10/14
<input checked="" type="checkbox"/> Antenna	Sunol	JB-6 (A100709)	30-1000 MHz	10/13	10/14
<input checked="" type="checkbox"/> Antenna	Standard	FXRY638A (621786)	10-18 GHz	5/14	5/15
<input type="checkbox"/> Antenna	EMCO	3143 (9607-1277)	20-1200 MHz	5/14	5/15
<input type="checkbox"/> Analyzer	HP	8591EM (3628A00871)	9kHz-1.8GHz	5/14	5/15
<input checked="" type="checkbox"/> Analyzer	HP	8562A (3051A05950)	9kHz-110GHz	5/14	5/15
<input checked="" type="checkbox"/> Power Meter	HP	N1911A (MY45102088)	50MHz-18GHz	5/14	5/15
<input checked="" type="checkbox"/> Power Sensor	HP	N1921A (MY45241502)	50MHz-18GHz	5/14	5/15
<input checked="" type="checkbox"/> Analyzer	Rohde & Schwarz	ESU40 (100108)	20Hz-40GHz	5/14	5/15
<input checked="" type="checkbox"/> Amplifier	Com-Power	PA-010 (171003)	100Hz-30MHz	10/13	10/14
<input checked="" type="checkbox"/> Amplifier	Com-Power	CPPA-102 (01254)	1-1000 MHz	10/13	10/14
<input checked="" type="checkbox"/> Amplifier	Com-Power	PAM-118A (551014)	0.5-18 GHz	10/13	10/14



Units of Measurements

Conducted EMI Data is in dB μ V; dB referenced to one microvolt

Radiated EMI Data is in dB μ V/m; dB/m referenced to one microvolt per meter

Sample Calculation:

RFS = Radiated Field Strength, FSM = Field Strength Measured

A.F. = Receive antenna factor, Gain = amplification gains and/or cable losses

RFS (dB μ V/m @ 3m) = FSM (dB μ V) + A.F. (dB) - Gain (dB)

Environmental Conditions

Ambient Temperature	23.4° C
Relative Humidity	41%
Atmospheric Pressure	1020.9 mb

Intentional Radiators

As per CFR47, Subpart C, paragraphs 15.212, 15.247 and RSS-210 the following information is submitted.

Antenna Requirements

The EUT incorporates integral antenna system and offers no provision for connection to alternate antenna system. The antenna connection point complies with the unique antenna connection requirements. There are no deviations or exceptions to the specification.

Restricted Bands of Operation

Spurious emissions falling in the restricted frequency bands of operation were measured at the OATS. The EUT utilizes frequency, determining circuitry, which generates harmonics falling in the restricted bands. Emissions were investigated at the OATS, using appropriate antennas or pyramidal horns, amplification stages, and a spectrum analyzer. Peak and average amplitudes of frequencies above 1000 MHz were compared to the required limits with worst-case data presented below. Test procedures of ANSI C63.10-2009 paragraph 6 and KDB 558074 paragraph 10.2 were used during testing. No other significant emission was observed which fell into the restricted bands of operation. Computed emission values take into account the received radiated field strength, receive antenna correction factor, amplifier gain stage, and test system cable losses.

Table 1 Radiated Emissions in Restricted Bands Data (worst-case)

Frequency in MHz	Horizontal Peak (dBµV/m)	Horizontal Quasi-Peak (dBµV/m)	Horizontal Average (dBµV/m)	Vertical Peak (dBµV/m)	Vertical Quasi-Peak (dBµV/m)	Vertical Average (dBµV/m)	Limit @ 3m (dBµV/m)
113.4	34.3	29.6	N/A	33.5	28.4	N/A	43.5
114.3	35.5	29.9	N/A	35.0	30.1	N/A	43.5
120.0	36.6	31.4	N/A	37.4	34.7	N/A	43.5
125.0	36.8	32.2	N/A	37.3	33.6	N/A	43.5
168.8	29.7	23.8	N/A	34.9	31.8	N/A	43.5
172.8	28.1	24.7	N/A	34.5	31.7	N/A	43.5
400.0	39.6	32.5	N/A	38.2	31.9	N/A	46.0
2390.0	46.3	N/A	33.2	48.3	N/A	36.0	54.0
2483.5	56.5	N/A	43.8	56.6	N/A	44.0	54.0
4824.0	59.4	N/A	44.4	59.4	N/A	43.2	54.0
4874.0	59.2	N/A	46.1	56.6	N/A	45.6	54.0
4924.0	54.0	N/A	16.6	16.1	N/A	42.7	54.0
7236.0	48.3	N/A	32.4	45.1	N/A	32.1	54.0
7311.0	42.4	N/A	31.6	41.8	N/A	32.1	54.0
7386.0	54.0	N/A	16.6	16.1	N/A	34.1	54.0
12060.0	49.3	N/A	33.6	46.9	N/A	31.4	54.0
12185.0	43.1	N/A	33.6	41.6	N/A	33.1	54.0
12310.0	44.3	N/A	33.3	50.3	N/A	33.3	54.0

Other emissions present had amplitudes at least 20 dB below the limit. Peak and Quasi-Peak amplitude emissions are recorded for frequency below 1000 MHz. Peak and Average amplitude emissions are recorded for frequency range above 1000 MHz.

Summary of Results for Radiated Emissions in Restricted Bands

The EUT demonstrated compliance with the radiated emissions requirements of CFR 47 Part 15C and RSS-210 Intentional Radiators. The EUT demonstrated a worst-case minimum harmonic margin of -7.9 dB below the radiated emissions requirements and -8.8 dB (general emissions) below requirements in restricted frequency bands. Peak, Quasi-peak, and average amplitudes were checked for compliance with the regulations. Worst-case emissions are reported with other emissions found in the restricted frequency bands at least 20 dB below the requirements.

AC Line Conducted Emissions Procedure

The EUT was arranged in a typical equipment configuration and placed on a 1 x 1.5-meter wooden bench 80 cm above the conducting ground plane, floor of a screen room. The bench was positioned 40 cm away from the wall of the screen room. The LISN was positioned on the floor of the screen room 80-cm from the rear of the EUT. The manufacturer supplied AC power adapter for the EUT was connected to the LISN. A second LISN was positioned on the floor of the screen room 80-cm from the rear of the supporting equipment of the EUT. All power cords except the EUT were then powered from the second LISN. EMI was coupled to the spectrum analyzer through a 0.1 μ F capacitor, internal to the LISN. Power line conducted emissions testing were carried out individually for each current carrying conductor of the EUT. The excess length of lead between the system and the LISN receptacle was folded back and forth to form a bundle not exceeding 40 cm in length. The screen room, conducting ground plane, analyzer, and LISN were bonded together to the protective earth ground. Preliminary testing was performed to identify the frequency of each emission displaying the highest amplitude. The cables were repositioned to obtain maximum amplitude of measured EMI level. Once the worst-case configuration was identified, plots were made of the EMI from 0.15 MHz to 30 MHz then the data was recorded with maximum conducted emissions levels. Refer to figures one and two for plots of the EUT AC Line Conducted emissions while operating with the manufacturer supplied POE injector.

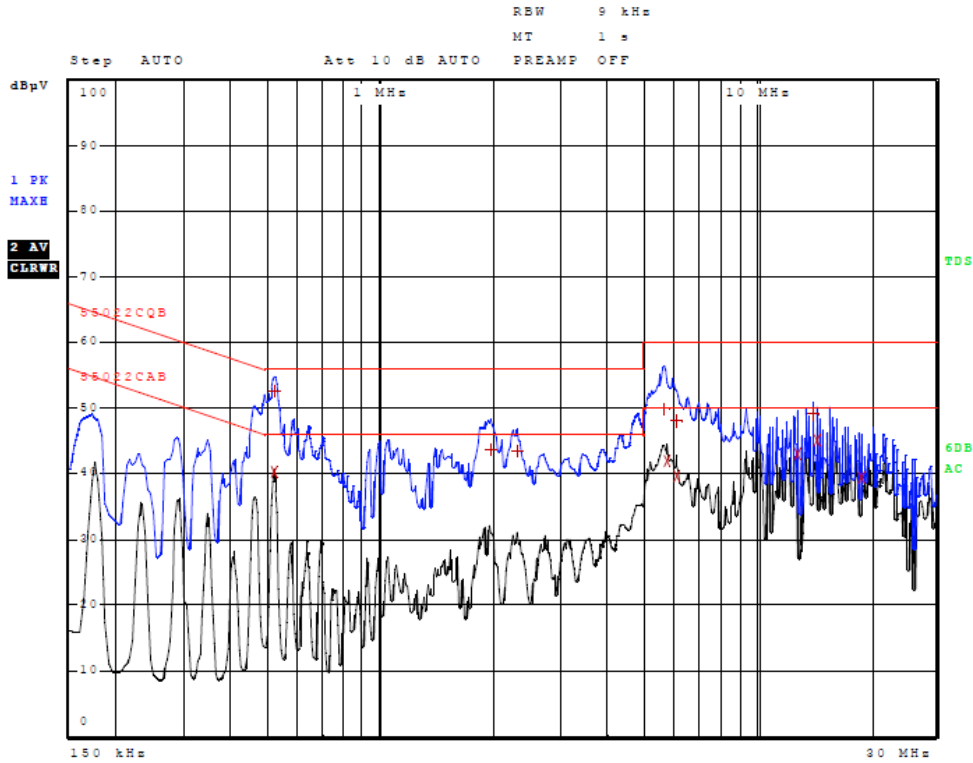

Figure 1 AC Line Conducted Emissions Line 1

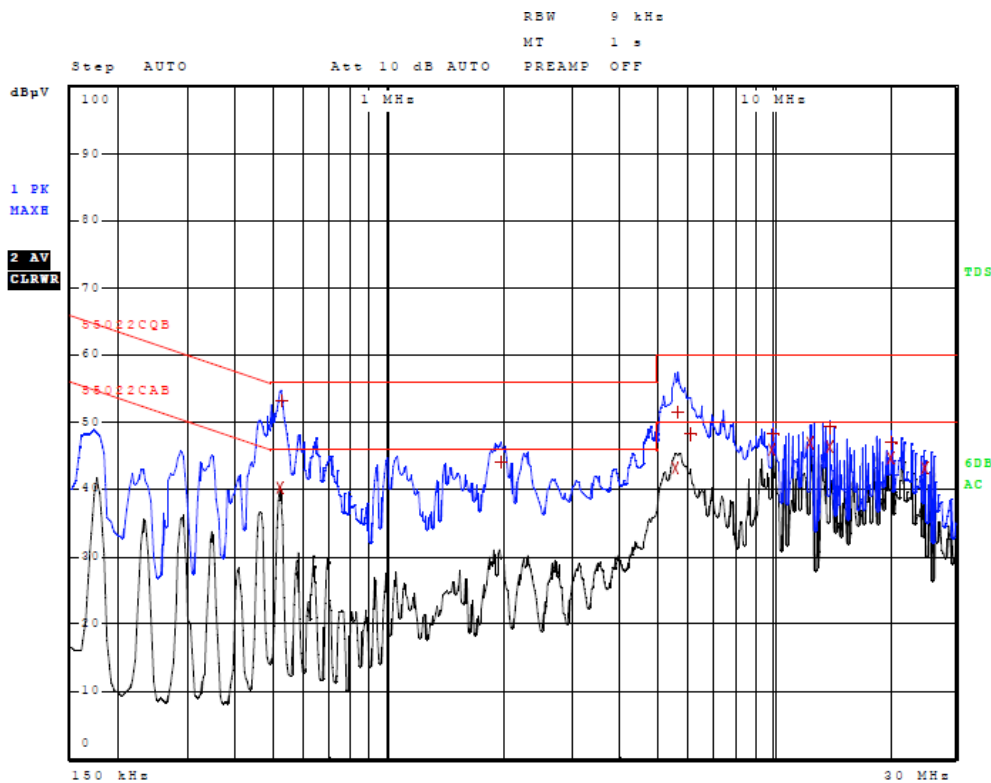

Figure 2 AC Line Conducted Emissions Line 2



Table 2 AC Line Conducted Emissions Data (Highest Emissions Line L1)

Trace	Frequency	Level (dBµV)	Detector	Delta Limit/dB
1	518.000000000 kHz	52.73	Quasi Peak	-3.27
2	518.000000000 kHz	40.17	Average	-5.83
1	1.962000000 MHz	43.61	Quasi Peak	-12.39
1	2.306000000 MHz	43.30	Quasi Peak	-12.70
1	5.676000000 MHz	49.99	Quasi Peak	-10.01
2	5.756000000 MHz	41.88	Average	-8.12
1	6.132000000 MHz	48.00	Quasi Peak	-12.00
2	6.132000000 MHz	39.51	Average	-10.49
2	12.864000000 MHz	42.97	Average	-7.03
1	14.092000000 MHz	49.02	Quasi Peak	-10.98
2	14.400000000 MHz	45.11	Average	-4.89
2	18.992000000 MHz	39.46	Average	-10.54

Other emissions present had amplitudes at least 20 dB below the limit.

Table 3 AC Line Conducted Emissions Data (Highest Emissions Line L2)

Trace	Frequency	Level (dBµV)	Detector	Delta Limit/dB
2	518.000000000 kHz	40.13	Average	-5.87
1	522.000000000 kHz	53.27	Quasi Peak	-2.73
1	1.958000000 MHz	44.06	Quasi Peak	-11.94
2	5.604000000 MHz	43.20	Average	-6.80
1	5.660000000 MHz	51.55	Quasi Peak	-8.45
1	6.140000000 MHz	48.21	Quasi Peak	-11.79
2	9.940000000 MHz	45.94	Average	-4.06
1	10.060000000 MHz	48.13	Quasi Peak	-11.87
2	12.560000000 MHz	46.94	Average	-3.06
1	14.092000000 MHz	49.21	Quasi Peak	-10.79
2	14.092000000 MHz	46.41	Average	-3.59
1	20.220000000 MHz	46.99	Quasi Peak	-13.01
2	20.220000000 MHz	44.73	Average	-5.27
2	24.816000000 MHz	43.12	Average	-6.88

Other emissions present had amplitudes at least 20 dB below the limit.

Summary of Results for AC Line Conducted Emissions

The EUT demonstrated compliance to the conducted emissions requirements of CFR47 Part 15C equipment. The EUT demonstrated minimum margin of -2.7 dB below the limit. Measurements were taken using the peak, quasi peak, and average, measurement function for each emissions amplitude and were below the limits stated in the specification. Other emissions were present with recorded data representing worst-case amplitudes.



General Radiated Emissions Procedure

The EUT was arranged in a typical equipment configuration and operated through all available modes with worst-case data recorded. Preliminary testing was performed in a screen room with the EUT positioned 1 meter from the FSM. Radiated emissions measurements were performed to identify the frequencies, which produced the highest emissions. Each radiated emission was then maximized at the OATS location before final radiated emissions measurements were performed. Final data was taken with the EUT located at the OATS at a distance of 3 meters between the EUT and the receiving antenna. The frequency spectrum from 9 kHz to 25,000 MHz was searched for general radiated emissions. Measured emission levels were maximized by EUT placement on the table, rotating the turntable through 360 degrees, varying the antenna height between 1 and 4 meters above the ground plane and changing antenna position between horizontal and vertical polarization. Antennas used were Loop from 9 kHz to 30 MHz, Broadband Biconical from 30 to 200 MHz, Biconilog from 30 to 1000 MHz, Log Periodic from 200 MHz to 1 GHz and or double Ridge or pyramidal horns and mixers from 1 GHz to 40 GHz, notch filters and appropriate amplifiers and external mixers were utilized.

Table 4 General Radiated Emissions from EUT Data (Highest Emissions)

Frequency in MHz	Horizontal Peak (dBµV/m)	Horizontal Quasi-Peak (dBµV/m)	Horizontal Average (dBµV/m)	Vertical Peak (dBµV/m)	Vertical Quasi-Peak (dBµV/m)	Vertical Average (dBµV/m)	Limit @ 3m (dBµV/m)
50.5	37.3	28.3	N/A	37.7	29.8	N/A	40.0
81.2	34.3	29.2	N/A	34.1	26.6	N/A	40.0
81.5	35.5	29.6	N/A	35.8	31.3	N/A	40.0
82.1	33.6	28.5	N/A	34.7	29.6	N/A	40.0
84.6	31.8	26.4	N/A	33.0	26.8	N/A	40.0
85.5	32.6	27.3	N/A	34.3	29.7	N/A	40.0
86.1	29.7	25.8	N/A	30.7	26.6	N/A	40.0
90.4	38.2	33.2	N/A	35.4	28.7	N/A	43.5
91.6	36.3	30.2	N/A	36.5	31.1	N/A	43.5
92.4	36.1	31.0	N/A	35.5	30.3	N/A	43.5
113.4	34.3	29.6	N/A	33.5	28.4	N/A	43.5
114.3	35.5	29.9	N/A	35.0	30.1	N/A	43.5
120.0	36.6	31.4	N/A	37.4	34.7	N/A	43.5
125.0	36.8	32.2	N/A	37.3	33.6	N/A	43.5
145.3	32.8	27.4	N/A	32.6	27.8	N/A	43.5
151.6	32.6	27.2	N/A	30.8	26.1	N/A	43.5
168.8	29.7	23.8	N/A	34.9	31.8	N/A	43.5
172.8	28.1	24.7	N/A	34.5	31.7	N/A	43.5
200.0	30.3	26.3	N/A	30.3	27.3	N/A	43.5
201.6	28.3	23.4	N/A	27.9	24.1	N/A	43.5
400.0	39.6	32.5	N/A	38.2	31.9	N/A	46.0
625.0	37.6	36.0	N/A	37.8	36.3	N/A	46.0

Other emissions present had amplitudes at least 20 dB below the limit. Peak and Quasi-Peak amplitude emissions are recorded for frequency range below 1000 MHz. Peak and Average amplitude emissions are recorded for frequency range above 1000 MHz.

Summary of Results for General Radiated Emissions

The EUT demonstrated compliance with the radiated emissions requirements of CFR47 Part 15C paragraph 15.209 and RSS-210 Intentional Radiators. The EUT demonstrated a minimum margin of -8.7 dB below the requirements. Other emissions were present with amplitudes at least 20 dB below the Limits.



Operation in the Band 2400 – 2483.5 MHz

Test procedures of ANSI C63.10-2009 paragraph 6 and KDB 558074 v03r02 were used during transmitter testing. The transmitter peak power was measured at the antenna port using a wide band peak RF power meter. Transmitter harmonic and general radiated emissions were measured on an open area test site @ 3 meters. The EUT was placed on a wooden turntable 0.8 meters above the ground plane and at a distance of 3 meters from the FSM antenna. The amplitude of each radiated emission was measured on the OATS at a distance of 3 meters from the FSM antenna (testing was performed on sample 1 representative of production with integral antenna). Each radiated emission was maximized by varying the FSM antenna height and polarization, and by rotating the turntable. The worst-case amplitude of each emission was then recorded from the analyzer display. The peak and quasi-peak amplitude of frequencies below 1000 MHz were measured using a spectrum analyzer. The peak and average amplitude of frequencies above 1000 MHz were measured using a spectrum analyzer. A Loop antenna was used for measuring emissions from 0.009 to 30 MHz, Biconilog Antenna for 30 to 1000 MHz, Double-Ridge, and/or Pyramidal Horn Antennas from 1 GHz to 25 GHz. Emissions were measured in dB μ V/m @ 3 meters. The test sample was disassembled to allow access to the U.FL antenna connection port, allowing for antenna port conducted emissions testing. Plots were taken of transmitter performance (using sample with access to antenna port) for reference in this and other documentation.

Refer to figures three through ten showing plots taken of the 2412-2462 MHz operation performance displaying compliance with the specifications.

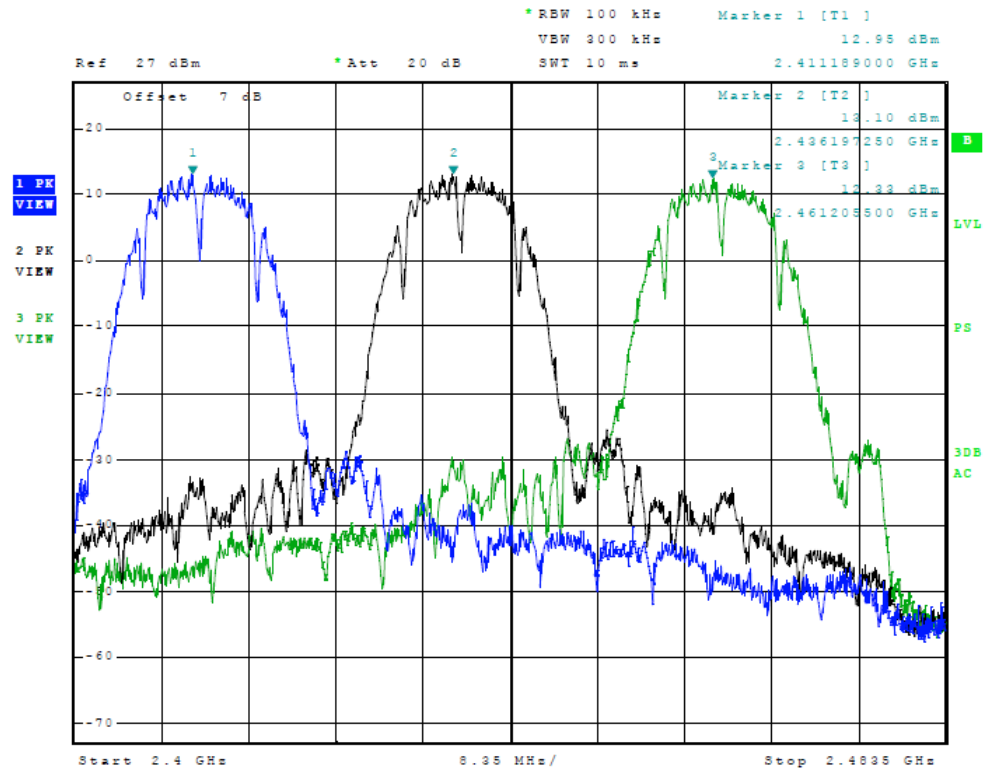

Figure 3 Plot of Transmitter Emissions in Operational Frequency (802.11b Mode)

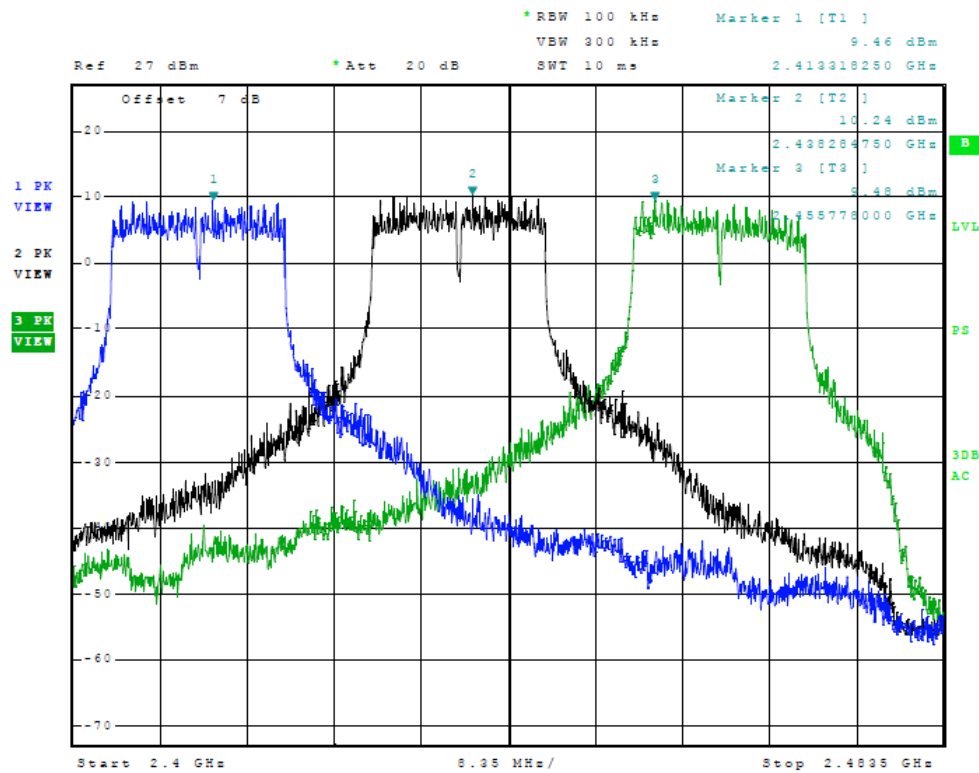

Figure 4 Plot of Transmitter Emissions in Operational Frequency (802.11g Mode)

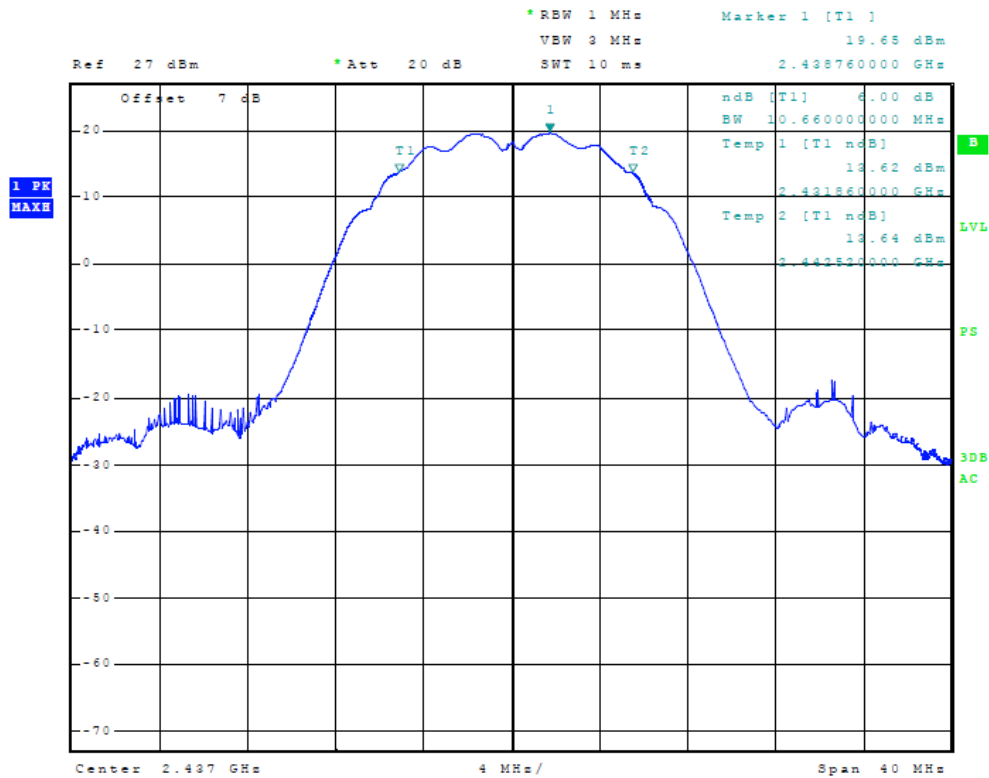

Figure 5 Plot of Transmitter Emissions in Operational Frequency (802.11b Mode)

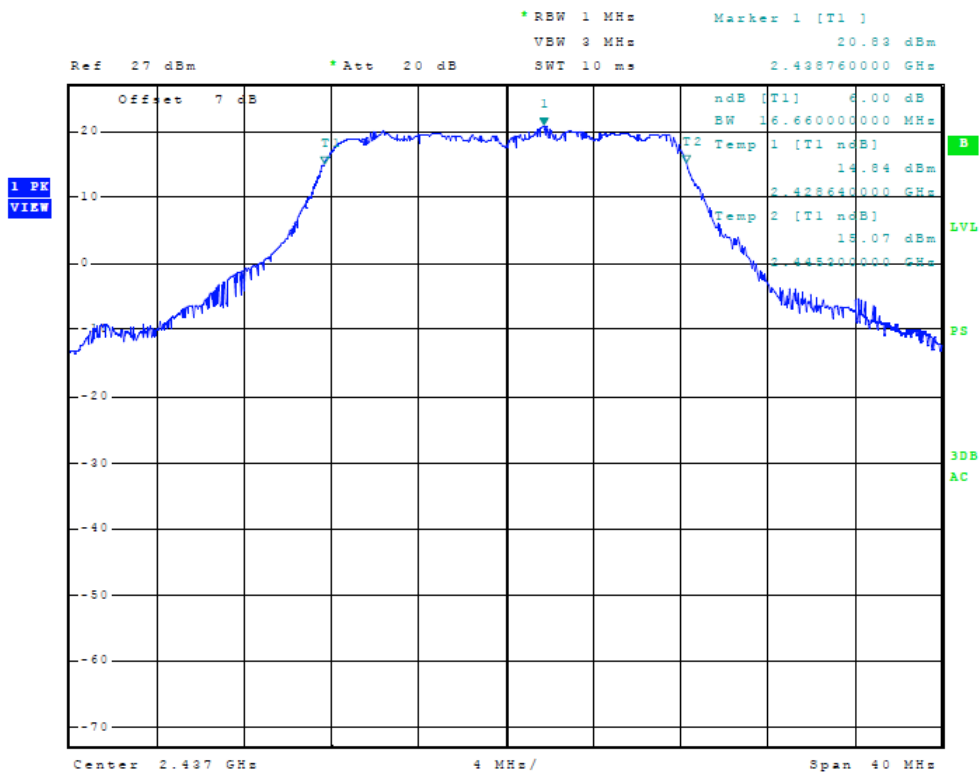

Figure 6 Plot of Transmitter Emissions in Operational Frequency (802.11g Mode)

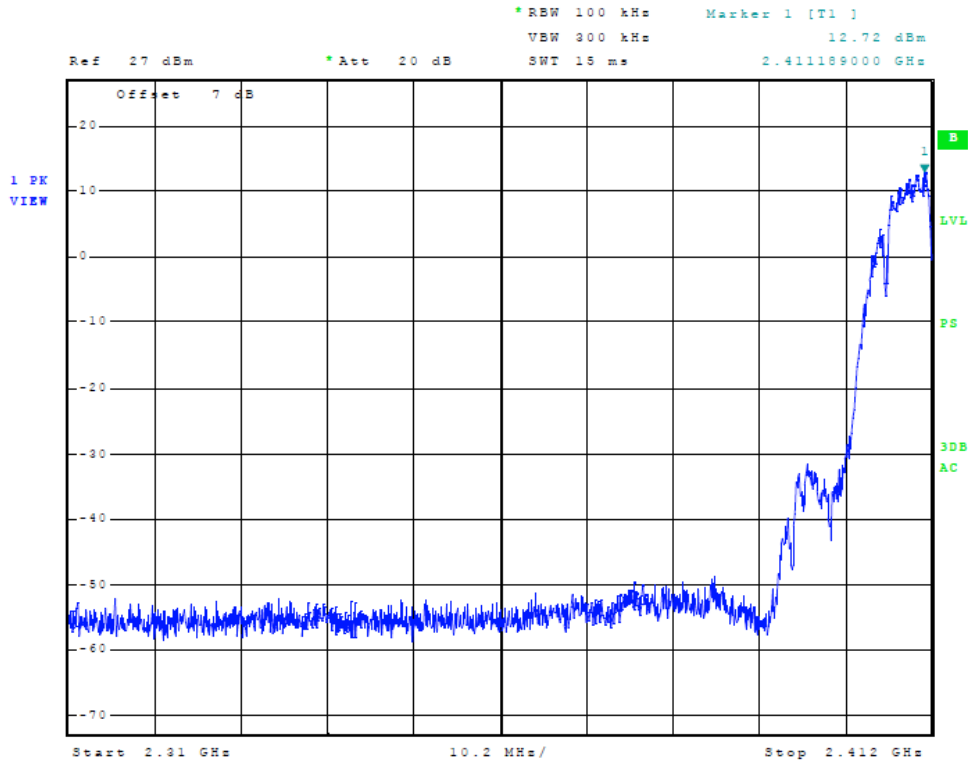

Figure 7 Plot of Transmitter Emissions Low Band Edge (802.11 b-mode)

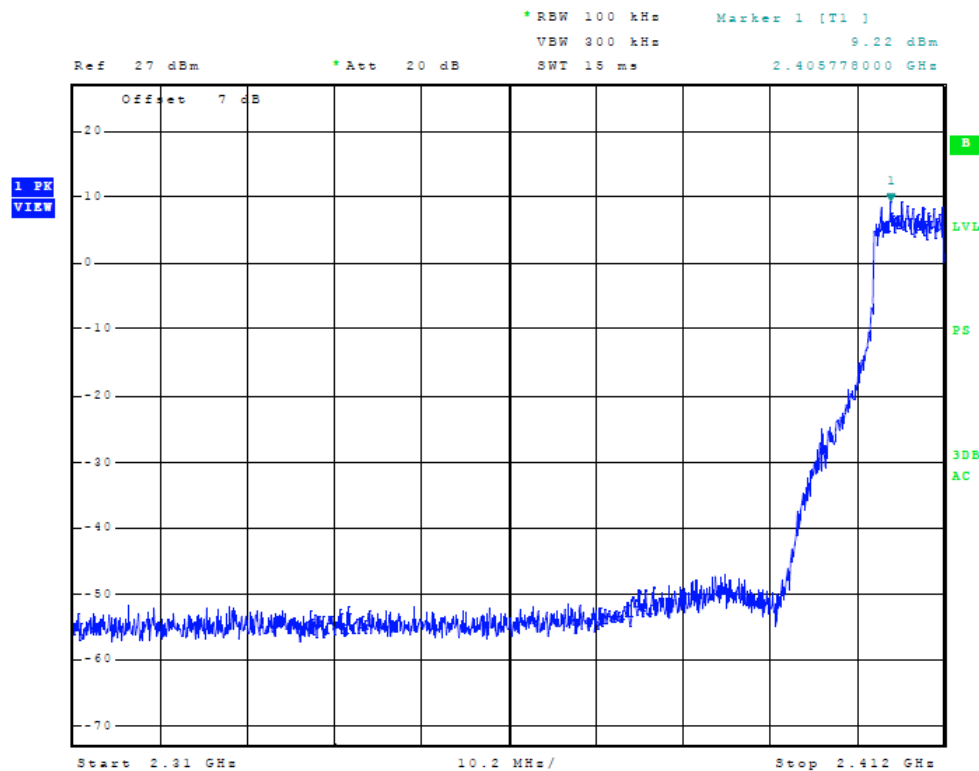

Figure 8 Plot of Transmitter Low Band Edge (802.11 g-mode)

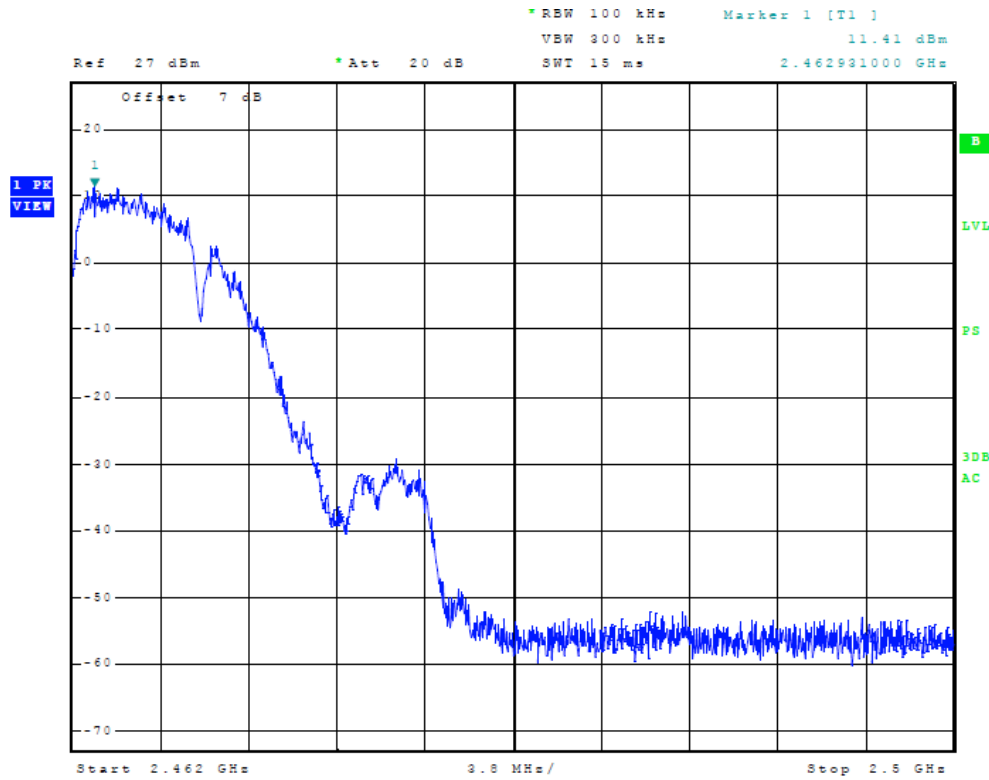

Figure 9 Plot of Transmitter High Band Edge (802.11 b-mode)

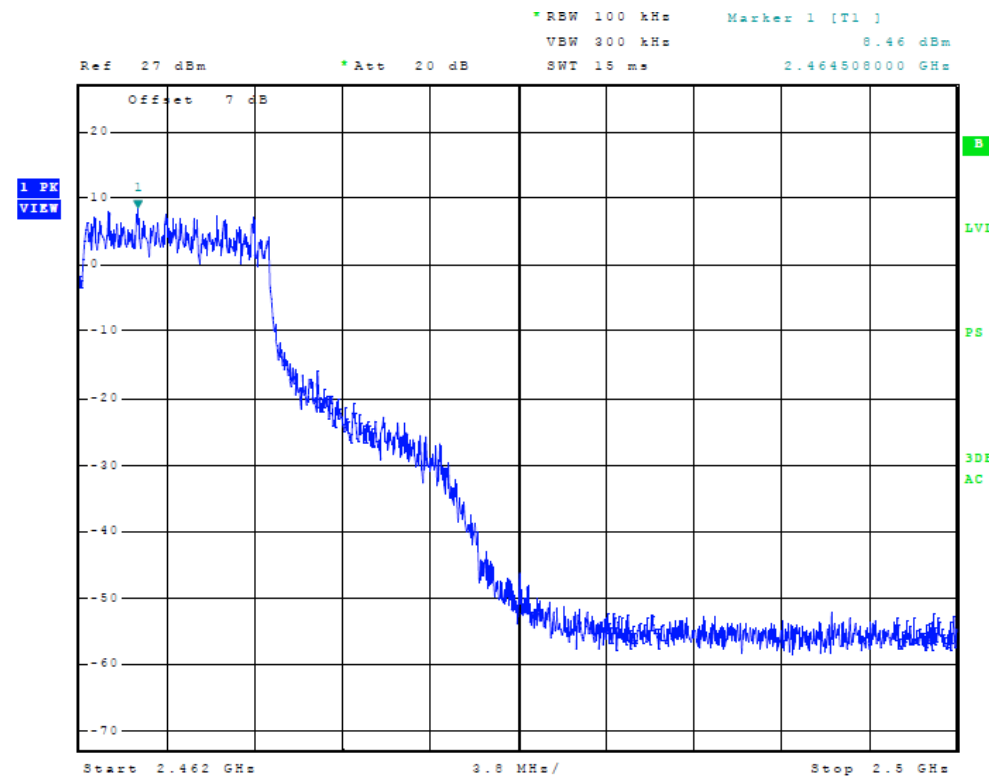

Figure 10 Plot of Transmitter High Band Edge (802.11 g-mode)

Transmitter Emissions Data

Table 5 Transmitter Radiated Emission (worst-case)

Frequency in MHz	Horizontal Peak (dBµV/m)	Horizontal Average (dBµV/m)	Vertical Peak (dBµV/m)	Vertical Average (dBµV/m)	Limit @ 3m (dBµV/m)
2412.0	--	--	--	--	--
4824.0	59.4	44.4	59.4	43.2	54.0
7236.0	48.3	32.4	45.1	32.1	54.0
9648.0	46.9	33.5	48.3	31.7	54.0
12060.0	49.3	33.6	46.9	31.4	54.0
14472.0	46.5	40.3	46.0	38.0	54.0
16884.0	48.5	39.9	47.7	39.9	54.0
2437.0	--	--	--	--	--
4874.0	59.2	46.1	56.6	45.6	54.0
7311.0	42.4	31.6	41.8	32.1	54.0
9748.0	43.1	32.9	41.4	35.6	54.0
12185.0	43.1	33.6	41.6	33.1	54.0
14622.0	49.0	38.0	47.8	38.0	54.0
17059.0	50.1	39.9	51.2	40.6	54.0
2462.0	--	--	--	--	--
4924.0	58.9	43.9	50.2	42.7	54.0
7386.0	42.4	33.4	43.9	34.1	54.0
9848.0	42.4	32.1	48.1	32.6	54.0
12310.0	44.3	33.3	50.3	33.3	54.0
14772.0	48.3	40.3	49.4	40.2	54.0
17234.0	51.9	41.4	50.4	41.4	54.0

Other emissions present had amplitudes at least 20 dB below the limit. Peak and Quasi-Peak amplitude emissions are recorded for frequency below 1000 MHz. Peak and Average amplitude emissions are recorded for frequency range above 1000 MHz.

Table 6 Transmitter Power and Operational Characteristics

Frequency MHz	Conducted Antenna Port Output Power (dBm / watts)	6-dB Occupied Bandwidth (kHz)	Power Spectral Density (dBm)
802.11 B-Mode			
2412	26.29 / 0.4	10,560	-1.38
2437	26.55 / 0.5	10,700	1.77
2462	25.44 / 0.4	10,580	-1.90
802.11 G-Mode			
2412	28.95 / 0.8	16,660	-4.98
2437	29.84 / 1.0	16,660	-4.56
2462	28.28 / 0.7	16,660	-4.54

Summary of Results for Transmitter Radiated Emissions of Intentional Radiator

The EUT demonstrated compliance with the radiated emissions requirements of CFR47 Part 15.247 and RSS-210 Digital Transmission Systems. Measured Peak conducted power of 29.84 dBm, 1.0 Watts for operations in 2412-2462 MHz band. The peak power spectral density presented a minimum margin of -6.2 dB below the requirements. The EUT demonstrated a minimum margin of -7.9 dB below the harmonic emissions requirements. There were no other significantly measurable emissions in the restricted bands other than those recorded in this report. Other emissions were present with amplitudes at least 20 dB below the requirements. There were no other deviations or exceptions to the requirements.

Statement of Modifications and Deviations

No modifications to the EUT were required for the unit to demonstrate compliance with the CFR47 Part 15C and RSS-210 emission requirements. There were no deviations to the specifications.



NVLAP Lab Code 200087-0

Annex

- Annex A Measurement Uncertainty Calculations
- Annex B Rogers Labs Test Equipment List
- Annex C Rogers Qualifications
- Annex D FCC Site Registration Letter
- Annex E Industry Canada Site Registration Letter

**Annex A Measurement Uncertainty Calculations**

Measurement uncertainty calculations were made for the laboratory. Result of measurement uncertainty calculations are recorded below for AC line conducted and radiated emission measurements.

Measurement Uncertainty	$U_{(E)}$	$U_{(lab)}$
3 Meter Horizontal 30-200 MHz Measurements	2.08	4.16
3 Meter Vertical 30-200 MHz Measurements	2.16	4.33
3 Meter Vertical Measurements 200-1000 MHz	2.99	5.97
10 Meter Horizontal Measurements 30-200 MHz	2.07	4.15
10 Meter Vertical Measurements 30-200 MHz	2.06	4.13
10 Meter Horizontal Measurements 200-1000 MHz	2.32	4.64
10 Meter Vertical Measurements 200-1000 MHz	2.33	4.66
3 Meter Measurements 1-6 GHz	2.57	5.14
3 Meter Measurements 6-18 GHz	2.58	5.16
AC Line Conducted	1.72	3.43



Annex B Rogers Labs Test Equipment List

<u>Equipment (Serial Number)</u>	<u>Calibration Date</u>
Spectrum Analyzer: Rohde & Schwarz ESU40 (100108)	5/14
Spectrum Analyzer: HP 8562A, 11518, 11519, and 11520 (3051A05950)	5/14
Mixers: 11517A, 11970A, 11970K, 11970U, 11970V, 11970W	
Spectrum Analyzer: HP 8591EM (3628A00871)	5/14
Antenna: EMCO Biconilog Model: 3143 (9607-1277)	5/14
Antenna: Sunol Biconilog Model: JB6 (A100709)	10/13
Antenna: EMCO Log Periodic Model: 3147 (40582)	10/13
Antenna: Com Power Model: AH-118 (10110)	10/13
Antenna: Com Power Model: AH-840 (101046)	10/13
Antenna: Antenna Research Biconical Model: BCD 235 (169)	10/13
Antenna: EMCO 6509 (9502-1374)	10/13
LISN: Compliance Design Model: FCC-LISN-2.Mod.cd (126)	10/13
R.F. Preamp Com-Power Model: CPPA-102 (01254)	10/13
Cable: Belden RG-58 (L1-CAT3-11590)	10/13
Cable: Belden RG-58 (L2-CAT3-11590)	10/13
Cable: Belden 8268 (L3)	10/13
Cable: Time Microwave: 4M-750HF290-750 (L4M)	10/13
Cable: Time Microwave: 10M-750HF290-750 (L10M)	10/13
Frequency Counter: Leader LDC825	2/14
Oscilloscope Scope: Tektronix 2230	2/14
Wattmeter: Bird 43 with Load Bird 8085	2/14
Power Supplies: Sorensen SRL 20-25, SRL 40-25, DCR 150, DCR 140	2/14
R.F. Generators: HP 606A, HP 8614A, HP 8640B	2/14
R.F. Power Amp 65W Model: 470-A-1010	2/14
R.F. Power Amp 50W M185- 10-501	2/14
R.F. Power Amp A.R. Model: 10W 1010M7	2/14
R.F. Power Amp EIN Model: A301	2/14
LISN: Compliance Eng. Model 240/20	2/14
LISN: Fischer Custom Communications Model: FCC-LISN-50-16-2-08	2/14
Antenna: EMCO Dipole Set 3121C	2/14
Antenna: C.D. B-101	2/14
Antenna: Solar 9229-1 & 9230-1	2/14
Audio Oscillator: H.P. 201CD	2/14
ELGAR Model: 1751	2/14
ELGAR Model: TG 704A-3D	2/14
ESD Test Set 2010i	2/14
Fast Transient Burst Generator Model: EFT/B-101	2/14
Field Intensity Meter: EFM-018	2/14
KEYTEK Ecat Surge Generator	2/14



Annex C Rogers Qualifications

Scot D. Rogers, Engineer

Rogers Labs, Inc.

Mr. Rogers has approximately 17 years' experience in the field of electronics. Engineering experience includes six years in the automated controls industry and remaining years working with the design, development and testing of radio communications and electronic equipment.

Positions Held

Systems Engineer: A/C Controls Mfg. Co., Inc. 6 Years

Electrical Engineer: Rogers Consulting Labs, Inc. 5 Years

Electrical Engineer: Rogers Labs, Inc. Current

Educational Background

- 1) Bachelor of Science Degree in Electrical Engineering from Kansas State University.
- 2) Bachelor of Science Degree in Business Administration Kansas State University.
- 3) Several Specialized Training courses and seminars pertaining to Microprocessors and Software programming.

Scot D. Rogers



NVLAP Lab Code 200087-0

Annex D FCC Site Registration Letter

FEDERAL COMMUNICATIONS COMMISSION

**Laboratory Division
7435 Oakland Mills Road
Columbia, MD 21046**

June 28, 2013

Registration Number: 90910

Rogers Labs, Inc.
4405 West 259th Terrace,
Louisburg, KS 66053

Attention: Scot Rogers,

Re: Measurement facility located at Louisburg
3 & 10 meter site
Date of Renewal: June 28, 2013

Dear Sir or Madam:

Your request for renewal of the registration of the subject measurement facility has been received. The information submitted has been placed in your file and the registration has been renewed. The name of your organization will remain on the list of facilities whose measurement data will be accepted in conjunction with applications for Certification under Parts 15 or 18 of the Commission's Rules. Please note that the file must be updated for any changes made to the facility and the registration must be renewed at least every three years.

Measurement facilities that have indicated that they are available to the public to perform measurement services on a fee basis may be found on the FCC website www.fcc.gov under E-Filing, OET Equipment Authorization Electronic Filing, Test Firms.

Sincerely,

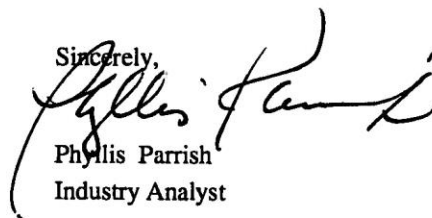

Phyllis Parrish
Industry Analyst

Rogers Labs, Inc.
4405 W. 259th Terrace
Louisburg, KS 66053
Phone/Fax: (913) 837-3214
Revision 1

Laird Technologies
Model: RMB024
Test #: 140728
Test to: CFR47 (15.247), RSS-210 (DTS)
File: Laird RMB024 TstRpt 140728

SN: PP7
FCC ID#: SQG-RMB024
IC: 3147A-RMB024
Date: August 6, 2014
Page 31 of 32



NVLAP Lab Code 200087-0

Annex E Industry Canada Site Registration Letter

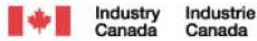

June 19, 2013

OUR FILE: 46405-3041

Submission No: 168037

Rogers Labs Inc.
4405 West 259th Terrace
Louisburg
KS, USA
66053

Attention: Mr. Scot D. Rogers

Dear Sir:

The Bureau has received your application for the renewal of 3/10m OATS. Be advised that the information received was satisfactory to Industry Canada. The following number(s) is now associated to the site(s) for which registration / renewal was sought (**Site# 3041A-1**). Please reference the appropriate site number in the body of test reports containing measurements performed on the site. In addition, please keep for your records the following information;

- The company address code associated to the site(s) located at the above address is: **3041A**

Furthermore, to obtain or renew a unique site number, the applicant shall demonstrate that the site has been accredited to ANSI C63.4-2003 or later. A scope of accreditation indicating the accreditation by a recognized accreditation body to ANSI C63.4-2003 or later shall be accepted. Please indicate in a letter the previous assigned site number if applicable and the type of site (example: 3 metre OATS or 3 metre chamber). If the test facility is not accredited to ANSI C63.4-2003 or later, the test facility shall submit test data demonstrating full compliance with the ANSI standard. The Bureau will evaluate the filing to determine if recognition shall be granted.

The frequency for re-validation of the test site and the information that is required to be filed or retained by the testing party shall comply with the requirements established by the accrediting organization. However, in all cases, test site re-validation shall occur on an interval not to **exceed three years**. There is no fee or form associated with an OATS filing. OATS submissions are encouraged to be submitted electronically to the Bureau using the following URL;

http://strategis.ic.gc.ca/epic/internet/inceb-bhst.nsf/en/h_tt00052e.html.

If you have any questions, you may contact the Bureau by e-mail at certification.bureau@ic.gc.ca Please reference our file and submission number above for all correspondence.

Yours sincerely,

Bill Payn
For: Wireless Laboratory Manager
Certification and Engineering Bureau
3701 Carling Ave., Building 94
P.O. Box 11490, Station "H"
Ottawa, Ontario K2H 8S2
Email: Bill.Payn@ic.gc.ca
Tel. No. (613) 990-3639
Fax. No. (613) 990-4752

Rogers Labs, Inc.
4405 W. 259th Terrace
Louisburg, KS 66053
Phone/Fax: (913) 837-3214
Revision 1

Laird Technologies
Model: RMB024
Test #: 140728
Test to: CFR47 (15.247), RSS-210 (DTS)
File: Laird RMB024 TstRpt 140728

SN: PP7
FCC ID#: SQG-RMB024
IC: 3147A-RMB024
Date: August 6, 2014
Page 32 of 32