



RADIO REPORT FCC 47 CFR Part 15C ISED Canada RSS-247 Digital transmission systems operating within the 2400 – 2483.5 MHz band	
Report Reference No	G0M-2002-8805-TFC247WF-V02
Testing Laboratory	Eurofins Product Service GmbH
Address	Storkower Str. 38c 15526 Reichenwalde Germany
Accreditation	 <p>DAkkS - Registration number : D-PL-12092-01-03 (ISED) ISED Testing Laboratory site: 3470A-2 DAkkS - Registration number : D-PL-12092-01-04 (FCC) FCC Filed Test Laboratory, Reg.-No.: 96970</p>
Applicant	Laird Connectivity Inc
Address	50 South Main Street 44308 Akron, OH United States of America
Test Specification	47 CFR Part 15C RSS-247, Issue 2, 2017-02 RSS-Gen, Issue 5, Amendment 1, 2019-03
Non-Standard Test Method	None
Equipment under Test (EUT):	
Product Description	915MHz LoRaWAN Gateway incl Wi-Fi, Ethernet & LTE - Indoor and IP67 variants
Model(s)	RG191+LTE Series
Additional Model(s)	None
Brand Name(s)	Laird Connectivity
Hardware Version(s)	v750.03.224
Software Version(s)	v93.9.5.1
FCC-ID	SQG-RG191NALTE
IC	3147A-RG191NALTE
Test Result	PASSED

Possible test case verdicts:		
Required by standard but not tested	N/T	
Not required by standard	N/R	
Not applicable to EUT	N/A	
Test object does meet the requirement	P(PASS)	
Test object does not meet the requirement	F(FAIL)	
Testing:		
Test Lab Temperature	20 - 23 °C	
Test Lab Humidity	32 – 38 %	
Date of receipt of test item	2020-06-18 (sample ID 29796) 2020-08-12 (sample ID 30742)	
Report:		
Compiled by	Toralf Jahn	
Tested by (+ signature) (Responsible for Test)	Toralf Jahn	
Approved by (+ signature) (Head of Lab)	Christian Weber	
Date of Issue	2020-09-29	
Total number of pages	63	
General Remarks:		
<p>The test results presented in this report relate only to the object tested.</p> <p>The results contained in this report reflect the results for this particular model and serial number. It is the responsibility of the manufacturer to ensure that all production models meet the intent of the requirements detailed within this report.</p> <p>This report shall not be reproduced, except in full, without the written approval of the Issuing testing laboratory.</p>		
Additional Comments:		

VERSION HISTORY

Version History			
Version	Issue Date	Remarks	Revised By
01	2020-09-03	Initial Release	
02	2020-09-29	Replaced document: G0M-2002-8805-TFC247WF-V01 Replaced by: G0M-2002-8805-TFC247WF-V02 Reason: Page 28 consecutive: channel frequency corrected	T.Jahn

ABBREVIATIONS AND ACRONYMS

Acronyms	
Acronym	Description
BPSK	Binary Phase Shift Keying
DSSS	Direct Sequence Spread Spectrum
EUT	Equipment Under Test
FCC	Federal Communications Commission
HT	High Throughput
IEEE 802.11	MAC and PHY Layer for WiFi
ISED	Innovation, Science and Economic Development Canada
OFDM	Orthogonal Frequency Division Multiplexing
QAM	Quadrature Amplitude Modulation
QPSK	Quadrature Phase Shift Keying
RBW	Resolution bandwidth
RMS	Root mean square
VBW	Video bandwidth
V _{NOM}	Nominal supply voltage

REPORT INDEX

1	Equipment (Test Item) Under Test.....	6
1.1	Photos – Equipment External.....	7
1.2	Photos – Equipment Internal.....	13
1.3	Photos – Test Setup.....	16
1.4	Support Equipment.....	18
1.5	Test Modes.....	19
1.6	Test Frequencies.....	20
1.7	Sample emission level calculation.....	21
2	Result Summary.....	22
3	Test Conditions and Results.....	23
3.1	Test Conditions and Results - AC powerline conducted emissions.....	23
3.2	Test Conditions and Results - Transmitter radiated emissions.....	26
3.3	Test Conditions and Results - Receiver radiated emissions.....	29
ANNEX A	Transmitter spurious emissions.....	32
ANNEX B	Receiver spurious emissions.....	48

1 Equipment (Test Item) Under Test

Description	915MHz LoRaWAN Gateway incl Wi-Fi, Ethernet & LTE - Indoor and IP67 variants	
Model	RG191+LTE Series	
Additional Model(s)	None	
Brand Name(s)	Laird Connectivity	
Serial Number(s)	Sample ID 29796 and 30742	
Hardware Version(s)	v750.03.224	
Software Version(s)	v93.9.5.1	
PMN	RG191+LTE Series	
HVIN	RG191+LTE	
FVIN	v93.9.5.1	
HMN	N/A	
FCC-ID	SQG-RG191NALTE	
IC	3147A-RG191NALTE	
Equipment type	End Product	
Radio type	Transceiver	
Assigned frequency bands	2400 - 2483.5 MHz	
Radio technology	IEEE 802.11 b/g/n (HT20)	
Modulation	BPSK, QPSK, 16-QAM, 64-QAM	
Number of antenna ports	2	
Radio Module	Type	Wi-Fi
	Model	WB50NBT
	Manufacturer	Laird
	HW Version	1.0
	SW Version	3.5.4.20
	FCC-ID	SQG-WB50NBT
	IC	3147A-WB50NBT
Antenna	Type	external rod
	Model	MAF94051
	Manufacturer	Laird
	Gain	2.1 dBi
Supply Voltage	V _{NOM}	12 VDC
Operating Temperature	T _{NOM}	25 °C
AC/DC-Adaptor	Model	GST25U12-P1J
	Vendor	Meanwell
	Input	115 VAC
	Output	12 VDC
Manufacturer	Laird Connectivity Inc 50 South Main Street 44308 Akron, OH United States of America	

1.1 Photos – Equipment External

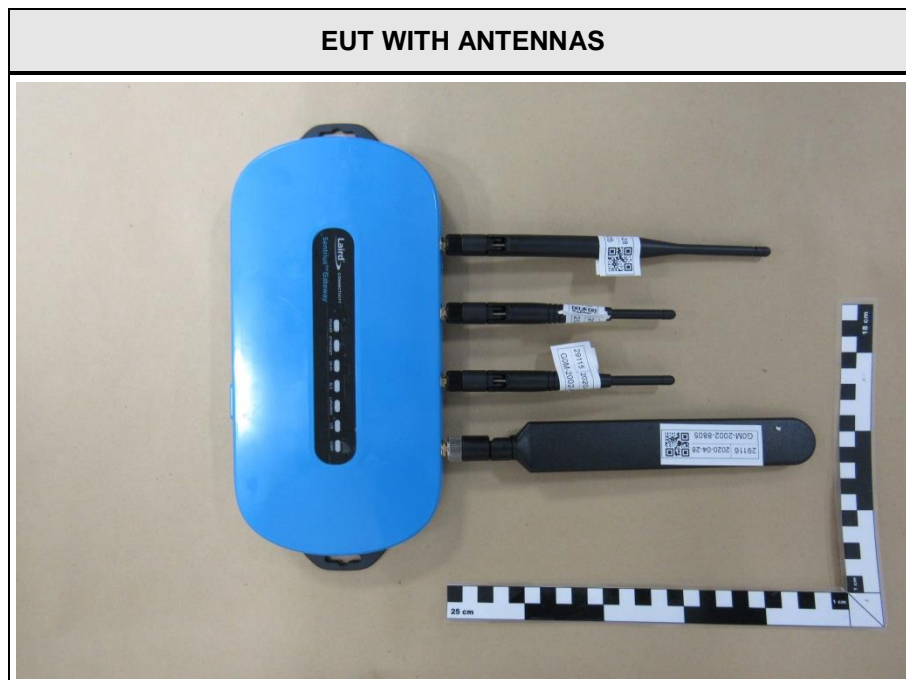



EUT ANTENNA CONNECTORS



EUT DC AND ETHERNET CONNECTOR

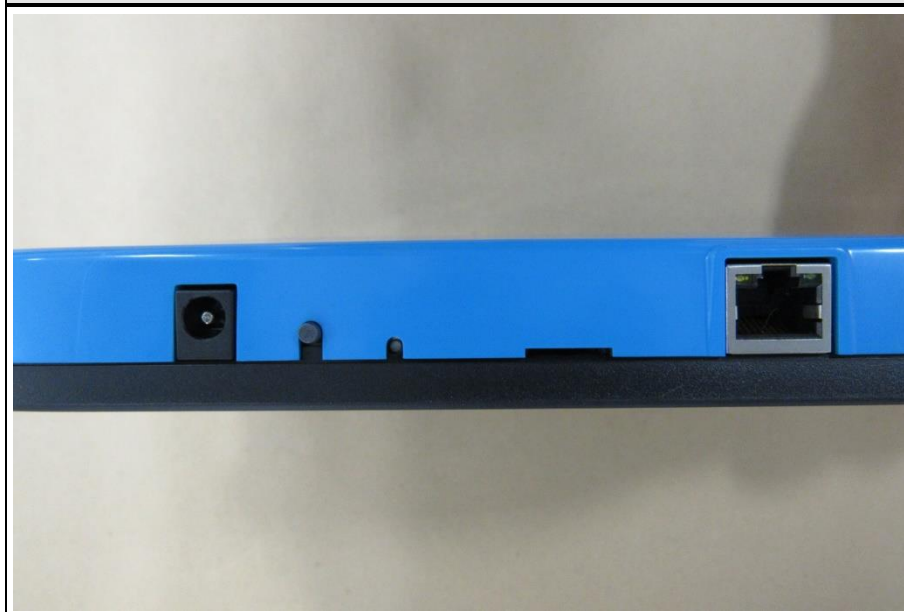

LTE ANTENNA



LoRa ANTENNA



WiFi ANTENNAS



AC/DC-ADAPTOR



1.2 Photos – Equipment Internal

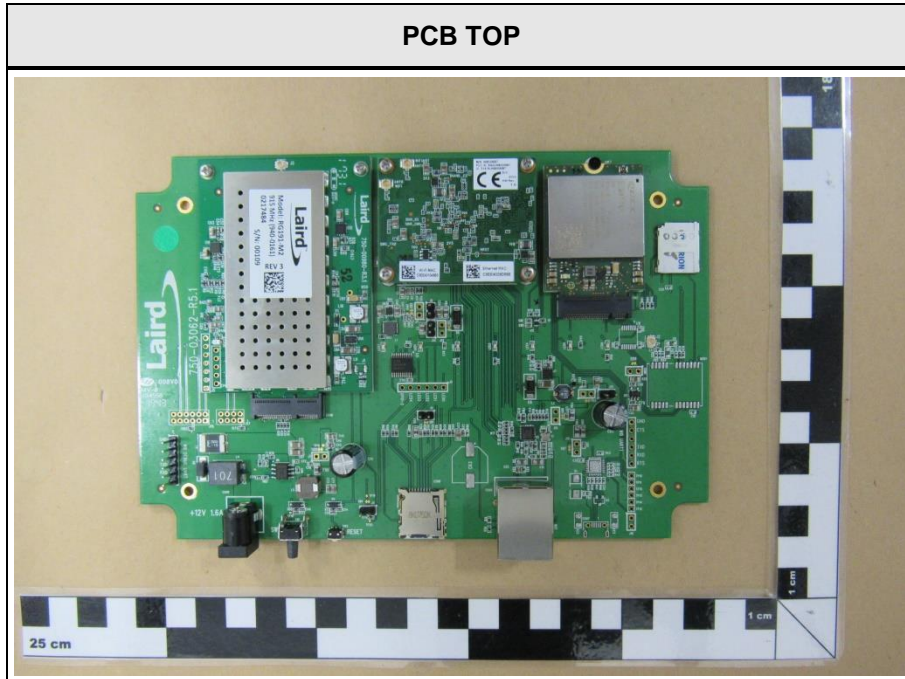

LTE AND WiFi

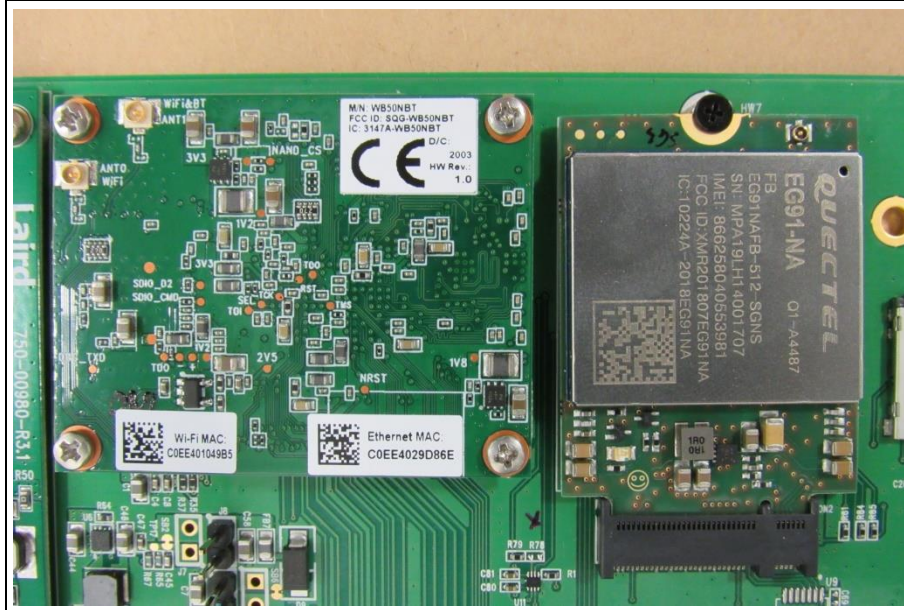

PCB BOTTOM

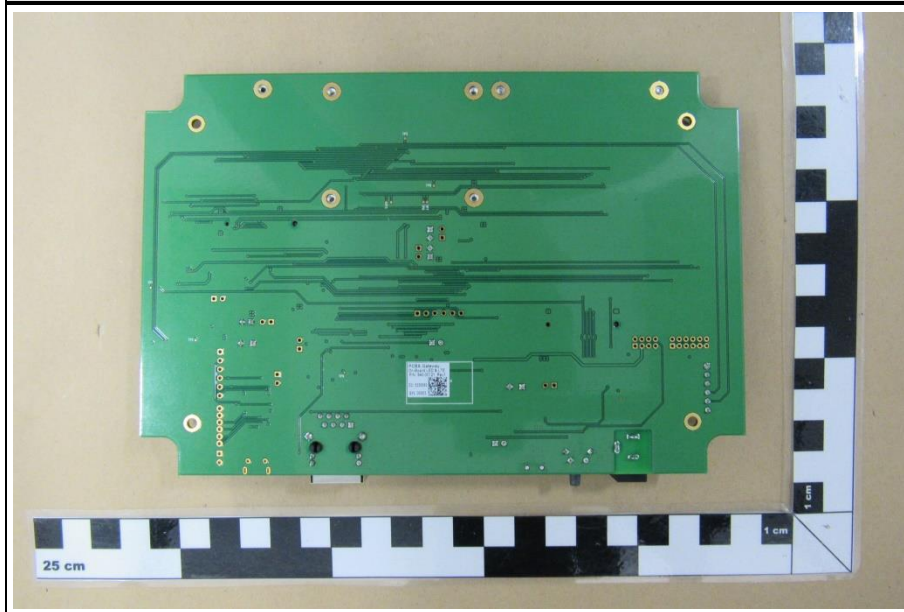

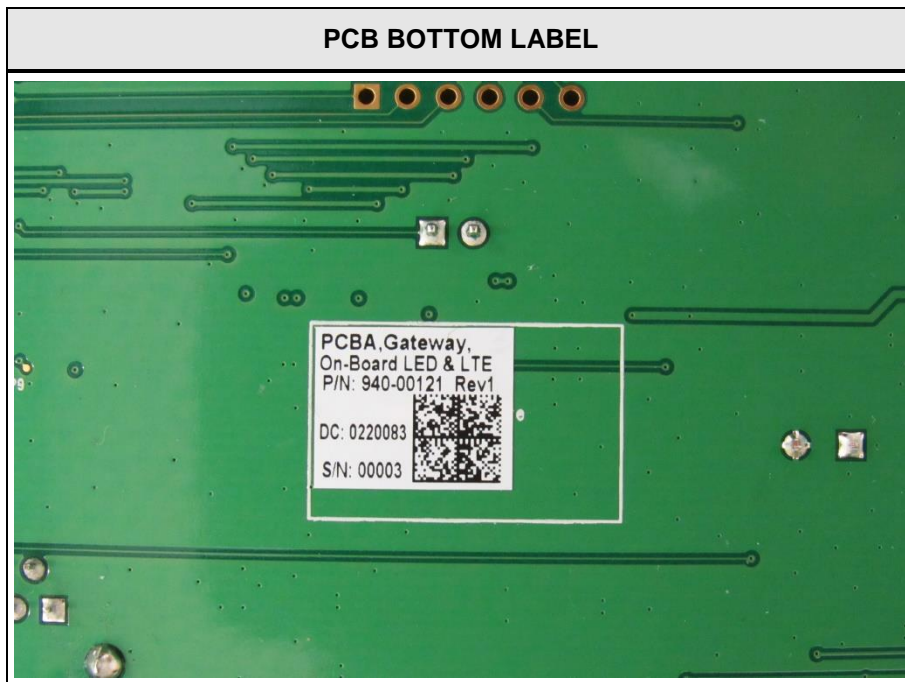

1.3 Photos – Test Setup

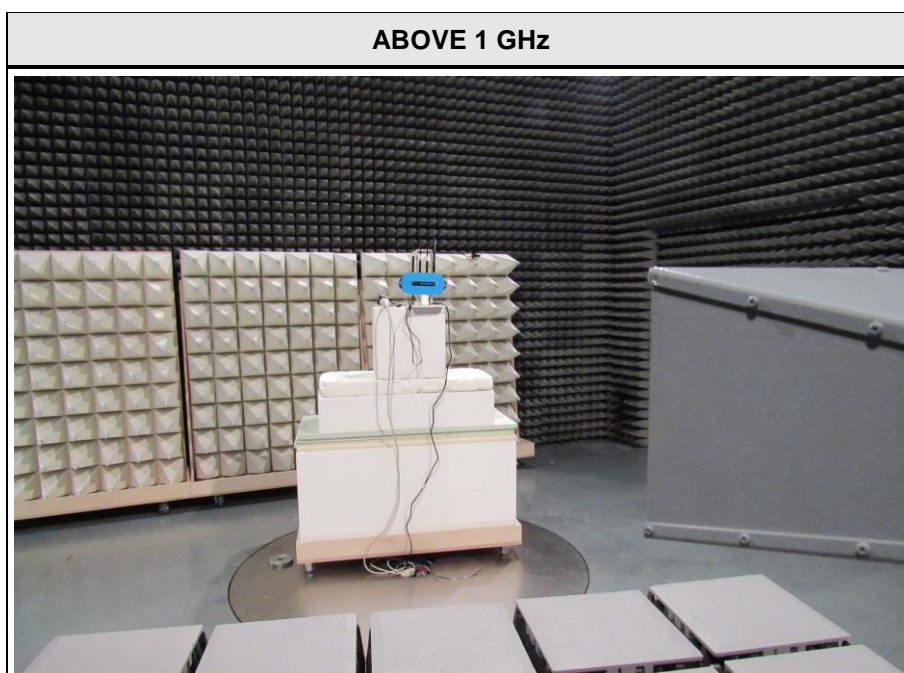
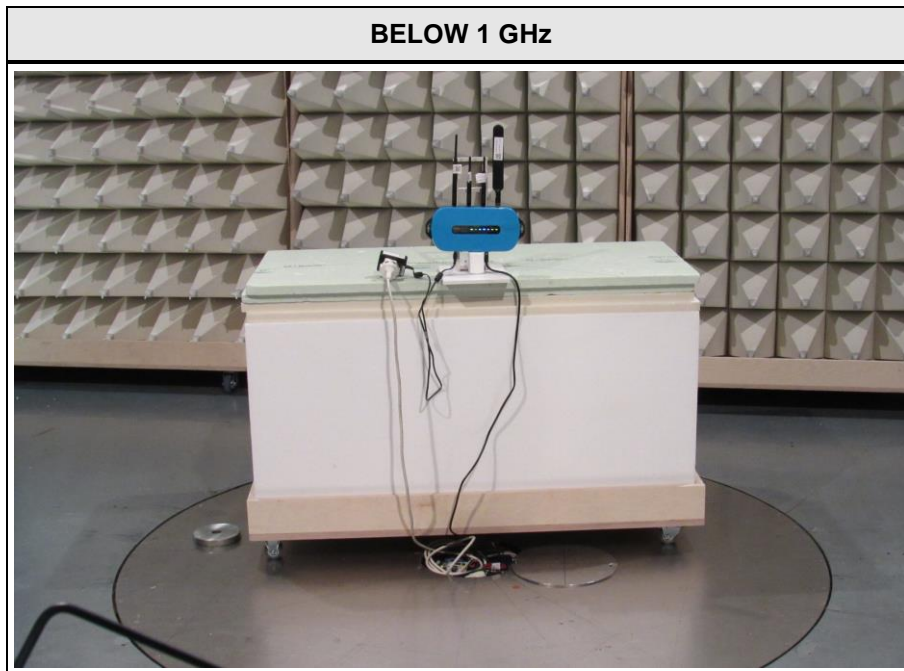

AC POWER LINE



1.4 Support Equipment

Product Type	Device	Manufacturer	Model	Comment
CBL	Ethernet Cable	Copartner	CAT 5.E	
AE	Ethernet Switch	Netgear	GS108	Termination of Ethernet Cable
Description:				
AE	Auxiliary Equipment			
SIM	Simulator			
CBL	Connecting Cable			
SFT	Software			
Comment:				

1.5 Test Modes

Mode	Description
OFDM (IEEE 802.11g)	Mode = Transmit diversity Modulation = BPSK Spreading = OFDM Bandwidth = 20 MHz Duty cycle = 98.11% Power setting = FCC table Data rate = 6 Mbps Chain 0 + 1
Receive	Mode = RX scan mode
Comment: The above settings were found as worst case in FCC module test report FR631002AC Rev. 02 of 2016-05-03 from International Certification Corp.. The end product does not support 40 MHz bandwidth.	

1.6 Test Frequencies

Designator	Mode	Channel	Frequency [MHz]
F1	Tx	6	2437
F2	Rx	1 - 11	2412 - 2462

1.7 Sample emission level calculation

The following is a description of terms and a sample calculation, as appears in the radiated emissions data table. The numbers used in the calculation are for example only. There is no direct correlation to the specific data taken for the product described in this document:

Reading:

This is the reading obtained on the spectrum analyzer in dB μ V. Any external preamplifiers used are taken into account through internal analyzer settings.

A.F.:

This is the antenna factor for the receiving antenna. It is a conversion factor, which converts electric fields strengths to voltages, which can be measured directly on the spectrum analyzer. It is treated as a loss in dB. Cable losses have been included with the A.F. to simplify the calculations. The antenna factor is used in calculations as follows:

$$\text{Reading on Analyzer (dB}\mu\text{V)} + \text{A.F. (dB/m)} = \text{Net field strength (dB}\mu\text{V/m)}$$

Net:

This is the net field strength measurement (as shown above).

Limit:

This is the FCC Class B radiated emission limit (in units of dB μ V/m). The FCC limits are given in units of μ V/m. The following formula is used to convert the units of μ V/m to dB μ V/m:

$$\text{Limit (dB}\mu\text{V/m)} = 20 \cdot \log(\mu\text{V/m})$$

Margin:

This is the margin of compliance below the FCC limit. The units are given in dB. A negative margin indicates the emission was below the limit. A positive margin indicates that the emission exceeds the limit.

Example only:

Reading + AF	=	Net Reading	:	Net reading - FCC limit	=	Margin
+21.5 dB μ V + 26 dB/m		= 47.5 dB μ V/m		47.5 dB μ V/m - 57.0 dB μ V/m		= -9.5 dB

2 Result Summary

FCC 47 CFR Part 15C, ISED RSS-247				
Product Standard Reference	Requirement	Reference Method	Result	Remarks
ISED RSS-Gen, Issue 5 (section 6.6)	Occupied Bandwidth	ANSI C63.10-2013	N/T	Informational only
FCC § 15.247(a)(2) ISED RSS-247, Issue 2 (section 5.2)	6 dB Bandwidth	ANSI C63.10-2013	N/T	
FCC § 15.247(b)(1) ISED RSS-247, Issue 2 (section 5.4)	Maximum peak conducted power	ANSI C63.10-2013	N/T	
FCC § 15.247(e) ISED RSS-247, Issue 2 (section 5.2)	Power spectral density	ANSI C63.10-2013	N/T	
FCC § 15.207 ISED RSS-247, Issue 2 (section 3.1)	AC power line conducted emissions	ANSI C63.10-2013	PASS	
FCC § 15.247(d) ISED RSS-247, Issue 2 (section 5.5)	Band edge compliance	ANSI C63.10-2013	N/T	
FCC § 15.247(d) ISED RSS-247, Issue 2 (section 5.5)	Conducted spurious emissions	ANSI C63.10-2013	N/T	
FCC § 15.247(d) FCC § 15.209 ISED RSS-Gen, Issue 5 (section 6.13)	Transmitter radiated spurious emissions	ANSI C63.10-2013	PASS	
ISED RSS-247, Issue 2 (section 3.1)	Receiver radiated spurious emissions	ANSI C63.10-2013	PASS	
Comment:				

Possible Test Case Verdicts	
PASS	Test object does meet the requirements
FAIL	Test object does not meet the requirements
N/T	Required by standard but not tested
N/R	Not required by standard for the test object

3 Test Conditions and Results

3.1 Test Conditions and Results - AC powerline conducted emissions

3.1.1 Information

Test Information	
Reference	FCC § 15.207; ISED RSS-247, Issue 2 (section 3.1)
Measurement Method	ANSI C63.10 6.2
Measurement Uncertainty	± 3.82 dB
Operator	Toralf Jahn
Date	2020-06-30

3.1.2 Limits

Limits		
Frequency [MHz]	Quasi-Peak [dB μ V]	Average [dB μ V]
0.15 - 0.5	66 - 56*	56 - 46*
0.5 - 5	56	46
5 - 30	60	50

* Limit decreases linearly with the logarithm of the frequency

3.1.3 Setup

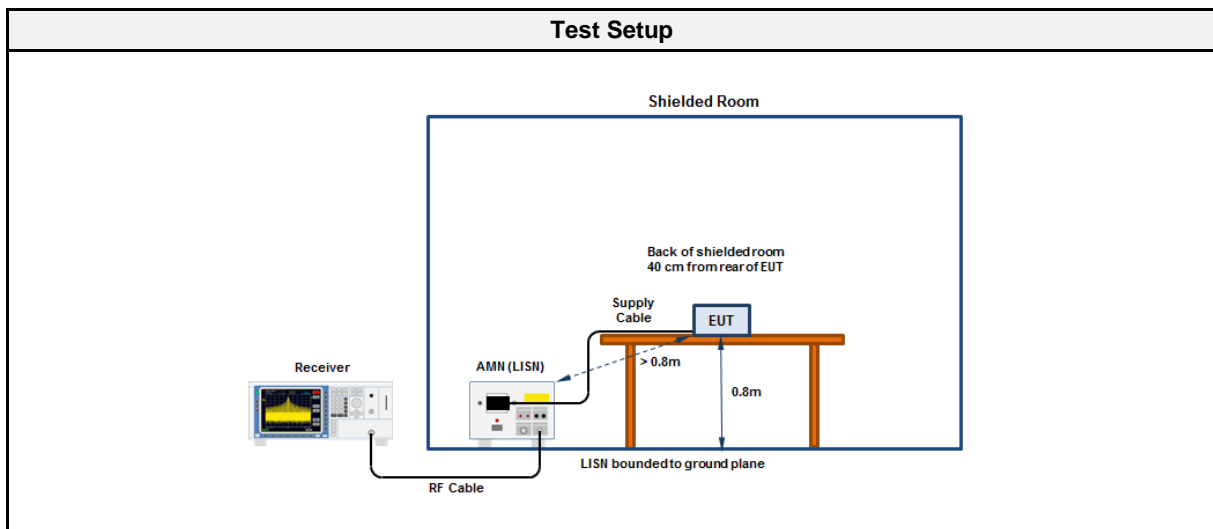

3.1.4 Equipment

Test Software			
Description	Manufacturer	Name	Version
EMC Software	DARE Instruments	RadiMation	2016.1.10

Test Equipment					
Description	Manufacturer	Model	Identifier	Cal. Date	Cal. Due
EMI Test Receiver	R&S	ESR7	EF00943	2020-07	2021-07
LISN	Schwarzbeck	NSLK 8127 RC	EF01592	2020-07	2021-07

Conducted emissions at the mains power port according to FCC part 15 C

Project Number: G0M-2002-8805
 Applicant: Laird Connectivity
 Model Description: 915MHz LoRaWAN Gateway incl Wi-Fi, Ethernet & LTE - Indoor and IP67 variants
 Model: RG191+LTE Series
 Test Sample ID: 29796
 Test Site: Eurofins Product Service Germany
 Operator: Mr. Jahn
 Test Date: 2020-06-30
 Operating Conditions: ambient temperature: 25°C
 power input: 12 VDC via AC/DC-Adaptor
 LISN: Schwarzbeck NSLK 8127 RC L
 Mode: Tx: 802.11g; 2437 MHz + LoRa 923.3 MHz + LTE FDD 2
 Applied to Port: AC mains
 Note 1: sample ID 29796

Index 40

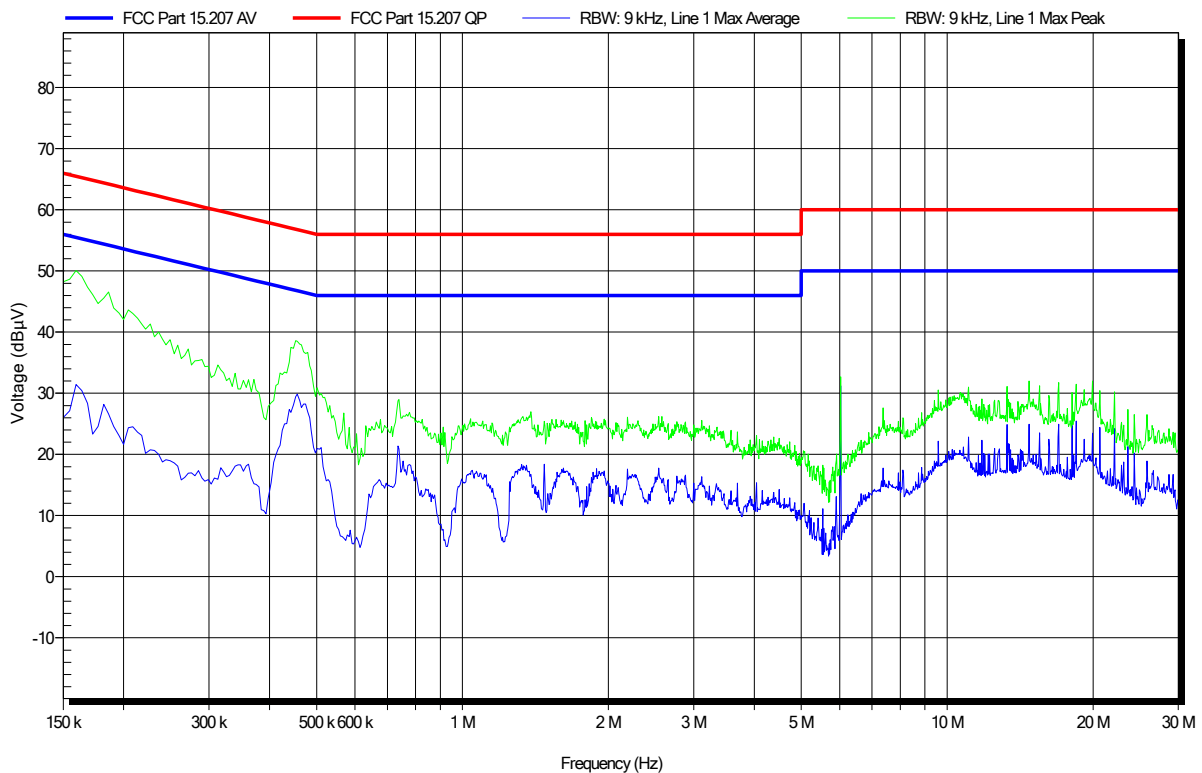

Conducted emissions at the mains power port according to FCC part 15 C

Project Number: G0M-2002-8805
 Applicant: Laird Connectivity
 Model Description: 915MHz LoRaWAN Gateway incl Wi-Fi, Ethernet & LTE - Indoor and IP67 variants
 Model: RG191+LTE Series
 Test Sample ID: 29796
 Test Site: Eurofins Product Service Germany
 Operator: Mr. Jahn
 Test Date: 2020-06-30
 Operating Conditions: ambient temperature: 25°C
 power input: 12 VDC via AC/DC-Adaptor
 LISN: Schwarzbeck NSLK 8127 RC N
 Mode: Tx: 802.11g; 2437 MHz + LoRa 923.3 MHz + LTE FDD 2
 Applied to Port: AC mains
 Note 1: sample ID 29796

Index 41

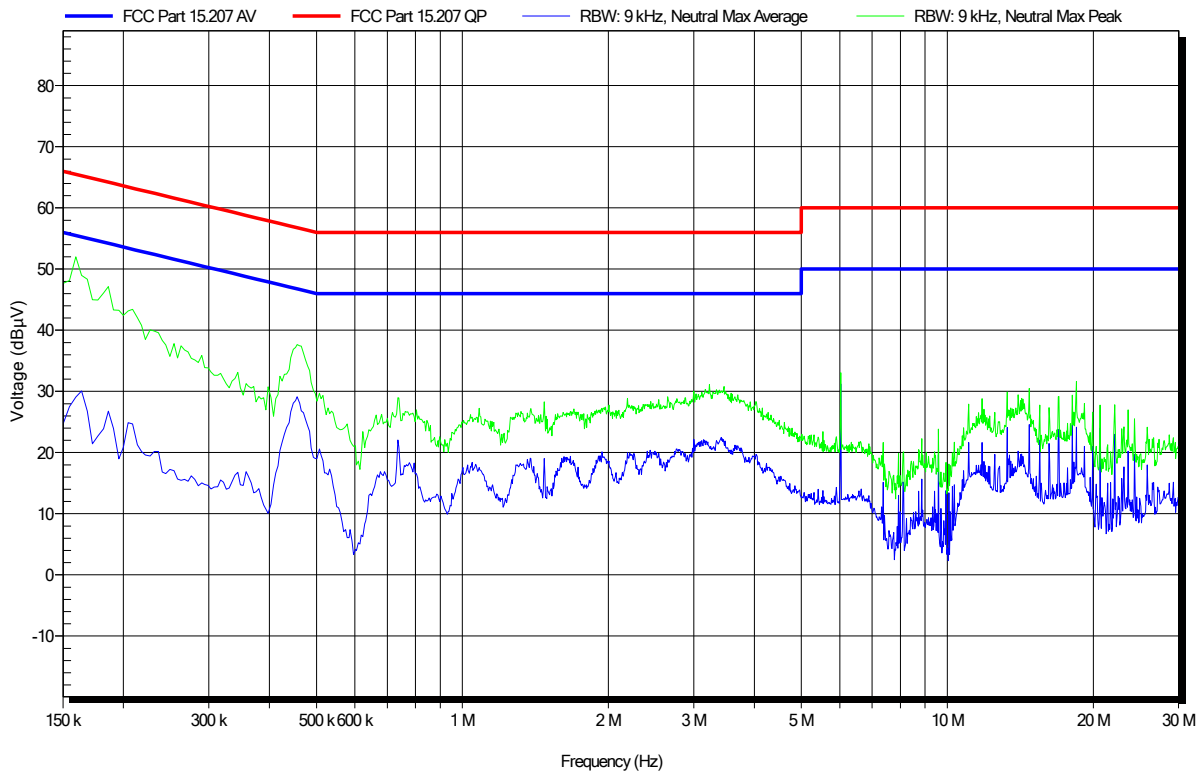

3.2 Test Conditions and Results - Transmitter radiated emissions

3.2.1 Information

Test Information	
Reference	FCC § 15.247(d); FCC § 15.209; ISED RSS-Gen, Issue 5 (section 6.13)
Measurement Method	ANSI C63.10 6.4, 6.5, 6.6, 11.12
Measurement Uncertainty	± 5.7 dB
Operator	Toralf Jahn
Date	2020-06-24 (sample ID 29796) + 2020-08-27 (sample ID 30742)

3.2.2 Limits

Limits			
Frequency [MHz]	Detector	Field strength [$\mu\text{V}/\text{m}$]	Measurement distance [m]
30 - 88	Quasi-Peak	100	3
88 - 216	Quasi-Peak	150	3
216 - 960	Quasi-Peak	200	3
960 - 1000	Quasi-Peak	500	3
>1000	Average	500	3

3.2.3 Setup

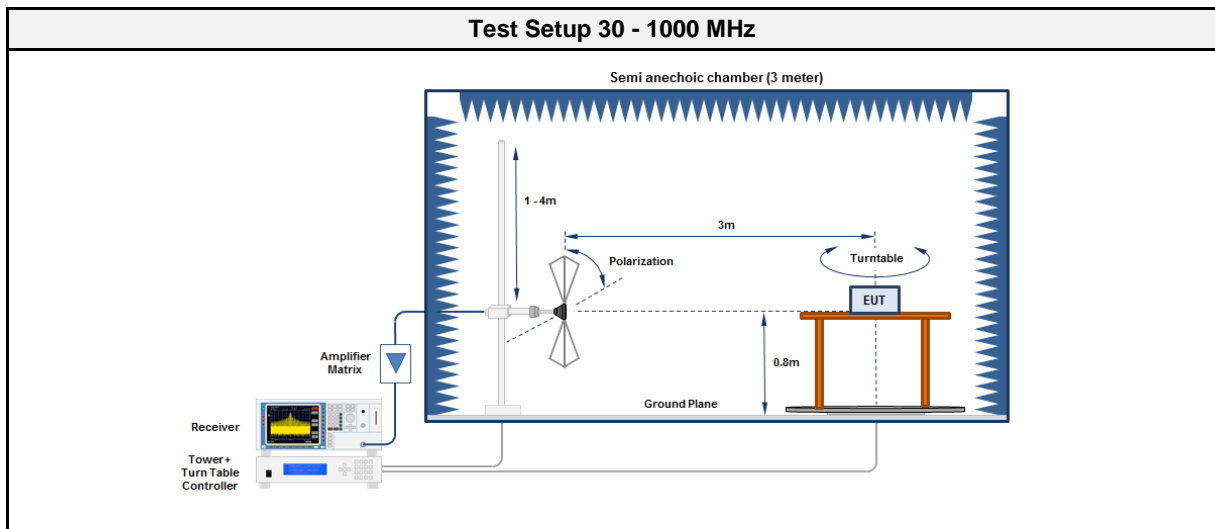

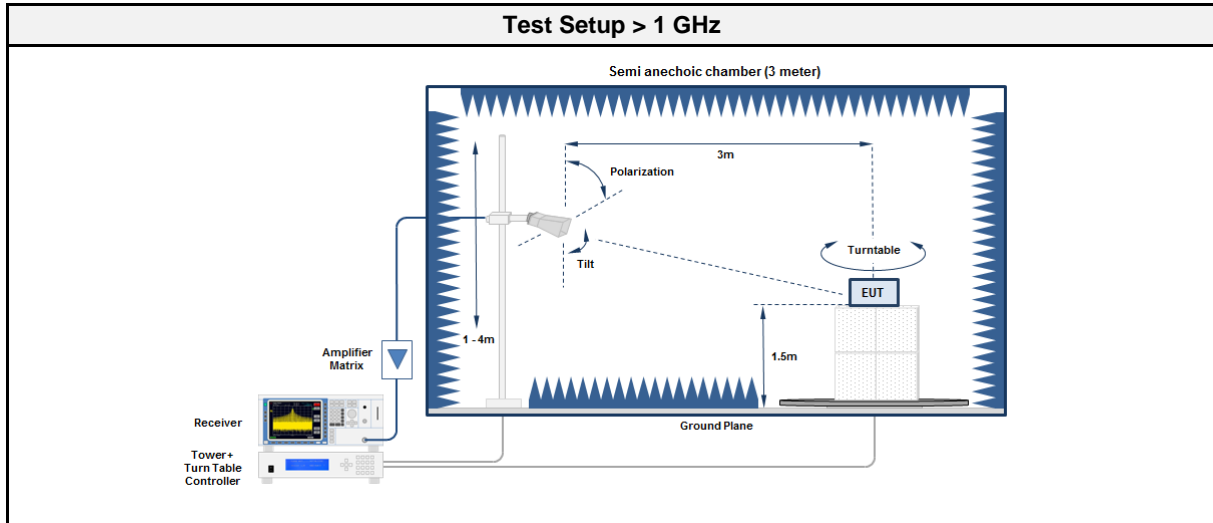

3.2.4 Equipment

Test Software			
Description	Manufacturer	Name	Version
EMC Software	DARE Instruments	RadiMation	2016.1.10
EMC Software	DARE Instruments	RadiMation	2020.1.8

Test Equipment 30 - 1000 MHz					
Description	Manufacturer	Model	Identifier	Cal. Date	Cal. Due
Anechoic Chamber	Frankonia	AC1	EF00062	2018-07	2021-07
Measurement Receiver	Agilent	N9038A-526/WXP	EF01070	2020-06	2021-06
Antenna	R&S	HK 116	EF00030	2019-04	2022-04
Antenna	R&S	HL 223	EF00187	2019-05	2022-05

Test Equipment > 1 GHz					
Description	Manufacturer	Model	Identifier	Cal. Date	Cal. Due
Anechoic Chamber	Frankonia	AC1	EF00062	2018-07	2021-07
Measurement Receiver	Agilent	N9038A-526/WXP	EF01070	2020-06	2021-06
Antenna	Schwarzbeck	BBHA 9120D	EF00018	2019-10	2022-10

3.2.5 Procedure

Test Procedure 30 - 1000 MHz
<ol style="list-style-type: none"> 1. EUT is placed on a non conducting support at the center of a turn table 0.8 m above the ground 2. EUT set to test mode 3. The receiver is set to peak detection with max hold 4. The EUT is rotated through 360° and the height of the antenna is varied from 1 m to 4 m 5. All significant emissions are measured again using the corresponding final detector

Test Procedure > 1 GHz

1. EUT is placed on a non conducting support at the center of a turn table 1.5 m above the ground
2. EUT set to test mode
3. The receiver is set to peak detection with max hold
4. The EUT is rotated through 360° and the height of the antenna is varied from 1 m to 4 m
5. All significant emissions are measured again using the corresponding final detector

3.2.6 Results

Test Results - OFDM

Channel [MHz]	Emission [MHz]	Level [dB μ V/m]	Det.	Pol.	Limit [dB μ V/m]	Margin [dB]
2437	264.0048	36.90	qpk	ver	46.00	-09.10
2437	1462.9	49.31	pk	ver	74.00	-24.69
2437	1462.9	47.96	RMS	ver	54.00	-06.04
2437	1463	48.77	pk	hor	74.00	-25.23
2437	1463	46.76	RMS	hor	54.00	-07.24
2437	2235.9	45.79	pk	hor	74.00	-28.21
2437	2235.9	40.19	RMS	hor	54.00	-13.81
2437	2288	51.39	pk	hor	74.00	-22.61
2437	2288	48.48	RMS	hor	54.00	-05.52
2437	2288	53.10	pk	ver	74.00	-20.90
2437	2288	50.55	RMS	ver	54.00	-03.45
2437	2313.9	50.18	pk	ver	74.00	-23.82
2437	2313.9	44.51	RMS	ver	54.00	-09.49
2437	2339.9	54.96	pk	ver	74.00	-19.04
2437	2339.9	47.44	RMS	ver	54.00	-06.56
2437	2340	49.96	pk	ver	74.00	-24.04
2437	2340	43.54	RMS	ver	54.00	-10.46
2437	2366	52.33	pk	ver	74.00	-21.67
2437	2366	45.95	RMS	ver	54.00	-08.05
2437	2389.9	56.74	pk	ver	74.00	-17.26
2437	2389.9	46.79	RMS	ver	54.00	-07.21
2437	2396.6	56.26	pk	hor	74.00	-17.74
2437	2396.9	62.29	pk	ver	74.00	-11.71
2437	2483.7	60.09	pk	ver	74.00	-13.91
2437	2483.7	49.65	RMS	ver	54.00	-04.35
2437	2491.4	58.81	pk	ver	74.00	-15.19
2437	2491.4	50.23	RMS	ver	54.00	-03.77
2437	2493.5	49.62	pk	hor	74.00	-24.38
2437	2493.5	39.97	RMS	hor	54.00	-14.03
2437	2496	57.76	pk	ver	74.00	-16.24
2437	2496	48.82	RMS	ver	54.00	-05.18
2437	12184	46.95	pk	hor	74.00	-27.05

3.3 Test Conditions and Results - Receiver radiated emissions

3.3.1 Information

Test Information	
Reference	ISED RSS-247, Issue 2 (section 3.1)
Measurement Method	ANSI C63.10 6.5, 6.6, 11.12
Measurement Uncertainty	± 5.7 dB
Operator	Toralf Jahn
Date	2020-06-25 (sample ID 29796) + 2020-08-27 (sample ID 30742)

3.3.2 Limits

Limits			
Frequency [MHz]	Detector	Field strength [$\mu\text{V}/\text{m}$]	Measurement distance [m]
30 - 88	Quasi-Peak	100	3
88 - 216	Quasi-Peak	150	3
216 - 960	Quasi-Peak	200	3
960 - 1000	Quasi-Peak	500	3
>1000	Average	500	3

3.3.3 Setup

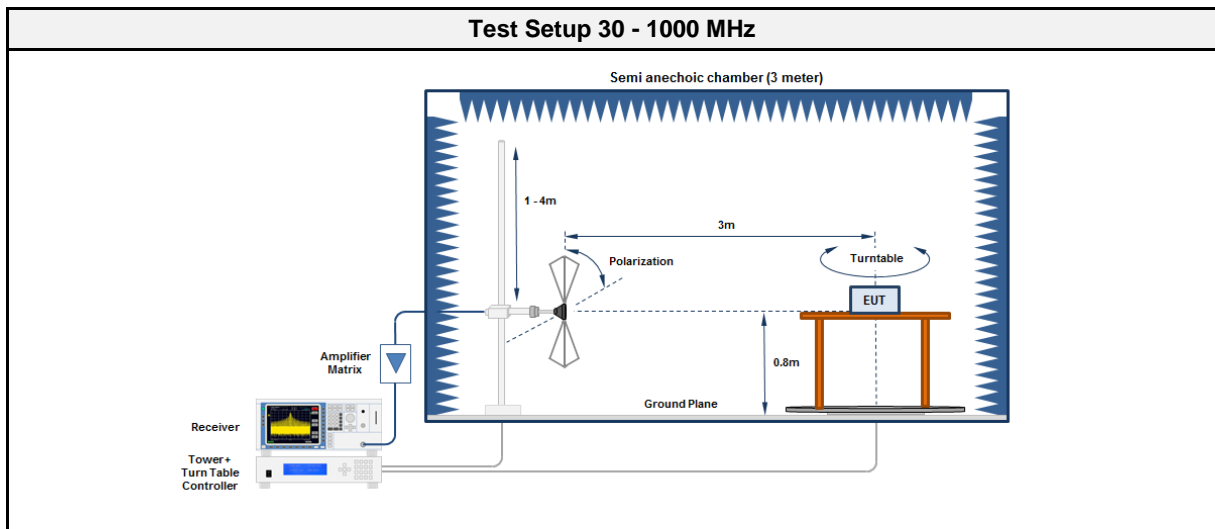

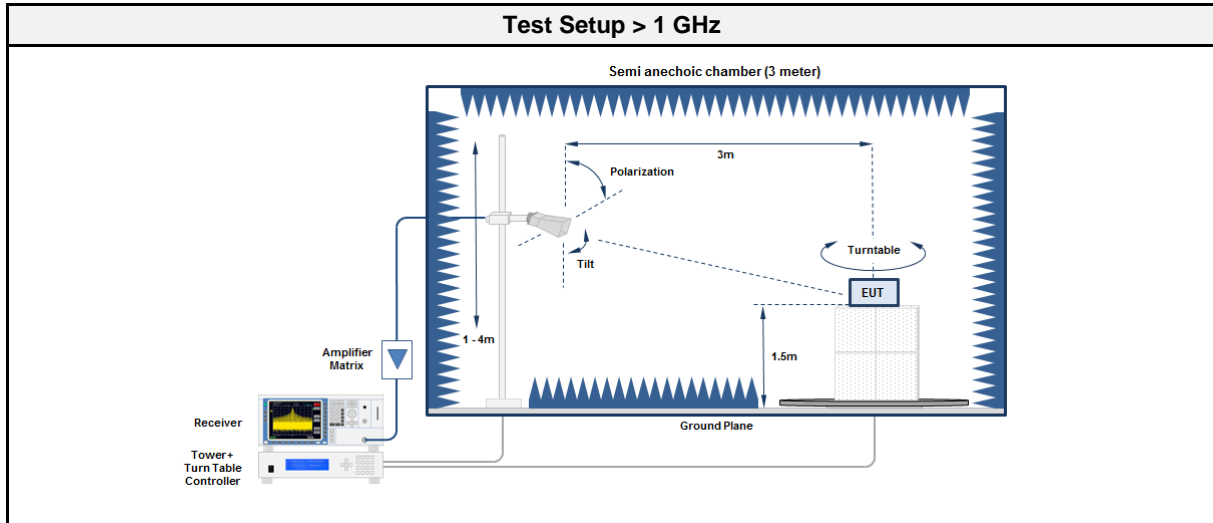

3.3.4 Equipment

Test Software			
Description	Manufacturer	Name	Version
EMC Software	DARE Instruments	RadiMation	2016.1.10
EMC Software	DARE Instruments	RadiMation	2020.1.8

Test Equipment 30 - 1000 MHz					
Description	Manufacturer	Model	Identifier	Cal. Date	Cal. Due
Anechoic Chamber	Frankonia	AC1	EF00062	2018-07	2021-07
Measurement Receiver	Agilent	N9038A-526/WXP	EF01070	2020-06	2021-06
Antenna	R&S	HK 116	EF00030	2019-04	2022-04
Antenna	R&S	HL 223	EF00187	2019-05	2022-05

Test Equipment > 1 GHz					
Description	Manufacturer	Model	Identifier	Cal. Date	Cal. Due
Anechoic Chamber	Frankonia	AC1	EF00062	2018-07	2021-07
Measurement Receiver	Agilent	N9038A-526/WXP	EF01070	2020-06	2021-06
Antenna	Schwarzbeck	BBHA 9120D	EF00018	2019-10	2022-10

3.3.5 Procedure

Test Procedure 30 - 1000 MHz
<ol style="list-style-type: none"> 1. EUT is placed on a non conducting support at the center of a turn table 0.8 m above the ground 2. EUT set to test mode 3. The receiver is set to peak detection with max hold 4. The EUT is rotated through 360° and the height of the antenna is varied from 1 m to 4 m 5. All significant emissions are measured again using the corresponding final detector

Test Procedure > 1 GHz
<ol style="list-style-type: none"> 1. EUT is placed on a non conducting support at the center of a turn table 1.5 m above the ground 2. EUT set to test mode 3. The receiver is set to peak detection with max hold 4. The EUT is rotated through 360° and the height of the antenna is varied from 1 m to 4 m 5. All significant emissions are measured again using the corresponding final detector

3.3.6 Results

Test Results						
Channel [MHz]	Emission [MHz]	Level [dBµV/m]	Det.	Pol.	Limit [dBµV/m]	Margin [dB]
2412 - 2462	209.0063	29.70	qpk	hor	43.50	-13.84
2412 - 2462	1463	45.80	avg	hor	53.98	-08.18
2412 - 2462	1463	46.06	avg	ver	53.98	-07.92
2412 - 2462	2660	48.89	avg	hor	53.98	-05.09
2412 - 2462	2926	47.43	avg	hor	53.98	-06.55
2412 - 2462	3192	41.56	avg	hor	53.98	-12.42

ANNEX A Transmitter spurious emissions

Spurious emissions according to FCC 15.247

Project number: G0M-2002-8805

Applicant: Laird Connectivity Inc
 EUT Name: 915MHz LoRaWAN Gateway incl Wi-Fi, Ethernet & LTE - Indoor and IP67 variants

Model: RG191+LTE Series
 Test Site: Eurofins Product Service Germany
 Operator: Mr. Jahn
 Measurement software: RadiMation, version 2020.0.12
 Test Conditions: Tnom: 23 °Celsius°C, Vnom: 12 VDC via AC/DC-Adaptor
 Antenna: Rohde & Schwarz HK 116, Horizontal
 Measurement distance: 3 m
 Mode: TX; 802.11g; 2437 MHz, Sample 30742
 Test Date: 2020-08-27
 Note:

Index 2

RadiMation

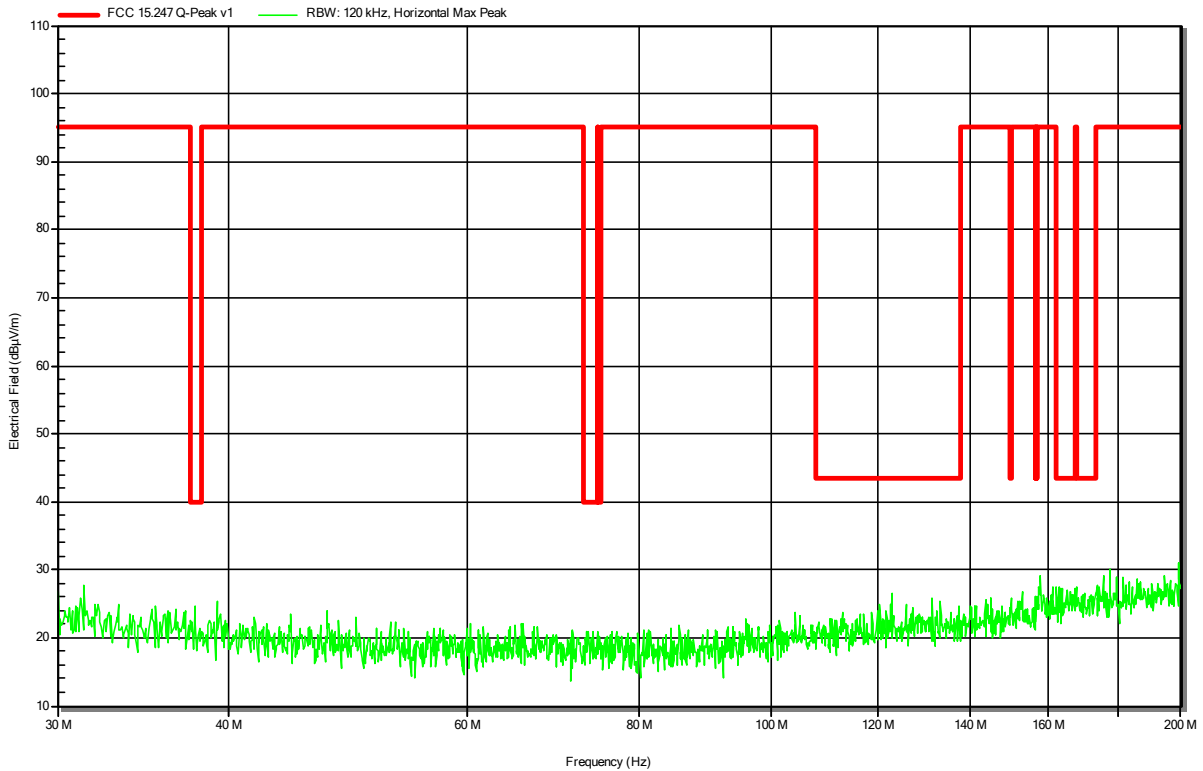

Spurious emissions according to FCC 15.247

Project number: G0M-2002-8805

Applicant: Laird Connectivity Inc
 EUT Name: 915MHz LoRaWAN Gateway incl Wi-Fi, Ethernet & LTE - Indoor and IP67 variants

Model: RG191+LTE Series
 Test Site: Eurofins Product Service Germany
 Operator: Mr. Jahn
 Measurement software: RadiMation, version 2020.0.12
 Test Conditions: Tnom: 23 °Celsius°C, Vnom: 12 VDC via AC/DC-Adaptor
 Antenna: Rohde & Schwarz HK 116, Vertical
 Measurement distance: 3 m
 Mode: TX; 802.11g; 2437 MHz, Sample 30742
 Test Date: 2020-08-27
 Note:

Index 1

RadiMation

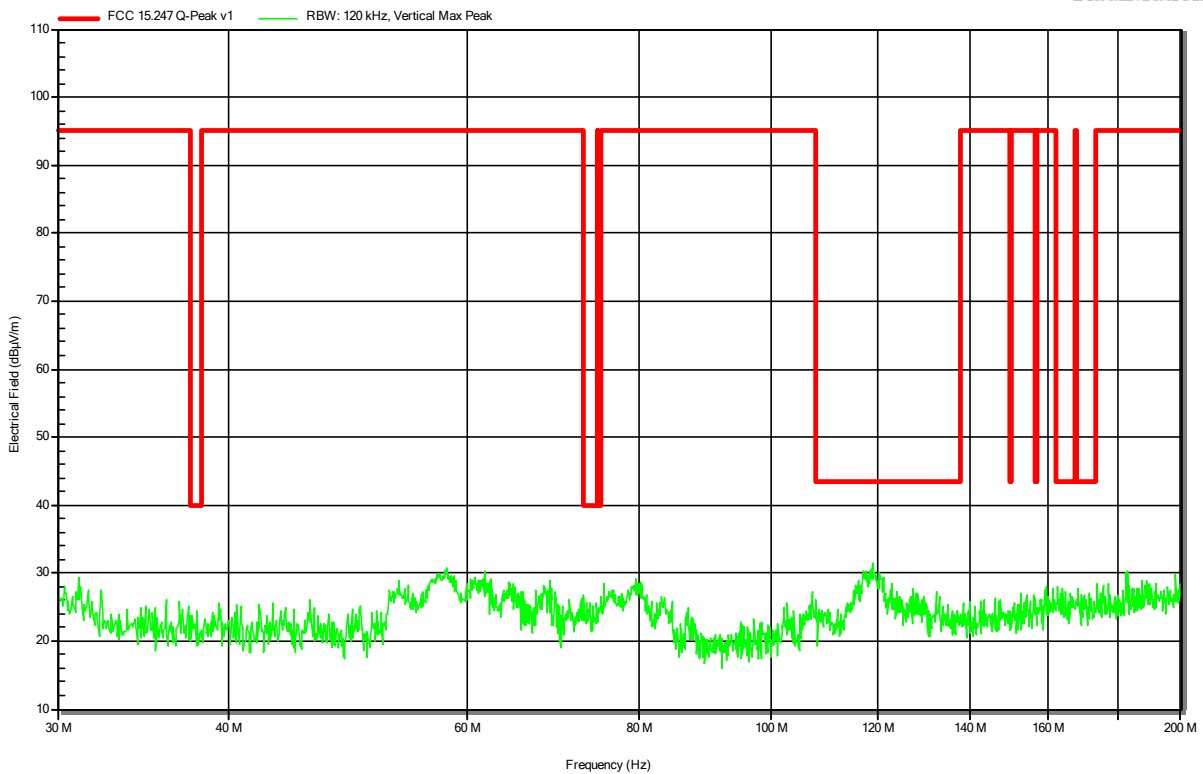

Spurious emissions according to FCC 15.247

Project number: G0M-2002-8805

Applicant: Laird Connectivity Inc
 EUT Name: 915MHz LoRaWAN Gateway incl Wi-Fi, Ethernet & LTE - Indoor and IP67 variants

Model: RG191+LTE Series
 Test Site: Eurofins Product Service Germany
 Operator: Mr. Jahn
 Measurement software: RadiMation, version 2020.0.12
 Test Conditions: Tnom: 23 °Celsius°C, Vnom: 12 VDC via AC/DC-Adaptor
 Antenna: Rohde & Schwarz HL 223, Horizontal
 Measurement distance: 3 m
 Mode: TX; 802.11g; 2437 MHz, Sample 30742
 Test Date: 2020-08-27
 Note:

Index 3

RadiMation

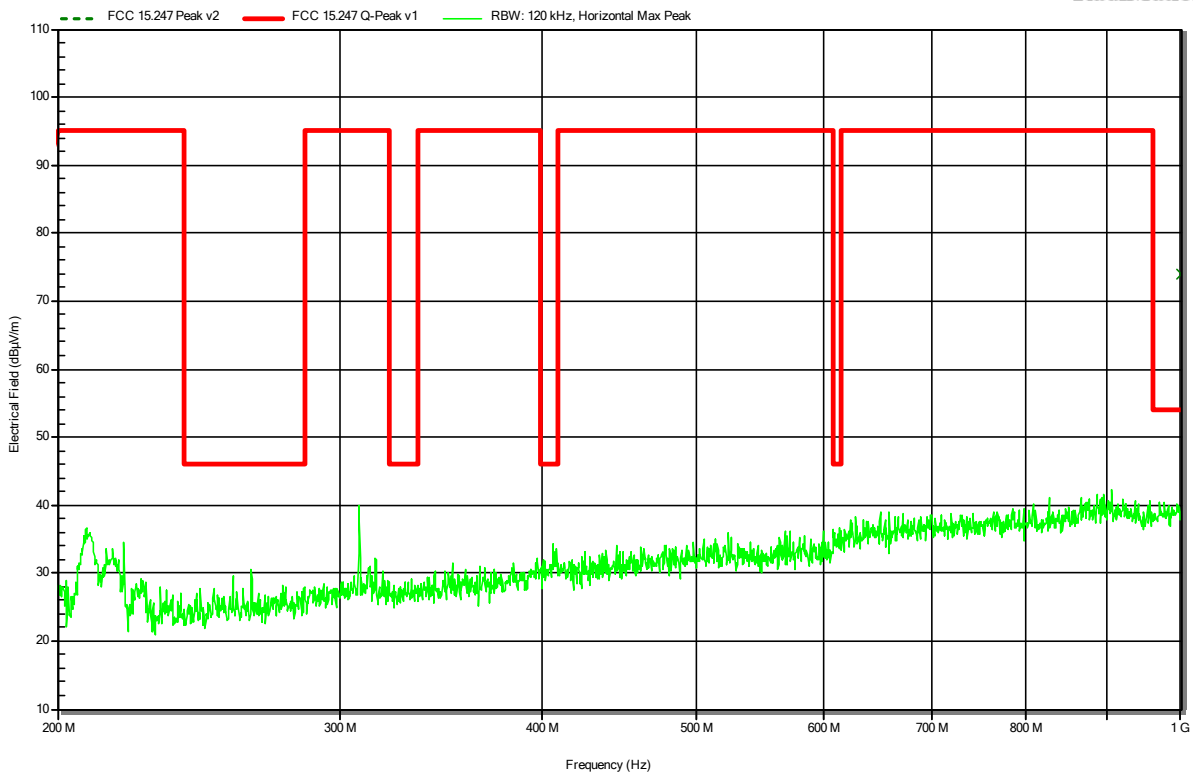

Spurious emissions according to FCC 15.247

Project number: G0M-2002-8805

Applicant: Laird Connectivity Inc
 EUT Name: 915MHz LoRaWAN Gateway incl Wi-Fi, Ethernet & LTE - Indoor and IP67 variants

Model: RG191+LTE Series
 Test Site: Eurofins Product Service Germany
 Operator: Mr. Jahn
 Measurement software: RadiMation, version 2020.0.12
 Test Conditions: Tnom: 23 °Celsius°C, Vnom: 12 VDC via AC/DC-Adaptor
 Antenna: Rohde & Schwarz HL 223, Vertical
 Measurement distance: 3 m
 Mode: TX; 802.11g; 2437 MHz, Sample 30742
 Test Date: 2020-08-27
 Note:

Index 4

RadiMation

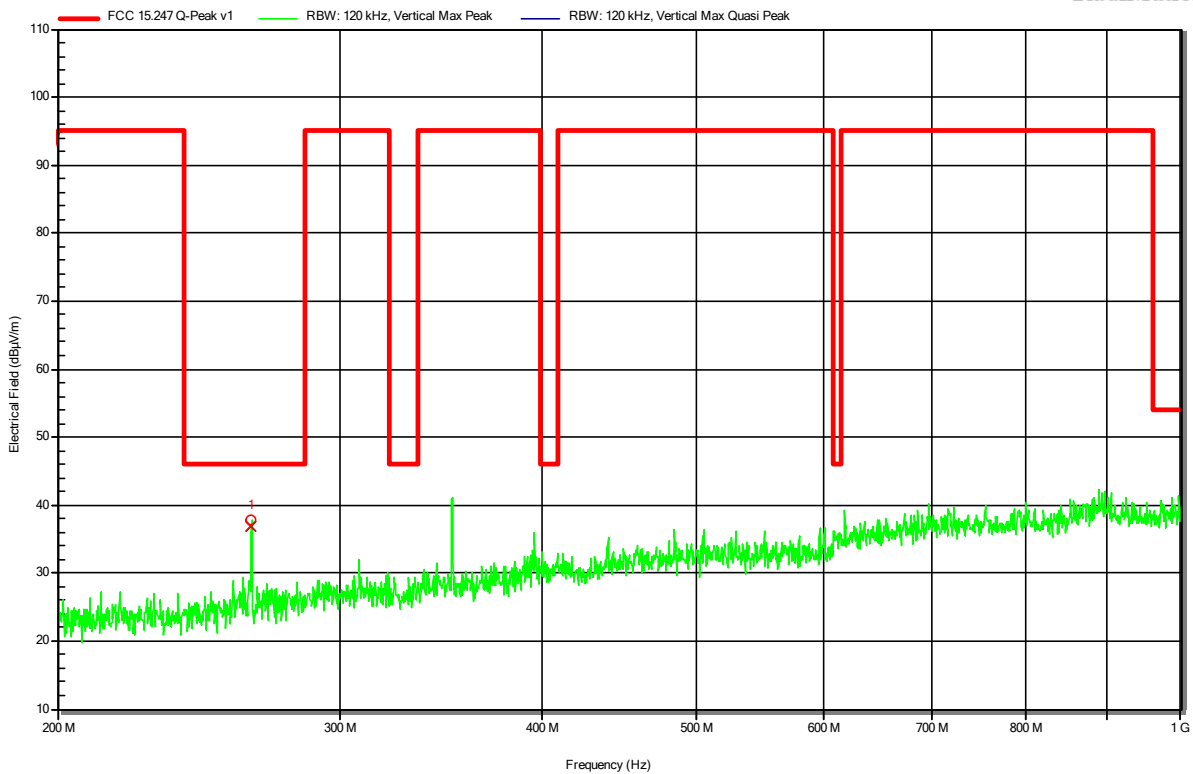

Frequency	Quasi-Peak	Quasi-Peak Limit	Quasi-Peak Difference	Quasi-Peak Status
264.0048 MHz	36.9 dBµV/m	46 dBµV/m	-9.1 dB	Pass

Spurious emissions according to FCC 47 e-CFR §15.247

Project number: G0M-2002-8805

Applicant: Laird Connectivity
 EUT Name: 915MHz LoRaWAN Gateway incl Wi-Fi, Ethernet & LTE - Indoor and IP67 variants

Model: RG191+LTE Series
 Test Site: Eurofins Product Service Germany
 Operator: Toralf Jahn
 Test Conditions: Tnom: 25°C, Vnom: 12 VDC via AC/DC-Adaptor
 Antenna: Schwarzbeck BBHA 9120D, Horizontal
 Measurement distance: 3 m converted to 3m
 Mode: TX; 802.11g; 2437 MHz, Sample 29796
 Test Date: 2020-06-25
 Note:

Index 16

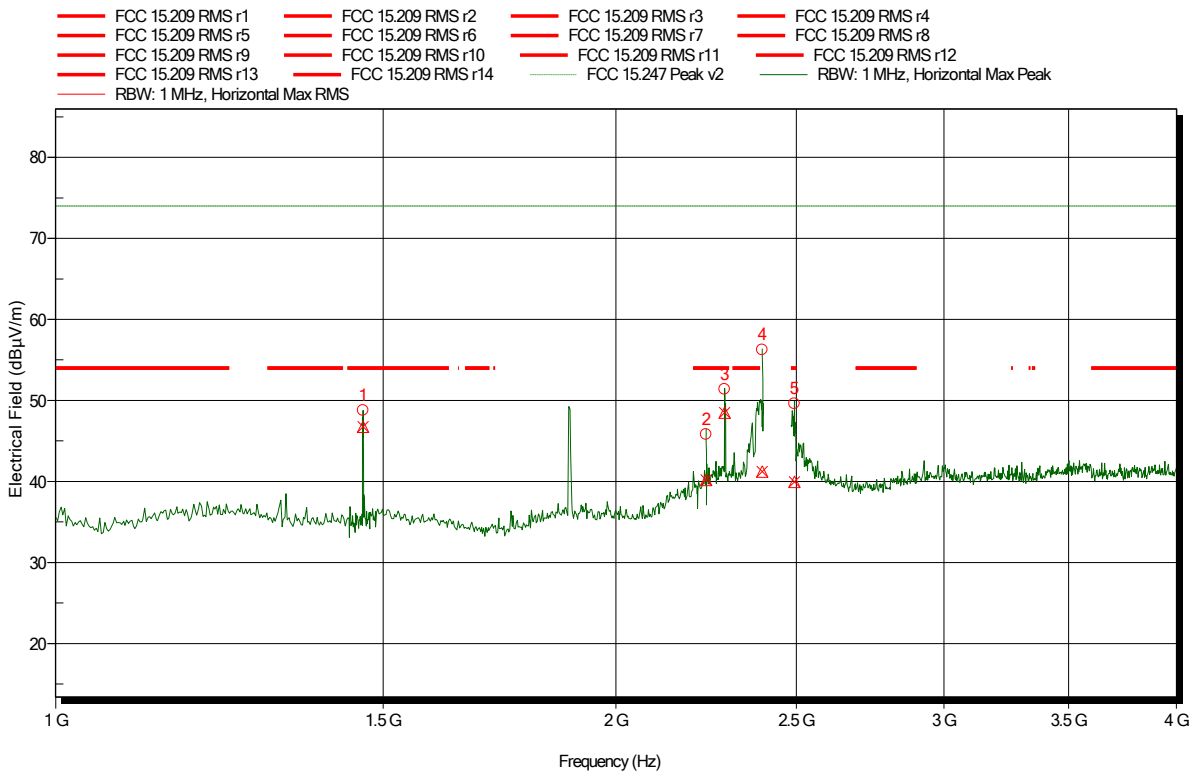

Frequency	Peak	Peak Limit	Peak Difference	Peak Status
1.463 GHz	48.77 dBµV/m	74 dBµV/m	-25.23 dB	Pass
2.2359 GHz	45.79 dBµV/m	74 dBµV/m	-28.21 dB	Pass
2.288 GHz	51.39 dBµV/m	74 dBµV/m	-22.61 dB	Pass
2.3966 GHz	56.26 dBµV/m	74 dBµV/m	-17.74 dB	Pass
2.4935 GHz	49.62 dBµV/m	74 dBµV/m	-24.38 dB	Pass

Frequency	RMS	RMS Limit	RMS Difference	RMS Status
1.463 GHz	46.76 dBµV/m	54 dBµV/m	-7.24 dB	Pass
2.2359 GHz	40.19 dBµV/m	54 dBµV/m	-13.81 dB	Pass
2.288 GHz	48.48 dBµV/m	54 dBµV/m	-5.52 dB	Pass
2.4935 GHz	39.97 dBµV/m	54 dBµV/m	-14.03 dB	Pass

Spurious emissions according to FCC 47 e-CFR §15.247

Project number: G0M-2002-8805

Applicant: Laird Connectivity
 EUT Name: 915MHz LoRaWAN Gateway incl Wi-Fi, Ethernet & LTE - Indoor and IP67 variants

Model: RG191+LTE Series
 Test Site: Eurofins Product Service Germany
 Operator: Toralf Jahn
 Test Conditions: Tnom: 25°C, Vnom: 12 VDC via AC/DC-Adaptor
 Antenna: Schwarzbeck BBHA 9120D, Vertical
 Measurement distance: 3 m converted to 3m
 Mode: TX; 802.11g; 2437 MHz, Sample 29796
 Test Date: 2020-06-25
 Note:

Index 15

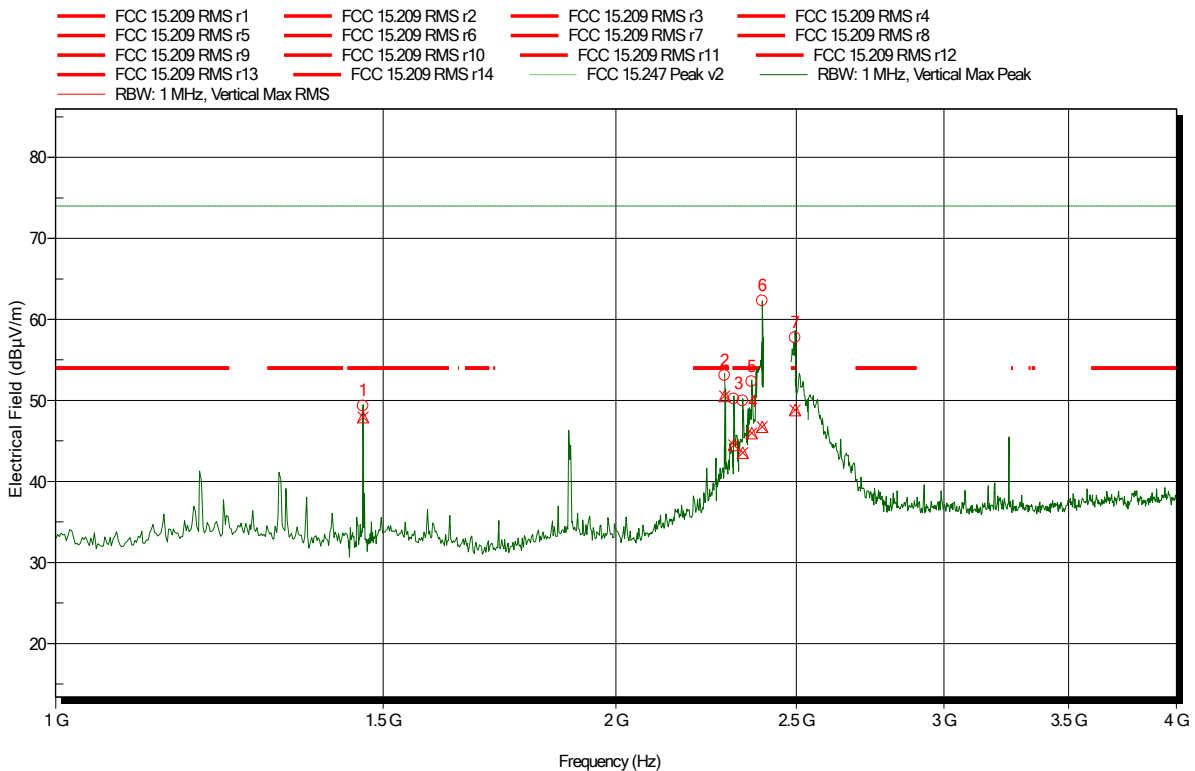

Frequency	Peak	Peak Limit	Peak Difference	Peak Status
1.4629 GHz	49.31 dBµV/m	74 dBµV/m	-24.69 dB	Pass
2.288 GHz	53.1 dBµV/m	74 dBµV/m	-20.9 dB	Pass
2.3139 GHz	50.18 dBµV/m	74 dBµV/m	-23.82 dB	Pass
2.34 GHz	49.96 dBµV/m	74 dBµV/m	-24.04 dB	Pass
2.366 GHz	52.33 dBµV/m	74 dBµV/m	-21.67 dB	Pass
2.3969 GHz	62.29 dBµV/m	74 dBµV/m	-11.71 dB	Pass
2.496 GHz	57.76 dBµV/m	74 dBµV/m	-16.24 dB	Pass

Frequency	RMS	RMS Limit	RMS Difference	RMS Status
1.4629 GHz	47.96 dBµV/m	54 dBµV/m	-6.04 dB	Pass
2.288 GHz	50.55 dBµV/m	54 dBµV/m	-3.45 dB	Pass
2.3139 GHz	44.51 dBµV/m	54 dBµV/m	-9.49 dB	Pass
2.34 GHz	43.54 dBµV/m	54 dBµV/m	-10.46 dB	Pass
2.366 GHz	45.95 dBµV/m	54 dBµV/m	-8.05 dB	Pass
2.496 GHz	48.82 dBµV/m	54 dBµV/m	-5.18 dB	Pass

Spurious emissions according to FCC 47 e-CFR §15.247

Project number: G0M-2002-8805

Applicant: Laird Connectivity
 EUT Name: 915MHz LoRaWAN Gateway incl Wi-Fi, Ethernet & LTE - Indoor and IP67 variants

Model: RG191+LTE Series
 Test Site: Eurofins Product Service Germany
 Operator: Toralf Jahn
 Test Conditions: Tnom: 25°C, Vnom: 12 VDC via AC/DC-Adaptor
 Antenna: Schwarzbeck BBHA 9120D, Horizontal
 Measurement distance: 1 m converted to 3m
 Mode: TX; 802.11g; 2437 MHz, Sample 29796
 Test Date: 2020-06-25
 Note: lower bandedge

Index 17

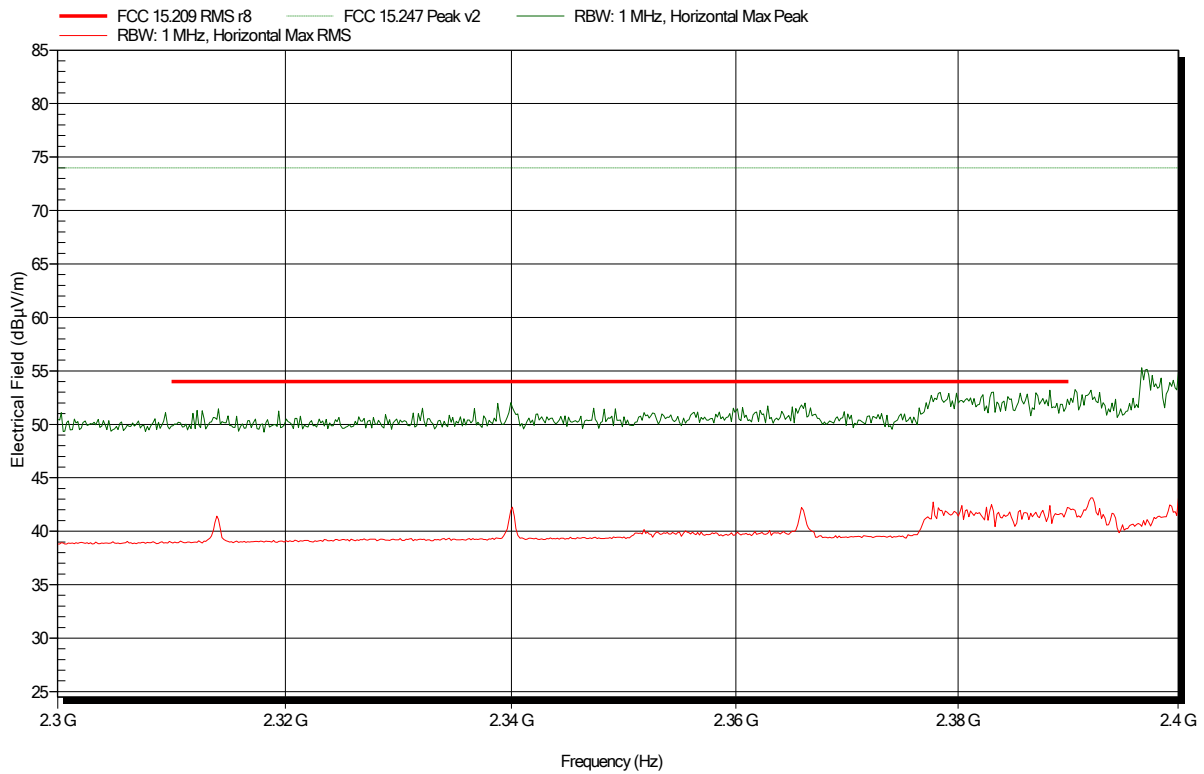

Spurious emissions according to FCC 47 e-CFR §15.247

Project number: G0M-2002-8805

Applicant: Laird Connectivity
 EUT Name: 915MHz LoRaWAN Gateway incl Wi-Fi, Ethernet & LTE - Indoor and IP67 variants

Model: RG191+LTE Series
 Test Site: Eurofins Product Service Germany
 Operator: Toralf Jahn
 Test Conditions: Tnom: 25°C, Vnom: 12 VDC via AC/DC-Adaptor
 Antenna: Schwarzbeck BBHA 9120D, Vertical
 Measurement distance: 1 m converted to 3m
 Mode: TX; 802.11g; 2437 MHz, Sample 29796
 Test Date: 2020-06-25
 Note: lower bandedge

Index 19

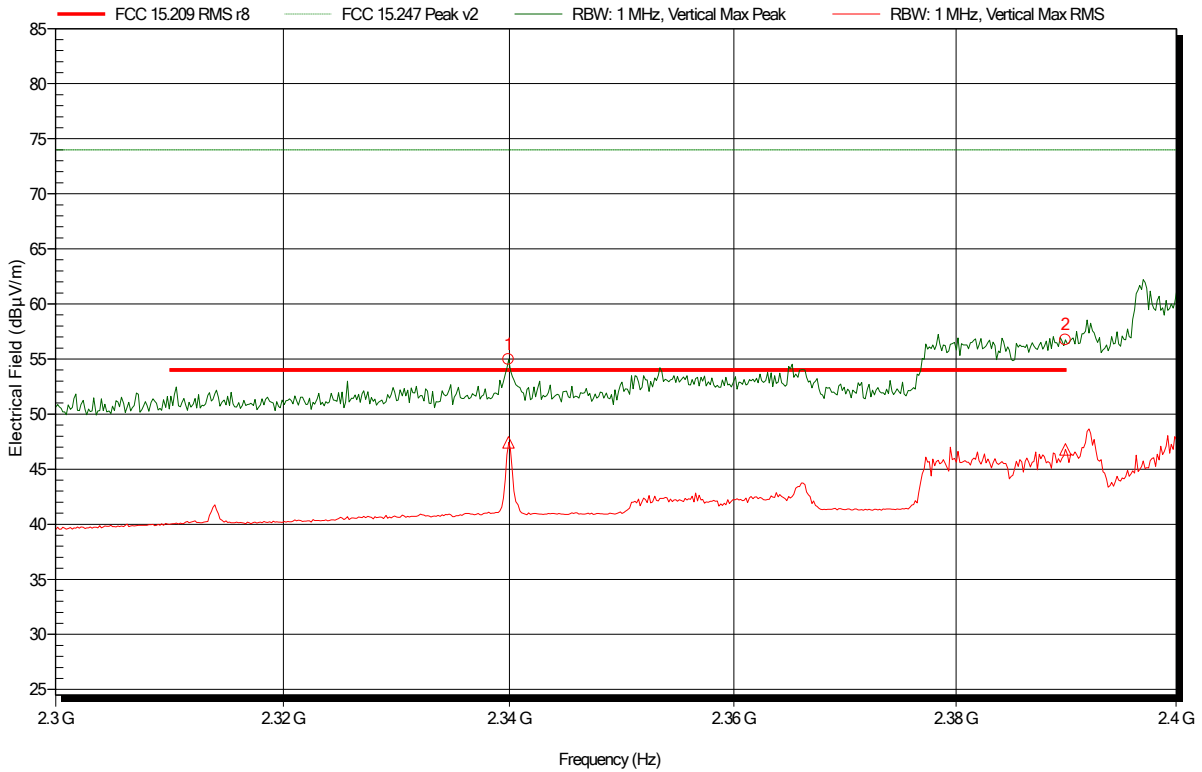

Frequency	Peak	Peak Limit	Peak Difference	Peak Status
2.3399 GHz	54.96 dBµV/m	74 dBµV/m	-19.04 dB	Pass
2.3899 GHz	56.74 dBµV/m	74 dBµV/m	-17.26 dB	Pass

Frequency	RMS	RMS Limit	RMS Difference	RMS Status
2.3399 GHz	47.44 dBµV/m	54 dBµV/m	-6.56 dB	Pass
2.3899 GHz	46.79 dBµV/m	54 dBµV/m	-7.21 dB	Pass

Spurious emissions according to FCC 47 e-CFR §15.247

Project number: G0M-2002-8805

Applicant: Laird Connectivity
 EUT Name: 915MHz LoRaWAN Gateway incl Wi-Fi, Ethernet & LTE - Indoor and IP67 variants

Model: RG191+LTE Series
 Test Site: Eurofins Product Service Germany
 Operator: Toralf Jahn
 Test Conditions: Tnom: 25°C, Vnom: 12 VDC via AC/DC-Adaptor
 Antenna: Schwarzbeck BBHA 9120D, Horizontal
 Measurement distance: 1 m converted to 3m
 Mode: TX; 802.11g; 2437 MHz, Sample 29796
 Test Date: 2020-06-25
 Note: upper bandedge

Index 18

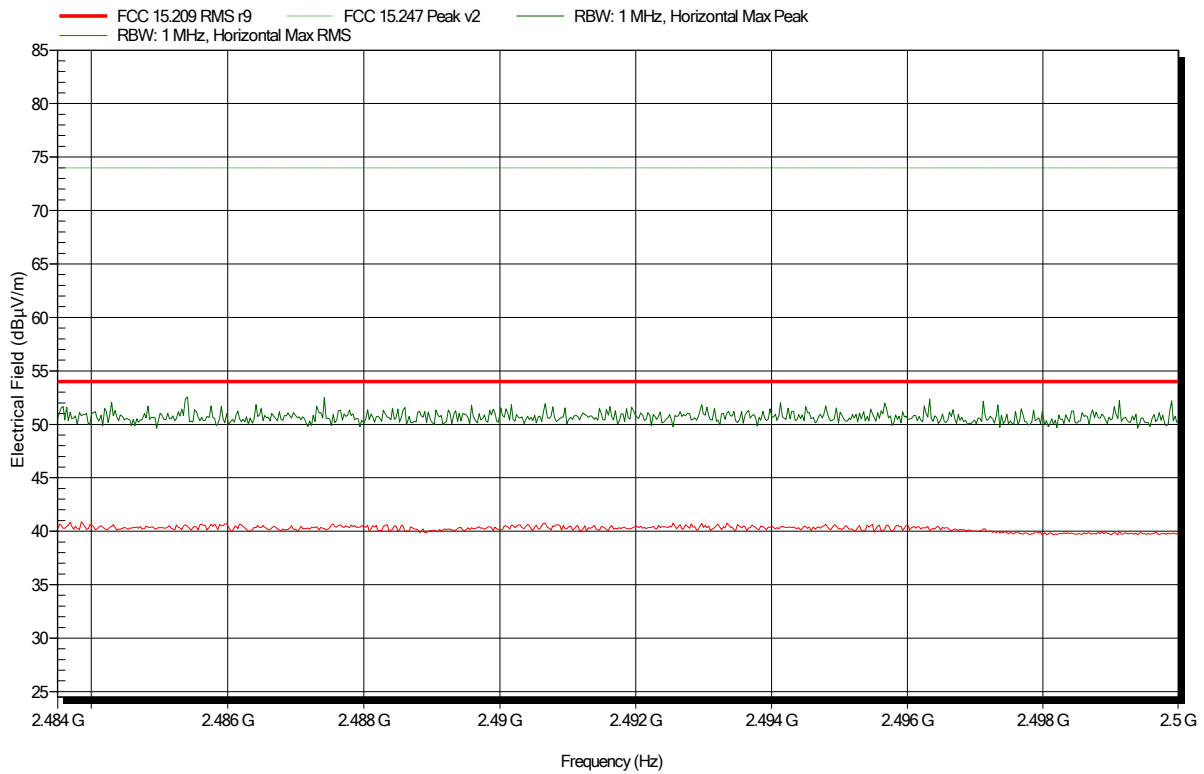

Spurious emissions according to FCC 47 e-CFR §15.247

Project number: G0M-2002-8805

Applicant: Laird Connectivity
 EUT Name: 915MHz LoRaWAN Gateway incl Wi-Fi, Ethernet & LTE - Indoor and IP67 variants

Model: RG191+LTE Series
 Test Site: Eurofins Product Service Germany
 Operator: Toralf Jahn
 Test Conditions: Tnom: 25°C, Vnom: 12 VDC via AC/DC-Adaptor
 Antenna: Schwarzbeck BBHA 9120D, Vertical
 Measurement distance: 1 m converted to 3m
 Mode: TX; 802.11g; 2437 MHz, Sample 29796
 Test Date: 2020-06-25
 Note: upper bandedge

Index 20

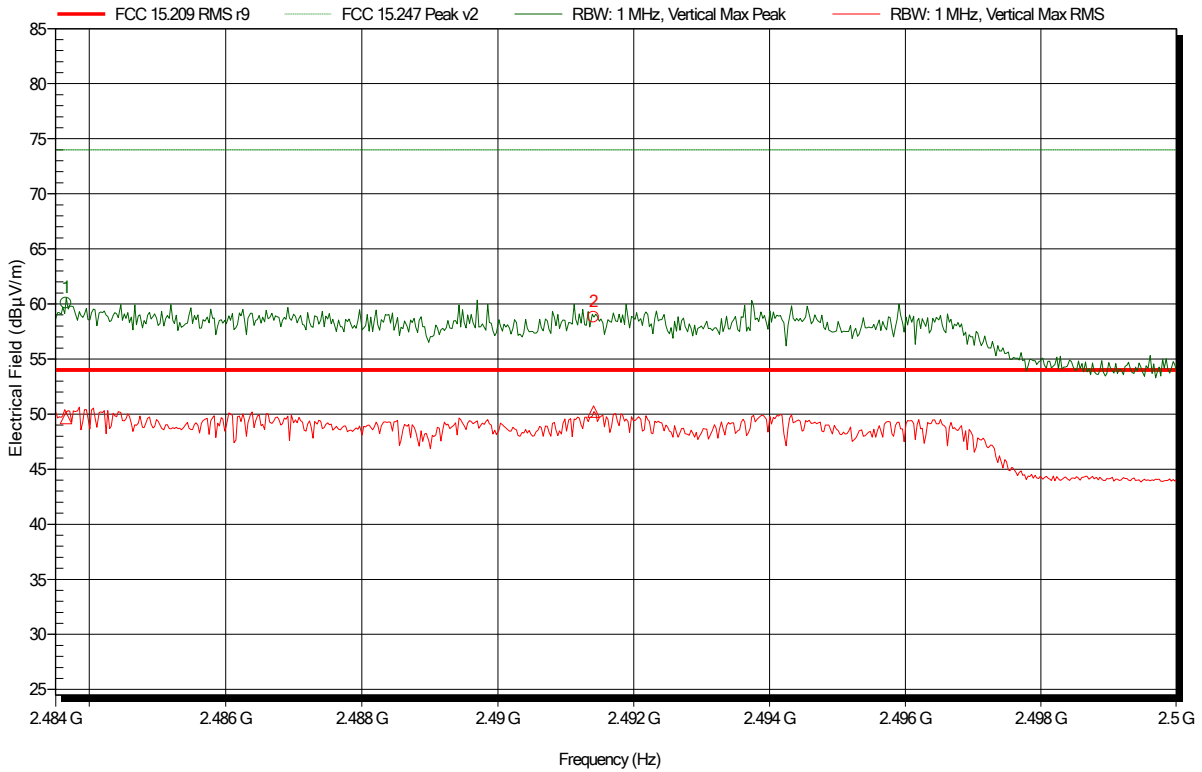

Frequency	Peak	Peak Limit	Peak Difference	Peak Status
2.4837 GHz	60.09 dBµV/m	74 dBµV/m	-13.91 dB	Pass
2.4914 GHz	58.81 dBµV/m	74 dBµV/m	-15.19 dB	Pass

Frequency	RMS	RMS Limit	RMS Difference	RMS Status
2.4837 GHz	49.65 dBµV/m	54 dBµV/m	-4.35 dB	Pass
2.4914 GHz	50.23 dBµV/m	54 dBµV/m	-3.77 dB	Pass

Spurious emissions according to FCC 47 e-CFR §15.247

Project number: G0M-2002-8805

Applicant: Laird Connectivity
 EUT Name: 915MHz LoRaWAN Gateway incl Wi-Fi, Ethernet & LTE - Indoor and IP67 variants

Model: RG191+LTE Series

Test Site: Eurofins Product Service Germany

Operator: Toralf Jahn

Test Conditions: Tnom: 25°C, Vnom: 12 VDC via AC/DC-Adaptor

Antenna: Schwarzbeck BBHA 9120D, Horizontal

Measurement distance: 1 m converted to 3m

Mode: TX; 802.11g; 2437 MHz, Sample 29796

Test Date: 2020-06-25

Note:

Index 21

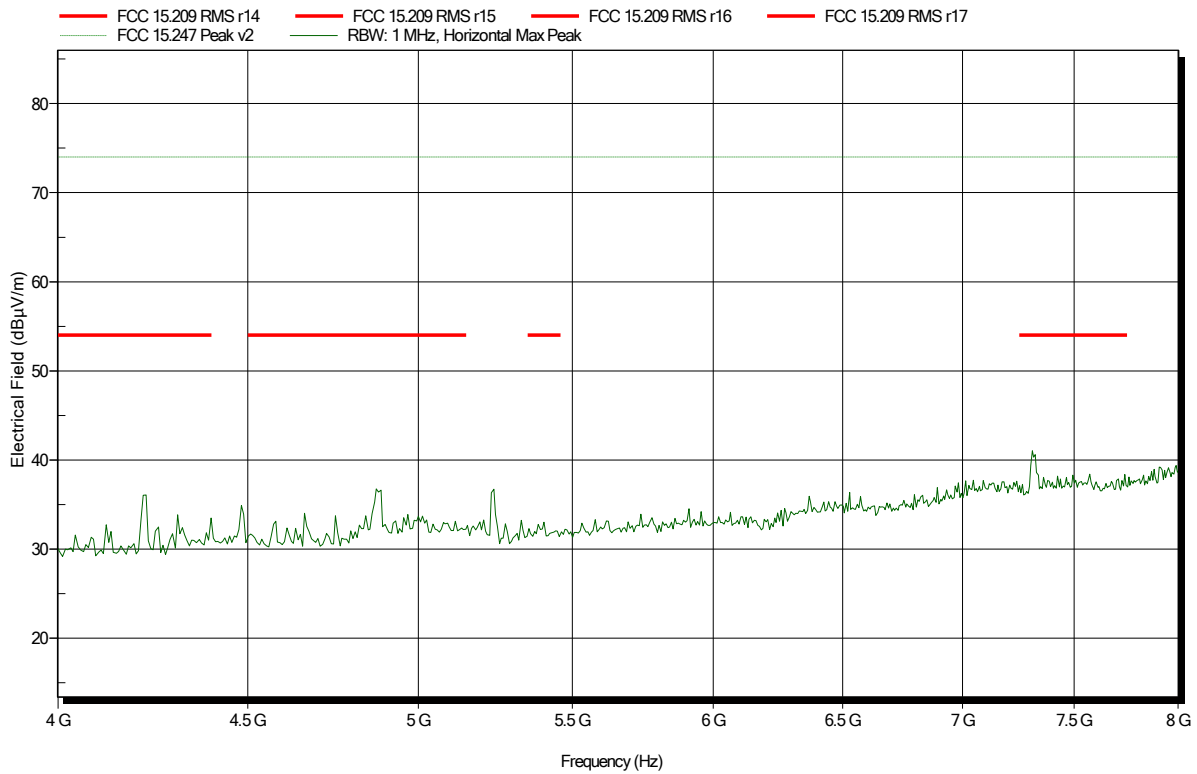

Spurious emissions according to FCC 47 e-CFR §15.247

Project number: G0M-2002-8805

Applicant: Laird Connectivity
 EUT Name: 915MHz LoRaWAN Gateway incl Wi-Fi, Ethernet & LTE - Indoor and IP67 variants

Model: RG191+LTE Series

Test Site: Eurofins Product Service Germany

Operator: Toralf Jahn

Test Conditions: Tnom: 25°C, Vnom: 12 VDC via AC/DC-Adaptor

Antenna: Schwarzbeck BBHA 9120D, Vertical

Measurement distance: 1 m converted to 3m

Mode: TX; 802.11g; 2437 MHz, Sample 29796

Test Date: 2020-06-25

Note:

Index 23

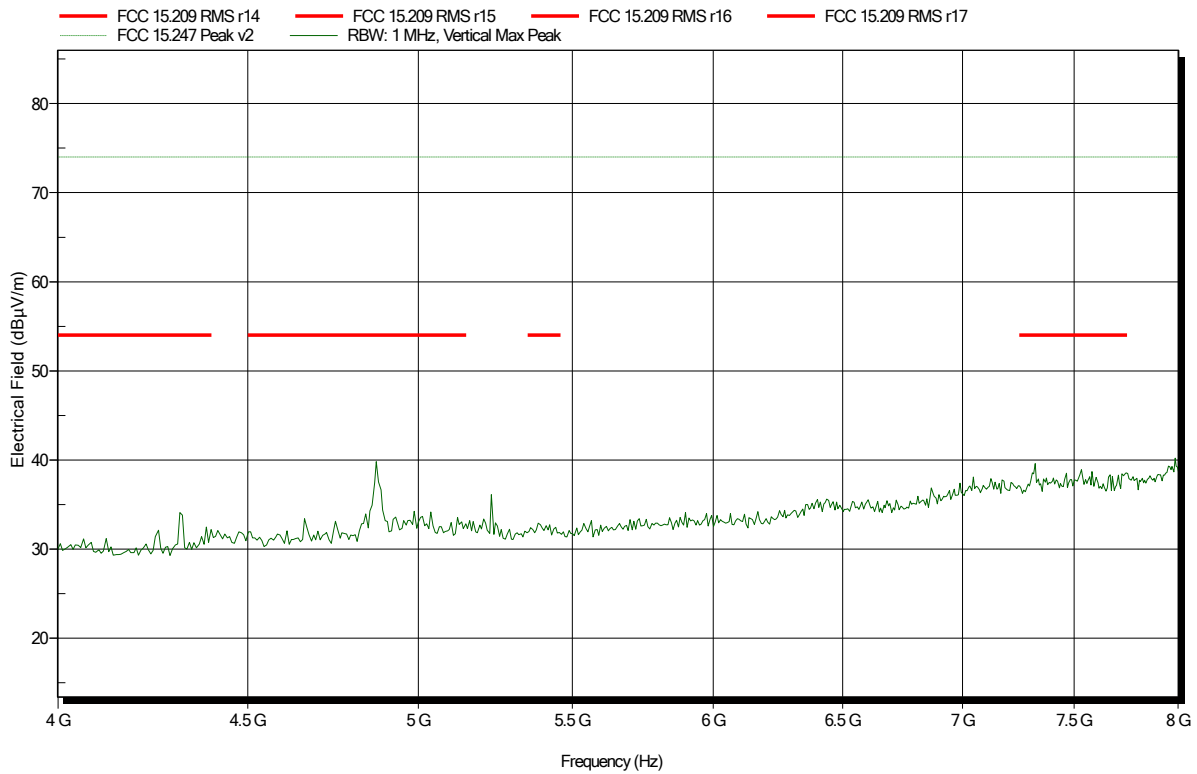

Spurious emissions according to FCC 47 e-CFR §15.247

Project number: G0M-2002-8805

Applicant: Laird Connectivity
 EUT Name: 915MHz LoRaWAN Gateway incl Wi-Fi, Ethernet & LTE - Indoor and IP67 variants

Model: RG191+LTE Series
 Test Site: Eurofins Product Service Germany
 Operator: Toralf Jahn
 Test Conditions: Tnom: 25°C, Vnom: 12 VDC via AC/DC-Adaptor
 Antenna: Schwarzbeck BBHA 9120D, Horizontal
 Measurement distance: 1 m converted to 3m
 Mode: TX; 802.11g; 2437 MHz, Sample 29796
 Test Date: 2020-06-25
 Note:

Index 22

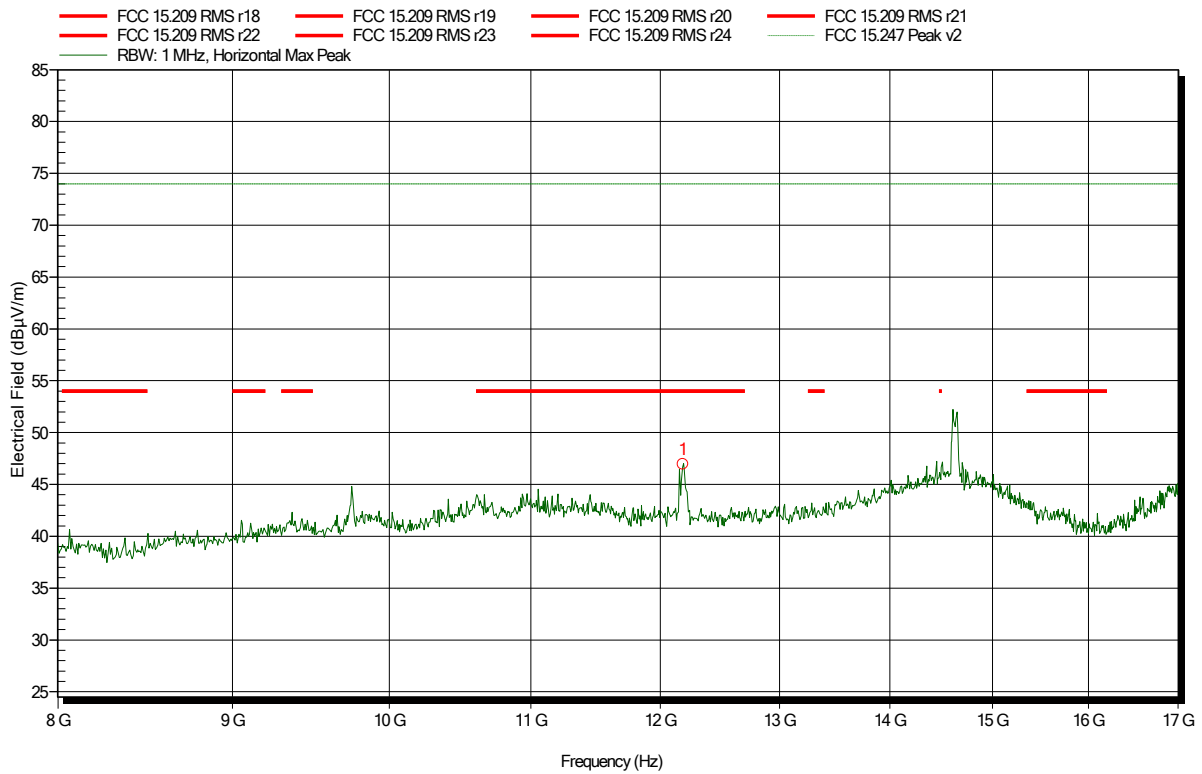

Frequency	Peak	Peak Limit	Peak Difference	Peak Status
12.184 GHz	46.95 dBµV/m	74 dBµV/m	-27.05 dB	Pass

Spurious emissions according to FCC 47 e-CFR §15.247

Project number: G0M-2002-8805

Applicant: Laird Connectivity
 EUT Name: 915MHz LoRaWAN Gateway incl Wi-Fi, Ethernet & LTE - Indoor and IP67 variants

Model: RG191+LTE Series
 Test Site: Eurofins Product Service Germany
 Operator: Toralf Jahn
 Test Conditions: Tnom: 25°C, Vnom: 12 VDC via AC/DC-Adaptor
 Antenna: Schwarzbeck BBHA 9120D, Vertical
 Measurement distance: 1 m converted to 3m
 Mode: TX; 802.11g; 2437 MHz, Sample 29796
 Test Date: 2020-06-25
 Note:

Index 24

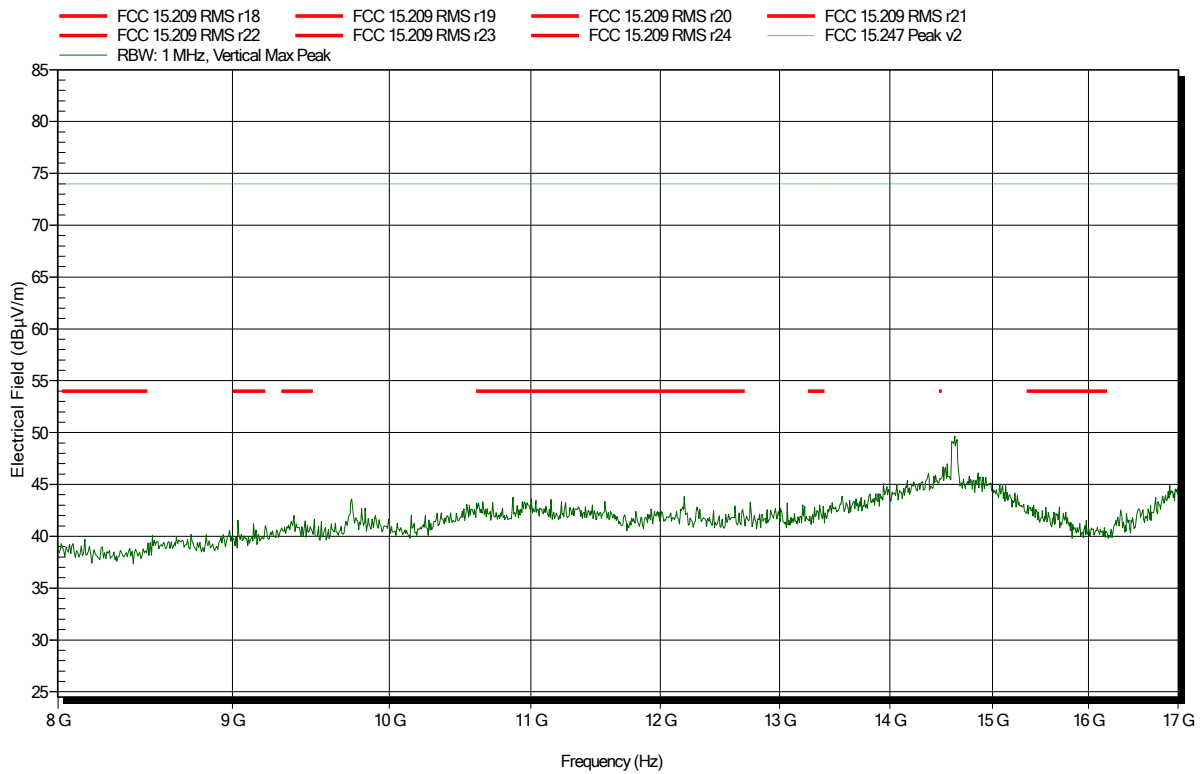

Spurious emissions according to FCC 47 e-CFR §15.247

Project number: G0M-2002-8805

Applicant: Laird Connectivity
 EUT Name: 915MHz LoRaWAN Gateway incl Wi-Fi, Ethernet & LTE - Indoor and IP67 variants

Model: RG191+LTE Series

Test Site: Eurofins Product Service Germany

Operator: Toralf Jahn

Test Conditions: Tnom: 25°C, Vnom: 12 VDC via AC/DC-Adaptor

Antenna: Amplifier Research AT4560, Horizontal

Measurement distance: 1 m converted to 3m

Mode: TX; 802.11g; 2437 MHz, Sample 29796

Test Date: 2020-06-25

Note:

Index 25

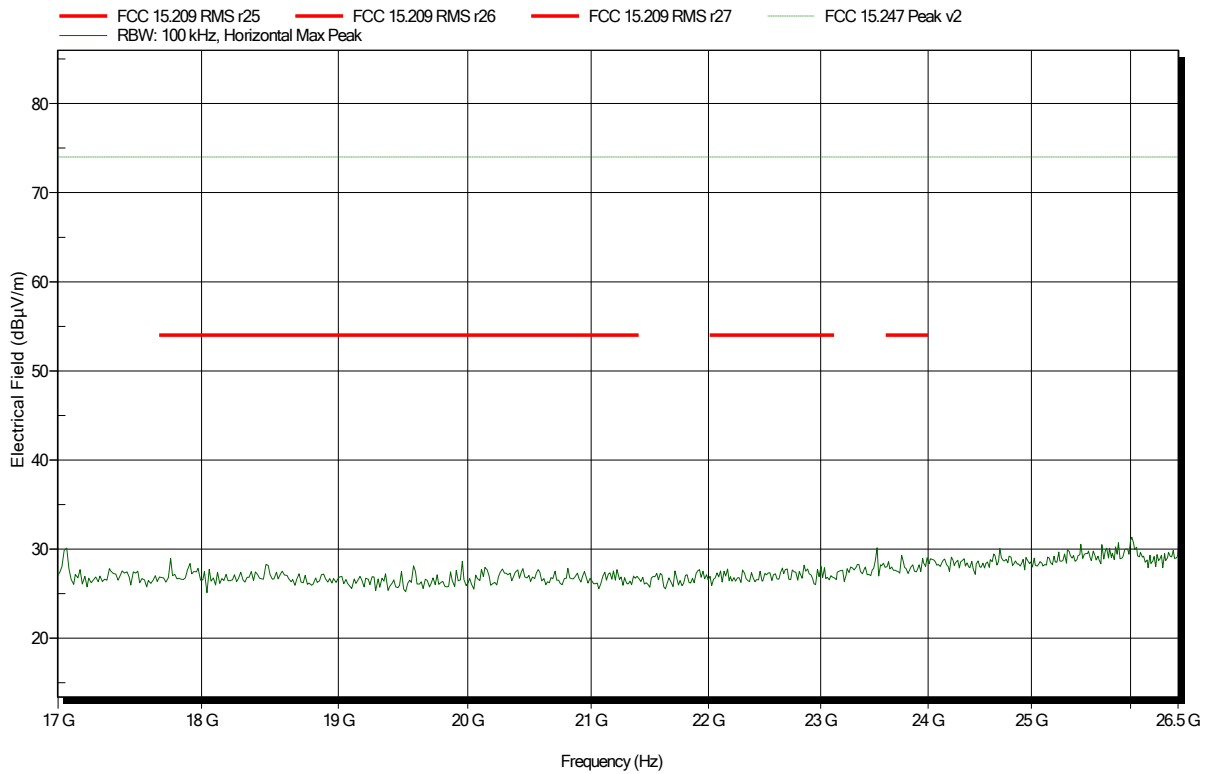

Spurious emissions according to FCC 47 e-CFR §15.247

Project number: G0M-2002-8805

Applicant: Laird Connectivity
 EUT Name: 915MHz LoRaWAN Gateway incl Wi-Fi, Ethernet & LTE - Indoor and IP67 variants

Model: RG191+LTE Series
 Test Site: Eurofins Product Service Germany
 Operator: Toralf Jahn
 Test Conditions: Tnom: 25°C, Vnom: 12 VDC via AC/DC-Adaptor
 Antenna: Amplifier Research AT4560, Vertical
 Measurement distance: 1 m converted to 3m
 Mode: TX; 802.11g; 2437 MHz, Sample 29796
 Test Date: 2020-06-25
 Note:

Index 26

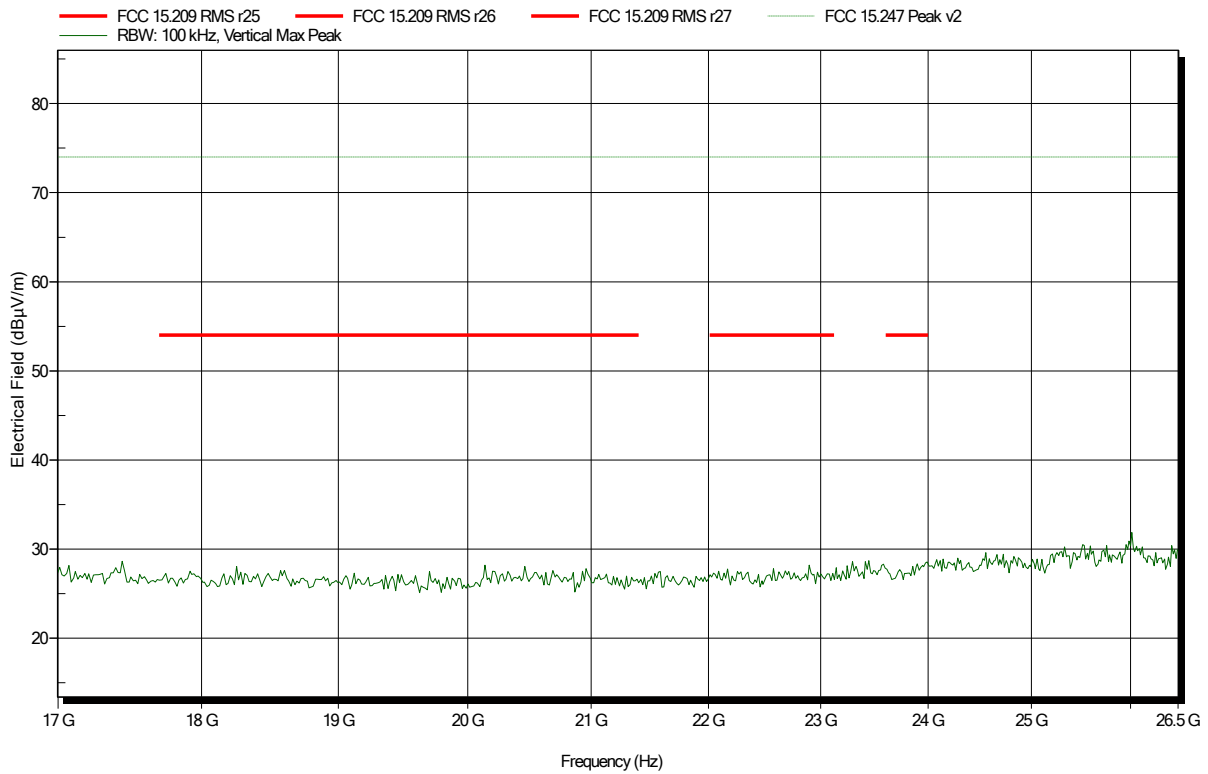

ANNEX B Receiver spurious emissions

Spurious emissions according to RSS-Gen

Project number: G0M-2002-8805

Applicant: Laird Connectivity Inc
 EUT Name: 915MHz LoRaWAN Gateway incl Wi-Fi, Ethernet & LTE - Indoor and IP67 variants

Model: RG191+LTE Series
 Test Site: Eurofins Product Service Germany
 Operator: Mr. Jahn
 Measurement software: RadiMation, version 2020.1.8
 Test Conditions: Tnom: 23 °Celsius°C, Vnom: 12 VDC via AC/DC-Adaptor
 Antenna: Rohde & Schwarz HK 116, Horizontal
 Measurement distance: 3 m
 Mode: RX; 802.11 scan mode, Sample 30742
 Test Date: 2020-08-27
 Note:

Index 12

RadiMation

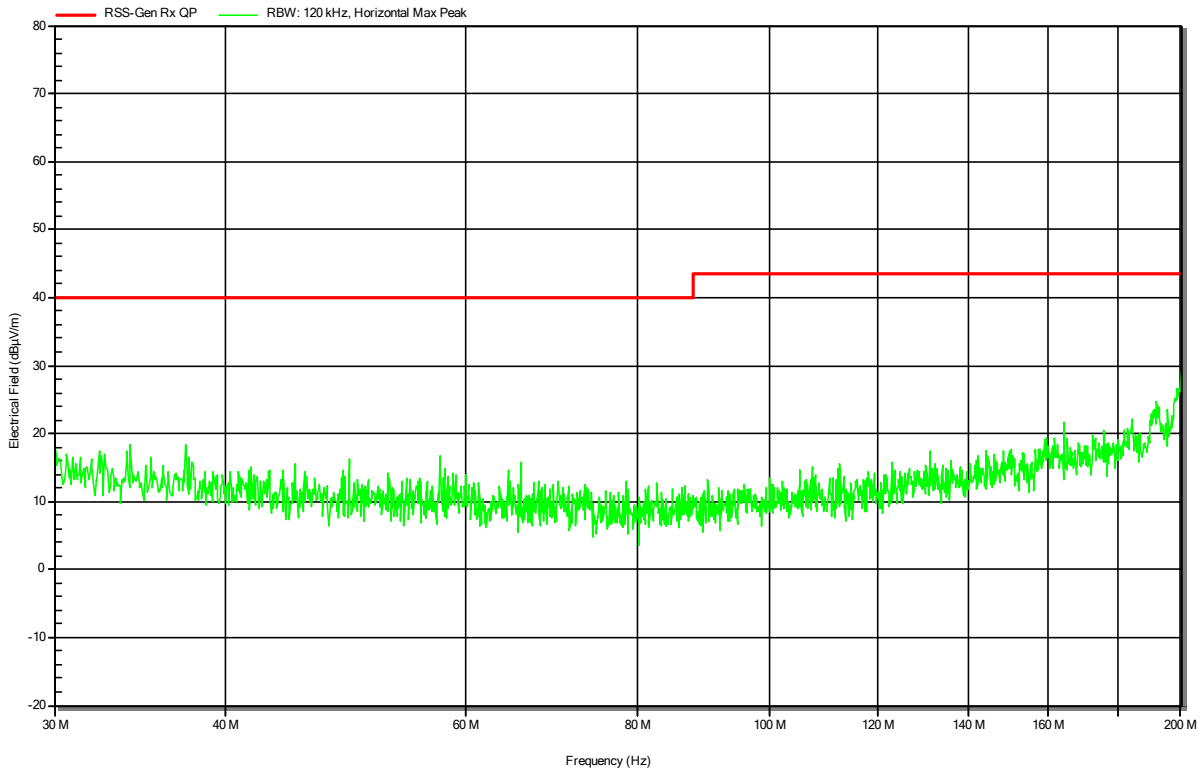

Spurious emissions according to RSS-Gen

Project number: G0M-2002-8805

Applicant: Laird Connectivity Inc
 EUT Name: 915MHz LoRaWAN Gateway incl Wi-Fi, Ethernet & LTE - Indoor and IP67 variants

Model: RG191+LTE Series
 Test Site: Eurofins Product Service Germany
 Operator: Mr. Jahn
 Measurement software: RadiMation, version 2020.1.8
 Test Conditions: Tnom: 23 °Celsius°C, Vnom: 12 VDC via AC/DC-Adaptor
 Antenna: Rohde & Schwarz HK 116, Vertical
 Measurement distance: 3 m
 Mode: RX; 802.11 scan mode, Sample 30742
 Test Date: 2020-08-27
 Note:

Index 13

RadiMation

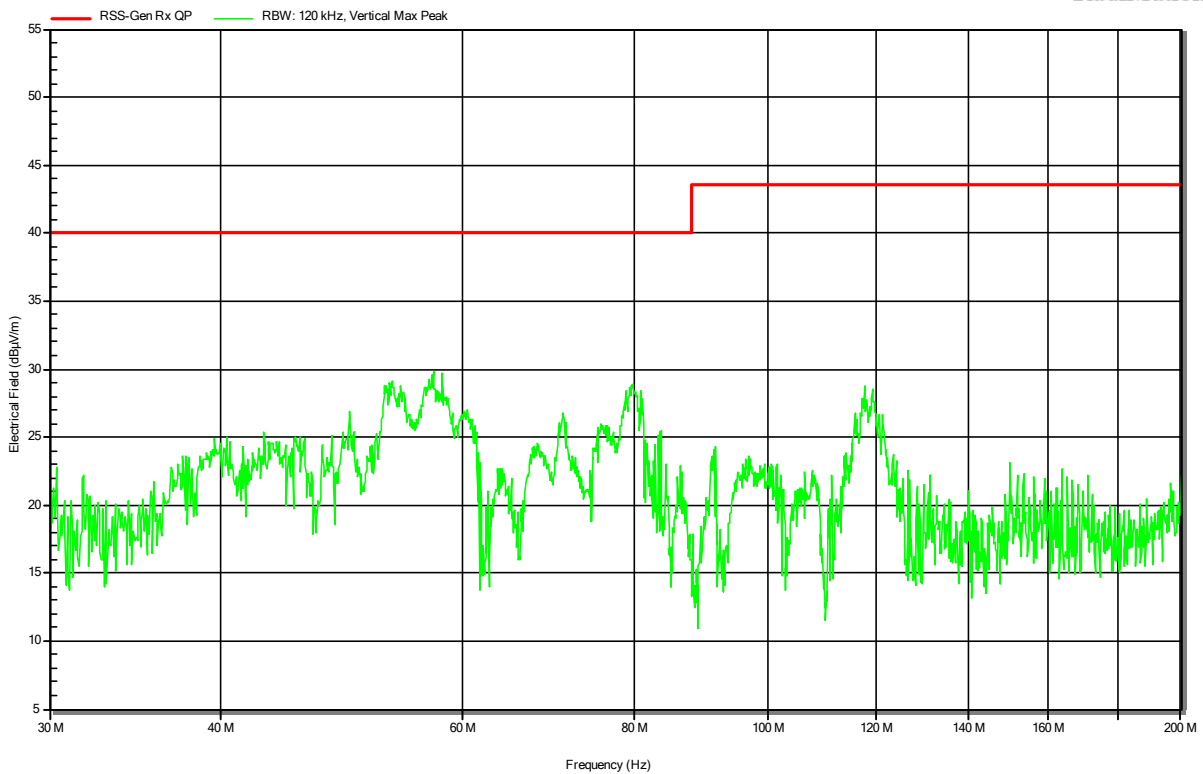

Spurious emissions according to RSS-Gen

Project number: G0M-2002-8805

Applicant: Laird Connectivity Inc
 EUT Name: 915MHz LoRaWAN Gateway incl Wi-Fi, Ethernet & LTE - Indoor and IP67 variants

Model: RG191+LTE Series
 Test Site: Eurofins Product Service Germany
 Operator: Mr. Jahn
 Measurement software: RadiMation, version 2020.1.8
 Test Conditions: Tnom: 23 °Celsius°C, Vnom: 12 VDC via AC/DC-Adaptor
 Antenna: Rohde & Schwarz HL 223, Horizontal
 Measurement distance: 3 m
 Mode: RX; 802.11 scan mode, Sample 30742
 Test Date: 2020-08-27
 Note:

Index 14

RadiMation

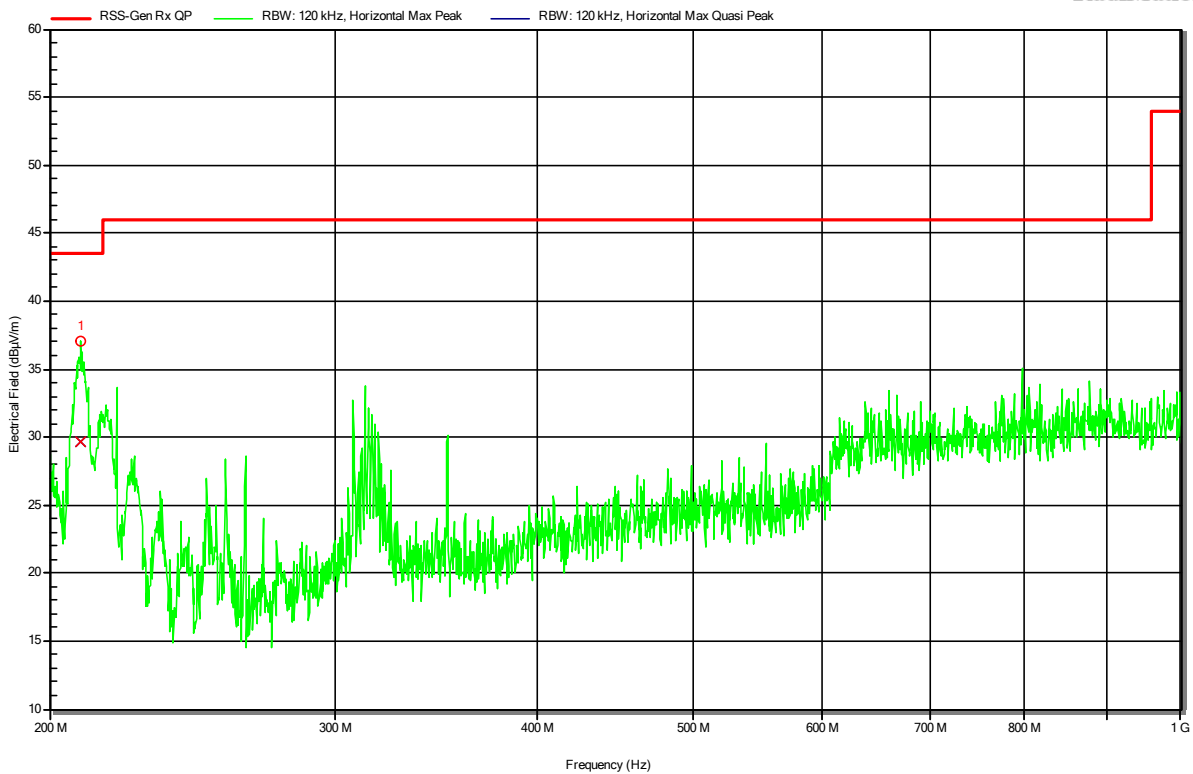

Frequency	Quasi-Peak	Quasi-Peak Limit	Quasi-Peak Difference	Quasi-Peak Status	Angle	Height
209.0063 MHz	29.7 dBµV/m	43.5 dBµV/m	-13.84 dB	Pass	0 degrees	1 m

Spurious emissions according to RSS-Gen

Project number: G0M-2002-8805

Applicant: Laird Connectivity Inc
 EUT Name: 915MHz LoRaWAN Gateway incl Wi-Fi, Ethernet & LTE - Indoor and IP67 variants

Model: RG191+LTE Series
 Test Site: Eurofins Product Service Germany
 Operator: Mr. Jahn
 Measurement software: RadiMation, version 2020.1.8
 Test Conditions: Tnom: 23 °Celsius°C, Vnom: 12 VDC via AC/DC-Adaptor
 Antenna: Rohde & Schwarz HL 223, Vertical
 Measurement distance: 3 m
 Mode: RX; 802.11 scan mode, Sample 30742
 Test Date: 2020-08-27
 Note:

Index 15

RadiMation

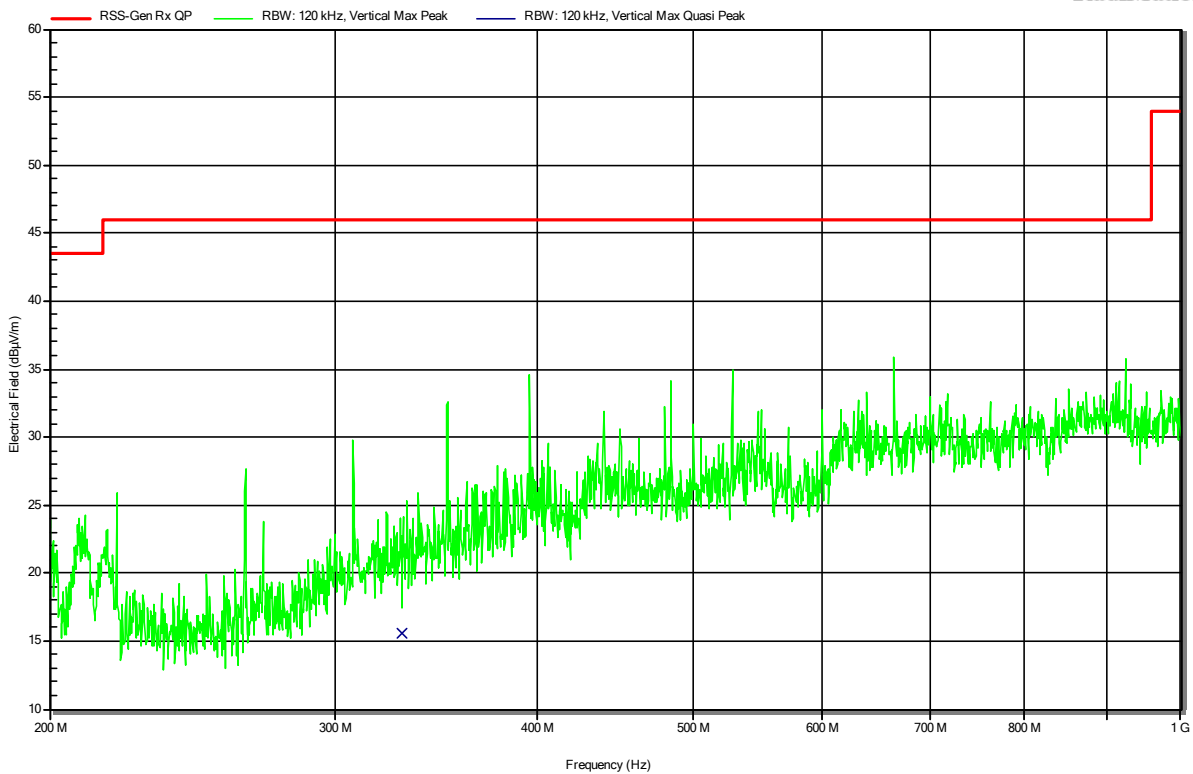

Spurious emissions according to RSS-Gen

Project number: G0M-2002-8805

Applicant: Laird Connectivity
 EUT Name: 915MHz LoRaWAN Gateway incl Wi-Fi, Ethernet & LTE - Indoor and IP67 variants

Model: RG191+LTE Series
 Test Site: Eurofins Product Service Germany
 Operator: Toralf Jahn
 Test Conditions: Tnom: 25°C, Vnom: 12 VDC via AC/DC-Adaptor
 Antenna: Schwarzbeck BBHA 9120D, Horizontal
 Measurement distance: 1 m converted to 3m
 Mode: RX; 802.11 scan mode, Sample 29796
 Test Date: 2020-06-25
 Note:

Index 29

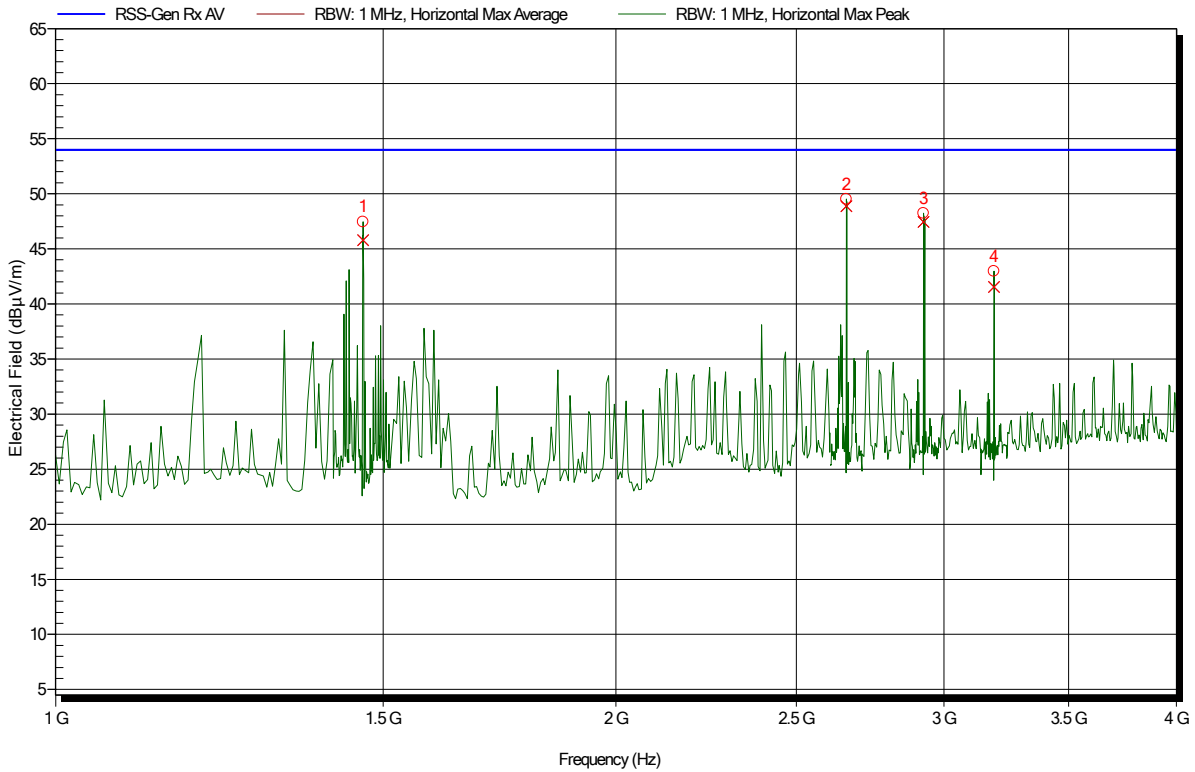

Frequency	Average	Average Limit	Average Difference	Average Status
1.463 GHz	45.8 dBµV/m	53.98 dBµV/m	-8.18 dB	Pass
2.66 GHz	48.89 dBµV/m	53.98 dBµV/m	-5.09 dB	Pass
2.926 GHz	47.43 dBµV/m	53.98 dBµV/m	-6.55 dB	Pass
3.192 GHz	41.56 dBµV/m	53.98 dBµV/m	-12.42 dB	Pass

Spurious emissions according to RSS-Gen

Project number: G0M-2002-8805

Applicant: Laird Connectivity
 EUT Name: 915MHz LoRaWAN Gateway incl Wi-Fi, Ethernet & LTE - Indoor and IP67 variants

Model: RG191+LTE Series
 Test Site: Eurofins Product Service Germany
 Operator: Toralf Jahn
 Test Conditions: Tnom: 25°C, Vnom: 12 VDC via AC/DC-Adaptor
 Antenna: Schwarzbeck BBHA 9120D, Vertical
 Measurement distance: 1 m converted to 3m
 Mode: RX; 802.11 scan mode, Sample 29796
 Test Date: 2020-06-25
 Note:

Index 33

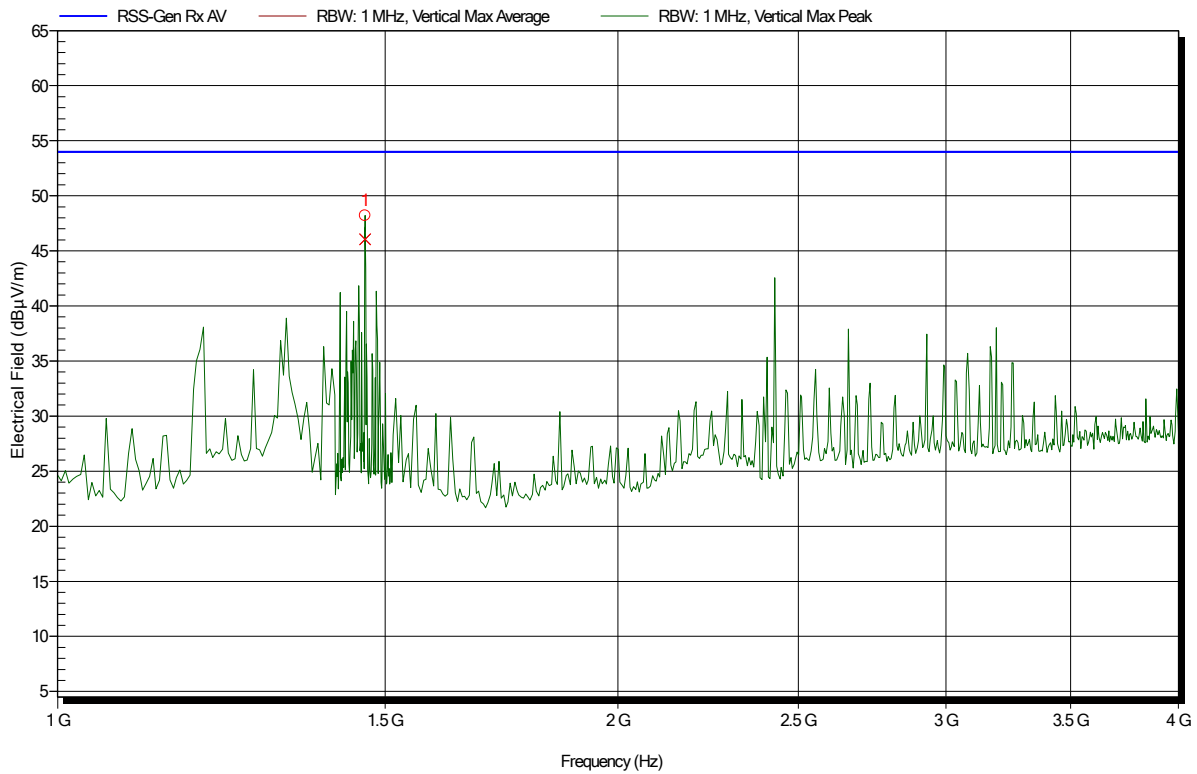

Frequency	Average	Average Limit	Average Difference	Average Status
1.463 GHz	46.06 dBµV/m	53.98 dBµV/m	-7.92 dB	Pass

Spurious emissions according to RSS-Gen

Project number: G0M-2002-8805

Applicant: Laird Connectivity
 EUT Name: 915MHz LoRaWAN Gateway incl Wi-Fi, Ethernet & LTE - Indoor and IP67 variants

Model: RG191+LTE Series
 Test Site: Eurofins Product Service Germany
 Operator: Toralf Jahn
 Test Conditions: Tnom: 25°C, Vnom: 12 VDC via AC/DC-Adaptor
 Antenna: Schwarzbeck BBHA 9120D, Horizontal
 Measurement distance: 1 m converted to 3m
 Mode: RX; 802.11 scan mode, Sample 29796
 Test Date: 2020-06-25
 Note:

Index 30

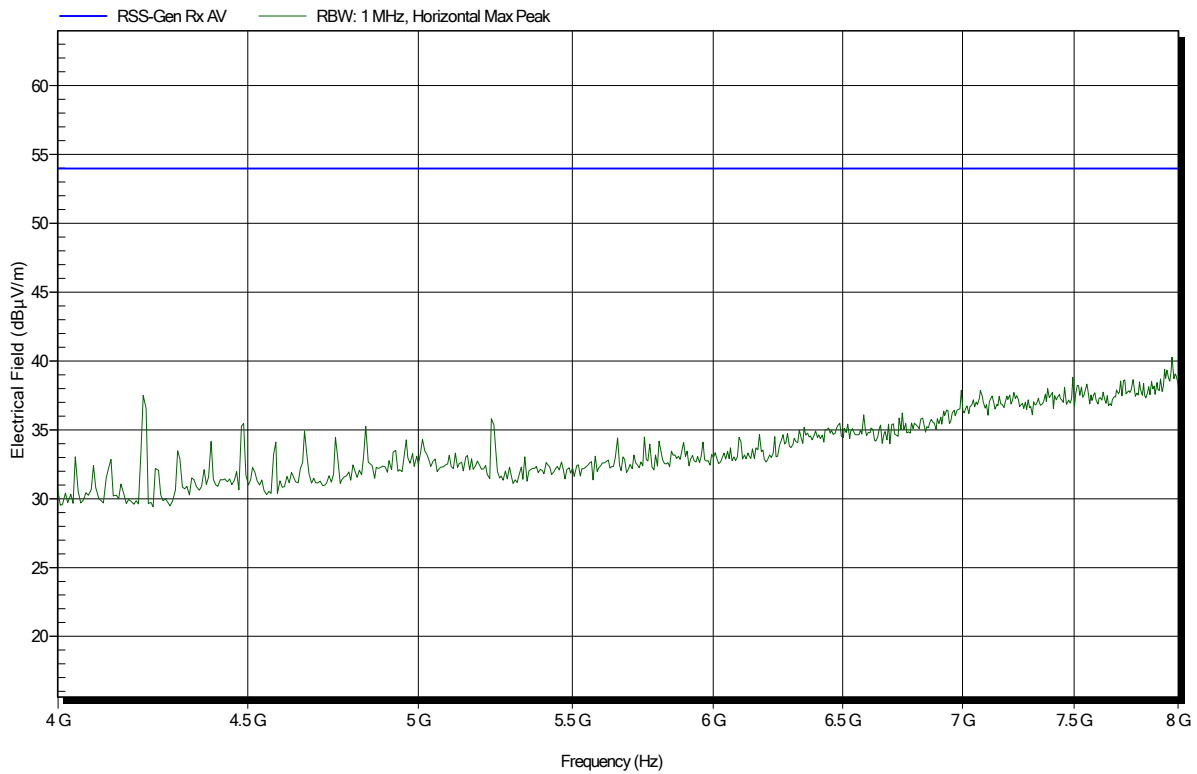

Spurious emissions according to RSS-Gen

Project number: G0M-2002-8805

Applicant: Laird Connectivity
 EUT Name: 915MHz LoRaWAN Gateway incl Wi-Fi, Ethernet & LTE - Indoor and IP67 variants

Model: RG191+LTE Series

Test Site: Eurofins Product Service Germany

Operator: Toralf Jahn

Test Conditions: Tnom: 25°C, Vnom: 12 VDC via AC/DC-Adaptor

Antenna: Schwarzbeck BBHA 9120D, Vertical

Measurement distance: 1 m converted to 3m

Mode: RX; 802.11 scan mode, Sample 29796

Test Date: 2020-06-25

Note:

Index 34

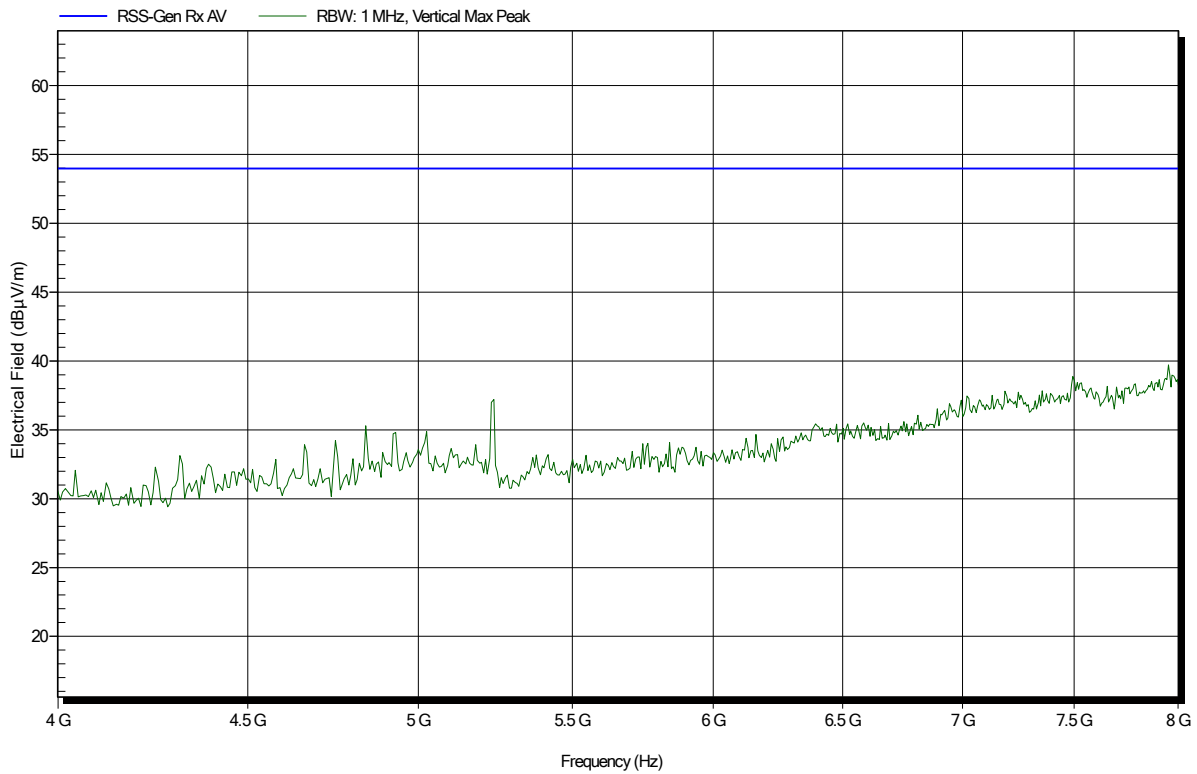

Spurious emissions according to RSS-Gen

Project number: G0M-2002-8805

Applicant: Laird Connectivity
 EUT Name: 915MHz LoRaWAN Gateway incl Wi-Fi, Ethernet & LTE - Indoor and IP67 variants

Model: RG191+LTE Series
 Test Site: Eurofins Product Service Germany
 Operator: Toralf Jahn
 Test Conditions: Tnom: 25°C, Vnom: 12 VDC via AC/DC-Adaptor
 Antenna: Schwarzbeck BBHA 9120D, Horizontal
 Measurement distance: 1 m converted to 3m
 Mode: RX; 802.11 scan mode, Sample 29796
 Test Date: 2020-06-25
 Note:

Index 31

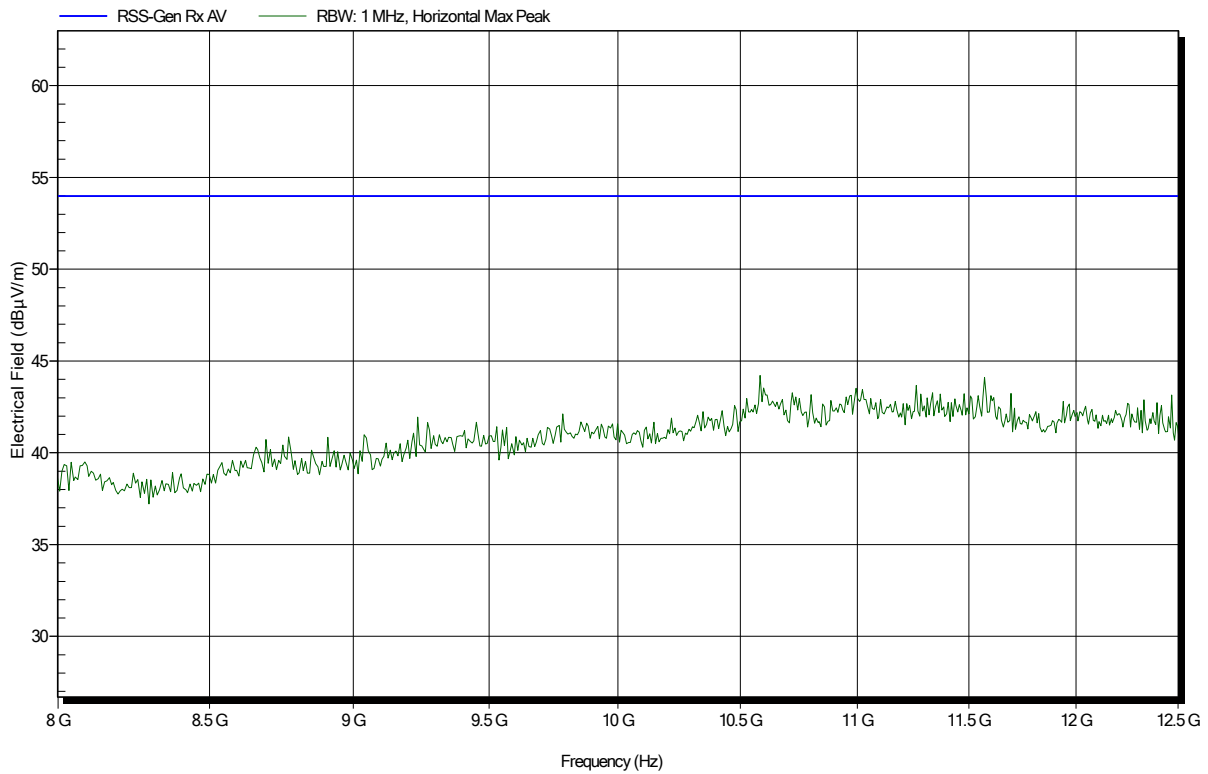

Spurious emissions according to RSS-Gen

Project number: G0M-2002-8805

Applicant: Laird Connectivity
 EUT Name: 915MHz LoRaWAN Gateway incl Wi-Fi, Ethernet & LTE - Indoor and IP67 variants

Model: RG191+LTE Series
 Test Site: Eurofins Product Service Germany
 Operator: Toralf Jahn
 Test Conditions: Tnom: 25°C, Vnom: 12 VDC via AC/DC-Adaptor
 Antenna: Schwarzbeck BBHA 9120D, Vertical
 Measurement distance: 1 m converted to 3m
 Mode: RX; 802.11 scan mode, Sample 29796
 Test Date: 2020-06-25
 Note:

Index 35

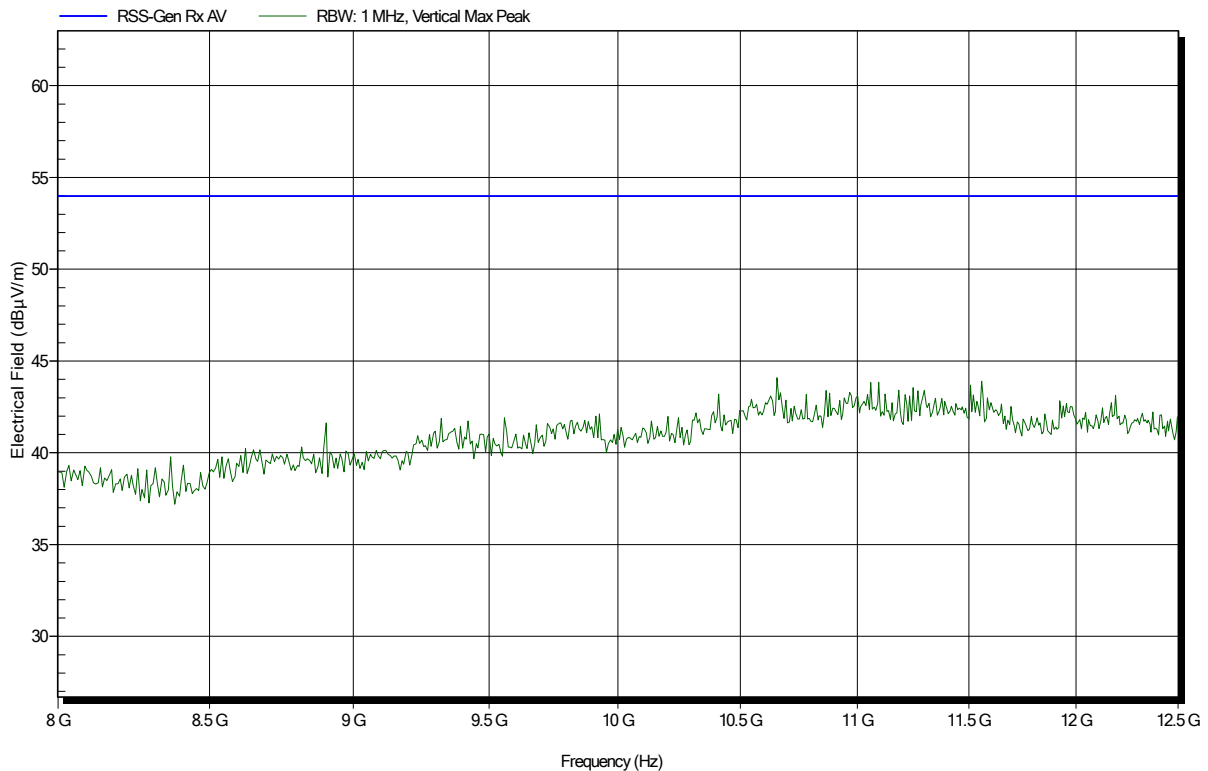

Spurious emissions according to RSS-Gen

Project number: G0M-2002-8805

Applicant: Laird Connectivity
 EUT Name: 915MHz LoRaWAN Gateway incl Wi-Fi, Ethernet & LTE - Indoor and IP67 variants

Model: RG191+LTE Series

Test Site: Eurofins Product Service Germany

Operator: Toralf Jahn

Test Conditions: Tnom: 25°C, Vnom: 12 VDC via AC/DC-Adaptor

Antenna: Schwarzbeck BBHA 9120D, Horizontal

Measurement distance: 1 m converted to 3m

Mode: RX; 802.11 scan mode, Sample 29796

Test Date: 2020-06-25

Note:

Index 32

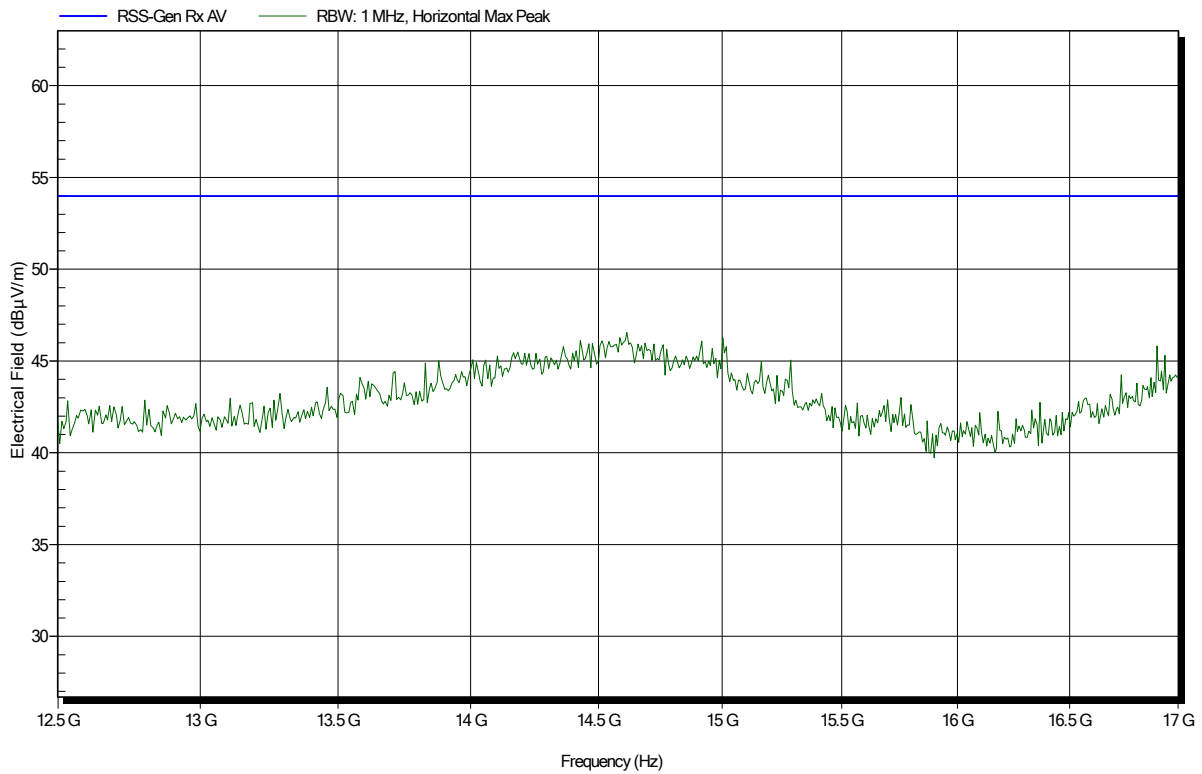

Spurious emissions according to RSS-Gen

Project number: G0M-2002-8805

Applicant: Laird Connectivity
 EUT Name: 915MHz LoRaWAN Gateway incl Wi-Fi, Ethernet & LTE - Indoor and IP67 variants

Model: RG191+LTE Series

Test Site: Eurofins Product Service Germany

Operator: Toralf Jahn

Test Conditions: Tnom: 25°C, Vnom: 12 VDC via AC/DC-Adaptor

Antenna: Schwarzbeck BBHA 9120D, Vertical

Measurement distance: 1 m converted to 3m

Mode: RX; 802.11 scan mode, Sample 29796

Test Date: 2020-06-25

Note:

Index 36

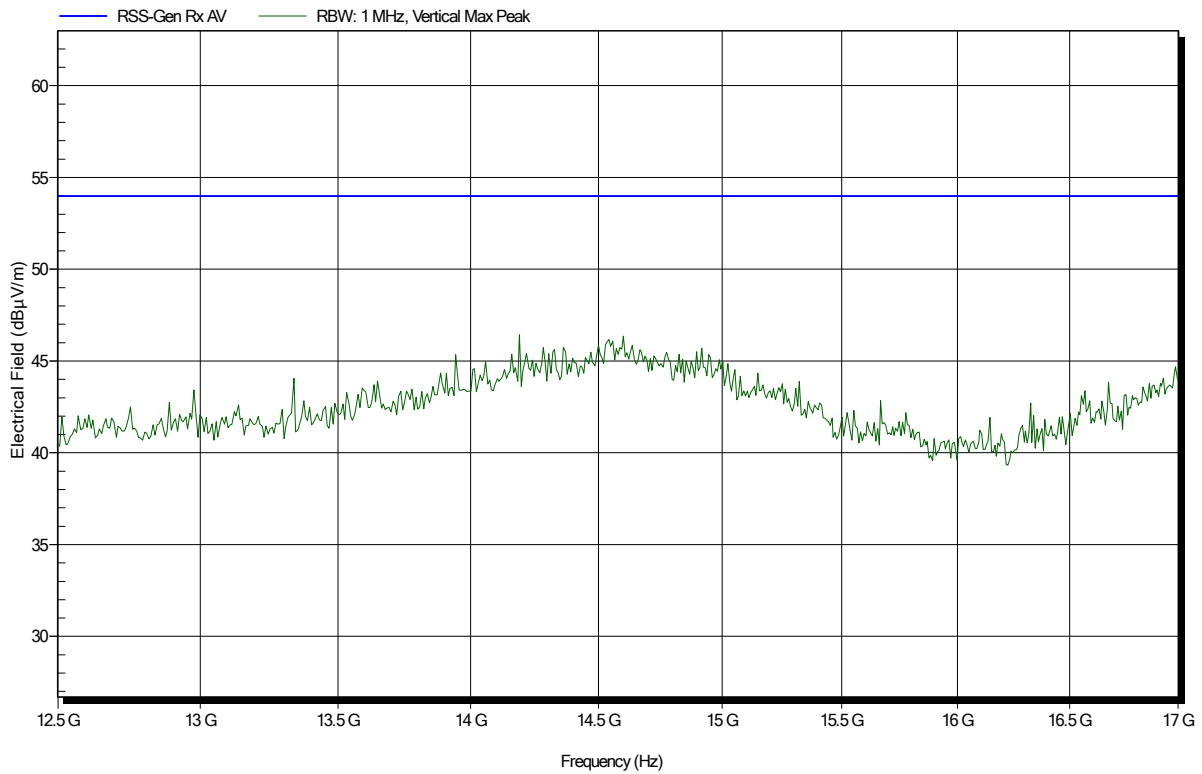

Spurious emissions according to RSS-Gen

Project number: G0M-2002-8805

Applicant: Laird Connectivity
 EUT Name: 915MHz LoRaWAN Gateway incl Wi-Fi, Ethernet & LTE - Indoor and IP67 variants

Model: RG191+LTE Series
 Test Site: Eurofins Product Service Germany
 Operator: Toralf Jahn
 Test Conditions: Tnom: 25°C, Vnom: 12 VDC via AC/DC-Adaptor
 Antenna: Amplifier Research AT4560, Horizontal
 Measurement distance: 1 m converted to 3m
 Mode: RX; 802.11 scan mode, Sample 29796
 Test Date: 2020-06-25
 Note:

Index 27

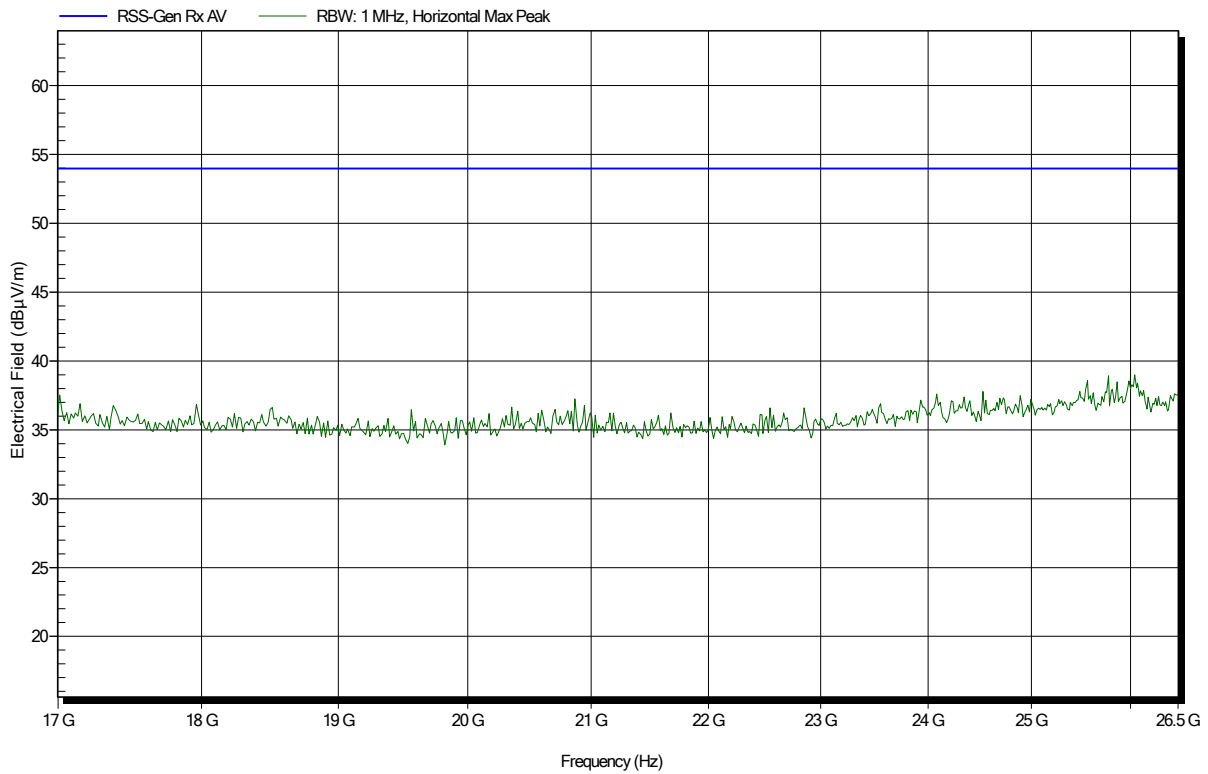

Spurious emissions according to RSS-Gen

Project number: G0M-2002-8805

Applicant: Laird Connectivity
 EUT Name: 915MHz LoRaWAN Gateway incl Wi-Fi, Ethernet & LTE - Indoor and IP67 variants

Model: RG191+LTE Series
 Test Site: Eurofins Product Service Germany
 Operator: Toralf Jahn
 Test Conditions: Tnom: 25°C, Vnom: 12 VDC via AC/DC-Adaptor
 Antenna: Amplifier Research AT4560, Vertical
 Measurement distance: 1 m converted to 3m
 Mode: RX; 802.11 scan mode, Sample 29796
 Test Date: 2020-06-25
 Note:

Index 28

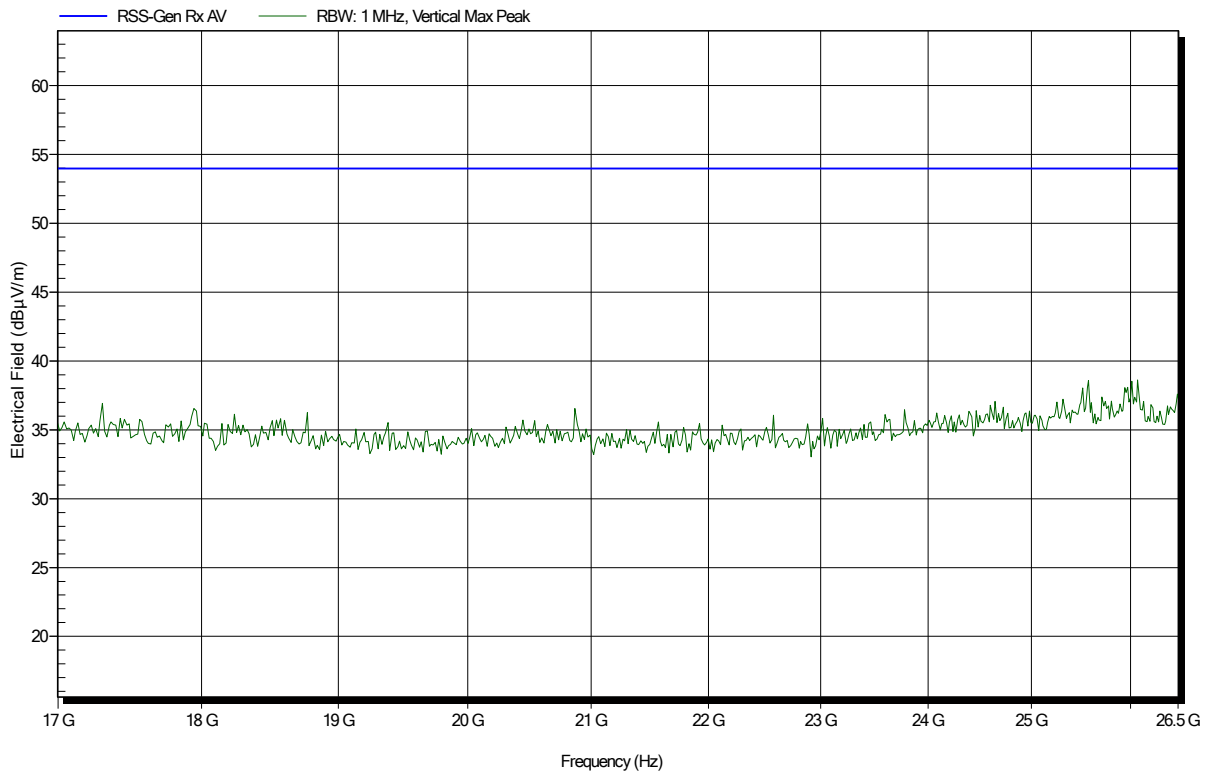

Spurious emissions according to RSS-Gen

Project number: G0M-2002-8805

Applicant: Laird Connectivity
 EUT Name: 915MHz LoRaWAN Gateway incl Wi-Fi, Ethernet & LTE - Indoor and IP67 variants

Model: RG191+LTE Series
 Test Site: Eurofins Product Service Germany
 Operator: Toralf Jahn
 Test Conditions: Tnom: 25°C, Vnom: 12 VDC via AC/DC-Adaptor
 Antenna: Flann Microwave Ltd 22240-25+CBL26402075, Horizontal
 Measurement distance: 1 m converted to 3m
 Mode: RX; 802.11 scan mode, Sample 29796
 Test Date: 2020-07-02
 Note:

Index 37

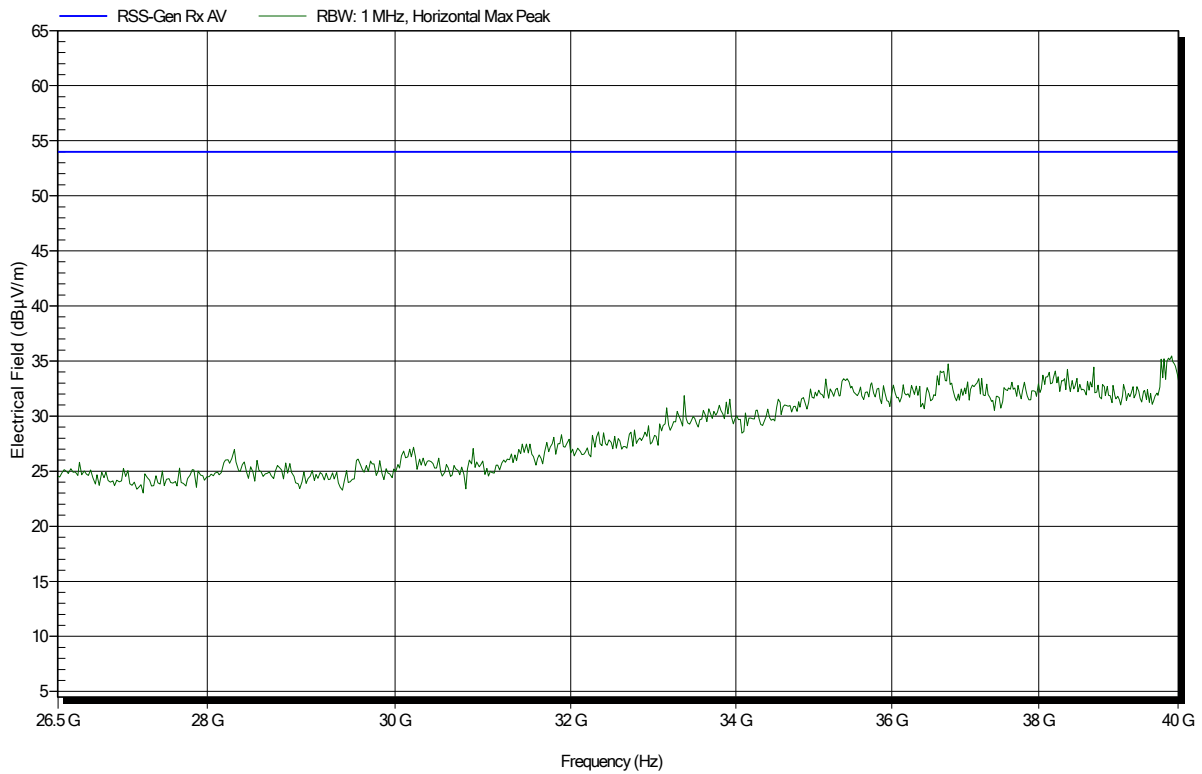

Spurious emissions according to RSS-Gen

Project number: G0M-2002-8805

Applicant: Laird Connectivity
 EUT Name: 915MHz LoRaWAN Gateway incl Wi-Fi, Ethernet & LTE - Indoor and IP67 variants

Model: RG191+LTE Series
 Test Site: Eurofins Product Service Germany
 Operator: Toralf Jahn
 Test Conditions: Tnom: 25°C, Vnom: 12 VDC via AC/DC-Adaptor
 Antenna: Flann Microwave Ltd 22240-25+CBL26402075, Vertical
 Measurement distance: 1 m converted to 3m
 Mode: RX; 802.11 scan mode, Sample 29796
 Test Date: 2020-07-02
 Note:

Index 38

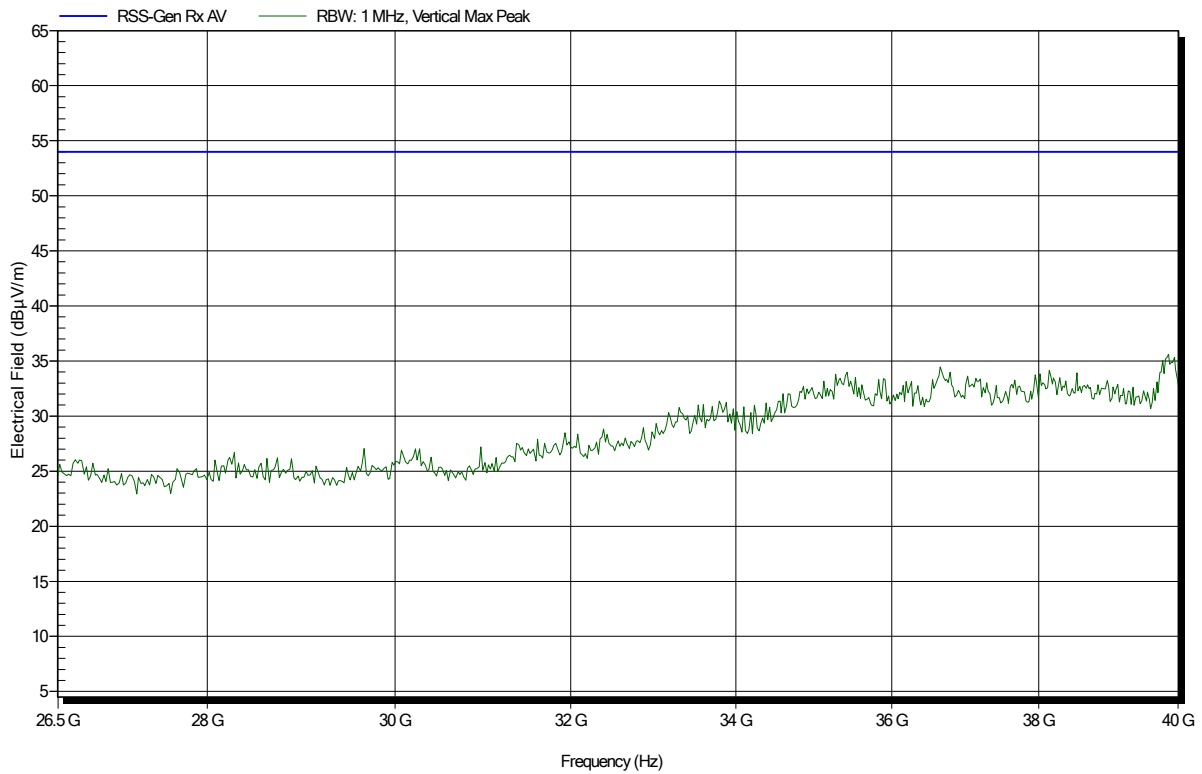

=== END OF TEST REPORT ===