

Datasheet

Pinnacle[™] 100 Cellular Modem

Version 1.8

REVISION HISTORY

Version	Date	Notes	Contributor(s)	Approver
1.0	11 Feb 2020	Initial Release	Mike Richter	Matt Stergiou
1.1	18 March 2020	Updated: Block Diagram, BLE RX Sensitivity, Bluetooth SIG Qualification	Mike Richter	Matt Stergiou
1.2	08 Apr 2020	Fixed typos and missing data	Mike Richter	Matt Stergiou
1.3	12 May 2020	Updated DoC	Ryan Urness	Matt Stergiou
1.4	09 Jun 2020	Updated DoC	Ryan Urness	Matt Stergiou
1.5	31 July 2020	Updated AT&T and PTCRB sections		Jonathan Kaye
1.6	13 Aug 2020	Add note regarding USB protection to the General Parameters Specifications section. Add HL7800 to nRF52840 UART Section.	Mike Richter	Jonathan Kaye
1.7	17 Oct 2020	Fixed table reference error	Rikki Horrigan	Jonathan Kaye
1.8	25 Nov 2020	Updated regulatory information; updated antenna information	Connie Lin	Jonathan Kaye

CONTENTS

1	Overview and Key Features	5
2	Specification	6
2.1	Specification Summary	6
2.2	Block Diagram	7
2.3	Pin Definitions	8
2.4	General Parameters	11
3	LTE Hardware Specifications	12
3.1	LTE RF Parameters	12
3.2	LTE Current	12
3.3	USB Interface Parameters	14
3.4	GPS Parameters	14
3.5	BAT_RTC	15
4	BLE Hardware Specifications	16
4.1	Programmability	17
4.1.1	Bootloader	17
4.1.2	Zephyr Hostless Firmware	17
4.1.3	Hosted Firmware	18
4.2	Electrical Specifications	18
4.3	BLE Power Consumption	19
4.4	Clocks and Timers	22
4.5	Radio Frequency (RF)	22
4.6	NFC	22
4.7	Primary UART Interface	24
4.8	HL7800 to nRF52840 UART interface	25
4.9	USB interface	25
4.10	SPI Bus	25
4.11	I2C Interface	26
4.12	General Purpose I/O, ADC, & PWM	26
4.12.1	GPIO	26
4.12.2	ADC	26
4.12.3	PWM Signal Output on Up to 16 SIO Pins	26
4.13	nRESET pin	27
4.14	Two-Wire Interface SWD	27
4.15	Pinnacle™ 100 Wakeup	28
4.15.1	Waking Up Pinnacle™ 100 from Host	28
4.16	Low Power Modes	28
4.17	Security/Privacy	28
4.17.1	Random Number Generator	28
4.17.2	AES Encryption/Decryption	28
4.17.3	ARM Cryptocell	28
4.17.4	Readback Protection	28
4.17.5	Elliptic Curve Cryptography	28
4.18	External 32.768 kHz crystal	28
5	Hardware Integration Suggestions	29
5.1	Circuit	29
5.2	PCB Layout on Host PCB - General	30
5.3	BLE Antenna Integration	31
5.4	LTE Antenna Integration	32
6	Mechanical Details	33
6.1	Pinnacle™ 100 Mechanical Details	33

6.2	PCI Express M2 Connector and Standoffs	34
6.3	Mounting Screw	34
6.4	Shipping.....	35
6.5	Modem Labeling.....	37
7	Regulatory.....	38
7.1	Regulatory IDs Summary	38
7.2	Certified Antennas.....	38
7.3	FCC Regulatory	39
7.4	ISED (Canada).....	41
7.5	EU Regulatory.....	43
7.5.1	EU Declarations of Conformity	46
8	Ordering Information.....	48
9	Bluetooth SIG Qualification.....	48
10	PTCRB.....	50
11	Global Certification Forum (GFC)	50
12	Carrier Certification.....	50
12.1	AT&T.....	50
12.2	Verizon (Pending)	50
12.3	Vodafone (Pending)	50
13	Additional Assistance	51

1 OVERVIEW AND KEY FEATURES

The Pinnacle™ 100 modem seamlessly incorporates a powerful Cortex M4F controller, full Bluetooth v5 and LTE CAT M1/NB-IoT capabilities – all with full regulatory certifications and LTE carrier approvals.

Develop your application directly on the M4F controller using Zephyr RTOS to cut BOM costs and power consumption. Take advantage of the Zephyr community, Laird Connectivity's sample code (cellular, Bluetooth) and hardware interfaces, OR use our hosted mode AT commands set that augments with commands that provide BLE, NFC and GPIO functionality.

This innovative modem family also offers complete antenna flexibility – on-device, off-board, as well as external antennas – to give you design flexibility, reduce complexity, and simplify your overall product solution.

Extremely power conscious, the Pinnacle™ 100 is ideal for battery-powered devices operating at the edge of your IoT networks, seamlessly bridging the cellular WAN to the BLE network. It's never been easier to bridge wireless Bluetooth 5 sensor data to cloud services like AWS IoT over a low-power LTE connection.



1.1 Features and Benefits

- **LTE-M / NB-IoT** radio via Sierra HL7800
 - **Altair ALT1250** – LTE bands 1, 2, 3, 4, 5, 8*, 12, 13, 20, 28
 - **Nordic nRF52840** – BT v5, Coded PHY (Long range), 1 MPHY & 2 MPHY
- Onboard Cortex-M4F Microcontroller – 32-bit @ 64 MHz, 256 KB of RAM, 1 MB internal flash, 8 MB QSPI**
- **Industrial Temp Range** – Operating range -40° to +85° C
- **Globally and Carrier Certified** – FCC, IC, CE, BT SIG plus PTCRB, GCF and **End Device** certified – AT&T, Verizon, Vodafone (all pending)
- **Flexible Programming** – Design your way: Hostless mode via Zephyr RTOS or Hosted mode AT Command Set
- **Secure Firmware Upgrade** – Comes pre-programmed with Laird Connectivity's secure bootloader
- **Antenna Options** – Unique integrated antenna variant plus external variant with U.FL connectors
- **Flexible Programming** – Design your way: Hostless mode via Zephyr RTOS or Hosted mode AT Command Set
- **Customisation** – Custom branding, packaging, application development all available.
- **BLE Rx sensitivity:** -93 dBm (1 Mbps), -101 dBm (125 kbps)

* – Band 8 supported by Laird Connectivity's Dipole Blade DBA6927C1-FSMAM antenna

** – When utilizing Bootloader, full 8 MB not available

1.2 Application Areas

- Cellular IoT
- Connected Medical
- Environmental Monitoring
- Predictive Maintenance
- Retail/Commercial

2 SPECIFICATION

2.1 Specification Summary

Table 1: Key specifications

Categories/Feature	Implementation
Wireless Specification	
Cellular LTE	<ul style="list-style-type: none"> ▪ Multi-Band cellular operation for world-wide operation ▪ Category M1 and category NB1 support ▪ Power class 3 ▪ Sensitivity: Cat-M1: -99 to -102 dBm (1.4 MHz BW, band-dependent)
Bluetooth®	<ul style="list-style-type: none"> ▪ BT 5.0 – Single mode ▪ 4x Range (CODED PHY support) – BT 5.0 ▪ 2x Speed (2M PHY support) – BT 5.0 ▪ LE Advertising Extensions – BT 5.0 ▪ Concurrent master, slave ▪ BLE Mesh capabilities ▪ Diffie-Hellman based pairing (LE Secure Connections) – BT 4.2 ▪ Data Packet Length Extension – BT 4.2 ▪ Link Layer Privacy (LE Privacy 1.2) – BT 4.2 ▪ LE Dual Mode Topology – BT 4.1 ▪ LE Ping – BT 4.1
Processor	<ul style="list-style-type: none"> ▪ 32-bit ARM® Cortex®-M4F @ 64 MHz ▪ Full-speed 12 Mbps USB controller ▪ +8 dBm BLE TX Power Setting ▪ -93 dBm BLE RX Sensitivity (1 Mbps) ▪ High speed SPI interface 32 MHz ▪ 12 bit/200K SPS ADC ▪ 128-bit AES/ECB/CCM/AAR co-processor

2.2 Block Diagram

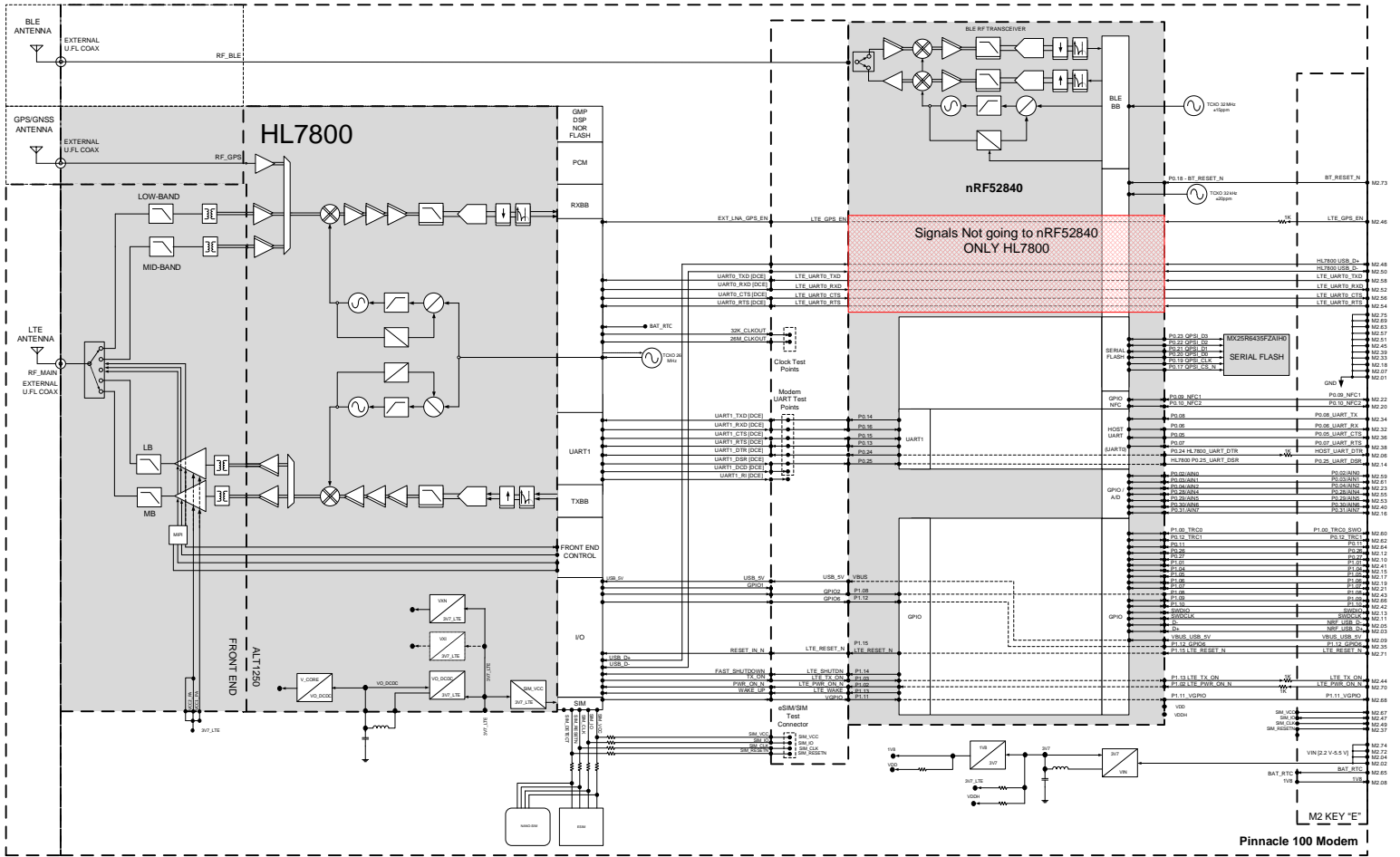

Figure 1: Pinnacle™ 100 block diagram

2.3 Pin Definitions

Table 2: Pin definitions

Pin #	Pin Name	Default Function	Alternate Function	Type	In/ Out	Pull Up/ Down	Voltage Domain	nRF52840 HL7800 Pin	nRF52840 QFN HL7800 Name	Comment
1	GND				COM				GND	
2	VIN				PI	IN	DC-DC			2.2V – 5.5V
3	NRF_USB_D+	D+			DIO	IN	NRF	AD6 -	D+ -	J10
4	VIN				PI	IN	DC-DC			2.2V – 5.5V
5	NRF_USB_D-	D-	-		DIO	IN	NRF	AD4 -	D- -	J10
6	HOST_UART1_D TR	UART1_DTR			DO		HL			None
7	GND				COM				GND	
8	1V8				PO	OUT	LDO	-	-	1.8V LDO IO Ref
9	USB_5V				PI	IN	NRF HL	AD2 C16	VBUS USB_VBUS	4.35V – 5.5V 4.75V – 5.25V
10	P0.27	P0.27			DIO	IN	PULL-UP	NRF	H2 -	P0.27 - I2C SCL
11	SWDCLK	SWDCLK			DIO	IN	PULL-DOWN	NRF	AA24 -	SWDCLK - SWDCLK
12	P0.26	P0.26			DIO	IN	PULL-UP	NRF	G1 -	P0.26 - I2C SDA
13	SWDIO	SWDIO			DIO	IN	PULL-UP	NRF	AC24 -	SWDIO - SWDIO
14	P0.25_UART1_D SR	UART1_DSR			DO	OUT	HL	AC21 C9	P0.25 UART1_DSR	
15	P1.04	P1.04			DIO	IN	PULL-UP	NRF	U24 -	P1.04 - LED1 (Blue)
16	P0.31_AIN7	P0.31	AIN7		DIO AIO	IN	PULL-UP	NRF	A8 -	P0.31/AIN7 - SW1
17	P1.05	P1.05			DIO	IN	PULL-UP	NRF	T23 -	P1.05 - LED2 (Green)
18	GND				COM				GND	
19	P1.06	P1.06			DIO	IN	PULL-UP	NRF	R24 -	P1.06 - LED3 (Red)
20	P0.10_NFC2	P0.10	NFC2		AIO	IN	NRF	J24 -	P0.10/NFC2 -	
21	P1.07	P1.07			DIO	IN	PULL-UP	NRF	P23 -	P1.07 - LED4 (Green)
22	P0.09_NFC1	P0.09	NFC1		AIO	IN	NRF	L24 -	P0.09/NFC1 -	
23	P0.04_AIN2	P0.04	AIN2		DIO AIO	IN	PULL-UP	NRF	J1 -	P0.04/AIN2 - SW3

Pin #	Pin Name	Default Function	Alternate Function	Type	In/Out	Pull Up/Down	Voltage Domain	nRF52840 HL7800 Pin	nRF52840 QFN HL7800 Name	Comment
24-31	Mech Key E									
32	HOST_UART_RX	UART_RX		DO	OUT		NRF	L1 -	P0.06 -	
33	GND			COM					GND	
34	HOST_UART_TX	UART_TX		DI	IN	PULL-UP	NRF	N1 -	P0.08 -	
35	P1.12_GPIO6			DO			HL	-	P1.12 GPIO6	
36	HOST_UART_CTS	UART_CTS		DO	OUT		NRF	K2 -	P0.05/AIN3 -	
37	SIM_RST			DO			HL	- C29	- UIM1_RESET	- Support Ext SIM
38	HOST_UART_RTS	UART_RTS		DI	IN		NRF	M2 -	P0.07/TRACECLK -	
39	GND			COM					GND	
40	P0.30_AIN6	P0.30	AIN6	DIO AIO			NRF	B9 -	P0.30/AIN6 -	
41	P1.01			DIO			NRF	Y23 -	P1.01 -	AUTORUN -
42	P1.10			DIO			NRF	A20 -	P1.10 -	
43	P1.08_GPIO2			DO			HL	P2 C10	P1.08 GPIO2	
44	TX_ON			DO	OUT		HL	V23 C60	P1.03 TX_ON	
45	GND			COM					GND	
46	GPS_LNA_EN			DI	IN		HL	- C43	- EXT_LNA_GPS_EN	
47	SIM_IO			DO			HL	- C28	- UIM1_DATA	- Support Ext SIM
48	HL_USB_D+			DIO			HL	- C13	- USB_D+	J7
49	SIM_CLK			DIO			HL	- C27	- UIM1_CLK	- Support Ext SIM
50	HL_USB_D-			DIO			HL	- C12	- USB_D-	J7
51	GND			COM					GND	
52	UART0_RX			DO			HL	- C55	- UART0_RX	- HL7800 Debug
53	P0.29_AIN5		AIN5	DIO AIO			NRF	A10 -	P0.29/AIN5 -	VIN_ADC
54	UART0_RTS			DI			HL	- C58	- UART0_RTS	- HL7800 Debug

Pin #	Pin Name	Default Function	Alternate Function	Type	In/Out	Pull Up/Down	Voltage Domain	nRF52840 HL7800 Pin	nRF52840 QFN HL7800 Name	Comment	
55	P0.28_AIN4			AIN4	DIO AIO			NRF	B11 -	P0.28/AIN4 -	VIN_ADC_EN
56	UART0_CTS				DO			HL	- C57	- UART0_CTS	- HL7800 Debug
57	GND				COM					GND	
58	UART0_TX				DI			HL	- C56	- UART0_TX	- HL7800 Debug
59	P0.02_AIN0	P0.02		AIN0	DIO AIO			NRF	A12 -	P0.02/AIN0 -	SW4
60	P1.00_TRC0_SW O	P1.00		TRC0	DIO			NRF	AD22 -	P1.00/TRACEDAT A0 -	
61	P0.03_AIN1	P0.03		AIN1	DIO AIO			NRF	B13 -	P0.03/AIN1 -	SW2
62	P0.12_TRC1	P0.12		TRC1	DIO			NRF	U1 -	P0.12/TRACEDAT A1 -	
63	GND				COM					GND	
64	P0.11_TRC2	P0.11		TRC2	DIO			NRF	T2 -	P0.11/TRACEDAT A2- -	
65	BAT_RTC				PI			HL	- C21	- BAT_RTC	
66	P1.09_TRC3	P1.09		TRC3	DIO			NRF	R1 -	P1.09/TRACEDAT A3 -	
67	1V8_SIM				PO			HL	- C26	- UIM1_VCC	- Support Ext SIM
68	P1.11_VGPIO	P1.11		VGPIO	DO			HL	B19 C45	P1.11 VGPIO	
69	GND				COM					GND	
70	nPWR_ON				DI			HL	W24 C59	P1.02 PWR_ON_N	
71	nLTE_RESET				DO			HL	A14 C11	P1.15 RESET_IN_N	
72	VIN				PI	IN		DC-DC	-	-	2.2V – 5.5V
73	nBT_RESET				DI			NRF	AC13 -	P0.18/nRESET -	-
74	VIN				PI	IN		DC-DC			2.2V – 5.5V
75	GND				COM					GND	

Note:

AI = Analog Input
 AO = Analog Output
 AIO = Analog Input/Output
 DI = Digital Input
 DO = Digital Output

Pin #	Pin Name	Default Function	Alternate Function	Type	In/Out	Pull Up/Down	Voltage Domain	nRF52840 HL7800 Pin	nRF52840 QFN HL7800 Name	Comment
-------	----------	------------------	--------------------	------	--------	--------------	----------------	---------------------	--------------------------	---------

DIO = Digital Input/Output
 PI = Power Supply Input
 PO = Power Supply Output
 COM = Common Ground

2.4 General Parameters

Table 3: General parameters

Parameter	Min	Typical	Max	Unit
VIN supply range	2.2	3.7	5.5	V
VBUS USB supply range	4.75	5.0	5.5	V
Antenna Options				
Integrated	<ul style="list-style-type: none"> LTE Bent Metal and PCB Trace monopole antenna – on-modem 453-00010 variant 			
External	<ul style="list-style-type: none"> LTE and BLE dipole antennas (with SMA and RPSMA connector) Flex carrier PCB antennas (with U.FL connector) 453-00011 variant. Connection via 3 U.FL 			
Physical				
Dimensions	PCI Express Key E Card Edge			
	453-00010	48.30 mm x 49.00 mm x 12.89 mm		
	453-00011	30.51 mm x 49.00 mm x 4.58 mm		
Weight	453-00010	9.7 g		
	453-00011	4.4 g		
Environmental				
Operating	-40 °C to +85 °C			
Storage	-40 °C to +125 °C			
Miscellaneous				
Lead Free	Lead-free and RoHS compliant			
Warranty	One-Year Warranty			
Development Tools				
Development Kit	Development kit per modem SKU (453-00010-K1 and 453-00011-K1)			
Approvals				
Bluetooth®	Full Bluetooth SIG Declaration ID			
FCC/IC/CE	<i>(Pending)</i>			
PTCRB/GFC	Pending, North America/EU <i>(Pending)</i>			
Carrier Certification	Verizon, AT&T, Vodafone <i>(Pending)</i>			

Note: Concerning the USB protection, customers should **always** add ESD protection to **any** interface that is exposed to the outside world. That being said, we do have a Panjit PE1605C2A_R1_00001 on the module at the M.2 connector for pins M.2-5 and M.2-3 as well as M2-50 and M2-48; there is no protection on M.2-9.

3 LTE HARDWARE SPECIFICATIONS

3.1 LTE RF Parameters

Table 4: LTE RF parameters

Parameter	Min	Typical	Max	Unit	
LTE Band Support	1, 2, 3, 4, 5, 8*, 12, 13, 20, 28				
Max LTE TX Power (25°)	21.5	23	24.5	dBm	
Rx Sensitivity (25°, 95% maximum throughput)	Band	M1	GGPP Limit	NB1	GGPP Limit
	1	-106			
	2	-106	-100.3	-114.5	-107.5
	3	-106			
	4	-105.5	-102.3	-114	-107.5
	5	-105	-100.8	-114	-107.5
	8	-105			
	12	-105	-99.3	-113.5	-107.5
	13	-105.5	-99.3	-114	-107.5
	20	-105	-98.3	-114	-107.5
	28	-105			

Note: The HL 7800 can support additional LTE Bands, but the antennas and the certifications **DO NOT**.

* Band 8 supported by Laird Connectivity's Dipole Blade DBA6927C1-FSMAM antenna

3.2 LTE Current

Table 5: LTE current parameters

Parameter @ 25C	2.2V Typ	3.7V Typ	5.5V Typ	Unit
LTE TX Average Current	550	250	200	mA
LTE TX Peak Current	950	650	600	mA
LTE RX Average Current		45		mA
LTE Hibernate		100		uA

3.2.1 Typical Currents in while connected to LTE network

Using the Hosted firmware, Figure 2, shows the modem's current profile @ 3.7V from boot to establishing a connection to a LTE Cat-M1 Network; Boot 33mA (Marker 1); TX Peak Current 320 mA, Avg Current 63.25mA. Figure 3, shows the Connected RX Average Current: 32.17mA; Peak: 127.68mA. For Low Power Operation see [CS-AN-Pinnacle-100-Low-Power-User Guide.pdf](#)



Figure 2: Pinnacle™ 100 Modem Current Profile for boot and establishing a connection



Figure 3: Pinnacle™ 100 Modem Connected RX Current

3.3 USB Interface Parameters

The HL7800 LTE module has one Universal Serial Bus Interface Full Speed to load firmware updates.

Table 6: USB interface parameters

Signal Name	M2 Pin No	I/O	Comments
D+	3	I/O	
D-	5	I/O	
VBUS	9		When using the Pinnacle™ 100 VBUS pin (which is mandatory when USB interface is used), you must externally connect a 4.7uF capacitor to ground. Note: MUST power the rest of Pinnacle™ 100 modem circuitry through the Vin 2.2-5.5V

Note: When the USB is used, the lowest power mode supported is Sleep mode.
VBUS must not be connected if Hibernate or Lite Hibernate mode is used.
These signals will be available in future firmware.

3.4 GPS Parameters

3.4.1 LTE_GPS_LNA_EN (M2.46)

The modem M2.46 pin is connected to HL7800 through a series 1K resistor.

Note: **This signal will be available in future firmware.**

3.4.2 GPS Performance

The HL7800 supports GPS L1 signal (1575.42 ± 20 MHz) and GLONASS L1 FDMA signals (1597.5 – 1605.8 MHz), with 50Ω connection to CON2 (U.FL). The following GPS Performance is **expected performance** and not based on measurement.

Table 7: GPS performance

Parameter	Conditions	Typical Value
Sensitivity	Cold Start	-146 dBm
	Hot Start	-152 dBm
	Tracking	-161 dBm
TTFF	Cold Start, Input Power -130 dBm	35 s
	Hot Start, Input Power -130 dBm	2 s
2D Position Error	Input Power -130 dBm	2.5 m
Module Current	Input Power -130 dBm	63.8 mA

Note: The GPS receiver shares the same RF resources as the 4G receiver. The end-device target should allow GPS positioning for asset management applications where infrequent and no real-time position updates are required.

3.5 BAT_RTC

The HL7800 has an input to connect a Real Time Clock power supply. This pin is used as a back-up power supply for the internal Real Time Clock. The RTC is supported when VIN is available, but a back-up power supply is needed to save date and hour when VIN is switched off.

Table 8 RTC battery parameters

Parameter	Min	Typical	Max	Unit
Input voltage	2.2	-	4.35	V
Input current consumption	-	-	10	µA

Note: This pin is input only and is not capable of charging a backup capacitor.

This signal will be available in future firmware

4 BLE HARDWARE SPECIFICATIONS

Table 9: nRF BLE parameters

General		
Frequency	2.402 - 2.480 GHz	
Raw Data Rates	1 Mbps BLE (over-the-air)	
	2 Mbps BLE (over-the-air)	
	125 kbps BLE (over-the-air)	
	500 kbps BLE (over-the-air)	
Maximum Transmit Power Setting	+8 dBm	Conducted 453-00010 (Integrated LTE & BLE antennas)
	+8 dBm	Conducted 453-00011 (3 U. FL, external antenna)
Minimum Transmit Power Setting	-40 dBm	
Additional Transmit Power Settings	-20 dBm, -16 dBm, -12 dBm, -8 dBm, -4 dBm, 0 dBm, 2 dBm, 3 dBm, 4 dBm, 5 dBm, 6 dBm, 7 dBm	
Receive Sensitivity (≤37byte packet)	BLE 1 Mbps (BER=1E-3)	-93 dBm typical
	BLE 2 Mbps	-92 dBm typical
	BLE 500 kbps	-97 dBm typical
	BLE 125 kbps	-101 dBm typical
Link Budget (conducted)	99 dB	@ BLE 1 Mbps
	107 dB	@ BLE 125 kbps

NFC

Based on NFC forum specification

- 13.56 MHz
- Data rate 106 kbps
- NFC Type2 and Type 4 emulation

Modes of Operation:

- Disable
- Sense
- Activated

Use Cases:

- Touch-to-Pair with NFC
- Standard Tag to exchange; EX: url Launcher

NFC enabled Out-of-Band Pairing

- Proximity Detection

Host Interfaces and Peripherals

Total 18 x multifunction I/O lines

- 1 UART (second UART interface connected to HL7800 internally)

- UART**
- Tx, Rx, CTS, RTS
 - Default 115200, n, 8, 1
 - From 1,200 bps to 1 Mbps

- USB**
- USB 2.0 FS (Full Speed, 12Mbps).
 - CDC driver / Virtual UART

- GPIO**
- Up to 18, configurable by firmware:
- I/O direction
 - O/P drive strength (standard 0.5 mA or high 3 mA)
 - Pull-up /pull-down
 - Input buffer disconnect

ADC	<ul style="list-style-type: none"> ▪ Seven 8/10/12-bit channels ▪ 0.6 V internal reference ▪ Configurable 4, 2, 1, 1/2, 1/3, 1/4, 1/5, 1/6 (default) pre-scaling ▪ Configurable acquisition time 3uS, 5uS, 10uS (default), 15uS, 20uS, 40uS ▪ One-shot mode
PWM Output	<p>PWM outputs on 16 GPIO output pins.</p> <ul style="list-style-type: none"> ▪ PWM output duty cycle: 0%-100% <p>PWM output frequency: Up to 500 kHz</p>
I2C	<ul style="list-style-type: none"> ▪ Two I2C interface (up to 400 kbps)
SPI	Four SPI Master Slave interface (up to 4 Mbps)
QSPI	Not Available, Modem contains 8Mbit x 4 (64 Mbit) IC
Temperature Sensor	<ul style="list-style-type: none"> ▪ One temperature sensor ▪ Temperature range equal to the operating temperature range ▪ Resolution 0.25°, Accuracy +/- 5°C
RSSI Detector	<ul style="list-style-type: none"> ▪ One RF received signal strength indicator ▪ ±2 dB accuracy (valid over -90 to -20 dBm) ▪ One dB resolution
I2S	One inter-IC sound interface
PDM	One pulse density modulation interface
External 32.768 kHz crystal	For more accurate timing
Profiles	
Services supported	<ul style="list-style-type: none"> ▪ Central mode ▪ Peripheral mode ▪ Mesh (with custom models) <p>Custom and adopted profiles</p>
Programmability	
Zephyr or AT command Set	via SWD
Operating Modes	
Zephyr or AT command Set	Per examples
Power Consumption	
Active Modes Average Current (for maximum Tx power +8 dBm)	14.4 mA peak Tx @ 3.7V
Active Modes Average Current (for Tx power -40 dBm)	6.8 mA peak Tx @ 3.7V

4.1 Programmability

4.1.1 Bootloader

The modem comes with a secure bootloader.

4.1.2 Zephyr Hostless Firmware

The Zephyr firmware provides a hostless example code used for the Out of Box demo (OOB). The modem is capable of taking readings from external BLE sensor and sending data to AWS.

4.1.3 Hosted Firmware

The Hosted firmware provides a hosted example code.

4.2 Electrical Specifications

4.2.1 Recommended Operating Parameters

Table 10: Signal levels for interface, SIO

Parameter	Min	Typical	Max	Unit
V _{IH} Input high voltage	0.7 x 1.8V		1.8V	V
V _{IL} Input low voltage	VSS		0.3 x 1.8V	V
V _{OH} Output high voltage (std. drive, 0.5mA) (high drive, 3mA)	1.8V -0.4 1.8V -0.4		1.8V 1.8V	V
V _{OL} Output low voltage (std. drive, 0.5mA) (high drive, 3mA)	VSS VSS		VSS+0.4 VSS+0.4	V
V _{OL} Current at VSS+0.4V, Output set low (std. drive, 0.5mA) (high drive, 3mA)	1 3	2 -	4 -	mA mA
V _{OL} Current at 1.8V -0.4, Output set low (std. drive, 0.5mA) (high drive, 3mA)	1 3	2 -	4 -	mA mA
Pull up resistance	11	13	16	kΩ
Pull down resistance	11	13	16	kΩ
Pad capacitance		3		pF
Pad capacitance at NFC pads		4		pF

Table 11: SIO pin alternative function AIN (ADC) specification

Parameter	Min	Typical	Max	Unit
Maximum sample rate			200	kHz
ADC Internal reference voltage	-1.5%	0.6 V	+1.5%	%
ADC pin input internal selectable scaling		4, 2, 1, 1/2, 1/3, 1/4, 1/5, 1/6		scaling
ADC input pin (AIN) voltage maximum without damaging ADC w.r.t (see Note 1) VCC Prescaling 0V-1.8V	4, 2, 1, ½, 1/3, ¼, 1/5, 1/6	1.8V+0.3		V
Configurable Resolution	8-bit mode	10-bit mode	12-bit mode	bits
Configurable (see Note 2)				
Acquisition Time, source resistance ≤10 kΩ		3		µS
Acquisition Time, source resistance ≤40 kΩ		5		µS
Acquisition Time, source resistance ≤100 kΩ		10		µS
Acquisition Time, source resistance ≤200 kΩ		15		µS
Acquisition Time, source resistance ≤400 kΩ		20		µS
Acquisition Time, source resistance ≤800 kΩ		40		µS
Conversion Time (see Note 3)		<2		µS

Parameter	Min	Typical	Max	Unit
Maximum sample rate			200	kHz
ADC input impedance (during operation) (see Note 3)				
Input Resistance		>1		MOhm
Sample and hold capacitance at maximum gain		2.5		pF

Recommended Operating Parameters Notes:

Note 1	Stay within internal 0.6 V reference voltage with given pre-scaling on AIN pin and do not violate ADC maximum input voltage 1.8V (for damage).
Note 2	Firmware allows configurable resolution (8-bit, 10-bit, or 12-bit mode) and acquisition time. Pinnacle™ 100 ADC is a Successive Approximation type ADC (SSADC), as a result no external capacitor is needed for ADC operation. Configure the acquisition time according to the source resistance that customer has. The sampling frequency is limited by the sum of sampling time and acquisition time. The maximum sampling time is 2us. For acquisition time of 3us the total conversion time is therefore 5us, which makes maximum sampling frequency of 1/5us = 200kHz. Similarly, if acquisition time of 40us chosen, then the conversion time is 42us and the maximum sampling frequency is 1/42us = 23.8kHz.
Note 3	ADC input impedance is estimated mean impedance of the ADC (AIN) pins.

4.3 BLE Power Consumption

Table 12: BLE Power consumption

Parameter	2.2V Typ	3.7V Typ	5.5V Typ	Unit
Active mode 1Mbps ‘avg’ current (Note 1)	DCDC [LDO]	DCDC [LDO]	DCDC [LDO]	
(Advertising or Connection)				
Tx only run peak current @ Pwr Step = +8 dBm	25.4 [50.3]	14.4 [28.5]	12.0 [23.0]	mA
Tx only run peak current @ Pwr Step= +7 dBm	23.5 [46.5]	13.5 [27.0]	11.4 [21.3]	mA
Tx only run peak current @ Pwr Step= +6 dBm	22.4 [44.3]	12.7 [25.1]	11.0 [20.1]	mA
Tx only run peak current @ Pwr Step= +5 dBm	20.5 [40.7]	11.7 [22.8]	10.2 [18.8]	mA
Tx only run peak current @ Pwr Step= +4 dBm	19.7 [38.9]	11.6 [21.6]	9.9 [17.7]	mA
Tx only run peak current @ Pwr Step= +3 dBm	18.8 [36.7]	10.9 [20.3]	9.2 [17.1]	mA
Tx only run peak current @ Pwr Step= +2 dBm	17.6 [34.2]	10.2 [18.8]	8.8 [15.7]	mA
Tx only run peak current @ Pwr Step = 0 dBm	14.2 [25.7]	8.5 [14.4]	7.5 [12.0]	mA
Tx only run peak current @ Pwr Step = -4 dBm	13.1 [22.7]	7.4 [12.9]	7.0 [11.3]	mA
Tx only run peak current @ Pwr Step = -8 dBm	12.5 [21.5]	7.3 [12.6]	6.8 [10.4]	mA
Tx only run peak current @ Pwr Step = -12 dBm	12.2 [20.5]	7.2 [11.9]	6.7 [10.3]	mA
Tx only run peak current @ Pwr Step = -16 dBm	11.8 [19.8]	7.2 [11.1]	6.6 [9.9]	mA
Tx only run peak current @ Pwr Step = -20 dBm	11.7 [19.4]	7.1 [11.2]	6.4 [9.4]	mA
Tx only run peak current @ Pwr Step = -40 dBm	11.2 [17.9]	6.8 [10.5]	6.3 [9.2]	mA
Active mode 2Mbps ‘avg’ current (Note 1)	DCDC [LDO]	DCDC [LDO]	DCDC [LDO]	
(Advertising or Connection)				
Tx only run peak current @ Pwr Step = +8 dBm	17.5 [32.0]	10.3 [18.3]	8.9 [15.3]	mA
Tx only run peak current @ Pwr Step= +7 dBm	16.7 [30.0]	9.5 [17.2]	8.6 [14.2]	mA
Tx only run peak current @ Pwr Step= +6 dBm	15.9 [28.9]	9.3 [16.2]	8.2 [13.6]	mA
Tx only run peak current @ Pwr Step= +5 dBm	15.0 [27.0]	8.9 [15.2]	7.9 [12.9]	mA
Tx only run peak current @ Pwr Step= +4 dBm	14.7 [25.9]	8.7 [14.6]	7.7 [12.3]	mA
Tx only run peak current @ Pwr Step= +3 dBm	14.0 [24.7]	8.1 [14.1]	7.6 [12.1]	mA
Tx only run peak current @ Pwr Step= +2 dBm	13.3 [23.4]	7.9 [13.2]	7.1 [11.5]	mA

Parameter	2.2V Typ	3.7V Typ	5.5V Typ	Unit
Tx only run peak current @ Pwr Step = 0 dBm	11.5 [19.3]	6.9 [11.0]	6.4 [9.5]	mA
Tx only run peak current @ Pwr Step = -4 dBm	10.8 [17.5]	6.3 [10.0]	6.1 [9.1]	mA
Tx only run peak current @ Pwr Step = -8 dBm	10.8 [17.0]	6.5 [9.7]	6.1 [8.8]	mA
Tx only run peak current @ Pwr Step = -12 dBm	10.5 [16.3]	6.3 [9.9]	6.0 [8.5]	mA
Tx only run peak current @ Pwr Step = -16 dBm	10.4 [16.0]	6.3 [9.2]	6.0 [8.3]	mA
Tx only run peak current @ Pwr Step = -20 dBm	10.4 [15.9]	6.2 [9.2]	5.9 [8.4]	mA
Tx only run peak current @ Pwr Step = -40 dBm	10.0 [14.9]	6.1 [9.0]	5.9 [8.0]	mA
Active mode 500Kbps 'avg' current (Note 1)	DCDC [LDO]	DCDC [LDO]	DCDC [LDO]	
(Advertising or Connection)				
Tx only run peak current @ Pwr Step = +8 dBm	23.4 [46.1]	13.1 [26.2]	11.1 [21.2]	mA
Tx only run peak current @ Pwr Step= +7 dBm	21.3 [42.7]	12.2 [24.0]	10.6 [19.8]	mA
Tx only run peak current @ Pwr Step= +6 dBm	20.4 [40.8]	11.5 [22.8]	10.4 [18.7]	mA
Tx only run peak current @ Pwr Step= +5 dBm	18.6 [37.2]	10.9 [20.8]	9.6 [17.0]	mA
Tx only run peak current @ Pwr Step= +4 dBm	17.9 [36.0]	10.2 [19.7]	9.0 [16.0]	mA
Tx only run peak current @ Pwr Step= +3 dBm	17.0 [33.9]	10.0 [18.8]	8.8 [16.0]	mA
Tx only run peak current @ Pwr Step= +2 dBm	16.1 [31.5]	9.3 [17.3]	8.3 [14.5]	mA
Tx only run peak current @ Pwr Step = 0 dBm	12.8 [23.6]	7.5 [13.4]	7.0 [11.4]	mA
Tx only run peak current @ Pwr Step = -4 dBm	11.7 [20.8]	7.2 [11.9]	6.5 [10.3]	mA
Tx only run peak current @ Pwr Step = -8 dBm	11.1 [19.9]	6.8 [11.0]	6.5 [9.7]	mA
Tx only run peak current @ Pwr Step = -12 dBm	11.0 [18.7]	6.6 [10.9]	6.3 [9.4]	mA
Tx only run peak current @ Pwr Step = -16 dBm	10.7 [18.4]	6.6 [10.7]	6.2 [9.3]	mA
Tx only run peak current @ Pwr Step = -20 dBm	10.6 [17.8]	6.4 [10.4]	6.1 [9.2]	mA
Tx only run peak current @ Pwr Step = -40 dBm	10.0 [16.5]	6.2 [9.7]	6.0 [8.7]	mA
Active mode 125Kbps 'avg' current (Note 1)	DCDC [LDO]	DCDC [LDO]	DCDC [LDO]	
(Advertising or Connection)				
Tx only run peak current @ Pwr Step = +8 dBm	30.7 [61.3]	17.2 [34.7]	14.2 [27.8]	mA
Tx only run peak current @ Pwr Step= +7 dBm	27.9 [56.6]	15.8 [31.7]	13.1 [24.8]	mA
Tx only run peak current @ Pwr Step= +6 dBm	26.4 [53.6]	14.8 [29.8]	12.5 [23.7]	mA
Tx only run peak current @ Pwr Step= +5 dBm	24.1 [48.8]	13.6 [27.1]	11.4 [21.6]	mA
Tx only run peak current @ Pwr Step= +4 dBm	22.9 [46.5]	12.9 [25.8]	11.1 [20.8]	mA
Tx only run peak current @ Pwr Step= +3 dBm	21.5 [44.0]	12.3 [24.0]	10.5 [19.7]	mA
Tx only run peak current @ Pwr Step= +2 dBm	20.1 [40.6]	11.5 [22.1]	10.1 [17.8]	mA
Tx only run peak current @ Pwr Step = 0 dBm	15.7 [29.0]	9.1 [16.1]	8.0 [13.5]	mA
Tx only run peak current @ Pwr Step = -4 dBm	14.0 [25.2]	8.2 [13.9]	7.3 [11.8]	mA
Tx only run peak current @ Pwr Step = -8 dBm	13.4 [23.4]	8.0 [13.6]	7.1 [11.4]	mA
Tx only run peak current @ Pwr Step = -12 dBm	12.7 [21.2]	7.7 [12.7]	6.8 [10.7]	mA
Tx only run peak current @ Pwr Step = -16 dBm	12.8 [21.2]	7.6 [12.2]	6.8 [10.5]	mA
Tx only run peak current @ Pwr Step = -20 dBm	12.4 [20.8]	7.5 [11.8]	6.6 [10.0]	mA
Tx only run peak current @ Pwr Step = -40 dBm	11.8 [19.0]	7.2 [10.8]	6.3 [9.1]	mA
Active Mode	DCDC [LDO]	DCDC [LDO]	DCDC [LDO]	
Rx only 'avg' current, BLE 1Mbps (Note 1)	8.5[14.2]	9.6[16.9]	16.4[30.5]	mA
Rx only 'avg' current, BLE 2Mbps (Note 2)	9.0[15.2]	10.1[18.2]	17.4[33.0]	mA
Rx only 'avg' current, BLE 500Kbps (Note 2)	8.6[14.0]	9.4[16.6]	16.1[29.9]	mA
Rx only 'avg' current, BLE 125Kbps (Note 2)	8.3[14.0]	9.5[16.6]	16.2[29.8]	mA
Ultra-Low Power Mode 1 (Note 2)				uA
Standby Doze, 256k RAM retention				

Parameter	2.2V Typ	3.7V Typ	5.5V Typ	Unit
Ultra-Low Power Mode 2 (Note 3) Deep Sleep (no RAM retention)				uA
Active Mode Average current (Note 4)				
Advertising Average Current draw				
Max , with advertising interval (min) 20 mS		Note 4		uA
Min , with advertising interval (max) 10240 mS		Note 4		uA
Connection Average Current draw				
Max , with connection interval (min) 7.5 mS		Note 4		uA
Min , with connection interval (max) 4000 mS		Note 4		uA

Power Consumption Notes:

Note 1	This is for avg Radio Current only.
Note 2	Pinnacle™ 100 BLE chipset Standby Doze is 100 uA typical. Depending on active peripherals, current consumption ranges from 100 µA to 370 uA (when UART is ON). The Pinnacle™ 100 Standby Doze current consists of the below nRF52840 blocks:
Note 3	In Deep Sleep, everything is disabled and the only wake-up sources (including NFC to wakeup) are reset and changes on SIO or NFC pins on which sense is enabled. The current consumption seen is ~65 uA typical in Pinnacle™ 100 modems. <ul style="list-style-type: none"> Coming out from Deep Sleep to Standby Doze through the reset vector.
Note 4	Average current consumption depends on several factors (including Tx power, VCC, and accuracy of 32MHz and 32.768 kHz crystals). With these factors fixed, the largest variable is the advertising or connection interval set. Advertising Interval range: <ul style="list-style-type: none"> 20 milliseconds to 10240 mS (10485759.375 mS in BT5.0) in multiples of 0.625 milliseconds. For an advertising event: <ul style="list-style-type: none"> The minimum average current consumption is when the advertising interval is large 10240 mS (10485759.375 mS (in BT5.0) although this may cause long discover times (for the advertising event) by scanners The maximum average current consumption is when the advertising interval is small 20 mS Other factors that are also related to average current consumption include the advertising payload bytes in each advertising packet and whether it's continuously advertising or periodically advertising. Connection Interval range (for a peripheral): <ul style="list-style-type: none"> 7.5 milliseconds to 4000 milliseconds in multiples of 1.25 milliseconds. For a connection event (for a peripheral device): <ul style="list-style-type: none"> The minimum average current consumption is when the connection interval is large 4000 milliseconds The maximum average current consumption is with the shortest connection interval of 7.5 ms; no slave latency. Other factors that are also related to average current consumption include: <ul style="list-style-type: none"> Number packets per connection interval with each packet payload size An inaccurate 32.768 kHz master clock accuracy would increase the average current consumption. Connection Interval range (for a central device): <ul style="list-style-type: none"> 2.5 milliseconds to 40959375 milliseconds in multiples of 1.25 milliseconds.

4.4 Clocks and Timers

4.4.1 Clocks

The integrated high accuracy 32 MHz (± 10 ppm) crystal oscillator helps with radio operation and reducing power consumption in the active modes.

A 32.768 kHz (± 20 ppm) crystal is also available for more accurate real time clock.

4.5 Radio Frequency (RF)

- 2402–2480 MHz Bluetooth Low Energy radio BT5.0 – 1 Mbps, 2 Mbps, and Long-range (125 kbps and 500 kbps) over-the-air data rate.
- Tx output programmable power steps include 8 dBm, 7dBm, 6dBm, 5dBm, 4dBm, 3dBm, 2dBm, 0dBm and further down to -20 dBm in steps of 4 dB and final TX power level of -40 dBm. The Pout of the modem will be 1-2 dB lower than the Power setting due to the Insertion Loss of a Bandpass filter.
- Receiver (with integrated channel filters) to achieve maximum sensitivity: -93 dBm @ 1 Mbps BLE, -92 dBm @ 2 Mbps, -97 dBm @ 500 kbps long-range, and -101 dBm @ 125 kbps long-range).
- RF conducted interface available with 453-00011 modem via the U.FL RF connectors: LTE, GPS, and BLE
- Antenna options:
 - Integrated PCB trace antenna on the 453-00010
 - External antenna connected with 3 U.FL connectors on the 453-00011
- Received Signal Strength Indicator (RSSI)
- RSSI accuracy (valid range -90 to -20 dBm) is ± 2 dB typical
- RSSI resolution 1 dB typical

4.6 NFC

NFC support:

- Based on the NFC forum specification
 - 13.56 MHz
 - Data rate 106 kbps
 - NFC Type2 and Type4 tag emulation
- Modes of operation
 - Disable
 - Sense
 - Activated

4.6.1 Use Cases

- Touch-to Pair with NFC
- Launch a smartphone app (on Android)
- NFC enabled Out-of-Band Pairing
- System Wake-On-Field function
- Proximity Detection

Table 13: NFC interface

Signal Name	M2 Pin No	I/O	Comments
NFC1/SIO_09	22	I/O	The NFC pins are by default GPIO and must be configured in firmware.
NFC2/SIO_10	20	I/O	

4.6.2 NFC Antenna Coil Tuning Capacitors

From Nordic's *nRF52840 Objective Product Specification v1.0*: http://infocenter.nordicsemi.com/pdf/nRF52840_PS_v1.0.pdf

The NFC antenna coil must be connected differential between the NFC1 and NFC2 pins of the Pinnacle™ 100. Two external capacitors should be used to tune the resonance of the antenna circuit to 13.56 MHz (*Figure 4*).

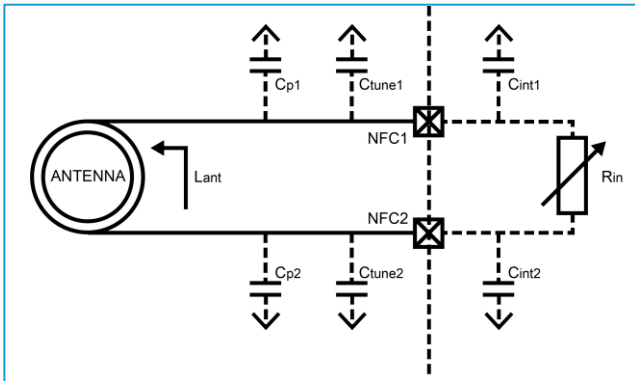

Figure 4: NFC antenna coil tuning capacitors

The required external tuning capacitor value is given by the following equations:

$$C_{tune} = \frac{2}{(2\pi \cdot 13.56 \text{ MHz})^2 \cdot L_{ant}} - C_{tune} - C_{int}$$

An antenna inductance of $L_{ant} = 0.72 \mu\text{H}$ provides tuning capacitors in the range of 300 pF on each pin. The total capacitance on NFC1 and NFC2 must be matched. C_{int} and C_p are small usually (C_{int} is 4pF), so can omit from calculation.

Battery Protection Note: If the NFC coil antenna is exposed to a strong NFC field, the supply current may flow in the opposite direction due to parasitic diodes and ESD structures.

If the used battery does not tolerate a return current, a series diode must be placed between the battery and the Pinnacle™ 100 to protect the battery.

4.7 Primary UART Interface

Note: The Pinnacle™ 100 has two UARTs.

The Universal Asynchronous Receiver/Transmitter (UART) offers fast, full-duplex, asynchronous serial communication with built-in flow control support (UART_CTS, UART_RTS) in HW up to one Mbps baud. Parity checking and generation for the ninth data bit are supported.

UART_TX, UART_RX, UART_RTS, and UART_CTS form a conventional asynchronous serial data port with handshaking. The interface is designed to operate correctly when connected to other UART devices such as the 16550A. The signaling levels are nominal 0 V and 1.8 V and are inverted with respect to the signaling on an RS232 cable.

Two-way hardware flow control is implemented by UART_RTS and UART_CTS. UART_RTS is an output and UART_CTS is an input. Both are active low.

These signals operate according to normal industry convention. UART_RX, UART_TX, UART_CTS, and UART_RTS are all 1.8V level logic. For example, when RX and TX are idle they sit at 1.8 V. Conversely for handshaking pins, CTS and RTS, at 0 V is treated as an assertion.

The modem communicates with the customer application using the following signals:

- Port/TxD of the application sends data to the modem's UART_RX signal line
- Port/RxD of the application receives data from the modem's UART_TX signal line

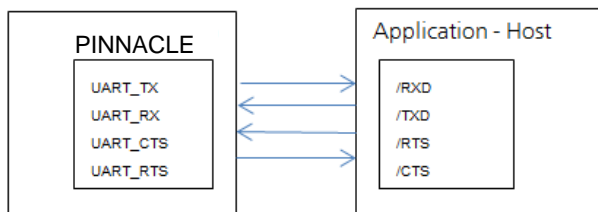

Figure 5: UART signals

Note: The Pinnacle™ 100 serial modem output is at 1.8V logic levels. Level conversion must be added to interface with an RS-232 level compliant interface.

Some serial implementations link CTS and RTS to remove the need for handshaking. We do not recommend linking CTS and RTS other than for testing and prototyping. If these pins are linked and the host sends data at the point that the Pinnacle™ 100 de-asserts its RTS signal, there is significant risk that internal receive buffers will overflow, which could lead to an internal processor crash. This will drop the connection and may require a power cycle to reset the modem. We recommend that the correct CTS/RTS handshaking protocol be adhered to for proper operation.

Table 14: UART interface

Signal Name	M2 Pin No	I/O	Comments
SIO_06 / UART_Tx	34	O	SIO_06 (alternative function UART_Tx) is an output, set high (in firmware).
SIO_08 / UART_Rx	32	I	SIO_08 (alternative function UART_Rx) is an input, set with internal pull-up (in firmware).
SIO_05 / UART_RTS	38	O	SIO_05 (alternative function UART_RTS) is an output, set low (in firmware).
SIO_07 / UART_CTS	36	I	SIO_07 (alternative function UART_CTS) is an input, set with internal pull-down (in firmware).

4.8 HL7800 to nRF52840 UART interface

The UART between the HL7800 and NRF52840 consists of the following signals: TXD, RXD, CTS, RTS, DTR, DSR, DCD & RI. The signals are available on a non-populated header J2. The Digi-Key Part number: [S9014E-06-ND](#), which is a Sullins Connector Solutions; GRPB061VWVN-RC; CONN HEADER VERT 6POS 1.27MM, that can be solder to the modem to provide access to the UART lines.

Table 15: UART interface

J2 Pin # net	HL7800	nRF52840	Comments
1	UART1_DCD	-	
2	UART1_DTR	P0.24	SIO_24 is an output, set high (in firmware).
3	UART1_RX	P0.16	SIO_16 is an input, set with internal pull-up (in firmware).
4	UART1_TX	P0.14	SIO_14 is an output, set high (in firmware).
5	UART1_CTS	P0.15	SIO_15 is an input, set with internal pull-down (in firmware).
6	UART1_RTS	P0.13	SIO_13 is an output, set low (in firmware).
-	UART1_DSR	P0.25	SIO_25 is an input, set with internal pull-up (in firmware).
-	UART1_RI	-	TP1 on Top of Pinnacle™ 100 next to J2

4.9 USB interface

Pinnacle™ 100 has USB2.0 FS (Full Speed, 12Mbps) hardware capability.

Table 16: USB interface

Signal Name	M2 Pin No	I/O	Comments
D+	3	I/O	
D-	5	I/O	
VBUS	9		When using the Pinnacle™ 100 VBUS pin (which is mandatory when USB interface is used), MUST connect externally a 4.7uF capacitor to ground. Note: MUST power the rest of Pinnacle™ 100 modem circuitry through the Vin = 2.2 - 5.5V

4.10 SPI Bus

The SPI interface is an alternate function on SIO pins.

The modem is a master device that uses terminals SPI_MOSI, SPI_MISO, and SPI_CLK. SPI_CS is implemented using any spare SIO digital output pins to allow for multi-dropping.

The SPI interface enables full duplex synchronous communication between devices. It supports a 3-wire (SPI_MOSI, SPI_MISO, SPI_SCK,) bi-directional bus with fast data transfers to and from multiple slaves. Individual chip select signals are necessary for each of the slave devices attached to a bus, but control of these is left to the application through use of SIO signals. I/O data is double buffered.

The SPI peripheral supports SPI mode 0, 1, 2, and 3.

Table 17: SPI interfaces

Signal Name	M2 Pin No	I/O	Comments
SIO_40/SPI_MOSI	60	O	
SIO_12/SPI_MISO	62	I	
SIO_11/SPI_CLK	64	O	
Any_SIO/SPI_CS	-	I	SPI_CS is implemented using any spare SIO digital output pins to allow for multi-dropping.

4.11 I2C Interface

The I2C interface is an alternate function on SIO pins.

The two-wire interface can interface a bi-directional wired-OR bus with two lines (SCL, SDA) and has master /slave topology. The interface is capable of clock stretching. Data rates of 100 kbps and 400 kbps are supported.

An I2C interface allows multiple masters and slaves to communicate over a shared wired-OR type bus consisting of two lines which normally sit at 1.8V. The SCL is the clock line which is always sourced by the master and SDA is a bi-directional data line which can be driven by any device on the bus.

IMPORTANT: It is essential to remember that pull-up resistors on both SCL and SDA lines are not provided in the modem and **MUST** be provided external to the modem.

Table 18: I2C interface

Signal Name	M2 Pin No	I/O	Comments
SIO_26/I2C_SDA	12	I/O	This interface is an alternate function on each pin.
SIO_27/I2C_SCL	10	I/O	

4.12 General Purpose I/O, ADC, & PWM

4.12.1 GPIO

The 19 SIO pins are configurable via firmware. They can be accessed individually. Each has the following user configured features:

- Input/output direction
- Output drive strength (standard drive 0.5 mA or high drive 3mA)
- Internal pull-up and pull-down resistors (13 K typical) or no pull-up/down or input buffer disconnect
- Wake-up from high or low-level triggers on all pins including NFC pins

4.12.2 ADC

The ADC is an alternate function on SIO pins, configurable by firmware.

The Pinnacle™ 100 provides access to 8-channel 8/10/12-bit successive approximation ADC in one-shot mode. This enables sampling up to 8 external signals through a front-end MUX. The ADC has configurable input and reference pre-scaling and sample resolution (8, 10, and 12 bit).

4.12.2.1 Analog Interface (ADC)

Table 19: Analog interface

Signal Name	M2 Pin No	I/O	Comments
SIO_02/AIN0 – Analog Input	59	I	This interface is an alternate function of each pin, Configurable 8, 10, 12-bit resolution.
SIO_03/AIN1 – Analog Input	61	I	
SIO_04/AIN2 – Analog Input	23	I	Configurable voltage scaling 4, 2, 1/1, 1/3, 1/3, 1/4, 1/5, 1/6 (default).
SIO_05/AIN3 – Analog Input	36	I	
SIO_28/AIN4 – Analog Input	55	I	Configurable acquisition time 3uS, 5uS, 10uS (default), 15uS, 20uS, 40uS.
SIO_29/AIN5 – Analog Input	53	I	
SIO_30/AIN6 – Analog Input	40	I	Full scale input range (1.8V)
SIO_31/AIN7 – Analog Input	16	I	

4.12.3 PWM Signal Output on Up to 16 SIO Pins

The PWM output is an alternate function on ALL (GPIO) SIO pins, configurable by firmware.

The **PWM output** signal has a frequency and duty cycle property. Frequency is adjustable (up to 1 MHz) and the duty cycle can be set over a range from 0% to 100%.

PWM output signal has a frequency and duty cycle property. PWM output is generated using dedicated hardware in the chipset. There is a trade-off between PWM output frequency and resolution.

For example:

- PWM output frequency of 500 kHz (2 uS) results in resolution of 1:2.
- PWM output frequency of 100 kHz (10 uS) results in resolution of 1:10.
- PWM output frequency of 10 kHz (100 uS) results in resolution of 1:100.
- PWM output frequency of 1 kHz (1000 uS) results in resolution of 1:1000

4.13 nRESET pin

Table 20: nRESET pin

Signal Name	M2 Pin No	I/O	Comments
nRESET	73	I	Pinnacle™ 100 HW reset (active low). Pull the nRESET pin low for minimum 100mS for the Pinnacle™ 100 to reset.

4.14 Two-Wire Interface SWD

Table 21: SWD pins

Signal Name	M2 Pin No	I/O	Comments
SWDIO	13	I/O	Internal pull-up resistor
SWDCLK	11	I	Internal pull-down resistor

The Laird Connectivity development board incorporates an on-board SWD programmer for this purpose. There is also the following SWD connector which allows on-board SWD debug and programming signals to be routed off the development board. The only requirement is that you should use the following SWD connector on the host PCB.

The SWD connector Manufacture Part number is as follows:

Table 22 Programing Header

Reference	Part	Description and MPN (Manufacturers Part Number)
J14	FTSH-105	Header, 1.27mm, SMD, 10-way, FTSH-105-01-L-DV Samtech

Note: Reference on the Pinnacle™ 100 development board schematic (Figure 6) shows the DVK development schematic wiring only for the JTAG connector and the Pinnacle™ 100 modem JTAG pins.

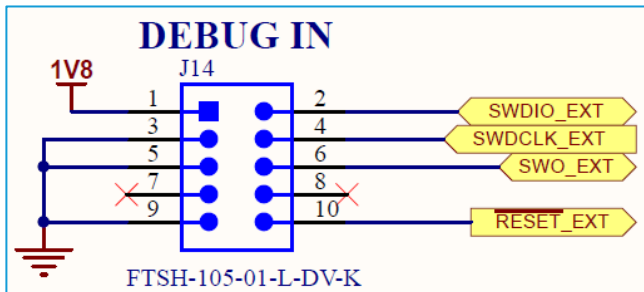

Figure 6: Pinnacle™ 100 development board schematic

Note: The Pinnacle™ 100 development board allows Laird Connectivity on-board SWD programmer signals to be routed off the development board by connector J14

We highly recommend that you place the SWD header to handle future Pinnacle™ 100 modem firmware upgrades. You **MUST** wire out the SWD interface on your host design (see [Figure 6](#), Required Signals SWDIO, SWDCLK, 1V8, & GND).

The SWO signal (SIO_32. M2.60) is a Trace output (called SWO, Serial Wire Output) and is **not** necessary for programming Pinnacle™ 100 over the SWD interface.

nRESET_BLE is **not** necessary for programming Pinnacle™ 100 over the SWD interface.

4.15 Pinnacle™ 100 Wakeup

4.15.1 Waking Up Pinnacle™ 100 from Host

The Pinnacle™ 100 can be woke up from the host using wake-up pins (any SIO pin). Pins may be configured in the firmware:

- Wake up when signal is low
- Wake up when signal is high
- Wake up when signal changes

4.16 Low Power Modes

The Pinnacle™ 100 support Low Power Mode, but current software is not optimized.

4.17 Security/Privacy

4.17.1 Random Number Generator

For Nordic related functionality, visit Nordic infocenter.nordicsemi.com

4.17.2 AES Encryption/Decryption

For Nordic related functionality, visit Nordic infocenter.nordicsemi.com

4.17.3 ARM Cryptocell

ARM Cryptocell incorporates a true random generator (TRNG) and support for a wide range of asymmetric, symmetric and hashing cryptographic services for secure applications.

4.17.4 Readback Protection

The Pinnacle™100 supports readback protection capability that disallows the reading of the memory on the nrf52840 using a JTAG interface.

4.17.5 Elliptic Curve Cryptography

The Pinnacle™100 offers a range of functions for generating public/private keypair, calculating a shared secret, as well as generating an authenticated hash.

4.18 External 32.768 kHz crystal

The Pinnacle™ 100 includes modem operation.

The Pinnacle™ 100 can use either the on-chip 32.76 kHz RC oscillator (LFCLK) by default (which has an accuracy of ± 500 ppm) which requires regulator calibration (every eight seconds) to within ± 500 ppm.

Or can use (Default) the external high accuracy (± 20 ppm) 32.768 kHz crystal (and associated load capacitors) that are connected to the nRF. [Table 23](#) compares the current consumption difference between RC and crystal oscillator.

Table 23: Comparing current consumption difference between Pinnacle™ 100 on-chip RC 32.76 kHz oscillator and external crystal (32.768 kHz) based oscillator

	Pinnacle™ 100 On-chip 32.768 kHz RC Oscillator (±500 ppm) LFRC	Optional External Higher Accuracy (±20 ppm) 32.768 kHz Crystal-based Oscillator LFXO
Current Consumption of 32.768 kHz Block	0.7 uA	0.23 uA
Standby Doze Current (SYSTEM ON IDLE + full RAM retention + RTC run current + LFRC or LFXO)	3.1 uA	2.6 uA
Calibration	<p>Calibration required regularly (default eight seconds interval).</p> <p>Calibration takes 33 ms; with DC-DC used, the total charge of a calibration event is 16 uC.</p> <p>The average current consumed by the calibration depends on the calibration interval and can be calculated using the following formula:</p> <p>CAL_charge/CAL_interval – The lowest calibration interval (0.25 seconds) provides an average current of (DC-DC enabled):</p> <p>16uC/0.25s = 64uA</p> <p>To get the 500-ppm accuracy, the BLE stack specification states that a calibration interval of eight seconds is enough. This gives an average current of:</p> <p>16uC/8s = 2 uA</p> <p>Added to the LFRC run current and Standby Doze (IDLE) base current shown above results in a total average current of:</p> <p>LFRC + CAL = 3.1 + 2 = 5.1 uA</p>	Not applicable
Total	5.1 uA	2.6 uA
Summary	<ul style="list-style-type: none"> ▪ Low current consumption ▪ Accuracy 500 ppm 	<ul style="list-style-type: none"> ▪ Lowest current consumption ▪ Needs external crystal ▪ High accuracy (depends on the crystal, usually 20 ppm)

5 HARDWARE INTEGRATION SUGGESTIONS

5.1 Circuit

The Pinnacle™ 100 is easy to integrate, requiring no external components on your board apart from those which you require for development and in your end application.

The following are suggestions for your design for the best performance and functionality.

Checklist (for Schematic):

- **Pinnacle™ 100 power supply:**
Provide 2.2 -5.5 V to M2 Pins 2, 4, 72,74 with a power supply that can supply up to 1A @ 2.2V.
- **AIN (ADC) and SIO pin IO voltage levels**
Pinnacle™ 100 SIO voltage levels are at 1.8V. Ensure input voltage levels into SIO pins are at 1.8V.
- **AIN (ADC) impedance and external voltage divider setup**
If you need to measure with ADC a voltage higher than 1.8V, you can connect a high impedance voltage divider to lower the voltage to the ADC input pin.

- **SWD**
This interface is used to load firmware.
Laird Connectivity recommends you use SWD (2-wire interface) to handle future Pinnacle™ 100 modem firmware upgrades. You MUST wire out the SWD(2-wire interface) on your host design (see [Figure 6](#), where four lines should be wired out, namely SWDIO, SWDCLK, GND and VCC).
- **UART**
Required for modem communication and HL7800 communication.
- **UART_RX and UART_CTS**
SIO_08 (alternative function UART_RX) is an input, set with internal weak pull-up (in firmware). The pull-up prevents the modem from going into deep sleep when UART_RX line is idling.
SIO_07 (alternative function UART_CTS) is an input, set with internal weak pull-down (in firmware). This pull-down ensures the default state of the UART_CTS will be asserted which means can send data out of the UART_TX line. Laird Connectivity recommends that UART_CTS be connected.
- **nAutoRUN pin and operating mode selection (Hosted Mode Only)**
nAutoRUN pin needs to be externally held high or low to select between the two Pinnacle™ 100 operating modes at power-up:
 - Self-contained Run mode (nAutoRUN pin held at 0V).
 - Interactive/development mode (nAutoRUN pin held at 1.8V).
Make provision to allow operation in the required mode. Add jumper to allow nAutoRUN pin to be held high or low (Pinnacle™ 100 has internal 13K pull-down by default) OR driven by host GPIO.
- **I2C**
It is essential to remember that pull-up resistors on both I2C_SCL and I2C_SDA lines are not provided in the Pinnacle™ 100 modem and MUST be provided external to the modem as per I2C standard.
- **SPI**
Implement SPI chip select using any unused SIO pin within your application then SPI_CS is controlled from the software application allowing multi-dropping.
- **SIO pin direction**
Pinnacle™ 100 modems SIO pins (with default function of DIO) are mostly digital inputs (see [Table 2](#)). Remember to change the direction SIO pin if that particular pin is wired to a device that expects to be driven by the Pinnacle™ 100 SIO pin configured as an output. Also, these SIO pins have the internal pull-up or pull-down resistor-enabled by default in firmware (see [Table 2](#)). This was done to avoid floating inputs, which can cause current consumption in low power modes (e.g. StandbyDoze) to drift with time. You can disable the PULL-UP or Pull-down through their Nordic application.

Note: Internal pull-up, pull down takes current from 1.8V.

- **NFC antenna connector**
To make use of the Laird Connectivity flexi-PCB NFC antenna, fit connector:
 - Description – FFC/FPC Connector, Right Angle, SMD/90d, Dual Contact, 1.2 mm Mated Height
 - Manufacturer – Molex
 - Manufacturers Part number – 512810594
 Add tuning capacitors of 300 pF on NFC1 pin to GND and 300 pF on NFC2 pins to GND if the PCB track length is similar as development board.
- **nRESET pin (active low)**
Hardware reset. Wire out to push button or drive by host.
By default modem is out of reset when power applied to Vin pins.

5.2 PCB Layout on Host PCB - General

Checklist (for PCB):

- MUST locate Pinnacle™ 100 modem M2 connector and Standoffs per the reference design. The positioning on the Intergerned Antenna host PCB must overhang the PCB edge matching the reference design (mandatory for the 453-00010 for on-board PCB trace antenna to radiate properly).
- Use solid GND plane on inner layer (for best EMC and RF performance).
- All modem GND pins MUST be connected to host PCB GND.

- Place GND vias close to modem GND pads as possible.
- Unused PCB area on surface layer can be flooded with copper but place GND vias regularly to connect the copper flood to the inner GND plane. If GND flood copper is on the bottom of the modem, then connect it with GND vias to the inner GND plane.
- Route traces to avoid noise being picked up on VIN, 1V8, VBUS supply and AIN (analogue) and SIO (digital) traces.
- 453-00010 has an integrated PCB trace antenna and its performance is sensitive to host PCB. It is critical to locate the 453-00010 on the edge of the host PCB exactly like the reference design to allow the antenna to radiate properly.
- Keep all mounting hardware and metal clear of the area to allow proper antenna radiation.
 - For best antenna performance, place the 453-00010 modem on the edge of the host PCB, preferably in the edge centers, similar to the Reference Design
 - The Pinnacle™ 100 development board has the 453-00010 modem on the edge of the board (not in the corner).
 - The 453-00010 LTE Bent Metal and BLE PCB integrated antenna is tuned to a maximum host board size of 150mm x 100mm, and a minimum host board size of 42mm x 80 mm.

Note: The Pinnacle™ 100 modem is placed on the edge, preferably edge centre of the host PCB.

5.2.1 Antenna Keep-out and Proximity to Metal or Plastic

Checklist (for metal /plastic enclosure):

- Minimum safe distance for metals without seriously compromising the antenna (tuning) is 40 mm top/bottom and 30 mm left or right.
- Metal close to the 453-00010 PCB trace monopole antenna (bottom, top, left, right, any direction) will have degradation on the antenna performance. The amount of that degradation is entirely system dependent, meaning you will need to perform some testing with your host application.
- Any metal closer than 20 mm will begin to significantly degrade performance (S11, gain, radiation efficiency).
- It is best that you test the range with a mock-up (or actual prototype) of the product to assess effects of enclosure height (and materials, whether metal or plastic).

5.3 BLE Antenna Integration

The Pinnacle™ 100 modem has been designed to operate with the following internal and external antennas (with a maximum gain of 2.0 dBi). The required antenna impedance is 50 ohms. See [Table 24](#). External antennas improve radiation efficiency.

Table 24: External antennas for the Pinnacle™ 100

Manufacturer	Model	Laird Connectivity Part Number	Type	Connector	Peak Gain
					2400-2500 MHz
Laird Connectivity	NanoBlue	MAF94045	PCB Dipole	IPEX U.FL	2 dBi
Laird Connectivity	FlexPIFA	001-0014	Patch	U.FL	2 dBi
Laird Connectivity	Dipole	001-0001		RP-SMA	2 dBi

Note: The OEM is free to choose another vendor's antenna of like type and equal or lesser gain as an antenna appearing in the table and still maintain compliance. Reference FCC Part 15.204(c)(4) for further information on this topic.

To reduce potential radio interference to other users, the antenna type and gain should be chosen so that the equivalent isotropic radiated power (EIRP) is not more than that permitted for successful communication.

5.4 LTE Antenna Integration

The Pinnacle™ 100 family has been designed to operate with the below internal and external antennas (with a maximum gain of 3.7 dBi). The required antenna impedance is 50 ohms. See [Table 24](#). External antennas improve radiation efficiency.

Table 25: External antennas for the Pinnacle™ 100

Manufacturer	Model	Laird Connectivity Part Number	Type	Connector	Peak Gain	
					698-875 MHz	1710-2500 MHz
Laird Connectivity	Revie Flex	EFF6925A3S-15MHF1	PCB Dipole	IPEX U.FL	1.9 dBi	3.7 dBi
Laird Connectivity	Dipole Blade	DBA6927C1-FSMAM	Dipole	SMA	0.5 dBi	2.2 dBi
Laird Connectivity	Pinnacle™ 100 Bent Metal	110-00665	Bent Metal	N/A	1.3 dBi	2.6 dBi

Note: Laird Connectivity is the manufacturer for the antennas listed below.

Model	Man. PN	Type	Conn.	Peak Gain											
				600-698	698-806	806-894	880-960	1350-1580	1550-1610	1690-1880	1850-1990	1910-2180	2300-2700	3300-4200	4900-6000
Revie Flex 600	EFF6060A3 S-10MHF1	PCB Dipole	IPEX U.FL	2.0	2.5	2.7	3.2	3.8	3.8	3.7	2.8	2.9	3.8	4.7	6.9

Model	Man. PN	Type	Conn.	Peak Gain											
				698-824	824-894	880-960	1350-1550	1550-1690	1690-1880	1850-1990	1910-2170	2300-2500	2500-2700	3300-4200	4900-6000
Revie Flex 700	EFF6989A3 S-19MHF1	PCB Dipole	IPEX U.FL	0.9	1.4	2.7	3.2	4.2	4.1	3.7	3.9	3.7	3.5	3.3	4.5

Note: The OEM is free to choose another vendor's antenna of like type and equal or lesser gain as an antenna appearing in the table and still maintain compliance. Reference FCC Part 15.204(c)(4) for further information on this topic.

To reduce potential radio interference to other users, the antenna type and gain should be chosen so that the equivalent isotropic radiated power (EIRP) is not more than that permitted for successful communication.

6 MECHANICAL DETAILS

6.1 Pinnacle™ 100 Mechanical Details

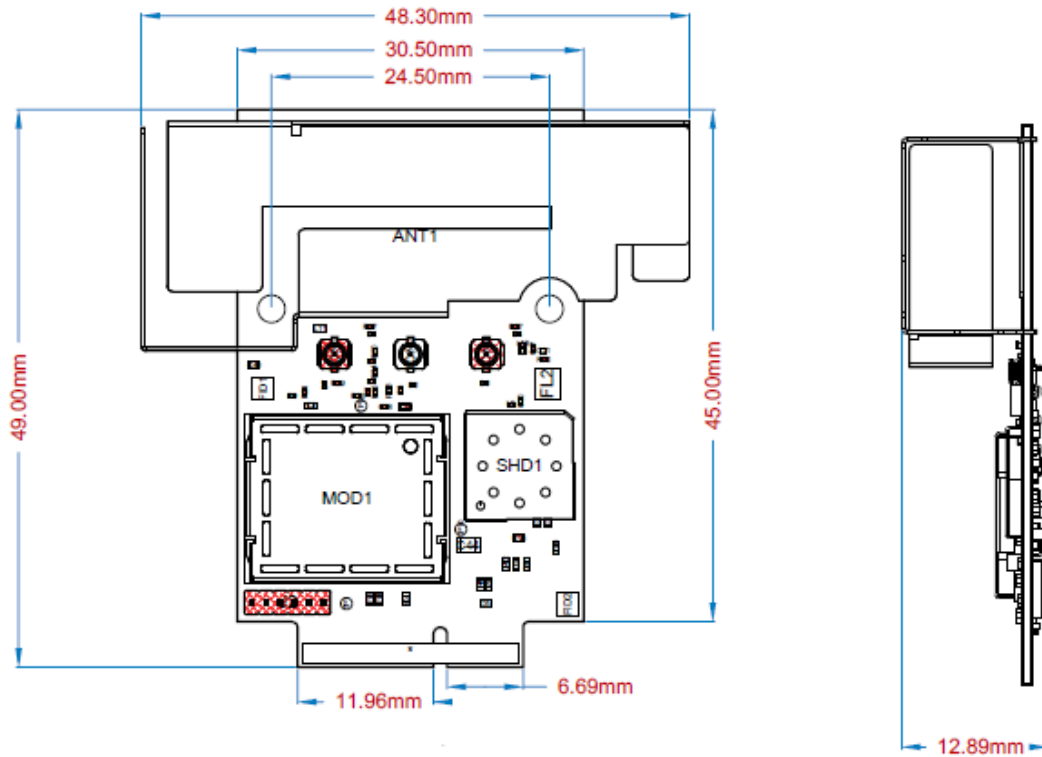

Figure 7: Pinnacle™ 100 453-00010 mechanical drawings

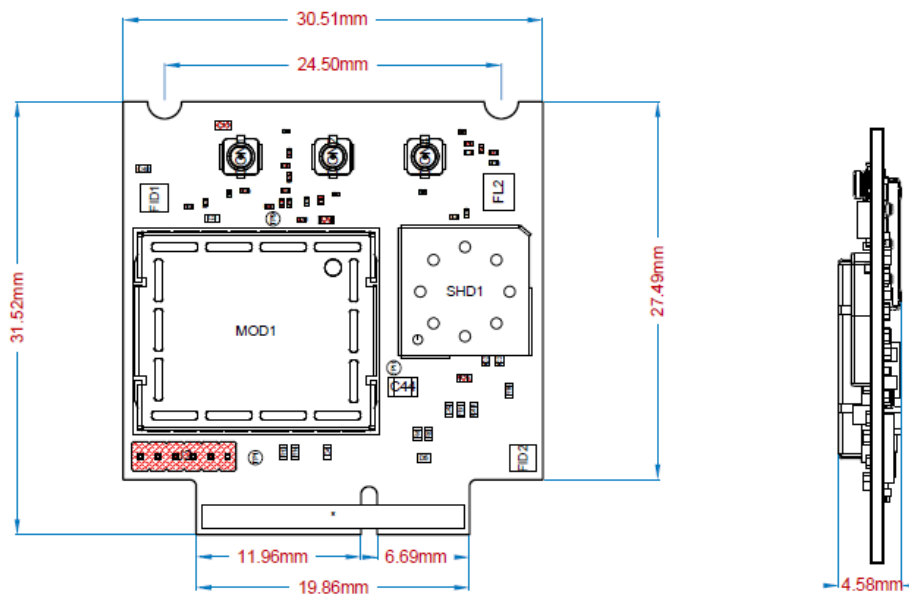

Figure 8: Pinnacle™ 100 453-00011 mechanical drawings

6.2 PCI Express M2 Connector and Standoffs

The Pinnacle™ 100 modem is connected to a host board using an TE Connectivity 2199230-4, 67 Position Female M.2 connector. The Pinnacle™ 100 uses a custom pin out and does not follow the M2 standard pin out. The modem also requires two PEM threaded standoffs and two screws to hold the modem. A PCB footprint is providing the reference dimension of the connector to stand-off distances, as well as, the distance from PCB board edge.

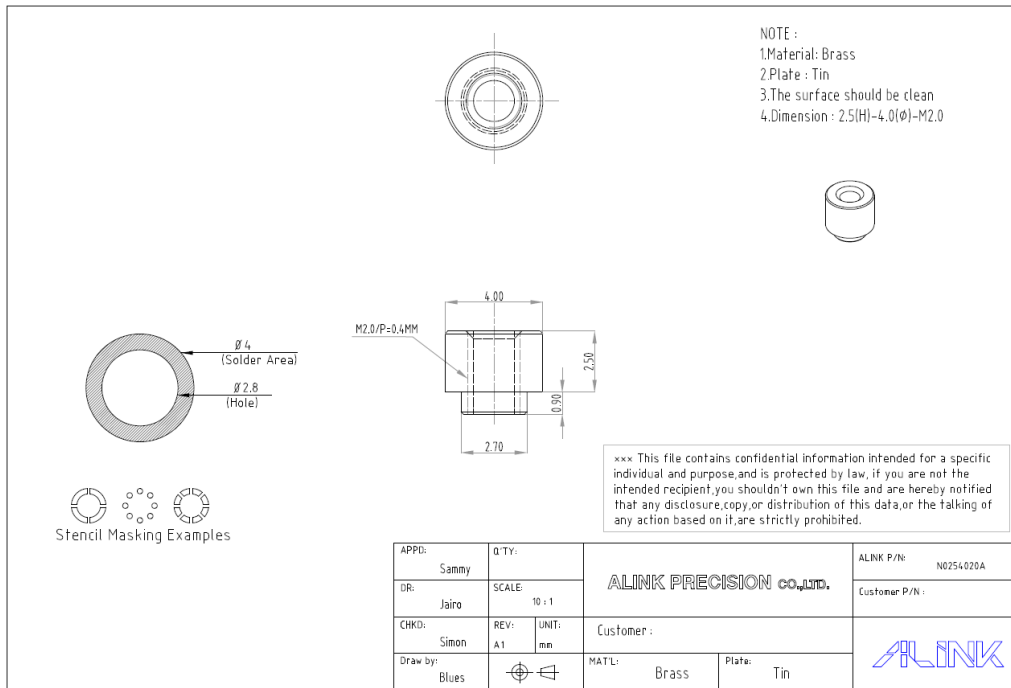

Figure 9: PEM Threaded Standoff mechanical drawings

6.3 Mounting Screw

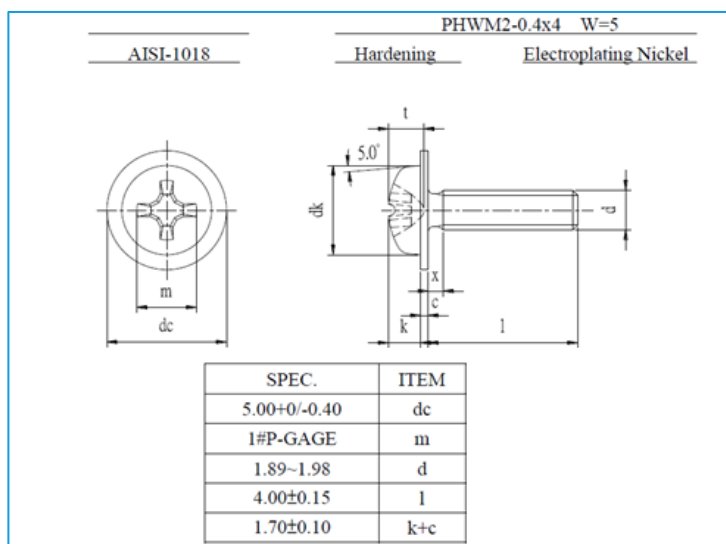

Figure 10: Mounting Screw mechanical drawing

6.4 Shipping

All modems are shipped in trays and sealed in ESD Bags.

453-00010T ship a quantity of 25 per tray.

453-00011T ship a quantity of 50 per tray.

6.4.1 Tray Dimensions

453-00010T:

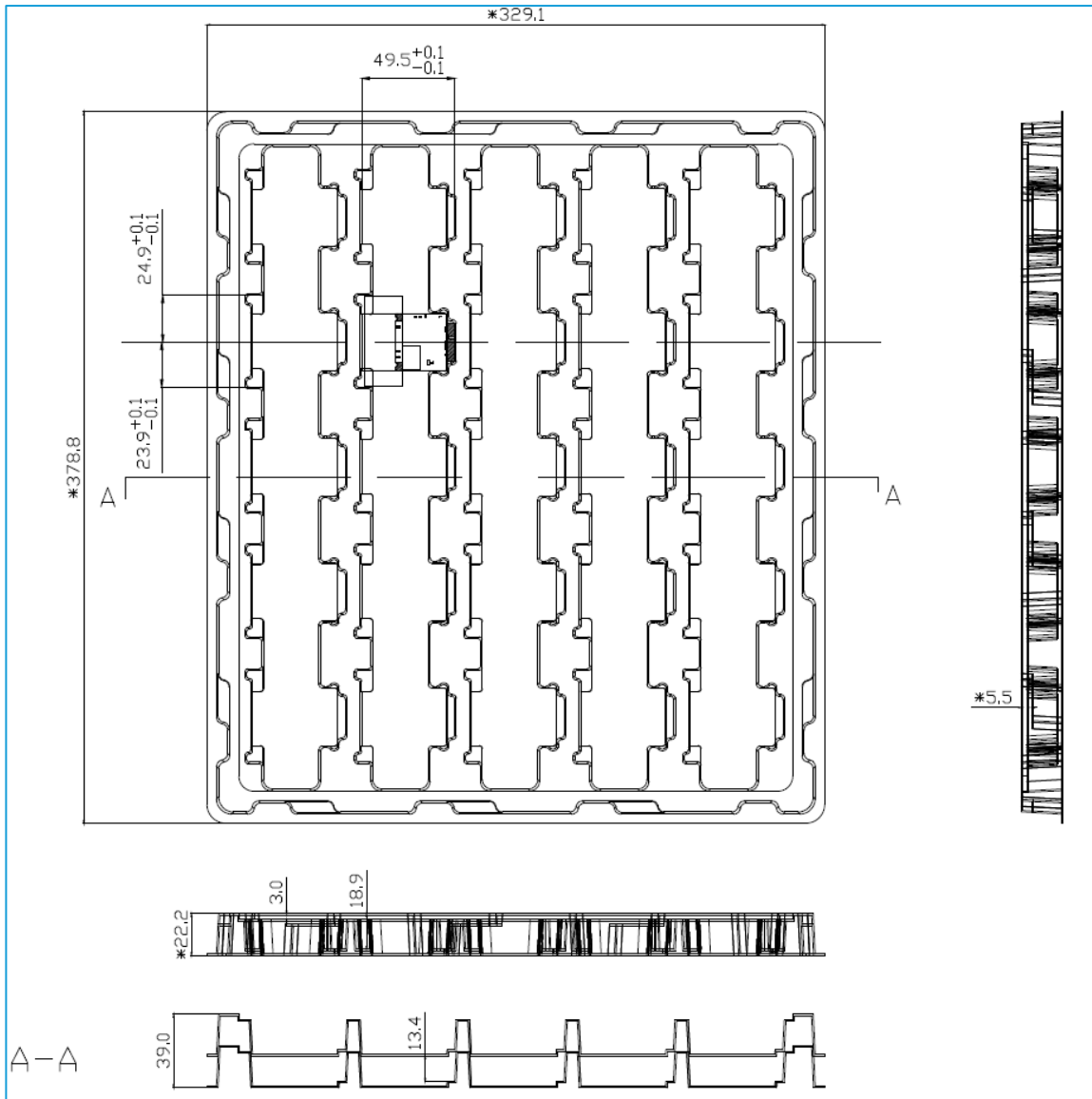

Figure 11: 453-00010 modem tray (mm) 25 per tray

453-00011T:

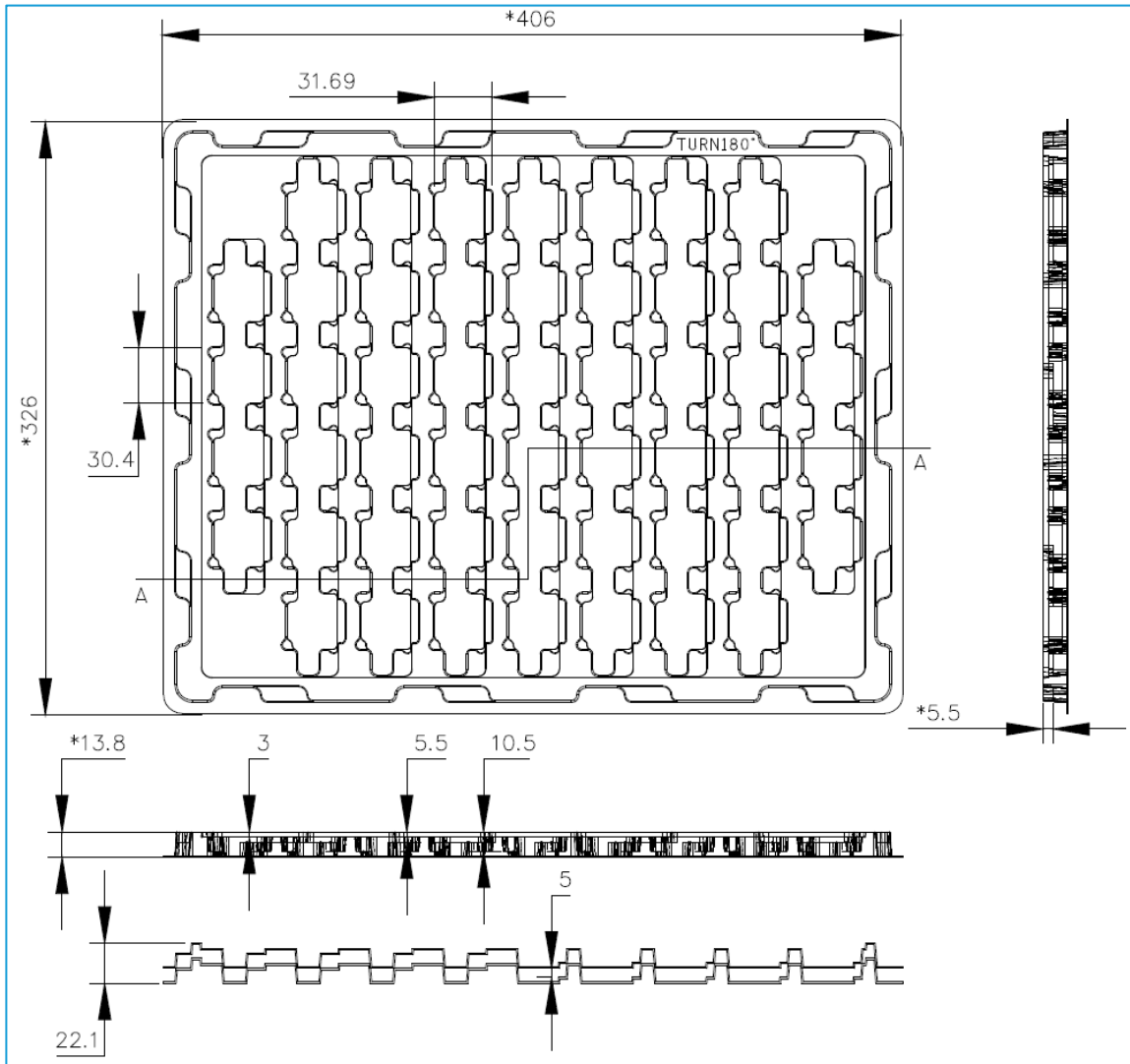

Figure 12: 453-00011 modem tray (mm) 50 per tray

6.5 Modem Labeling

6.5.1 453-00010

Initial Release (Rev 4)

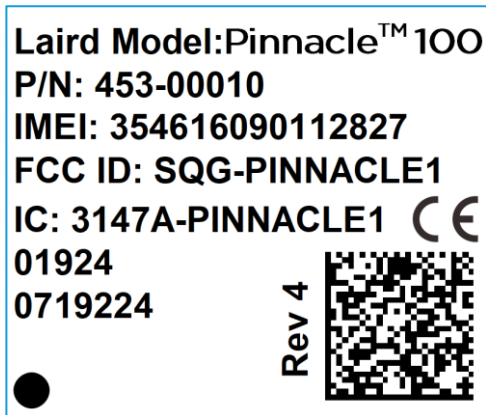

Figure 13: 453-00010 modem label

6.5.2 453-00011

Initial Release (Rev 4)

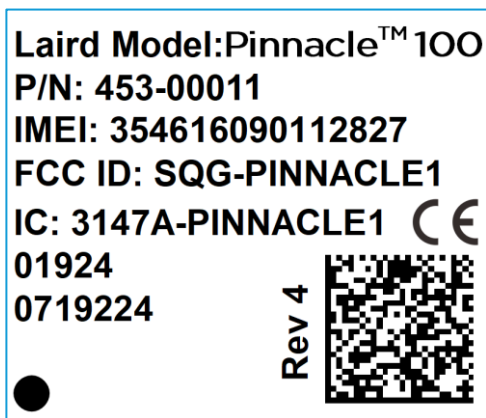

Figure 14: 453-00011 modem label

7 REGULATORY

7.1 Regulatory IDs Summary

Model	US/FCC	Canada/ISED
453-00010	SQG-PINNACLE1	3147A-PINNACLE1
453-00011		

7.2 Certified Antennas

Note: Laird Connectivity is the manufacturer for all of the antennas listed below.

Table 26: Pinnacle 100 certified antennas

Model	Laird Connectivity Part Number	Type	Connector	Peak Gain	
				2400-2500 MHz	
NanoBlue	MAF94045	PCB Dipole	IPEX U.FL	2 dBi	
FlexPIFA	001-0014	Patch	U.FL	2 dBi	
Dipole	001-0001		RP-SMA	2 dBi	

Model	Laird Connectivity Part Number	Type	Connector	Peak Gain	
				698-875MHz	1710-2500 MHz
Revie Flex	EFF6925A3S-15MHF1	PCB Dipole	IPEX U.FL	1.9 dBi	3.7 dBi
Dipole Blade	DBA6927C1-FSMAM	Dipole	SMA	0.5 dBi	2.2 dBi
Pinnacle™ 100 Bent Metal	110-00665	Bent Metal	N/A	1.3 dBi	2.6 dBi

Model	Man. PN	Type	Conn.	Peak Gain											
				600-698	698-806	806-894	880-960	1350-1580	1550-1610	1690-1880	1850-1990	1910-2180	2300-2700	3300-4200	4900-6000
Revie Flex 600	EFF6060A3 S-10MHF1	PCB Dipole	IPEX U.FL	2.0	2.5	2.7	3.2	3.8	3.8	3.7	2.8	2.9	3.8	4.7	6.9

Model	Man. PN	Type	Conn.	Peak Gain											
				698-824	824-894	880-960	1350-1550	1550-1690	1690-1880	1850-1990	1910-2170	2300-2500	2500-2700	3300-4200	4900-6000
Revie Flex 700	EFF6989A3 S-19MHF1	PCB Dipole	IPEX U.FL	0.9	1.4	2.7	3.2	4.2	4.1	3.7	3.9	3.7	3.5	3.3	4.5

Note: The OEM is free to choose another vendor's antenna of like type and equal or lesser gain as an antenna appearing in the table and still maintain compliance. Reference FCC Part 15.204(c)(4) for further information on this topic.

To reduce potential radio interference to other users, the antenna type and gain should be chosen so that the equivalent isotropic radiated power (EIRP) is not more than that permitted for successful communication.

7.3 FCC Regulatory

The 453-00010 and the 453-00011 hold full modular approvals. The OEM must follow the regulatory guidelines and warnings listed below to inherit the modem approval.

Part #	Form Factor	BLE TX Pout	BLE Antenna	LTE TX Pout	LTE Antenna
453-00010	M2 Key E	6 dBm	PCB Trace	23 dBm	Bent Metal
453-00011	M2 Key E	6 dBm	U.FL	23 dBm	U.FL

Federal Communication Commission (FCC) Radiation Exposure Statement

This EUT complies with SAR for general population/uncontrolled exposure limits in FCC Part 1.1307, Part. 1310 and FCC KDB 447498 – RF Exposure Procedures and Equipment Authorization Policies for Mobile and Portable Devices.

This transceiver must not be co-located or operating in conjunction with any other antenna, transmitter, or external amplifiers. Further testing/evaluation of the end product will be required if the OEM's device violates any of these requirements.

The Pinnacle™ 100 is fully approved for mobile and portable applications.

OEM Responsibilities

WARNING: The OEM must ensure that FCC labelling requirements are met. This includes a clearly visible label on the outside of the OEM enclosure specifying the appropriate Laird Connectivity FCC identifier for this product.

Contains FCC ID: SQG-PINNACLE1

The following FCC part 15.19 statement must also be available on visible on outside of device:

The enclosed device complies with Part 15 of the FCC Rules. Operation is subject to the following two conditions: (1) This device may not cause harmful interference, and (2) This device must accept any interference received, including interference that may cause undesired operation

Label and text information should be in a size of type large enough to be readily legible, consistent with the dimensions of the equipment and the label. However, the type size for the text is not required to be larger than eight points.

CAUTION: The OEM should have their device which incorporates the Pinnacle™ 100 tested by a qualified test house to verify compliance with FCC Part 15 Subpart B limits for unintentional radiators.

CAUTION: Any changes or modifications not expressly approved by Laird Connectivity could void the user's authority to operate the equipment.

Federal Communication Commission Interference Statement

This equipment has been tested and found to comply with the limits for a Class B digital device, pursuant to Part 15 of the FCC Rules. These limits are designed to provide reasonable protection against harmful interference in a residential installation. This equipment generates, uses, and can radiate radio frequency energy and, if not installed and used in accordance with the instructions, may cause harmful interference to radio communications. However, there is no guarantee that interference will not occur in a particular installation. If this equipment does cause harmful interference to radio or television reception, which can be determined by turning the equipment off and on, the user is encouraged to try to correct the interference by one of the following measures:

- Reorient or relocate the receiving antenna.
- Increase the separation between the equipment and receiver.
- Connect the equipment into an outlet on a circuit different from that to which the receiver is connected.
- Consult the dealer or an experienced radio/TV technician for help.

FCC Caution: Any changes or modifications not expressly approved by the party responsible for compliance could void the user's authority to operate this equipment.

This device complies with Part 15 of the FCC Rules. Operation is subject to the following two conditions: (1) This device may not cause harmful interference, and (2) this device must accept any interference received, including interference that may cause undesired operation.

FCC Caution: Any changes or modifications not expressly approved by the party responsible for compliance could void the user's authority to operate this equipment.

IMPORTANT NOTE:

FCC Radiation Exposure Statement:

This equipment complies with FCC radiation exposure limits set forth for an uncontrolled environment. This equipment should be installed and operated with a minimum distance of 20 centimeters between the radiator and your body.

This transmitter must not be co-located or operated in conjunction with any other antenna or transmitter.

Integration Instructions for Host Product Manufacturers

Applicable FCC rules to module – FCC Part 24/27; FCC Part 15.247

Summary of the Specific Operational Use Conditions – The module must be installed in a mobile device. This device is intended only for OEM integrators under the following conditions:

- The antenna must be installed such that 20 cm is maintained between the antenna and users, and
- The transmitter module may not be co-located with any other transmitter or antenna

As long as the two conditions above are met, further transmitter testing is not be required. However, the OEM integrator is still responsible for testing their end-product for any additional compliance requirements required with this module installed.

IMPORTANT NOTE: In the event that these conditions cannot be met (for example, certain laptop configurations or co-location with another transmitter), then the FCC authorization is no longer considered valid and the FCC ID cannot be used on the final product. In these circumstances, the OEM integrator is responsible for re-evaluating the end product (including the transmitter) and obtaining a separate FCC authorization. The OEM integrator must be aware not to provide information to the end user regarding how to install or remove this RF module in the user's manual of the end product which integrates this module.

The end user manual shall include all required regulatory information/warning as show in this manual.

Limited Module Procedures – Not applicable

Trace Antenna Designs – Not applicable

RF Exposure Considerations – 20-centimeter separation distance and co-located issue shall be met as mentioned in *Summary of the Specific Operational Use Conditions*.

Product manufacturer shall provide the following text in the end-product manual:

This equipment complies with FCC radiation exposure limits set forth for an uncontrolled environment. This equipment should be installed and operated with a minimum distance of 20 centimeters between the radiator and your body.

Label and Compliance Information

Product manufacturers must provide a physical or e-label with the finished product that states the following:

Contains FCC ID: SQG-PINNACLE1

Information on Test Modes and Additional Testing Requirements

LTE – Simulator is required to link up and set the module to transmit at specific frequency, output power level under operation mode.

BT – Test tool is UwTerminal, version 7.94

Additional Testing – Part 15 Subpart B Disclaimer

The module is only FCC authorized for the specific rule parts listed on the grant, and that the host product manufacturer is responsible for compliance to any other FCC rules that apply to the host not covered by the modular transmitter grant of certification. The final host product still requires Part 15 Subpart B compliance testing with the modular transmitter installed.

7.4 ISED (Canada)

This device contains licence-exempt transmitter(s)/receiver(s) that comply with Innovation, Science and Economic Development Canada's licence-exempt RSS(s). Operation is subject to the following two conditions:

- *This device may not cause interference*
- *(This device must accept any interference, including interference that may cause undesired operation of the device)*

Cet appareil contient des émetteurs / récepteurs exempts de licence qui sont conformes au (x) RSS (s) exemptés de licence d'Innovation, Sciences et Développement économique Canada. L'opération est soumise aux deux conditions suivantes:

- *Cet appareil ne doit pas causer d'interférences*
- *Cet appareil doit accepter toute interférence, y compris les interférences pouvant provoquer un fonctionnement indésirable de l'appareil*

Radiation Exposure Statement

This equipment complies with Canada radiation exposure limits set forth for an uncontrolled environment. This equipment should be installed and operated with minimum distance 20cm between the radiator & your body.

Déclaration d'exposition aux radiations:

Cet équipement est conforme Canada limites d'exposition aux radiations dans un environnement non contrôlé. Cet équipement doit être installé et utilisé à distance minimum de 20cm entre le radiateur et votre corps.

This device is intended only for OEM integrators under the following condition:

- The transmitter module may not be co-located with any other transmitter or antenna.

As long as 1 condition above are met, further transmitter test will not be required. However, the OEM integrator is still responsible for testing their end-product for any additional compliance requirements required with this module installed.

Cet appareil est conçu uniquement pour les intégrateurs OEM dans les conditions suivantes:

- Le module émetteur peut ne pas être coimplanté avec un autre émetteur ou antenne.

Tant que les 1 condition ci-dessus sont remplies, des essais supplémentaires sur l'émetteur ne seront pas nécessaires. Toutefois, l'intégrateur OEM est toujours responsable des essais sur son produit final pour toutes exigences de conformité supplémentaires requis pour ce module installé.

IMPORTANT NOTE:

In the event that these conditions can not be met (for example certain laptop configurations or co-location with another transmitter), then the Canada authorization is no longer considered valid and the IC ID can not be used on the final product. In these circumstances, the OEM integrator will be responsible for re-evaluating the end product (including the transmitter) and obtaining a separate Canada authorization.

NOTE IMPORTANTE:

Dans le cas où ces conditions ne peuvent être satisfaites (par exemple pour certaines configurations d'ordinateur portable ou de certaines co-localisation avec un autre émetteur), l'autorisation du Canada n'est plus considéré comme valide et l'ID IC ne peut pas être utilisé sur le produit final. Dans ces circonstances, l'intégrateur OEM sera chargé de réévaluer le produit final (y compris l'émetteur) et l'obtention d'une autorisation distincte au Canada.

End Product Labeling

The final end product must be labeled in a visible area with the following: "Contains IC: 3147A-PINNACLE1"

Plaque signalétique du produit final

Le produit final doit être étiqueté dans un endroit visible avec l'inscription suivante: "Contient des IC: 3147A-PINNACLE1".

Manual Information to the End User

The OEM integrator has to be aware not to provide information to the end user regarding how to install or remove this RF module in the user's manual of the end product which integrates this module.

The end user manual shall include all required regulatory information/warning as show in this manual.

Manuel d'information à l'utilisateur final

L'intégrateur OEM doit être conscient de ne pas fournir des informations à l'utilisateur final quant à la façon d'installer ou de supprimer ce module RF dans le manuel de l'utilisateur du produit final qui intègre ce module.

Le manuel de l'utilisateur final doit inclure toutes les informations réglementaires requises et avertissements comme indiqué dans ce manuel.

This radio transmitter (IC: 3147A-PINNACLE1) has been approved by Industry Canada to operate with the antenna types listed below with the maximum permissible gain indicated. Antenna types not included in this list, having a gain greater than the maximum gain indicated for that type, are strictly prohibited for use with this device.

Le présent émetteur radio (IC: 3147A-PINNACLE1) a été approuvé par Industrie Canada pour fonctionner avec les types d'antenne énumérés ci-dessous et ayant un gain admissible maximal. Les types d'antenne non inclus dans cette liste, et dont le gain est supérieur au gain maximal indiqué, sont strictement interdits pour l'exploitation de l'émetteur.

Table 27: Pinnacle 100 certified antennas

Model	Laird Connectivity Part Number	Type	Connector	Peak Gain	
				2400-2500 MHz	
NanoBlue	MAF94045	PCB Dipole	IPEX U.FL	2 dBi	
FlexPIFA	001-0014	Patch	U.FL	2 dBi	
Dipole	001-0001		RP-SMA	2 dBi	

Model	Laird Connectivity Part Number	Type	Connector	Peak Gain	
				698-875MHz	1710-2500 MHz
Revie Flex	EFF6925A3S-15MHF1	PCB Dipole	IPEX U.FL	1.9 dBi	3.7 dBi
Dipole Blade	DBA6927C1-FSMAM	Dipole	SMA	0.5 dBi	2.2 dBi
Pinnacle™ 100 Bent Metal	110-00665	Bent Metal	N/A	1.3 dBi	2.6 dBi

Model	Man. PN	Type	Conn.	Peak Gain											
				600-698	698-806	806-894	880-960	1350-1580	1550-1610	1690-1880	1850-1990	1910-2180	2300-2700	3300-4200	4900-6000
Revie Flex 600	EFF6060A3 S-10MHF1	PCB Dipole	IPEX U.FL	2.0	2.5	2.7	3.2	3.8	3.8	3.7	2.8	2.9	3.8	4.7	6.9

Model	Man. PN	Type	Conn.	Peak Gain											
				698-824	824-894	880-960	1350-1550	1550-1690	1690-1880	1850-1990	1910-2170	2300-2500	2500-2700	3300-4200	4900-6000
Revie Flex 700	EFF6989A3 S-19MHF1	PCB Dipole	IPEX U.FL	0.9	1.4	2.7	3.2	4.2	4.1	3.7	3.9	3.7	3.5	3.3	4.5

7.5 EU Regulatory

The 453-00010/453-00011 have been tested for compliance with relevant standards for the EU market. The 453-00011 modem was tested with a 2 dBi antenna. The OEM can operate the 453-00011 modem with any other type of antenna but must ensure that the gain does not exceed 2 dBi to maintain the Laird Connectivity approval.

The OEM should consult with a qualified test house before entering their device into an EU member country to make sure all regulatory requirements have been met for their complete device.

Reference the Declaration of Conformities listed below for a full list of the standards that the modems were tested to. Test reports are available upon request.

Antenna Information

The antennas listed below were tested for use with the Pinnacle™ 100. For CE mark countries, the OEM is free to use any manufacturer's antenna and type of antenna if the gain is less than or equal to the highest gain approved for use (2dBi). Contact a Laird Connectivity representative for more information regarding adding antennas.

Note: Laird Connectivity is the manufacturer for all of the antennas listed below.

Table 28: Pinnacle 100 certified antennas

Model	Laird Connectivity Part Number	Type	Connector	Peak Gain	
				2400-2500 MHz	
NanoBlue	MAF94045	PCB Dipole	IPEX U.FL	2 dBi	
FlexPIFA	001-0014	Patch	U.FL	2 dBi	
Dipole	001-0001		RP-SMA	2 dBi	

Model	Laird Connectivity Part Number	Type	Connector	Peak Gain	
				698-875MHz	1710-2500 MHz
Revie Flex	EFF6925A3S-15MHF1	PCB Dipole	IPEX U.FL	1.9 dBi	3.7 dBi
Dipole Blade	DBA6927C1-FSMAM	Dipole	SMA	0.5 dBi	2.2 dBi
Pinnacle™ 100 Bent Metal	110-00665	Bent Metal	N/A	1.3 dBi	2.6 dBi

Model	Man. PN	Type	Conn.	Peak Gain											
				600-698	698-806	806-894	880-960	1350-1580	1550-1610	1690-1880	1850-1990	1910-2180	2300-2700	3300-4200	4900-6000
Revie Flex 600	EFF6060A3 S-10MHF1	PCB Dipole	IPEX U.FL	2.0	2.5	2.7	3.2	3.8	3.8	3.7	2.8	2.9	3.8	4.7	6.9

Model	Man. PN	Type	Conn.	Peak Gain											
				698-824	824-894	880-960	1350-1550	1550-1690	1690-1880	1850-1990	1910-2170	2300-2500	2500-2700	3300-4200	4900-6000
Revie Flex 700	EFF6989A3 S-19MHF1	PCB Dipole	IPEX U.FL	0.9	1.4	2.7	3.2	4.2	4.1	3.7	3.9	3.7	3.5	3.3	4.5

Note: The Pinnacle™ 100 modem internal BLE chipset IC pins are rated 2 kV (ESD HBM). ESD can find its way through the external JTAG connector (if used on the customer's design), if discharge is applied directly. Customer should ensure adequate protection against ESD on their end product design (using the Pinnacle™ 100 modem) to meet relevant ESD standard (for CE, this is EN301-489).

User's Guide Requirements

The integrator must include specific information in the user's guide for the device into which the WB40NBT is integrated. In addition to the required FCC and IC statements outlined above, the following Radio Equipment Directive (RED) statements must be added in their entirety and without modification into a prominent place in the user's guide for the device into which the WB40NBT is integrated:

This device complies with the essential requirements of the 2014/53/EU – Radio Equipment Directive (RED). The following test methods have been applied in order to prove presumption of conformity with the essential requirements of the 2014/53/EU – Radio Equipment Directive (RED):

- **EN 62368-1:2014/A11:2017**
Safety requirements for audio/video, information, and technology equipment
- **EN 300 328 v2.2.2 (2019-07)**
Electromagnetic compatibility and Radio Spectrum Matters (ERM); Wideband Transmission systems; Data transmission equipment operating in the 2,4 GHz ISM band and using spread spectrum modulation techniques; Harmonized EN covering essential requirements under article 3.2 of the R&TTE Directive
- **EN 62311:2008 | EN 50665:2017 | EN 50385:2017**
RF exposure
- **EN 301 489-1 v2.2.0 (2017-03)**
Electromagnetic compatibility and Radio Spectrum Matters (ERM); ElectroMagnetic Compatibility (EMC) standard for radio equipment and services; Part 1: Common technical requirements
- **EN 301 489-17 V3.2.0 (2017-03)**
Electromagnetic compatibility and Radio spectrum Matters (ERM); ElectroMagnetic Compatibility (EMC) standard for radio equipment and services; Part 17: Specific conditions for 2,4 GHz wideband transmission systems and 5 GHz high performance RLAN equipment
- **EN 301 893 V2.1.1 (2017-05)**
Electromagnetic compatibility and Radio spectrum Matters (ERM); Broadband Radio Access Networks (BRAN); Specific conditions for 5 GHz high performance RLAN equipment
- **EU 2015/863 (RoHS 3)**
Declaration of Compliance – EU Directive 2015/863; Reduction of Hazardous Substances (RoHS)

This device is a 2.4 GHz wideband transmission system (transceiver), intended for use in all EU member states and EFTA countries, except in France and Italy where restrictive use applies.

In Italy the end-user should apply for a license at the national spectrum authorities in order to obtain authorization to use the device for setting up outdoor radio links and/or for supplying public access to telecommunications and/or network services.

This device may not be used for setting up outdoor radio links in France and in some areas the RF output power may be limited to 10 mW EIRP in the frequency range of 2454 – 2483.5 MHz. For detailed information the end-user should contact the national spectrum authority in France.

Български [Bulgarian]	С настоящото [име на производителя] декларира, че това устройство [вид оборудване] е в съответствие със съществените изисквания и други приложими разпоредби на Директиви 2014/53/EC
Hrvatski [Croatian]	[naziv proizvođača] ovim putem izjavljuje da je ovaj uređaj [vrsta opreme] sukladan osnovnim zahtjevima i ostalim bitnim odredbama Direktiva 2014/53/EU
Česky [Czech]	[Jméno výrobce] tímto prohlašuje, že tento [typ zařízení] je ve shodě se základními požadavky a dalšími příslušnými ustanoveními směrnice 2014/53/EU.
Dansk [Danish]	Undertegnede [fabrikantens navn] erklærer herved, at følgende udstyr [udstyrets typebetegnelse] overholder de væsentlige krav og øvrige relevante krav i direktiv 2014/53/EU.
Deutsch [German]	Hiermit erklärt [Name des Herstellers], dass sich das Gerät [Gerätetyp] in Übereinstimmung mit den grundlegenden Anforderungen und den übrigen einschlägigen Bestimmungen der Richtlinie 2014/53/EU befindet.

Eesti [Estonian]	Käesolevaga kinnitab [<i>tootja nimi</i>] seadme [<i>seadme tüüp</i>] vastavust direktiivi 2014/53/EL põhinõuetele ja nimetatud direktiivist tulenevatele teistele asjakohastele sätetele.
English	Hereby, [<i>name of manufacturer</i>], declares that this [<i>type of equipment</i>] is in compliance with the essential requirements and other relevant provisions of Directive 2014/53/EU.
Español [Spanish]	Por medio de la presente [<i>nombre del fabricante</i>] declara que el [<i>clase de equipo</i>] cumple con los requisitos esenciales y cualesquiera otras disposiciones aplicables o exigibles de la Directiva 2014/53/UE.
Ελληνική [Greek]	ΜΕ ΤΗΝ ΠΑΡΟΥΣΑ [<i>όνομα του κατασκευαστή</i>] ΔΗΛΩΝΕΙ ΟΤΙ [<i>εξοπλισμού</i>] ΣΥΜΜΟΡΦΩΝΕΤΑΙ ΠΡΟΣ ΤΙΣ ΟΥΣΙΩΔΕΙΣ ΑΠΑΙΤΗΣΕΙΣ ΚΑΙ ΤΙΣ ΛΟΙΠΕΣ ΣΧΕΤΙΚΕΣ ΔΙΑΤΑΞΕΙΣ ΤΗΣ ΟΔΗΓΙΑΣ 2014/53/ΕΕ.
Français [French]	Par la présente [<i>nom du fabricant</i>] déclare que l'appareil [<i>type d'appareil</i>] est conforme aux exigences essentielles et aux autres dispositions pertinentes de la directive 2014/53/UE.
Íslenska [Icelandic]	Hér, [<i>Nafn framleiðanda</i>], því yfir að þetta [<i>gerð búnaðar</i>] tæki er í samræmi við grunnkröfur og önnur viðeigandi ákvæði tilskipana 2014/53/ ESB
Italiano [Italian]	Con la presente [<i>nome del costruttore</i>] dichiara che questo [<i>tipo di apparecchio</i>] è conforme ai requisiti essenziali ed alle altre disposizioni pertinenti stabilite dalla direttiva 2014/53/UE.
Latviešu valoda [Latvian]	Ar šo [<i>izgatavotājas nosaukums</i>] deklarē, ka [<i>iekārtas tips</i>] atbilst Direktīvas 2014/53/ES būtiskajām prasībām un citiem ar to saistītajiem noteikumiem.
Lietuvių kalba [Lithuanian]	Šiuo [<i>gamintojo pavadinimas</i>] deklaruojama, kad šis [<i>įrangos tipas</i>] atitinka esminius reikalavimus ir kitas 2014/53/ES Direktyvos nuostatas.
Nederlands [Dutch]	Hierbij verklaart [<i>naam van de fabrikant</i>] dat het toestel [<i>type van toestel</i>] in overeenstemming is met de essentiële eisen en de andere relevante bepalingen van richtlijn 2014/53/EU.
Malti [Maltese]	Hawnhekk, [<i>isem tal-manifattur</i>], jiddikjara li dan [<i>il-mudel tal-prodott</i>] jikkonforma mal-htigijiet essenzjali u ma provvedimenti oħrajn relevanti li hemm fid-Dirrettiva 2014/53/UE.
Magyar [Hungarian]	Alulírott, [<i>gyártó neve</i>] nyilatkozom, hogy a [<i>... típus</i>] megfelel a vonatkozó alapvető követelményeknek és az 2014/53/EU irányelv egyéb előírásainak.
Norsk [Norwegian]	Herved [<i>navnet på produsenten</i>], erklærer at denne [<i>type utstyr</i>] enheten, er i samsvar med de grunnleggende kravene og andre relevante bestemmelser i direktivene 2014/53/EU
Polski [Polish]	Niniejszym [<i>nazwa producenta</i>] oświadczam, że [<i>nazwa wyrobu</i>] jest zgodny z zasadniczymi wymogami oraz pozostałymi stosownymi postanowieniami Dyrektywy 2014/53/UE.
Português [Portuguese]	[<i>Nome do fabricante</i>] declara que este [<i>tipo de equipamento</i>] está conforme com os requisitos essenciais e outras disposições da Directiva 2014/53/UE.
Română [Romanian]	Prin prezenta, [<i>numele producătorului</i>] declară că acest dispozitiv [<i>tipul de echipament</i>] este în conformitate cu cerințele esențiale și alte prevederi relevante ale Directivelor 2014/53/UE
Slovenščina [Slovenian]	[<i>Ime proizvajalca</i>] izjavlja, da je ta [<i>tip opreme</i>] v skladu z bistvenimi zahtevami in ostalimi relevantnimi določili direktive 2014/53/EU.
Slovenčina [Slovak]	[<i>Menovýrobcu</i>] týmto vyhlasuje, že [<i>typzariadenia</i>] spĺňa základné požiadavky a všetky príslušné ustanovenia Smernice 2014/53/EU.
Suomi [Finnish]	[<i>Valmistaja</i>] vakuuttaa täten että [<i>laitteen tyyppimerkintä</i>] tyyppinen laite on direktiivin 2014/53/EU oleellisten vaatimusten ja sitä koskevien direktiivin muiden ehtojen mukainen.
Svenska [Swedish]	Härmed intygar [<i>företag</i>] att denna [<i>utrustningstyp</i>] står i överensstämmelse med de väsentliga egenskapskrav och övriga relevanta bestämmelser som framgår av direktiv 2014/53/EU.

7.5.1 EU Declarations of Conformity

Manufacturer	Laird Connectivity
Product(s)	LTE Modem

Product Description



Pinnacle 100



LTE Modem

Antenna Photos

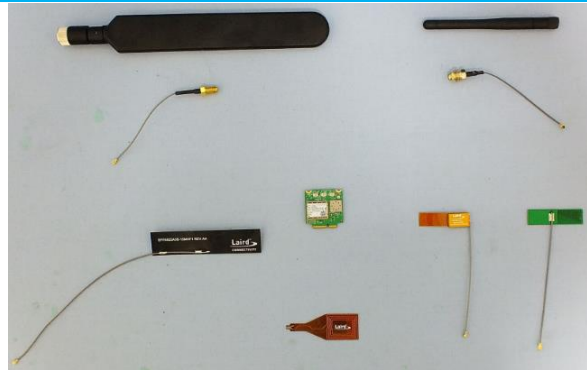

Notified Body (where applicable)

Name of notify body	Telefication
4 digit notified body number:	0560
Conformity assessment Module	Module B
Reference number of the certificate of notified body	

EU Directives 2014/53/EU – Radio Equipment Directive (RED)

Reference standards used for presumption of conformity:

Article Number	Requirement	Reference standard(s)
3.1a	Low voltage equipment safety RF Exposure	EN 62368-1: 2014+A11:2017
		EN 62311:2008
		EN 50385:2017
		EN 50665:2017
3.1b	Protection requirements – Electromagnetic compatibility	EN 301 489-1 v2.2.3 (2019-11)
		EN 301 489-3 v2.1.1 (2019-03)
		EN 301 489-17 v3.2.2 (2019-12) (Draft)
		EN 301 489-52 v1.1.0 (2016-11) (Draft)
3.2	Means of the efficient use of the radio frequency spectrum (ERM)	EN 300 328 v2.2.2 (2019-07)
		EN 300 330 v2.1.1 (2017-02)
		EN 908-1 v11.1.1 (2016-07)
		EN 908-13 v11.1.2 (2017-07)

Declaration:

We, Laird Connectivity, declare under our sole responsibility that the essential radio test suites have been carried out and that the above product to which this declaration relates is in conformity with all the applicable essential requirements of Article 3 of the Radio Equipment Directive 2014/53/EU, when used for its intended purpose.

Place of Issue: Laird Connectivity
W66N220 Commerce Court, Cedarburg, WI 53012 USA
tel: +1-262-375-4400 fax: +1-262-364-2649

Date of Issue: **2020/06/08**

Name of Authorized Person: Ryan Urness

Signature of Authorized Person:



Maximum Power Information

	Frequency	Maximum EIRP Power (dBm)
BT LE	2402-2480 MHz	10
	LTE Band	Maximum Conducted Power (dBm)
Cat-M1	LTE B1	22
	LTE B3	23
	LTE B8	22.5
	LTE B20	23
	LTE B28	23.5
NB-IoT	LTE B1	22
	LTE B3	23
	LTE B8	22.5
	LTE B20	23
	LTE B28	23

SW version: BHL78xx.3.7.2.3

The minimum distance between the user and/or any bystander and the radiating structure of the transmitter is 20 centimeters.

8 ORDERING INFORMATION

Table 29: Order Info

Part Number	Product Description
453-00010	LTE/Bluetooth v5/NFC modem – Integrated antenna LTE & BLE
453-00011	LTE/Bluetooth v5/NFC modem – External antenna
453-00010-K1	Development Kit for 453-00010 modem – Integrated antenna
453-00011-K1	Development Kit for 453-00011 modem – External antenna

9 BLUETOOTH SIG QUALIFICATION

9.1 Overview

The Pinnacle™ 100 modem is listed on the Bluetooth SIG website as a qualified End Product.

Table 30: BLE SIG

Design Name	Owner	Declaration ID	QD ID	Link to listing on the SIG website
Pinnacle™ 100	Laird Connectivity	D046329	145483	https://launchstudio.bluetooth.com/ListingDetails/102649

It is a mandatory requirement of the Bluetooth Special Interest Group (SIG) that every product implementing Bluetooth technology has a Declaration ID. Every Bluetooth design is required to go through the qualification process, even when referencing a Bluetooth Design that already has its own Declaration ID. The Qualification Process requires each company to register as a member of the Bluetooth SIG – www.bluetooth.org

The following link provides a link to the Bluetooth Registration page: <https://www.bluetooth.org/login/register/>

For each Bluetooth Design, it is necessary to purchase a Declaration ID. This can be done before starting the new qualification, either through invoicing or credit card payment. The fees for the Declaration ID will depend on your membership status, please refer to the following webpage:

<https://www.bluetooth.org/en-us/test-qualification/qualification-overview/fees>

For a detailed procedure of how to obtain a new Declaration ID for your design, please refer to the following SIG document:

https://www.bluetooth.org/DocMan/handlers/DownloadDoc.ashx?doc_id=283698&vId=317486

9.2 Qualification Steps When Referencing a Laird Connectivity End Product Design

To start a listing, go to: https://www.bluetooth.org/tpg/QLI_SDoc.cfm

To start the new Design listing select ‘Start the Bluetooth Qualification Process with **No Required Testing**’

In step 1, select the option, **Reference a Qualified Design** with the link above and enter D046329 in the End Product table entry. You can then select your pre-paid Declaration ID from the drop-down menu or go to the Purchase Declaration ID page. Please note that unless the Declaration ID is pre-paid or purchased with a credit card, it will not be possible to proceed until the SIG invoice is paid.

Once all the relevant sections of step 1 are finished, complete steps 2, 3, and 4 as described in the help document. Your new Design will be listed on the SIG website and you can print your Certificate and Declaration of Conformity.

For further information, please refer to the following training material:

<https://www.bluetooth.org/en-us/test-qualification/qualification-overview/listing-process-updates>

9.3 Qualification Steps When Deviating from a Laird Connectivity End Product Design

If you wish to deviate from the standard End Product design listed under D046329, the qualification process follows the Traditional Project route, creating a new design. When creating a new design, it is necessary to complete the full qualification listing process and also maintain a compliance folder for the new design.

The Pinnacle™ 100 design under D046329 incorporates the following components:

Listing reference	Design Name	Core Spec Version
D046329	Controller – Pinnacle 100	5.1
D047806	Host Subsystem – Zephyr 1.14	5.1
D047833	Profile Subsystem	N/A

If your design is based on un-modified Pinnacle™ 100 hardware it is possible use the following process;

1. Reference the existing RF-PHY test report from the Pinnacle™ 100 listing.
2. Combine the relevant Nordic Link Layer (LL) – check QDID with Nordic.
3. Combine in a Host Component (covering L2CAP, GAP, ATT, GATT, SM) - check QDID with Nordic.
4. Test any standard SIG profiles that are supported in the design (customs profiles are exempt).

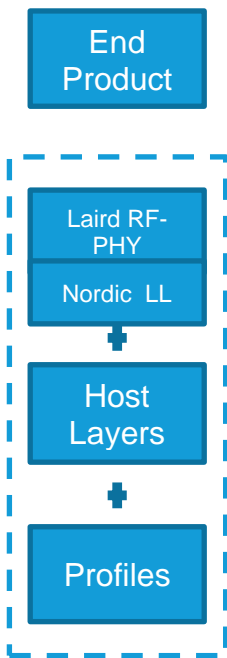

Figure 15: Scope of the qualification for an end product design

When creating a new design, you must chose “Start the Bluetooth Qualification Process with **Required Testing**”

The first step is to generate a project on the TPG (Test Plan Generator) system. This determines which test cases apply to demonstrate compliance with the Bluetooth Test Specifications. If you are combining pre-tested and qualified components in your design and they are within their three-year listing period, you are not required to re-test those layers covered by these components.

If the design incorporates any standard SIG LE profiles (such as Heart Rate Profile), it is necessary to test these profiles using PTS or other tools where permitted; the results are added to the compliance folder.

You are required to upload your test declaration and test reports (where applicable) and then complete the final listing steps on the SIG website. Remember to purchase your Declaration ID before you start the qualification process, as it’s impossible to complete the listing without it.

10 PTCRB

Pinnacle 100 Modem – Integrated Antenna (453-00010)

<https://www.ptcrb.com/certified-devices/device-details/?model=43744>

Pinnacle 100 Modem – External Antenna (453-00011)

<https://www.ptcrb.com/certified-devices/device-details/?model=43743>

11 GLOBAL CERTIFICATION FORUM (GFC)

Pinnacle 100 Modem – Integrated Antenna (453-00010)

https://www.globalcertificationforum.org/pub_product/8933.html

Pinnacle 100 Modem – External Antenna (453-00011)

https://www.globalcertificationforum.org/pub_product/8934.html

12 CARRIER CERTIFICATION

12.1 AT&T

Review listing on the AT&T certified devices database (<https://iotdevices.att.com/certified-devices.aspx>) by typing in *Pinnacle 100* into the Search function.

12.2 Verizon (Pending)

12.3 Vodafone (Pending)

13 ADDITIONAL ASSISTANCE

Please contact your local sales representative or our support team for further assistance:

Laird Connectivity Products Business Unit

Support Centre: <http://ews-support.lairdconnect.com>

Email: wireless.support@lairdconnect.com

Phone: Americas: +1-800-492-2320

Europe: +44-1628-858-940

Hong Kong: +852 2923 0610

Web: www.lairdconnect.com/products

Any information furnished by Laird Connectivity, its subsidiary companies and its agents (hereafter, "Laird Connectivity") is believed to be accurate and reliable. All specifications are subject to change without notice. Responsibility for the use and application of Laird Connectivity materials rests with the end user, since Laird Connectivity and its agents cannot be aware of all potential uses. Laird Connectivity makes no warranties as to the fitness, merchantability or suitability of any Laird Connectivity materials or products for any specific or general uses. Laird Connectivity disclaims liability for incidental or consequential damages of any kind. All Laird Connectivity products are sold pursuant to the Laird Connectivity Terms and Conditions of sale in effect at the time of sale. A current copy of the Laird Connectivity Terms and Conditions will be furnished upon request. This document is © Copyright 2020, Laird Connectivity, Inc., all rights reserved. Laird Connectivity, the Laird Connectivity Logo, and other marks are trademarks of Laird Connectivity. Other product or service names may be the property of third parties. Nothing herein provides a license under any Laird Connectivity or any third-party intellectual property rights.