

FCC Test Report

FCC ID : SQG-MT320
Equipment : WiFi 6 + Bluetooth 5.4 Module
Model No. : Sona MT320
Brand Name : Laird Connectivity
Applicant : Laird Connectivity LLC
Address : W66N220 Commerce Court, Cedarburg, WI
53012 United States Of America
Standard : 47 CFR FCC Part 15.247
Received Date : Sep. 25, 2023
Tested Date : Oct. 24 ~ Dec. 08, 2023

We, International Certification Corporation, would like to declare that the tested sample has been evaluated and in compliance with the requirement of the above standards. The test results contained in this report refer exclusively to the product. It shall not be reproduced except in full without the written approval of our laboratory.

Reviewed by:

Approved by:

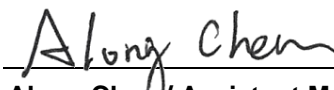

Along Chen / Assistant Manager



Gary Chang / Manager

Table of Contents

1	GENERAL DESCRIPTION	5
1.1	Information.....	5
1.2	Local Support Equipment List	8
1.3	Test Setup Chart	8
1.4	Test Equipment List and Calibration Data.....	10
1.5	Test Standards	11
1.6	Reference Guidance	11
1.7	Deviation from Test Standard and Measurement Procedure.....	11
1.8	Measurement Uncertainty	11
2	TEST CONFIGURATION.....	12
2.1	Testing Facility	12
2.2	The Worst Test Modes and Channel Details	12
3	TRANSMITTER TEST RESULTS	13
3.1	6dB and Occupied Bandwidth	13
3.2	Conducted Output Power	14
3.3	Power Spectral Density	15
3.4	Unwanted Emissions in Restricted Frequency Bands.....	16
3.5	Emissions in non-restricted Frequency Bands.....	18
3.6	AC Power Line Conducted Emissions	19
4	TEST LABORATORY INFORMATION	20

Appendix A. 6dB and Occupied Bandwidth

Appendix B. Conducted Output Power

Appendix C. Power Spectral Density

Appendix D. Unwanted Emissions into Restricted Frequency Bands

Appendix E. Emissions in Non-Restricted Frequency Bands

Appendix F. AC Power Line Conducted Emissions

Release Record

Report No.	Version	Description	Issued Date
FR392501AE	Rev. 01	Initial issue	Jan. 23, 2024
FR392501AE	Rev. 02	Product name changed	Feb. 08, 2024

Summary of Test Results

FCC Rules	Test Items	Measured	Result
15.207	AC Power Line Conducted Emissions	[dBuV]: 0.410MHz 32.35 (Margin -15.29dB) - AV	Pass
15.247(d) 15.209	Unwanted Emissions	[dBuV/m at 3m]: 40.67MHz 31.14 (Margin -8.86dB - PK	Pass
15.247(b)(3)	Conducted Output Power	Power [dBm]: 7.37	Pass
15.247(a)(2)	6dB Bandwidth	Meet the requirement of limit	Pass
15.247(e)	Power Spectral Density	Meet the requirement of limit	Pass
15.203	Antenna Requirement	Meet the requirement of limit	Pass

Declaration of Conformity:

The test results with all measurement uncertainty excluded are presented in accordance with the regulation limits or requirements declared by manufacturers.

Comments and Explanations:

The declared of product specification for EUT presented in the report are provided by the manufacturer, and the manufacturer takes all the responsibilities for the accuracy of product specification.

1 General Description

1.1 Information

1.1.1 Product Details

The two configurations of the EUT are shown on the following:

Brand Name	Model Name	Description
Laird Connectivity	Sona MT320	MT320-SC (MHF4 connector on module)
		MT320-ST (RF trace variant)

1.1.2 Specification of the Equipment under Test (EUT)

RF General Information				
Frequency Range (MHz)	Bluetooth Mode	Ch. Freq. (MHz)	Channel Number	Data Rate
2400-2483.5	LE	2402-2480	40	125 kbps
				500 kbps
		2404-2478	37	1 Mbps
				2 Mbps

Note: Bluetooth LE (Low energy) uses GFSK modulation.

1.1.3 Antenna Details

Ant. No.	Manufacturer	Model	Part Number	Type	Connector	Gain (dBi)
1	Laird Connectivity	FlexMIMO 6E	EFD2471A3S-10 MH4L	PIFA	MHF4L	2.2
2	Laird Connectivity	FlexPIFA 6E	EFB2471A3S-10 MH4L	PIFA	MHF4L	2.2
3	Laird Connectivity	Mini NanoBlade Flex 6 GHz	EMF2471A3S-10 MH4L	PCB Dipole	MHF4L	2.4
4	Joymax Electronics	Dipole 6E	TWX-100BRS3B	Dipole	RP-SMA	2

1.1.4 Power Supply Type of Equipment under Test (EUT)

Power Supply Type	3.3Vdc from host
-------------------	------------------

1.1.5 Accessories

N/A

1.1.6 Channel List

Frequency band (MHz)				2402-2480 / BT-LE (125kbps/500kbps/1Mbps)			
Channel	Frequency (MHz)	Channel	Frequency (MHz)	Channel	Frequency (MHz)	Channel	Frequency (MHz)
37	2402	9	2422	18	2442	28	2462
0	2404	10	2424	19	2444	29	2464
1	2406	38	2426	20	2446	30	2466
2	2408	11	2428	21	2448	31	2468
3	2410	12	2430	22	2450	32	2470
4	2412	13	2432	23	2452	33	2472
5	2414	14	2434	24	2454	34	2474
6	2416	15	2436	25	2456	35	2476
7	2418	16	2438	26	2458	36	2478
8	2420	17	2440	27	2460	39	2480

Frequency band (MHz)				2404-2478 / BT-LE(2Mbps)			
Channel	Frequency (MHz)	Channel	Frequency (MHz)	Channel	Frequency (MHz)	Channel	Frequency (MHz)
0	2404	10	2424	20	2446	30	2466
1	2406	11	2428	21	2448	31	2468
2	2408	12	2430	22	2450	32	2470
3	2410	13	2432	23	2452	33	2472
4	2412	14	2434	24	2454	34	2474
5	2414	15	2436	25	2456	35	2476
6	2416	16	2438	26	2458	36	2478
7	2418	17	2440	27	2460	--	--
8	2420	18	2442	28	2462	--	--
9	2422	19	2444	29	2464	--	--

1.1.7 Test Tool and Duty Cycle

Test Tool	WCN Combo tool, version: W2316	
Modulation Mode	Duty Cycle Of Test Signal (%)	Duty Factor (dB)
BT-LE(125kbps)	98.28%	0.08
BT-LE(500kbps)	91.69%	0.38
BT-LE(1Mbps)	86.24%	0.64
BT-LE(2Mbps)	58.06%	2.36

1.1.8 Power Index of Test Tool

Modulation Mode	Test Frequency (MHz)		
	2402	2440	2480
BT-LE(125kbps)	7	7	7
BT-LE(500kbps)	7	7	7
BT-LE(1Mbps)	7	7	7

Modulation Mode	Test Frequency (MHz)		
	2404	2440	2478
BT-LE(2Mbps)	7	7	7

1.2 Local Support Equipment List

Support Equipment List					
No.	Equipment	Brand	Model	FCC ID	Remarks
1	Laptop	DELL	Latitude 5400	DoC	---
2	Fixture	---	---	---	Provided by applicant.
3	Fixture's adapter	---	---	---	Provided by applicant. I/P: 100-240Vac, 1.5A, 50-60Hz O/P: 5.0V 3.0A
4	Carrier board	---	---	---	Provided by applicant.
5	50Ω terminator	---	---	---	---

Note: The support laptop was disconnected from EUT and was removed from testing table after sending command to EUT to transmit continuously.

1.3 Test Setup Chart

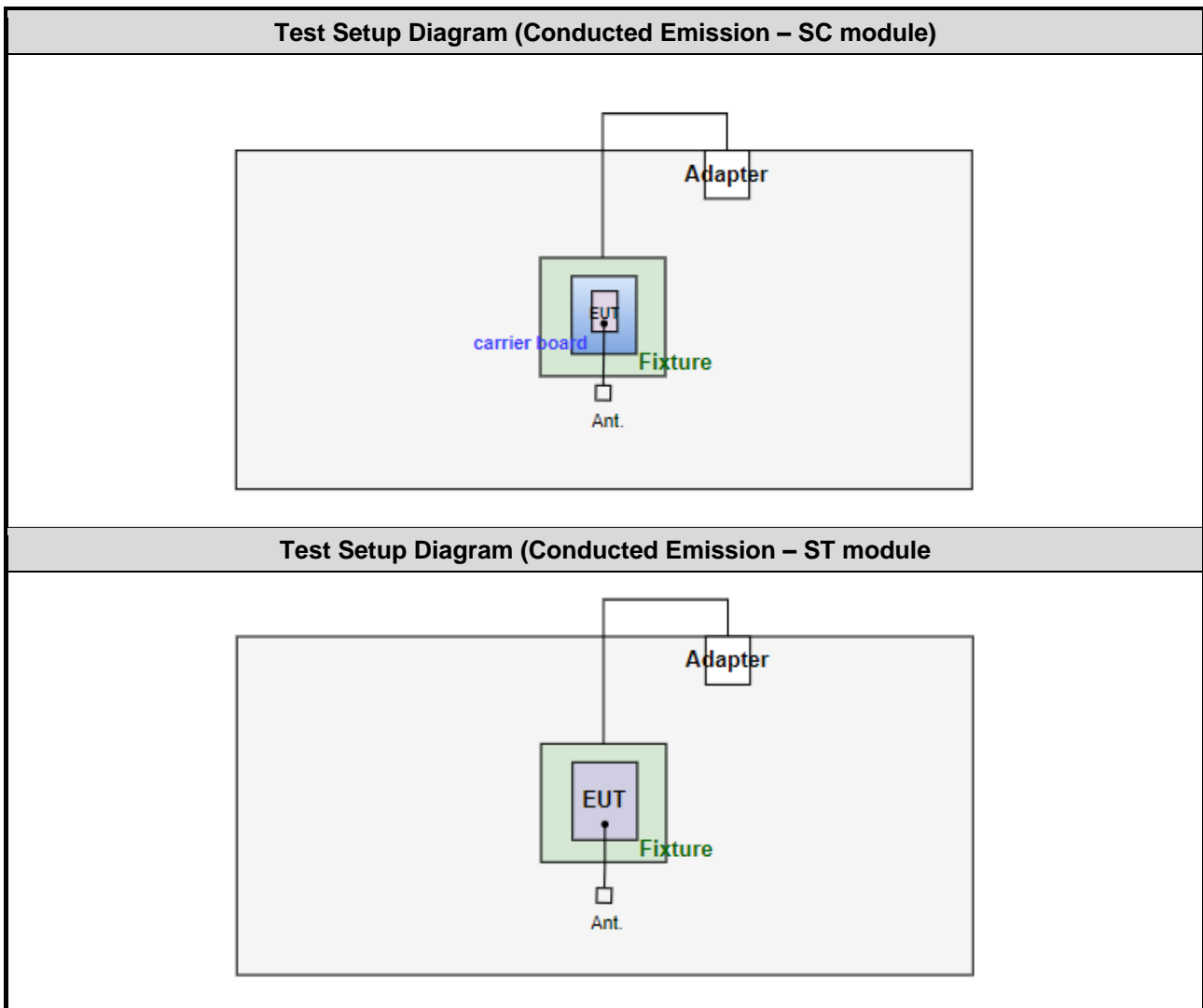

Test Setup Diagram (Radiated Emission – SC module)

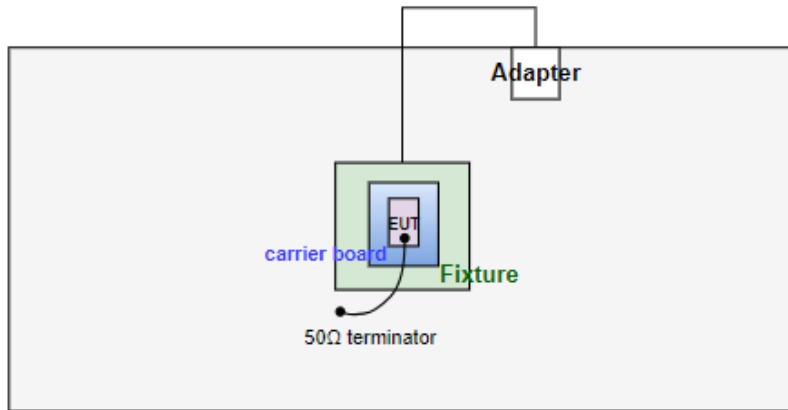

Test Setup Diagram (Radiated Emission – ST module)

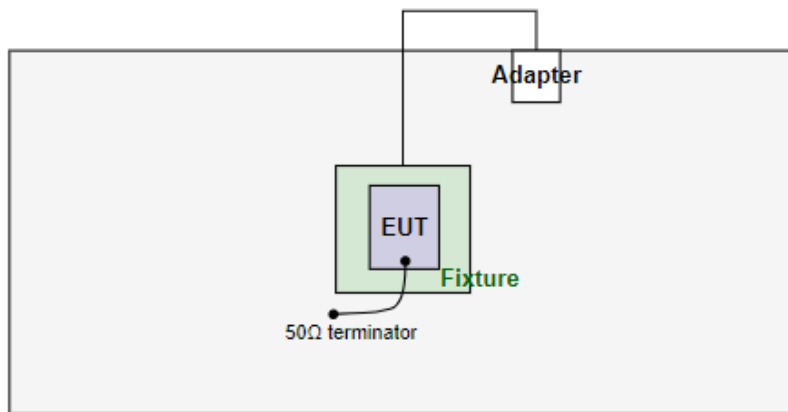

1.4 Test Equipment List and Calibration Data

Test Item	Conducted Emission				
Test Site	Conduction room 1 / (CO01-WS)				
Tested Date	Dec. 08, 2023				
Instrument	Brand	Model No.	Serial No.	Calibration Date	Calibration Until
Receiver	R&S	ESR3	101658	Feb. 17, 2023	Feb. 16, 2024
LISN	R&S	ENV216	101579	May. 09, 2023	May. 08, 2024
LISN (Support Unit)	SCHWARZBECK	Schwarzbeck 8127	8127667	Jan. 03, 2023	Jan. 02, 2024
RF Cable-CON	Woken	CFD200-NL	CFD200-NL-001	Oct. 11, 2023	Oct. 10, 2024
50 ohm terminal (Support Unit)	NA	50	01	Jun. 14, 2023	Jun. 13, 2024
Measurement Software	AUDIX	e3	6.120210k	NA	NA

Note: Calibration Interval of instruments listed above is one year.

Test Item	Radiated Emission				
Test Site	966 chamber1 / (03CH01-WS)				
Tested Date	Oct. 24, 2023				
Instrument	Brand	Model No.	Serial No.	Calibration Date	Calibration Until
Receiver	R&S	ESR3	101657	Mar. 03, 2023	Mar. 02, 2024
Spectrum Analyzer	R&S	FSV40	101498	Nov. 21, 2022	Nov. 20, 2023
Loop Antenna	R&S	HFH2-Z2	100330	Nov. 01, 2022	Oct. 31, 2023
Bilog Antenna	SCHWARZBECK	VULB9168	VULB9168-522	Jul. 31, 2023	Jul. 30, 2024
Horn Antenna 1G-18G	SCHWARZBECK	BBHA 9120 D	BBHA 9120 D 1096	Nov. 25, 2022	Nov. 24, 2023
Horn Antenna 18G-40G	SCHWARZBECK	BBHA 9170	BBHA 9170517	Oct. 27, 2022	Oct. 26, 2023
Preamplifier	EMC	EMC02325	980225	Jun. 28, 2023	Jun. 27, 2024
Preamplifier	EMC	EMC118A45SE	980898	Jul. 14, 2023	Jul. 13, 2024
Preamplifier	EMC	EMC184045SE	980903	Jul. 17, 2023	Jul. 16, 2024
Loop Antenna Cable	KOAX KABEL	101354-BW	101354-BW	Oct. 03, 2023	Oct. 02, 2024
LF cable 3M	Woken	CFD400NL-LW	CFD400NL-001	Oct. 03, 2023	Oct. 02, 2024
LF cable 11M	EMC	EMCCFD400-NW-NW-1 1000	200801	Oct. 03, 2023	Oct. 02, 2024
LF cable 1M	EMC	EMCCFD400-NM-NM-1 000	160502	Oct. 03, 2023	Oct. 02, 2024
RF Cable	EMC	EMC104-35M-35M-8000	210920	Oct. 03, 2023	Oct. 02, 2024
RF Cable	EMC	EMC104-35M-35M-3000	210922	Oct. 03, 2023	Oct. 02, 2024
Measurement Software	AUDIX	e3	6.120210g	NA	NA

Note: Calibration Interval of instruments listed above is one year.

Test Item	RF Conducted				
Test Site	(TH01-WS)				
Tested Date	Nov. 06 ~ Nov. 10, 2023				
Instrument	Brand	Model No.	Serial No.	Calibration Date	Calibration Until
Spectrum Analyzer	R&S	FSV40	101910	Apr. 14, 2023	Apr. 13, 2024
Power Meter	Anritsu	ML2495A	1241001	Jan. 11, 2023	Jan. 10, 2024
Power Sensor	Anritsu	MA2411B	1911228	Jan. 11, 2023	Jan. 10, 2024
Attenuator	Pasternack	PE7005-10	10-2	Oct. 05, 2023	Oct. 04, 2024
HIGHPASS FILTER 3.1-18G	WHK	WHK3.1/18G-10SS	39	Oct. 05, 2023	Oct. 04, 2024
LOWPASS FILTER	WI	WLKS1100-12SS	2	Oct. 05, 2023	Oct. 04, 2024
Measurement Software	Sporton	SENSE-15247_FS	V5.10.8	NA	NA
Note: Calibration Interval of instruments listed above is one year.					

1.5 Test Standards

47 CFR FCC Part 15.247
ANSI C63.10-2013

1.6 Reference Guidance

FCC KDB 558074 D01 15.247 Meas Guidance v05r02

1.7 Deviation from Test Standard and Measurement Procedure

None

1.8 Measurement Uncertainty

The measurement uncertainties given below are based on a 95% confidence level (based on a coverage factor ($k=2$)).

Measurement Uncertainty	
Parameters	Uncertainty
Bandwidth	±34.130 Hz
Conducted power	±0.808 dB
Power density	±0.583 dB
Conducted emission	±2.715 dB
AC conducted emission	±2.92 dB
Unwanted Emission ≤ 1GHz	±3.41 dB
Unwanted Emission > 1GHz	±4.59 dB

2 Test Configuration

2.1 Testing Facility

Test Laboratory	International Certification Corporation
Test Site	CO01-WS, 03CH01-WS, TH01-WS
Address of Test Site	No.3-1, Lane 6, Wen San 3rd St., Kwei Shan Dist., Tao Yuan City 33381, Taiwan (R.O.C.)

- FCC Designation No.: TW2732
- FCC site registration No.: 181692
- ISED#: 10807A
- CAB identifier: TW2732

2.2 The Worst Test Modes and Channel Details

Test item	Modulation Mode	Test Frequency (MHz)	Test method	Mode	Test Configuration	Note
AC Power Line Conducted Emissions	BT-LE(1Mbps)	2402	Conducted	TX	1	-
Unwanted Emissions ≤ 1GHz	BT-LE(1Mbps)	2402	Radiated	TX	1, 2	Note 2
Unwanted Emissions > 1GHz	BT-LE(1Mbps) BT-LE(2Mbps)	2402, 2440, 2480 2404, 2440, 2478	Radiated	TX	1	Note 2
	BT-LE(1Mbps)	2440			2	
Unwanted Emissions ≤ 1GHz	BT-LE(1Mbps)	2480	Conducted	TX	1	-
		2402			2	-
Unwanted Emissions > 1GHz	BT-LE(1Mbps) BT-LE(2Mbps)	2402, 2440, 2480 2404, 2440, 2478	Conducted	TX	1	-
	BT-LE(1Mbps)	2480			2	-
Conducted Output Power	BT-LE(125kbps)	2402, 2440, 2480	Conducted	TX	1, 2	-
	BT-LE(500kbps)	2402, 2440, 2480				
	BT-LE(1Mbps)	2402, 2440, 2480				
	BT-LE(2Mbps)	2404, 2440, 2478				
6dB bandwidth Power spectral density	BT-LE(125kbps)	2402, 2440, 2480	Conducted	TX	1	-
	BT-LE(500kbps)	2402, 2440, 2480				
	BT-LE(1Mbps)	2402, 2440, 2480				
	BT-LE(2Mbps)	2404, 2440, 2478				

NOTE:

1. The EUT was pretested with 3 orientations placed on the table for the radiated emission measurement – X, Y, and Z-plane. The **Y-plane** result was found as the worst case and was shown in this report.
2. The 50Ω terminator is connected to antenna port of EUT for radiated emission measurement.
3. Test configurations are listed as below:
Configuration 1: SC Module
Configuration 2: ST Module

3 Transmitter Test Results

3.1 6dB and Occupied Bandwidth

3.1.1 Limit of 6dB Bandwidth

The minimum 6dB bandwidth shall be at least 500 kHz.

3.1.2 Test Procedures

6dB Bandwidth

1. Set resolution bandwidth (RBW) = 100 kHz, Video bandwidth = 300 kHz.
2. Detector = Peak, Trace mode = max hold.
3. Sweep = auto couple, Allow the trace to stabilize.
4. Measure the maximum width of the emission that is constrained by the frequencies associated with the two outermost amplitude points (upper and lower) that are attenuated by 6dB relative to the maximum level measured in the fundamental emission.

Occupied Bandwidth

1. Set resolution bandwidth (RBW) = 1% ~ 5 % of OBW, Video bandwidth = 3 x RBW
2. Detector = Sample, Trace mode = max hold.
3. Sweep = auto couple, Allow the trace to stabilize.
4. Use the OBW measurement function of spectrum analyzer to measure the occupied bandwidth.

3.1.3 Test Setup

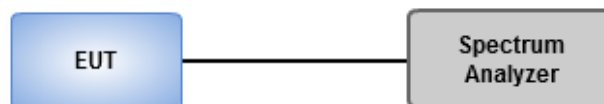

3.1.4 Test Results

Ambient Condition	23°C / 65-68%	Tested By	Roger Lu
--------------------------	---------------	------------------	----------

Refer to Appendix A.

3.2 Conducted Output Power

3.2.1 Limit of Conducted Output Power

Conducted power shall not exceed 1Watt.

Antenna gain $\leq 6\text{dBi}$, no any corresponding reduction is in output power limit.

3.2.2 Test Procedures

A broadband RF power meter is used for output power measurement. The video bandwidth of power meter is greater than DTS bandwidth of EUT. If duty cycle of test signal is not 100 %, trigger and gating function of power meter will be enabled to capture transmission burst for measuring output power.

3.2.3 Test Setup



3.2.4 Test Results

Ambient Condition	23°C / 65-68%	Tested By	Roger Lu
--------------------------	---------------	------------------	----------

Refer to Appendix B.

3.3 Power Spectral Density

3.3.1 Limit of Power Spectral Density

Power spectral density shall not be greater than 8 dBm in any 3 kHz band.

3.3.2 Test Procedures

1. Set the RBW = 3 kHz, VBW = 10 kHz.
2. Detector = Peak, Sweep time = auto couple.
3. Trace mode = max hold, allow trace to fully stabilize.
4. Use the peak marker function to determine the maximum amplitude level.

3.3.3 Test Setup

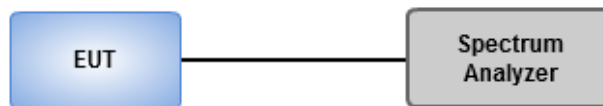

3.3.4 Test Results

Ambient Condition	23°C / 65-68%	Tested By	Roger Lu
--------------------------	---------------	------------------	----------

Refer to Appendix C.

3.4 Unwanted Emissions in Restricted Frequency Bands

3.4.1 Limit of Unwanted Emissions in Restricted Frequency Bands

Restricted Band Emissions Limit			
Frequency Range (MHz)	Field Strength (uV/m)	Field Strength (dBuV/m)	Measure Distance (m)
0.009~0.490	2400/F(kHz)	48.5 - 13.8	300
0.490~1.705	24000/F(kHz)	33.8 - 23	30
1.705~30.0	30	29	30
30~88	100	40	3
88~216	150	43.5	3
216~960	200	46	3
Above 960	500	54	3

Note 1:
Quasi-Peak value is measured for frequency below 1GHz except for 9–90 kHz, 110–490 kHz frequency band. Peak and average value are measured for frequency above 1GHz. The limit on average radio frequency emission is as above table. The limit on peak radio frequency emissions is 20 dB above the maximum permitted average emission limit

Note 2:
Measurements may be performed at a distance other than what is specified provided. When performing measurements at a distance other than that specified, the results shall be extrapolated to the specified distance using an extrapolation factor as below, Frequency at or above 30 MHz: 20 dB/decade Frequency below 30 MHz: 40 dB/decade.

3.4.2 Test Procedures

1. Measurement is made at a semi-anechoic chamber that incorporates a turntable allowing a EUT rotation of 360°. A continuously-rotating, remotely-controlled turntable is installed at the test site to support the EUT and facilitate determination of the direction of maximum radiation for each EUT emission frequency. The EUT is placed at test table. For emissions testing at or below 1 GHz, the table height is 80 cm above the reference ground plane. For emission measurements above 1 GHz, the table height is 1.5 m
2. Measurement is made with the antenna positioned in both the horizontal and vertical planes of polarization. The measurement antenna is varied in height (1m ~ 4m) above the reference ground plane to obtain the maximum signal strength. Distance between EUT and antenna is 3 m.
3. This investigation is performed with the EUT rotated 360°, the antenna height scanned between 1 m and 4 m, and the antenna rotated to repeat the measurements for both the horizontal and vertical antenna polarizations.

Note:

1. 120kHz measurement bandwidth of test receiver and Quasi-peak detector is for radiated emission below 1GHz.
2. RBW=1MHz, VBW=3MHz and Peak detector is for peak measured value of radiated emission above 1GHz.
3. RBW=1MHz, VBW=1/T and Peak detector is for average measured value of radiated emission above 1GHz.

3.4.3 Test Setup

Radiated Emissions below 1 GHz

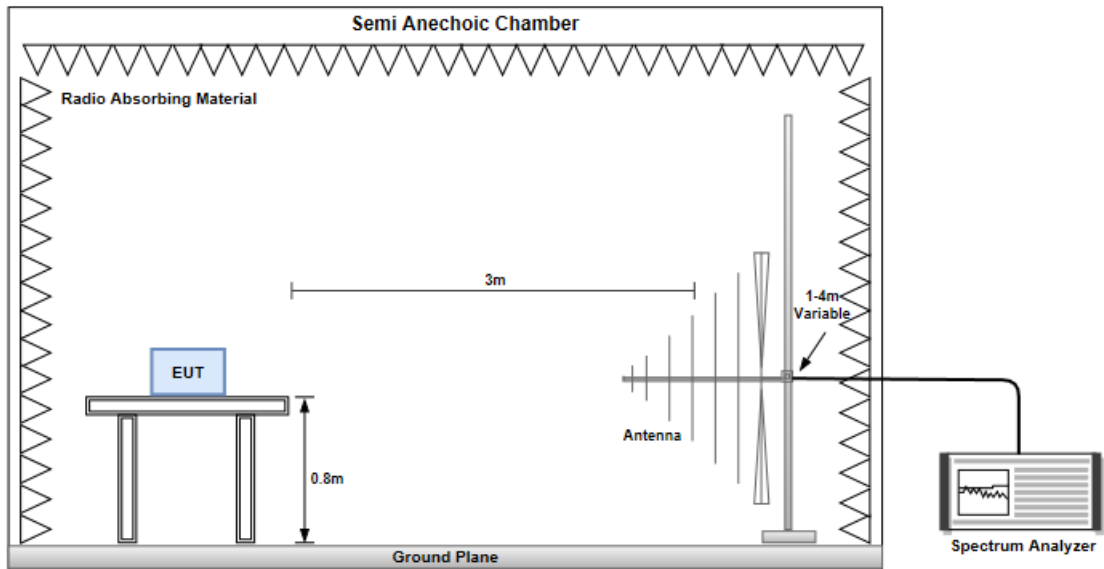

Radiated Emissions above 1 GHz

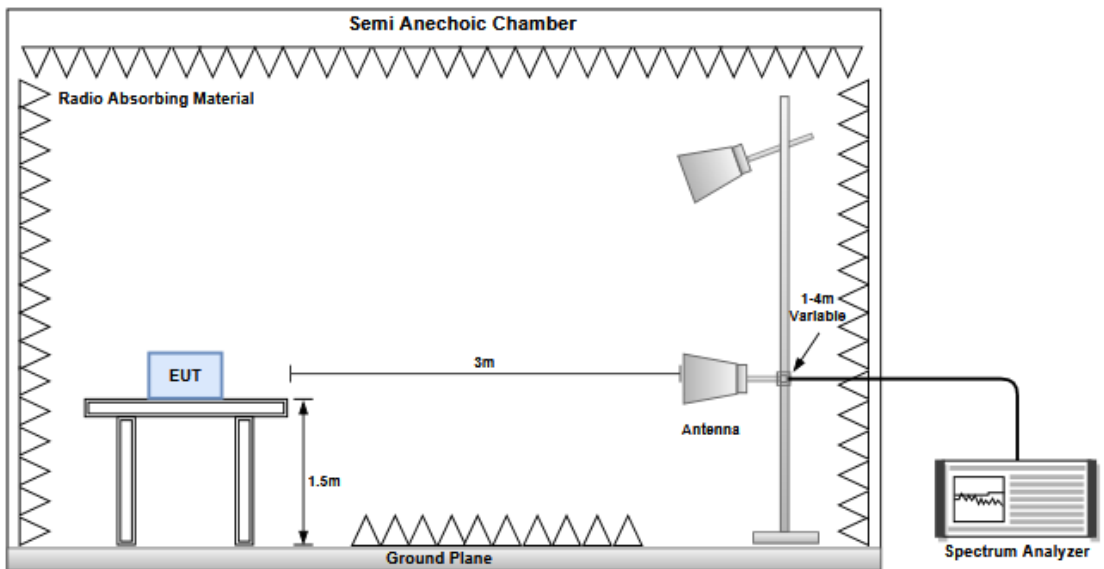

3.4.4 Test Results

Refer to Appendix D.

3.5 Emissions in non-restricted Frequency Bands

3.5.1 Emissions in non-restricted frequency bands limit

Peak power in any 100 kHz bandwidth outside of the authorized frequency band shall be attenuated by at least 20 dB relative to the maximum in-band peak PSD level in 100 kHz.

3.5.2 Test Procedures

Reference level measurement

1. Set RBW=100kHz, VBW = 300kHz , Detector = Peak, Sweep time = Auto
2. Trace = max hold , Allow Trace to fully stabilize
3. Use the peak marker function to determine the maximum PSD level

Emission level measurement

1. Set RBW=100kHz, VBW = 300kHz , Detector = Peak, Sweep time = Auto
2. Trace = max hold , Allow Trace to fully stabilize
3. Scan Frequency range is up to 25GHz
4. Use the peak marker function to determine the maximum amplitude level

3.5.3 Test Setup

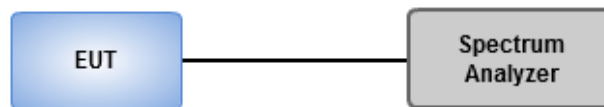

3.5.4 Test Results

Ambient Condition	23°C / 65-68%	Tested By	Roger Lu
--------------------------	---------------	------------------	----------

Refer to Appendix E.

3.6 AC Power Line Conducted Emissions

3.6.1 Limit of AC Power Line Conducted Emissions

Conducted Emissions Limit		
Frequency Emission (MHz)	Quasi-Peak	Average
0.15-0.5	66 - 56 *	56 - 46 *
0.5-5	56	46
5-30	60	50

Note 1: * Decreases with the logarithm of the frequency.

3.6.2 Test Procedures

1. The device is placed on a test table, raised 80 cm above the reference ground plane. The vertical conducting plane is located 40 cm to the rear of the device.
2. The device is connected to line impedance stabilization network (LISN) and other accessories are connected to other LISN. Measured levels of AC power line conducted emission are across the 50 Ω LISN port.
3. AC conducted emission measurements is made over frequency range from 150 kHz to 30 MHz.
4. This measurement was performed with AC 120V/60Hz

3.6.3 Test Setup

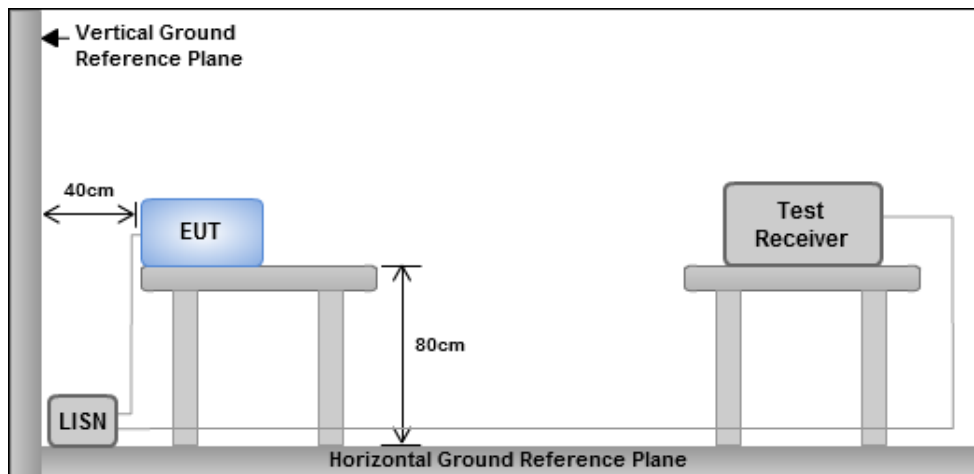

- Note: 1. Support units were connected to second LISN.
 2. Both of LISNs (AMN) are 80 cm from EUT and at least 80 cm from other units and other metal planes

3.6.4 Test Results

Refer to Appendix F.

4 Test laboratory information

Established in 2012, ICC provides foremost EMC & RF Testing and advisory consultation services by our skilled engineers and technicians. Our services employ a wide variety of advanced edge test equipment and one of the widest certification extents in the business.

International Certification Corporation (EMC and Wireless Communication Laboratory), it is our definitive objective is to institute long term, trust-based associations with our clients. The expectation we set up with our clients is based on outstanding service, practical expertise and devotion to a certified value structure. Our passion is to grant our clients with best EMC / RF services by oriented knowledgeable and accommodating staff.

Our Test sites are located at Linkou District and Kwei Shan District. Location map can be found on our website <http://www.icertifi.com.tw>.

Linkou

Tel: 886-2-2601-1640

No.30-2, Ding Fwu Tsuen, Lin Kou
District, New Taipei City, Taiwan
(R.O.C.)

Kwei Shan

Tel: 886-3-271-8666

No.3-1, Lane 6, Wen San 3rd
St., Kwei Shan Dist., Tao Yuan
City 33381, Taiwan (R.O.C.)
No.2-1, Lane 6, Wen San 3rd
St., Kwei Shan Dist., Tao Yuan
City 33381, Taiwan (R.O.C.)

Kwei Shan Site II

Tel: 886-3-271-8640

No.14-1, Lane 19, Wen San 3rd
St., Kwei Shan Dist., Tao Yuan
City 33381, Taiwan (R.O.C.)

If you have any suggestion, please feel free to contact us as below information.

Tel: 886-3-271-8666

Fax: 886-3-318-0155

Email: ICC_Service@icertifi.com.tw

==END==



Summary

Mode	Max-N dB (Hz)	Max-OBW (Hz)	ITU-Code	Min-N dB (Hz)	Min-OBW (Hz)
2.4-2.4835GHz	-	-	-	-	-
BT-LE(125kbps)	698.75k	1.059M	1M06F1D	693.75k	1.055M
BT-LE(500kbps)	677.5k	1.026M	1M03F1D	660k	1.022M
BT-LE(1Mbps)	665k	1.032M	1M03F1D	661.25k	1.03M
BT-LE(2Mbps)	1.185M	2.057M	2M06F1D	1.173M	2.053M

Max-N dB = Maximum 6dB down bandwidth; Max-OBW = Maximum 99% occupied bandwidth;
Min-N dB = Minimum 6dB down bandwidth; Min-OBW = Minimum 99% occupied bandwidth

Result

Mode	Result	Limit (Hz)	Port 1-N dB (Hz)	Port 1-OBW (Hz)
BT-LE(125kbps)	-	-	-	-
2402MHz	Pass	500k	693.75k	1.059M
2440MHz	Pass	500k	698.75k	1.057M
2480MHz	Pass	500k	697.5k	1.055M
BT-LE(500kbps)	-	-	-	-
2402MHz	Pass	500k	666.25k	1.026M
2440MHz	Pass	500k	660k	1.025M
2480MHz	Pass	500k	677.5k	1.022M
BT-LE(1Mbps)	-	-	-	-
2402MHz	Pass	500k	661.25k	1.032M
2440MHz	Pass	500k	663.75k	1.03M
2480MHz	Pass	500k	665k	1.032M
BT-LE(2Mbps)	-	-	-	-
2404MHz	Pass	500k	1.173M	2.053M
2440MHz	Pass	500k	1.185M	2.057M
2478MHz	Pass	500k	1.185M	2.055M

Port X-N dB = Port X 6dB down bandwidth;
Port X-OBW = Port X 99% occupied bandwidth



2.4-2.4835GHz_BT-LE(125kbps)

EBW-DTS

2402MHz

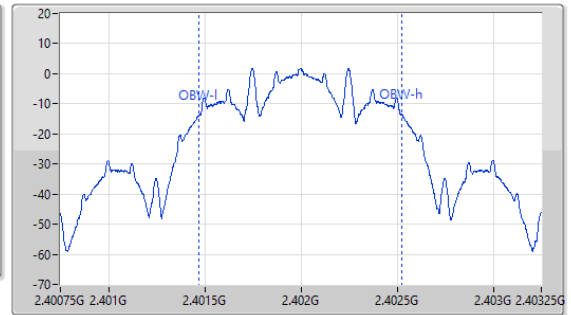
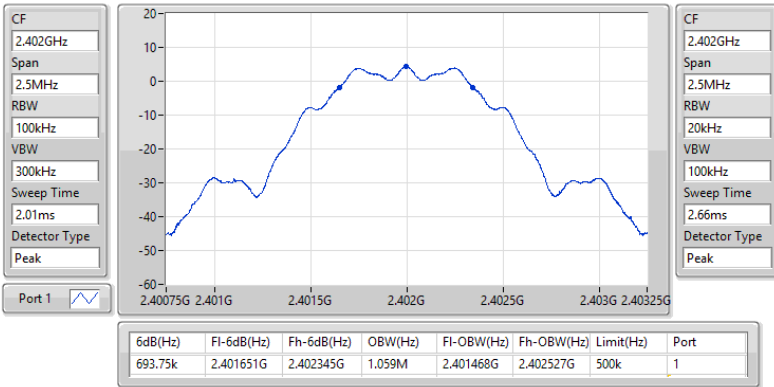

2.4-2.4835GHz_BT-LE(125kbps)

EBW-DTS

2440MHz

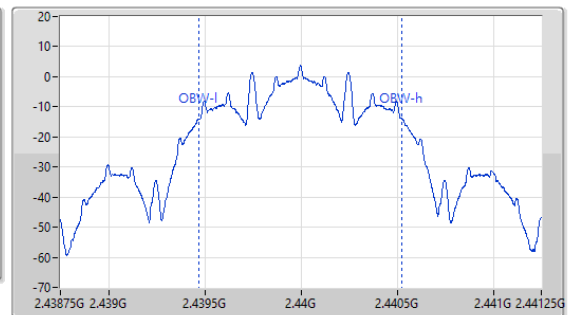
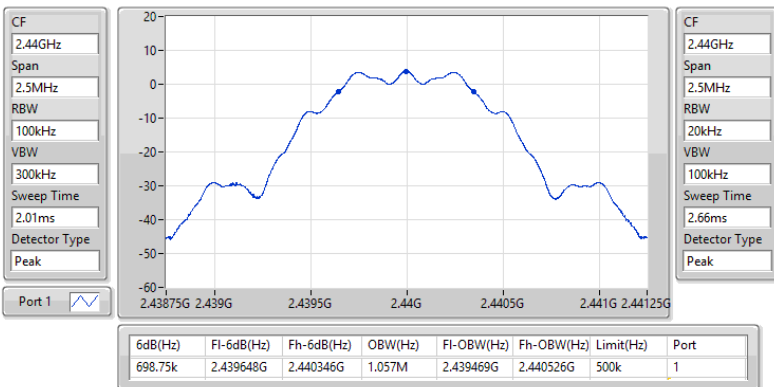



2.4-2.4835GHz_BT-LE(125kbps)

EBW-DTS

2480MHz

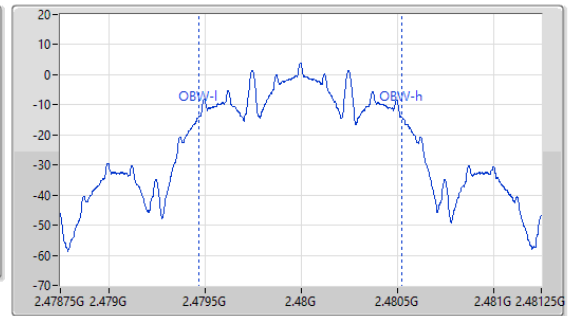
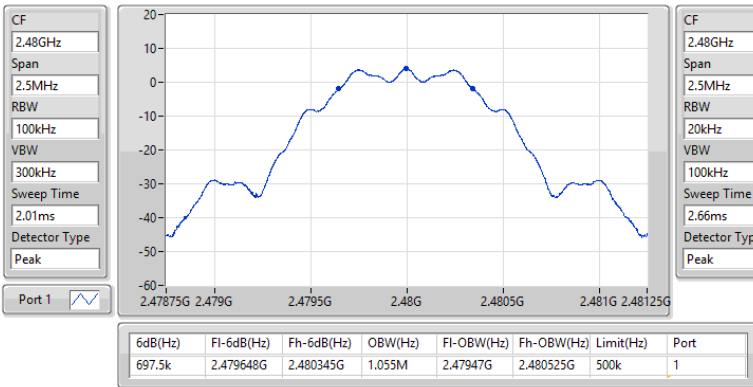

2.4-2.4835GHz_BT-LE(500kbps)

EBW-DTS

2402MHz

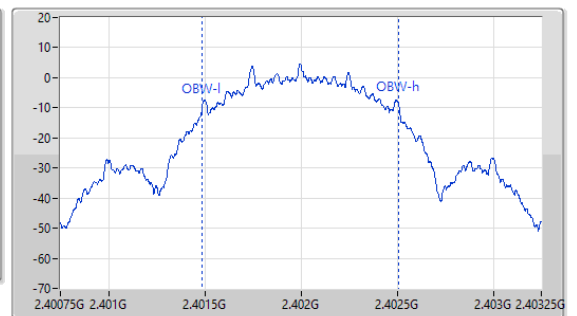
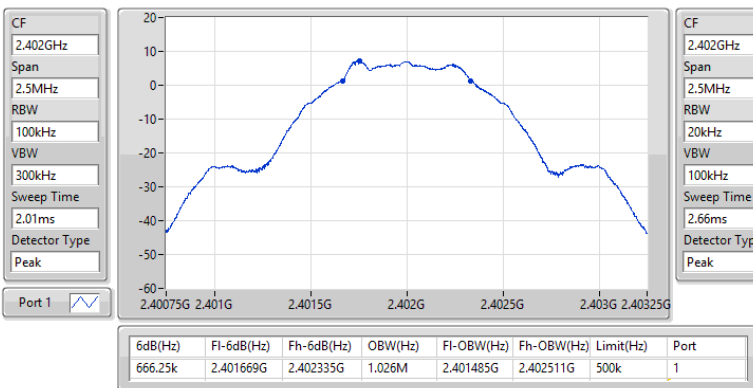



2.4-2.4835GHz_BT-LE(500kbps)

EBW-DTS

2440MHz

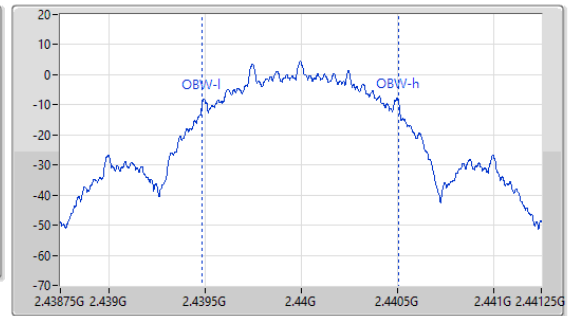
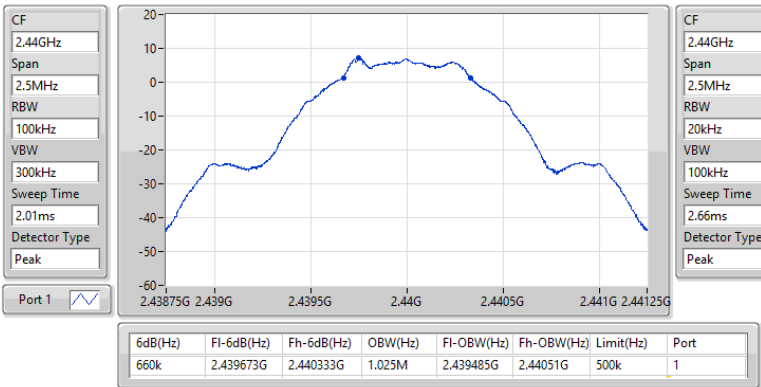

2.4-2.4835GHz_BT-LE(500kbps)

EBW-DTS

2480MHz

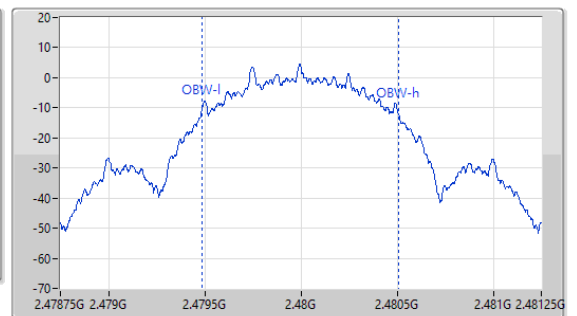
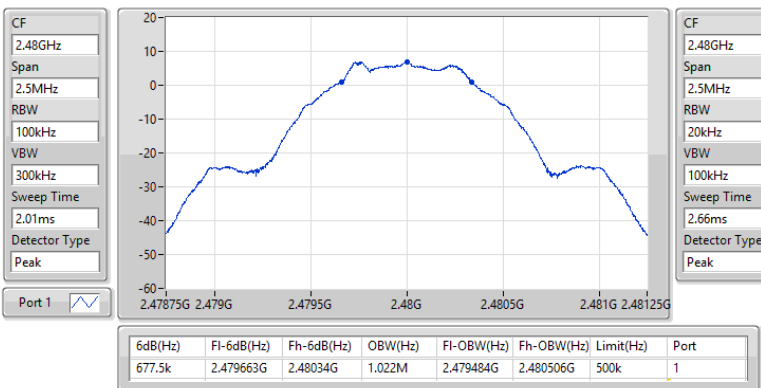



2.4-2.4835GHz_BT-LE(1Mbps)

EBW-DTS

2402MHz

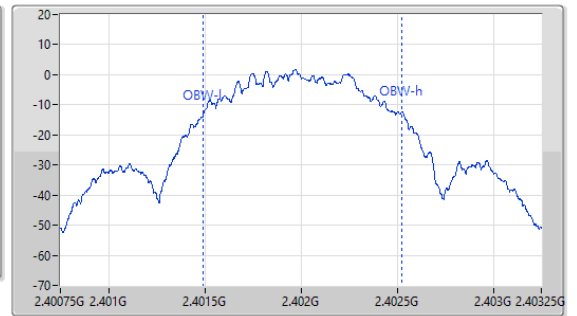
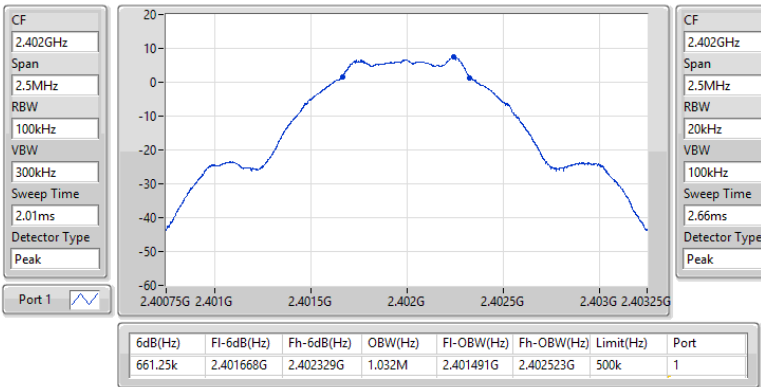

2.4-2.4835GHz_BT-LE(1Mbps)

EBW-DTS

2440MHz

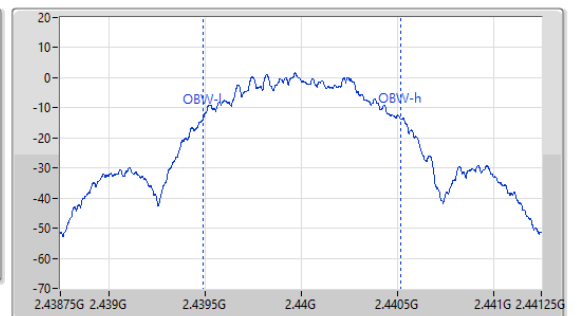
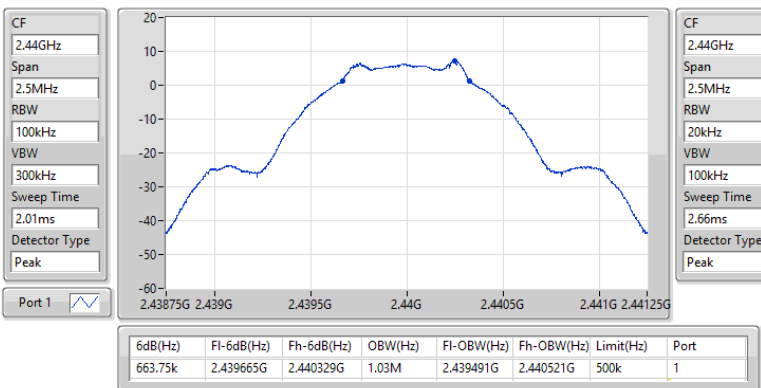



2.4-2.4835GHz_BT-LE(1Mbps)

EBW-DTS

2480MHz

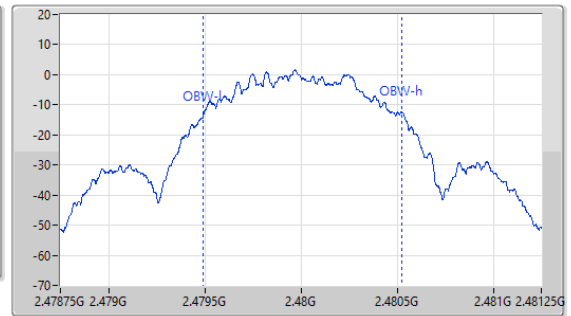
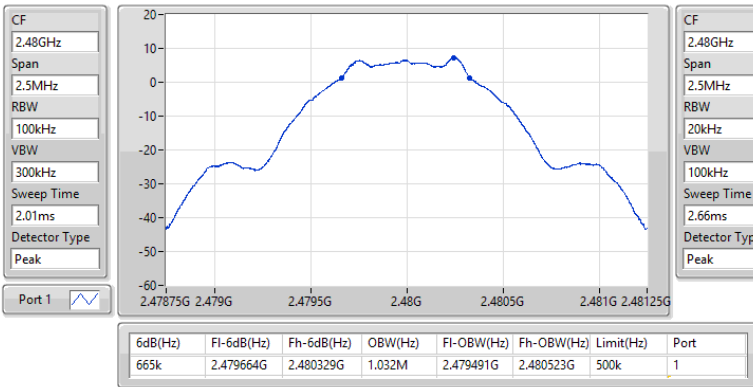

2.4-2.4835GHz_BT-LE(2Mbps)

EBW-DTS

2404MHz

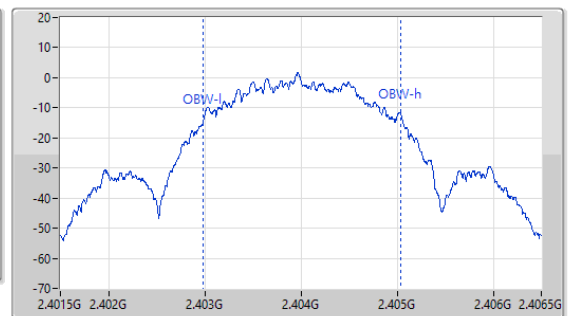
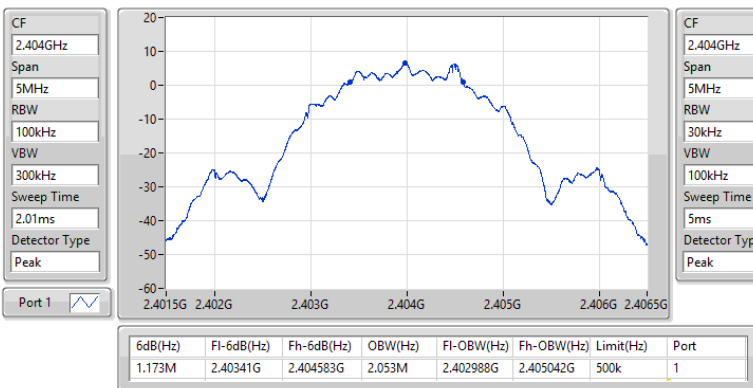



2.4-2.4835GHz_BT-LE(2Mbps)

EBW-DTS

2440MHz

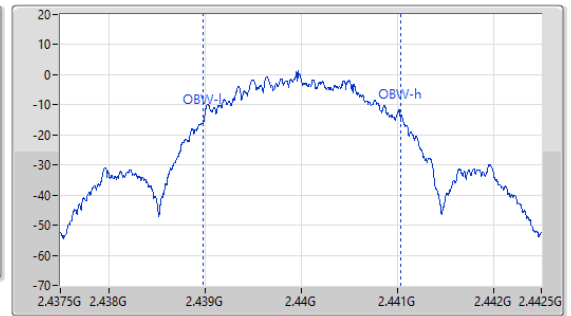
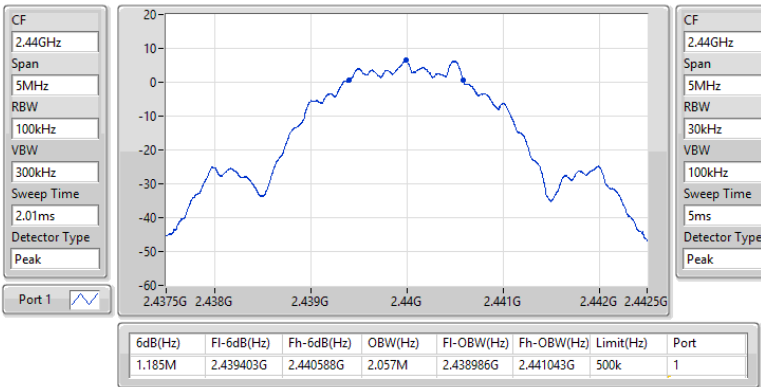

2.4-2.4835GHz_BT-LE(2Mbps)

EBW-DTS

2478MHz

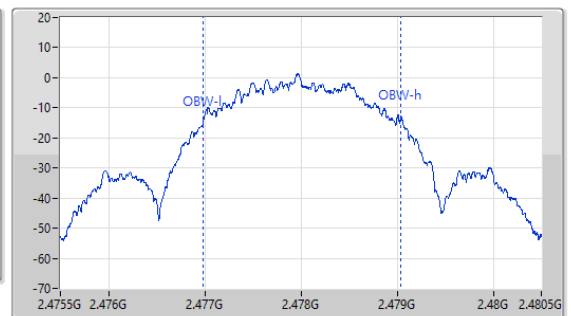
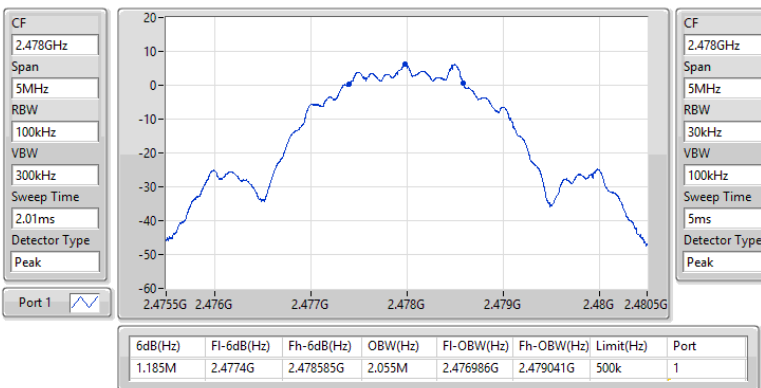



Summary

Mode	Total Power (dBm)	Power (W)
2.4-2.4835GHz	-	-
BT-LE(125kbps)	7.35	0.00543
BT-LE(500kbps)	7.36	0.00545
BT-LE(1Mbps)	7.37	0.00546
BT-LE(2Mbps)	7.33	0.00541

Result

Mode	Result	Antenna Gain (dBi)	Total Power (dBm)	Power Limit (dBm)	EIRP (dBm)	EIRP Limit (dBm)
BT-LE(125kbps)	-	-	-	-	-	-
2402MHz	Pass	2.40	7.35	30.00	9.75	36.00
2440MHz	Pass	2.40	7.07	30.00	9.47	36.00
2480MHz	Pass	2.40	7.05	30.00	9.45	36.00
BT-LE(500kbps)	-	-	-	-	-	-
2402MHz	Pass	2.40	7.36	30.00	9.76	36.00
2440MHz	Pass	2.40	7.07	30.00	9.47	36.00
2480MHz	Pass	2.40	7.05	30.00	9.45	36.00
BT-LE(1Mbps)	-	-	-	-	-	-
2402MHz	Pass	2.40	7.37	30.00	9.77	36.00
2440MHz	Pass	2.40	7.08	30.00	9.48	36.00
2480MHz	Pass	2.40	7.06	30.00	9.46	36.00
BT-LE(2Mbps)	-	-	-	-	-	-
2404MHz	Pass	2.40	7.33	30.00	9.73	36.00
2440MHz	Pass	2.40	7.01	30.00	9.41	36.00
2478MHz	Pass	2.40	7.05	30.00	9.45	36.00



Summary

Mode	Total Power (dBm)	Power (W)
2.4-2.4835GHz	-	-
BT-LE(125kbps)	7.16	0.00520
BT-LE(500kbps)	7.20	0.00525
BT-LE(1Mbps)	7.21	0.00526
BT-LE(2Mbps)	7.19	0.00524

Result

Mode	Result	Antenna Gain (dBi)	Total Power (dBm)	Power Limit (dBm)	EIRP (dBm)	EIRP Limit (dBm)
BT-LE(125kbps)	-	-	-	-	-	-
2402MHz	Pass	2.40	7.16	-	9.56	-
2440MHz	Pass	2.40	6.92	-	9.32	-
2480MHz	Pass	2.40	6.88	-	9.28	-
BT-LE(500kbps)	-	-	-	-	-	-
2402MHz	Pass	2.40	7.20	-	9.60	-
2440MHz	Pass	2.40	6.92	-	9.32	-
2480MHz	Pass	2.40	6.89	-	9.29	-
BT-LE(1Mbps)	-	-	-	-	-	-
2402MHz	Pass	2.40	7.21	-	9.61	-
2440MHz	Pass	2.40	6.94	-	9.34	-
2480MHz	Pass	2.40	6.89	-	9.29	-
BT-LE(2Mbps)	-	-	-	-	-	-
2404MHz	Pass	2.40	7.19	-	9.59	-
2440MHz	Pass	2.40	6.85	-	9.25	-
2478MHz	Pass	2.40	6.88	-	9.28	-

Note: Average power is for reference only.



Summary

Mode	Total Power (dBm)	Power (W)
2.4-2.4835GHz	-	-
BT-LE(125kbps)	7.34	0.00542
BT-LE(500kbps)	7.33	0.00541
BT-LE(1Mbps)	7.34	0.00542
BT-LE(2Mbps)	7.32	0.00540

Result

Mode	Result	Antenna Gain (dBi)	Total Power (dBm)	Power Limit (dBm)	EIRP (dBm)	EIRP Limit (dBm)
BT-LE(125kbps)	-	-	-	-	-	-
2402MHz	Pass	2.40	7.11	30.00	9.51	36.00
2440MHz	Pass	2.40	7.08	30.00	9.48	36.00
2480MHz	Pass	2.40	7.34	30.00	9.74	36.00
BT-LE(500kbps)	-	-	-	-	-	-
2402MHz	Pass	2.40	7.10	30.00	9.50	36.00
2440MHz	Pass	2.40	7.09	30.00	9.49	36.00
2480MHz	Pass	2.40	7.33	30.00	9.73	36.00
BT-LE(1Mbps)	-	-	-	-	-	-
2402MHz	Pass	2.40	7.12	30.00	9.52	36.00
2440MHz	Pass	2.40	7.15	30.00	9.55	36.00
2480MHz	Pass	2.40	7.34	30.00	9.74	36.00
BT-LE(2Mbps)	-	-	-	-	-	-
2404MHz	Pass	2.40	7.12	30.00	9.52	36.00
2440MHz	Pass	2.40	7.14	30.00	9.54	36.00
2478MHz	Pass	2.40	7.32	30.00	9.72	36.00



Summary

Mode	Total Power (dBm)	Power (W)
2.4-2.4835GHz	-	-
BT-LE(125kbps)	7.15	0.00519
BT-LE(500kbps)	7.19	0.00524
BT-LE(1Mbps)	7.20	0.00525
BT-LE(2Mbps)	7.18	0.00522

Result

Mode	Result	Antenna Gain (dBi)	Total Power (dBm)	Power Limit (dBm)	EIRP (dBm)	EIRP Limit (dBm)
BT-LE(125kbps)	-	-	-	-	-	-
2402MHz	Pass	2.40	6.99	-	9.39	-
2440MHz	Pass	2.40	6.95	-	9.35	-
2480MHz	Pass	2.40	7.15	-	9.55	-
BT-LE(500kbps)	-	-	-	-	-	-
2402MHz	Pass	2.40	6.98	-	9.38	-
2440MHz	Pass	2.40	6.95	-	9.35	-
2480MHz	Pass	2.40	7.19	-	9.59	-
BT-LE(1Mbps)	-	-	-	-	-	-
2402MHz	Pass	2.40	6.99	-	9.39	-
2440MHz	Pass	2.40	7.01	-	9.41	-
2480MHz	Pass	2.40	7.20	-	9.60	-
BT-LE(2Mbps)	-	-	-	-	-	-
2404MHz	Pass	2.40	6.99	-	9.39	-
2440MHz	Pass	2.40	7.00	-	9.40	-
2478MHz	Pass	2.40	7.18	-	9.58	-

Note: Average power is for reference only.



Summary

Mode	PD (dBm/3kHz)
2.4-2.4835GHz	-
BT-LE(125kbps)	1.42
BT-LE(500kbps)	1.07
BT-LE(1Mbps)	-9.19
BT-LE(2Mbps)	-11.40

Result

Mode	Result	Antenna Gain (dBi)	Power Density (dBm/3kHz)	Power Density Limit (dBm/3kHz)
BT-LE(125kbps)	-	-	-	-
2402MHz	Pass	2.40	1.42	8.00
2440MHz	Pass	2.40	1.11	8.00
2480MHz	Pass	2.40	1.14	8.00
BT-LE(500kbps)	-	-	-	-
2402MHz	Pass	2.40	1.07	8.00
2440MHz	Pass	2.40	0.57	8.00
2480MHz	Pass	2.40	0.92	8.00
BT-LE(1Mbps)	-	-	-	-
2402MHz	Pass	2.40	-9.19	8.00
2440MHz	Pass	2.40	-9.30	8.00
2480MHz	Pass	2.40	-9.40	8.00
BT-LE(2Mbps)	-	-	-	-
2404MHz	Pass	2.40	-11.40	8.00
2440MHz	Pass	2.40	-11.51	8.00
2478MHz	Pass	2.40	-11.66	8.00

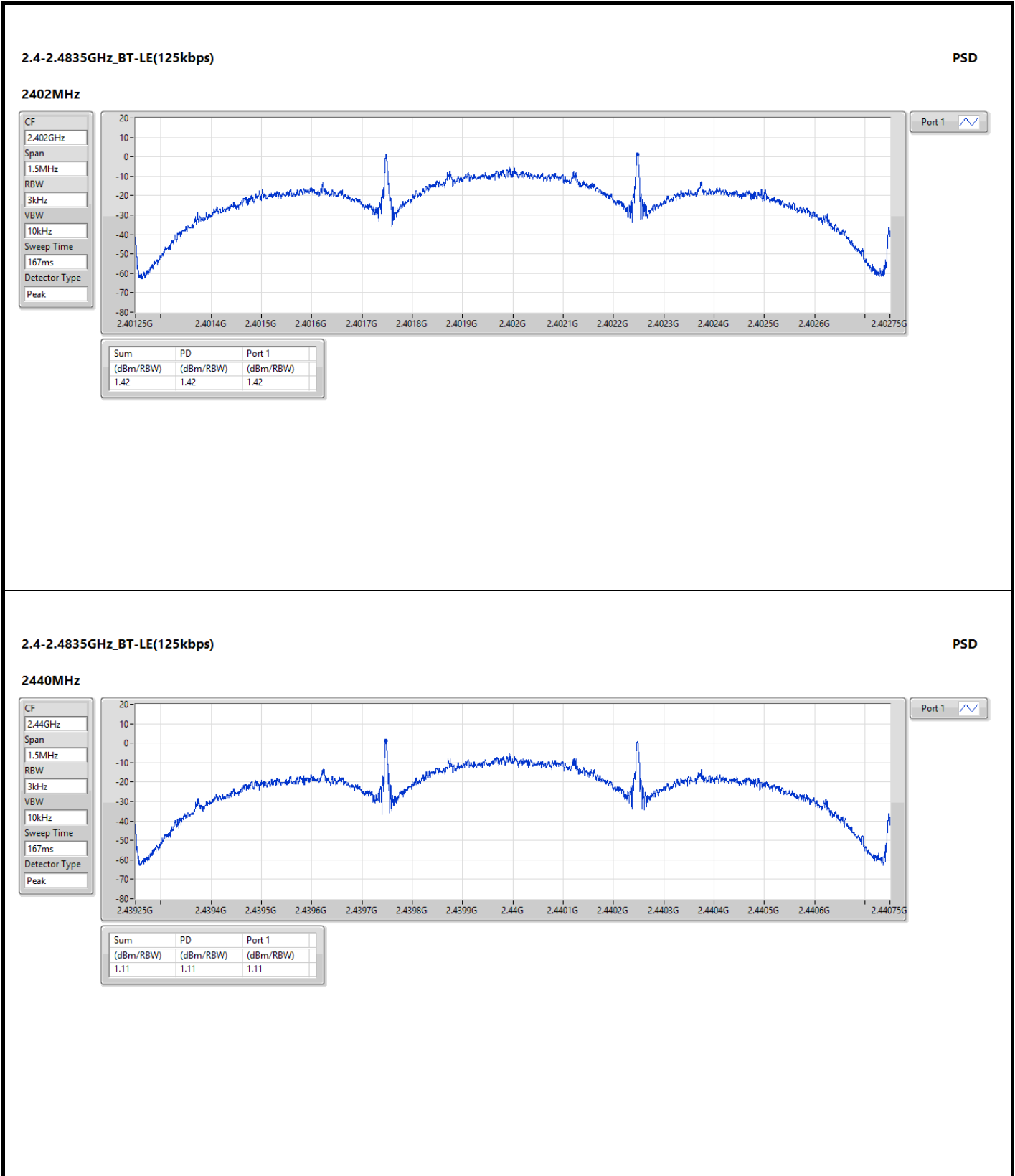

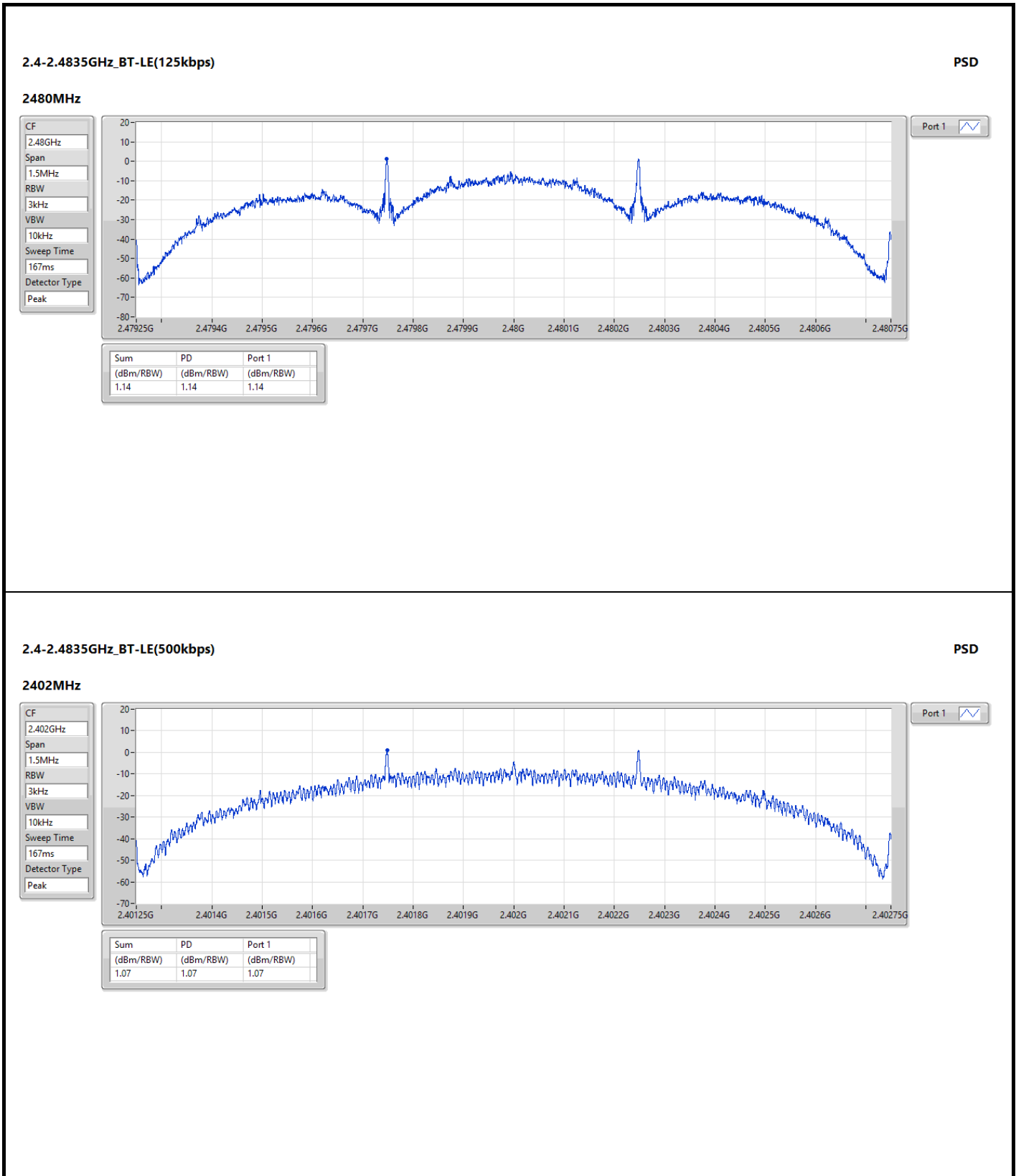

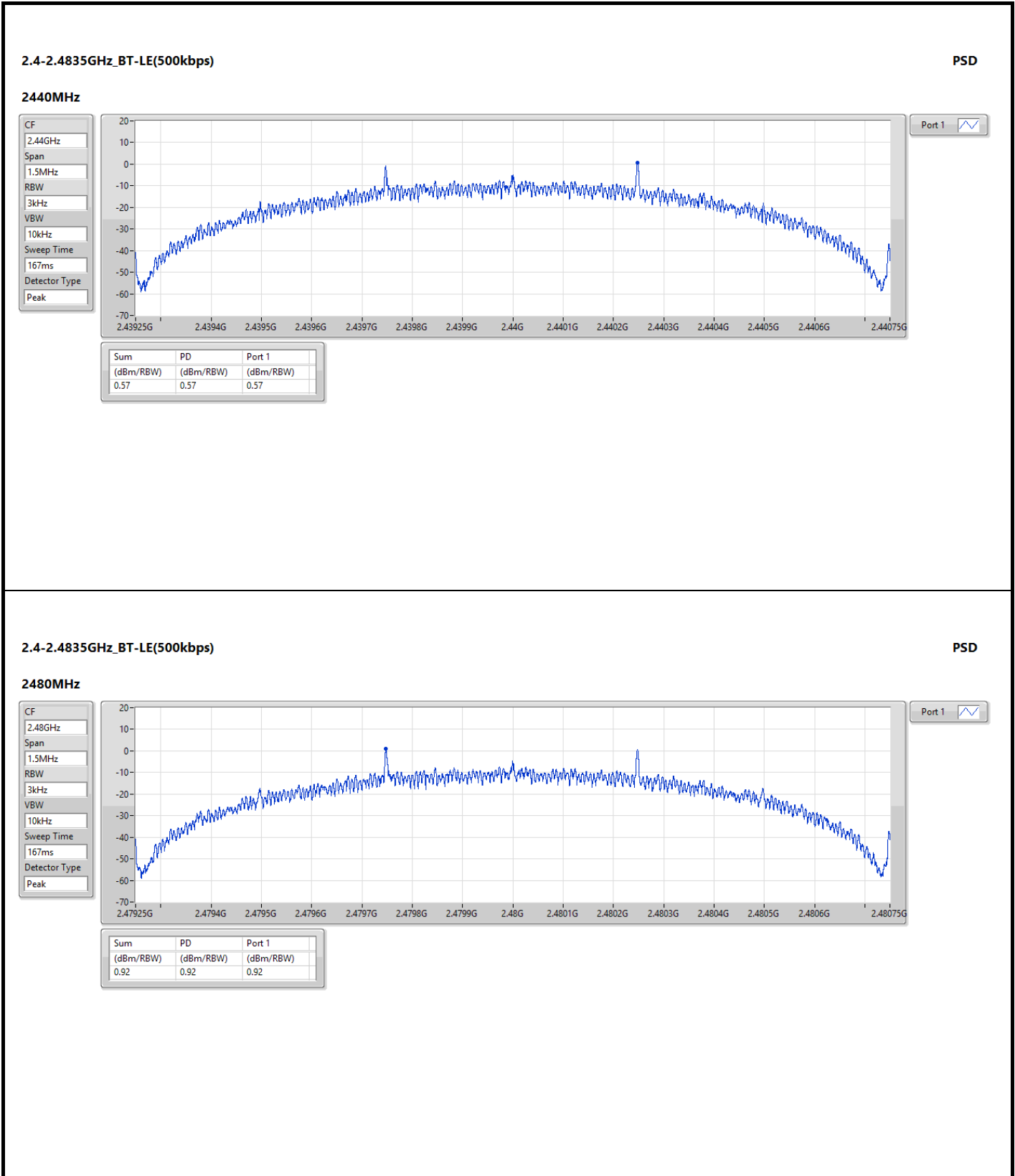

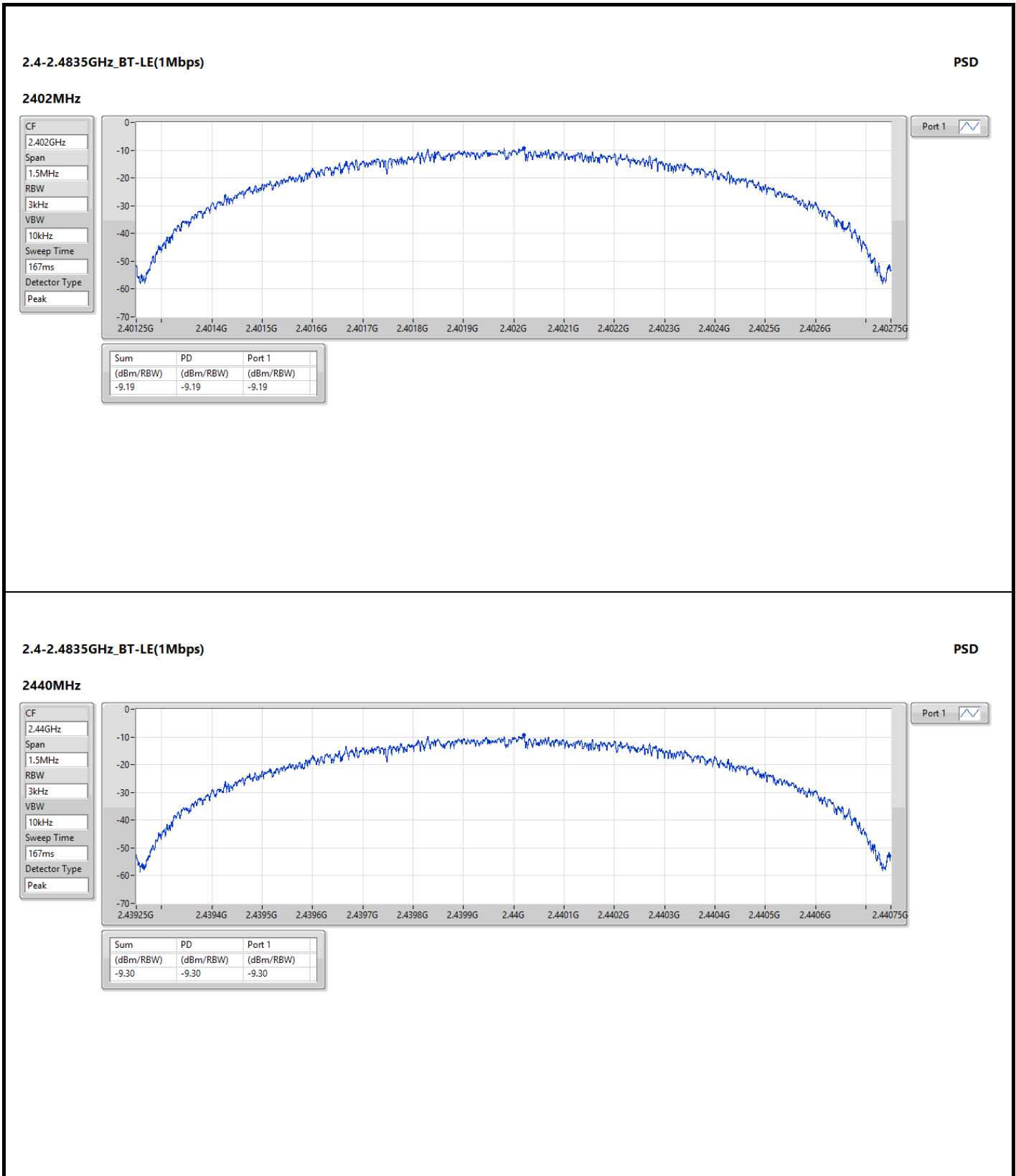

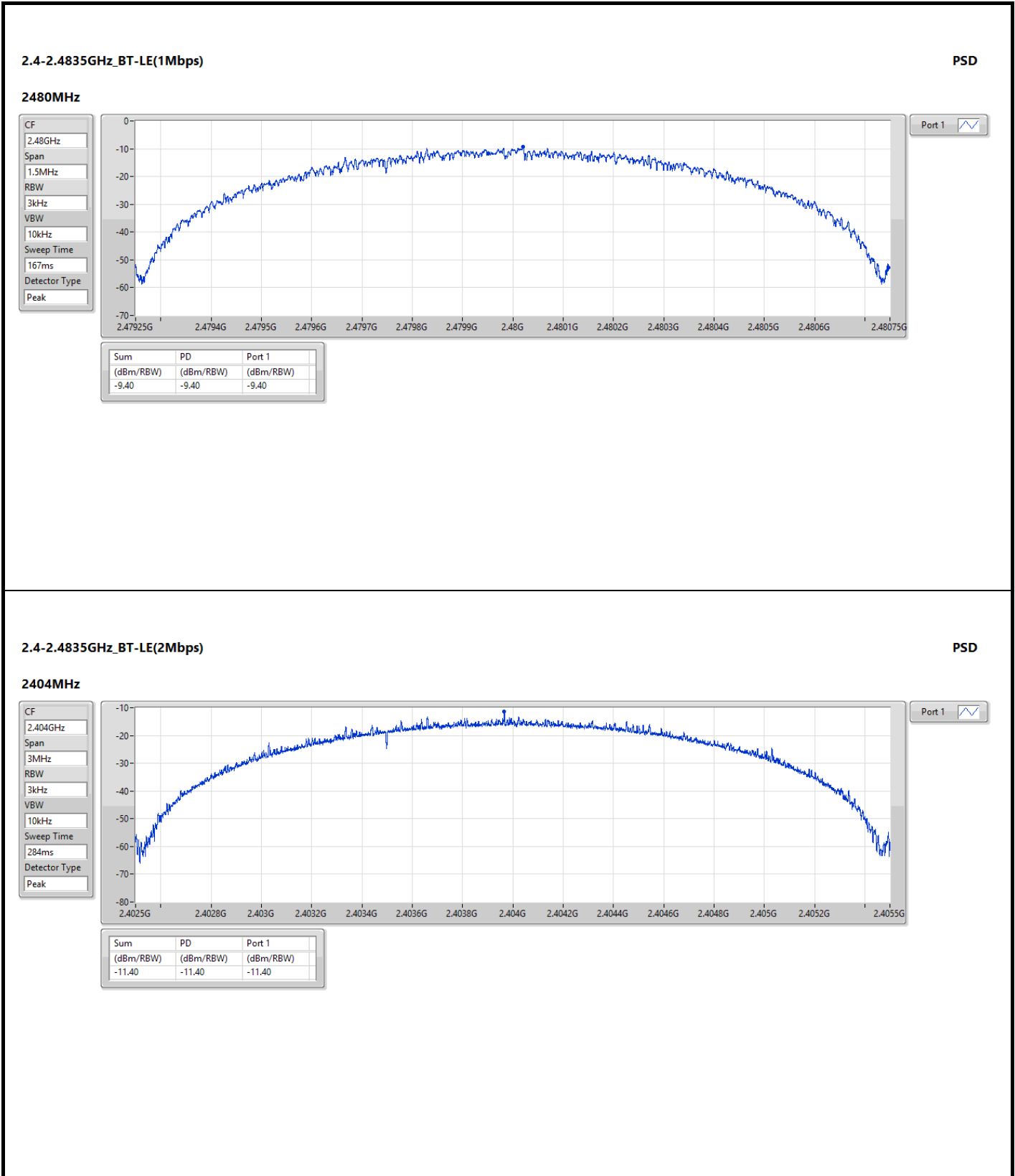



2.4-2.4835GHz_BT-LE(2Mbps)

PSD

2440MHz

CF
2.44GHz
Span
3MHz
RBW
3kHz
VBW
10kHz
Sweep Time
284ms
Detector Type
Peak

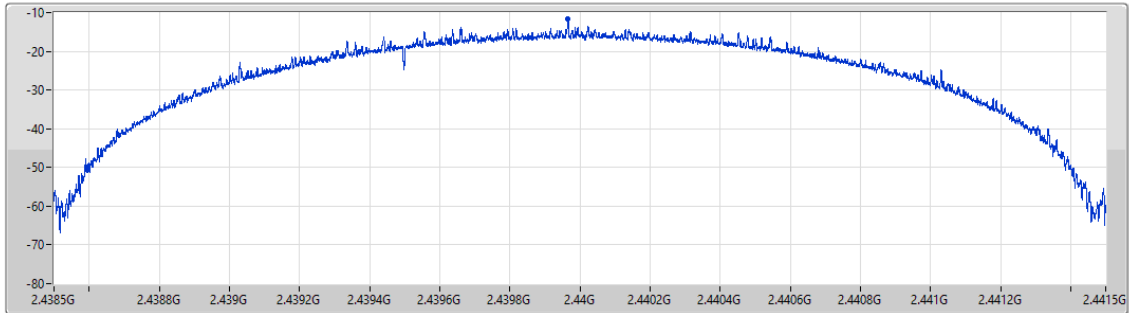

Port 1

Sum	PD	Port 1
(dBm/RBW)	(dBm/RBW)	(dBm/RBW)
-11.51	-11.51	-11.51

2.4-2.4835GHz_BT-LE(2Mbps)

PSD

2478MHz

CF
2.478GHz
Span
3MHz
RBW
3kHz
VBW
10kHz
Sweep Time
284ms
Detector Type
Peak

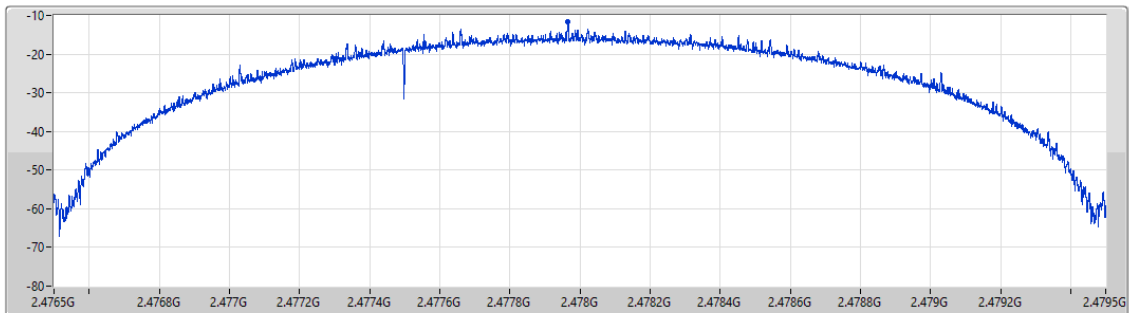

Port 1

Sum	PD	Port 1
(dBm/RBW)	(dBm/RBW)	(dBm/RBW)
-11.66	-11.66	-11.66



Summary

Mode	Result	F-Start (Hz)	F-Stop (Hz)	Type	Freq (Hz)	DG (dBi)	Psum (dBm)	GRF (dB)	EIRP (dBm)	Limit (dBm)	Margin (dB)
2.4-2.4835GHz	-	-	-	-	-	-	-	-	-	-	-
BT-LE(1Mbps)	Pass	30M	1G	PK	75.23M	2.40	-77.76	4.7	-70.66	-55.20	-15.46

DG = Directional Gain ; PX=Port X; Psum=P1+P2+...PX

Result

Mode	Result	F-Start (Hz)	F-Stop (Hz)	Type	Freq (Hz)	DG (dBi)	Psum (dBm)	GRF (dB)	EIRP (dBm)	Limit (dBm)	Margin (dB)
BT-LE(1Mbps)	-	-	-	-	-	-	-	-	-	-	-
2402MHz	Pass	30M	1G	PK	75.23M	2.40	-77.76	4.7	-70.66	-55.20	-15.46

DG = Directional Gain ; PX=Port X; Psum=P1+P2+...PX

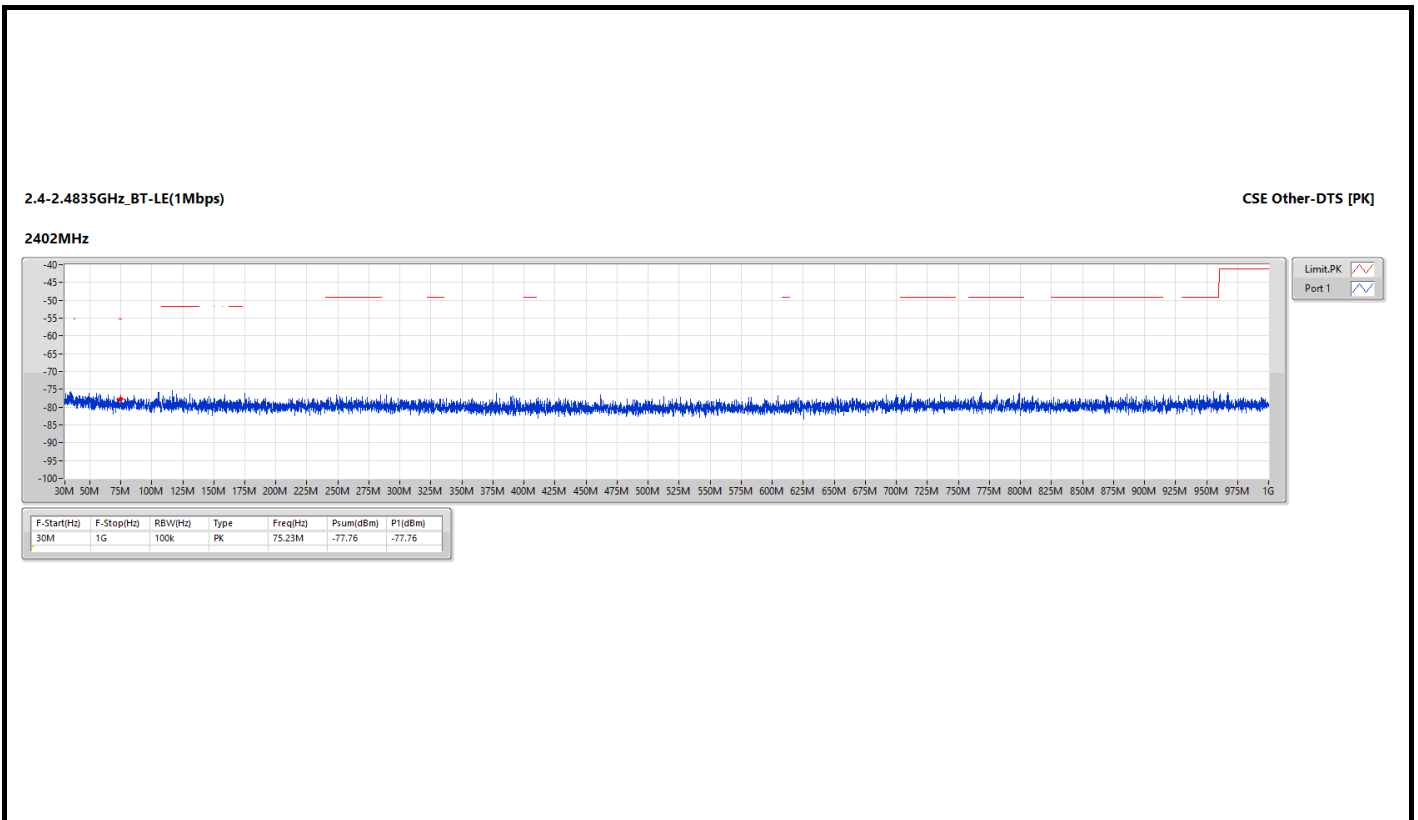



Unwanted Conducted Emissions into Restricted Frequency Bands 1GHz~3.1GHz - SC Module

Appendix D.2

Summary

Mode	Result	F-Start (Hz)	F-Stop (Hz)	Type	Freq (Hz)	DG (dBi)	Psum (dBm)	EIRP (dBm)	Limit (dBm)	Margin (dB)
2.4-2.4835GHz	-	-	-	-	-	-	-	-	-	-
BT-LE(1Mbps)	Pass	2.4835G	2.5G	AV	2.48371G	2.40	-63.00	-60.60	-41.20	-19.40
BT-LE(2Mbps)	Pass	2.4835G	2.5G	AV	2.48403G	2.40	-64.23	-61.83	-41.20	-20.63

DG = Directional Gain ; PX=Port X; Psum=P1+P2+...PX

Result

Mode	Result	F-Start (Hz)	F-Stop (Hz)	Type	Freq (Hz)	DG (dBi)	Psum (dBm)	EIRP (dBm)	Limit (dBm)	Margin (dB)
BT-LE(1Mbps)	-	-	-	-	-	-	-	-	-	-
2402MHz	Pass	1G	2.31G	AV	2.28347G	2.40	-64.87	-62.47	-41.20	-21.27
2402MHz	Pass	2.31G	2.39G	AV	2.32208G	2.40	-65.38	-62.98	-41.20	-21.78
2402MHz	Pass	2.4835G	2.5G	AV	2.48613G	2.40	-65.33	-62.93	-41.20	-21.73
2402MHz	Pass	2.5G	3.1G	AV	2.64205G	2.40	-65.05	-62.65	-41.20	-21.45
2402MHz	Pass	1G	2.31G	PK	2.16918G	2.40	-53.65	-51.25	-21.20	-30.05
2402MHz	Pass	2.31G	2.39G	PK	2.33368G	2.40	-55.29	-52.89	-21.20	-31.69
2402MHz	Pass	2.4835G	2.5G	PK	2.4901G	2.40	-55.12	-52.72	-21.20	-31.52
2402MHz	Pass	2.5G	3.1G	PK	2.656G	2.40	-53.97	-51.57	-21.20	-30.37
2440MHz	Pass	1G	2.31G	AV	2.22894G	2.40	-64.65	-62.25	-41.20	-21.05
2440MHz	Pass	2.31G	2.39G	AV	2.36012G	2.40	-65.19	-62.79	-41.20	-21.59
2440MHz	Pass	2.4835G	2.5G	AV	2.48428G	2.40	-65.27	-62.87	-41.20	-21.67
2440MHz	Pass	2.5G	3.1G	AV	2.60005G	2.40	-64.89	-62.49	-41.20	-21.29
2440MHz	Pass	1G	2.31G	PK	2.14625G	2.40	-54.03	-51.63	-21.20	-30.43
2440MHz	Pass	2.31G	2.39G	PK	2.36268G	2.40	-54.28	-51.88	-21.20	-30.68
2440MHz	Pass	2.4835G	2.5G	PK	2.48742G	2.40	-55.16	-52.76	-21.20	-31.56
2440MHz	Pass	2.5G	3.1G	PK	2.7796G	2.40	-54.89	-52.49	-21.20	-31.29
2480MHz	Pass	1G	2.31G	AV	2.28937G	2.40	-64.87	-62.47	-41.20	-21.27
2480MHz	Pass	2.31G	2.39G	AV	2.35996G	2.40	-66.06	-63.66	-41.20	-22.46
2480MHz	Pass	2.4835G	2.5G	AV	2.48371G	2.40	-63.00	-60.60	-41.20	-19.40
2480MHz	Pass	2.5G	3.1G	AV	2.63995G	2.40	-64.95	-62.55	-41.20	-21.35
2480MHz	Pass	1G	2.31G	PK	2.1135G	2.40	-53.79	-51.39	-21.20	-30.19
2480MHz	Pass	2.31G	2.39G	PK	2.35644G	2.40	-54.61	-52.21	-21.20	-31.01
2480MHz	Pass	2.4835G	2.5G	PK	2.48364G	2.40	-53.04	-50.64	-21.20	-29.44
2480MHz	Pass	2.5G	3.1G	PK	2.7616G	2.40	-54.05	-51.65	-21.20	-30.45
BT-LE(2Mbps)	-	-	-	-	-	-	-	-	-	-
2404MHz	Pass	1G	2.31G	AV	2.25089G	2.40	-64.80	-62.40	-41.20	-21.20
2404MHz	Pass	2.31G	2.39G	AV	2.32404G	2.40	-66.00	-63.60	-41.20	-22.40
2404MHz	Pass	2.4835G	2.5G	AV	2.48403G	2.40	-64.23	-61.83	-41.20	-20.63
2404MHz	Pass	2.5G	3.1G	AV	2.56345G	2.40	-65.36	-62.96	-41.20	-21.76
2404MHz	Pass	1G	2.31G	PK	2.22485G	2.40	-53.22	-50.82	-21.20	-29.62
2404MHz	Pass	2.31G	2.39G	PK	2.3192G	2.40	-54.87	-52.47	-21.20	-31.27
2404MHz	Pass	2.4835G	2.5G	PK	2.48373G	2.40	-53.55	-51.15	-21.20	-29.95
2404MHz	Pass	2.5G	3.1G	PK	2.7556G	2.40	-54.07	-51.67	-21.20	-30.47



**Unwanted Conducted Emissions into Restricted
Frequency Bands 1GHz~3.1GHz - SC Module**

Appendix D.2

Mode	Result	F-Start (Hz)	F-Stop (Hz)	Type	Freq (Hz)	DG (dBi)	Psum (dBm)	EIRP (dBm)	Limit (dBm)	Margin (dB)
2440MHz	Pass	1G	2.31G	AV	2.27267G	2.40	-64.84	-62.44	-41.20	-21.24
2440MHz	Pass	2.31G	2.39G	AV	2.35964G	2.40	-65.83	-63.43	-41.20	-22.23
2440MHz	Pass	2.4835G	2.5G	AV	2.48574G	2.40	-65.58	-63.18	-41.20	-21.98
2440MHz	Pass	2.5G	3.1G	AV	2.81665G	2.40	-65.18	-62.78	-41.20	-21.58
2440MHz	Pass	1G	2.31G	PK	2.25171G	2.40	-52.82	-50.42	-21.20	-29.22
2440MHz	Pass	2.31G	2.39G	PK	2.31676G	2.40	-55.09	-52.69	-21.20	-31.49
2440MHz	Pass	2.4835G	2.5G	PK	2.48496G	2.40	-55.13	-52.73	-21.20	-31.53
2440MHz	Pass	2.5G	3.1G	PK	2.5288G	2.40	-54.56	-52.16	-21.20	-30.96
2478MHz	Pass	1G	2.31G	AV	2.24778G	2.40	-64.64	-62.24	-41.20	-21.04
2478MHz	Pass	2.31G	2.39G	AV	2.35804G	2.40	-66.02	-63.62	-41.20	-22.42
2478MHz	Pass	2.4835G	2.5G	AV	2.48352G	2.40	-64.45	-62.05	-41.20	-20.85
2478MHz	Pass	2.5G	3.1G	AV	2.82865G	2.40	-65.22	-62.82	-41.20	-21.62
2478MHz	Pass	1G	2.31G	PK	1.71461G	2.40	-54.19	-51.79	-21.20	-30.59
2478MHz	Pass	2.31G	2.39G	PK	2.32516G	2.40	-55.00	-52.60	-21.20	-31.40
2478MHz	Pass	2.4835G	2.5G	PK	2.48651G	2.40	-53.58	-51.18	-21.20	-29.98
2478MHz	Pass	2.5G	3.1G	PK	2.722G	2.40	-54.03	-51.63	-21.20	-30.43

DG = Directional Gain ; PX=Port X; Psum=P1+P2+...PX

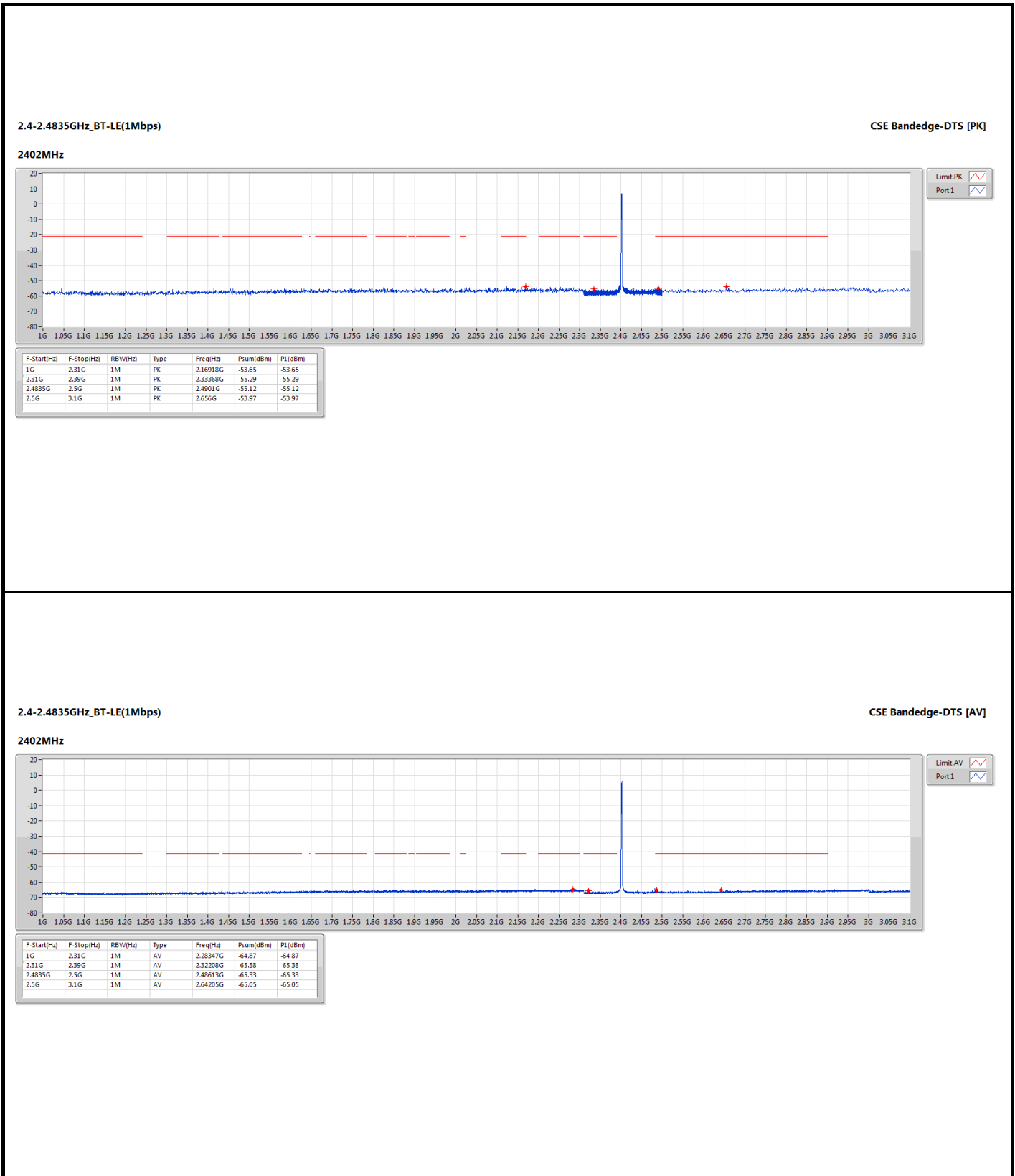



2.4-2.4835GHz_BT-LE(1Mbps)

CSE Bandedge-DTS [PK]

2440MHz

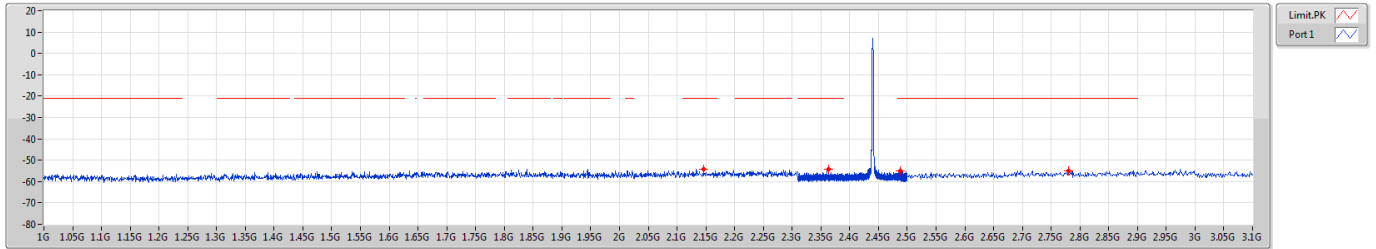

F-Start(Hz)	F-Stop(Hz)	RBW(Hz)	Type	Freq(Hz)	Psum(dBm)	P1(dBm)
1G	2.31G	1M	PK	2.14625G	-54.03	-54.03
2.31G	2.39G	1M	PK	2.36268G	-54.28	-54.28
2.4835G	2.5G	1M	PK	2.48742G	-55.16	-55.16
2.5G	3.1G	1M	PK	2.7796G	-54.89	-54.89

2.4-2.4835GHz_BT-LE(1Mbps)

CSE Bandedge-DTS [AV]

2440MHz

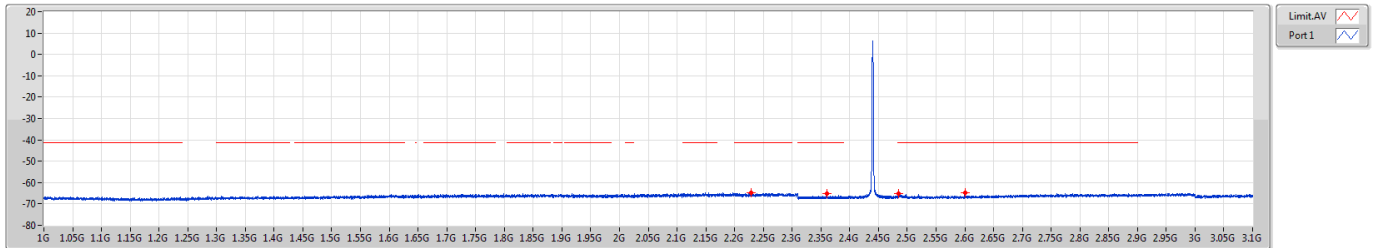

F-Start(Hz)	F-Stop(Hz)	RBW(Hz)	Type	Freq(Hz)	Psum(dBm)	P1(dBm)
1G	2.31G	1M	AV	2.22894G	-64.65	-64.65
2.31G	2.39G	1M	AV	2.36012G	-65.19	-65.19
2.4835G	2.5G	1M	AV	2.48428G	-65.27	-65.27
2.5G	3.1G	1M	AV	2.60005G	-64.89	-64.89



2.4-2.4835GHz_BT-LE(1Mbps)

CSE Bandedge-DTS [PK]

2480MHz

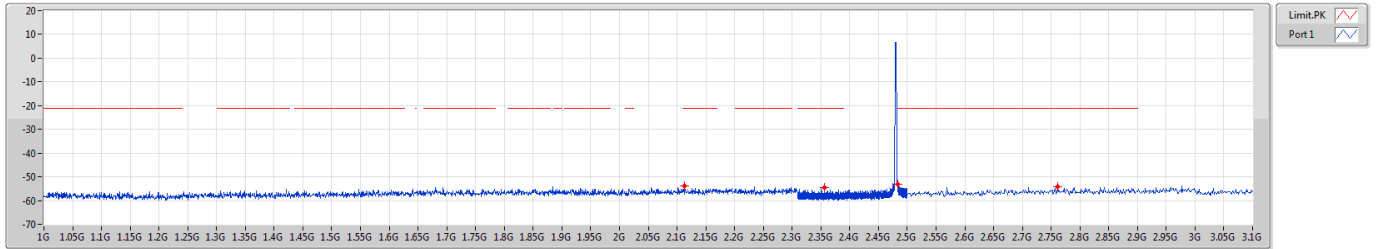

F-Start(Hz)	F-Stop(Hz)	RBW(Hz)	Type	Freq(Hz)	Psum(dBm)	P1(dBm)
1G	2.31G	1M	PK	2.1135G	-53.79	-53.79
2.31G	2.39G	1M	PK	2.35644G	-54.61	-54.61
2.4835G	2.5G	1M	PK	2.48364G	-53.04	-53.04
2.5G	3.1G	1M	PK	2.7616G	-54.05	-54.05

2.4-2.4835GHz_BT-LE(1Mbps)

CSE Bandedge-DTS [AV]

2480MHz

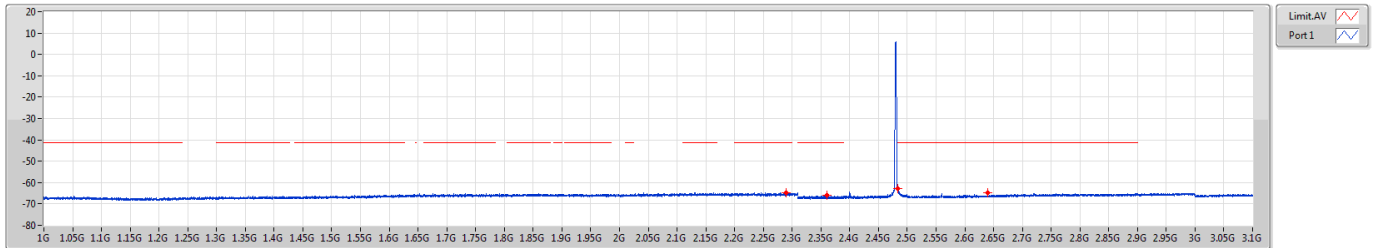

F-Start(Hz)	F-Stop(Hz)	RBW(Hz)	Type	Freq(Hz)	Psum(dBm)	P1(dBm)
1G	2.31G	1M	AV	2.28937G	-64.87	-64.87
2.31G	2.39G	1M	AV	2.35996G	-66.06	-66.06
2.4835G	2.5G	1M	AV	2.48371G	-63.00	-63.00
2.5G	3.1G	1M	AV	2.63995G	-64.95	-64.95



2.4-2.4835GHz_BT-LE(2Mbps)

CSE Bandedge-DTS [PK]

2404MHz

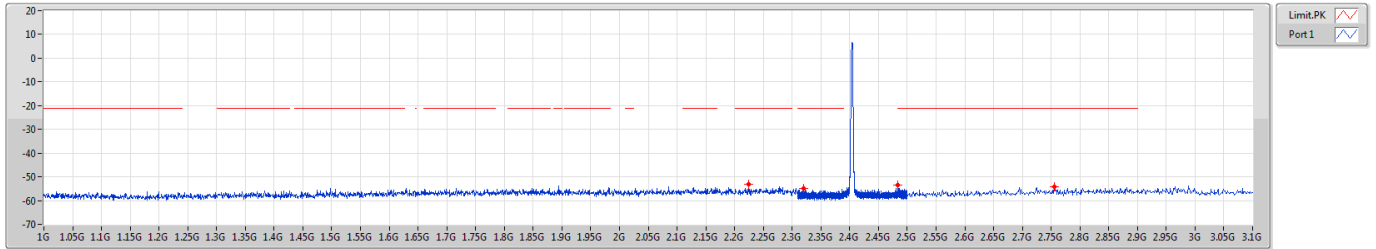

F-Start(Hz)	F-Stop(Hz)	RBW(Hz)	Type	Freq(Hz)	Psum(dBm)	P1(dBm)
1G	2.31G	1M	PK	2.22485G	-53.22	-53.22
2.31G	2.39G	1M	PK	2.3192G	-54.87	-54.87
2.4835G	2.5G	1M	PK	2.48373G	-53.55	-53.55
2.5G	3.1G	1M	PK	2.7556G	-54.07	-54.07

2.4-2.4835GHz_BT-LE(2Mbps)

CSE Bandedge-DTS [AV]

2404MHz

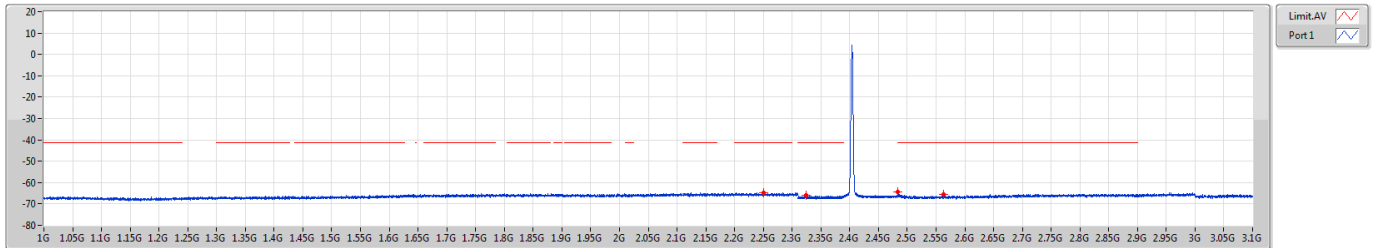

F-Start(Hz)	F-Stop(Hz)	RBW(Hz)	Type	Freq(Hz)	Psum(dBm)	P1(dBm)
1G	2.31G	1M	AV	2.25089G	-64.80	-64.80
2.31G	2.39G	1M	AV	2.32404G	-66.00	-66.00
2.4835G	2.5G	1M	AV	2.48403G	-64.23	-64.23
2.5G	3.1G	1M	AV	2.56345G	-65.36	-65.36



2.4-2.4835GHz_BT-LE(2Mbps)

CSE Bandedge-DTS [PK]

2440MHz

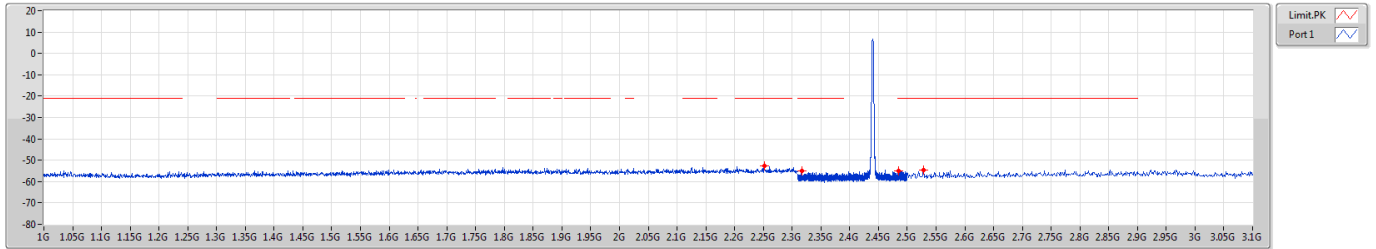

F-Start(Hz)	F-Stop(Hz)	RBW(Hz)	Type	Freq(Hz)	Psum(dBm)	P1(dBm)
1G	2.31G	1M	PK	2.25171G	-52.82	-52.82
2.31G	2.39G	1M	PK	2.31676G	-55.09	-55.09
2.4835G	2.5G	1M	PK	2.48496G	-55.13	-55.13
2.5G	3.1G	1M	PK	2.5288G	-54.56	-54.56

2.4-2.4835GHz_BT-LE(2Mbps)

CSE Bandedge-DTS [AV]

2440MHz

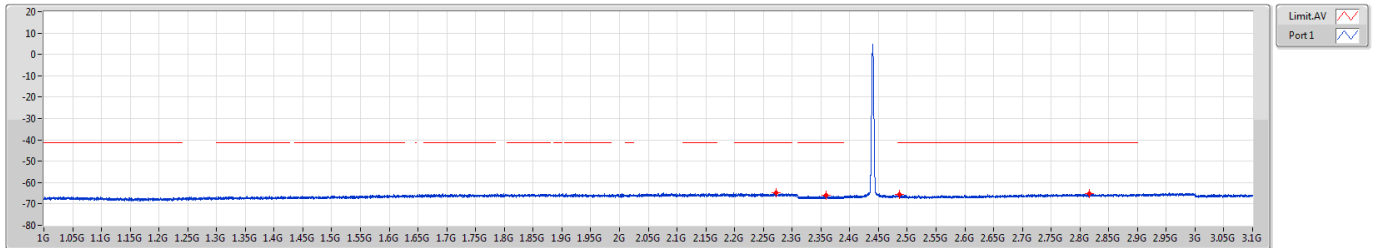

F-Start(Hz)	F-Stop(Hz)	RBW(Hz)	Type	Freq(Hz)	Psum(dBm)	P1(dBm)
1G	2.31G	1M	AV	2.27267G	-64.84	-64.84
2.31G	2.39G	1M	AV	2.35964G	-65.83	-65.83
2.4835G	2.5G	1M	AV	2.48574G	-65.58	-65.58
2.5G	3.1G	1M	AV	2.81665G	-65.18	-65.18



2.4-2.4835GHz_BT-LE(2Mbps)

CSE Bandedge-DTS [PK]

2478MHz

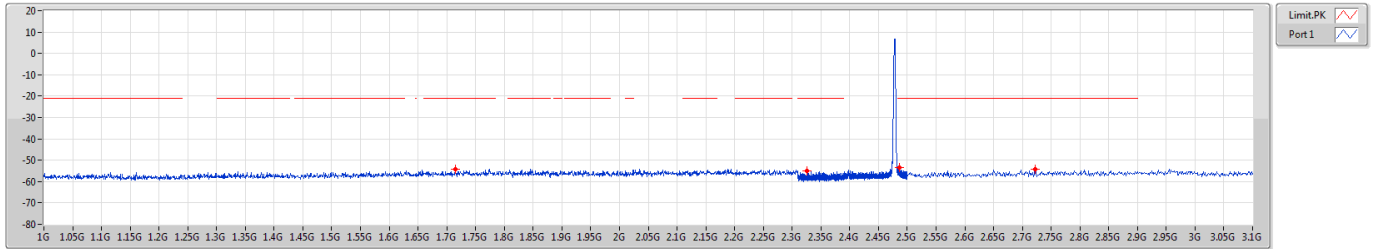

F-Start(Hz)	F-Stop(Hz)	RBW(Hz)	Type	Freq(Hz)	Psum(dBm)	P1(dBm)
1G	2.31G	1M	PK	1.71461G	-54.19	-54.19
2.31G	2.39G	1M	PK	2.32516G	-55.00	-55.00
2.4835G	2.5G	1M	PK	2.48651G	-53.58	-53.58
2.5G	3.1G	1M	PK	2.722G	-54.03	-54.03

2.4-2.4835GHz_BT-LE(2Mbps)

CSE Bandedge-DTS [AV]

2478MHz

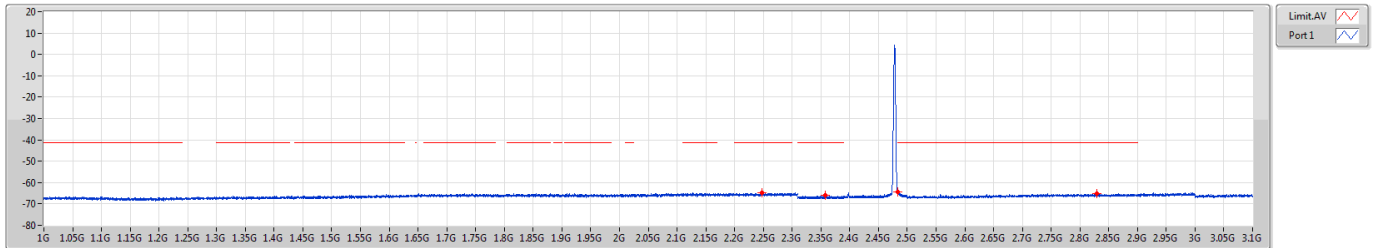

F-Start(Hz)	F-Stop(Hz)	RBW(Hz)	Type	Freq(Hz)	Psum(dBm)	P1(dBm)
1G	2.31G	1M	AV	2.24778G	-64.64	-64.64
2.31G	2.39G	1M	AV	2.35804G	-66.02	-66.02
2.4835G	2.5G	1M	AV	2.48352G	-64.45	-64.45
2.5G	3.1G	1M	AV	2.82865G	-65.22	-65.22



Unwanted Conducted Emissions into Restricted Frequency Bands 3.1GHz~25GHz - SC Module

Appendix D.3

Summary

Mode	Result	F-Start (Hz)	F-Stop (Hz)	Type	Freq (Hz)	DG (dBi)	Psum (dBm)	EIRP (dBm)	Limit (dBm)	Margin (dB)
2.4-2.4835GHz	-	-	-	-	-	-	-	-	-	-
BT-LE(1Mbps)	Pass	8G	25G	AV	22.12275G	2.40	-67.50	-65.10	-41.20	-23.90
BT-LE(2Mbps)	Pass	8G	25G	AV	22.15675G	2.40	-67.90	-65.50	-41.20	-24.30

DG = Directional Gain ; PX=Port X; Psum=P1+P2+...PX

Result

Mode	Result	F-Start (Hz)	F-Stop (Hz)	Type	Freq (Hz)	DG (dBi)	Psum (dBm)	EIRP (dBm)	Limit (dBm)	Margin (dB)
BT-LE(1Mbps)	-	-	-	-	-	-	-	-	-	-
2402MHz	Pass	3.1G	4G	AV	3.99843G	2.40	-77.92	-75.52	-41.20	-34.32
2402MHz	Pass	4G	5G	AV	4.80325G	2.40	-77.40	-75.00	-41.20	-33.80
2402MHz	Pass	4G	5G	AV	4.9225G	2.40	-77.09	-74.69	-41.20	-33.49
2402MHz	Pass	5G	7G	AV	5.35G	2.40	-76.56	-74.16	-41.20	-32.96
2402MHz	Pass	7G	8G	AV	7.48925G	2.40	-73.49	-71.09	-41.20	-29.89
2402MHz	Pass	8G	25G	AV	22.15038G	2.40	-68.11	-65.71	-41.20	-24.51
2402MHz	Pass	3.1G	4G	PK	3.87445G	2.40	-67.02	-64.62	-21.20	-43.42
2402MHz	Pass	4G	5G	PK	4.65825G	2.40	-66.42	-64.02	-21.20	-42.82
2402MHz	Pass	4G	5G	PK	4.803G	2.40	-66.91	-64.51	-21.20	-43.31
2402MHz	Pass	5G	7G	PK	5.4215G	2.40	-65.89	-63.49	-21.20	-42.29
2402MHz	Pass	7G	8G	PK	7.4615G	2.40	-62.86	-60.46	-21.20	-39.26
2402MHz	Pass	8G	25G	PK	22.10416G	2.40	-57.95	-55.55	-21.20	-34.35
2440MHz	Pass	3.1G	4G	AV	3.97953G	2.40	-77.78	-75.38	-41.20	-34.18
2440MHz	Pass	4G	5G	AV	4.851G	2.40	-77.34	-74.94	-41.20	-33.74
2440MHz	Pass	4G	5G	AV	4.87975G	2.40	-77.71	-75.31	-41.20	-34.11
2440MHz	Pass	5G	7G	AV	5.441G	2.40	-76.35	-73.95	-41.20	-32.75
2440MHz	Pass	7G	8G	AV	7.465G	2.40	-73.54	-71.14	-41.20	-29.94
2440MHz	Pass	8G	25G	AV	22.14613G	2.40	-68.06	-65.66	-41.20	-24.46
2440MHz	Pass	3.1G	4G	PK	3.92373G	2.40	-66.94	-64.54	-21.20	-43.34
2440MHz	Pass	4G	5G	PK	4.56175G	2.40	-66.38	-63.98	-21.20	-42.78
2440MHz	Pass	4G	5G	PK	4.88G	2.40	-68.27	-65.87	-21.20	-44.67
2440MHz	Pass	5G	7G	PK	5.399G	2.40	-65.91	-63.51	-21.20	-42.31
2440MHz	Pass	7G	8G	PK	7.368G	2.40	-63.19	-60.79	-21.20	-39.59
2440MHz	Pass	8G	25G	PK	22.11584G	2.40	-58.52	-56.12	-21.20	-34.92
2480MHz	Pass	3.1G	4G	AV	3.98605G	2.40	-77.83	-75.43	-41.20	-34.23
2480MHz	Pass	4G	5G	AV	4.86825G	2.40	-77.25	-74.85	-41.20	-33.65
2480MHz	Pass	4G	5G	AV	4.96025G	2.40	-77.54	-75.14	-41.20	-33.94
2480MHz	Pass	5G	7G	AV	5.453G	2.40	-76.35	-73.95	-41.20	-32.75
2480MHz	Pass	7G	8G	AV	7.48775G	2.40	-73.39	-70.99	-41.20	-29.79
2480MHz	Pass	8G	25G	AV	22.12275G	2.40	-67.50	-65.10	-41.20	-23.90
2480MHz	Pass	3.1G	4G	PK	3.97615G	2.40	-67.03	-64.63	-21.20	-43.43
2480MHz	Pass	4G	5G	PK	4.961G	2.40	-68.57	-66.17	-21.20	-44.97
2480MHz	Pass	4G	5G	PK	4.98925G	2.40	-66.32	-63.92	-21.20	-42.72



Unwanted Conducted Emissions into Restricted Frequency Bands 3.1GHz~25GHz - SC Module

Appendix D.3

Mode	Result	F-Start (Hz)	F-Stop (Hz)	Type	Freq (Hz)	DG (dBi)	Psum (dBm)	EIRP (dBm)	Limit (dBm)	Margin (dB)
2480MHz	Pass	5G	7G	PK	5.391G	2.40	-65.71	-63.31	-21.20	-42.11
2480MHz	Pass	7G	8G	PK	7.44825G	2.40	-63.10	-60.70	-21.20	-39.50
2480MHz	Pass	8G	25G	PK	22.07919G	2.40	-59.47	-57.07	-21.20	-35.87
BT-LE(2Mbps)	-	-	-	-	-	-	-	-	-	-
2404MHz	Pass	3.1G	4G	AV	3.87445G	2.40	-77.88	-75.48	-41.20	-34.28
2404MHz	Pass	4G	5G	AV	4.8065G	2.40	-77.84	-75.44	-41.20	-34.24
2404MHz	Pass	4G	5G	AV	4.9715G	2.40	-77.17	-74.77	-41.20	-33.57
2404MHz	Pass	5G	7G	AV	5.419G	2.40	-76.65	-74.25	-41.20	-33.05
2404MHz	Pass	7G	8G	AV	7.48525G	2.40	-73.27	-70.87	-41.20	-29.67
2404MHz	Pass	8G	25G	AV	22.15675G	2.40	-67.90	-65.50	-41.20	-24.30
2404MHz	Pass	3.1G	4G	PK	3.97503G	2.40	-67.05	-64.65	-21.20	-43.45
2404MHz	Pass	4G	5G	PK	4.8065G	2.40	-67.64	-65.24	-21.20	-44.04
2404MHz	Pass	4G	5G	PK	4.9275G	2.40	-66.30	-63.90	-21.20	-42.70
2404MHz	Pass	5G	7G	PK	5.358G	2.40	-65.43	-63.03	-21.20	-41.83
2404MHz	Pass	7G	8G	PK	7.40625G	2.40	-63.06	-60.66	-21.20	-39.46
2404MHz	Pass	8G	25G	PK	22.04997G	2.40	-58.59	-56.19	-21.20	-34.99
2440MHz	Pass	3.1G	4G	AV	3.97435G	2.40	-77.72	-75.32	-41.20	-34.12
2440MHz	Pass	4G	5G	AV	4.88125G	2.40	-77.40	-75.00	-41.20	-33.80
2440MHz	Pass	4G	5G	AV	4.88875G	2.40	-77.09	-74.69	-41.20	-33.49
2440MHz	Pass	5G	7G	AV	5.4525G	2.40	-76.09	-73.69	-41.20	-32.49
2440MHz	Pass	7G	8G	AV	7.46075G	2.40	-73.47	-71.07	-41.20	-29.87
2440MHz	Pass	8G	25G	AV	22.11903G	2.40	-68.18	-65.78	-41.20	-24.58
2440MHz	Pass	3.1G	4G	PK	3.94758G	2.40	-67.83	-65.43	-21.20	-44.23
2440MHz	Pass	4G	5G	PK	4.8795G	2.40	-68.08	-65.68	-21.20	-44.48
2440MHz	Pass	4G	5G	PK	4.892G	2.40	-66.46	-64.06	-21.20	-42.86
2440MHz	Pass	5G	7G	PK	5.3805G	2.40	-66.26	-63.86	-21.20	-42.66
2440MHz	Pass	7G	8G	PK	7.46825G	2.40	-63.29	-60.89	-21.20	-39.69
2440MHz	Pass	8G	25G	PK	22.10309G	2.40	-59.23	-56.83	-21.20	-35.63
2478MHz	Pass	3.1G	4G	AV	3.98583G	2.40	-77.67	-75.27	-41.20	-34.07
2478MHz	Pass	4G	5G	AV	4.79275G	2.40	-77.31	-74.91	-41.20	-33.71
2478MHz	Pass	4G	5G	AV	4.95425G	2.40	-77.80	-75.40	-41.20	-34.20
2478MHz	Pass	5G	7G	AV	5.4515G	2.40	-76.56	-74.16	-41.20	-32.96
2478MHz	Pass	7G	8G	AV	7.46825G	2.40	-73.50	-71.10	-41.20	-29.90
2478MHz	Pass	8G	25G	AV	22.13072G	2.40	-68.07	-65.67	-41.20	-24.47
2478MHz	Pass	3.1G	4G	PK	3.93003G	2.40	-66.90	-64.50	-21.20	-43.30
2478MHz	Pass	4G	5G	PK	4.7385G	2.40	-66.39	-63.99	-21.20	-42.79
2478MHz	Pass	4G	5G	PK	4.95625G	2.40	-67.97	-65.57	-21.20	-44.37
2478MHz	Pass	5G	7G	PK	5.383G	2.40	-66.24	-63.84	-21.20	-42.64
2478MHz	Pass	7G	8G	PK	7.4645G	2.40	-62.84	-60.44	-21.20	-39.24
2478MHz	Pass	8G	25G	PK	22.18809G	2.40	-59.31	-56.91	-21.20	-35.71

DG = Directional Gain ; PX=Port X; Psum=P1+P2+...PX



2.4-2.4835GHz_BT-LE(1Mbps)

CSE-DTS [PK]

2402MHz

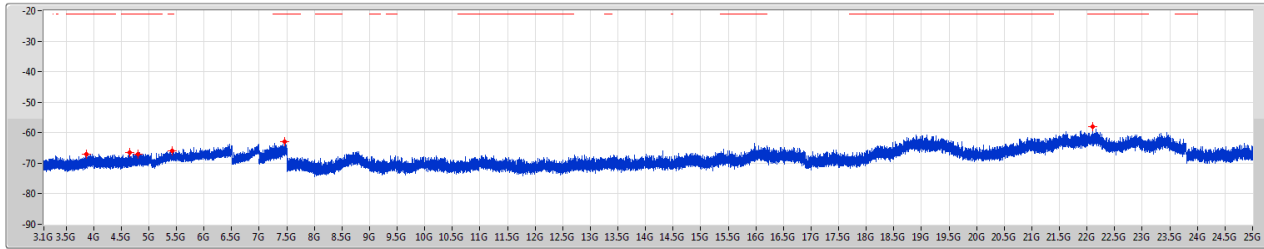

Limit:PK
Port:1

F-Start(Hz)	F-Stop(Hz)	RBW(Hz)	Type	Freq(Hz)	Psum(dBm)	P1(dBm)
3.1G	4G	1M	PK	3.87445G	-67.02	-67.02
4G	5G	1M	PK	4.65825G	-66.42	-66.42
4G	5G	1M	PK	4.803G	-66.91	-66.91
5G	7G	1M	PK	5.4215G	-65.99	-65.99
7G	8G	1M	PK	7.4615G	-62.86	-62.86
8G	25G	1M	PK	22.10416G	-57.95	-57.95

2.4-2.4835GHz_BT-LE(1Mbps)

CSE-DTS [AV]

2402MHz

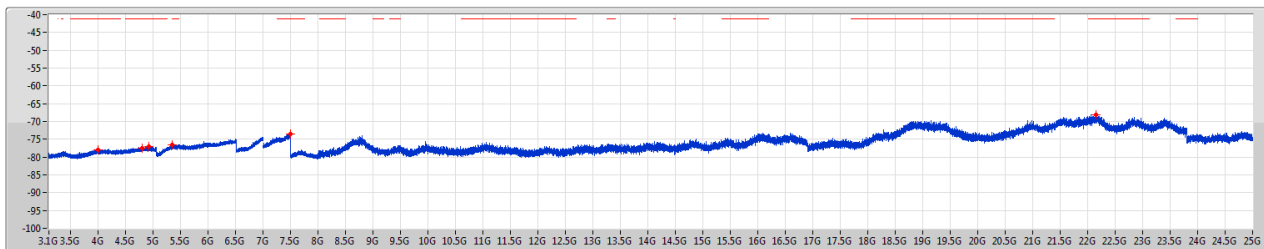

Limit:AV
Port:1

F-Start(Hz)	F-Stop(Hz)	RBW(Hz)	Type	Freq(Hz)	Psum(dBm)	P1(dBm)
3.1G	4G	1M	AV	3.99843G	-77.92	-77.92
4G	5G	1M	AV	4.80325G	-77.40	-77.40
4G	5G	1M	AV	4.9225G	-77.09	-77.09
5G	7G	1M	AV	5.39G	-76.56	-76.56
7G	8G	1M	AV	7.48925G	-73.49	-73.49
8G	25G	1M	AV	22.15038G	-68.11	-68.11



2.4-2.4835GHz_BT-LE(1Mbps)

CSE-DTS [PK]

2440MHz

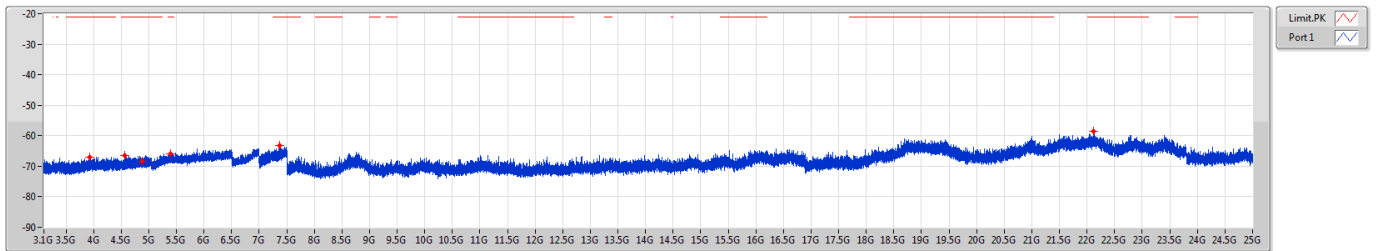

2.4-2.4835GHz_BT-LE(1Mbps)

CSE-DTS [AV]

2440MHz

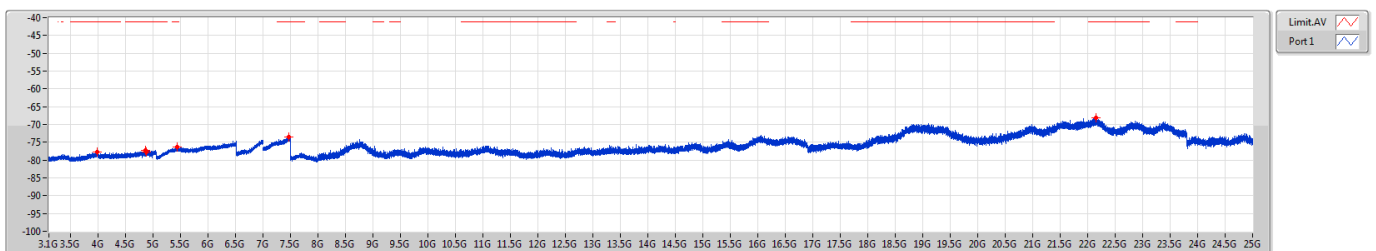



2.4-2.4835GHz_BT-LE(1Mbps)

CSE-DTS [PK]

2480MHz

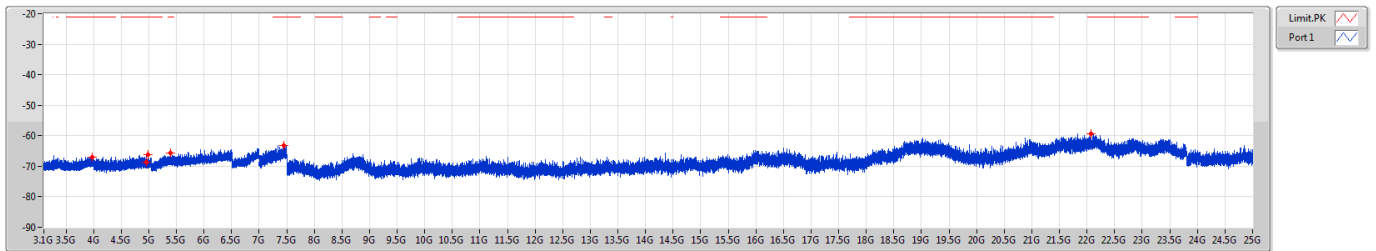

F-Start(Hz)	F-Stop(Hz)	RBW(Hz)	Type	Freq(Hz)	Psum(dBm)	P1(dBm)
3.1G	4G	1M	PK	3.97615G	-67.03	-67.03
4G	5G	1M	PK	4.961G	-68.57	-68.57
4G	5G	1M	PK	4.98925G	-66.32	-66.32
5G	7G	1M	PK	5.391G	-65.71	-65.71
7G	8G	1M	PK	7.44825G	-63.10	-63.10
8G	25G	1M	PK	22.07919G	-59.47	-59.47

2.4-2.4835GHz_BT-LE(1Mbps)

CSE-DTS [AV]

2480MHz

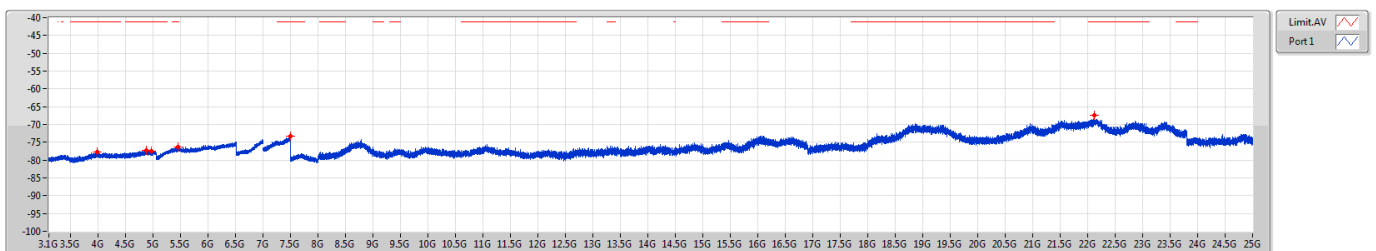

F-Start(Hz)	F-Stop(Hz)	RBW(Hz)	Type	Freq(Hz)	Psum(dBm)	P1(dBm)
3.1G	4G	1M	AV	3.98605G	-77.83	-77.83
4G	5G	1M	AV	4.86825G	-77.25	-77.25
4G	5G	1M	AV	4.96025G	-77.54	-77.54
5G	7G	1M	AV	5.453G	-76.35	-76.35
7G	8G	1M	AV	7.48775G	-73.39	-73.39
8G	25G	1M	AV	22.12275G	-67.50	-67.50



2.4-2.4835GHz_BT-LE(2Mbps)

CSE-DTS [PK]

2404MHz

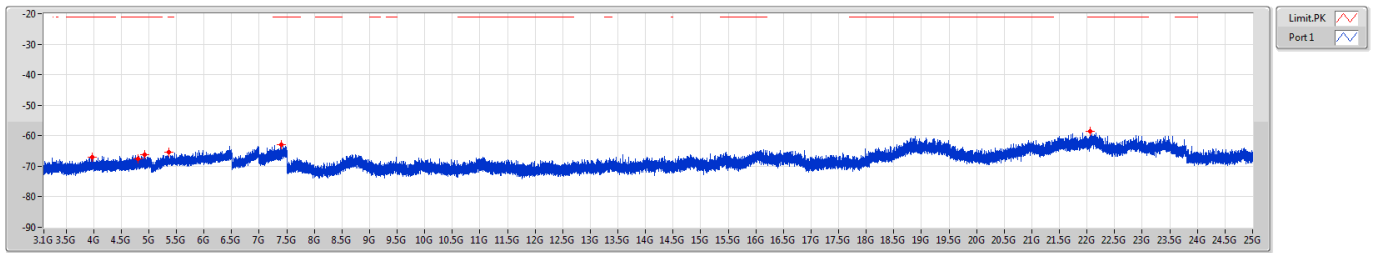

F-Start(Hz)	F-Stop(Hz)	RBW(Hz)	Type	Freq(Hz)	Psum(dBm)	P1(dBm)
3.1G	4G	1M	PK	3.97503G	-67.05	-67.05
4G	5G	1M	PK	4.8065G	-67.64	-67.64
4G	5G	1M	PK	4.9275G	-66.30	-66.30
5G	7G	1M	PK	5.358G	-65.43	-65.43
7G	8G	1M	PK	7.40625G	-63.06	-63.06
8G	25G	1M	PK	22.04997G	-58.59	-58.59

2.4-2.4835GHz_BT-LE(2Mbps)

CSE-DTS [AV]

2404MHz

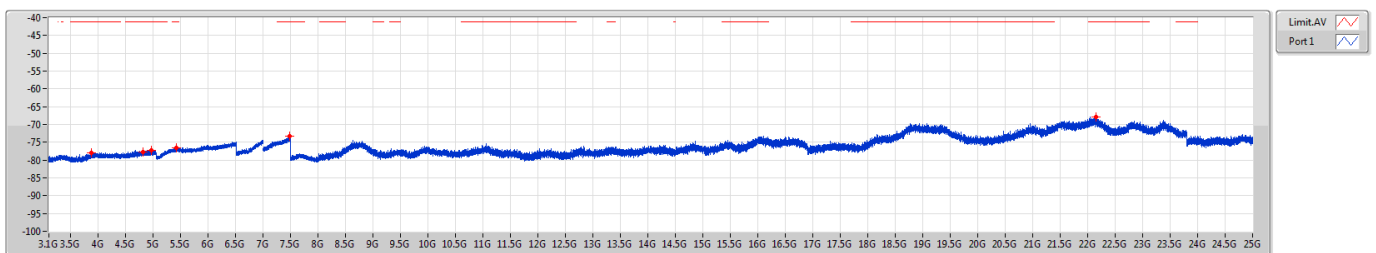

F-Start(Hz)	F-Stop(Hz)	RBW(Hz)	Type	Freq(Hz)	Psum(dBm)	P1(dBm)
3.1G	4G	1M	AV	3.87445G	-77.88	-77.88
4G	5G	1M	AV	4.8065G	-77.84	-77.84
4G	5G	1M	AV	4.9715G	-77.17	-77.17
5G	7G	1M	AV	5.419G	-76.65	-76.65
7G	8G	1M	AV	7.48525G	-73.27	-73.27
8G	25G	1M	AV	22.15675G	-67.90	-67.90



2.4-2.4835GHz_BT-LE(2Mbps)

CSE-DTS [PK]

2440MHz

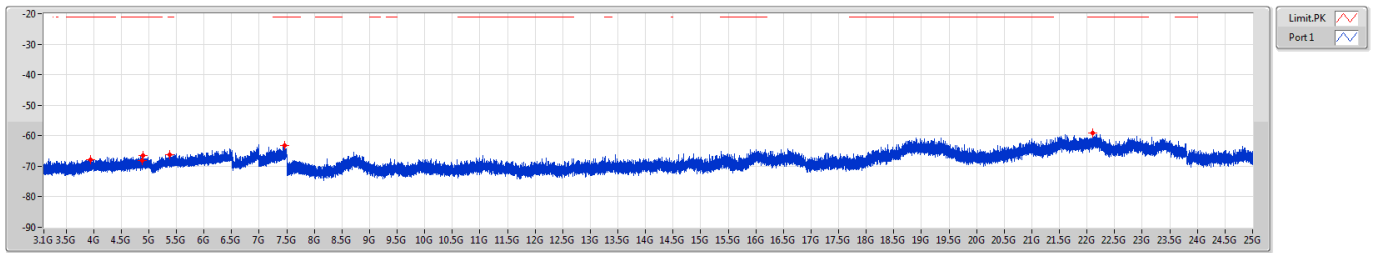

F-Start(Hz)	F-Stop(Hz)	RBW(Hz)	Type	Freq(Hz)	Psum(dBm)	P1(dBm)
3.1G	4G	1M	PK	3.94758G	-67.83	-67.83
4G	5G	1M	PK	4.8795G	-68.08	-68.08
4G	5G	1M	PK	4.892G	-66.46	-66.46
5G	7G	1M	PK	5.3805G	-66.26	-66.26
7G	8G	1M	PK	7.46825G	-63.29	-63.29
8G	25G	1M	PK	22.10309G	-59.23	-59.23

2.4-2.4835GHz_BT-LE(2Mbps)

CSE-DTS [AV]

2440MHz

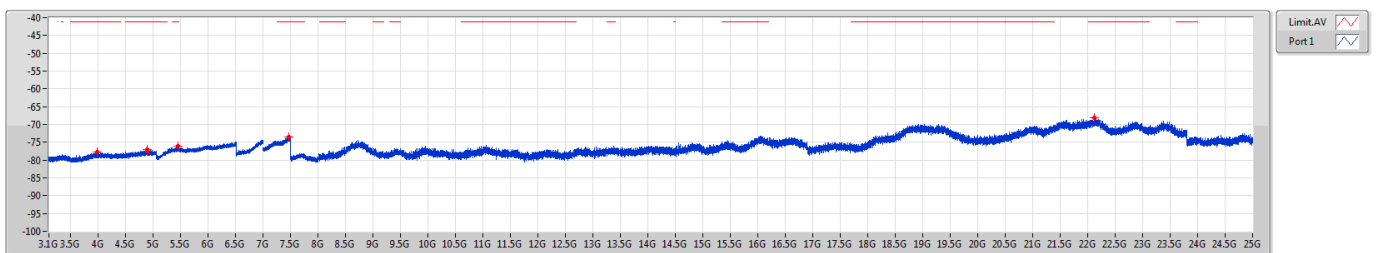

F-Start(Hz)	F-Stop(Hz)	RBW(Hz)	Type	Freq(Hz)	Psum(dBm)	P1(dBm)
3.1G	4G	1M	AV	3.97435G	-77.72	-77.72
4G	5G	1M	AV	4.88125G	-77.40	-77.40
4G	5G	1M	AV	4.88875G	-77.09	-77.09
5G	7G	1M	AV	5.4525G	-76.09	-76.09
7G	8G	1M	AV	7.46075G	-73.47	-73.47
8G	25G	1M	AV	22.11909G	-68.18	-68.18



2.4-2.4835GHz_BT-LE(2Mbps)

CSE-DTS [PK]

2478MHz

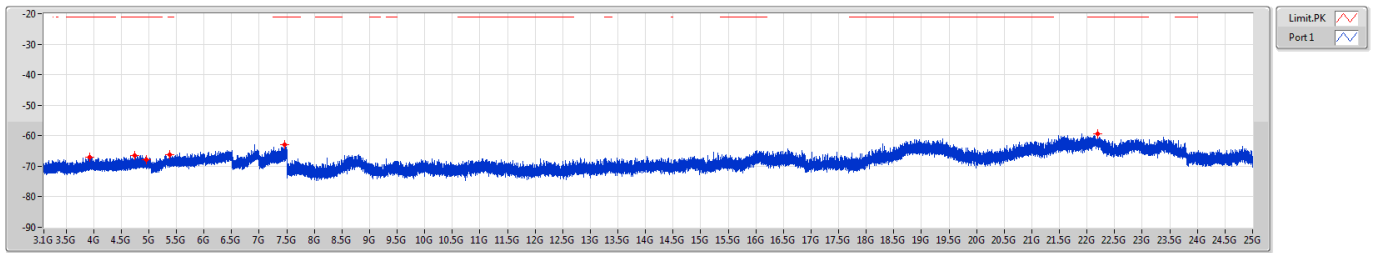

F-Start(Hz)	F-Stop(Hz)	RBW(Hz)	Type	Freq(Hz)	Psum(dBm)	P1(dBm)
3.1G	4G	1M	PK	3.93003G	-66.90	-66.90
4G	5G	1M	PK	4.7385G	-66.39	-66.39
4G	5G	1M	PK	4.95625G	-67.97	-67.97
5G	7G	1M	PK	5.383G	-66.24	-66.24
7G	8G	1M	PK	7.4645G	-62.84	-62.84
8G	25G	1M	PK	22.18809G	-59.31	-59.31

2.4-2.4835GHz_BT-LE(2Mbps)

CSE-DTS [AV]

2478MHz

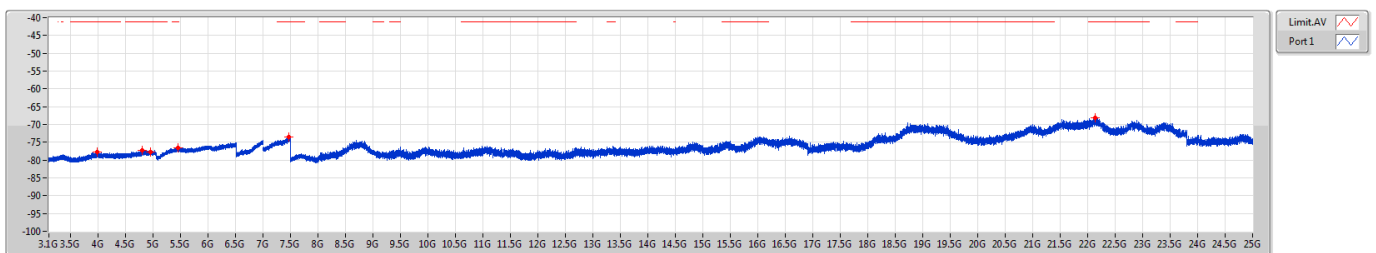

F-Start(Hz)	F-Stop(Hz)	RBW(Hz)	Type	Freq(Hz)	Psum(dBm)	P1(dBm)
3.1G	4G	1M	AV	3.98583G	-77.67	-77.67
4G	5G	1M	AV	4.79275G	-77.31	-77.31
4G	5G	1M	AV	4.95425G	-77.80	-77.80
5G	7G	1M	AV	5.4515G	-76.56	-76.56
7G	8G	1M	AV	7.46825G	-73.50	-73.50
8G	25G	1M	AV	22.13072G	-68.07	-68.07



Summary

Mode	Result	F-Start (Hz)	F-Stop (Hz)	Type	Freq (Hz)	DG (dBi)	Psum (dBm)	GRF (dB)	EIRP (dBm)	Limit (dBm)	Margin (dB)
2.4-2.4835GHz	-	-	-	-	-	-	-	-	-	-	-
BT-LE(1Mbps)	Pass	30M	1G	PK	37.88M	2.40	-77.52	4.7	-70.42	-55.20	-15.22

DG = Directional Gain ; PX=Port X; Psum=P1+P2+...PX

Result

Mode	Result	F-Start (Hz)	F-Stop (Hz)	Type	Freq (Hz)	DG (dBi)	Psum (dBm)	GRF (dB)	EIRP (dBm)	Limit (dBm)	Margin (dB)
BT-LE(1Mbps)	-	-	-	-	-	-	-	-	-	-	-
2402MHz	Pass	30M	1G	PK	37.88M	2.40	-77.52	4.7	-70.42	-55.20	-15.22

DG = Directional Gain ; PX=Port X; Psum=P1+P2+...PX

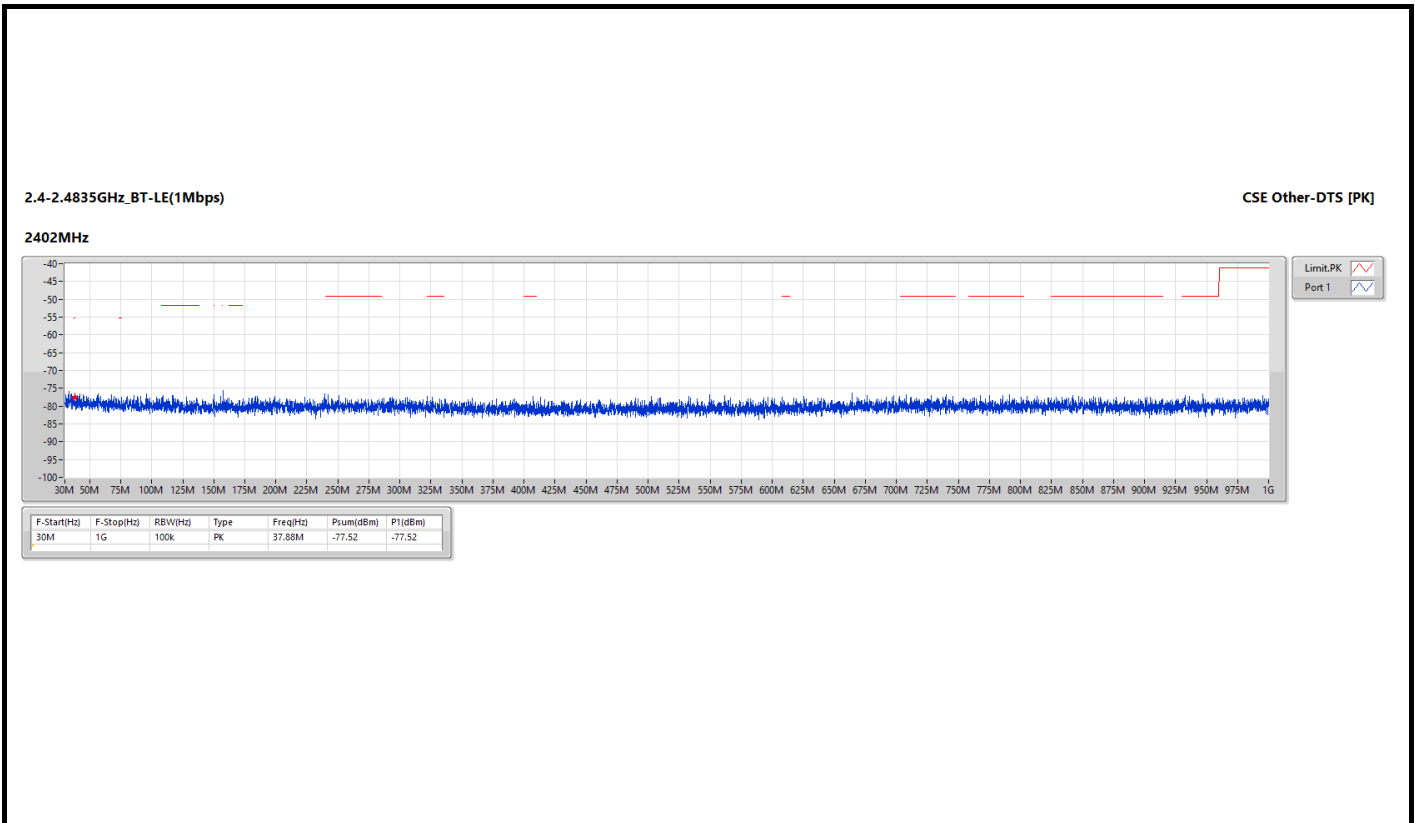



**Unwanted Conducted Emissions into Restricted
Frequency Bands 1GHz~3.1GHz - ST Module**

Appendix D.5

Summary

Mode	Result	F-Start (Hz)	F-Stop (Hz)	Type	Freq (Hz)	DG (dBi)	Psum (dBm)	EIRP (dBm)	Limit (dBm)	Margin (dB)
2.4-2.4835GHz	-	-	-	-	-	-	-	-	-	-
BT-LE(1Mbps)	Pass	2.4835G	2.5G	AV	2.48429G	2.40	-63.22	-60.82	-41.20	-19.62

DG = Directional Gain ; PX=Port X; Psum=P1+P2+...PX

Result

Mode	Result	F-Start (Hz)	F-Stop (Hz)	Type	Freq (Hz)	DG (dBi)	Psum (dBm)	EIRP (dBm)	Limit (dBm)	Margin (dB)
BT-LE(1Mbps)	-	-	-	-	-	-	-	-	-	-
2480MHz	Pass	1G	2.31G	AV	2.15231G	2.40	-64.76	-62.36	-41.20	-21.16
2480MHz	Pass	2.31G	2.39G	AV	2.35944G	2.40	-66.32	-63.92	-41.20	-22.72
2480MHz	Pass	2.4835G	2.5G	AV	2.48429G	2.40	-63.22	-60.82	-41.20	-19.62
2480MHz	Pass	2.5G	3.1G	AV	2.5504G	2.40	-63.27	-60.87	-41.20	-19.67
2480MHz	Pass	1G	2.31G	PK	2.2242G	2.40	-52.81	-50.41	-21.20	-29.21
2480MHz	Pass	2.31G	2.39G	PK	2.34992G	2.40	-55.21	-52.81	-21.20	-31.61
2480MHz	Pass	2.4835G	2.5G	PK	2.48407G	2.40	-52.05	-49.65	-21.20	-28.45
2480MHz	Pass	2.5G	3.1G	PK	2.6968G	2.40	-54.18	-51.78	-21.20	-30.58

DG = Directional Gain ; PX=Port X; Psum=P1+P2+...PX



2.4-2.4835GHz_BT-LE(1Mbps)

CSE Bandedge-DTS [PK]

2480MHz

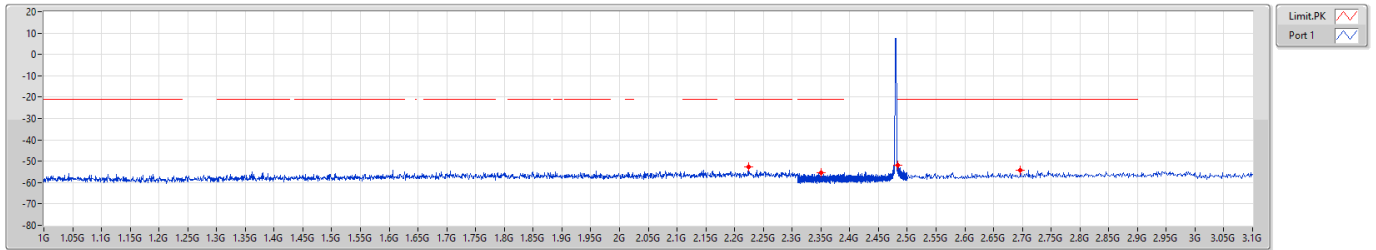

F-Start(Hz)	F-Stop(Hz)	RBW(Hz)	Type	Freq(Hz)	Psum(dBm)	P1(dBm)
1G	2.31G	1M	PK	2.2242G	-52.81	-52.81
2.31G	2.39G	1M	PK	2.34992G	-55.21	-55.21
2.4835G	2.5G	1M	PK	2.48407G	-52.05	-52.05
2.5G	3.1G	1M	PK	2.6966G	-54.18	-54.18

2.4-2.4835GHz_BT-LE(1Mbps)

CSE Bandedge-DTS [AV]

2480MHz

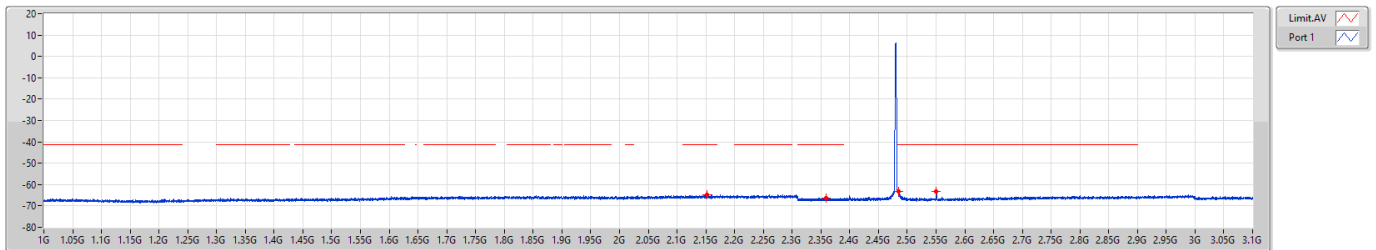

F-Start(Hz)	F-Stop(Hz)	RBW(Hz)	Type	Freq(Hz)	Psum(dBm)	P1(dBm)
1G	2.31G	1M	AV	2.15231G	-64.76	-64.76
2.31G	2.39G	1M	AV	2.35944G	-66.32	-66.32
2.4835G	2.5G	1M	AV	2.48429G	-63.22	-63.22
2.5G	3.1G	1M	AV	2.5504G	-63.27	-63.27



**Unwanted Conducted Emissions into Restricted
Frequency Bands 3.1GHz~25GHz - ST Module**

Appendix D.6

Summary

Mode	Result	F-Start (Hz)	F-Stop (Hz)	Type	Freq (Hz)	DG (dBi)	Psum (dBm)	EIRP (dBm)	Limit (dBm)	Margin (dB)
2.4-2.4835GHz	-	-	-	-	-	-	-	-	-	-
BT-LE(1Mbps)	Pass	8G	25G	AV	22.05475G	2.40	-68.21	-65.81	-41.20	-24.61

DG = Directional Gain ; PX=Port X; Psum=P1+P2+...PX

Result

Mode	Result	F-Start (Hz)	F-Stop (Hz)	Type	Freq (Hz)	DG (dBi)	Psum (dBm)	EIRP (dBm)	Limit (dBm)	Margin (dB)
BT-LE(1Mbps)	-	-	-	-	-	-	-	-	-	-
2480MHz	Pass	3.1G	4G	AV	3.95838G	2.40	-77.97	-75.57	-41.20	-34.37
2480MHz	Pass	4G	5G	AV	4.80475G	2.40	-77.49	-75.09	-41.20	-33.89
2480MHz	Pass	4G	5G	AV	4.96G	2.40	-77.74	-75.34	-41.20	-34.14
2480MHz	Pass	5G	7G	AV	5.444G	2.40	-76.51	-74.11	-41.20	-32.91
2480MHz	Pass	7G	8G	AV	7.49075G	2.40	-73.58	-71.18	-41.20	-29.98
2480MHz	Pass	8G	25G	AV	22.05475G	2.40	-68.21	-65.81	-41.20	-24.61
2480MHz	Pass	3.1G	4G	PK	3.94083G	2.40	-67.50	-65.10	-21.20	-43.90
2480MHz	Pass	4G	5G	PK	4.85725G	2.40	-65.73	-63.33	-21.20	-42.13
2480MHz	Pass	4G	5G	PK	4.96G	2.40	-68.27	-65.87	-21.20	-44.67
2480MHz	Pass	5G	7G	PK	5.459G	2.40	-65.84	-63.44	-21.20	-42.24
2480MHz	Pass	7G	8G	PK	7.44025G	2.40	-63.77	-61.37	-21.20	-40.17
2480MHz	Pass	8G	25G	PK	22.1525G	2.40	-59.31	-56.91	-21.20	-35.71

DG = Directional Gain ; PX=Port X; Psum=P1+P2+...PX



2.4-2.4835GHz_BT-LE(1Mbps)

CSE-DTS [PK]

2480MHz

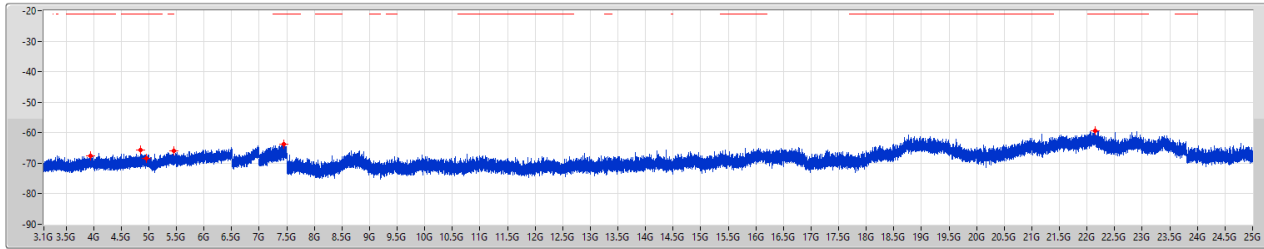

F-Start(Hz)	F-Stop(Hz)	RBW(Hz)	Type	Freq(Hz)	Psum(dBm)	P1(dBm)
3.1G	4G	1M	PK	3.94083G	-67.50	-67.50
4G	5G	1M	PK	4.85725G	-65.73	-65.73
4G	5G	1M	PK	4.96G	-68.27	-68.27
5G	7G	1M	PK	5.4596G	-65.84	-65.84
7G	8G	1M	PK	7.44025G	-63.77	-63.77
8G	25G	1M	PK	22.1525G	-59.31	-59.31

2.4-2.4835GHz_BT-LE(1Mbps)

CSE-DTS [AV]

2480MHz

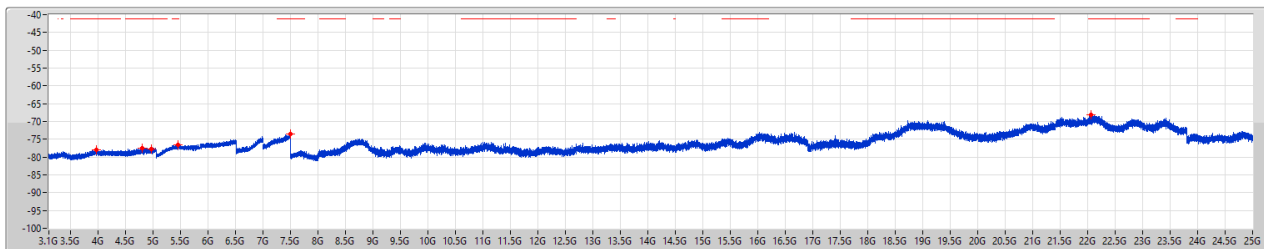

F-Start(Hz)	F-Stop(Hz)	RBW(Hz)	Type	Freq(Hz)	Psum(dBm)	P1(dBm)
3.1G	4G	1M	AV	3.95838G	-77.97	-77.97
4G	5G	1M	AV	4.80475G	-77.49	-77.49
4G	5G	1M	AV	4.96G	-77.74	-77.74
5G	7G	1M	AV	5.4446G	-76.51	-76.51
7G	8G	1M	AV	7.49075G	-73.58	-73.58
8G	25G	1M	AV	22.05475G	-68.21	-68.21



SC Module

Unwanted Emissions (Below 1GHz)

Modulation	BT-LE (1Mbps)	Test Freq. (MHz)	2402
Polarization	Horizontal		

Test By : Sean Yu Temperature(°C): 26 Humidity(%): 61

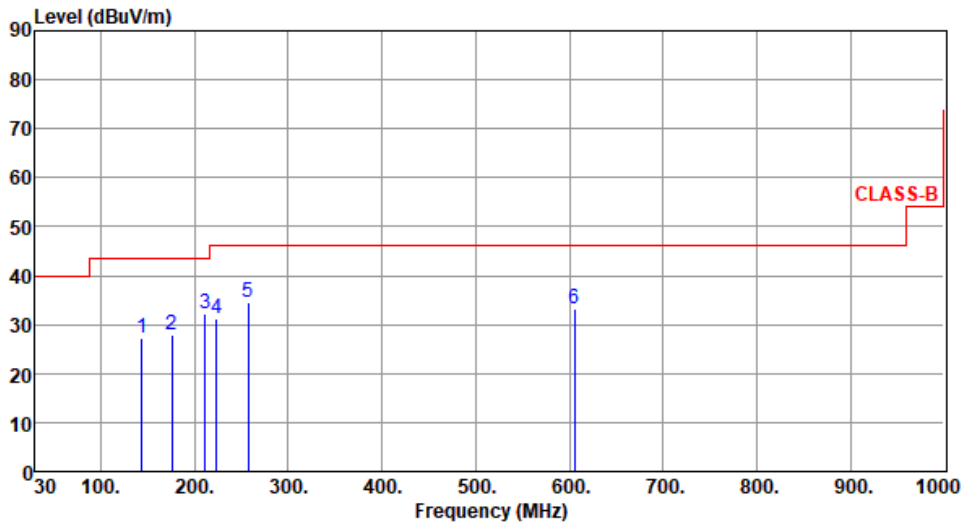

	Freq. MHz	Emission level dBuV/m	Limit dBuV/m	Margin dB	SA reading dBuV	Factor dB/m	Remark	ANT High cm	Turn Table deg
1	143.58	27.38	43.50	-16.12	36.37	-8.99	Peak	---	---
2	176.22	27.84	43.50	-15.66	37.66	-9.82	Peak	---	---
3	211.34	32.15	43.50	-11.35	44.13	-11.98	Peak	---	---
4	223.47	31.17	46.00	-14.83	43.15	-11.98	Peak	---	---
5	257.33	34.55	46.00	-11.45	44.23	-9.68	Peak	---	---
6	605.38	33.18	46.00	-12.82	33.62	-0.44	Peak	---	---

Note 1: Emission Level (dBuV/m) = SA Reading (dBuV) + Factor* (dB/m)

*Factor includes antenna factor , cable loss and amplifier gain

Note 2: Margin (dB) = Emission level (dBuV/m) – Limit (dBuV/m).

Note 3: All spurious emissions below 30MHz are more than 20 dB below the limit.



Unwanted Radiated Emissions into Restricted Frequency Bands Appendix D.7

Modulation	BT-LE (1Mbps)	Test Freq. (MHz)	2402
------------	---------------	------------------	------

Polarization	Vertical
--------------	----------

Test By : Sean Yu Temperature(°C): 26 Humidity(%): 61

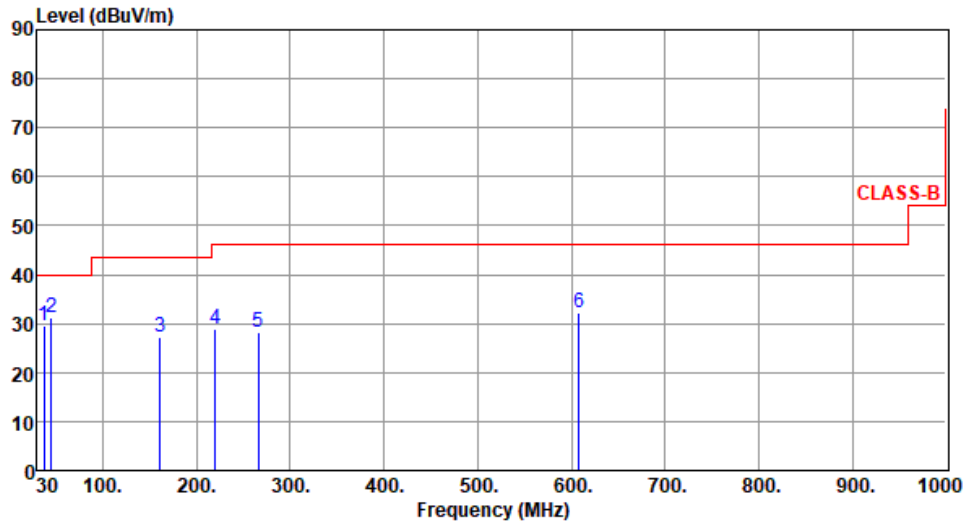

	Freq. MHz	Emission level dBuV/m	Limit dBuV/m	Margin dB	SA reading dBuV	Factor dB/m	Remark	ANT High cm	Turn Table deg
1	36.98	29.61	40.00	-10.39	38.87	-9.26	Peak	---	---
2	45.15	31.08	40.00	-8.92	39.20	-8.12	Peak	---	---
3	161.13	27.15	43.50	-16.35	35.99	-8.84	Peak	---	---
4	220.11	28.84	46.00	-17.16	40.69	-11.85	Peak	---	---
5	266.16	28.35	46.00	-17.65	37.59	-9.24	Peak	---	---
6	607.83	32.13	46.00	-13.87	32.51	-0.38	Peak	---	---

Note 1: Emission Level (dBuV/m) = SA Reading (dBuV) + Factor* (dB/m)

*Factor includes antenna factor , cable loss and amplifier gain

Note 2: Margin (dB) = Emission level (dBuV/m) – Limit (dBuV/m).

Note 3: All spurious emissions below 30MHz are more than 20 dB below the limit.



Unwanted Emissions (Above 1GHz)

Modulation	BT-LE (1Mbps)	Test Freq. (MHz)	2402
Polarization	Horizontal		

Test By :Sean Yu Temperature(°C):26 Humidity(%):61

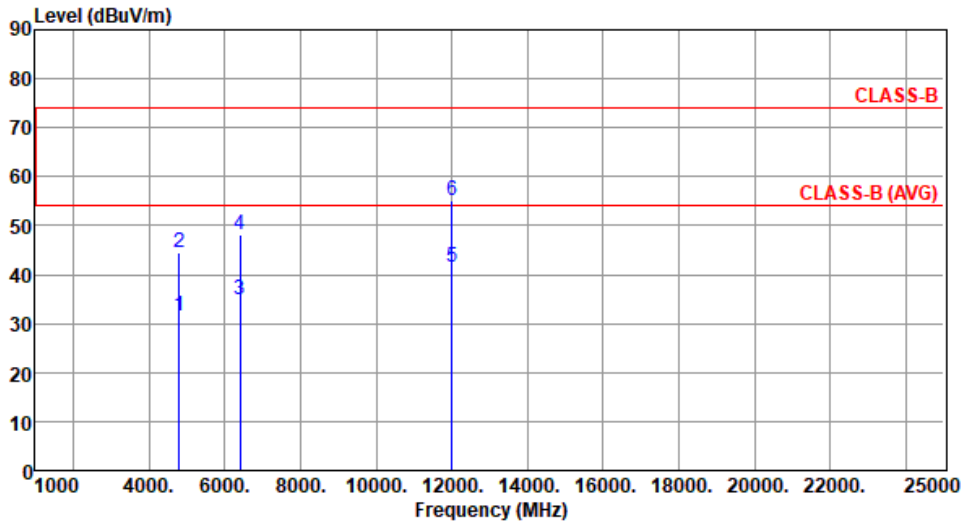

	Freq. MHz	Emission level dBuV/m	Limit dBuV/m	Margin dB	SA reading dBuV	Factor dB/m	Remark	ANT High cm	Turn Table deg
1	4804.00	31.63	54.00	-22.37	31.90	-0.27	Average	100	145
2	4804.00	44.65	74.00	-29.35	44.92	-0.27	Peak	100	145
3	6405.33	34.97	54.00	-19.03	32.37	2.60	Average	100	176
4	6405.33	48.07	74.00	-25.93	45.47	2.60	Peak	100	176
5	12010.00	41.39	54.00	-12.61	34.87	6.52	Average	100	204
6	12010.00	55.21	74.00	-18.79	48.69	6.52	Peak	100	204

Note 1: Emission Level (dBuV/m) = SA Reading (dBuV) + Factor* (dB/m)
 *Factor includes antenna factor , cable loss and amplifier gain
 Note 2: Margin (dB) = Emission level (dBuV/m) – Limit (dBuV/m).



Unwanted Radiated Emissions into Restricted Frequency Bands Appendix D.7

Modulation	BT-LE (1Mbps)	Test Freq. (MHz)	2402
------------	---------------	------------------	------

Polarization	Vertical
--------------	----------

Test By :Sean Yu Temperature(°C):26 Humidity(%):61

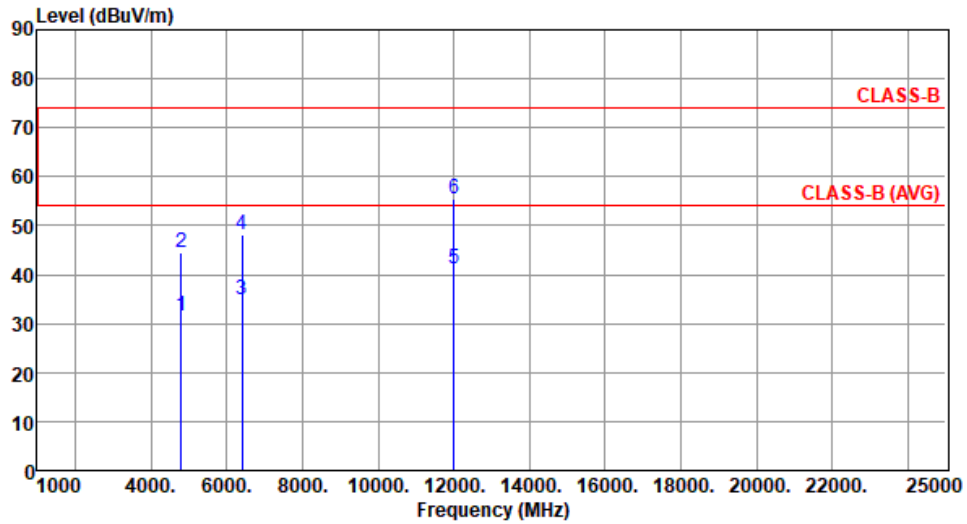

	Freq. MHz	Emission level dBuV/m	Limit dBuV/m	Margin dB	SA reading dBuV	Factor dB/m	Remark	ANT High cm	Turn Table deg
1	4804.00	31.58	54.00	-22.42	31.85	-0.27	Average	100	201
2	4804.00	44.55	74.00	-29.45	44.82	-0.27	Peak	100	201
3	6405.33	34.89	54.00	-19.11	32.29	2.60	Average	100	213
4	6405.33	48.10	74.00	-25.90	45.50	2.60	Peak	100	213
5	12010.00	41.28	54.00	-12.72	34.76	6.52	Average	100	117
6	12010.00	55.31	74.00	-18.69	48.79	6.52	Peak	100	117

Note 1: Emission Level (dBuV/m) = SA Reading (dBuV) + Factor* (dB/m)

*Factor includes antenna factor , cable loss and amplifier gain

Note 2: Margin (dB) = Emission level (dBuV/m) – Limit (dBuV/m).



Unwanted Radiated Emissions into Restricted Frequency Bands Appendix D.7

Modulation	BT-LE (1Mbps)	Test Freq. (MHz)	2440
Polarization	Horizontal		

Test By : Sean Yu Temperature(°C): 26 Humidity(%): 61

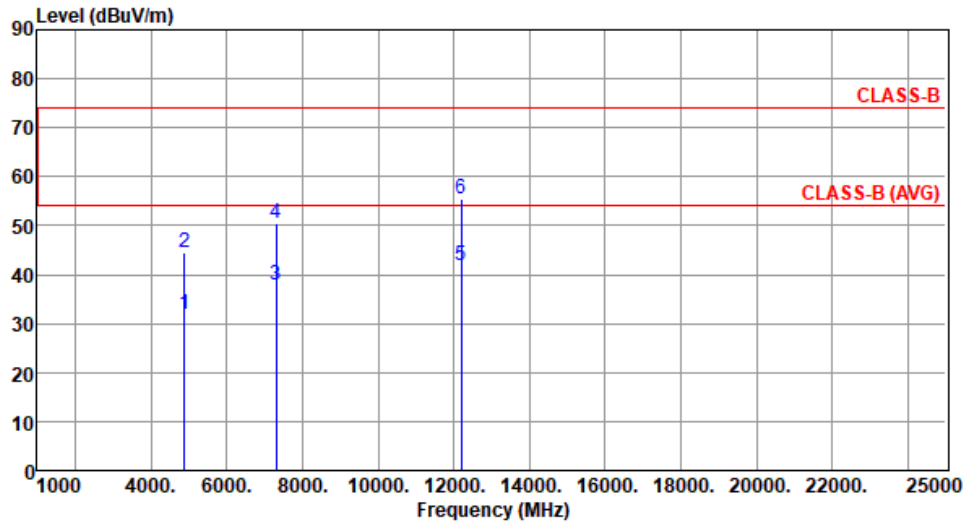

	Freq. MHz	Emission level dBuV/m	Limit dBuV/m	Margin dB	SA reading dBuV	Factor dB/m	Remark	ANT High cm	Turn Table deg
1	4880.00	31.72	54.00	-22.28	31.97	-0.25	Average	100	174
2	4880.00	44.60	74.00	-29.40	44.85	-0.25	Peak	100	174
3	7320.00	37.81	54.00	-16.19	32.38	5.43	Average	100	203
4	7320.00	50.60	74.00	-23.40	45.17	5.43	Peak	100	203
5	12200.00	41.88	54.00	-12.12	35.34	6.54	Average	100	147
6	12200.00	55.56	74.00	-18.44	49.02	6.54	Peak	100	147

Note 1: Emission Level (dBuV/m) = SA Reading (dBuV) + Factor* (dB/m)
 *Factor includes antenna factor , cable loss and amplifier gain
 Note 2: Margin (dB) = Emission level (dBuV/m) – Limit (dBuV/m).



Unwanted Radiated Emissions into Restricted Frequency Bands Appendix D.7

Modulation	BT-LE (1Mbps)	Test Freq. (MHz)	2440
Polarization	Vertical		

Test By : Sean Yu Temperature(°C): 26 Humidity(%): 61

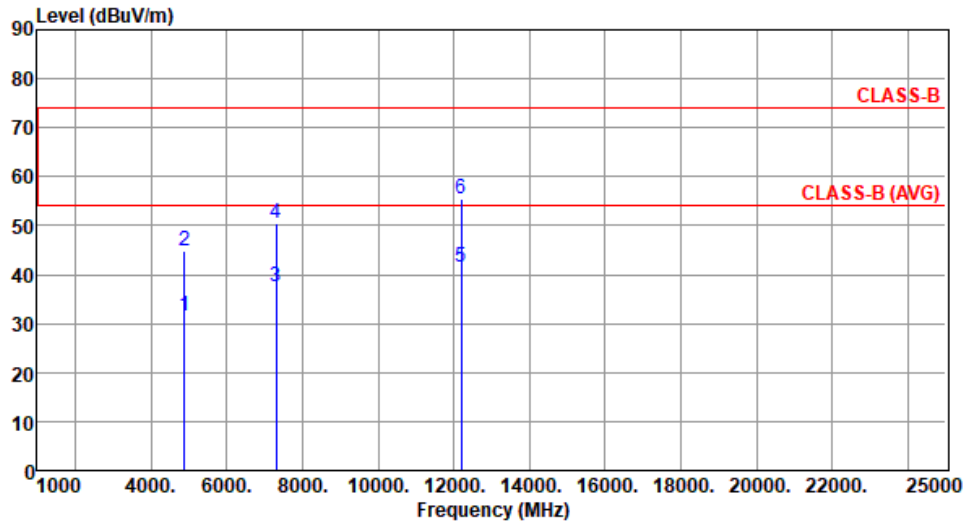

	Freq. MHz	Emission level dBuV/m	Limit dBuV/m	Margin dB	SA reading dBuV	Factor dB/m	Remark	ANT High cm	Turn Table deg
1	4880.00	31.66	54.00	-22.34	31.91	-0.25	Average	100	213
2	4880.00	44.72	74.00	-29.28	44.97	-0.25	Peak	100	213
3	7320.00	37.54	54.00	-16.46	32.11	5.43	Average	100	117
4	7320.00	50.64	74.00	-23.36	45.21	5.43	Peak	100	117
5	12200.00	41.65	54.00	-12.35	35.11	6.54	Average	100	200
6	12200.00	55.38	74.00	-18.62	48.84	6.54	Peak	100	200

Note 1: Emission Level (dBuV/m) = SA Reading (dBuV) + Factor* (dB/m)

*Factor includes antenna factor , cable loss and amplifier gain

Note 2: Margin (dB) = Emission level (dBuV/m) – Limit (dBuV/m).



Unwanted Radiated Emissions into Restricted Frequency Bands Appendix D.7

Modulation	BT-LE (1Mbps)	Test Freq. (MHz)	2480
------------	---------------	------------------	------

Polarization	Horizontal
--------------	------------

Test By : Sean Yu Temperature(°C): 26 Humidity(%): 61

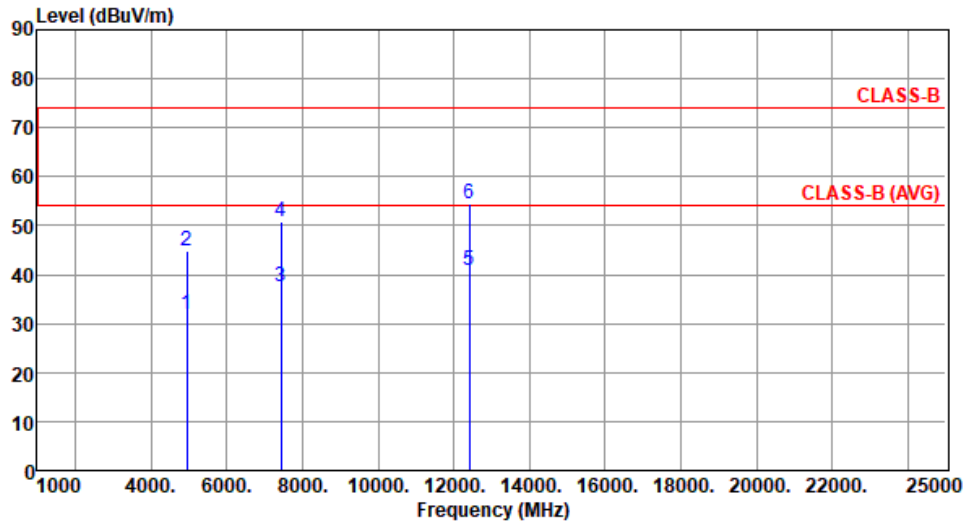

	Freq. MHz	Emission level dBuV/m	Limit dBuV/m	Margin dB	SA reading dBuV	Factor dB/m	Remark	ANT High cm	Turn Table deg
1	4960.00	31.86	54.00	-22.14	31.97	-0.11	Average	100	145
2	4960.00	44.99	74.00	-29.01	45.10	-0.11	Peak	100	145
3	7440.00	37.58	54.00	-16.42	32.21	5.37	Average	100	125
4	7440.00	50.79	74.00	-23.21	45.42	5.37	Peak	100	125
5	12400.00	40.96	54.00	-13.04	34.66	6.30	Average	100	204
6	12400.00	54.61	74.00	-19.39	48.31	6.30	Peak	100	204

Note 1: Emission Level (dBuV/m) = SA Reading (dBuV) + Factor* (dB/m)

*Factor includes antenna factor , cable loss and amplifier gain

Note 2: Margin (dB) = Emission level (dBuV/m) – Limit (dBuV/m).



Unwanted Radiated Emissions into Restricted Frequency Bands Appendix D.7

Modulation	BT-LE (1Mbps)	Test Freq. (MHz)	2480
------------	---------------	------------------	------

Polarization	Vertical
--------------	----------

Test By :Sean Yu Temperature(°C):26 Humidity(%):61

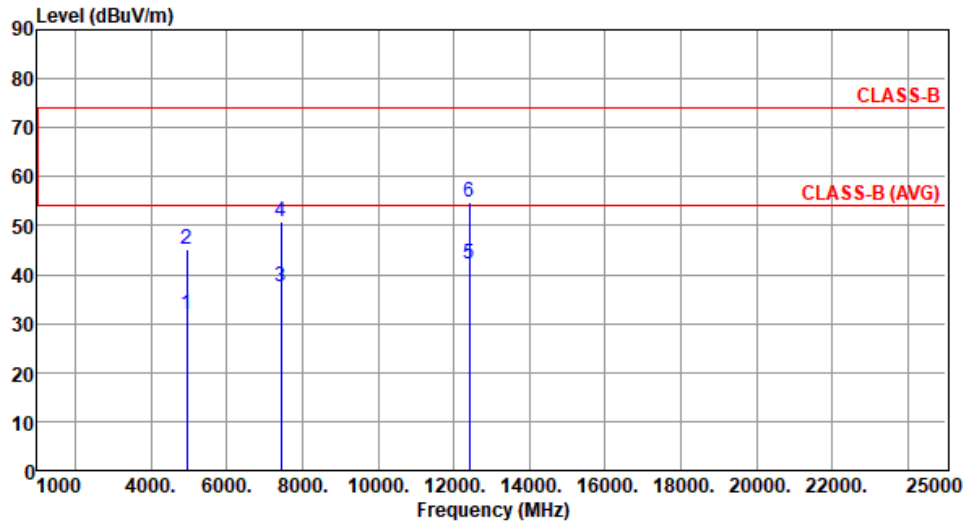

	Freq. MHz	Emission level dBuV/m	Limit dBuV/m	Margin dB	SA reading dBuV	Factor dB/m	Remark	ANT High cm	Turn Table deg
1	4960.00	31.93	54.00	-22.07	32.04	-0.11	Average	100	186
2	4960.00	45.16	74.00	-28.84	45.27	-0.11	Peak	100	186
3	7440.00	37.48	54.00	-16.52	32.11	5.37	Average	100	102
4	7440.00	50.90	74.00	-23.10	45.53	5.37	Peak	100	102
5	12400.00	42.26	54.00	-11.74	35.96	6.30	Average	100	276
6	12400.00	54.72	74.00	-19.28	48.42	6.30	Peak	100	276

Note 1: Emission Level (dBuV/m) = SA Reading (dBuV) + Factor* (dB/m)

*Factor includes antenna factor , cable loss and amplifier gain

Note 2: Margin (dB) = Emission level (dBuV/m) – Limit (dBuV/m).



Unwanted Radiated Emissions into Restricted Frequency Bands Appendix D.7

Modulation	BT-LE (2Mbps)	Test Freq. (MHz)	2404
Polarization	Horizontal		

Test By : Sean Yu Temperature(°C): 26 Humidity(%): 61

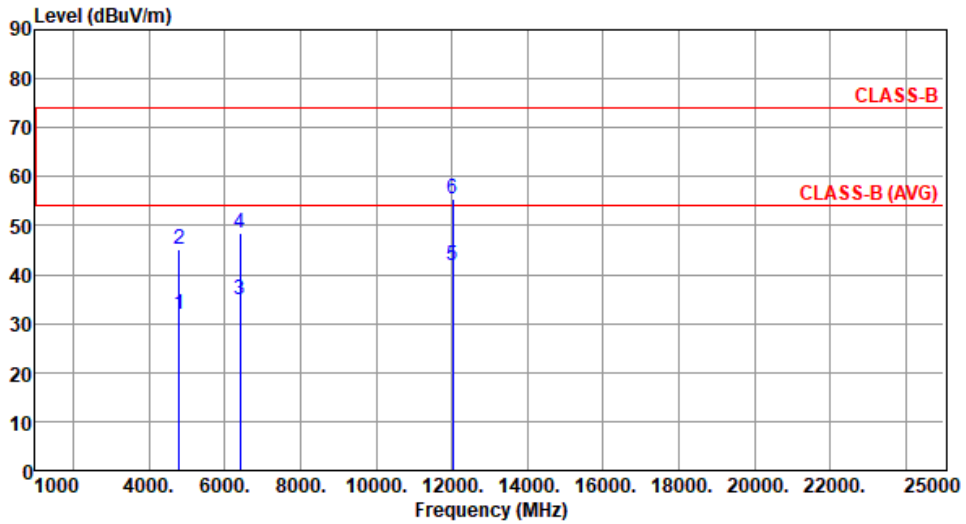

	Freq. MHz	Emission level dBuV/m	Limit dBuV/m	Margin dB	SA reading dBuV	Factor dB/m	Remark	ANT High cm	Turn Table deg
1	4808.00	31.88	54.00	-22.12	32.14	-0.26	Average	100	223
2	4808.00	45.21	74.00	-28.79	45.47	-0.26	Peak	100	223
3	6410.66	35.02	54.00	-18.98	32.39	2.63	Average	100	204
4	6410.66	48.38	74.00	-25.62	45.75	2.63	Peak	100	204
5	12020.00	41.85	54.00	-12.15	35.29	6.56	Average	100	113
6	12020.00	55.30	74.00	-18.70	48.74	6.56	Peak	100	113

Note 1: Emission Level (dBuV/m) = SA Reading (dBuV) + Factor* (dB/m)

*Factor includes antenna factor , cable loss and amplifier gain

Note 2: Margin (dB) = Emission level (dBuV/m) – Limit (dBuV/m).



Unwanted Radiated Emissions into Restricted Frequency Bands Appendix D.7

Modulation	BT-LE (2Mbps)	Test Freq. (MHz)	2404
Polarization	Vertical		

Test By :Sean Yu Temperature(°C):26 Humidity(%):61

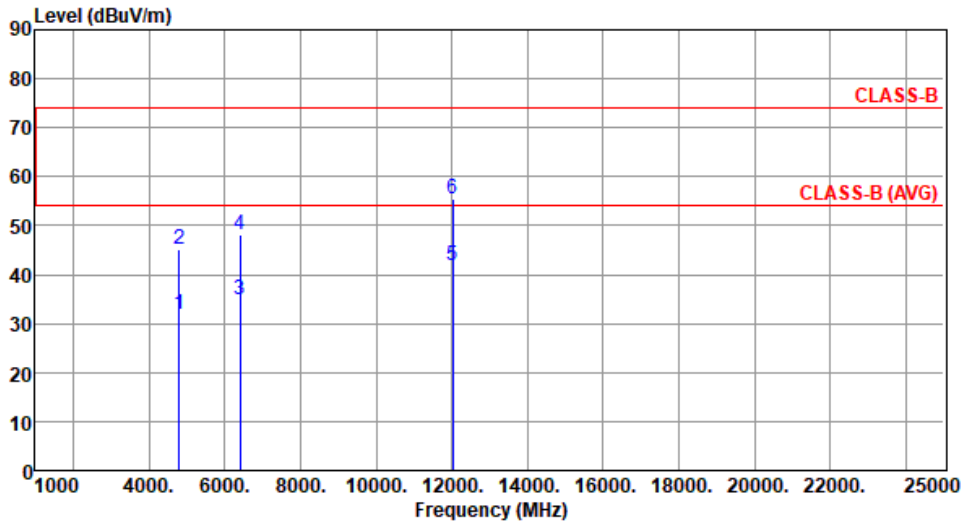

	Freq. MHz	Emission level dBuV/m	Limit dBuV/m	Margin dB	SA reading dBuV	Factor dB/m	Remark	ANT High cm	Turn Table deg
1	4808.00	31.75	54.00	-22.25	32.01	-0.26	Average	100	186
2	4808.00	45.08	74.00	-28.92	45.34	-0.26	Peak	100	186
3	6410.66	34.96	54.00	-19.04	32.33	2.63	Average	100	182
4	6410.66	48.27	74.00	-25.73	45.64	2.63	Peak	100	182
5	12020.00	41.93	54.00	-12.07	35.37	6.56	Average	100	258
6	12020.00	55.40	74.00	-18.60	48.84	6.56	Peak	100	258

Note 1: Emission Level (dBuV/m) = SA Reading (dBuV) + Factor* (dB/m)

*Factor includes antenna factor , cable loss and amplifier gain

Note 2: Margin (dB) = Emission level (dBuV/m) – Limit (dBuV/m).



Unwanted Radiated Emissions into Restricted Frequency Bands Appendix D.7

Modulation	BT-LE (2Mbps)	Test Freq. (MHz)	2440
Polarization	Horizontal		

Test By :Sean Yu Temperature(°C):26 Humidity(%):61

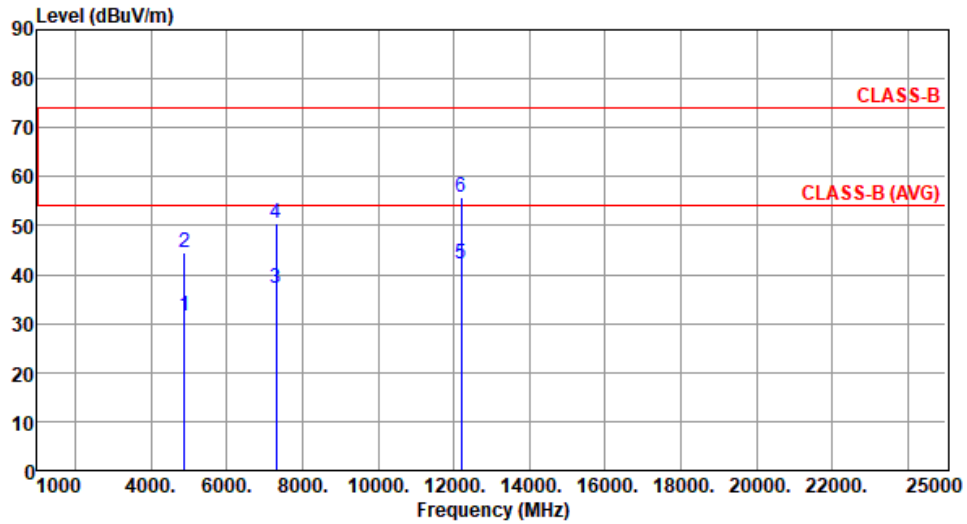

	Freq. MHz	Emission level dBuV/m	Limit dBuV/m	Margin dB	SA reading dBuV	Factor dB/m	Remark	ANT High cm	Turn Table deg
1	4880.00	31.62	54.00	-22.38	31.87	-0.25	Average	100	145
2	4880.00	44.62	74.00	-29.38	44.87	-0.25	Peak	100	145
3	7320.00	37.34	54.00	-16.66	31.91	5.43	Average	100	208
4	7320.00	50.56	74.00	-23.44	45.13	5.43	Peak	100	208
5	12200.00	42.12	54.00	-11.88	35.58	6.54	Average	100	245
6	12200.00	55.70	74.00	-18.30	49.16	6.54	Peak	100	245

Note 1: Emission Level (dBuV/m) = SA Reading (dBuV) + Factor* (dB/m)
 *Factor includes antenna factor , cable loss and amplifier gain
 Note 2: Margin (dB) = Emission level (dBuV/m) – Limit (dBuV/m).



Unwanted Radiated Emissions into Restricted Frequency Bands Appendix D.7

Modulation	BT-LE (2Mbps)	Test Freq. (MHz)	2440
Polarization	Vertical		

Test By :Sean Yu Temperature(°C):26 Humidity(%):61

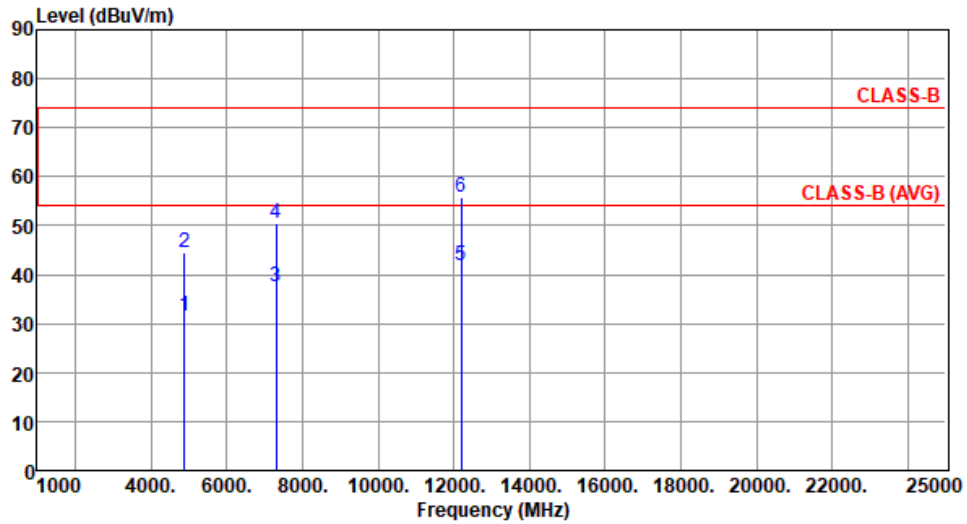

	Freq. MHz	Emission level dBuV/m	Limit dBuV/m	Margin dB	SA reading dBuV	Factor dB/m	Remark	ANT High cm	Turn Table deg
1	4880.00	31.67	54.00	-22.33	31.92	-0.25	Average	100	186
2	4880.00	44.60	74.00	-29.40	44.85	-0.25	Peak	100	186
3	7320.00	37.40	54.00	-16.60	31.97	5.43	Average	100	222
4	7320.00	50.61	74.00	-23.39	45.18	5.43	Peak	100	222
5	12200.00	41.93	54.00	-12.07	35.39	6.54	Average	100	176
6	12200.00	55.89	74.00	-18.11	49.35	6.54	Peak	100	176

Note 1: Emission Level (dBuV/m) = SA Reading (dBuV) + Factor* (dB/m)

*Factor includes antenna factor , cable loss and amplifier gain

Note 2: Margin (dB) = Emission level (dBuV/m) – Limit (dBuV/m).



Unwanted Radiated Emissions into Restricted Frequency Bands Appendix D.7

Modulation	BT-LE (2Mbps)	Test Freq. (MHz)	2478
Polarization	Horizontal		

Test By :Sean Yu Temperature(°C):26 Humidity(%):61

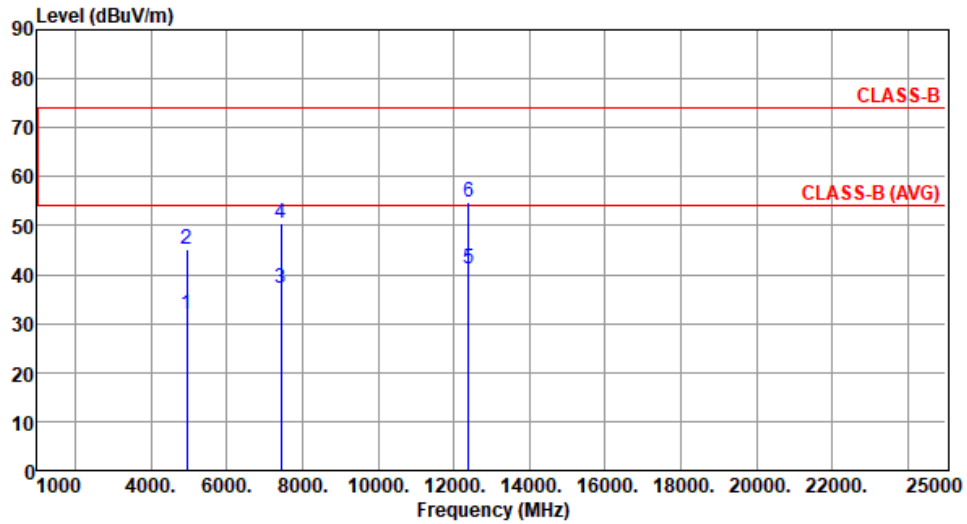

	Freq. MHz	Emission level dBuV/m	Limit dBuV/m	Margin dB	SA reading dBuV	Factor dB/m	Remark	ANT High cm	Turn Table deg
1	4956.00	31.84	54.00	-22.16	31.96	-0.12	Average	100	177
2	4956.00	45.04	74.00	-28.96	45.16	-0.12	Peak	100	177
3	7434.00	37.23	54.00	-16.77	31.86	5.37	Average	100	204
4	7434.00	50.44	74.00	-23.56	45.07	5.37	Peak	100	204
5	12390.00	41.03	54.00	-12.97	34.72	6.31	Average	100	227
6	12390.00	54.70	74.00	-19.30	48.39	6.31	Peak	100	227

Note 1: Emission Level (dBuV/m) = SA Reading (dBuV) + Factor* (dB/m)

*Factor includes antenna factor , cable loss and amplifier gain

Note 2: Margin (dB) = Emission level (dBuV/m) – Limit (dBuV/m).



Unwanted Radiated Emissions into Restricted Frequency Bands Appendix D.7

Modulation	BT-LE (2Mbps)	Test Freq. (MHz)	2478
Polarization	Vertical		

Test By :Sean Yu Temperature(°C):26 Humidity(%):61

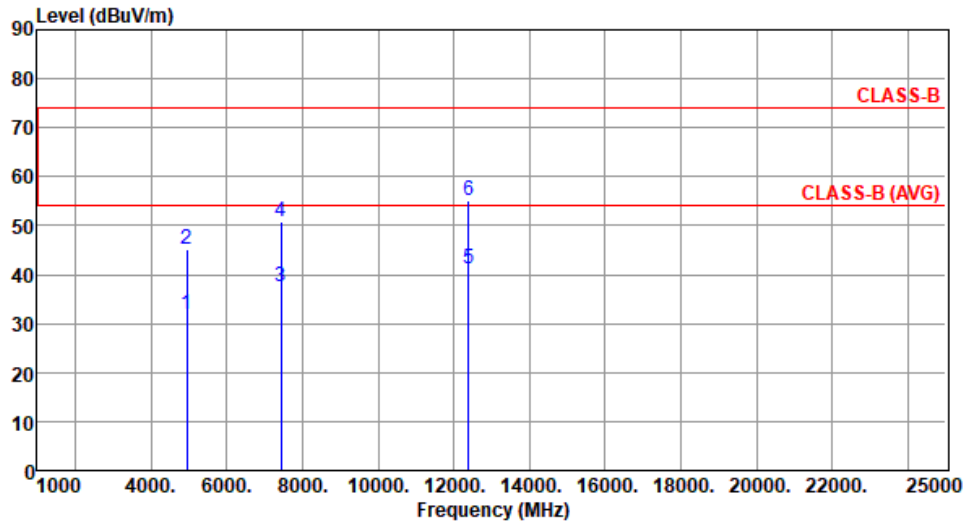

	Freq. MHz	Emission level dBuV/m	Limit dBuV/m	Margin dB	SA reading dBuV	Factor dB/m	Remark	ANT High cm	Turn Table deg
1	4956.00	31.82	54.00	-22.18	31.94	-0.12	Average	100	175
2	4956.00	45.08	74.00	-28.92	45.20	-0.12	Peak	100	175
3	7434.00	37.40	54.00	-16.60	32.03	5.37	Average	100	208
4	7434.00	50.76	74.00	-23.24	45.39	5.37	Peak	100	208
5	12390.00	41.14	54.00	-12.86	34.83	6.31	Average	100	157
6	12390.00	55.00	74.00	-19.00	48.69	6.31	Peak	100	157

Note 1: Emission Level (dBuV/m) = SA Reading (dBuV) + Factor* (dB/m)

*Factor includes antenna factor , cable loss and amplifier gain

Note 2: Margin (dB) = Emission level (dBuV/m) – Limit (dBuV/m).



ST Module

Unwanted Emissions (Below 1GHz)

Modulation	BT-LE (1Mbps)	Test Freq. (MHz)	2402						
Polarization	Horizontal								
Test By : Sean Yu Temperature(°C): 26 Humidity(%): 61									
<p>The graph plots Level (dBuV/m) on the y-axis (0 to 90) against Frequency (MHz) on the x-axis (30 to 1000). A red step function represents the CLASS-B limit, starting at 40 dBuV/m, stepping up to 43.5 dBuV/m at 100 MHz, 46.0 dBuV/m at 200 MHz, and 50 dBuV/m at 900 MHz. Six blue vertical lines indicate measured peaks: 1 (148.34 MHz, 25.04 dBuV/m), 2 (190.05 MHz, 27.41 dBuV/m), 3 (221.09 MHz, 30.15 dBuV/m), 4 (256.01 MHz, 31.33 dBuV/m), 5 (598.42 MHz, 33.07 dBuV/m), and 6 (934.04 MHz, 36.47 dBuV/m).</p>									
	Freq. MHz	Emission level dBuV/m	Limit dBuV/m	Margin dB	SA reading dBuV	Factor dB/m	Remark	ANT High cm	Turn Table deg
1	148.34	25.04	43.50	-18.46	33.91	-8.87	Peak	---	---
2	190.05	27.41	43.50	-16.09	38.74	-11.33	Peak	---	---
3	221.09	30.15	46.00	-15.85	42.04	-11.89	Peak	---	---
4	256.01	31.33	46.00	-14.67	41.10	-9.77	Peak	---	---
5	598.42	33.07	46.00	-12.93	33.79	-0.72	Peak	---	---
6	934.04	36.47	46.00	-9.53	31.42	5.05	Peak	---	---

Note 1: Emission Level (dBuV/m) = SA Reading (dBuV) + Factor* (dB/m)
*Factor includes antenna factor , cable loss and amplifier gain
Note 2: Margin (dB) = Emission level (dBuV/m) – Limit (dBuV/m).
Note 3: All spurious emissions below 30MHz are more than 20 dB below the limit.



Unwanted Radiated Emissions into Restricted Frequency Bands Appendix D.7

Modulation	BT-LE (1Mbps)	Test Freq. (MHz)	2402
------------	---------------	------------------	------

Polarization	Vertical
--------------	----------

Test By : Sean Yu Temperature(°C): 26 Humidity(%): 61

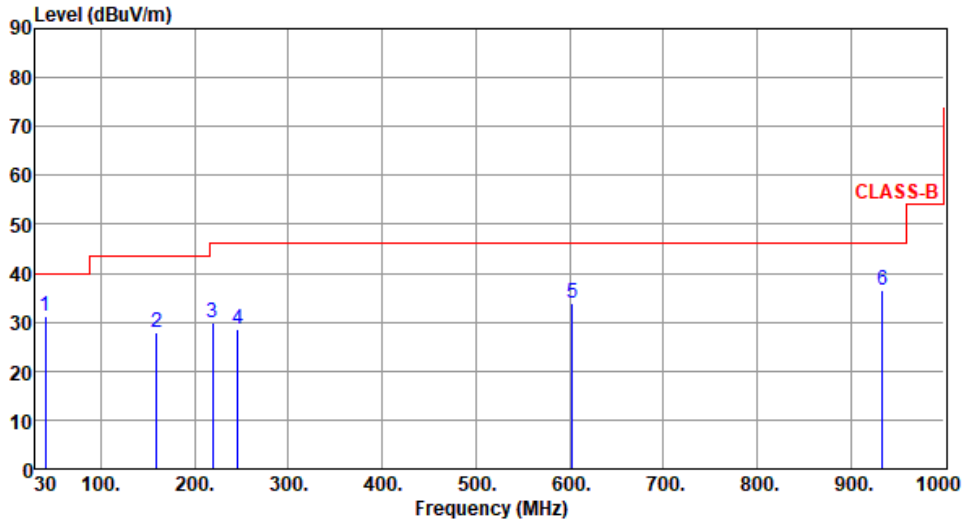

	Freq. MHz	Emission level dBuV/m	Limit dBuV/m	Margin dB	SA reading dBuV	Factor dB/m	Remark	ANT High cm	Turn Table deg
1	40.67	31.14	40.00	-8.86	39.92	-8.78	Peak	---	---
2	159.01	27.96	43.50	-15.54	36.60	-8.64	Peak	---	---
3	219.15	29.90	46.00	-16.10	41.77	-11.87	Peak	---	---
4	246.31	28.43	46.00	-17.57	38.46	-10.03	Peak	---	---
5	603.27	34.04	46.00	-11.96	34.58	-0.54	Peak	---	---
6	934.04	36.57	46.00	-9.43	31.52	5.05	Peak	---	---

Note 1: Emission Level (dBuV/m) = SA Reading (dBuV) + Factor* (dB/m)

*Factor includes antenna factor , cable loss and amplifier gain

Note 2: Margin (dB) = Emission level (dBuV/m) – Limit (dBuV/m).

Note 3: All spurious emissions below 30MHz are more than 20 dB below the limit.



Unwanted Emissions (Above 1GHz)

Modulation	BT-LE (1Mbps)	Test Freq. (MHz)	2440
Polarization	Horizontal		

Test By : Sean Yu Temperature(°C): 26 Humidity(%): 61

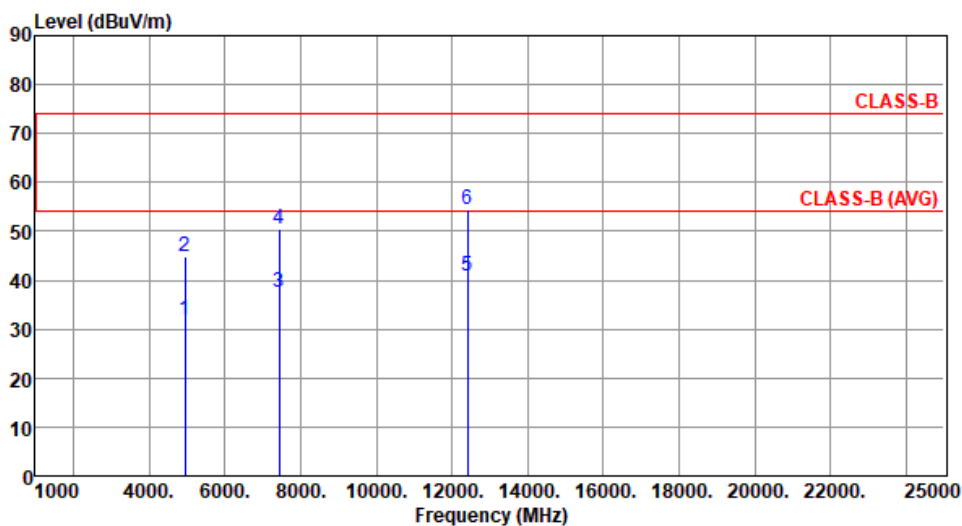

	Freq. MHz	Emission level dBuV/m	Limit dBuV/m	Margin dB	SA reading dBuV	Factor dB/m	Remark	ANT High cm	Turn Table deg
1	4960.00	31.72	54.00	-22.28	31.83	-0.11	Average	100	154
2	4960.00	44.83	74.00	-29.17	44.94	-0.11	Peak	100	154
3	7440.00	37.43	54.00	-16.57	32.06	5.37	Average	100	123
4	7440.00	50.64	74.00	-23.36	45.27	5.37	Peak	100	123
5	12400.00	40.77	54.00	-13.23	34.47	6.30	Average	100	213
6	12400.00	54.43	74.00	-19.57	48.13	6.30	Peak	100	213

Note 1: Emission Level (dBuV/m) = SA Reading (dBuV) + Factor* (dB/m)

*Factor includes antenna factor , cable loss and amplifier gain

Note 2: Margin (dB) = Emission level (dBuV/m) – Limit (dBuV/m).



Unwanted Radiated Emissions into Restricted Frequency Bands Appendix D.7

Modulation	BT-LE (1Mbps)	Test Freq. (MHz)	2440
------------	---------------	------------------	------

Polarization	Vertical
--------------	----------

Test By :Sean Yu Temperature(°C):26 Humidity(%):61

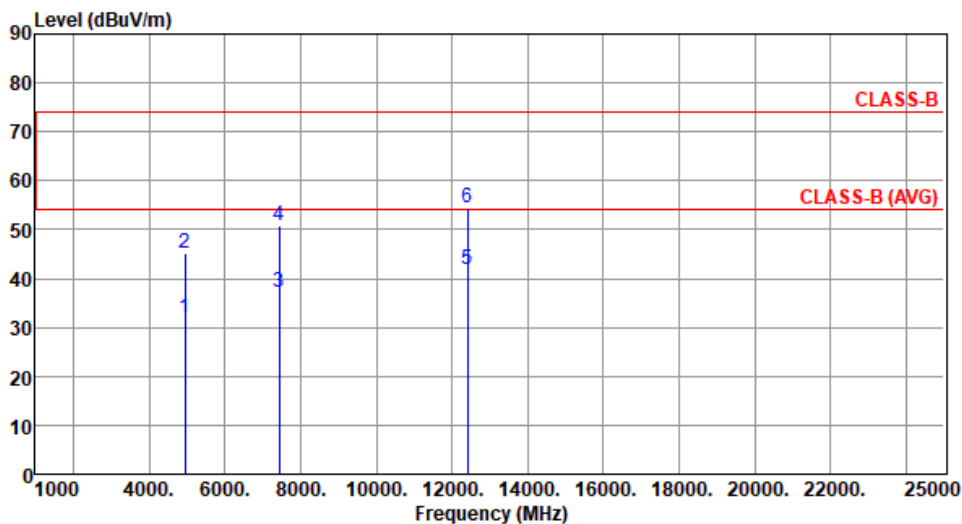

	Freq. MHz	Emission level dBuV/m	Limit dBuV/m	Margin dB	SA reading dBuV	Factor dB/m	Remark	ANT High cm	Turn Table deg
1	4960.00	31.84	54.00	-22.16	31.95	-0.11	Average	100	176
2	4960.00	45.10	74.00	-28.90	45.21	-0.11	Peak	100	176
3	7440.00	37.24	54.00	-16.76	31.87	5.37	Average	100	132
4	7440.00	50.77	74.00	-23.23	45.40	5.37	Peak	100	132
5	12400.00	41.86	54.00	-12.14	35.56	6.30	Average	100	281
6	12400.00	54.51	74.00	-19.49	48.21	6.30	Peak	100	281

Note 1: Emission Level (dBuV/m) = SA Reading (dBuV) + Factor* (dB/m)

*Factor includes antenna factor , cable loss and amplifier gain

Note 2: Margin (dB) = Emission level (dBuV/m) – Limit (dBuV/m).

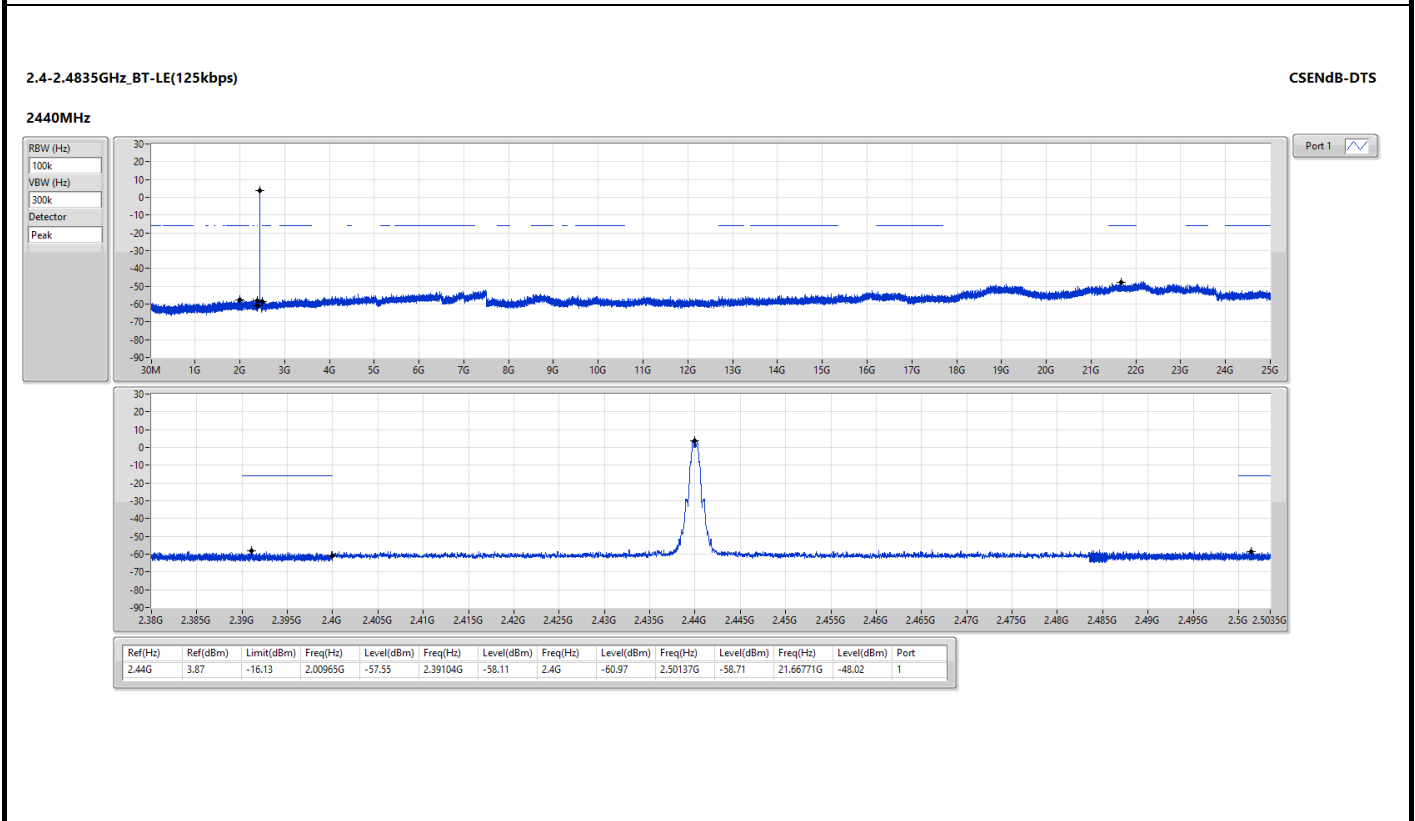
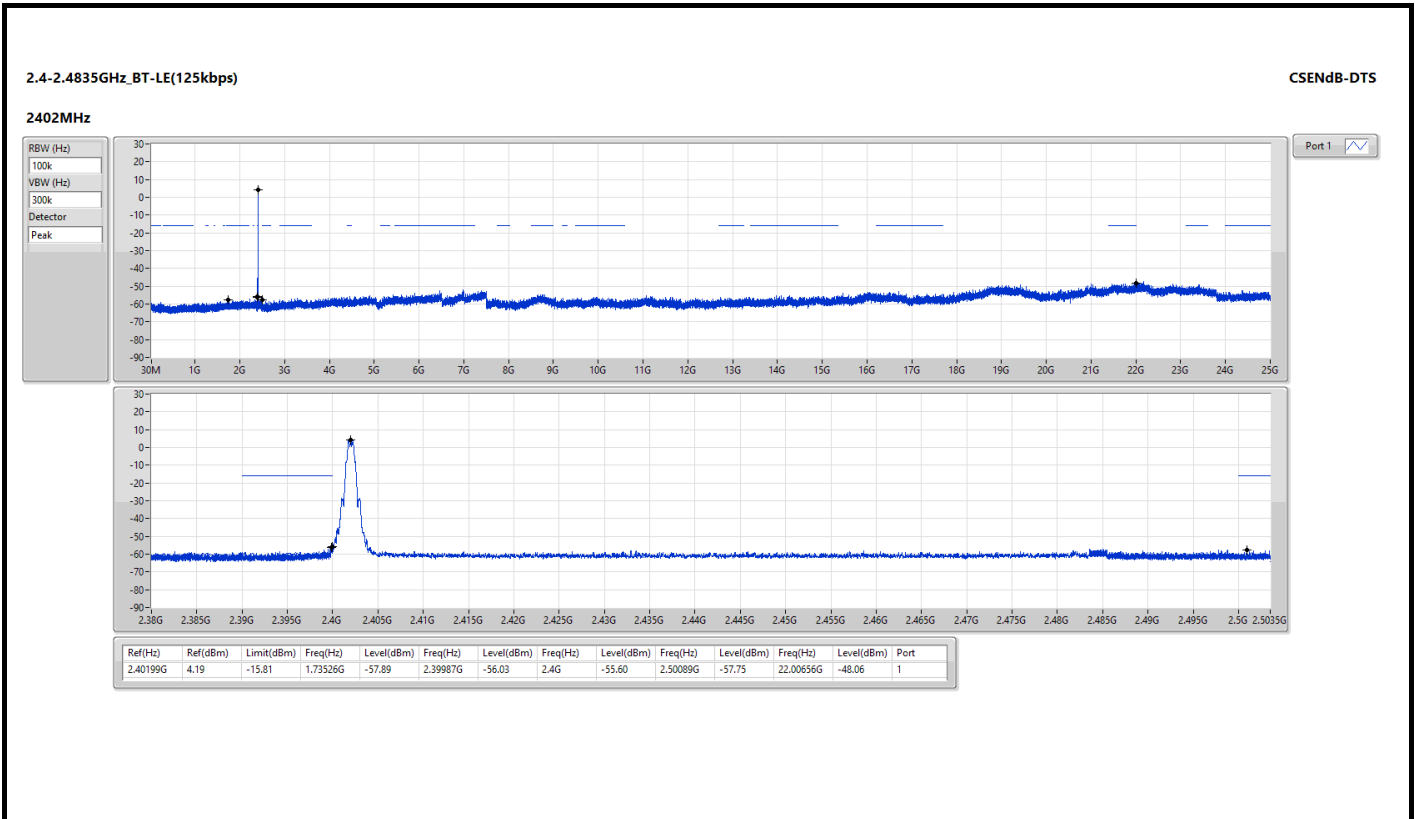

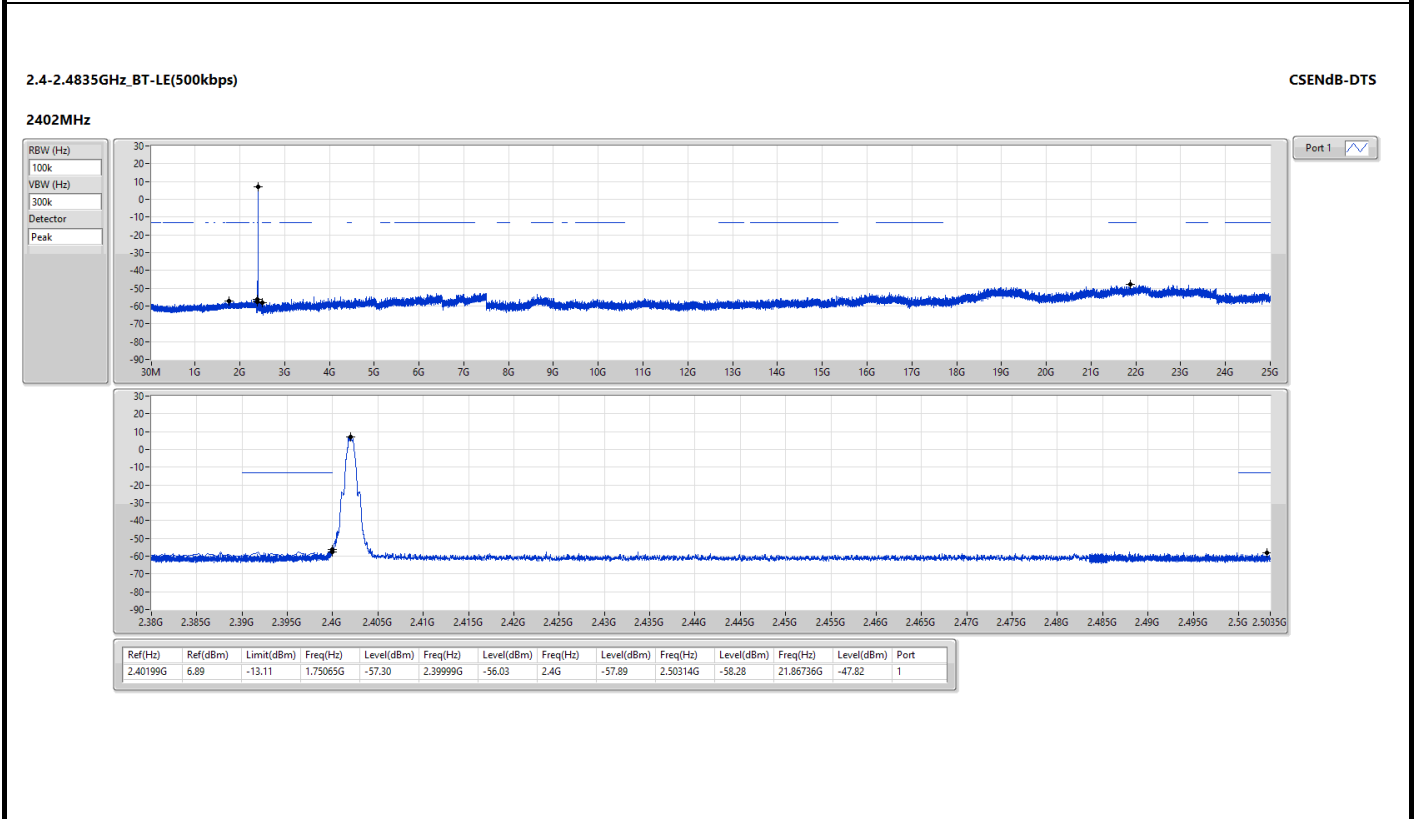
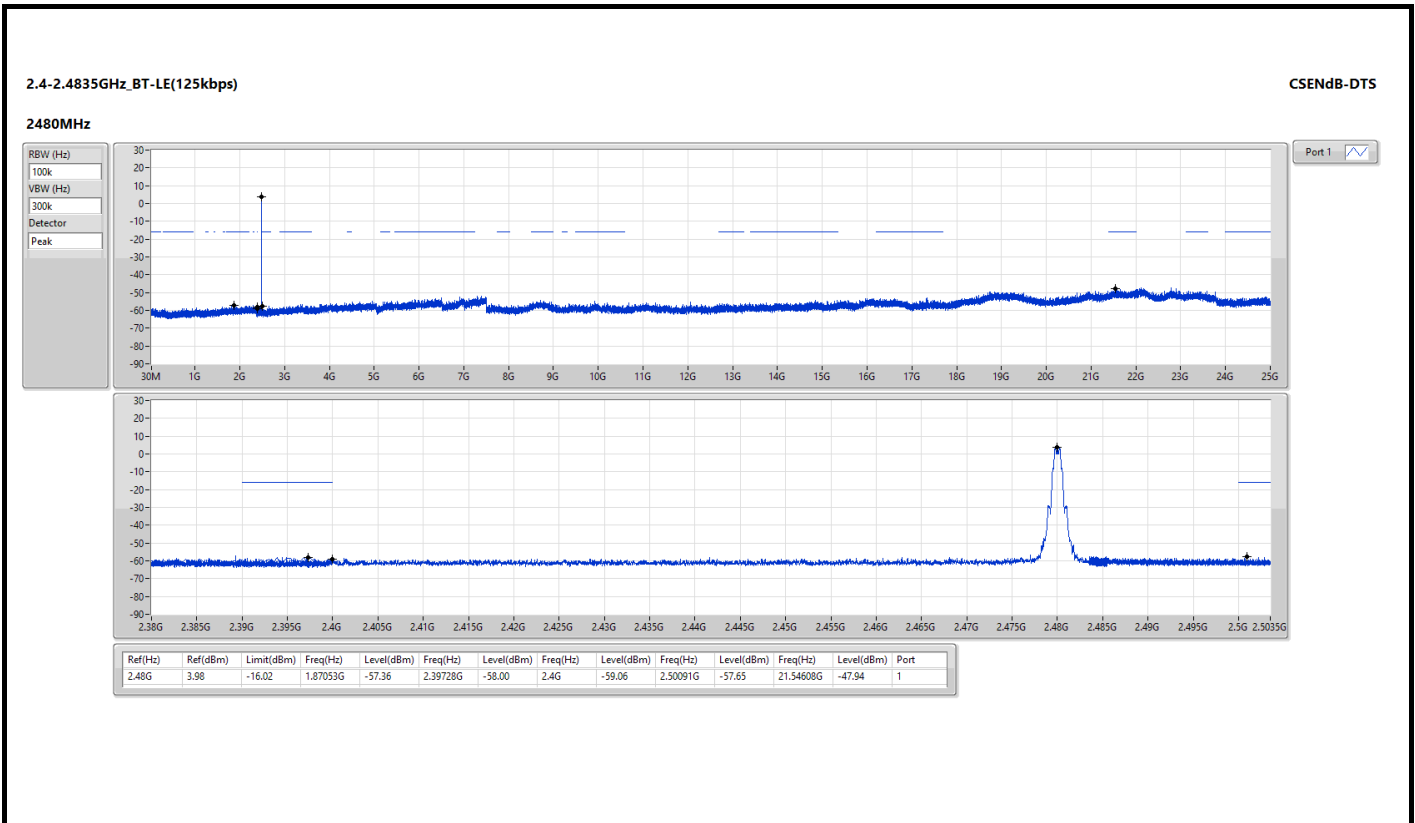

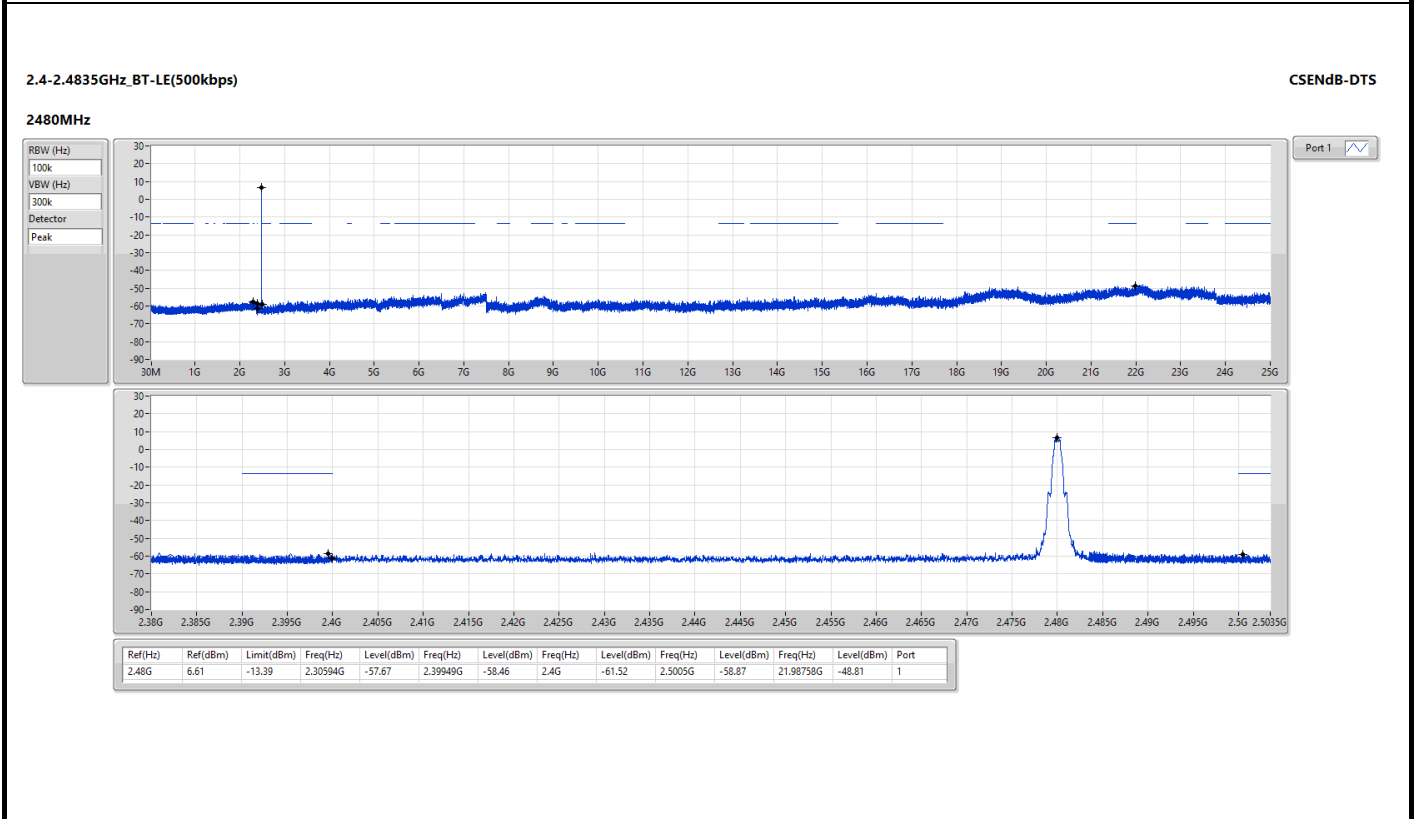
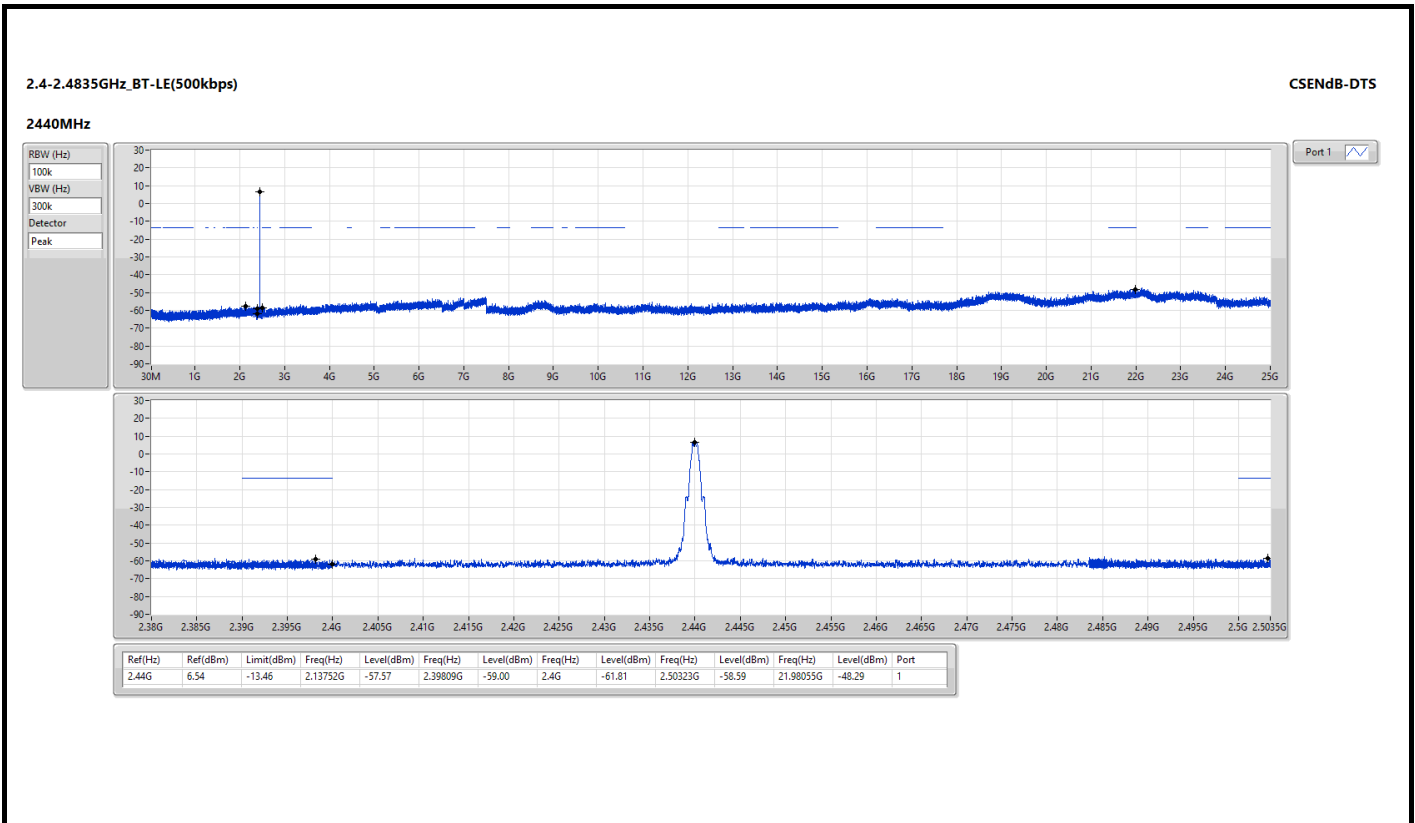

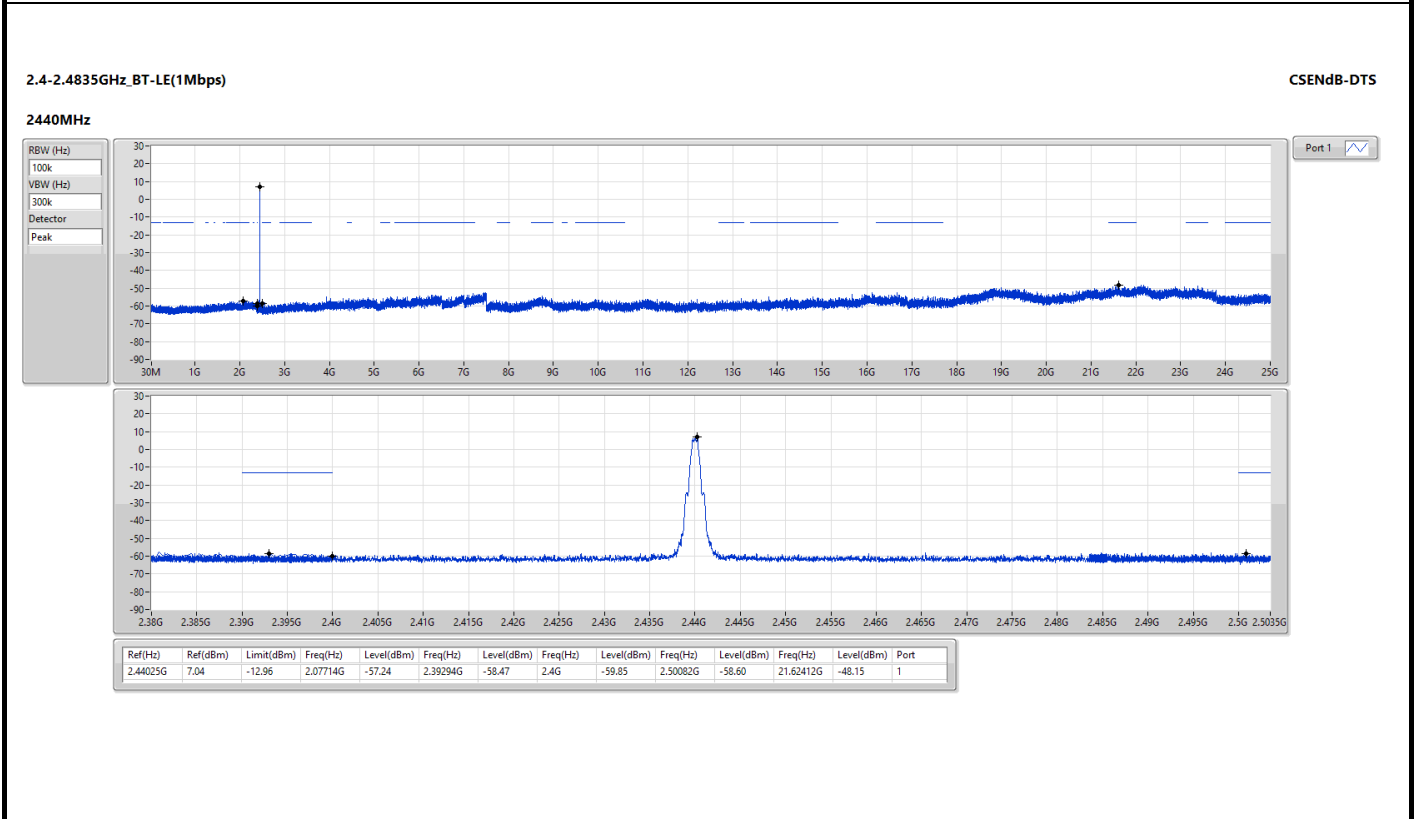
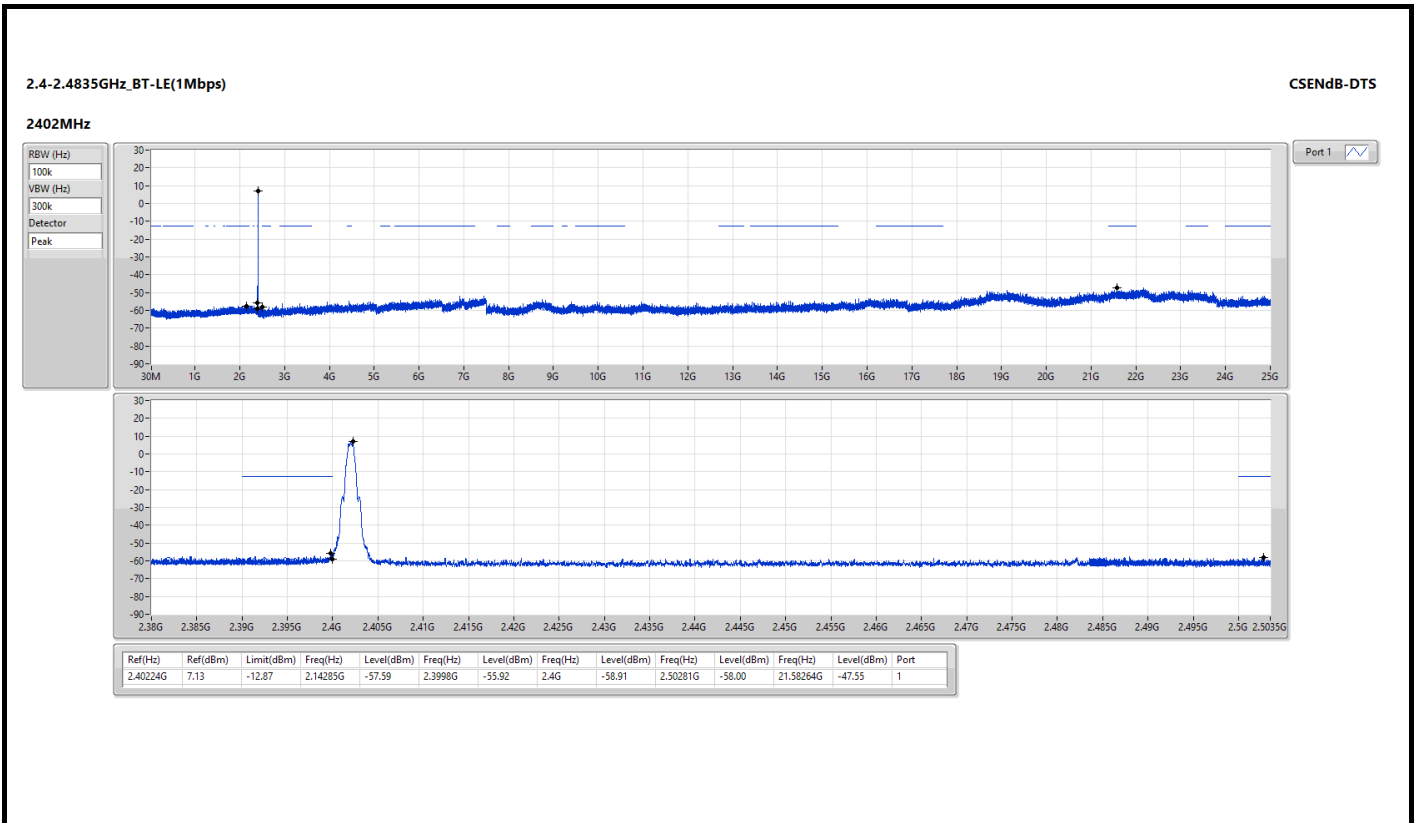

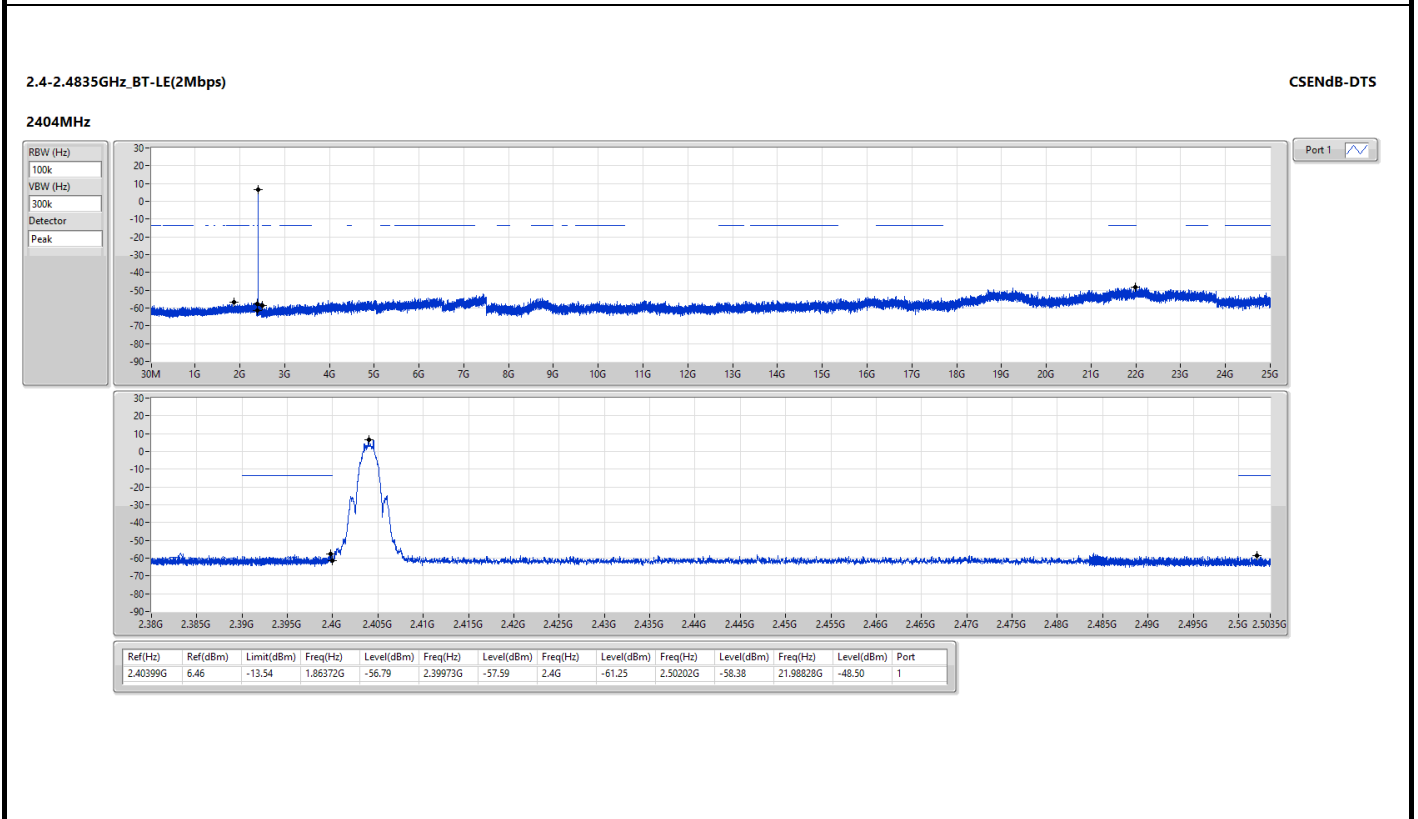
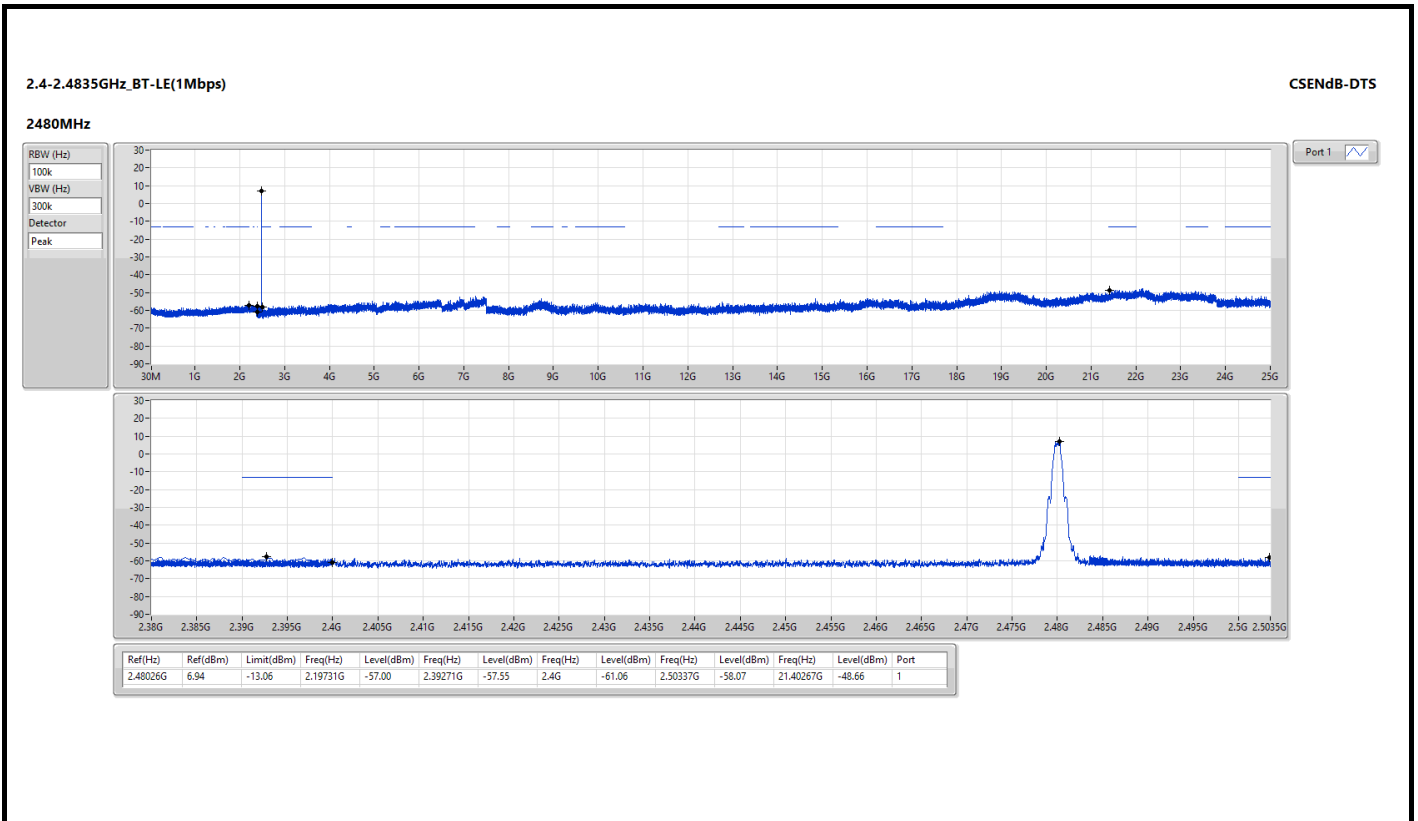

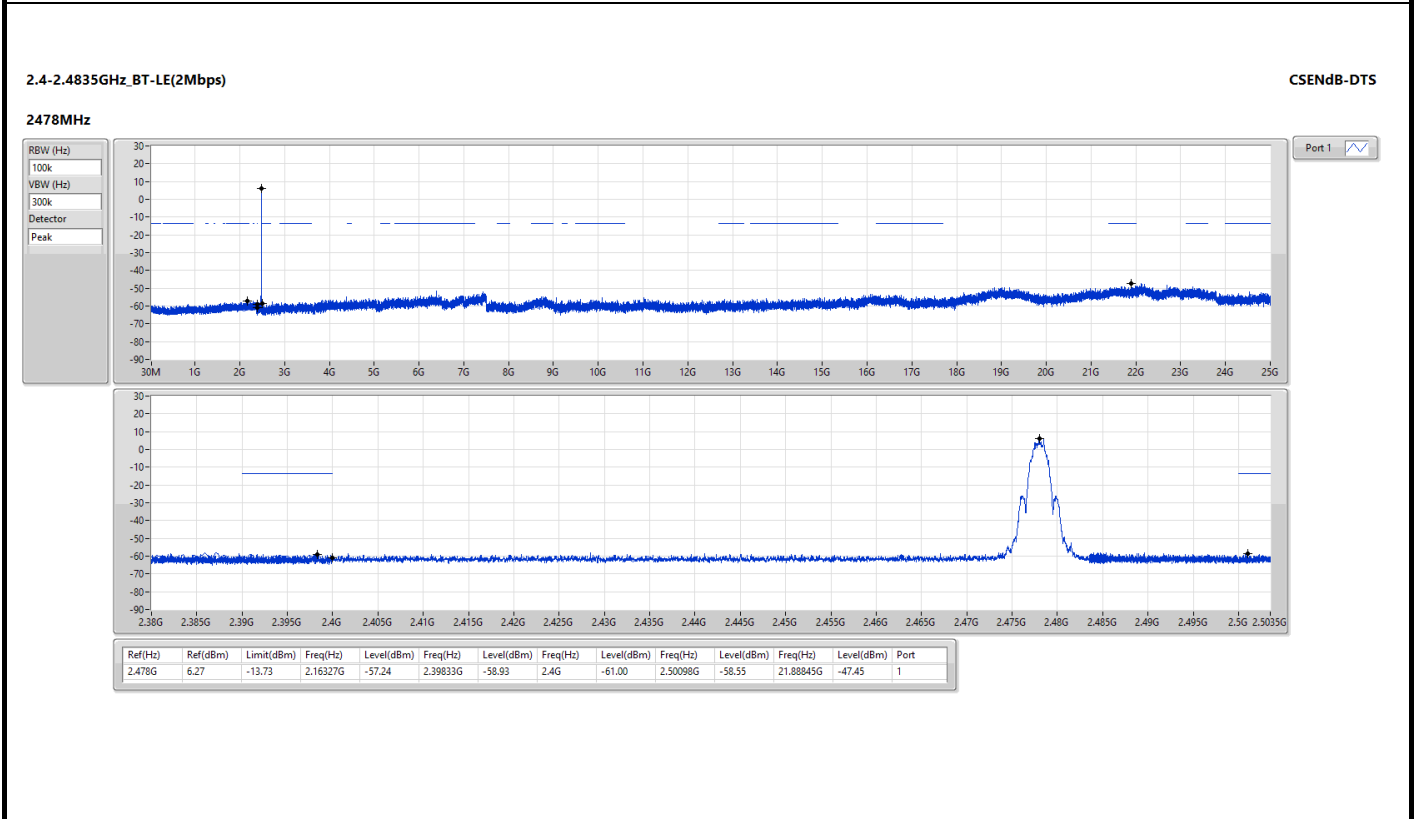
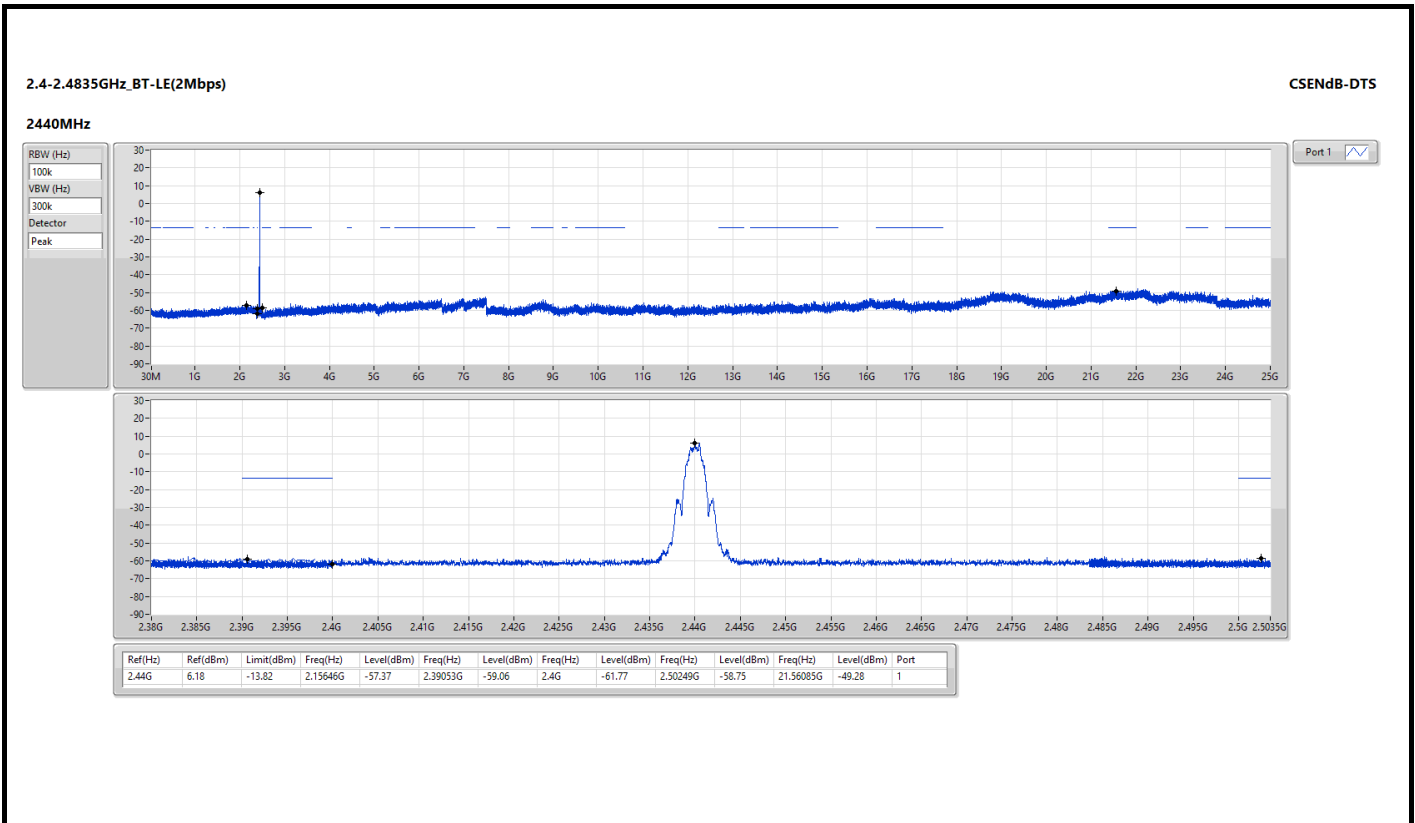



Modulation	BT-LE(1Mbps)	Test Freq. (MHz)	2402
Power Phase	Line		

Test by : Joe Liao Temperature: 22°C Humidity: 68%

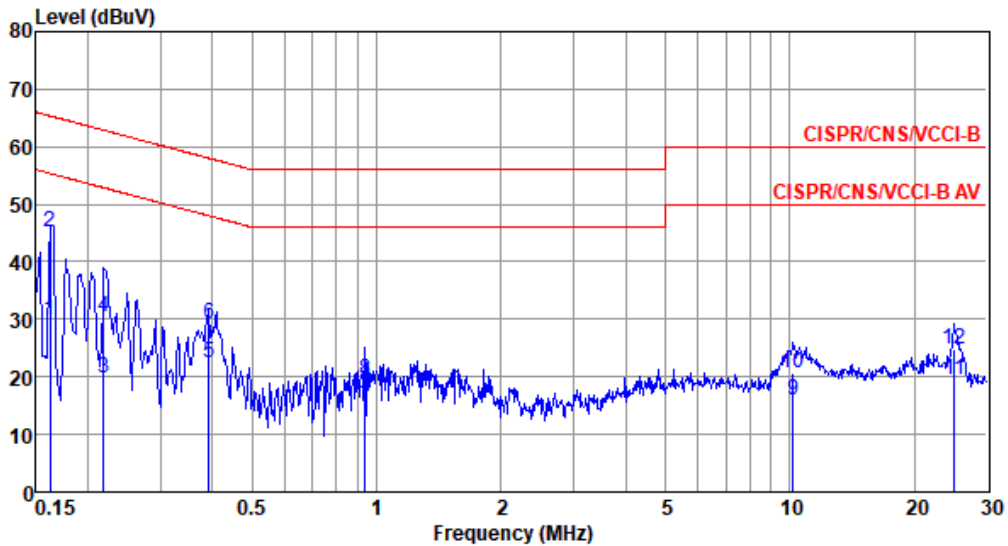

	Freq MHz	Level dBuV	Limit Line dBuV	Over Limit dB	Read Level dBuV	Factor dB	Cable loss dB	Aux dB	Remark
1	0.162	29.89	55.34	-25.45	19.98	9.63	0.07	0.21	Average
2*	0.162	45.07	65.34	-20.27	35.16	9.63	0.07	0.21	QP
3	0.219	19.79	52.88	-33.09	9.85	9.62	0.06	0.26	Average
4	0.219	30.34	62.88	-32.54	20.40	9.62	0.06	0.26	QP
5	0.393	22.56	47.99	-25.43	12.53	9.62	0.08	0.33	Average
6	0.393	29.15	57.99	-28.84	19.12	9.62	0.08	0.33	QP
7	0.938	14.86	46.00	-31.14	4.78	9.63	0.09	0.36	Average
8	0.938	19.59	56.00	-36.41	9.51	9.63	0.09	0.36	QP
9	10.179	16.00	50.00	-34.00	5.51	9.69	0.35	0.45	Average
10	10.179	20.74	60.00	-39.26	10.25	9.69	0.35	0.45	QP
11	25.055	19.61	50.00	-30.39	8.73	9.65	0.54	0.69	Average
12	25.055	24.67	60.00	-35.33	13.79	9.65	0.54	0.69	QP

Note 1: Level (dBuV) = Read Level (dBuV) + LISN Factor (dB) + Cable Loss (dB) + Aux (dB).

2: Over Limit (dB) = Level (dBuV) – Limit Line (dBuV).



Modulation	BT-LE(1Mbps)	Test Freq. (MHz)	2402
Power Phase	Neutral		

Test by : Joe Liao Temperature: 22°C Humidity: 68%

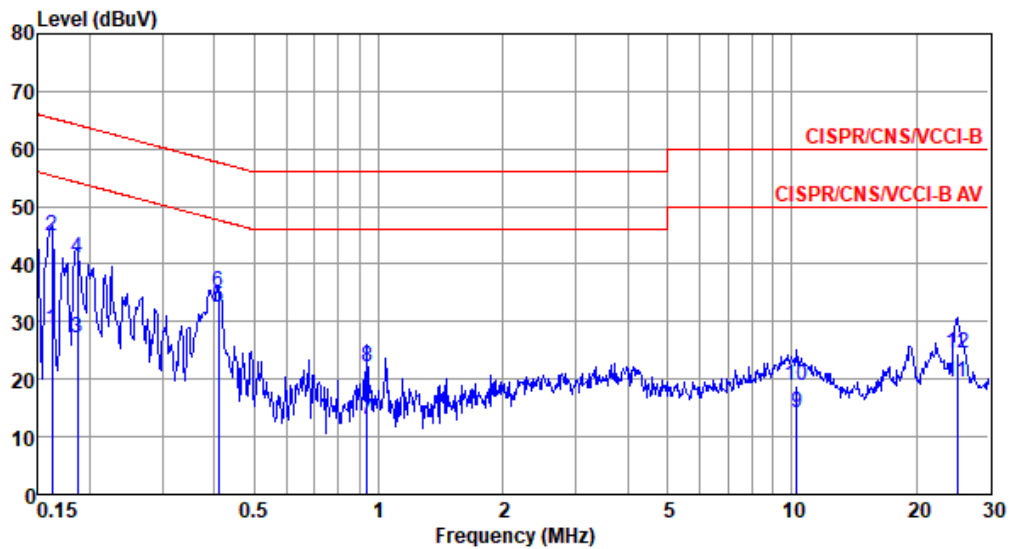

	Freq MHz	Level dBuV	Limit Line dBuV	Over Limit dB	Read Level dBuV	Factor dB	Cable loss dB	Aux dB	Remark
1	0.162	28.77	55.34	-26.57	18.94	9.63	0.07	0.13	Average
2	0.162	44.76	65.34	-20.58	34.93	9.63	0.07	0.13	QP
3	0.186	27.06	54.20	-27.14	17.21	9.63	0.06	0.16	Average
4	0.186	41.03	64.20	-23.17	31.18	9.63	0.06	0.16	QP
5*	0.410	32.35	47.64	-15.29	22.40	9.62	0.08	0.25	Average
6	0.410	35.18	57.64	-22.46	25.23	9.62	0.08	0.25	QP
7	0.938	12.91	46.00	-33.09	2.89	9.63	0.09	0.30	Average
8	0.938	22.28	56.00	-33.72	12.26	9.63	0.09	0.30	QP
9	10.288	14.18	50.00	-35.82	3.69	9.71	0.36	0.42	Average
10	10.288	18.87	60.00	-41.13	8.38	9.71	0.36	0.42	QP
11	25.188	19.38	50.00	-30.62	8.43	9.79	0.54	0.62	Average
12	25.188	24.38	60.00	-35.62	13.43	9.79	0.54	0.62	QP

Note 1: Level (dBuV) = Read Level (dBuV) + LISN Factor (dB) + Cable Loss (dB) + Aux (dB).
 Note 2: Over Limit (dB) = Level (dBuV) - Limit Line (dBuV).