

FCC Test Report

FCC ID : SQG-MT320
Equipment : WiFi 6 + Bluetooth 5.3 Module
Model No. : Sona MT320
Brand Name : Laird Connectivity
Applicant : Laird Connectivity LLC
Address : W66N220 Commerce Court, Cedarburg, WI
53012 United States Of America
Standard : 47 CFR FCC Part 15.247
Received Date : Sep. 25, 2023
Tested Date : Oct. 24 ~ Dec. 08, 2023

We, International Certification Corporation, would like to declare that the tested sample has been evaluated and in compliance with the requirement of the above standards. The test results contained in this report refer exclusively to the product. It shall not be reproduced except in full without the written approval of our laboratory.

Reviewed by:

Approved by:



Along Chen / Assistant Manager



Gary Chang / Manager

Table of Contents

1	GENERAL DESCRIPTION	5
1.1	Information.....	5
1.2	Local Support Equipment List	8
1.3	Test Setup Chart	9
1.4	The Equipment List	11
1.5	Test Standards	12
1.6	Reference Guidance	12
1.7	Deviation from Test Standard and Measurement Procedure.....	12
1.8	Measurement Uncertainty	12
2	TEST CONFIGURATION	13
2.1	Testing Facility.....	13
2.2	The Worst Test Modes and Channel Details	14
3	TRANSMITTER TEST RESULTS.....	15
3.1	Unwanted Emissions into Restricted Frequency Bands	15
3.2	Unwanted Emissions into Non-Restricted Frequency Bands	18
3.3	Conducted Output Power	19
3.4	Number of Hopping Frequency	20
3.5	20dB and Occupied Bandwidth.....	21
3.6	Channel Separation.....	22
3.7	Number of Dwell Time.....	23
3.8	AC Power Line Conducted Emissions	24
4	TEST LABORATORY INFORMATION	25

Appendix A. Unwanted Emissions into Restricted Frequency Bands

Appendix B. Unwanted Emissions into Non-Restricted Frequency Bands

Appendix C. Conducted Output Power

Appendix D. Number of Hopping Frequency

Appendix E. 20dB and Occupied Bandwidth

Appendix F. Channel Separation

Appendix G. Number of Dwell Time

Appendix H. AC Power Line Conducted Emissions

Release Record

Report No.	Version	Description	Issued Date
FR392501AD	Rev. 01	Initial issue	Jan. 23, 2024

Summary of Test Results

FCC Rules	Test Items	Measured	Result
15.207	AC Power Line Conducted Emission	[dBuV]: 0.408MHz 32.70 (Margin -14.98dB) - AV	Pass
15.247(d) 15.209	Unwanted Emissions	[dBuV/m at 3m]: 44.93MHz 30.65 (Margin -9.35dB) - PK	Pass
15.247(d)	Band Edge	Meet the requirement of limit	Pass
15.247(b)(1)	Conducted Output Power	Power [dBm]: 9.63	Pass
15.247(a)(1)(iii)	Number of Hopping Channels	Meet the requirement of limit	Pass
15.247(a)(1)	Hopping Channel Separation	Meet the requirement of limit	Pass
15.247(a)(1)(iii)	Dwell Time	Meet the requirement of limit	Pass
15.203	Antenna Requirement	Meet the requirement of limit	Pass

Declaration of Conformity:

The test results with all measurement uncertainty excluded are presented in accordance with the regulation limits or requirements declared by manufacturers.

Comments and Explanations:

The declared of product specification for EUT presented in the report are provided by the manufacturer, and the manufacturer takes all the responsibilities for the accuracy of product specification.

1 General Description

1.1 Information

1.1.1 Product Details

The two configurations of the EUT are shown on the following:

Brand Name	Model Name	Description
Laird Connectivity	Sona MT320	MT320-SC (MHF4 connector on module)
		MT320-ST (RF trace variant)

1.1.2 Specification of the Equipment under Test (EUT)

RF General Information				
Frequency Range (MHz)	Bluetooth Mode	Ch. Frequency (MHz)	Channel Number	Data Rate
2400-2483.5	BR	2402-2480	0-78 [79]	1 Mbps
2400-2483.5	EDR	2402-2480	0-78 [79]	2 Mbps
2400-2483.5	EDR	2402-2480	0-78 [79]	3 Mbps

Note 1: RF output power specifies that Maximum Peak Conducted Output Power.
 Note 2: Bluetooth BR uses a GFSK.
 Note 3: Bluetooth EDR uses a combination of $\pi/4$ -DQPSK and 8DPSK.

1.1.3 Antenna Details

Ant. No.	Manufacturer	Model	Part Number	Type	Connector	Gain (dBi)
1	Laird Connectivity	FlexMIMO 6E	EFD2471A3S-10 MH4L	PIFA	MHF4L	2.2
2	Laird Connectivity	FlexPIFA 6E	EFB2471A3S-10 MH4L	PIFA	MHF4L	2.2
3	Laird Connectivity	Mini NanoBlade Flex 6 GHz	EMF2471A3S-10 MH4L	PCB Dipole	MHF4L	2.4
4	Joymax Electronics	Dipole 6E	TWX-100BRS3B	Dipole	RP-SMA	2

1.1.4 Power Supply Type of Equipment under Test (EUT)

Power Supply Type	3.3Vdc from host
-------------------	------------------

1.1.5 Accessories

N/A

1.1.6 Channel List

Frequency band (MHz)				2400~2483.5			
Channel	Frequency (MHz)	Channel	Frequency (MHz)	Channel	Frequency (MHz)	Channel	Frequency (MHz)
0	2402	20	2422	40	2442	60	2462
1	2403	21	2423	41	2443	61	2463
2	2404	22	2424	42	2444	62	2464
3	2405	23	2425	43	2445	63	2465
4	2406	24	2426	44	2446	64	2466
5	2407	25	2427	45	2447	65	2467
6	2408	26	2428	46	2448	66	2468
7	2409	27	2429	47	2449	67	2469
8	2410	28	2430	48	2450	68	2470
9	2411	29	2431	49	2451	69	2471
10	2412	30	2432	50	2452	70	2472
11	2413	31	2433	51	2453	71	2473
12	2414	32	2434	52	2454	72	2474
13	2415	33	2435	53	2455	73	2475
14	2416	34	2436	54	2456	74	2476
15	2417	35	2437	55	2457	75	2477
16	2418	36	2438	56	2458	76	2478
17	2419	37	2439	57	2459	77	2479
18	2420	38	2440	58	2460	78	2480
19	2421	39	2441	59	2461	---	---

1.1.7 Test Tool and Duty Cycle

Test Tool	WCN Combo tool, version: W2316 Bluetooth Simulator, Brand: R&S, Model: CMW270	
Modulation Mode	Duty Cycle Of Test Signal (%)	Duty Factor (dB)
DH5	77.73%	1.09
2DH5	77.73%	1.09
3DH5	77.63%	1.10

1.1.8 Power Index of Test Tool

Modulation Mode	Test Frequency (MHz)		
	2402	2441	2480
GFSK/1Mbps	7	7	7
$\pi/4$ -DQPSK /2Mbps	7	7	7
8DPSK/3Mbps	7	7	7

1.2 Local Support Equipment List

Support Equipment List					
No.	Equipment	Brand	Model	FCC ID	Remarks
1	Laptop	DELL	Latitude 5400	DoC	---
2	Fixture	---	---	---	Provided by applicant.
3	Fixture's adapter	---	---	---	Provided by applicant. I/P: 100-240Vac,1.5A,50-60Hz O/P: 5.0V 3.0A
4	Carrier board	---	---	---	Provided by applicant.
5	50Ω terminator	---	---	---	---

Note: The support laptop was disconnected from EUT and was removed from testing table after sending command to EUT to transmit continuously.

1.3 Test Setup Chart

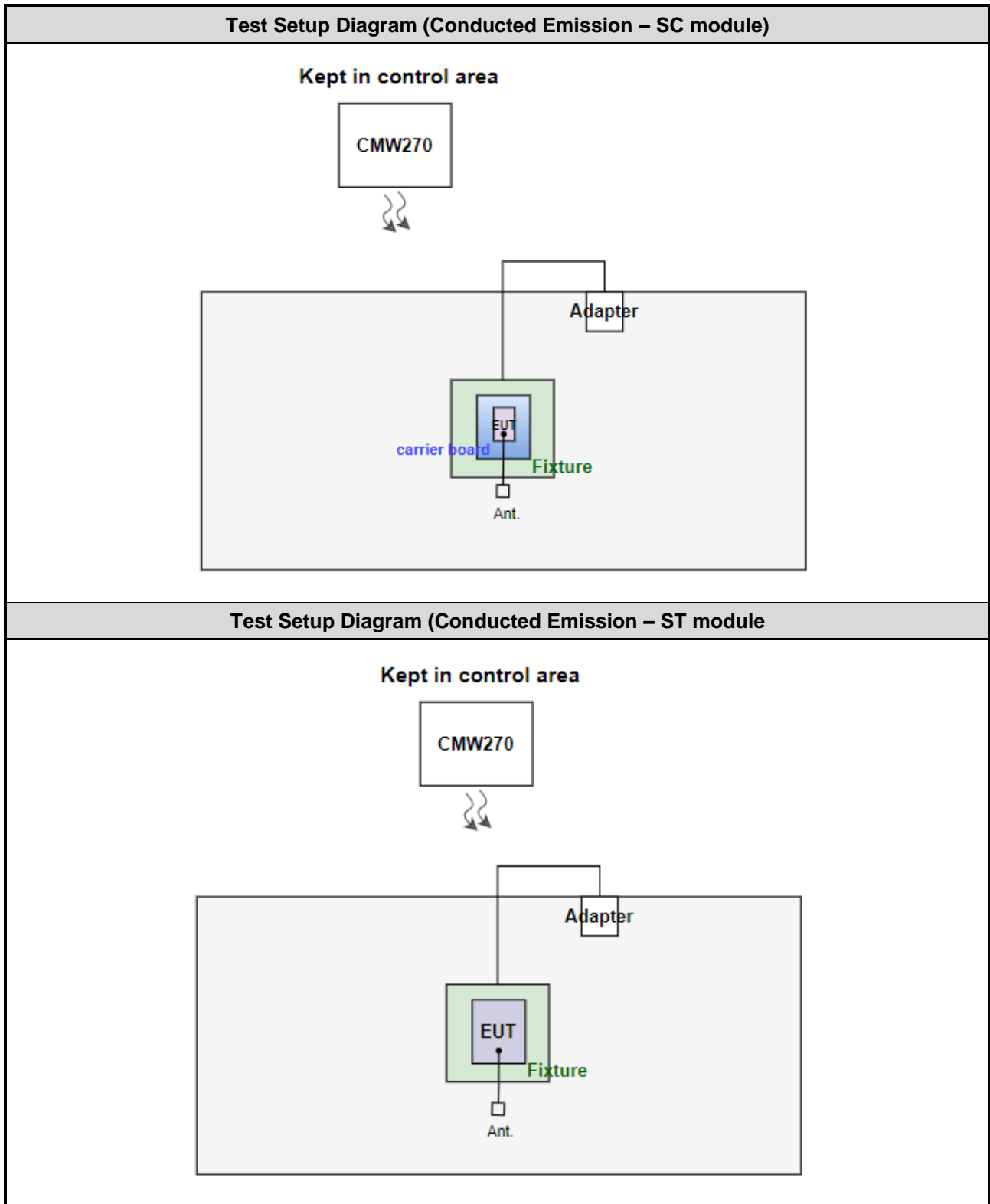

Test Setup Diagram (Radiated Emission – SC module)

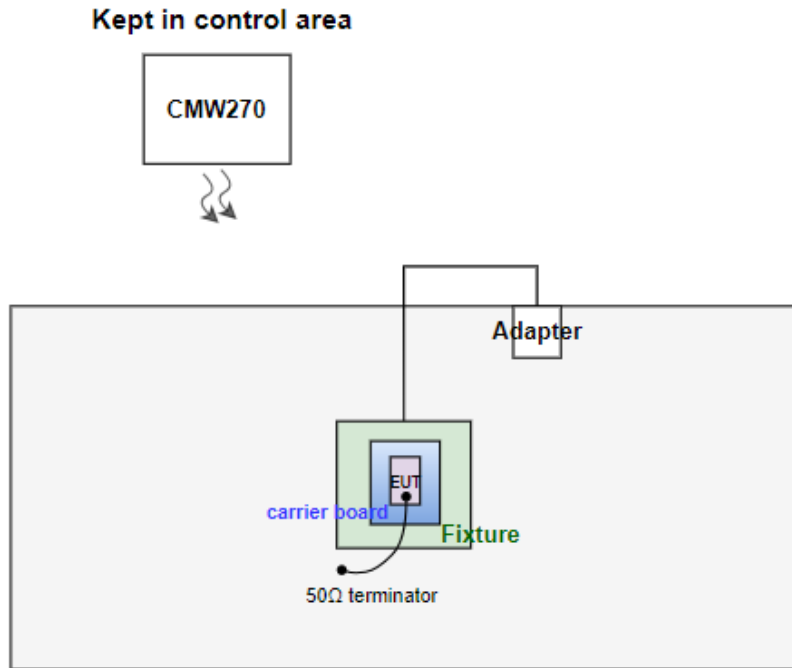

Test Setup Diagram (Radiated Emission – ST module)

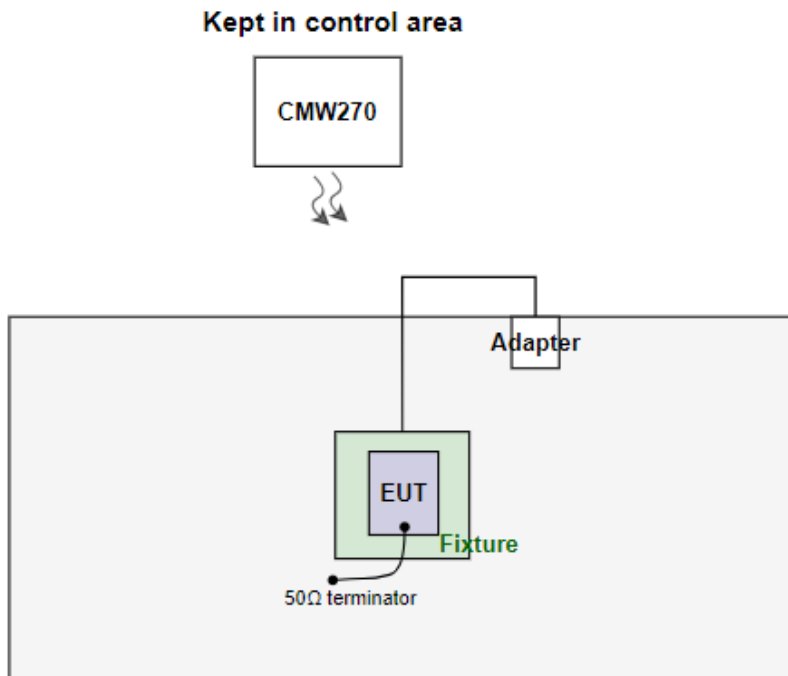

1.4 The Equipment List

Test Item	Conducted Emission				
Test Site	Conduction room 1 / (CO01-WS)				
Tested Date	Dec. 08, 2023				
Instrument	Brand	Model No.	Serial No.	Calibration Date	Calibration Until
Receiver	R&S	ESR3	101658	Feb. 17, 2023	Feb. 16, 2024
LISN	R&S	ENV216	101579	May. 09, 2023	May. 08, 2024
LISN (Support Unit)	SCHWARZBECK	Schwarzbeck 8127	8127667	Jan. 03, 2023	Jan. 02, 2024
RF Cable-CON	Woken	CFD200-NL	CFD200-NL-001	Oct. 11, 2023	Oct. 10, 2024
50 ohm terminal (Support Unit)	NA	50	01	Jun. 14, 2023	Jun. 13, 2024
Measurement Software	AUDIX	e3	6.120210k	NA	NA
Note: Calibration Interval of instruments listed above is one year.					

Test Item	Radiated Emission				
Test Site	966 chamber1 / (03CH01-WS)				
Tested Date	Oct. 24, 2023				
Instrument	Brand	Model No.	Serial No.	Calibration Date	Calibration Until
Wireless connectivity tester	R&S	CMW270	100856	Nov. 16, 2022	Nov. 15, 2023
Receiver	R&S	ESR3	101657	Mar. 03, 2023	Mar. 02, 2024
Spectrum Analyzer	R&S	FSV40	101498	Nov. 21, 2022	Nov. 20, 2023
Loop Antenna	R&S	HFH2-Z2	100330	Nov. 01, 2022	Oct. 31, 2023
Bilog Antenna	SCHWARZBECK	VULB9168	VULB9168-522	Jul. 31, 2023	Jul. 30, 2024
Horn Antenna 1G-18G	SCHWARZBECK	BBHA 9120 D	BBHA 9120 D 1096	Nov. 25, 2022	Nov. 24, 2023
Horn Antenna 18G-40G	SCHWARZBECK	BBHA 9170	BBHA 9170517	Oct. 27, 2022	Oct. 26, 2023
Preamplifier	EMC	EMC02325	980225	Jun. 28, 2023	Jun. 27, 2024
Preamplifier	EMC	EMC118A45SE	980898	Jul. 14, 2023	Jul. 13, 2024
Preamplifier	EMC	EMC184045SE	980903	Jul. 17, 2023	Jul. 16, 2024
Loop Antenna Cable	KOAX KABEL	101354-BW	101354-BW	Oct. 03, 2023	Oct. 02, 2024
LF cable 3M	Woken	CFD400NL-LW	CFD400NL-001	Oct. 03, 2023	Oct. 02, 2024
LF cable 11M	EMC	EMCCFD400-NW-NW-1 1000	200801	Oct. 03, 2023	Oct. 02, 2024
LF cable 1M	EMC	EMCCFD400-NM-NM-1 000	160502	Oct. 03, 2023	Oct. 02, 2024
RF Cable	EMC	EMC104-35M-35M-8000	210920	Oct. 03, 2023	Oct. 02, 2024
RF Cable	EMC	EMC104-35M-35M-3000	210922	Oct. 03, 2023	Oct. 02, 2024
Measurement Software	AUDIX	e3	6.120210g	NA	NA
Note: Calibration Interval of instruments listed above is one year.					

Test Item	RF Conducted				
Test Site	(TH01-WS)				
Tested Date	Nov. 06 ~ Nov. 10, 2023				
Instrument	Brand	Model No.	Serial No.	Calibration Date	Calibration Until
Wireless connectivity tester	R&S	CMW270	100856	Nov. 16, 2022	Nov. 15, 2023
Spectrum Analyzer	R&S	FSV40	101910	Apr. 14, 2023	Apr. 13, 2024
Power Meter	Anritsu	ML2495A	1241001	Jan. 11, 2023	Jan. 10, 2024
Power Sensor	Anritsu	MA2411B	1911228	Jan. 11, 2023	Jan. 10, 2024
Attenuator	Pasternack	PE7005-10	10-2	Oct. 05, 2023	Oct. 04, 2024
HIGHPASS FILTER 3.1-18G	WHK	WHK3.1/18G-10SS	39	Oct. 05, 2023	Oct. 04, 2024
LOWPASS FILTER	WI	WLKS1100-12SS	2	Oct. 05, 2023	Oct. 04, 2024
Measurement Software	Sporton	SENSE-15247_FS	V5.10.8	NA	NA
Note: Calibration Interval of instruments listed above is one year.					

1.5 Test Standards

47 CFR FCC Part 15.247
ANSI C63.10-2013

1.6 Reference Guidance

FCC KDB 558074 D01 15.247 Meas Guidance v05r02

1.7 Deviation from Test Standard and Measurement Procedure

None

1.8 Measurement Uncertainty

The measurement uncertainties given below are based on a 95% confidence level (based on a coverage factor ($k=2$)).

Measurement Uncertainty	
Parameters	Uncertainty
Bandwidth	± 34.130 Hz
Conducted power	± 0.808 dB
Power density	± 0.583 dB
Conducted emission	± 2.715 dB
AC conducted emission	± 2.92 dB
Unwanted Emission ≤ 1 GHz	± 3.41 dB
Unwanted Emission > 1 GHz	± 4.59 dB
Time	$\pm 0.1\%$

2 Test Configuration

2.1 Testing Facility

Test Laboratory	International Certification Corporation
Test Site	CO01-WS, 03CH01-WS, TH01-WS
Address of Test Site	No.3-1, Lane 6, Wen San 3rd St., Kwei Shan Dist., Tao Yuan City 33381, Taiwan (R.O.C.)

- FCC Designation No.: TW2732
- FCC site registration No.: 181692
- ISED#: 10807A
- CAB identifier: TW2732

2.2 The Worst Test Modes and Channel Details

Test item	Modulation Mode	Test Frequency (MHz)	Test method	Mode	Test Configuration	Note
Conducted Emissions	8DPSK(3Mbps)	2402	Conducted	TX	1	-
Radiated Emissions \leq 1GHz	8DPSK(3Mbps)	2402	Radiated	TX	1, 2	Note 2
Radiated Emissions $>$ 1GHz	GFSK(1Mbps) 8DPSK(3Mbps)	2402, 2441, 2480 2402, 2441, 2480	Radiated	TX	1	Note 2
	8DPSK(3Mbps)	2480	Radiated	TX	2	Note 2
Radiated Emissions \leq 1GHz	8DPSK(3Mbps)	2402	Conducted	TX	1	-
					2	-
Radiated Emissions $>$ 1GHz	GFSK(1Mbps) 8DPSK(3Mbps)	2402, 2441, 2480 2402, 2441, 2480	Conducted	TX	1	-
	8DPSK(3Mbps)	2480	Conducted	TX	2	-
Number of Hopping Channels	GFSK(1Mbps) $\pi/4$ DQPSK(2Mbps) 8DPSK(3Mbps)	2402~2480 2402~2480 2402~2480	Conducted	TX	1	-
Conducted Output Power	GFSK(1Mbps) $\pi/4$ DQPSK(2Mbps) 8DPSK(3Mbps)	2402, 2441, 2480 2402, 2441, 2480 2402, 2441, 2480	Conducted	TX	1, 2	-
Hopping Channel Separation 20dB and Occupied bandwidth	GFSK(1Mbps) $\pi/4$ DQPSK(2Mbps) 8DPSK(3Mbps)	2402, 2441, 2480 2402, 2441, 2480 2402, 2441, 2480	Conducted	TX	1	-
Dwell Time	GFSK(1Mbps) $\pi/4$ DQPSK(2Mbps) 8DPSK(3Mbps)	2402 2402 2402	Conducted	TX	1	-

NOTE:

- The EUT was pretested with 3 orientations placed on the table for the radiated emission measurement – X, Y, and Z-plane. The **Y-plane** result was found as the worst case and was shown in this report.
- The 50 Ω terminator is connected to antenna port of EUT for radiated emission measurement.
- Test configurations are listed as below:
Configuration 1: SC Module
Configuration 2: ST Module

3 Transmitter Test Results

3.1 Unwanted Emissions into Restricted Frequency Bands

3.1.1 Limit of Unwanted Emissions into Restricted Frequency Bands

Restricted Band Emissions Limit			
Frequency Range (MHz)	Field Strength (uV/m)	Field Strength (dBuV/m)	Measure Distance (m)
0.009~0.490	2400/F(kHz)	48.5 - 13.8	300
0.490~1.705	24000/F(kHz)	33.8 - 23	30
1.705~30.0	30	29	30
30~88	100	40	3
88~216	150	43.5	3
216~960	200	46	3
Above 960	500	54	3

Note 1:
Qusai-Peak value is measured for frequency below 1GHz except for 9–90 kHz, 110–490 kHz frequency band. Peak and average value are measured for frequency above 1GHz. The limit on average radio frequency emission is as above table. The limit on peak radio frequency emissions is 20 dB above the maximum permitted average emission limit

Note 2:
Measurements may be performed at a distance other than what is specified provided. When performing measurements at a distance other than that specified, the results shall be extrapolated to the specified distance using an extrapolation factor as below, Frequency at or above 30 MHz: 20 dB/decade Frequency below 30 MHz: 40 dB/decade.

3.1.2 Test Procedures

1. Measurement is made at a semi-anechoic chamber that incorporates a turntable allowing a EUT rotation of 360°. A continuously-rotating, remotely-controlled turntable is installed at the test site to support the EUT and facilitate determination of the direction of maximum radiation for each EUT emission frequency. The EUT is placed at test table. For emissions testing at or below 1 GHz, the table height is 80 cm above the reference ground plane. For emission measurements above 1 GHz, the table height is 1.5 m
2. Measurement is made with the antenna positioned in both the horizontal and vertical planes of polarization. The measurement antenna is varied in height (1m ~ 4m) above the reference ground plane to obtain the maximum signal strength. Distance between EUT and antenna is 3 m.
3. This investigation is performed with the EUT rotated 360°, the antenna height scanned between 1 m and 4 m, and the antenna rotated to repeat the measurements for both the horizontal and vertical antenna polarizations.

Note:

1. 120kHz measurement bandwidth of test receiver and Quasi-peak detector is for radiated emission below 1GHz.

2. Radiated emission above 1GHz / Peak value
RBW=1MHz, VBW=3MHz and Peak detector

Radiated emission above 1GHz / Average value for harmonics

The average value is: Average = Peak value + 20log(Duty cycle) Where the duty factor is calculated from following formula for DH5 packet type which has worst duty factor:

3.
$$20\log(\text{Duty cycle}) = 20\log \frac{1\text{s} / 1600 * 5}{100\text{ ms}} = -30.1\text{dB}$$

4. Radiated emission above 1GHz / Average value for other emissions
RBW=1MHz, VBW=1/T and Peak detector

3.1.3 Test Setup

Radiated Emissions below 1 GHz

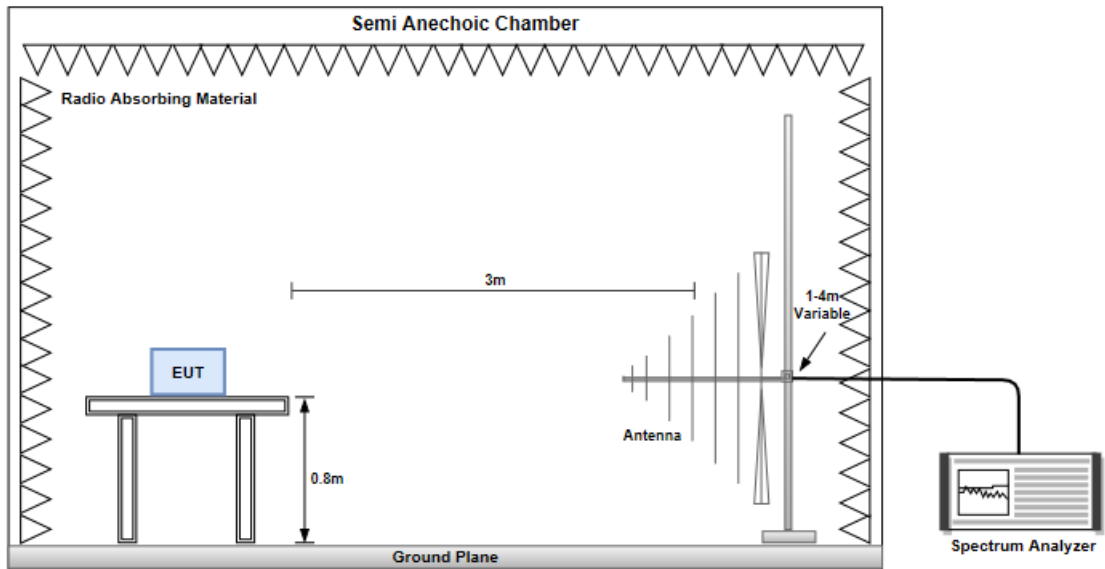

Radiated Emissions above 1 GHz

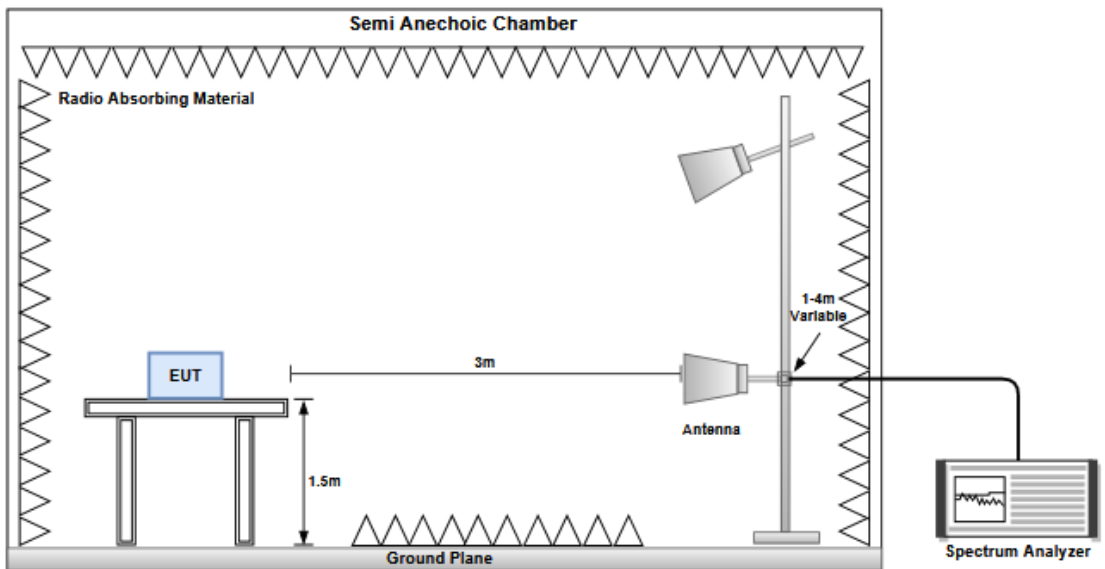

3.1.4 Test Results

Refer to Appendix A.

3.2 Unwanted Emissions into Non-Restricted Frequency Bands

3.2.1 Limit of Unwanted Emissions into Non-Restricted Frequency Bands

Peak power in any 100 kHz bandwidth outside of the authorized frequency band shall be attenuated by at least 20 dB relative to the maximum in-band peak PSD level in 100 kHz.

3.2.2 Test Procedures

Reference level measurement

1. Set RBW=100kHz, VBW = 300kHz , Detector = Peak, Sweep time = Auto
2. Trace = max hold , Allow Trace to fully stabilize
3. Use the peak marker function to determine the maximum PSD level

Emission level measurement

1. Set RBW=100kHz, VBW = 300kHz , Detector = Peak, Sweep time = Auto
2. Trace = max hold , Allow Trace to fully stabilize
3. Scan Frequency range is up to 25GHz
4. Use the peak marker function to determine the maximum amplitude level

3.2.3 Test Setup

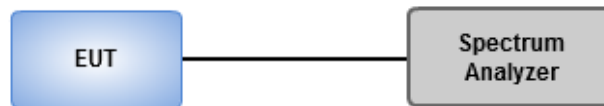

3.2.4 Test Results

Ambient Condition	23°C / 65-68%	Tested By	Roger Lu
--------------------------	---------------	------------------	----------

Refer to Appendix B.

3.3 Conducted Output Power

3.3.1 Limit of Conducted Output Power

- 1 Watt
For frequency hopping systems operating in the 2400–2483.5 MHz band employing at least 75 non overlapping hopping channels, and all frequency hopping systems in the 5725–5850 MHz band.
- 0.125 Watt
For all other frequency hopping systems in the 2400–2483.5 MHz band.
- 0.125 Watt
For Frequency hopping systems operating in the 2400–2483.5 MHz band have hopping channel carrier frequencies that are separated by two-thirds of the 20 dB bandwidth of the hopping channel.

3.3.2 Test Procedures

1. A wideband power meter is used for power measurement. Bandwidth of power sensor and meter is 50MHz
2. If duty cycle of test signal is not 100 %, trigger and gating function of power meter will be enabled to capture transmission burst for measuring output power

3.3.3 Test Setup

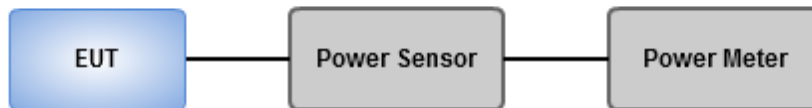

3.3.4 Test Results

Ambient Condition	23°C / 65-68%	Tested By	Roger Lu
--------------------------	---------------	------------------	----------

Refer to Appendix C.

3.4 Number of Hopping Frequency

3.4.1 Limit of Number of Hopping Frequency

Frequency hopping systems in the 2400–2483.5 MHz band shall use at least 15 channels.

3.4.2 Test Procedures

1. Set RBW = 100kHz, VBW = 300kHz, Sweep time = Auto, Detector = Peak Trace max hold.
2. Allow trace to stabilize.

3.4.3 Test Setup

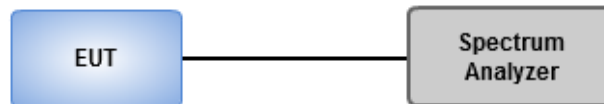

3.4.4 Test Results

Ambient Condition	23°C / 65-68%	Tested By	Roger Lu
--------------------------	---------------	------------------	----------

Refer to Appendix D.

3.5 20dB and Occupied Bandwidth

3.5.1 Test Procedures

20dB Bandwidth

1. Set RBW=20kHz, VBW=100kHz, Sweep time = Auto, Detector=Peak , Trace max hold
2. Allow trace to stabilize
3. Measure the maximum width of the emission that is constrained by the frequencies associated with the two outermost amplitude points (upper and lower) that are attenuated by 20 dB relative to the maximum level measured in the fundamental emission.

Occupied Bandwidth

1. Set RBW=20kHz, VBW=100kHz, Sweep time = Auto, Detector=Sample , Trace max hold
2. Allow trace to stabilize
3. Use Occupied bandwidth function of spectrum analyzer to measuring 99% occupied bandwidth

3.5.2 Test Setup

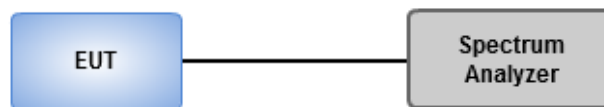

3.5.3 Test Results

Ambient Condition	23°C / 65-68%	Tested By	Roger Lu
--------------------------	---------------	------------------	----------

Refer to Appendix E.

3.6 Channel Separation

3.6.1 Limit of Channel Separation

- Frequency hopping systems shall have hopping channel carrier frequencies separated by a minimum of 25 kHz or the 20 dB bandwidth of the hopping channel, whichever is greater.
- Frequency hopping systems operating in the 2400–2483.5 MHz band may have hopping channel carrier frequencies that are separated by 25 kHz or two-thirds of the 20 dB bandwidth of the hopping channel, whichever is greater.

3.6.2 Test Procedures

1. Set RBW=30kHz, VBW=100kHz, Sweep time = Auto, Detector=Peak Trace max hold
2. Allow trace to stabilize
3. Use the marker-delta function to determine the separation between the peaks of the adjacent channels. The EUT shall show compliance with the appropriate regulatory limit

3.6.3 Test Setup

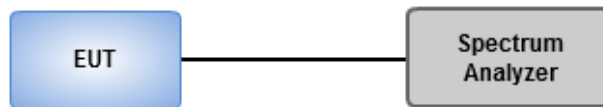

3.6.4 Test Results

Ambient Condition	23°C / 65-68%	Tested By	Roger Lu
--------------------------	---------------	------------------	----------

Refer to Appendix F.

3.7 Number of Dwell Time

3.7.1 Limit of Dwell time

The average time of occupancy on any channel shall not be greater than 0.4 seconds within a period of 0.4 seconds multiplied by the number of hopping channels employed.

3.7.2 Test Procedures

1. Set RBW=300 kHz, VBW=1 MHz, Sweep time=8 ms, Detector=Peak, Span=0 Hz, Trace max hold.
2. Enable gating and trigger function of spectrum analyzer to measure burst on time.
3. Set RBW=300 kHz, VBW=1 MHz, Sweep time=5 s / 2 s, Detector=Peak, Span=0 Hz, Trace max hold.
4. Enable gating and trigger function of spectrum analyzer to measure burst on number of transmission.
5. Set RBW=300 kHz, VBW=1 MHz, Sweep time=31.6 s / 8 s, Detector=Peak, Span=0 Hz, Trace max hold.
6. Enable gating and trigger function of spectrum analyzer to measure burst on number of transmission of entire time cycle.

3.7.3 Test Setup

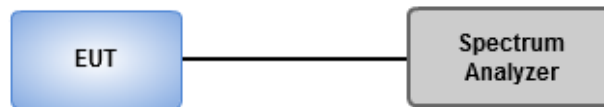

3.7.4 Test Results

Ambient Condition	23°C / 65-68%	Tested By	Roger Lu
--------------------------	---------------	------------------	----------

Refer to Appendix G.

3.8 AC Power Line Conducted Emissions

3.8.1 Limit of AC Power Line Conducted Emissions

Conducted Emissions Limit		
Frequency Emission (MHz)	Quasi-Peak	Average
0.15-0.5	66 - 56 *	56 - 46 *
0.5-5	56	46
5-30	60	50

Note 1: * Decreases with the logarithm of the frequency.

3.8.2 Test Procedures

1. The device is placed on a test table, raised 80 cm above the reference ground plane. The vertical conducting plane is located 40 cm to the rear of the device.
2. The device is connected to line impedance stabilization network (LISN) and other accessories are connected to other LISN. Measured levels of AC power line conducted emission are across the 50 Ω LISN port.
3. AC conducted emission measurements is made over frequency range from 150 kHz to 30 MHz.
4. This measurement was performed with AC 120V/60Hz

3.8.3 Test Setup

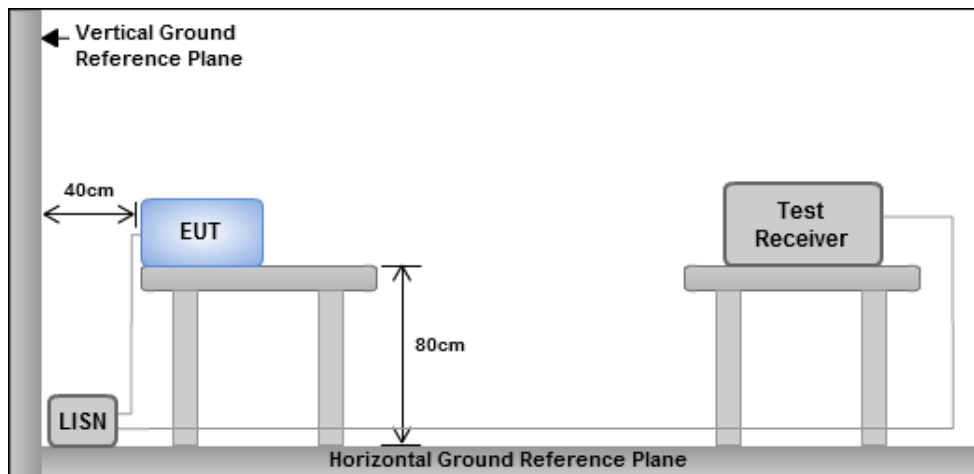

- Note: 1. Support units were connected to second LISN.
2. Both of LISNs (AMN) are 80 cm from EUT and at least 80 cm from other units and other metal planes

3.8.4 Test Results

Refer to Appendix H.

4 Test laboratory information

Established in 2012, ICC provides foremost EMC & RF Testing and advisory consultation services by our skilled engineers and technicians. Our services employ a wide variety of advanced edge test equipment and one of the widest certification extents in the business.

International Certification Corporation (EMC and Wireless Communication Laboratory), it is our definitive objective is to institute long term, trust-based associations with our clients. The expectation we set up with our clients is based on outstanding service, practical expertise and devotion to a certified value structure. Our passion is to grant our clients with best EMC / RF services by oriented knowledgeable and accommodating staff.

Our Test sites are located at Linkou District and Kwei Shan District. Location map can be found on our website <http://www.icertifi.com.tw>.

Linkou

Tel: 886-2-2601-1640

No.30-2, Ding Fwu Tsuen, Lin Kou
District, New Taipei City, Taiwan
(R.O.C.)

Kwei Shan

Tel: 886-3-271-8666

No.3-1, Lane 6, Wen San 3rd
St., Kwei Shan Dist., Tao Yuan
City 33381, Taiwan (R.O.C.)
No.2-1, Lane 6, Wen San 3rd
St., Kwei Shan Dist., Tao Yuan
City 33381, Taiwan (R.O.C.)

Kwei Shan Site II

Tel: 886-3-271-8640

No.14-1, Lane 19, Wen San 3rd
St., Kwei Shan Dist., Tao Yuan
City 33381, Taiwan (R.O.C.)

If you have any suggestion, please feel free to contact us as below information.

Tel: 886-3-271-8666

Fax: 886-3-318-0345

Email: ICC_Service@icertifi.com.tw

==END==



Summary

Mode	Result	F-Start (Hz)	F-Stop (Hz)	Type	Freq (Hz)	DG (dBi)	Psum (dBm)	GRF (dB)	EIRP (dBm)	Limit (dBm)	Margin (dB)
2.4-2.4835GHz	-	-	-	-	-	-	-	-	-	-	-
BT-EDR(3Mbps)	Pass	30M	1G	PK	74.98M	2.40	-76.71	4.7	-69.61	-55.20	-14.41

DG = Directional Gain ; PX=Port X; Psum=P1+P2+...PX

Result

Mode	Result	F-Start (Hz)	F-Stop (Hz)	Type	Freq (Hz)	DG (dBi)	Psum (dBm)	GRF (dB)	EIRP (dBm)	Limit (dBm)	Margin (dB)
BT-EDR(3Mbps)	-	-	-	-	-	-	-	-	-	-	-
2402MHz	Pass	30M	1G	PK	74.98M	2.40	-76.71	4.7	-69.61	-55.20	-14.41

DG = Directional Gain ; PX=Port X; Psum=P1+P2+...PX

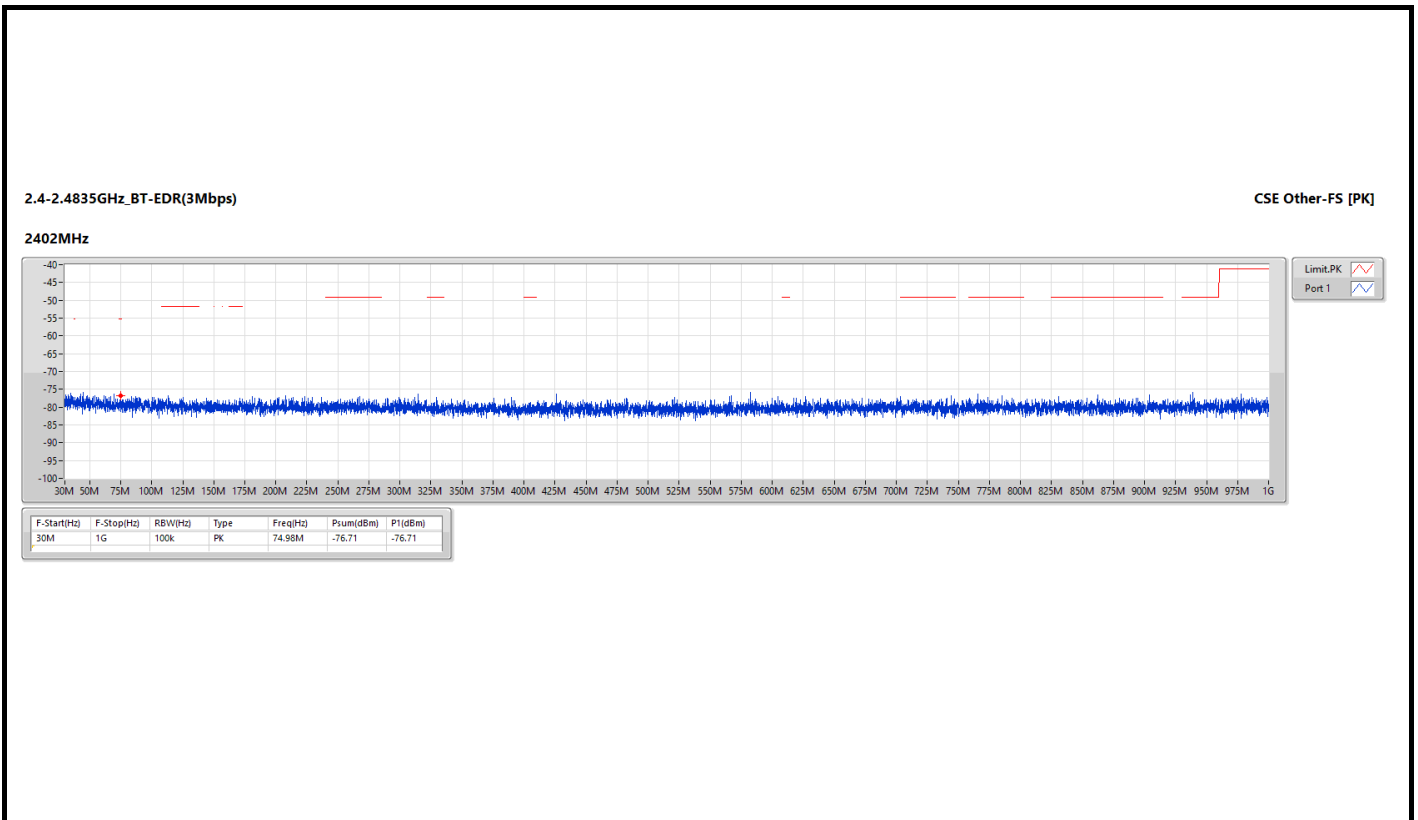



Unwanted Conducted Emissions into Restricted Frequency Bands 1GHz~3.1GHz - SC Module

Appendix A.2

Summary

Mode	Result	F-Start (Hz)	F-Stop (Hz)	Type	Freq (Hz)	DG (dBi)	Psum (dBm)	EIRP (dBm)	Limit (dBm)	Margin (dB)
2.4-2.4835GHz	-	-	-	-	-	-	-	-	-	-
BT-BR(1Mbps)	Pass	2.4835G	2.5G	AV	2.48379G	2.40	-63.42	-61.02	-41.20	-19.82
BT-EDR(3Mbps)	Pass	2.4835G	2.5G	AV	2.48352G	2.40	-62.27	-59.87	-41.20	-18.67

DG = Directional Gain ; PX=Port X; Psum=P1+P2+...PX

Result

Mode	Result	F-Start (Hz)	F-Stop (Hz)	Type	Freq (Hz)	DG (dBi)	Psum (dBm)	EIRP (dBm)	Limit (dBm)	Margin (dB)
BT-BR(1Mbps)	-	-	-	-	-	-	-	-	-	-
2402MHz	Pass	1G	2.31G	AV	2.2951G	2.40	-64.54	-62.14	-41.20	-20.94
2402MHz	Pass	2.31G	2.39G	AV	2.32188G	2.40	-64.80	-62.40	-41.20	-21.20
2402MHz	Pass	2.4835G	2.5G	AV	2.48507G	2.40	-65.55	-63.15	-41.20	-21.95
2402MHz	Pass	2.5G	3.1G	AV	2.56195G	2.40	-65.00	-62.60	-41.20	-21.40
2402MHz	Pass	1G	2.31G	PK	1.83775G	2.40	-53.74	-51.34	-21.20	-30.14
2402MHz	Pass	2.31G	2.39G	PK	2.32176G	2.40	-54.73	-52.33	-21.20	-31.13
2402MHz	Pass	2.4835G	2.5G	PK	2.49512G	2.40	-54.72	-52.32	-21.20	-31.12
2402MHz	Pass	2.5G	3.1G	PK	2.8288G	2.40	-54.59	-52.19	-21.20	-30.99
2441MHz	Pass	1G	2.31G	AV	2.20094G	2.40	-64.69	-62.29	-41.20	-21.09
2441MHz	Pass	2.31G	2.39G	AV	2.361G	2.40	-64.44	-62.04	-41.20	-20.84
2441MHz	Pass	2.4835G	2.5G	AV	2.48367G	2.40	-65.34	-62.94	-41.20	-21.74
2441MHz	Pass	2.5G	3.1G	AV	2.52085G	2.40	-64.55	-62.15	-41.20	-20.95
2441MHz	Pass	1G	2.31G	PK	2.26546G	2.40	-54.11	-51.71	-21.20	-30.51
2441MHz	Pass	2.31G	2.39G	PK	2.36448G	2.40	-54.87	-52.47	-21.20	-31.27
2441MHz	Pass	2.4835G	2.5G	PK	2.48655G	2.40	-53.85	-51.45	-21.20	-30.25
2441MHz	Pass	2.5G	3.1G	PK	2.7676G	2.40	-54.58	-52.18	-21.20	-30.98
2480MHz	Pass	1G	2.31G	AV	2.26988G	2.40	-64.63	-62.23	-41.20	-21.03
2480MHz	Pass	2.31G	2.39G	AV	2.31996G	2.40	-65.96	-63.56	-41.20	-22.36
2480MHz	Pass	2.4835G	2.5G	AV	2.48379G	2.40	-63.42	-61.02	-41.20	-19.82
2480MHz	Pass	2.5G	3.1G	AV	2.72005G	2.40	-64.77	-62.37	-41.20	-21.17
2480MHz	Pass	1G	2.31G	PK	1.96285G	2.40	-53.56	-51.16	-21.20	-29.96
2480MHz	Pass	2.31G	2.39G	PK	2.36192G	2.40	-55.03	-52.63	-21.20	-31.43
2480MHz	Pass	2.4835G	2.5G	PK	2.48371G	2.40	-52.23	-49.83	-21.20	-28.63
2480MHz	Pass	2.5G	3.1G	PK	2.8612G	2.40	-54.27	-51.87	-21.20	-30.67
BT-EDR(3Mbps)	-	-	-	-	-	-	-	-	-	-
2402MHz	Pass	1G	2.31G	AV	2.29723G	2.40	-64.76	-62.36	-41.20	-21.16
2402MHz	Pass	2.31G	2.39G	AV	2.32196G	2.40	-65.10	-62.70	-41.20	-21.50
2402MHz	Pass	2.4835G	2.5G	AV	2.48498G	2.40	-65.32	-62.92	-41.20	-21.72
2402MHz	Pass	2.5G	3.1G	AV	2.64175G	2.40	-64.59	-62.19	-41.20	-20.99
2402MHz	Pass	1G	2.31G	PK	1.86133G	2.40	-53.84	-51.44	-21.20	-30.24
2402MHz	Pass	2.31G	2.39G	PK	2.38524G	2.40	-55.22	-52.82	-21.20	-31.62
2402MHz	Pass	2.4835G	2.5G	PK	2.48476G	2.40	-54.48	-52.08	-21.20	-30.88
2402MHz	Pass	2.5G	3.1G	PK	2.8912G	2.40	-54.42	-52.02	-21.20	-30.82



**Unwanted Conducted Emissions into Restricted
Frequency Bands 1GHz~3.1GHz - SC Module**

Appendix A.2

Mode	Result	F-Start (Hz)	F-Stop (Hz)	Type	Freq (Hz)	DG (dBi)	Psum (dBm)	EIRP (dBm)	Limit (dBm)	Margin (dB)
2441MHz	Pass	1G	2.31G	AV	2.25809G	2.40	-64.69	-62.29	-41.20	-21.09
2441MHz	Pass	2.31G	2.39G	AV	2.36116G	2.40	-64.89	-62.49	-41.20	-21.29
2441MHz	Pass	2.4835G	2.5G	AV	2.48366G	2.40	-65.32	-62.92	-41.20	-21.72
2441MHz	Pass	2.5G	3.1G	AV	2.52085G	2.40	-64.38	-61.98	-41.20	-20.78
2441MHz	Pass	1G	2.31G	PK	1.80696G	2.40	-53.52	-51.12	-21.20	-29.92
2441MHz	Pass	2.31G	2.39G	PK	2.33712G	2.40	-54.16	-51.76	-21.20	-30.56
2441MHz	Pass	2.4835G	2.5G	PK	2.49653G	2.40	-54.79	-52.39	-21.20	-31.19
2441MHz	Pass	2.5G	3.1G	PK	2.5804G	2.40	-54.34	-51.94	-21.20	-30.74
2480MHz	Pass	1G	2.31G	AV	2.25662G	2.40	-64.77	-62.37	-41.20	-21.17
2480MHz	Pass	2.31G	2.39G	AV	2.37624G	2.40	-65.89	-63.49	-41.20	-22.29
2480MHz	Pass	2.4835G	2.5G	AV	2.48352G	2.40	-62.27	-59.87	-41.20	-18.67
2480MHz	Pass	2.5G	3.1G	AV	2.8279G	2.40	-64.88	-62.48	-41.20	-21.28
2480MHz	Pass	1G	2.31G	PK	2.29035G	2.40	-52.82	-50.42	-21.20	-29.22
2480MHz	Pass	2.31G	2.39G	PK	2.37804G	2.40	-54.57	-52.17	-21.20	-30.97
2480MHz	Pass	2.4835G	2.5G	PK	2.48375G	2.40	-51.88	-49.48	-21.20	-28.28
2480MHz	Pass	2.5G	3.1G	PK	2.6332G	2.40	-54.06	-51.66	-21.20	-30.46

DG = Directional Gain ; PX=Port X; Psum=P1+P2+...PX



2.4-2.4835GHz_BT-BR(1Mbps)

CSE Bandedge-FS [PK]

2402MHz

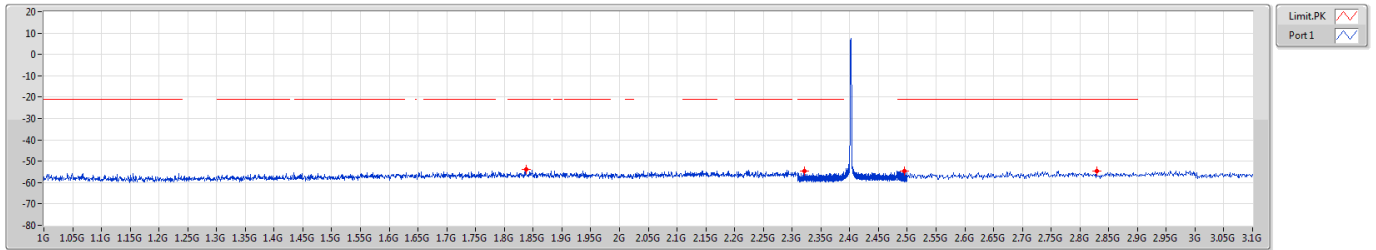

F-Start(Hz)	F-Stop(Hz)	RBW(Hz)	Type	Freq(Hz)	Psum(dBm)	P1(dBm)
1G	2.31G	1M	PK	1.83775G	-53.74	-53.74
2.31G	2.39G	1M	PK	2.32176G	-54.73	-54.73
2.4835G	2.5G	1M	PK	2.49512G	-54.72	-54.72
2.5G	3.1G	1M	PK	2.8288G	-54.59	-54.59

2.4-2.4835GHz_BT-BR(1Mbps)

CSE Bandedge-FS [AV]

2402MHz

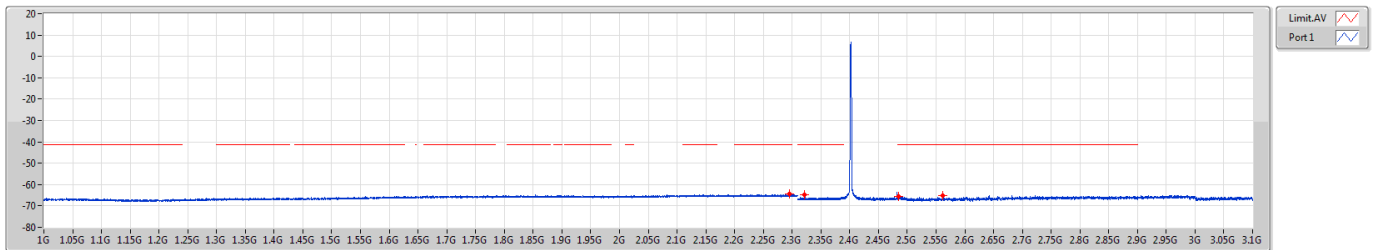

F-Start(Hz)	F-Stop(Hz)	RBW(Hz)	Type	Freq(Hz)	Psum(dBm)	P1(dBm)
1G	2.31G	1M	AV	2.2951G	-64.54	-64.54
2.31G	2.39G	1M	AV	2.32188G	-64.80	-64.80
2.4835G	2.5G	1M	AV	2.48507G	-65.55	-65.55
2.5G	3.1G	1M	AV	2.56195G	-65.00	-65.00



2.4-2.4835GHz_BT-BR(1Mbps)

CSE Bandedge-FS [PK]

2441MHz

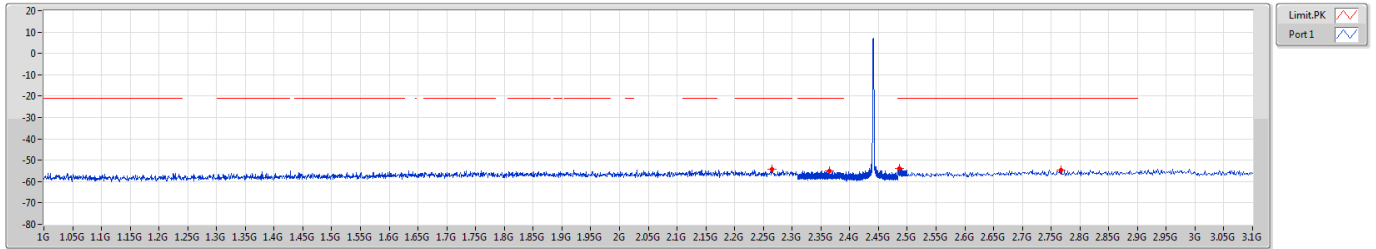

F-Start(Hz)	F-Stop(Hz)	RBW(Hz)	Type	Freq(Hz)	Psum(dBm)	P1(dBm)
1G	2.31G	1M	PK	2.26546G	-54.11	-54.11
2.31G	2.39G	1M	PK	2.36448G	-54.87	-54.87
2.4835G	2.5G	1M	PK	2.48655G	-53.85	-53.85
2.5G	3.1G	1M	PK	2.7676G	-54.58	-54.58

2.4-2.4835GHz_BT-BR(1Mbps)

CSE Bandedge-FS [AV]

2441MHz

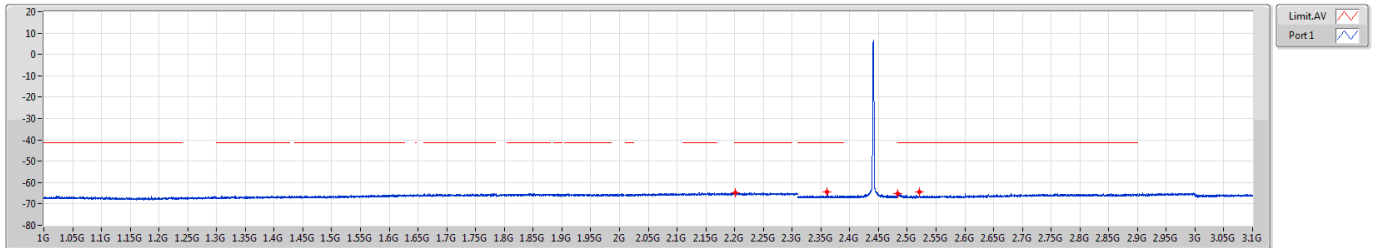

F-Start(Hz)	F-Stop(Hz)	RBW(Hz)	Type	Freq(Hz)	Psum(dBm)	P1(dBm)
1G	2.31G	1M	AV	2.20094G	-64.69	-64.69
2.31G	2.39G	1M	AV	2.361G	-64.44	-64.44
2.4835G	2.5G	1M	AV	2.48367G	-65.34	-65.34
2.5G	3.1G	1M	AV	2.52085G	-64.55	-64.55



2.4-2.4835GHz_BT-BR(1Mbps)

CSE Bandedge-FS [PK]

2480MHz

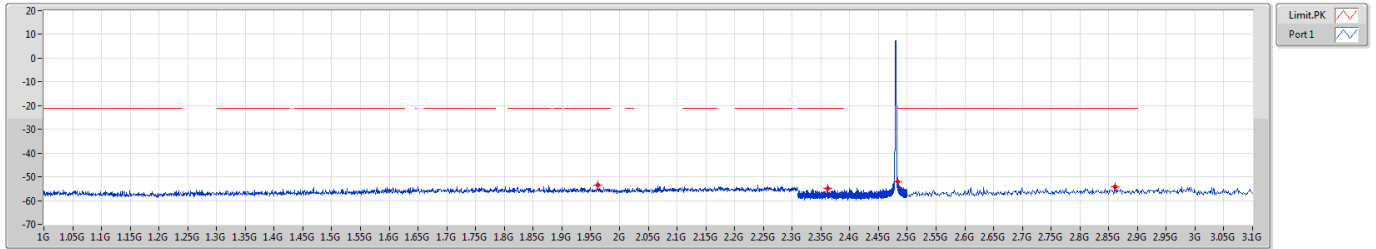

F-Start(Hz)	F-Stop(Hz)	RBW(Hz)	Type	Freq(Hz)	Psum(dBm)	P1(dBm)
1G	2.31G	1M	PK	1.96285G	-53.56	-53.56
2.31G	2.39G	1M	PK	2.36192G	-55.03	-55.03
2.4835G	2.5G	1M	PK	2.48371G	-52.23	-52.23
2.5G	3.1G	1M	PK	2.8612G	-54.27	-54.27

2.4-2.4835GHz_BT-BR(1Mbps)

CSE Bandedge-FS [AV]

2480MHz

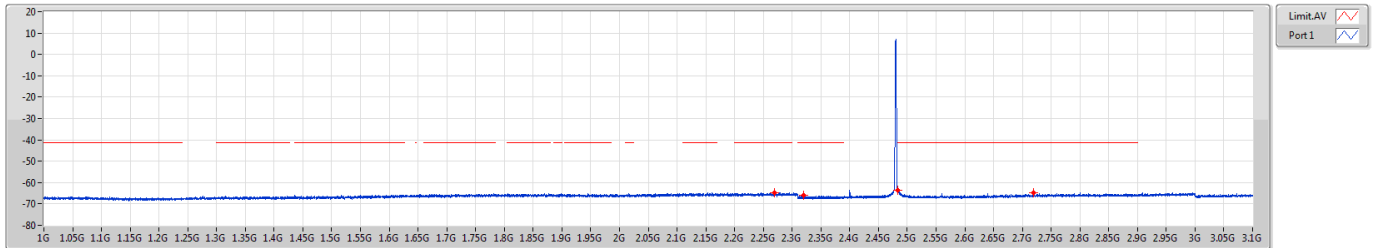

F-Start(Hz)	F-Stop(Hz)	RBW(Hz)	Type	Freq(Hz)	Psum(dBm)	P1(dBm)
1G	2.31G	1M	AV	2.26988G	-64.63	-64.63
2.31G	2.39G	1M	AV	2.31996G	-65.96	-65.96
2.4835G	2.5G	1M	AV	2.48379G	-63.42	-63.42
2.5G	3.1G	1M	AV	2.72005G	-64.77	-64.77



2.4-2.4835GHz_BT-EDR(3Mbps)

CSE Bandedge-FS [PK]

2402MHz

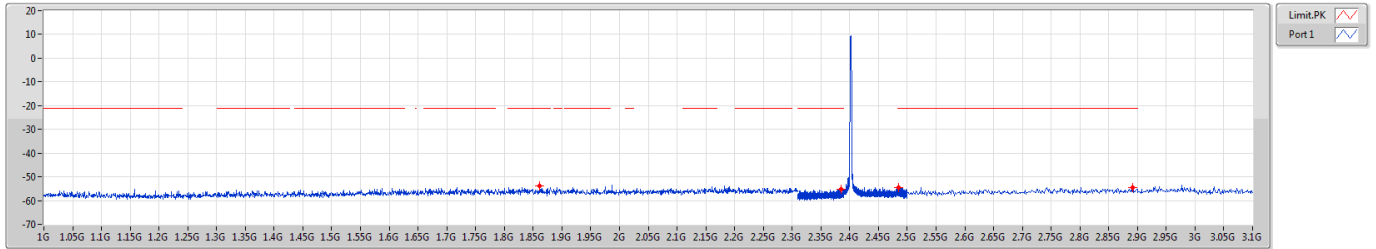

F-Start(Hz)	F-Stop(Hz)	RBW(Hz)	Type	Freq(Hz)	Psum(dBm)	P1(dBm)
1G	2.31G	1M	PK	1.86133G	-53.84	-53.84
2.31G	2.39G	1M	PK	2.38524G	-55.22	-55.22
2.4835G	2.5G	1M	PK	2.48476G	-54.48	-54.48
2.5G	3.1G	1M	PK	2.8912G	-54.42	-54.42

2.4-2.4835GHz_BT-EDR(3Mbps)

CSE Bandedge-FS [AV]

2402MHz

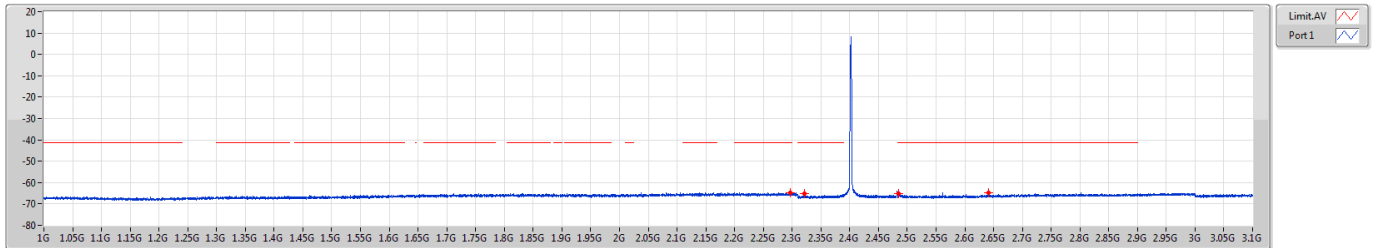

F-Start(Hz)	F-Stop(Hz)	RBW(Hz)	Type	Freq(Hz)	Psum(dBm)	P1(dBm)
1G	2.31G	1M	AV	2.29723G	-64.76	-64.76
2.31G	2.39G	1M	AV	2.32196G	-65.10	-65.10
2.4835G	2.5G	1M	AV	2.48498G	-65.32	-65.32
2.5G	3.1G	1M	AV	2.64175G	-64.59	-64.59



2.4-2.4835GHz_BT-EDR(3Mbps)

CSE Bandedge-FS [PK]

2441MHz

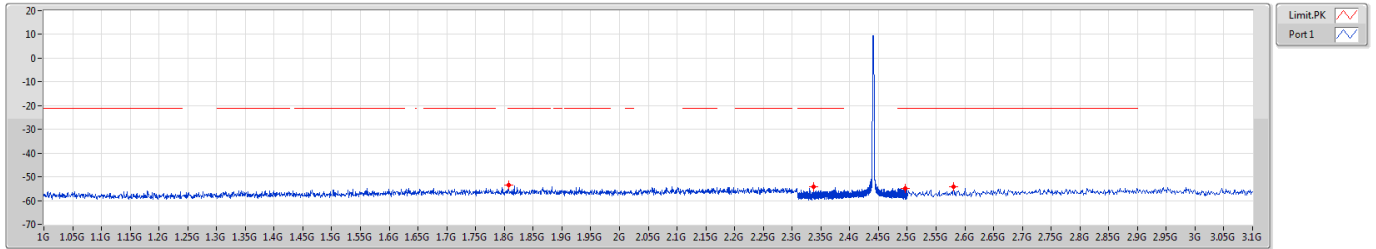

F-Start(Hz)	F-Stop(Hz)	RBW(Hz)	Type	Freq(Hz)	Psum(dBm)	P1(dBm)
1G	2.31G	1M	PK	1.80696G	-53.52	-53.52
2.31G	2.39G	1M	PK	2.33712G	-54.16	-54.16
2.4835G	2.5G	1M	PK	2.49653G	-54.79	-54.79
2.5G	3.1G	1M	PK	2.5804G	-54.34	-54.34

2.4-2.4835GHz_BT-EDR(3Mbps)

CSE Bandedge-FS [AV]

2441MHz

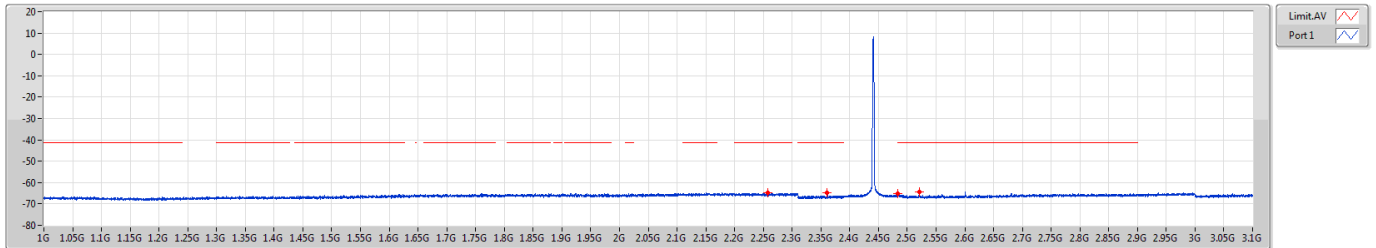

F-Start(Hz)	F-Stop(Hz)	RBW(Hz)	Type	Freq(Hz)	Psum(dBm)	P1(dBm)
1G	2.31G	1M	AV	2.25809G	-64.69	-64.69
2.31G	2.39G	1M	AV	2.36116G	-64.89	-64.89
2.4835G	2.5G	1M	AV	2.48366G	-65.32	-65.32
2.5G	3.1G	1M	AV	2.52085G	-64.38	-64.38



2.4-2.4835GHz_BT-EDR(3Mbps)

CSE Bandedge-FS [PK]

2480MHz

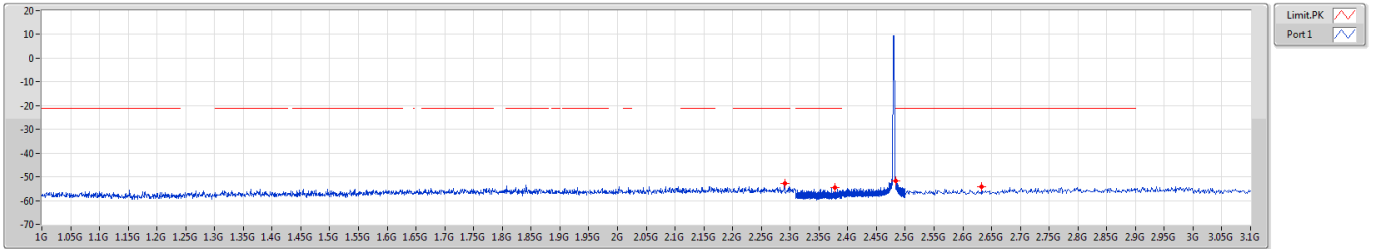

F-Start(Hz)	F-Stop(Hz)	RBW(Hz)	Type	Freq(Hz)	Psum(dBm)	P1(dBm)
1G	2.31G	1M	PK	2.29035G	-52.82	-52.82
2.31G	2.39G	1M	PK	2.37804G	-54.57	-54.57
2.4835G	2.5G	1M	PK	2.48375G	-51.88	-51.88
2.5G	3.1G	1M	PK	2.6332G	-54.06	-54.06

2.4-2.4835GHz_BT-EDR(3Mbps)

CSE Bandedge-FS [AV]

2480MHz

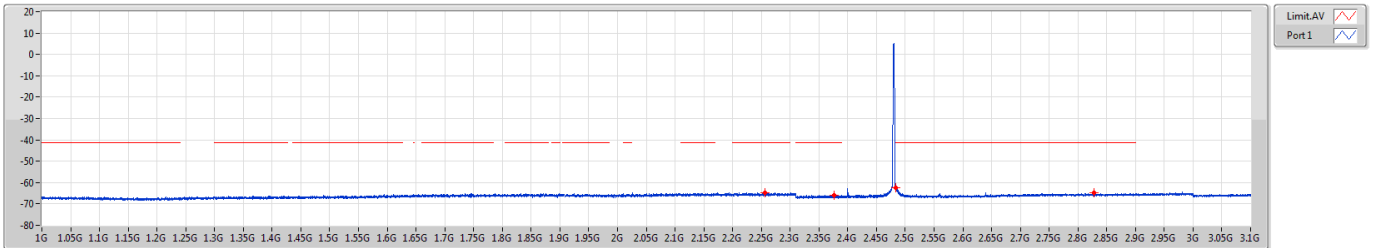

F-Start(Hz)	F-Stop(Hz)	RBW(Hz)	Type	Freq(Hz)	Psum(dBm)	P1(dBm)
1G	2.31G	1M	AV	2.25662G	-64.77	-64.77
2.31G	2.39G	1M	AV	2.37624G	-65.89	-65.89
2.4835G	2.5G	1M	AV	2.48352G	-62.27	-62.27
2.5G	3.1G	1M	AV	2.8279G	-64.88	-64.88



Unwanted Conducted Emissions into Restricted Frequency Bands 3.1GHz~25GHz - SC Module

Appendix A.3

Summary

Mode	Result	F-Start (Hz)	F-Stop (Hz)	Type	Freq (Hz)	DG (dBi)	Psum (dBm)	EIRP (dBm)	Limit (dBm)	Margin (dB)
2.4-2.4835GHz	-	-	-	-	-	-	-	-	-	-
BT-BR(1Mbps)	Pass	8G	25G	PK	22.18756G	2.40	-59.13	-56.73	-21.20	-35.53
BT-EDR(3Mbps)	Pass	8G	25G	PK	22.1695G	2.40	-58.32	-55.92	-21.20	-34.72

DG = Directional Gain ; PX=Port X; Psum=P1+P2+...PX

Result

Mode	Result	F-Start (Hz)	F-Stop (Hz)	Type	Freq (Hz)	DG (dBi)	Psum (dBm)	EIRP (dBm)	Limit (dBm)	Margin (dB)
BT-BR(1Mbps)	-	-	-	-	-	-	-	-	-	-
2402MHz	Pass	3.1G	4G	PK	3.9892G	2.40	-66.88	-64.48	-21.20	-43.28
2402MHz	Pass	4G	5G	PK	4.6455G	2.40	-65.75	-63.35	-21.20	-42.15
2402MHz	Pass	4G	5G	PK	4.805G	2.40	-67.79	-65.39	-21.20	-44.19
2402MHz	Pass	5G	7G	PK	5.3935G	2.40	-65.80	-63.40	-21.20	-42.20
2402MHz	Pass	7G	8G	PK	7.362G	2.40	-62.82	-60.42	-21.20	-39.22
2402MHz	Pass	8G	25G	PK	22.18756G	2.40	-59.13	-56.73	-21.20	-35.53
2441MHz	Pass	3.1G	4G	PK	3.8866G	2.40	-65.93	-63.53	-21.20	-42.33
2441MHz	Pass	4G	5G	PK	4.6675G	2.40	-65.35	-62.95	-21.20	-41.75
2441MHz	Pass	4G	5G	PK	4.88225G	2.40	-65.67	-63.27	-21.20	-42.07
2441MHz	Pass	5G	7G	PK	5.3595G	2.40	-65.62	-63.22	-21.20	-42.02
2441MHz	Pass	7G	8G	PK	7.47975G	2.40	-63.04	-60.64	-21.20	-39.44
2441MHz	Pass	8G	25G	PK	22.08716G	2.40	-59.63	-57.23	-21.20	-36.03
2480MHz	Pass	3.1G	4G	PK	3.99888G	2.40	-66.38	-63.98	-21.20	-42.78
2480MHz	Pass	4G	5G	PK	4.877G	2.40	-65.91	-63.51	-21.20	-42.31
2480MHz	Pass	4G	5G	PK	4.96075G	2.40	-67.57	-65.17	-21.20	-43.97
2480MHz	Pass	5G	7G	PK	5.3535G	2.40	-65.72	-63.32	-21.20	-42.12
2480MHz	Pass	7G	8G	PK	7.4685G	2.40	-63.42	-61.02	-21.20	-39.82
2480MHz	Pass	8G	25G	PK	22.17428G	2.40	-59.30	-56.90	-21.20	-35.70
BT-EDR(3Mbps)	-	-	-	-	-	-	-	-	-	-
2402MHz	Pass	3.1G	4G	PK	3.95613G	2.40	-66.28	-63.88	-21.20	-42.68
2402MHz	Pass	4G	5G	PK	4.80375G	2.40	-66.92	-64.52	-21.20	-43.32
2402MHz	Pass	4G	5G	PK	4.97825G	2.40	-65.34	-62.94	-21.20	-41.74
2402MHz	Pass	5G	7G	PK	5.3735G	2.40	-66.04	-63.64	-21.20	-42.44
2402MHz	Pass	7G	8G	PK	7.49575G	2.40	-62.62	-60.22	-21.20	-39.02
2402MHz	Pass	8G	25G	PK	22.1695G	2.40	-58.32	-55.92	-21.20	-34.72
2441MHz	Pass	3.1G	4G	PK	3.94353G	2.40	-66.50	-64.10	-21.20	-42.90
2441MHz	Pass	4G	5G	PK	4.818G	2.40	-65.24	-62.84	-21.20	-41.64
2441MHz	Pass	4G	5G	PK	4.883G	2.40	-67.50	-65.10	-21.20	-43.90
2441MHz	Pass	5G	7G	PK	5.4555G	2.40	-66.13	-63.73	-21.20	-42.53
2441MHz	Pass	7G	8G	PK	7.48825G	2.40	-61.77	-59.37	-21.20	-38.17
2441MHz	Pass	8G	25G	PK	22.14772G	2.40	-58.95	-56.55	-21.20	-35.35
2480MHz	Pass	3.1G	4G	PK	3.95365G	2.40	-66.39	-63.99	-21.20	-42.79
2480MHz	Pass	4G	5G	PK	4.856G	2.40	-66.56	-64.16	-21.20	-42.96



**Unwanted Conducted Emissions into Restricted
Frequency Bands 3.1GHz~25GHz - SC Module**

Appendix A.3

Mode	Result	F-Start (Hz)	F-Stop (Hz)	Type	Freq (Hz)	DG (dBi)	Psum (dBm)	EIRP (dBm)	Limit (dBm)	Margin (dB)
2480MHz	Pass	4G	5G	PK	4.95925G	2.40	-68.91	-66.51	-21.20	-45.31
2480MHz	Pass	5G	7G	PK	5.398G	2.40	-65.98	-63.58	-21.20	-42.38
2480MHz	Pass	7G	8G	PK	7.47625G	2.40	-62.55	-60.15	-21.20	-38.95
2480MHz	Pass	8G	25G	PK	22.76716G	2.40	-58.86	-56.46	-21.20	-35.26

DG = Directional Gain ; PX=Port X; Psum=P1+P2+...PX

Note: If the PK margin greater than 20 dB, there is no need to get AVG reading.



2.4-2.4835GHz_BT-BR(1Mbps)

CSE-FS [PK]

2402MHz

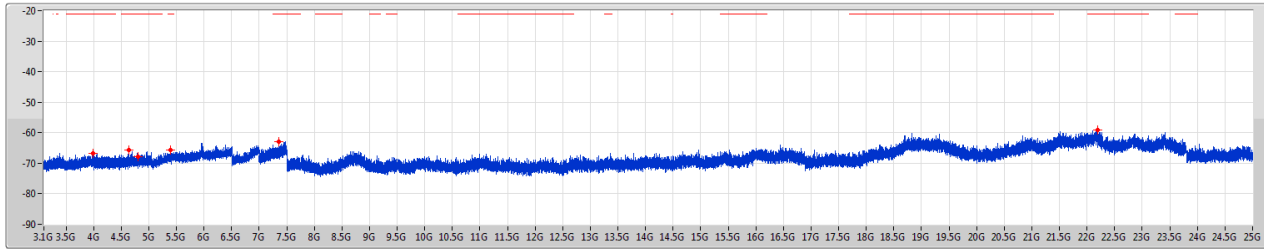

Limit PK
Port 1

F-Start(Hz)	F-Stop(Hz)	RBW(Hz)	Type	Freq(Hz)	Psum(dBm)	P1(dBm)
3.1G	4G	1M	PK	3.9892G	-66.88	-66.88
4G	5G	1M	PK	4.6455G	-65.75	-65.75
4G	5G	1M	PK	4.805G	-67.79	-67.79
5G	7G	1M	PK	5.3935G	-65.00	-65.00
7G	8G	1M	PK	7.962G	-62.82	-62.82
8G	25G	1M	PK	22.1875G	-59.13	-59.13

2.4-2.4835GHz_BT-BR(1Mbps)

CSE-FS [PK]

2441MHz

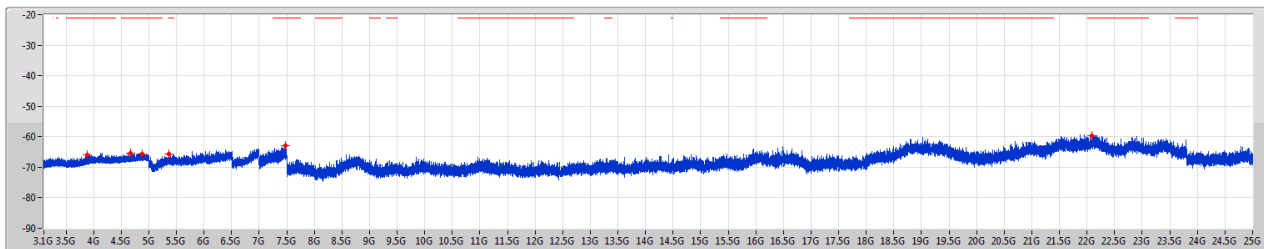

Limit PK
Port 1

F-Start(Hz)	F-Stop(Hz)	RBW(Hz)	Type	Freq(Hz)	Psum(dBm)	P1(dBm)
3.1G	4G	1M	PK	3.8866G	-65.93	-65.93
4G	5G	1M	PK	4.6675G	-65.35	-65.35
4G	5G	1M	PK	4.88225G	-65.67	-65.67
5G	7G	1M	PK	5.3935G	-65.62	-65.62
7G	8G	1M	PK	7.47975G	-63.04	-63.04
8G	25G	1M	PK	22.08716G	-59.63	-59.63



2.4-2.4835GHz_BT-BR(1Mbps)

CSE-FS [PK]

2480MHz

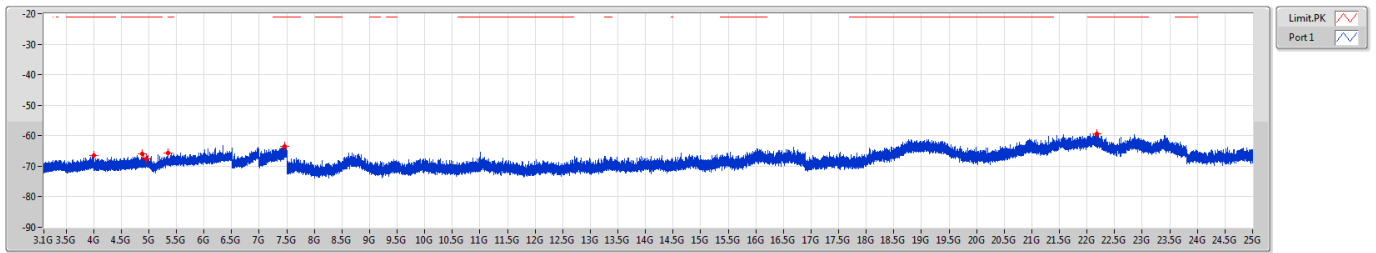

2.4-2.4835GHz_BT-EDR(3Mbps)

CSE-FS [PK]

2402MHz

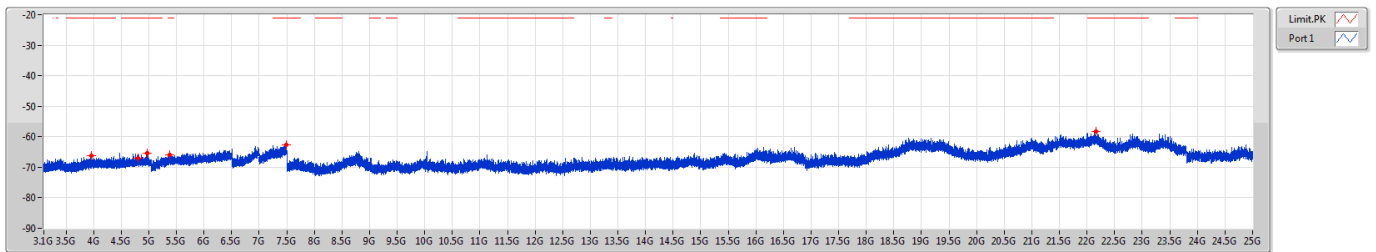



2.4-2.4835GHz_BT-EDR(3Mbps)

CSE-FS [PK]

2441MHz

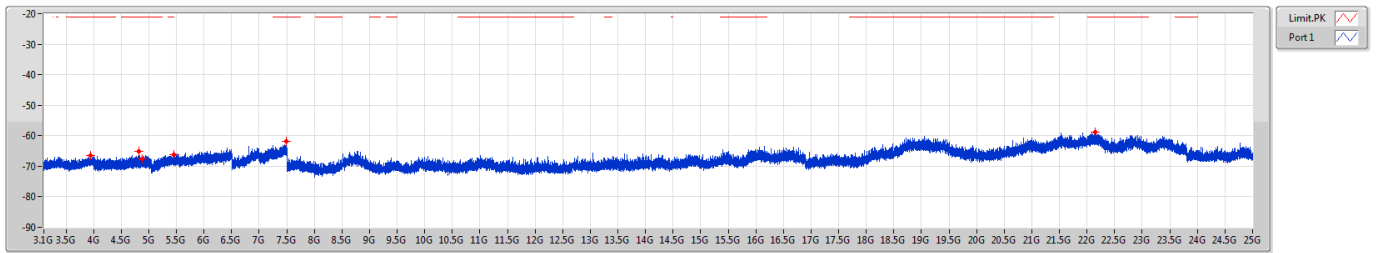

F-Start(Hz)	F-Stop(Hz)	RBW(Hz)	Type	Freq(Hz)	Psum(dBm)	P1(dBm)
3.1G	4G	1M	PK	3.94353G	-66.50	-66.50
4G	5G	1M	PK	4.818G	-65.24	-65.24
4G	5G	1M	PK	4.883G	-67.50	-67.50
5G	7G	1M	PK	5.4555G	-66.13	-66.13
7G	8G	1M	PK	7.48825G	-61.77	-61.77
8G	25G	1M	PK	22.14772G	-58.95	-58.95

2.4-2.4835GHz_BT-EDR(3Mbps)

CSE-FS [PK]

2480MHz

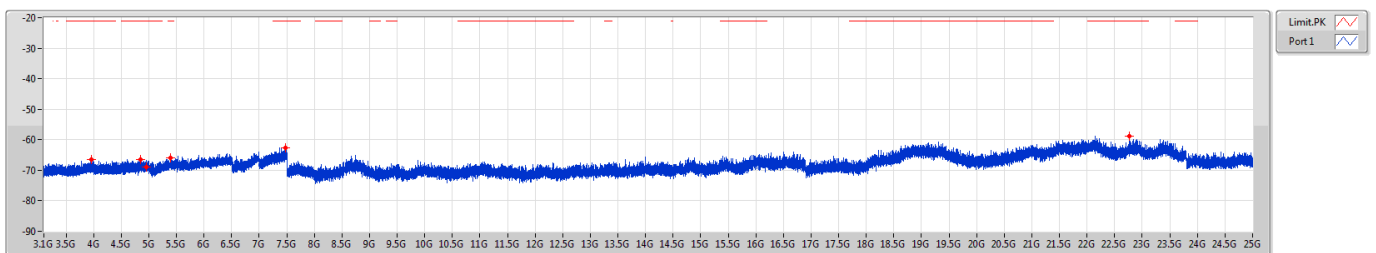

F-Start(Hz)	F-Stop(Hz)	RBW(Hz)	Type	Freq(Hz)	Psum(dBm)	P1(dBm)
3.1G	4G	1M	PK	3.95365G	-66.39	-66.39
4G	5G	1M	PK	4.856G	-66.56	-66.56
4G	5G	1M	PK	4.9925G	-68.91	-68.91
5G	7G	1M	PK	5.398G	-65.98	-65.98
7G	8G	1M	PK	7.47625G	-62.55	-62.55
8G	25G	1M	PK	22.76716G	-58.86	-58.86



Summary

Mode	Result	F-Start (Hz)	F-Stop (Hz)	Type	Freq (Hz)	DG (dBi)	Psum (dBm)	GRF (dB)	EIRP (dBm)	Limit (dBm)	Margin (dB)
2.4-2.4835GHz	-	-	-	-	-	-	-	-	-	-	-
BT-EDR(3Mbps)	Pass	30M	1G	PK	74.26M	2.40	-77.08	4.7	-69.98	-55.20	-14.78

DG = Directional Gain ; PX=Port X; Psum=P1+P2+...PX

Result

Mode	Result	F-Start (Hz)	F-Stop (Hz)	Type	Freq (Hz)	DG (dBi)	Psum (dBm)	GRF (dB)	EIRP (dBm)	Limit (dBm)	Margin (dB)
BT-EDR(3Mbps)	-	-	-	-	-	-	-	-	-	-	-
2402MHz	Pass	30M	1G	PK	74.26M	2.40	-77.08	4.7	-69.98	-55.20	-14.78

DG = Directional Gain ; PX=Port X; Psum=P1+P2+...PX

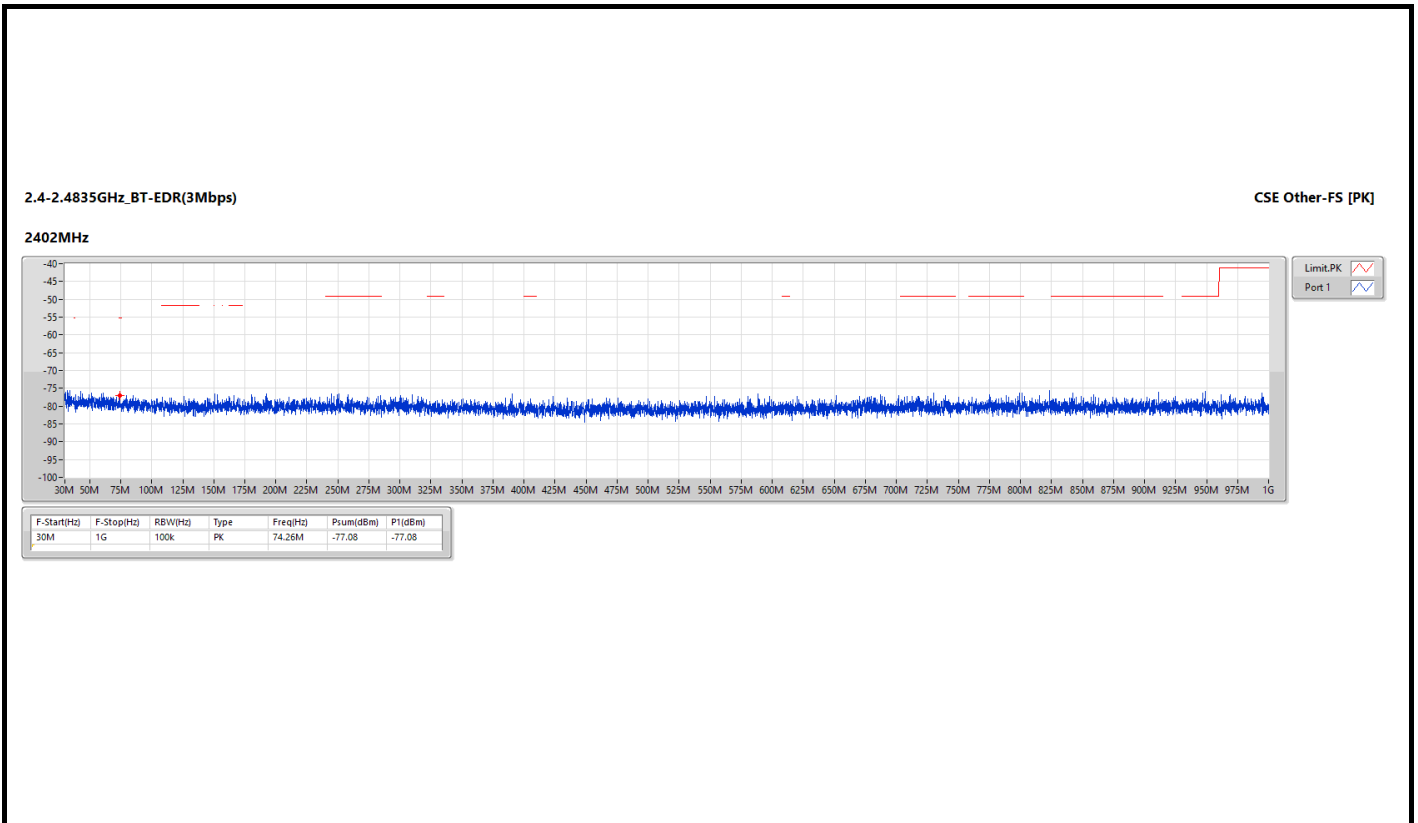



Unwanted Conducted Emissions into Restricted Frequency Bands 1GHz~3.1GHz - ST Module

Appendix A.5

Summary

Mode	Result	F-Start (Hz)	F-Stop (Hz)	Type	Freq (Hz)	DG (dBi)	Psum (dBm)	EIRP (dBm)	Limit (dBm)	Margin (dB)
2.4-2.4835GHz	-	-	-	-	-	-	-	-	-	-
BT-EDR(3Mbps)	Pass	2.4835G	2.5G	AV	2.48374G	2.40	-62.55	-60.15	-41.20	-18.95

DG = Directional Gain ; PX=Port X; Psum=P1+P2+...PX

Result

Mode	Result	F-Start (Hz)	F-Stop (Hz)	Type	Freq (Hz)	DG (dBi)	Psum (dBm)	EIRP (dBm)	Limit (dBm)	Margin (dB)
BT-EDR(3Mbps)	-	-	-	-	-	-	-	-	-	-
2480MHz	Pass	1G	2.31G	AV	2.29461G	2.40	-64.56	-62.16	-41.20	-20.96
2480MHz	Pass	2.31G	2.39G	AV	2.35416G	2.40	-66.16	-63.76	-41.20	-22.56
2480MHz	Pass	2.4835G	2.5G	AV	2.48374G	2.40	-62.55	-60.15	-41.20	-18.95
2480MHz	Pass	2.5G	3.1G	AV	2.84875G	2.40	-65.28	-62.88	-41.20	-21.68
2480MHz	Pass	1G	2.31G	PK	2.20193G	2.40	-53.91	-51.51	-21.20	-30.31
2480MHz	Pass	2.31G	2.39G	PK	2.33992G	2.40	-55.39	-52.99	-21.20	-31.79
2480MHz	Pass	2.4835G	2.5G	PK	2.48368G	2.40	-52.29	-49.89	-21.20	-28.69
2480MHz	Pass	2.5G	3.1G	PK	2.872G	2.40	-54.47	-52.07	-21.20	-30.87

DG = Directional Gain ; PX=Port X; Psum=P1+P2+...PX



2.4-2.4835GHz_BT-EDR(3Mbps)

CSE Bandedge-FS [PK]

2480MHz

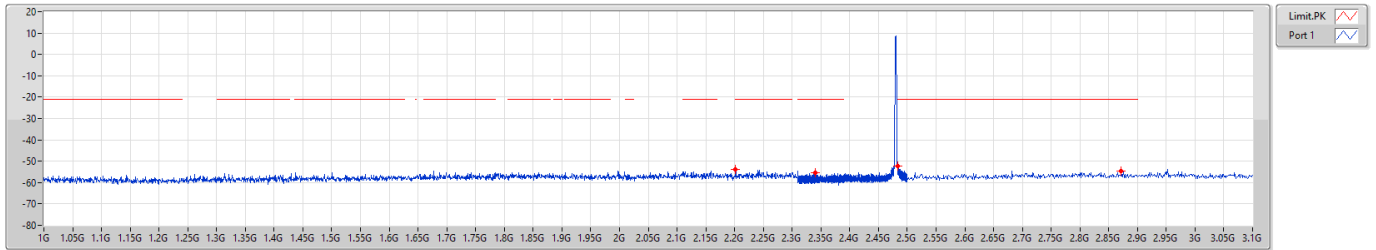

F-Start(Hz)	F-Stop(Hz)	RBW(Hz)	Type	Freq(Hz)	Psum(dBm)	P1(dBm)
1G	2.31G	1M	PK	2.20193G	-53.91	-53.91
2.31G	2.39G	1M	PK	2.33992G	-55.39	-55.39
2.4835G	2.5G	1M	PK	2.48368G	-52.29	-52.29
2.5G	3.1G	1M	PK	2.872G	-54.47	-54.47

2.4-2.4835GHz_BT-EDR(3Mbps)

CSE Bandedge-FS [AV]

2480MHz

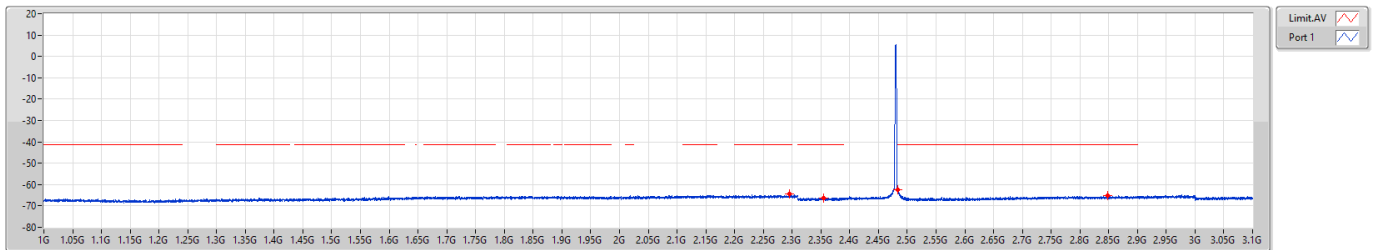

F-Start(Hz)	F-Stop(Hz)	RBW(Hz)	Type	Freq(Hz)	Psum(dBm)	P1(dBm)
1G	2.31G	1M	AV	2.29461G	-64.56	-64.56
2.31G	2.39G	1M	AV	2.35416G	-66.16	-66.16
2.4835G	2.5G	1M	AV	2.48374G	-62.55	-62.55
2.5G	3.1G	1M	AV	2.84875G	-65.28	-65.28



Summary

Mode	Result	F-Start (Hz)	F-Stop (Hz)	Type	Freq (Hz)	DG (dBi)	Psum (dBm)	EIRP (dBm)	Limit (dBm)	Margin (dB)
2.4-2.4835GHz	-	-	-	-	-	-	-	-	-	-
BT-EDR(3Mbps)	Pass	8G	25G	PK	22.24547G	2.40	-59.13	-56.73	-21.20	-35.53

DG = Directional Gain ; PX=Port X; Psum=P1+P2+...PX

Result

Mode	Result	F-Start (Hz)	F-Stop (Hz)	Type	Freq (Hz)	DG (dBi)	Psum (dBm)	EIRP (dBm)	Limit (dBm)	Margin (dB)
BT-EDR(3Mbps)	-	-	-	-	-	-	-	-	-	-
2480MHz	Pass	3.1G	4G	PK	3.97345G	2.40	-66.91	-64.51	-21.20	-43.31
2480MHz	Pass	4G	5G	PK	4.786G	2.40	-67.05	-64.65	-21.20	-43.45
2480MHz	Pass	4G	5G	PK	4.96G	2.40	-68.31	-65.91	-21.20	-44.71
2480MHz	Pass	5G	7G	PK	5.4385G	2.40	-66.99	-64.59	-21.20	-43.39
2480MHz	Pass	7G	8G	PK	7.49925G	2.40	-63.38	-60.98	-21.20	-39.78
2480MHz	Pass	8G	25G	PK	22.24547G	2.40	-59.13	-56.73	-21.20	-35.53

DG = Directional Gain ; PX=Port X; Psum=P1+P2+...PX

Note: If the PK margin greater than 20 dB, there is no need to get AVG reading.

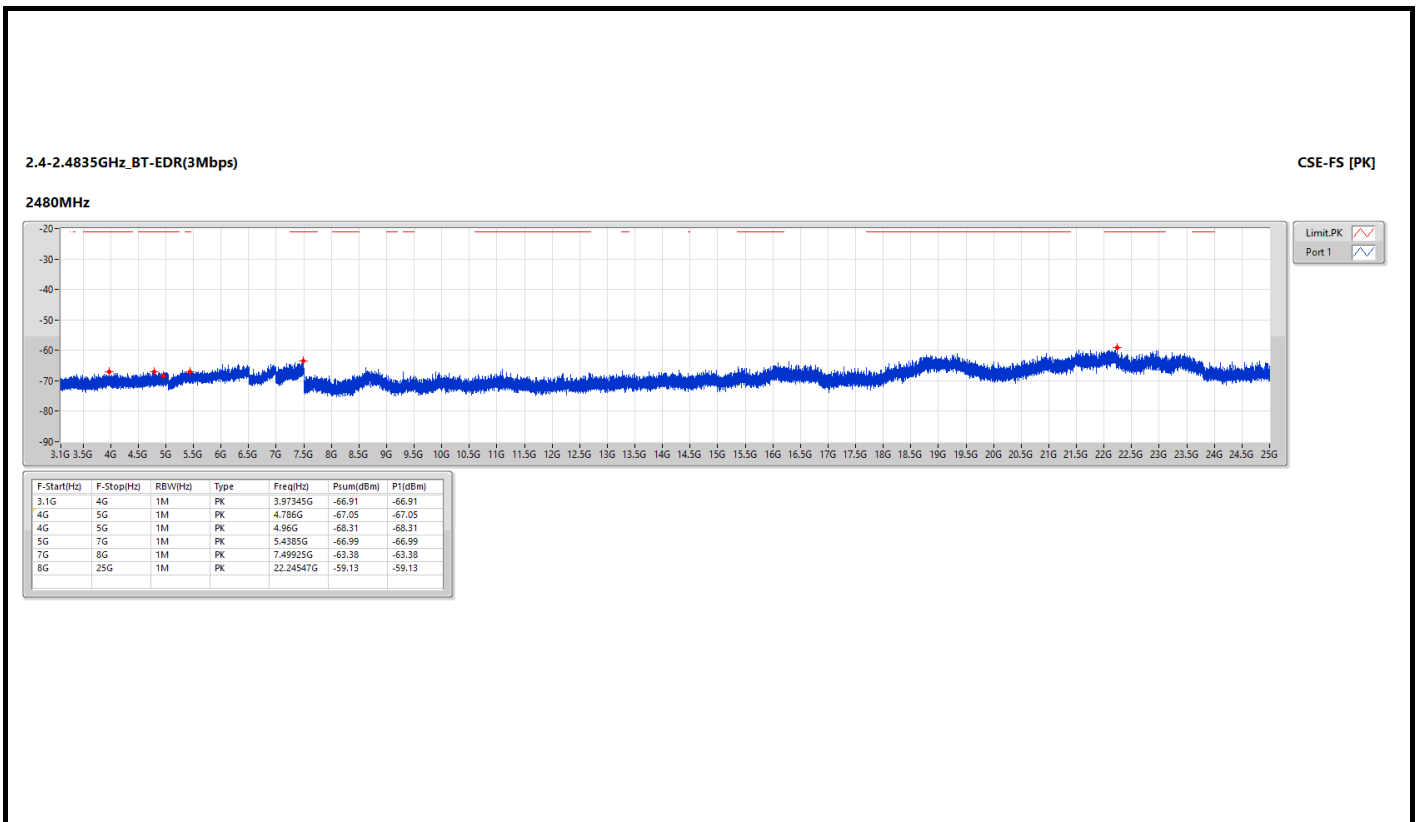



SC Module

Emissions (Below 1GHz)

Modulation	8DPSK	Test Freq. (MHz)	2402
Polarization	Horizontal		

Test By : Sean Yu Temperature(°C): 26 Humidity(%): 61

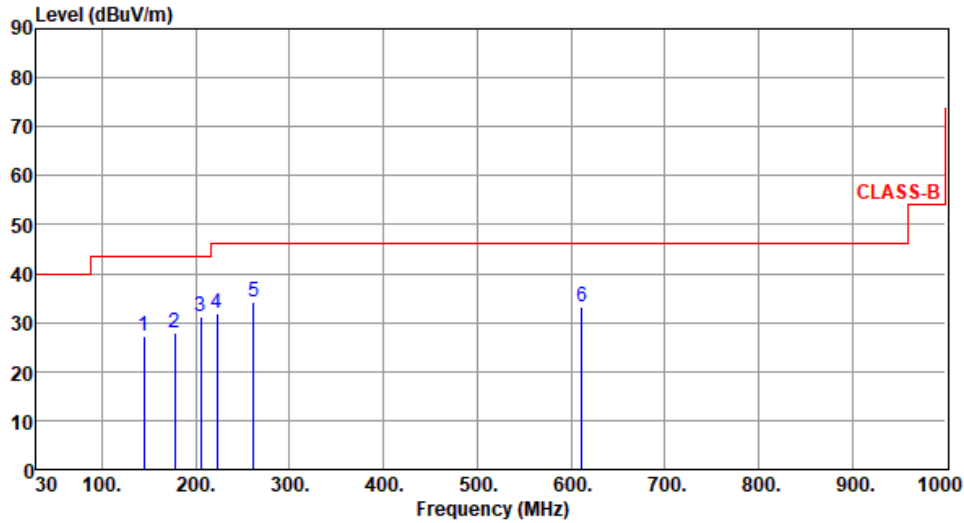

	Freq. MHz	Emission level dBuV/m	Limit dBuV/m	Margin dB	SA reading dBuV	Factor dB/m	Remark	ANT High cm	Turn Table deg
1	144.41	27.38	43.50	-16.12	36.36	-8.98	Peak	---	---
2	177.72	27.76	43.50	-15.74	37.87	-10.11	Peak	---	---
3	205.18	31.34	43.50	-12.16	43.23	-11.89	Peak	---	---
4	222.24	31.78	46.00	-14.22	43.71	-11.93	Peak	---	---
5	261.94	34.32	46.00	-11.68	43.75	-9.43	Peak	---	---
6	611.18	33.23	46.00	-12.77	33.54	-0.31	Peak	---	---

Note 1: Emission Level (dBuV/m) = SA Reading (dBuV) + Factor* (dB/m)

*Factor includes antenna factor , cable loss and amplifier gain

Note 2: Margin (dB) = Emission level (dBuV/m) – Limit (dBuV/m).

Note 3: All spurious emissions below 30MHz are more than 20 dB below the limit.



Unwanted Radiated Emissions into Restricted Frequency Bands

Appendix A.7

Modulation	8DPSK	Test Freq. (MHz)	2402
Polarization	Vertical		

Test By : Sean Yu Temperature(°C): 26 Humidity(%): 61

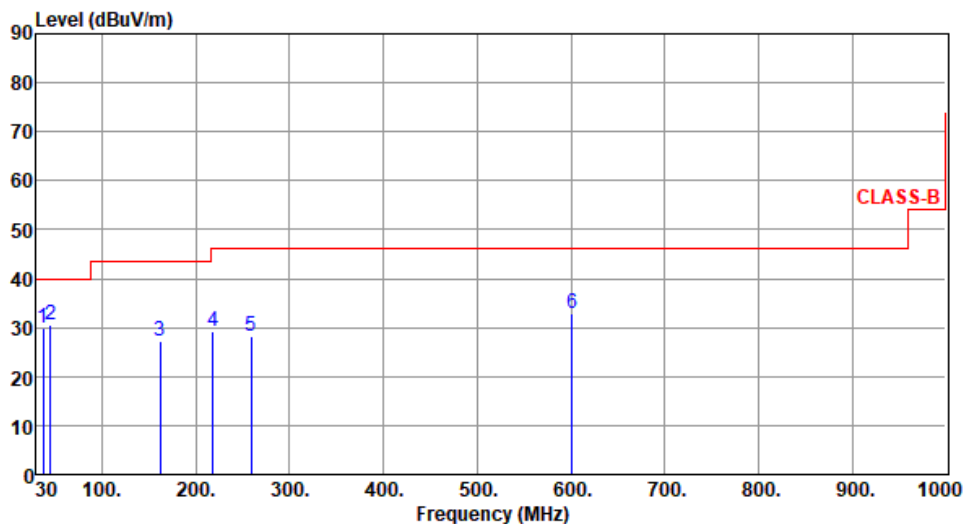

	Freq. MHz	Emission level dBuV/m	Limit dBuV/m	Margin dB	SA reading dBuV	Factor dB/m	Remark	ANT High cm	Turn Table deg
1	36.98	29.81	40.00	-10.19	39.07	-9.26	Peak	---	---
2	44.93	30.65	40.00	-9.35	38.82	-8.17	Peak	---	---
3	162.13	27.20	43.50	-16.30	36.12	-8.92	Peak	---	---
4	218.29	29.36	46.00	-16.64	41.25	-11.89	Peak	---	---
5	259.17	28.34	46.00	-17.66	37.91	-9.57	Peak	---	---
6	601.47	32.87	46.00	-13.13	33.48	-0.61	Peak	---	---

Note 1: Emission Level (dBuV/m) = SA Reading (dBuV) + Factor* (dB/m)

*Factor includes antenna factor , cable loss and amplifier gain

Note 2: Margin (dB) = Emission level (dBuV/m) – Limit (dBuV/m).

Note 3: All spurious emissions below 30MHz are more than 20 dB below the limit.



Emissions (Above 1GHz) for GFSK

Modulation	GFSK	Test Freq. (MHz)	2402
Polarization	Horizontal		

Test By :Sean Yu Temperature(°C):26 Humidity(%):61

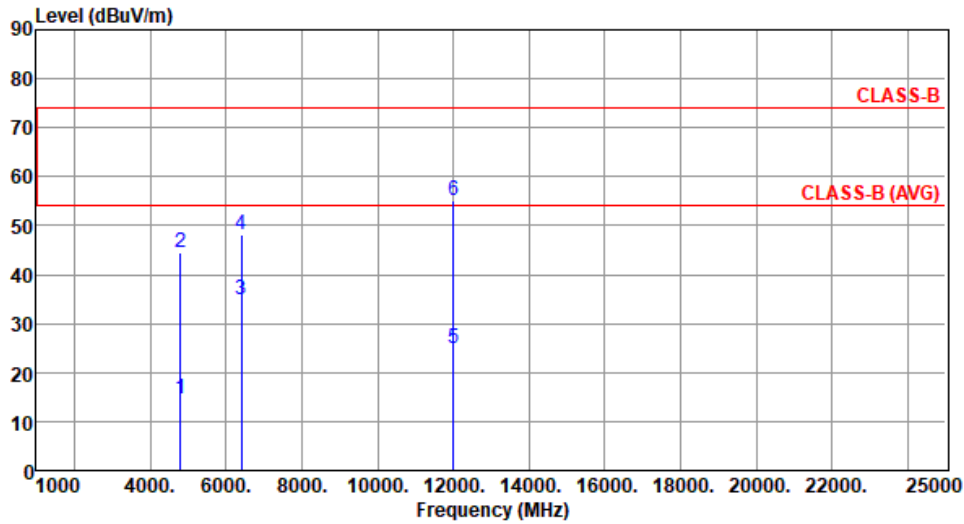

	Freq. MHz	Emission level dBuV/m	Limit dBuV/m	Margin dB	SA reading dBuV	Factor dB/m	Remark	ANT High cm	Turn Table deg
1	4804.00	14.48	54.00	-39.52			Average	100	223
2	4804.00	44.58	74.00	-29.42	44.85	-0.27	Peak	100	223
3	6405.33	34.91	54.00	-19.09	32.31	2.60	Average	100	203
4	6405.33	48.01	74.00	-25.99	45.41	2.60	Peak	100	203
5	12010.00	25.01	54.00	-28.99			Average	100	213
6	12010.00	55.11	74.00	-18.89	48.59	6.52	Peak	100	213

Note 1: Emission Level (dBuV/m) = SA Reading (dBuV) + Factor* (dB/m)
 *Factor includes antenna factor , cable loss and amplifier gain
 Note 2: Margin (dB) = Emission level (dBuV/m) – Limit (dBuV/m).
 Note 3: When average value is calculated not measured, no SA reading and factor value are listed.



Unwanted Radiated Emissions into Restricted Frequency Bands

Appendix A.7

Modulation	GFSK	Test Freq. (MHz)	2402
------------	------	------------------	------

Polarization	Vertical
--------------	----------

Test By : Sean Yu Temperature(°C): 26 Humidity(%): 61

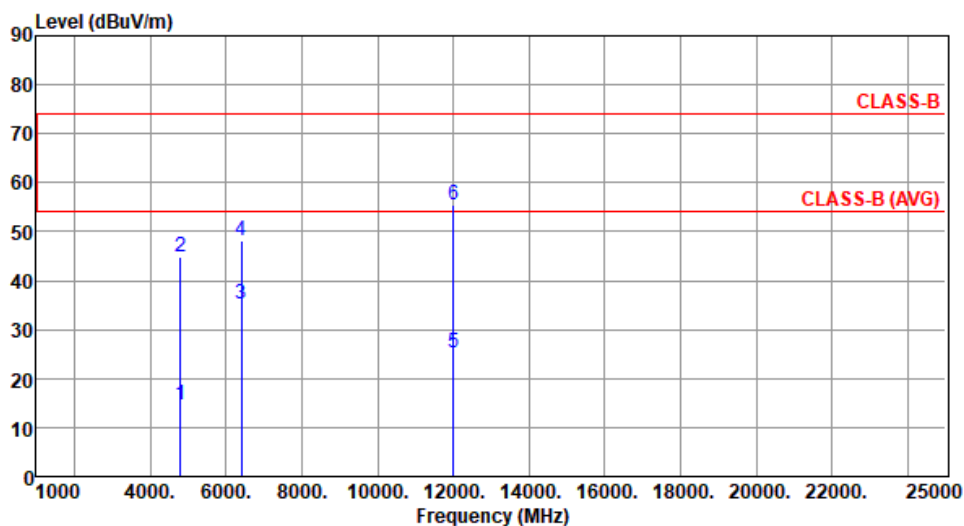

	Freq. MHz	Emission level dBuV/m	Limit dBuV/m	Margin dB	SA reading dBuV	Factor dB/m	Remark	ANT High cm	Turn Table deg
1	4804.00	14.65	54.00	-39.35			Average	100	174
2	4804.00	44.75	74.00	-29.25	45.02	-0.27	Peak	100	174
3	6405.33	35.11	54.00	-18.89	32.51	2.60	Average	100	220
4	6405.33	48.21	74.00	-25.79	45.61	2.60	Peak	100	210
5	12010.00	25.38	54.00	-28.62			Average	100	203
6	12010.00	55.48	74.00	-18.52	48.96	6.52	Peak	100	203

Note 1: Emission Level (dBuV/m) = SA Reading (dBuV) + Factor* (dB/m)

*Factor includes antenna factor , cable loss and amplifier gain

Note 2: Margin (dB) = Emission level (dBuV/m) – Limit (dBuV/m).

Note 3: When average value is calculated not measured, no SA reading and factor value are listed.



Unwanted Radiated Emissions into Restricted Frequency Bands

Appendix A.7

Modulation	GFSK	Test Freq. (MHz)	2441
-------------------	------	-------------------------	------

Polarization	Horizontal
---------------------	------------

Test By : Sean Yu Temperature(°C): 26 Humidity(%): 61

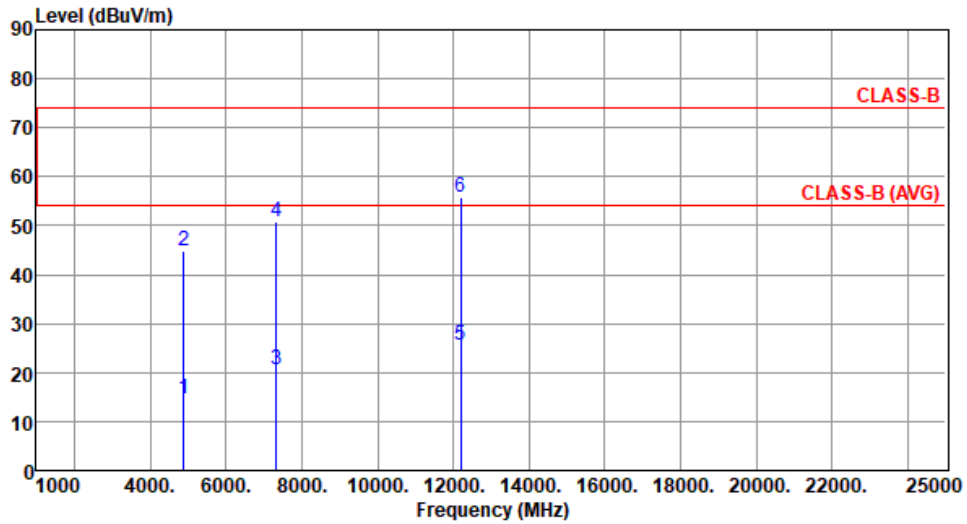

	Freq. MHz	Emission level dBuV/m	Limit dBuV/m	Margin dB	SA reading dBuV	Factor dB/m	Remark	ANT High cm	Turn Table deg
1	4882.00	14.62	54.00	-39.38			Average	100	207
2	4882.00	44.72	74.00	-29.28	44.97	-0.25	Peak	100	207
3	7323.00	20.56	54.00	-33.44			Average	100	165
4	7323.00	50.66	74.00	-23.34	45.24	5.42	Peak	100	165
5	12205.00	25.65	54.00	-28.35			Average	100	229
6	12205.00	55.75	74.00	-18.25	49.22	6.53	Peak	100	229

Note 1: Emission Level (dBuV/m) = SA Reading (dBuV) + Factor* (dB/m)

*Factor includes antenna factor , cable loss and amplifier gain

Note 2: Margin (dB) = Emission level (dBuV/m) – Limit (dBuV/m).

Note 3: When average value is calculated not measured, no SA reading and factor value are listed.



Unwanted Radiated Emissions into Restricted Frequency Bands

Appendix A.7

Modulation	GFSK	Test Freq. (MHz)	2441
-------------------	------	-------------------------	------

Polarization	Vertical
---------------------	----------

Test By : Sean Yu Temperature(°C): 26 Humidity(%): 61

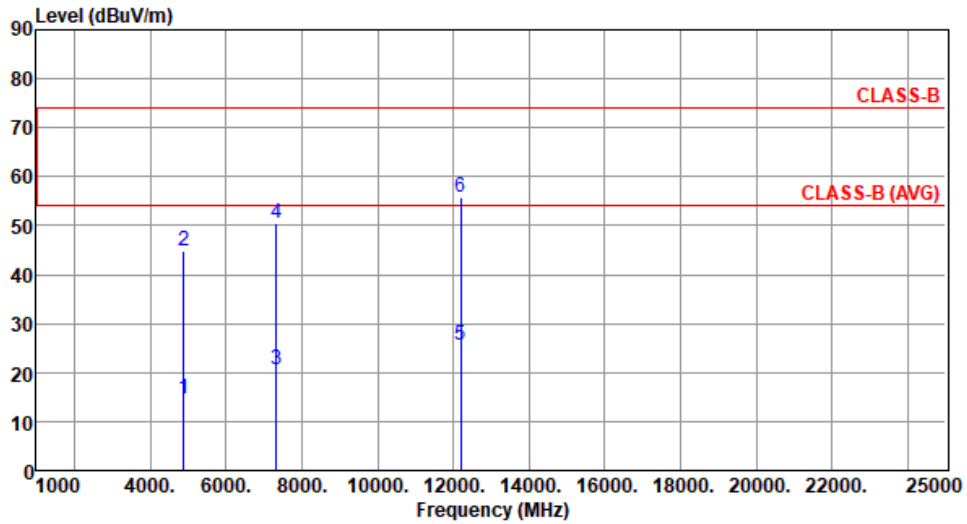

	Freq. MHz	Emission level dBuV/m	Limit dBuV/m	Margin dB	SA reading dBuV	Factor dB/m	Remark	ANT High cm	Turn Table deg
1	4882.00	14.70	54.00	-39.30			Average	100	218
2	4882.00	44.80	74.00	-29.20	45.05	-0.25	Peak	100	218
3	7323.00	20.50	54.00	-33.50			Average	100	205
4	7323.00	50.60	74.00	-23.40	45.18	5.42	Peak	100	205
5	12205.00	25.56	54.00	-28.44			Average	100	241
6	12205.00	55.66	74.00	-18.34	49.13	6.53	Peak	100	241

Note 1: Emission Level (dBuV/m) = SA Reading (dBuV) + Factor* (dB/m)

*Factor includes antenna factor , cable loss and amplifier gain

Note 2: Margin (dB) = Emission level (dBuV/m) – Limit (dBuV/m).

Note 3: When average value is calculated not measured, no SA reading and factor value are listed.



Unwanted Radiated Emissions into Restricted Frequency Bands

Appendix A.7

Modulation	GFSK	Test Freq. (MHz)	2480
-------------------	------	-------------------------	------

Polarization	Horizontal
---------------------	------------

Test By : Sean Yu Temperature(°C): 26 Humidity(%): 61

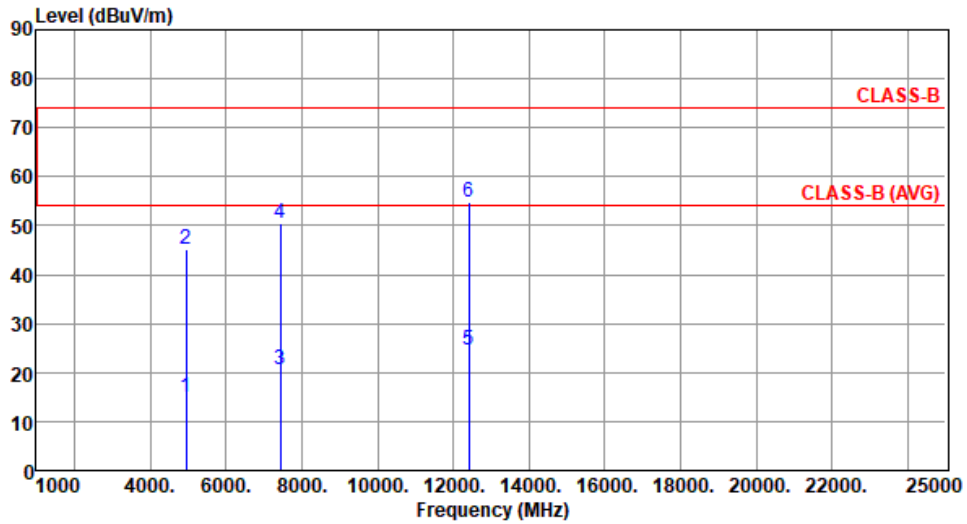

	Freq. MHz	Emission level dBuV/m	Limit dBuV/m	Margin dB	SA reading dBuV	Factor dB/m	Remark	ANT High cm	Turn Table deg
1	4960.00	14.94	54.00	-39.06			Average	100	234
2	4960.00	45.04	74.00	-28.96	45.15	-0.11	Peak	100	234
3	7440.00	20.51	54.00	-33.49			Average	100	227
4	7440.00	50.61	74.00	-23.39	45.24	5.37	Peak	100	227
5	12400.00	24.68	54.00	-29.32			Average	100	168
6	12400.00	54.78	74.00	-19.22	48.48	6.30	Peak	100	168

Note 1: Emission Level (dBuV/m) = SA Reading (dBuV) + Factor* (dB/m)

*Factor includes antenna factor , cable loss and amplifier gain

Note 2: Margin (dB) = Emission level (dBuV/m) – Limit (dBuV/m).

Note 3: When average value is calculated not measured, no SA reading and factor value are listed.



Unwanted Radiated Emissions into Restricted Frequency Bands

Appendix A.7

Modulation	GFSK	Test Freq. (MHz)	2480
-------------------	------	-------------------------	------

Polarization	Vertical
---------------------	----------

Test By : Sean Yu Temperature(°C): 26 Humidity(%): 61

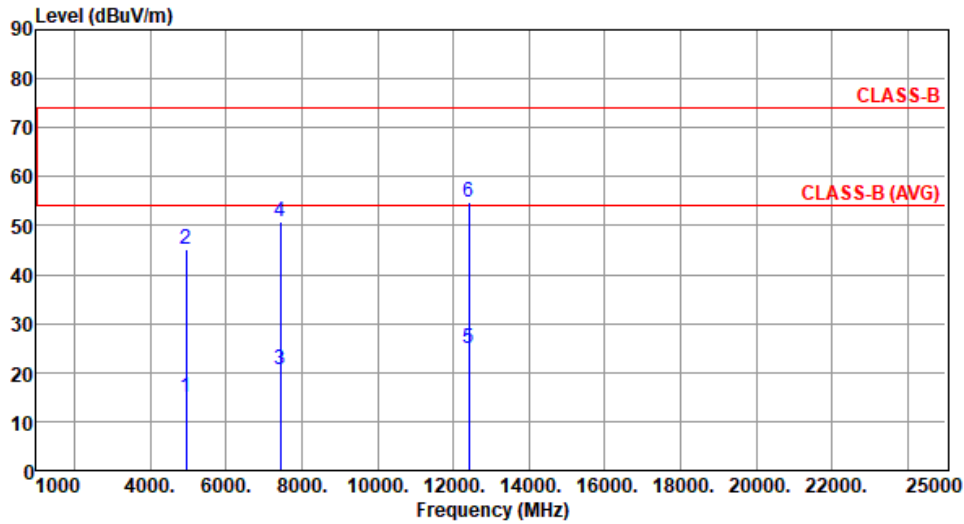

	Freq. MHz	Emission level dBuV/m	Limit dBuV/m	Margin dB	SA reading dBuV	Factor dB/m	Remark	ANT High cm	Turn Table deg
1	4960.00	14.96	54.00	-39.04			Average	100	175
2	4960.00	45.06	74.00	-28.94	45.17	-0.11	Peak	100	175
3	7440.00	20.71	54.00	-33.29			Average	100	105
4	7440.00	50.81	74.00	-23.19	45.44	5.37	Peak	100	105
5	12400.00	24.78	54.00	-29.22			Average	100	284
6	12400.00	54.88	74.00	-19.12	48.58	6.30	Peak	100	284

Note 1: Emission Level (dBuV/m) = SA Reading (dBuV) + Factor* (dB/m)

*Factor includes antenna factor , cable loss and amplifier gain

Note 2: Margin (dB) = Emission level (dBuV/m) – Limit (dBuV/m).

Note 3: When average value is calculated not measured, no SA reading and factor value are listed.



Emissions (Above 1GHz) for 8DPSK

Modulation	8DPSK	Test Freq. (MHz)	2402
Polarization	Horizontal		

Test By :Sean Yu Temperature(°C):26 Humidity(%):61

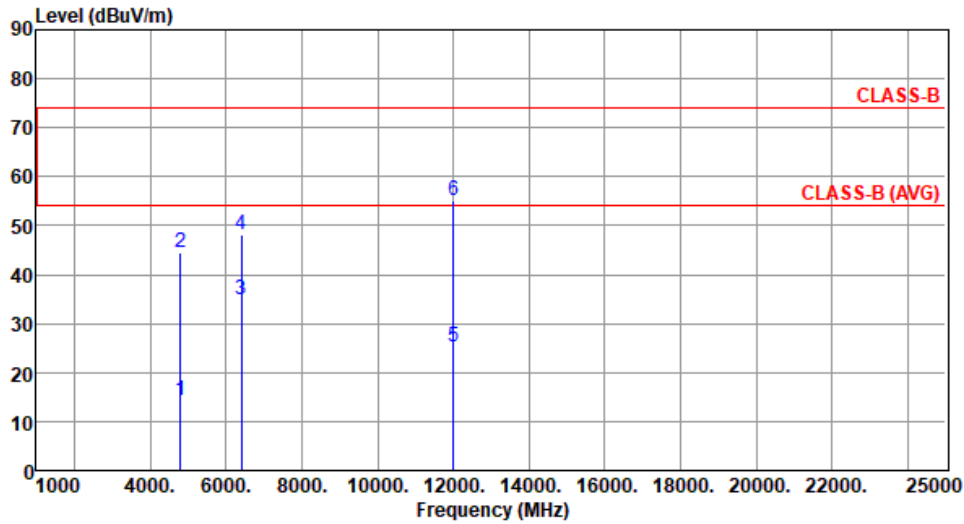

	Freq. MHz	Emission level dBuV/m	Limit dBuV/m	Margin dB	SA reading dBuV	Factor dB/m	Remark	ANT High cm	Turn Table deg
1	4804.00	14.38	54.00	-39.62			Average	100	204
2	4804.00	44.48	74.00	-29.52	44.75	-0.27	Peak	100	204
3	6405.33	35.01	54.00	-18.99	32.41	2.60	Average	100	253
4	6405.33	48.13	74.00	-25.87	45.53	2.60	Peak	100	253
5	12010.00	25.17	54.00	-28.83			Average	100	184
6	12010.00	55.27	74.00	-18.73	48.75	6.52	Peak	100	184

Note 1: Emission Level (dBuV/m) = SA Reading (dBuV) + Factor* (dB/m)
 *Factor includes antenna factor , cable loss and amplifier gain
 Note 2: Margin (dB) = Emission level (dBuV/m) – Limit (dBuV/m).
 Note 3: When average value is calculated not measured, no SA reading and factor value are listed.



Unwanted Radiated Emissions into Restricted Frequency Bands

Appendix A.7

Modulation	8DPSK	Test Freq. (MHz)	2402
------------	-------	------------------	------

Polarization	Vertical
--------------	----------

Test By : Sean Yu Temperature(°C): 26 Humidity(%): 61

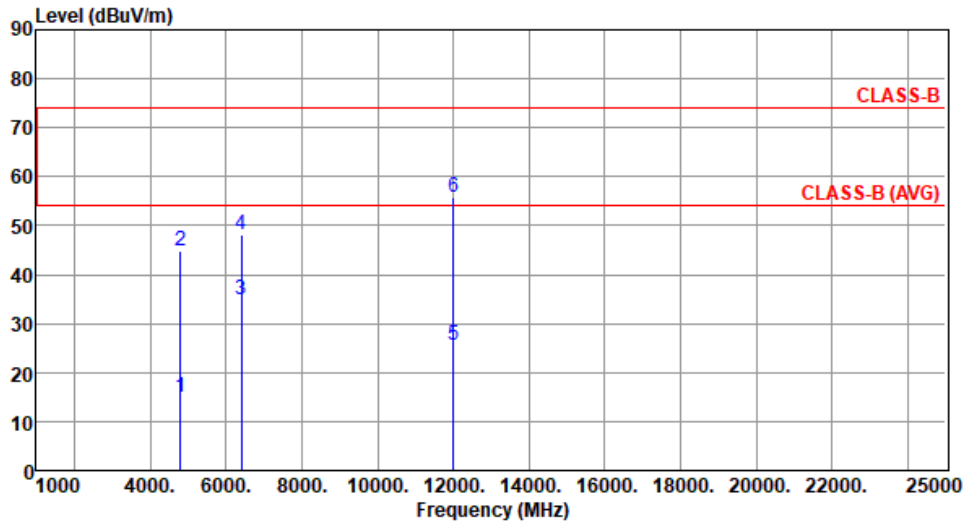

	Freq. MHz	Emission level dBuV/m	Limit dBuV/m	Margin dB	SA reading dBuV	Factor dB/m	Remark	ANT High cm	Turn Table deg
1	4804.00	14.78	54.00	-39.22			Average	100	183
2	4804.00	44.88	74.00	-29.12	45.15	-0.27	Peak	100	183
3	6405.33	34.95	54.00	-19.05	32.35	2.60	Average	100	188
4	6405.33	48.05	74.00	-25.95	45.45	2.60	Peak	100	188
5	12010.00	25.54	54.00	-28.46			Average	100	200
6	12010.00	55.64	74.00	-18.36	49.12	6.52	Peak	100	200

Note 1: Emission Level (dBuV/m) = SA Reading (dBuV) + Factor* (dB/m)

*Factor includes antenna factor , cable loss and amplifier gain

Note 2: Margin (dB) = Emission level (dBuV/m) – Limit (dBuV/m).

Note 3: When average value is calculated not measured, no SA reading and factor value are listed.



Unwanted Radiated Emissions into Restricted Frequency Bands

Appendix A.7

Modulation	8DPSK	Test Freq. (MHz)	2441
------------	-------	------------------	------

Polarization	Horizontal
--------------	------------

Test By : Sean Yu Temperature(°C): 26 Humidity(%): 61

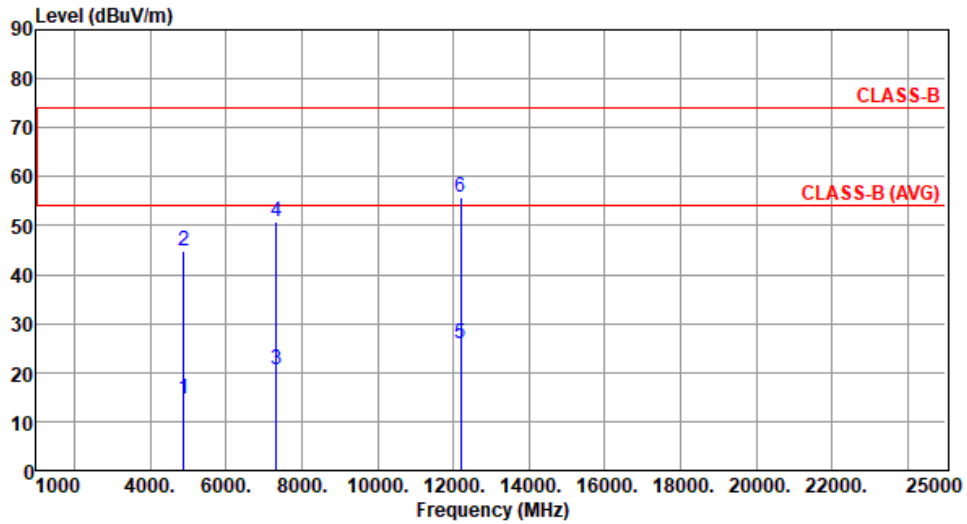

	Freq. MHz	Emission level dBuV/m	Limit dBuV/m	Margin dB	SA reading dBuV	Factor dB/m	Remark	ANT High cm	Turn Table deg
1	4882.00	14.77	54.00	-39.23			Average	100	108
2	4882.00	44.87	74.00	-29.13	45.12	-0.25	Peak	100	108
3	7323.00	20.75	54.00	-33.25			Average	100	223
4	7323.00	50.85	74.00	-23.15	45.43	5.42	Peak	100	223
5	12205.00	25.75	54.00	-28.25			Average	100	235
6	12205.00	55.85	74.00	-18.15	49.32	6.53	Peak	100	235

Note 1: Emission Level (dBuV/m) = SA Reading (dBuV) + Factor* (dB/m)

*Factor includes antenna factor , cable loss and amplifier gain

Note 2: Margin (dB) = Emission level (dBuV/m) – Limit (dBuV/m).

Note 3: When average value is calculated not measured, no SA reading and factor value are listed.



Unwanted Radiated Emissions into Restricted Frequency Bands

Appendix A.7

Modulation	8DPSK	Test Freq. (MHz)	2441
-------------------	-------	-------------------------	------

Polarization	Vertical
---------------------	----------

Test By : Sean Yu Temperature(°C): 26 Humidity(%): 61

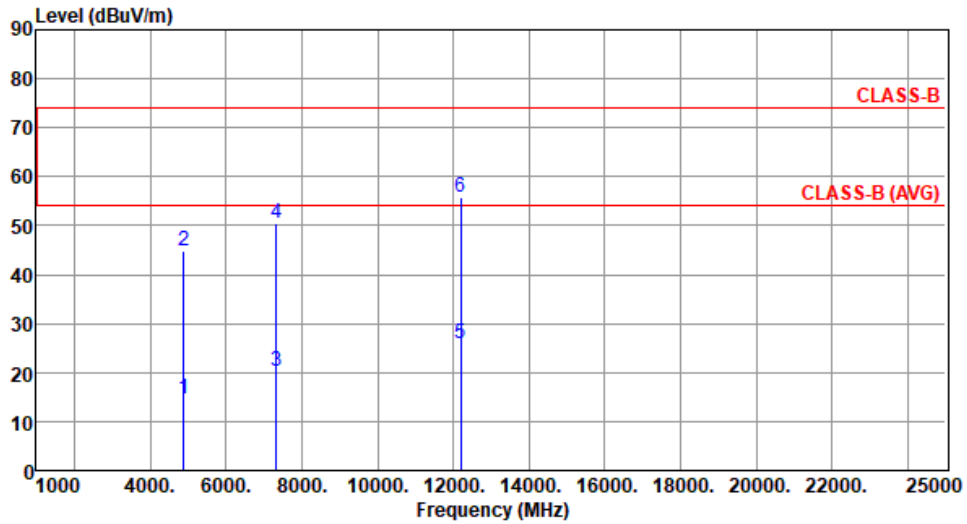

	Freq. MHz	Emission level dBuV/m	Limit dBuV/m	Margin dB	SA reading dBuV	Factor dB/m	Remark	ANT High cm	Turn Table deg
1	4882.00	14.67	54.00	-39.33			Average	100	186
2	4882.00	44.77	74.00	-29.23	45.02	-0.25	Peak	100	186
3	7323.00	20.35	54.00	-33.65			Average	100	210
4	7323.00	50.45	74.00	-23.55	45.03	5.42	Peak	100	210
5	12205.00	25.76	54.00	-28.24			Average	100	285
6	12205.00	55.86	74.00	-18.14	49.33	6.53	Peak	100	285

Note 1: Emission Level (dBuV/m) = SA Reading (dBuV) + Factor* (dB/m)

*Factor includes antenna factor , cable loss and amplifier gain

Note 2: Margin (dB) = Emission level (dBuV/m) – Limit (dBuV/m).

Note 3: When average value is calculated not measured, no SA reading and factor value are listed.



Unwanted Radiated Emissions into Restricted Frequency Bands

Appendix A.7

Modulation	8DPSK	Test Freq. (MHz)	2480
-------------------	-------	-------------------------	------

Polarization	Horizontal
---------------------	------------

Test By : Sean Yu Temperature(°C): 26 Humidity(%): 61

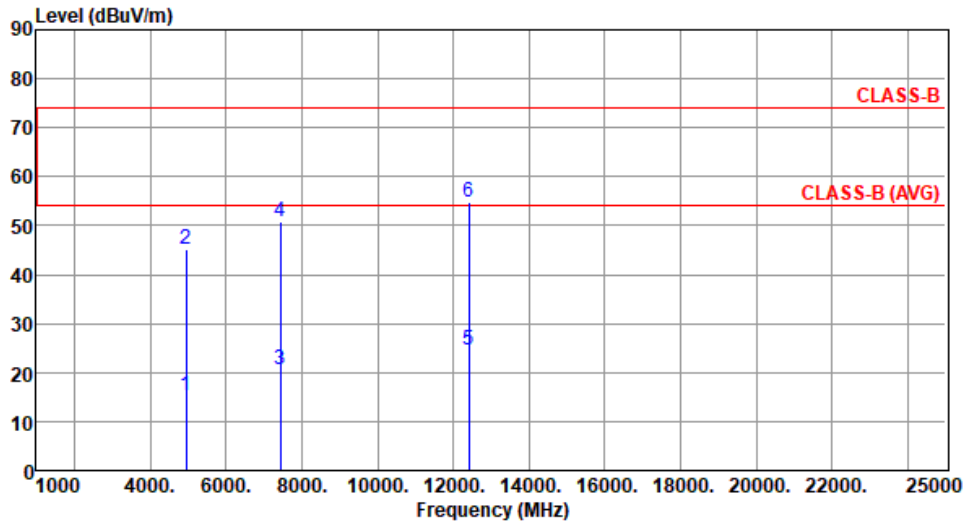

	Freq. MHz	Emission level dBuV/m	Limit dBuV/m	Margin dB	SA reading dBuV	Factor dB/m	Remark	ANT High cm	Turn Table deg
1	4960.00	15.15	54.00	-38.85			Average	100	210
2	4960.00	45.25	74.00	-28.75	45.36	-0.11	Peak	100	210
3	7440.00	20.58	54.00	-33.42			Average	100	143
4	7440.00	50.68	74.00	-23.32	45.31	5.37	Peak	100	143
5	12400.00	24.73	54.00	-29.27			Average	100	203
6	12400.00	54.83	74.00	-19.17	48.53	6.30	Peak	100	203

Note 1: Emission Level (dBuV/m) = SA Reading (dBuV) + Factor* (dB/m)

*Factor includes antenna factor , cable loss and amplifier gain

Note 2: Margin (dB) = Emission level (dBuV/m) – Limit (dBuV/m).

Note 3: When average value is calculated not measured, no SA reading and factor value are listed.



Unwanted Radiated Emissions into Restricted Frequency Bands

Appendix A.7

Modulation	8DPSK	Test Freq. (MHz)	2480
Polarization	Vertical		

Test By : Sean Yu Temperature(°C): 26 Humidity(%): 61

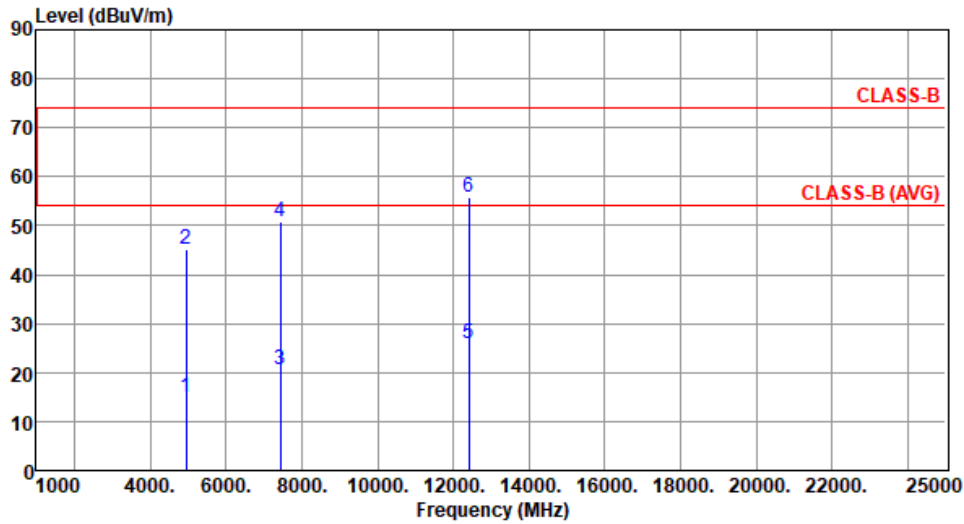

	Freq. MHz	Emission level dBuV/m	Limit dBuV/m	Margin dB	SA reading dBuV	Factor dB/m	Remark	ANT High cm	Turn Table deg
1	4960.00	15.11	54.00	-38.89			Average	100	222
2	4960.00	45.21	74.00	-28.79	45.32	-0.11	Peak	100	222
3	7440.00	20.55	54.00	-33.45			Average	100	123
4	7440.00	50.65	74.00	-23.35	45.28	5.37	Peak	100	123
5	12400.00	25.83	54.00	-28.17			Average	100	272
6	12400.00	55.93	74.00	-18.07	49.63	6.30	Peak	100	272

Note 1: Emission Level (dBuV/m) = SA Reading (dBuV) + Factor* (dB/m)

*Factor includes antenna factor , cable loss and amplifier gain

Note 2: Margin (dB) = Emission level (dBuV/m) – Limit (dBuV/m).

Note 3: When average value is calculated not measured, no SA reading and factor value are listed.



ST Module

Emissions (Below 1GHz)

Modulation	8DPSK	Test Freq. (MHz)	2402
Polarization	Horizontal		

Test By : Sean Yu Temperature(°C): 26 Humidity(%): 61

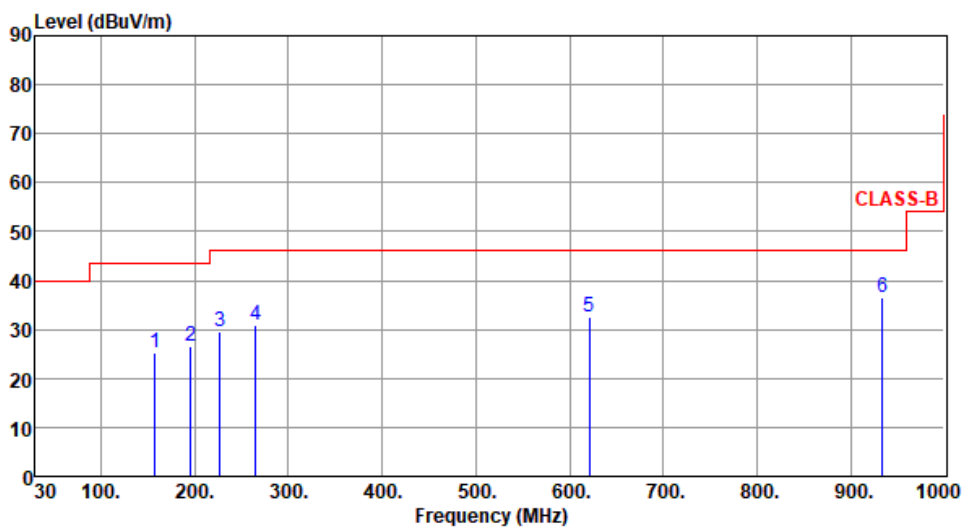

	Freq. MHz	Emission level dBUV/m	Limit dBUV/m	Margin dB	SA reading dBUV	Factor dB/m	Remark	ANT High cm	Turn Table deg
1	158.04	25.39	43.50	-18.11	34.03	-8.64	Peak	---	---
2	195.87	26.48	43.50	-17.02	38.09	-11.61	Peak	---	---
3	226.91	29.41	46.00	-16.59	41.24	-11.83	Peak	---	---
4	264.74	30.73	46.00	-15.27	40.04	-9.31	Peak	---	---
5	620.73	32.47	46.00	-13.53	32.56	-0.09	Peak	---	---
6	934.04	36.51	46.00	-9.49	31.46	5.05	Peak	---	---

Note 1: Emission Level (dBUV/m) = SA Reading (dBUV) + Factor* (dB/m)

*Factor includes antenna factor , cable loss and amplifier gain

Note 2: Margin (dB) = Emission level (dBUV/m) – Limit (dBUV/m).

Note 3: All spurious emissions below 30MHz are more than 20 dB below the limit.



Unwanted Radiated Emissions into Restricted Frequency Bands

Appendix A.7

Modulation	8DPSK	Test Freq. (MHz)	2402
Polarization	Vertical		

Test By : Sean Yu Temperature(°C): 26 Humidity(%): 61

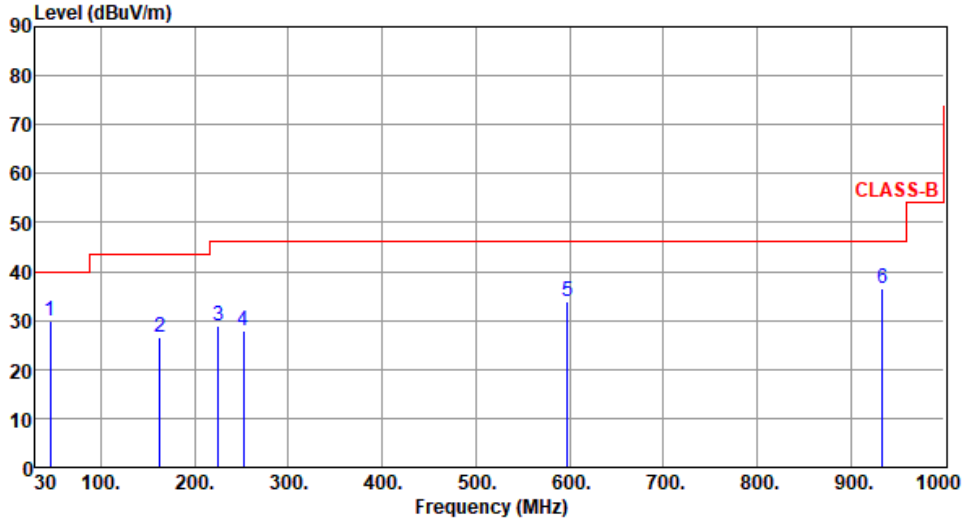

	Freq. MHz	Emission level dBuV/m	Limit dBuV/m	Margin dB	SA reading dBuV	Factor dB/m	Remark	ANT High cm	Turn Table deg
1	45.52	29.83	40.00	-10.17	37.89	-8.06	Peak	---	---
2	162.89	26.49	43.50	-17.01	35.33	-8.84	Peak	---	---
3	224.97	28.94	46.00	-17.06	40.98	-12.04	Peak	---	---
4	252.13	27.90	46.00	-18.10	37.80	-9.90	Peak	---	---
5	597.45	33.95	46.00	-12.05	34.69	-0.74	Peak	---	---
6	934.04	36.61	46.00	-9.39	31.56	5.05	Peak	---	---

Note 1: Emission Level (dBuV/m) = SA Reading (dBuV) + Factor* (dB/m)

*Factor includes antenna factor , cable loss and amplifier gain

Note 2: Margin (dB) = Emission level (dBuV/m) – Limit (dBuV/m).

Note 3: All spurious emissions below 30MHz are more than 20 dB below the limit.



Emissions (Above 1GHz)

Modulation	8DPSK	Test Freq. (MHz)	2480
Polarization	Horizontal		

Test By : Sean Yu Temperature(°C): 26 Humidity(%): 61

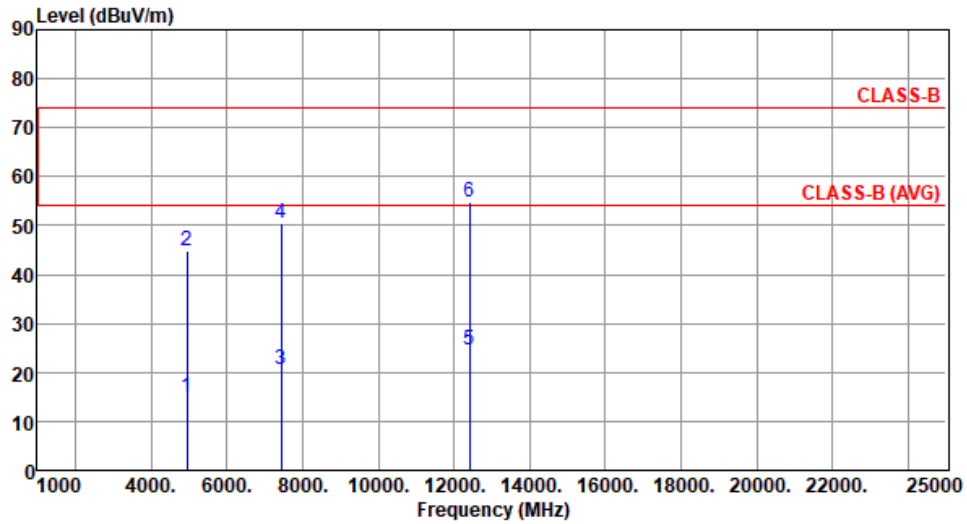

	Freq. MHz	Emission level dBuV/m	Limit dBuV/m	Margin dB	SA reading dBuV	Factor dB/m	Remark	ANT High cm	Turn Table deg
1	4960.00	14.86	54.00	-39.14			Average	100	135
2	4960.00	44.96	74.00	-29.04	45.07	-0.11	Peak	100	135
3	7440.00	20.46	54.00	-33.54			Average	100	157
4	7440.00	50.56	74.00	-23.44	45.19	5.37	Peak	100	157
5	12400.00	24.70	54.00	-29.30			Average	100	227
6	12400.00	54.80	74.00	-19.20	48.50	6.30	Peak	100	227

Note 1: Emission Level (dBuV/m) = SA Reading (dBuV) + Factor* (dB/m)

*Factor includes antenna factor , cable loss and amplifier gain

Note 2: Margin (dB) = Emission level (dBuV/m) – Limit (dBuV/m).

Note 3: When average value is calculated not measured, no SA reading and factor value are listed.



Unwanted Radiated Emissions into Restricted Frequency Bands

Appendix A.7

Modulation	8DPSK	Test Freq. (MHz)	2480
Polarization	Vertical		

Test By : Sean Yu Temperature(°C): 26 Humidity(%): 61

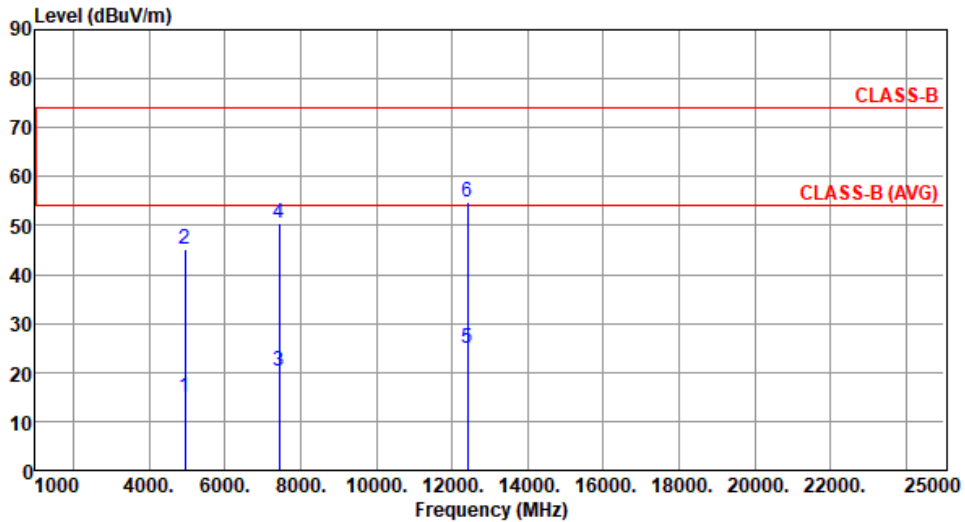

	Freq. MHz	Emission level dBuV/m	Limit dBuV/m	Margin dB	SA reading dBuV	Factor dB/m	Remark	ANT High cm	Turn Table deg
1	4960.00	14.97	54.00	-39.03			Average	100	208
2	4960.00	45.07	74.00	-28.93	45.18	-0.11	Peak	100	108
3	7440.00	20.41	54.00	-33.59			Average	100	125
4	7440.00	50.51	74.00	-23.49	45.14	5.37	Peak	100	125
5	12400.00	24.75	54.00	-29.25			Average	100	277
6	12400.00	54.85	74.00	-19.15	48.55	6.30	Peak	100	277

Note 1: Emission Level (dBuV/m) = SA Reading (dBuV) + Factor* (dB/m)

*Factor includes antenna factor , cable loss and amplifier gain

Note 2: Margin (dB) = Emission level (dBuV/m) – Limit (dBuV/m).

Note 3: When average value is calculated not measured, no SA reading and factor value are listed.

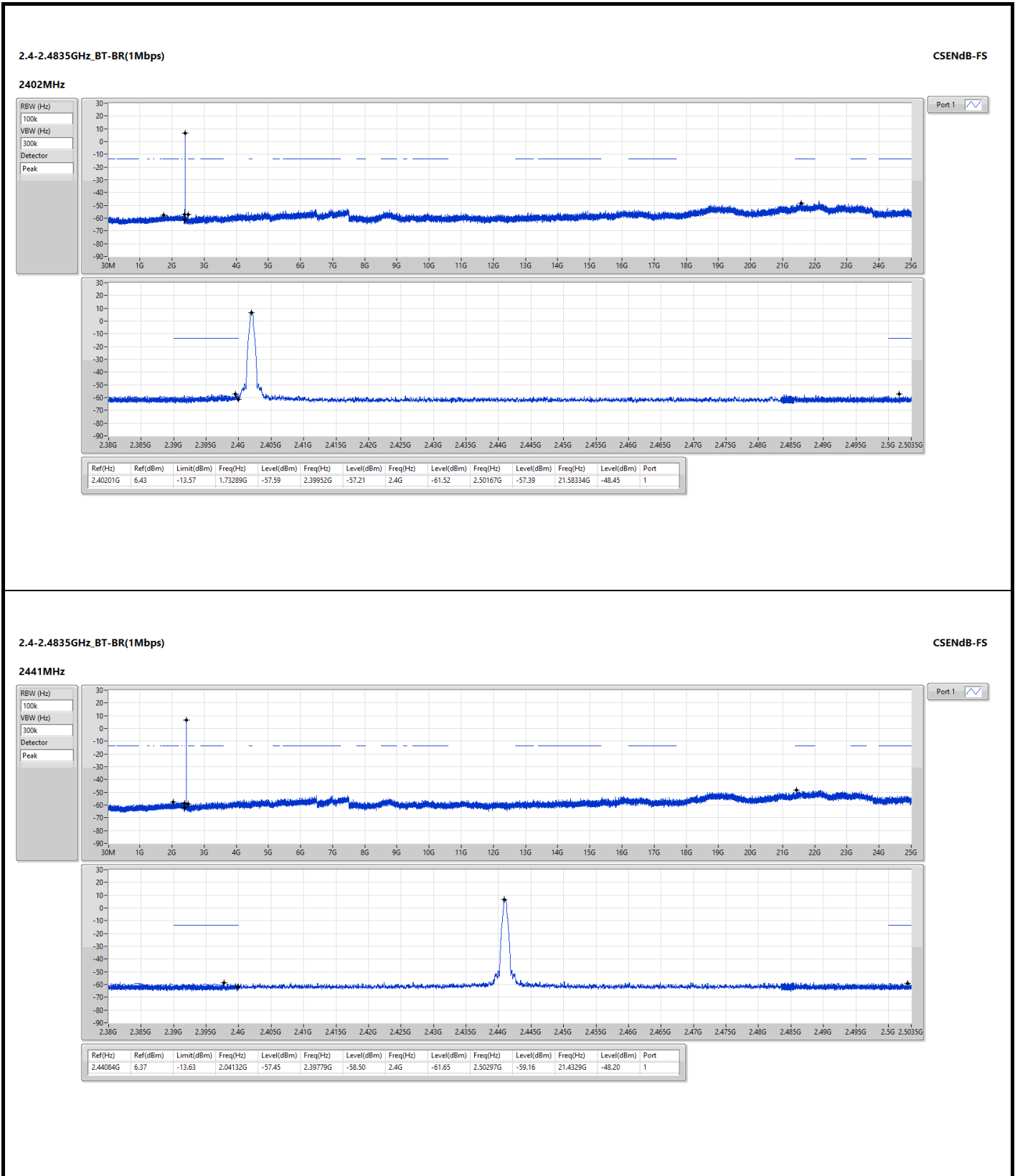

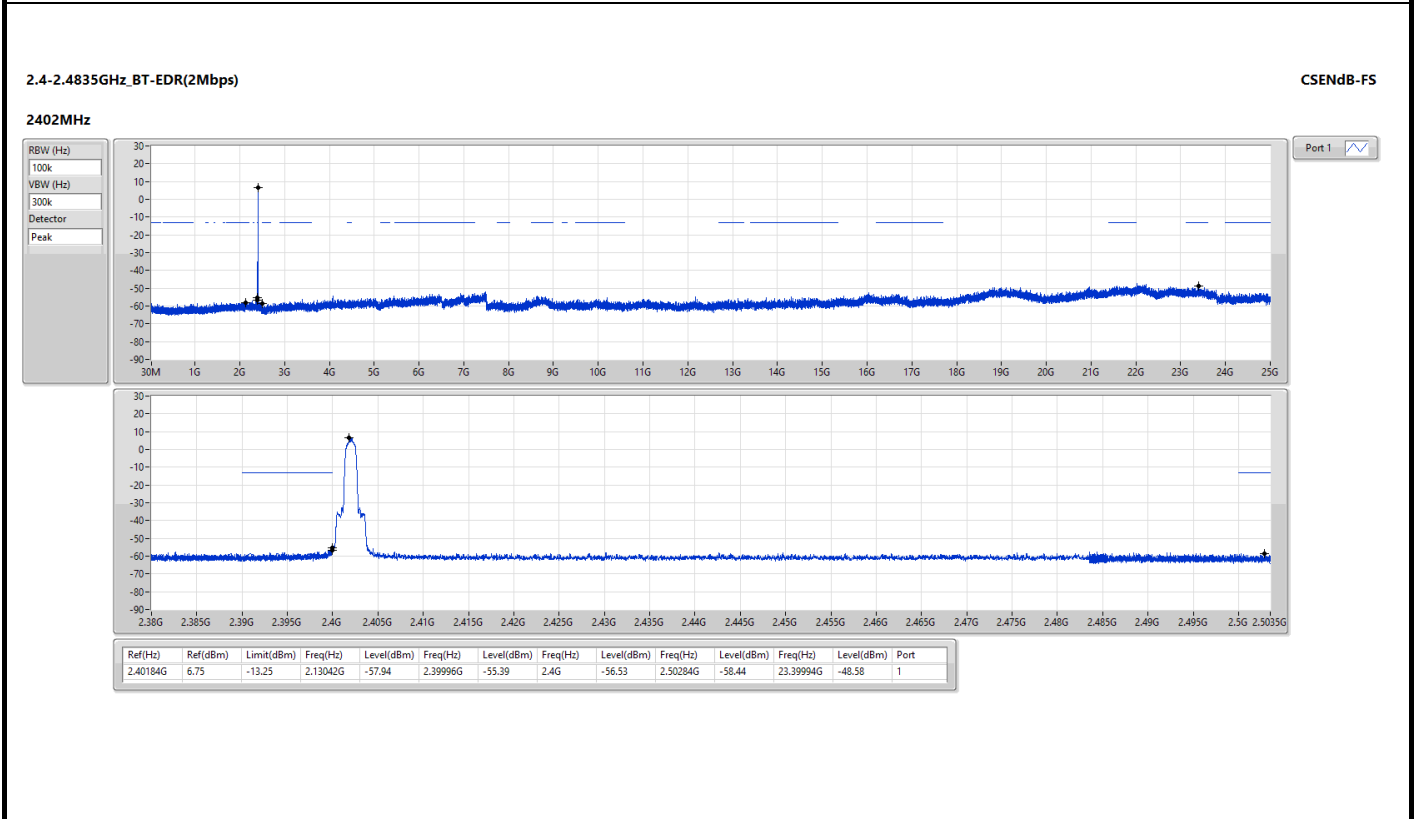
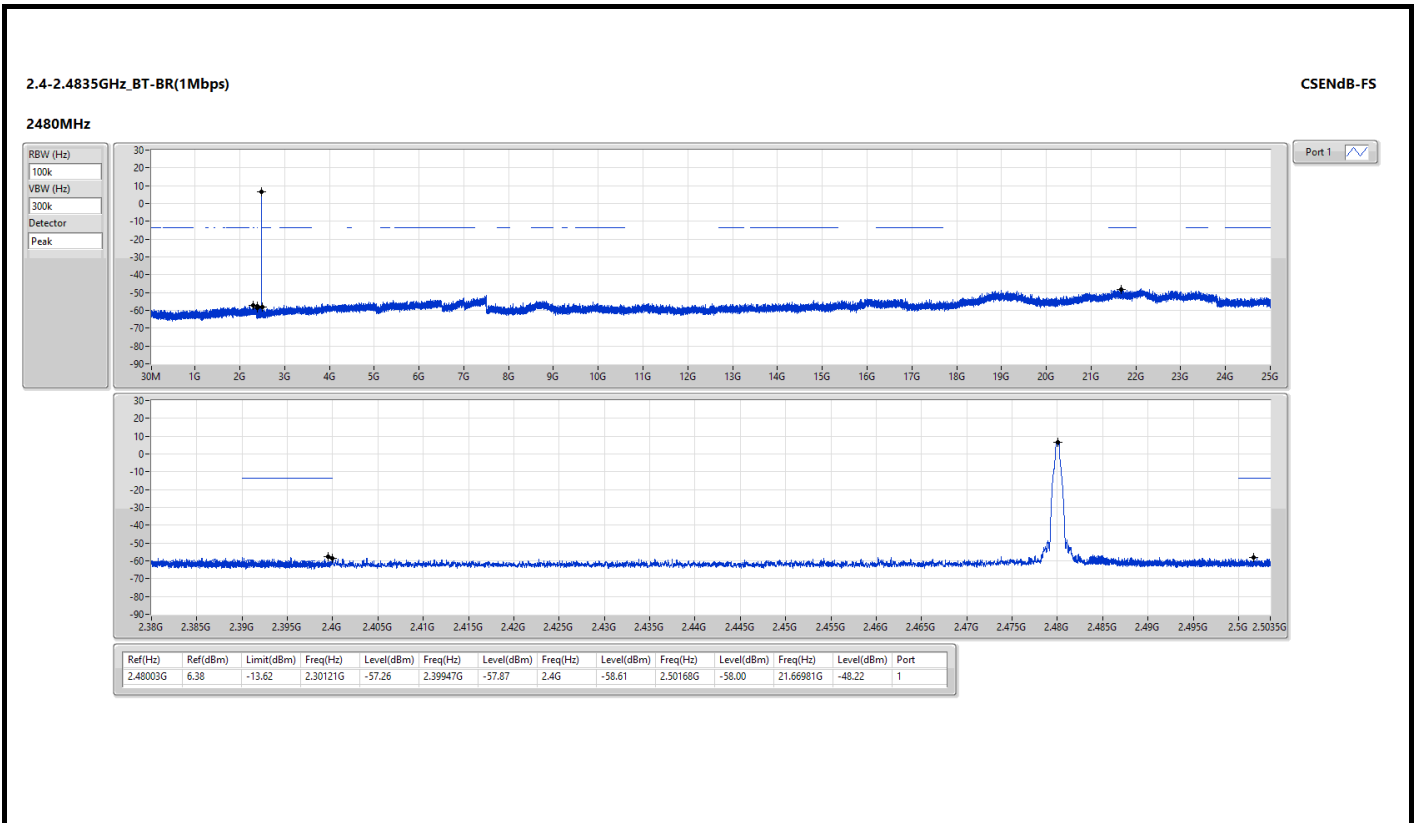

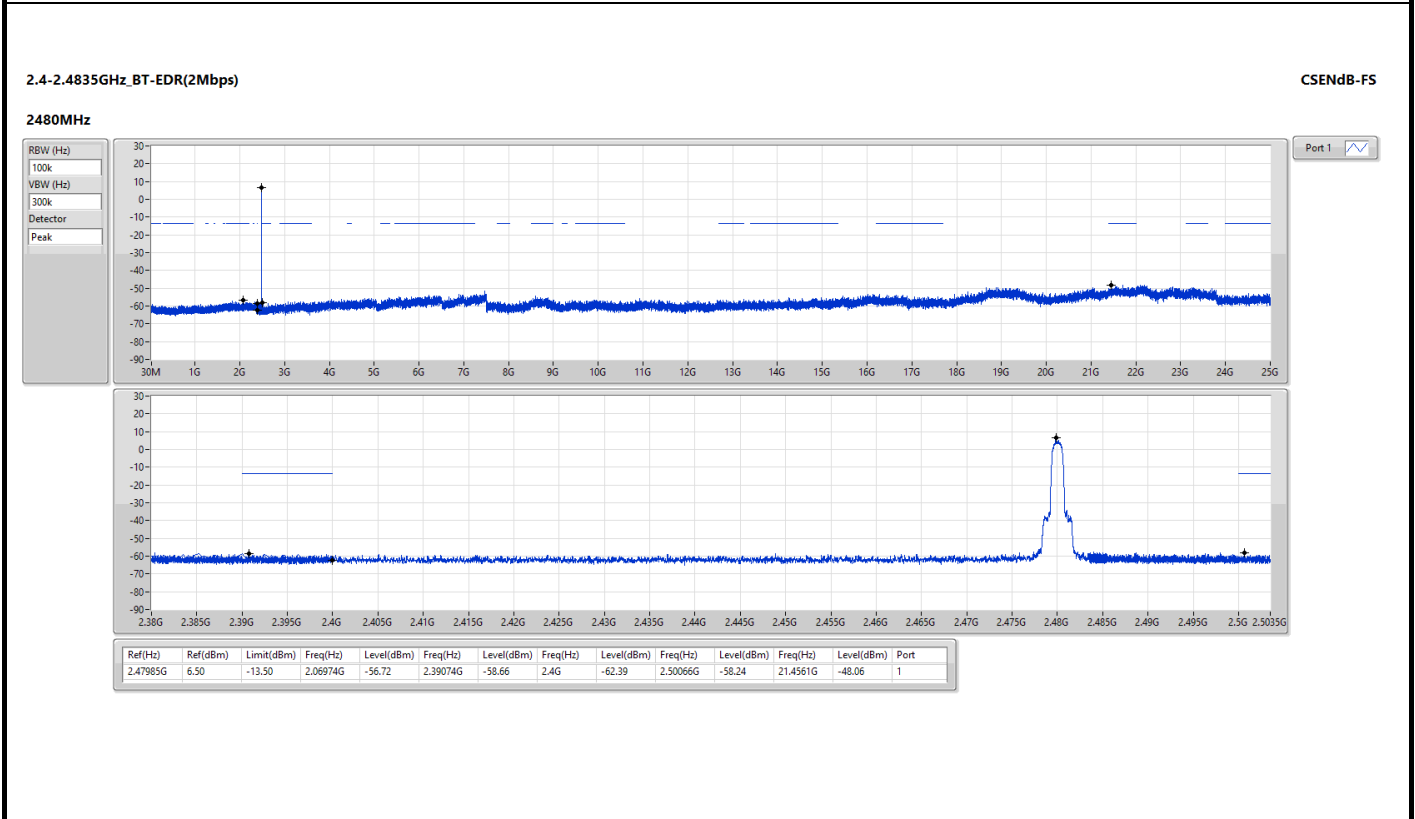
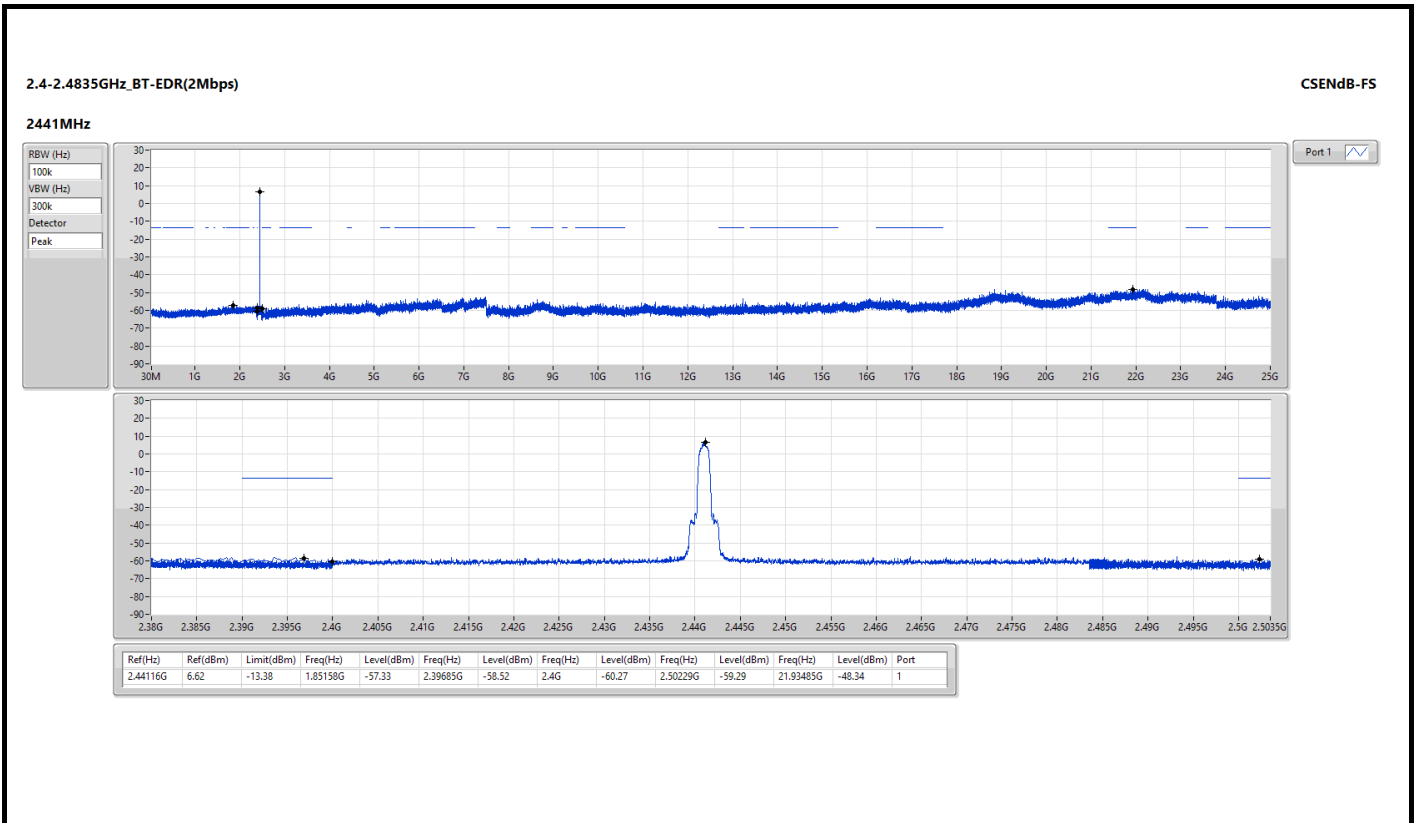

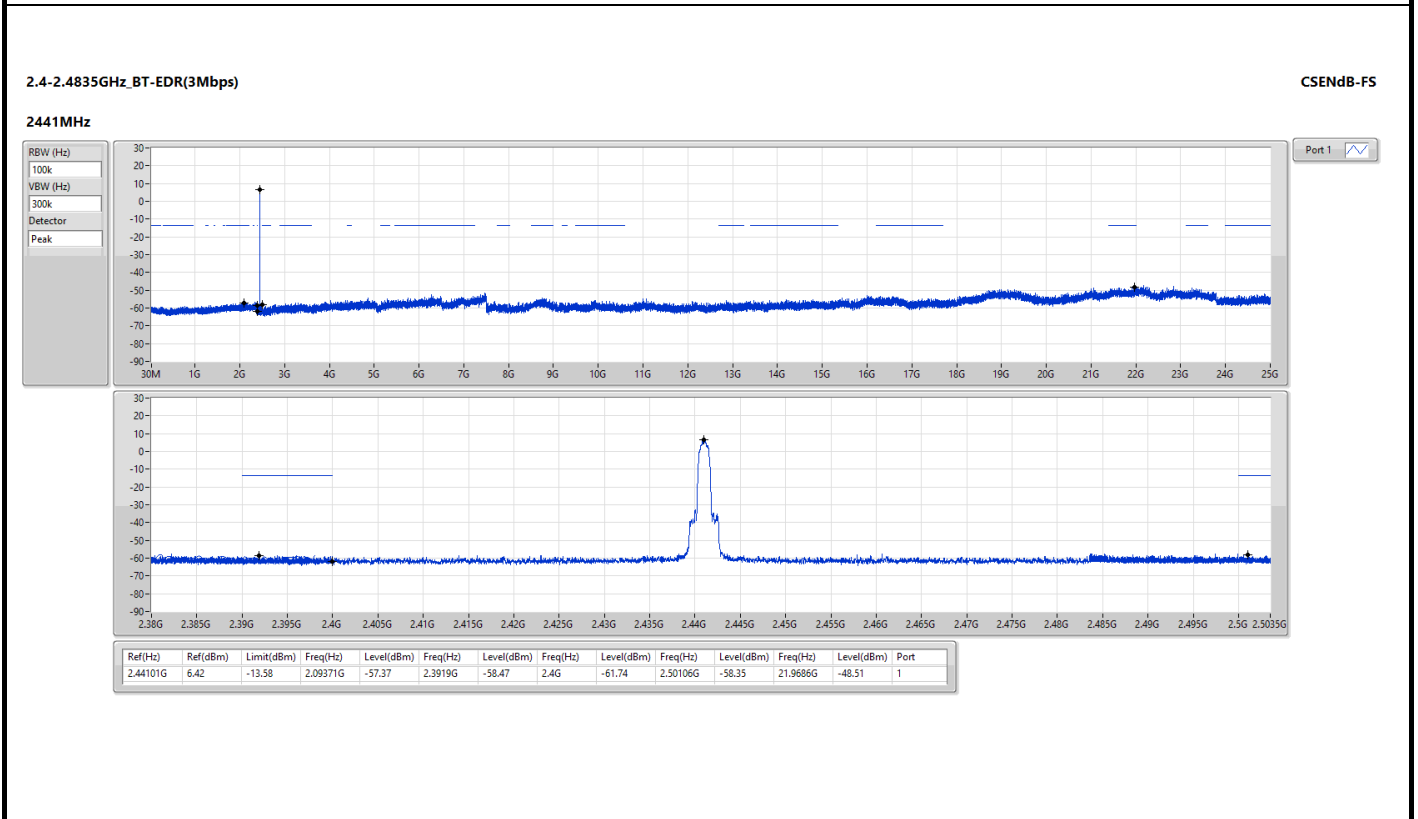
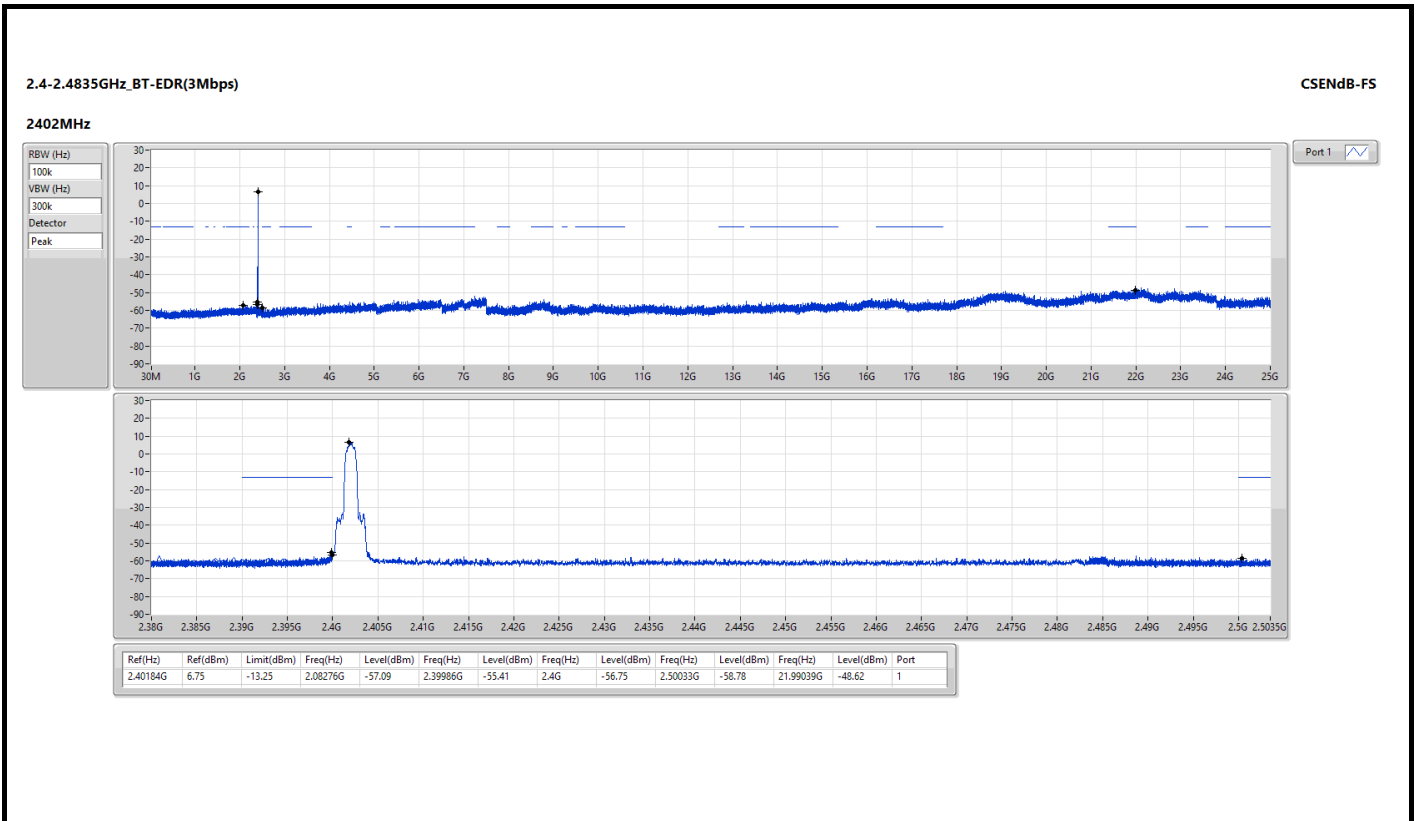

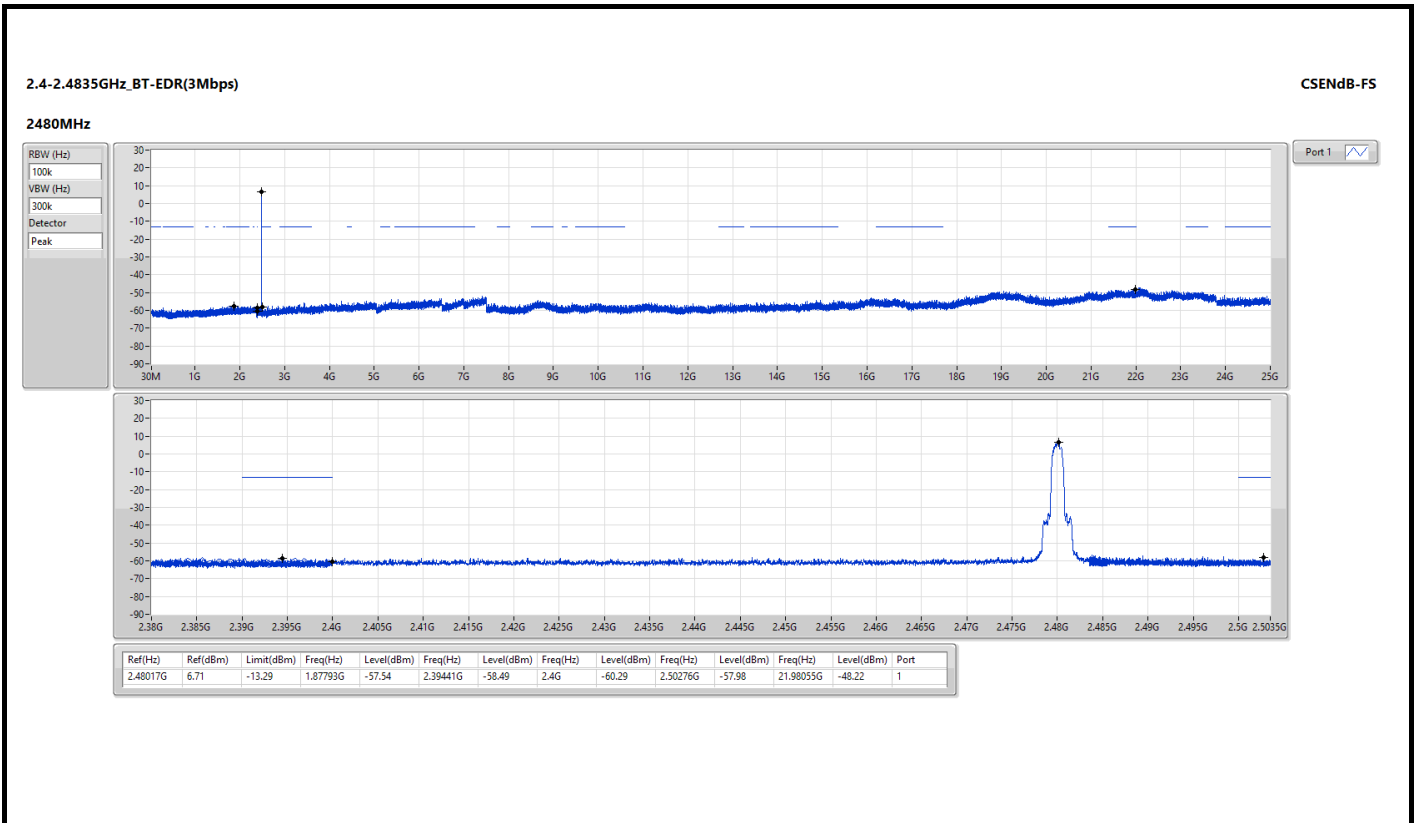

2.4-2.4835GHz_BT-BR(1Mbps)

2402MHz

Hopping Ch Bandedge (Non-restricted Band)

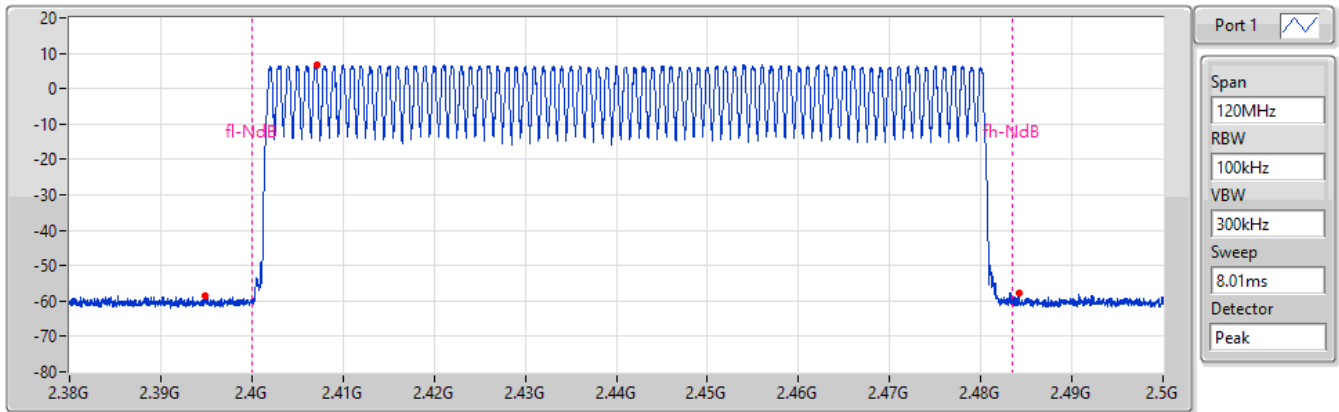

2.4-2.4835GHz_BT-EDR(2Mbps)

2402MHz

Hopping Ch Bandedge (Non-restricted Band)

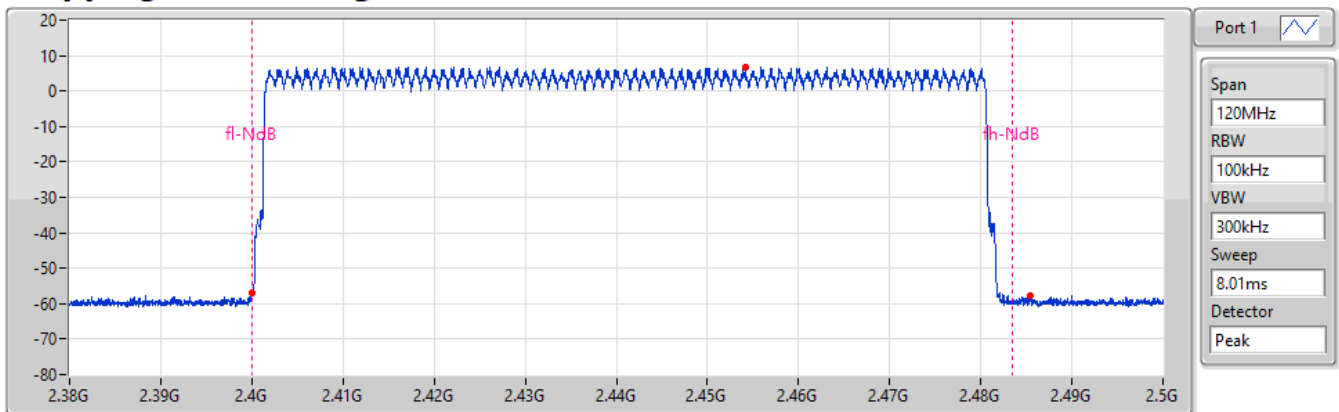

2.4-2.4835GHz_BT-EDR(3Mbps)

2402MHz

Hopping Ch Bandedge (Non-restricted Band)

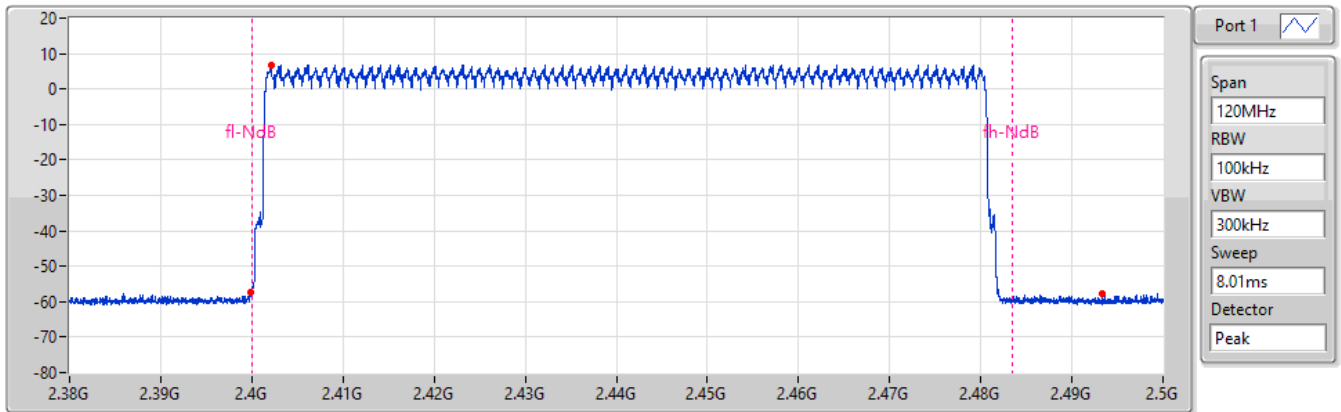

Limit(dBm)	Ref(Hz)	Ref(dBm)	BE-l(Hz)	BE-l(dBm)	BE-h(Hz)	BE-h(dBm)
-13.12	2.402155G	6.88	2.39986G	-57.53	2.49334G	-57.67



Summary

Mode	Total Power (dBm)	Power (W)
2.4-2.4835GHz	-	-
BT-BR(1Mbps)	6.92	0.00492
BT-EDR(2Mbps)	9.28	0.00847
BT-EDR(3Mbps)	9.63	0.00918

Result

Mode	Result	Antenna Gain (dBi)	Total Power (dBm)	Power Limit (dBm)	EIRP (dBm)	EIRP Limit (dBm)
BT-BR(1Mbps)	-	-	-	-	-	-
2402MHz	Pass	2.40	6.92	21.00	9.32	27.00
2441MHz	Pass	2.40	6.66	21.00	9.06	27.00
2480MHz	Pass	2.40	6.69	21.00	9.09	27.00
BT-EDR(2Mbps)	-	-	-	-	-	-
2402MHz	Pass	2.40	9.28	21.00	11.68	27.00
2441MHz	Pass	2.40	9.03	21.00	11.43	27.00
2480MHz	Pass	2.40	9.01	21.00	11.41	27.00
BT-EDR(3Mbps)	-	-	-	-	-	-
2402MHz	Pass	2.40	9.63	21.00	12.03	27.00
2441MHz	Pass	2.40	9.39	21.00	11.79	27.00
2480MHz	Pass	2.40	9.37	21.00	11.77	27.00

DG = Directional Gain; Port X = Port X output power



Summary

Mode	Total Power (dBm)	Power (W)
2.4-2.4835GHz	-	-
BT-BR(1Mbps)	6.53	0.00450
BT-EDR(2Mbps)	6.68	0.00466
BT-EDR(3Mbps)	6.68	0.00466

Result

Mode	Result	Antenna Gain (dBi)	Total Power (dBm)	Power Limit (dBm)	EIRP (dBm)	EIRP Limit (dBm)
BT-BR(1Mbps)	-	-	-	-	-	-
2402MHz	Pass	2.40	6.53	-	8.93	-
2441MHz	Pass	2.40	6.23	-	8.63	-
2480MHz	Pass	2.40	6.28	-	8.68	-
BT-EDR(2Mbps)	-	-	-	-	-	-
2402MHz	Pass	2.40	6.68	-	9.08	-
2441MHz	Pass	2.40	6.38	-	8.78	-
2480MHz	Pass	2.40	6.37	-	8.77	-
BT-EDR(3Mbps)	-	-	-	-	-	-
2402MHz	Pass	2.40	6.68	-	9.08	-
2441MHz	Pass	2.40	6.39	-	8.79	-
2480MHz	Pass	2.40	6.38	-	8.78	-

Note: Average power is for reference only



Summary

Mode	Total Power (dBm)	Power (W)
2.4-2.4835GHz	-	-
BT-BR(1Mbps)	6.91	0.00491
BT-EDR(2Mbps)	9.27	0.00845
BT-EDR(3Mbps)	9.61	0.00914

Result

Mode	Result	Antenna Gain (dBi)	Total Power (dBm)	Power Limit (dBm)	EIRP (dBm)	EIRP Limit (dBm)
BT-BR(1Mbps)	-	-	-	-	-	-
2402MHz	Pass	2.40	6.78	21.00	9.18	27.00
2441MHz	Pass	2.40	6.73	21.00	9.13	27.00
2480MHz	Pass	2.40	6.91	21.00	9.31	27.00
BT-EDR(2Mbps)	-	-	-	-	-	-
2402MHz	Pass	2.40	9.10	21.00	11.50	27.00
2441MHz	Pass	2.40	9.08	21.00	11.48	27.00
2480MHz	Pass	2.40	9.27	21.00	11.67	27.00
BT-EDR(3Mbps)	-	-	-	-	-	-
2402MHz	Pass	2.40	9.47	21.00	11.87	27.00
2441MHz	Pass	2.40	9.46	21.00	11.86	27.00
2480MHz	Pass	2.40	9.61	21.00	12.01	27.00

DG = Directional Gain; Port X = Port X output power



Summary

Mode	Total Power (dBm)	Power (W)
2.4-2.4835GHz	-	-
BT-BR(1Mbps)	6.52	0.00449
BT-EDR(2Mbps)	6.67	0.00465
BT-EDR(3Mbps)	6.67	0.00465

Result

Mode	Result	Antenna Gain (dBi)	Total Power (dBm)	Power Limit (dBm)	EIRP (dBm)	EIRP Limit (dBm)
BT-BR(1Mbps)	-	-	-	-	-	-
2402MHz	Pass	2.40	6.41	-	8.81	-
2441MHz	Pass	2.40	6.38	-	8.78	-
2480MHz	Pass	2.40	6.52	-	8.92	-
BT-EDR(2Mbps)	-	-	-	-	-	-
2402MHz	Pass	2.40	6.48	-	8.88	-
2441MHz	Pass	2.40	6.46	-	8.86	-
2480MHz	Pass	2.40	6.67	-	9.07	-
BT-EDR(3Mbps)	-	-	-	-	-	-
2402MHz	Pass	2.40	6.48	-	8.88	-
2441MHz	Pass	2.40	6.48	-	8.88	-
2480MHz	Pass	2.40	6.67	-	9.07	-

Note: Average power is for reference only



Summary

Mode	Max-Hop No
2.4-2.4835GHz	-
BT-BR(1Mbps)	79
BT-EDR(2Mbps)	79
BT-EDR(3Mbps)	79

Result

Mode	Result	Hopping No	Limit
BT-BR(1Mbps)	-	-	-
2402MHz	Pass	79	15
BT-EDR(2Mbps)	-	-	-
2402MHz	Pass	79	15
BT-EDR(3Mbps)	-	-	-
2402MHz	Pass	79	15



2.4-2.4835GHz_BT-BR(1Mbps)

Hopping-FS

2402MHz

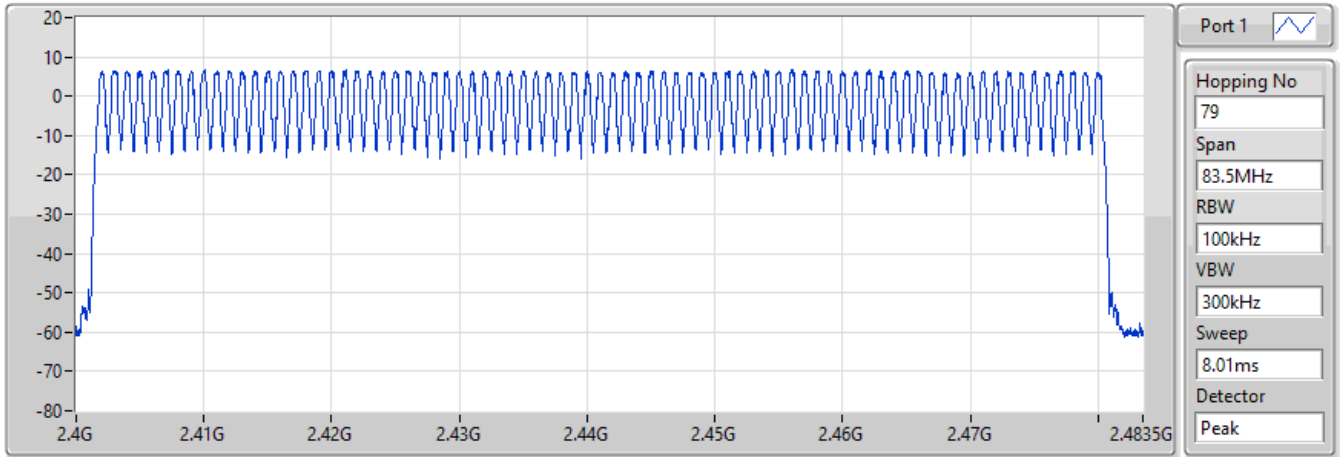

Hopping No	Limit
79	15

2.4-2.4835GHz_BT-EDR(2Mbps)

Hopping-FS

2402MHz

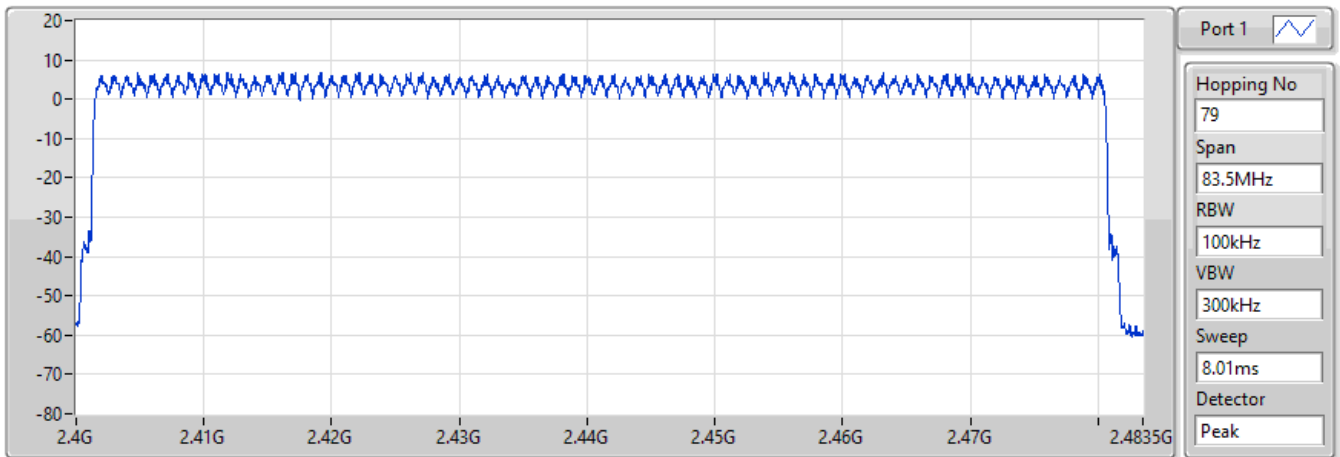

Hopping No	Limit
79	15



2.4-2.4835GHz_BT-EDR(3Mbps)

Hopping-FS

2402MHz

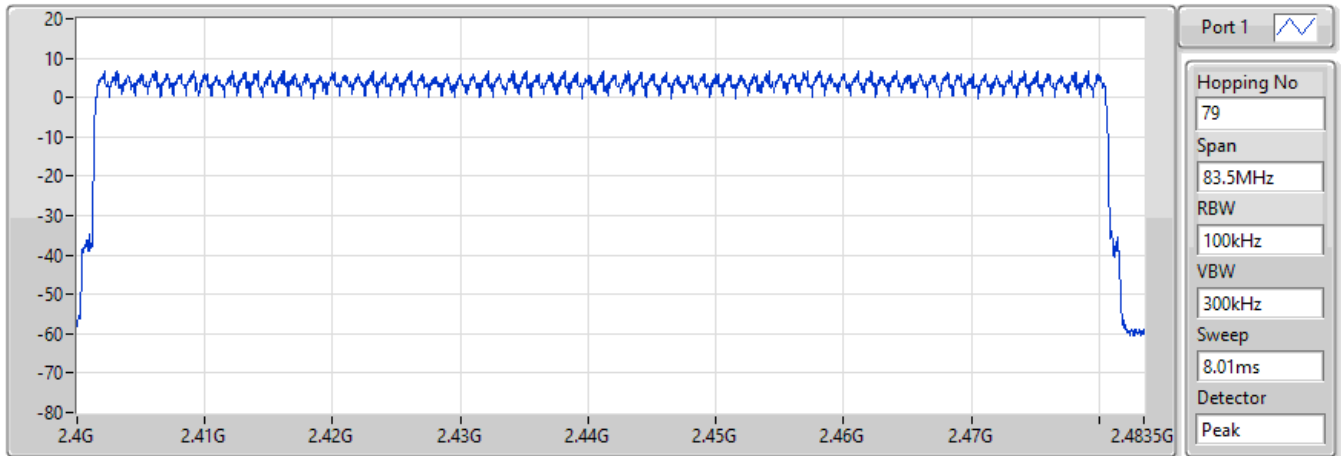

Hopping No	Limit
79	15



Summary

Mode	Max-N dB (Hz)	Max-OBW (Hz)	ITU-Code	Min-N dB (Hz)	Min-OBW (Hz)
2.4-2.4835GHz	-	-	-	-	-
BT-BR(1Mbps)	800.25k	755.036k	755KF1D	800.25k	753.291k
BT-EDR(2Mbps)	1.32M	1.182M	1M18G1D	1.284M	1.171M
BT-EDR(3Mbps)	1.29M	1.198M	1M20G1D	1.282M	1.179M

Max-N dB = Maximum 20dB down bandwidth; Max-OBW = Maximum 99% occupied bandwidth;
Min-N dB = Minimum 20dB down bandwidth; Min-OBW = Minimum 99% occupied bandwidth

Result

Mode	Result	Limit (Hz)	Port 1-N dB (Hz)	Port 1-OBW (Hz)
BT-BR(1Mbps)	-	-	-	-
2402MHz	Pass	Inf	800.25k	753.291k
2441MHz	Pass	Inf	800.25k	755.036k
2480MHz	Pass	Inf	800.25k	754.856k
BT-EDR(2Mbps)	-	-	-	-
2402MHz	Pass	Inf	1.284M	1.171M
2441MHz	Pass	Inf	1.287M	1.181M
2480MHz	Pass	Inf	1.32M	1.182M
BT-EDR(3Mbps)	-	-	-	-
2402MHz	Pass	Inf	1.282M	1.198M
2441MHz	Pass	Inf	1.29M	1.181M
2480MHz	Pass	Inf	1.282M	1.179M

Port X-N dB = Port X 20dB down bandwidth;
Port X-OBW = Port X 99% occupied bandwidth



2.4-2.4835GHz_BT-BR(1Mbps)

EBW-FS

2402MHz

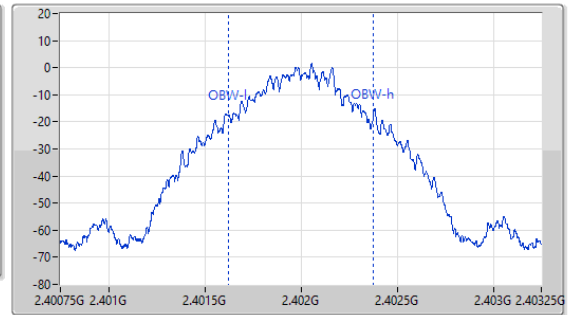
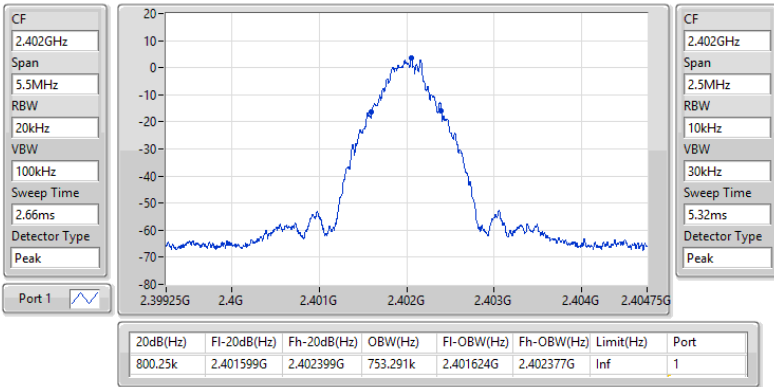

2.4-2.4835GHz_BT-BR(1Mbps)

EBW-FS

2441MHz

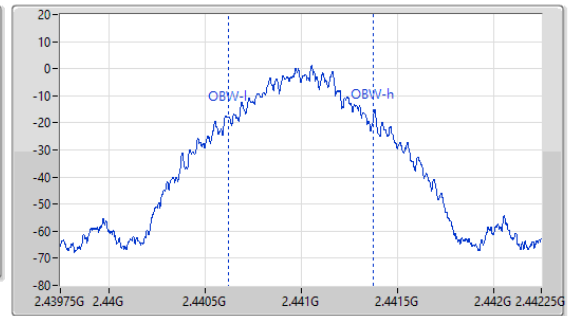
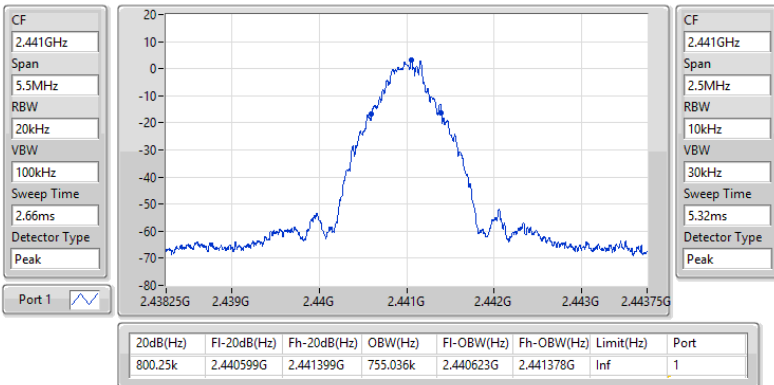



2.4-2.4835GHz_BT-BR(1Mbps)

EBW-FS

2480MHz

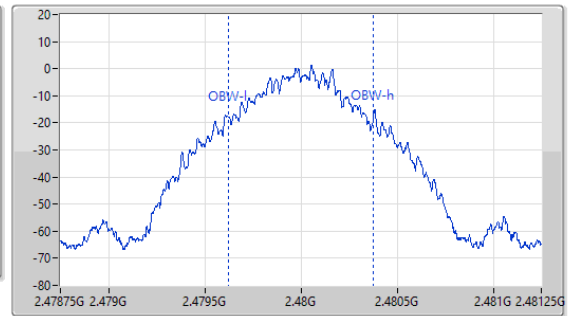
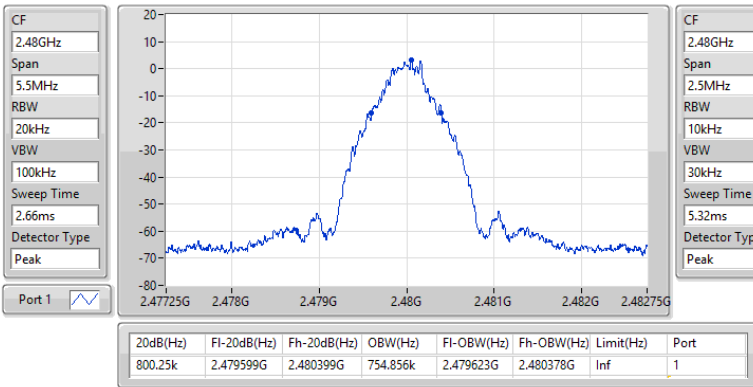

2.4-2.4835GHz_BT-EDR(2Mbps)

EBW-FS

2402MHz

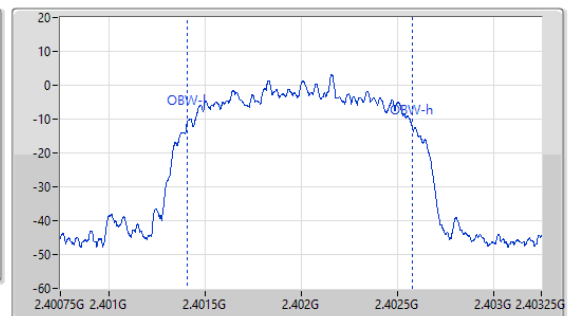
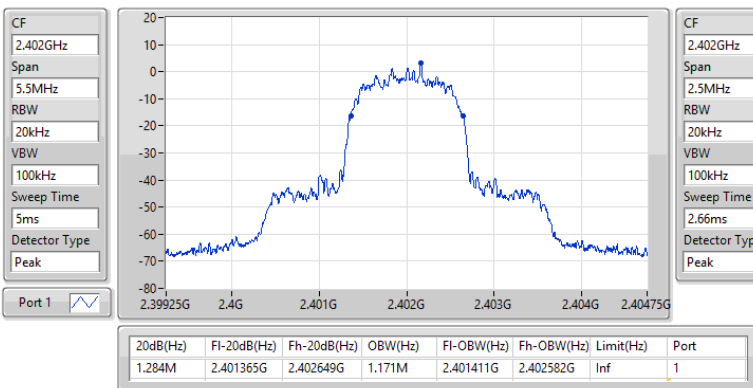

2.4-2.4835GHz_BT-EDR(2Mbps)

EBW-FS

2441MHz

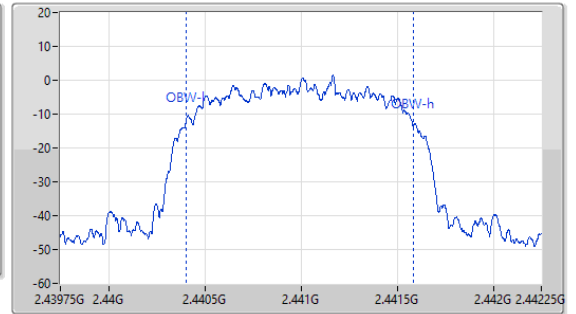
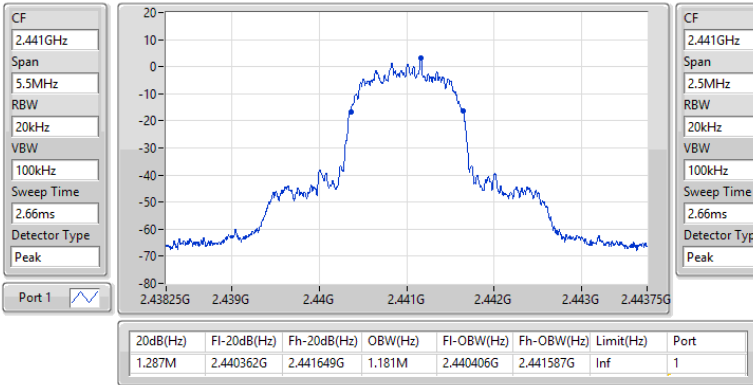

2.4-2.4835GHz_BT-EDR(2Mbps)

EBW-FS

2480MHz

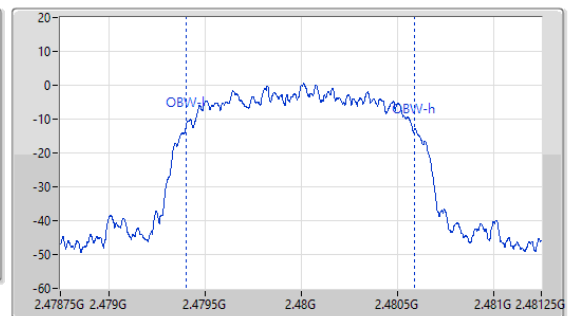
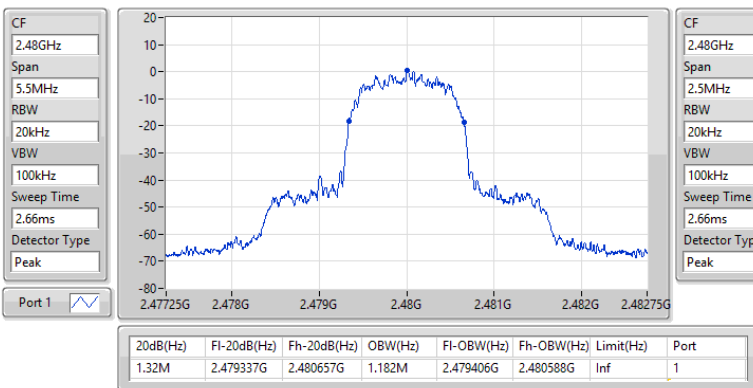



2.4-2.4835GHz_BT-EDR(3Mbps)

EBW-FS

2402MHz

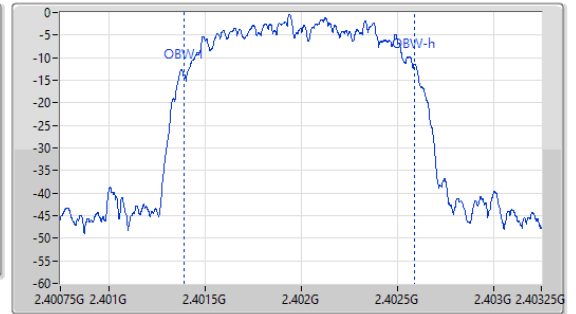
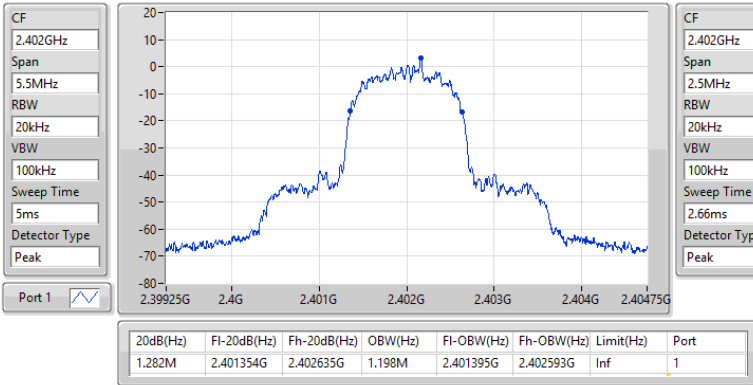

2.4-2.4835GHz_BT-EDR(3Mbps)

EBW-FS

2441MHz

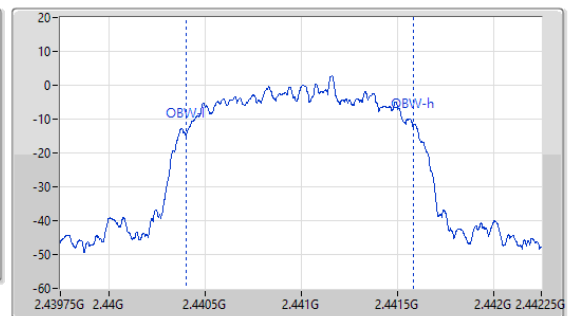
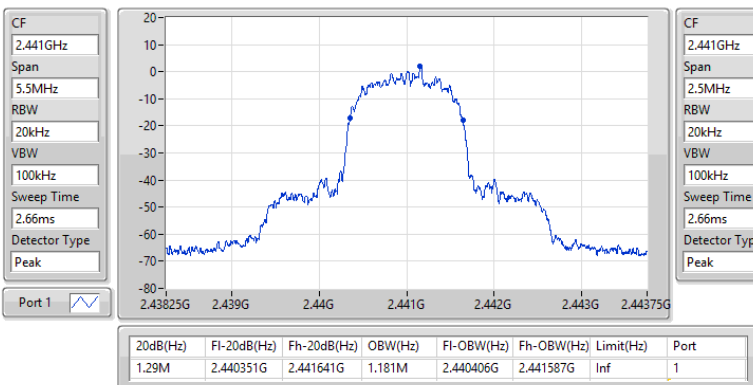

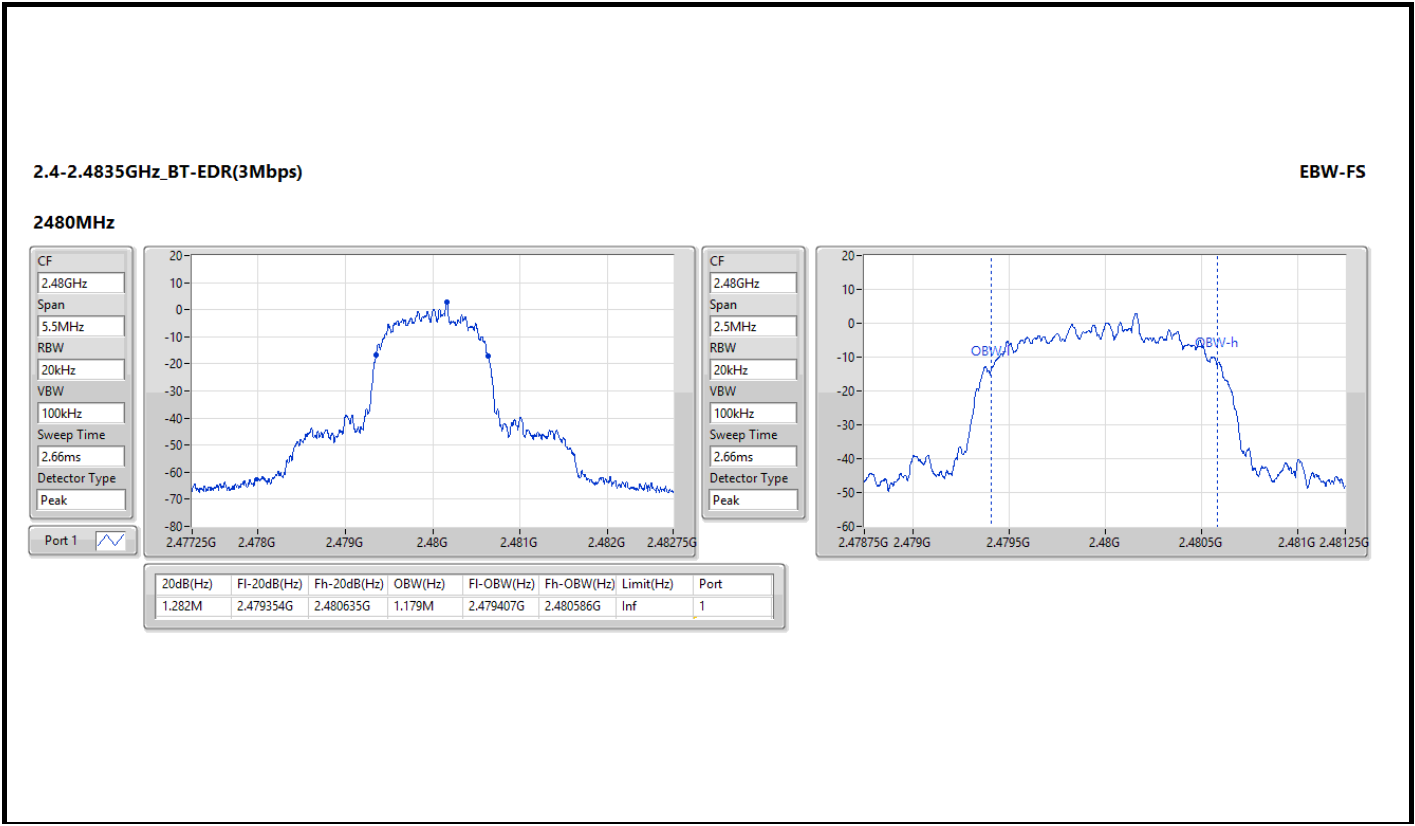



Summary

Mode	Max-Space (Hz)	Min-Space (Hz)
2.4-2.4835GHz	-	-
BT-BR(1Mbps)	1.0035M	1.0005M
BT-EDR(2Mbps)	1.0005M	1.0005M
BT-EDR(3Mbps)	1.002M	1.002M

Result

Mode	Result	Fl (Hz)	Fh (Hz)	Ch.Space (Hz)	Limit (Hz)
BT-BR(1Mbps)	-	-	-	-	-
2402MHz	Pass	2.402158G	2.403162G	1.0035M	532.9665k
2441MHz	Pass	2.441158G	2.44216G	1.002M	532.9665k
2480MHz	Pass	2.479055G	2.480055G	1.0005M	532.9665k
BT-EDR(2Mbps)	-	-	-	-	-
2402MHz	Pass	2.402161G	2.403162G	1.0005M	855.144k
2441MHz	Pass	2.441161G	2.442162G	1.0005M	857.142k
2480MHz	Pass	2.479161G	2.480162G	1.0005M	879.12k
BT-EDR(3Mbps)	-	-	-	-	-
2402MHz	Pass	2.40216G	2.403162G	1.002M	853.812k
2441MHz	Pass	2.441158G	2.44216G	1.002M	859.14k
2480MHz	Pass	2.479157G	2.480159G	1.002M	853.812k

2.4-2.4835GHz_BT-BR(1Mbps)

Channel Separation-FS

2.402G/2.403GHz

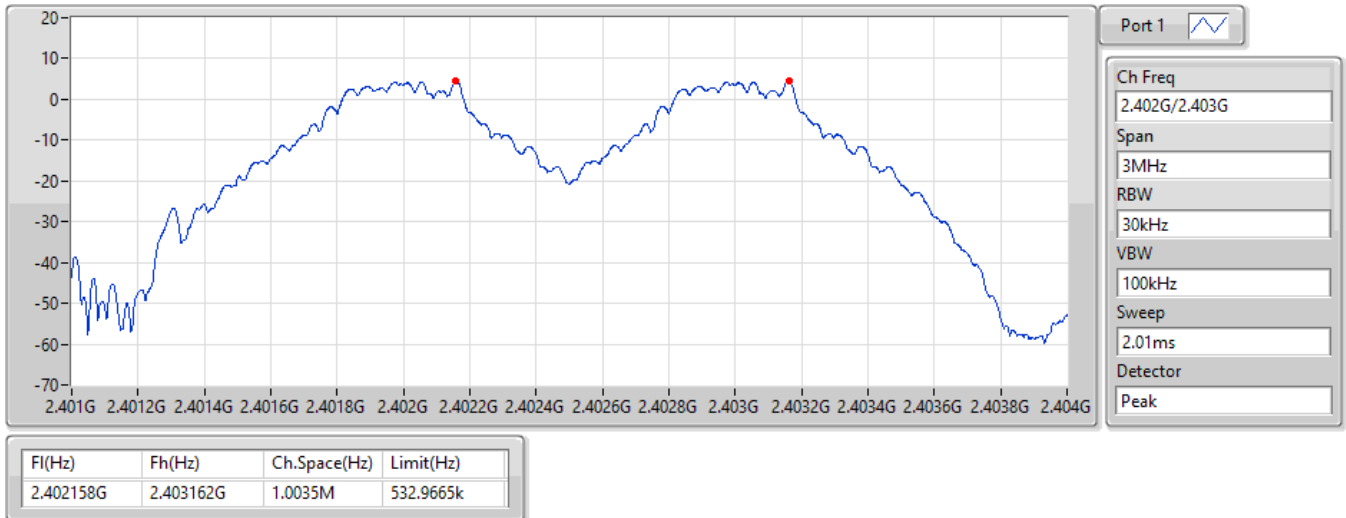

2.4-2.4835GHz_BT-BR(1Mbps)

Channel Separation-FS

2.441G/2.442GHz

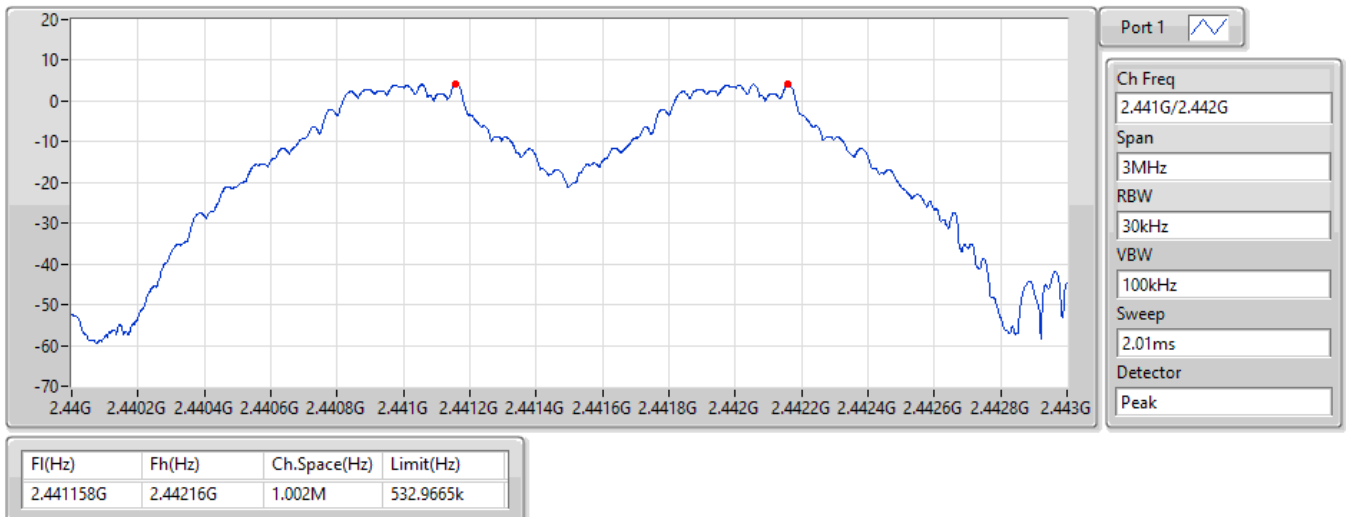

2.4-2.4835GHz_BT-BR(1Mbps)

Channel Separation-FS

2.48G/2.479GHz

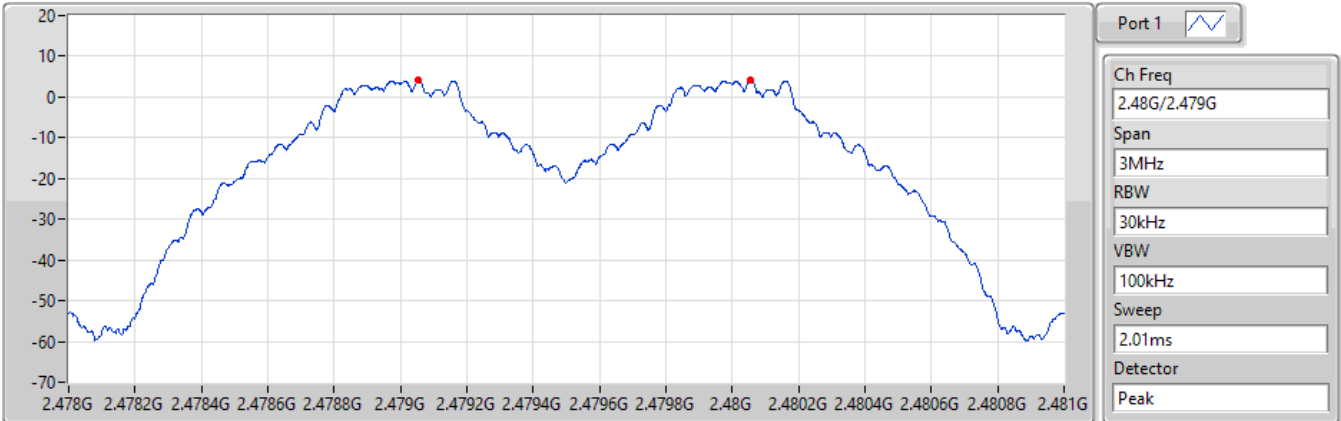

Fl(Hz)	Fh(Hz)	Ch.Space(Hz)	Limit(Hz)
2.479055G	2.480055G	1.0005M	532.9665k

2.4-2.4835GHz_BT-EDR(2Mbps)

Channel Separation-FS

2.402G/2.403GHz

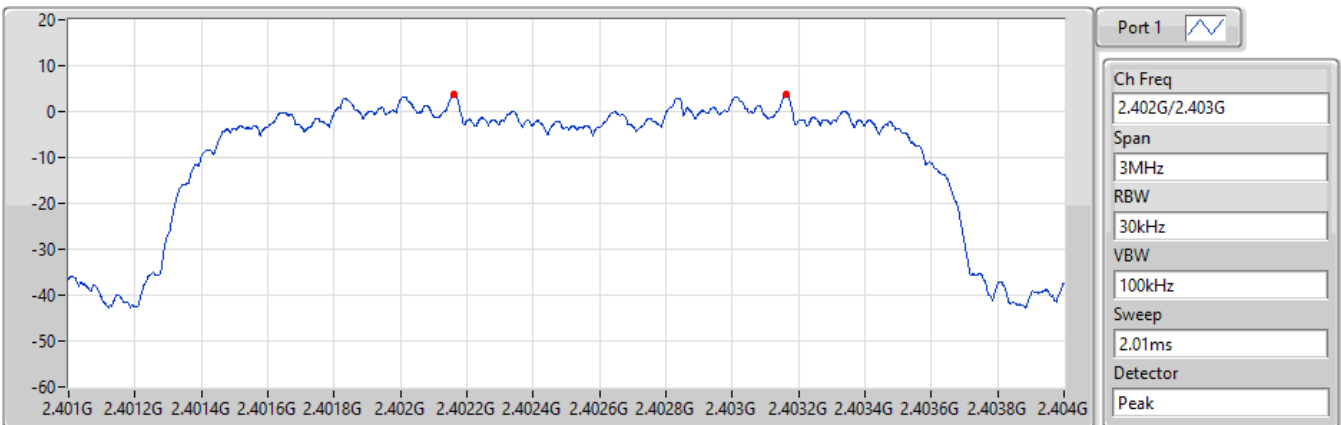

Fl(Hz)	Fh(Hz)	Ch.Space(Hz)	Limit(Hz)
2.402161G	2.403162G	1.0005M	855.144k

2.4-2.4835GHz_BT-EDR(2Mbps)

Channel Separation-FS

2.441G/2.442GHz

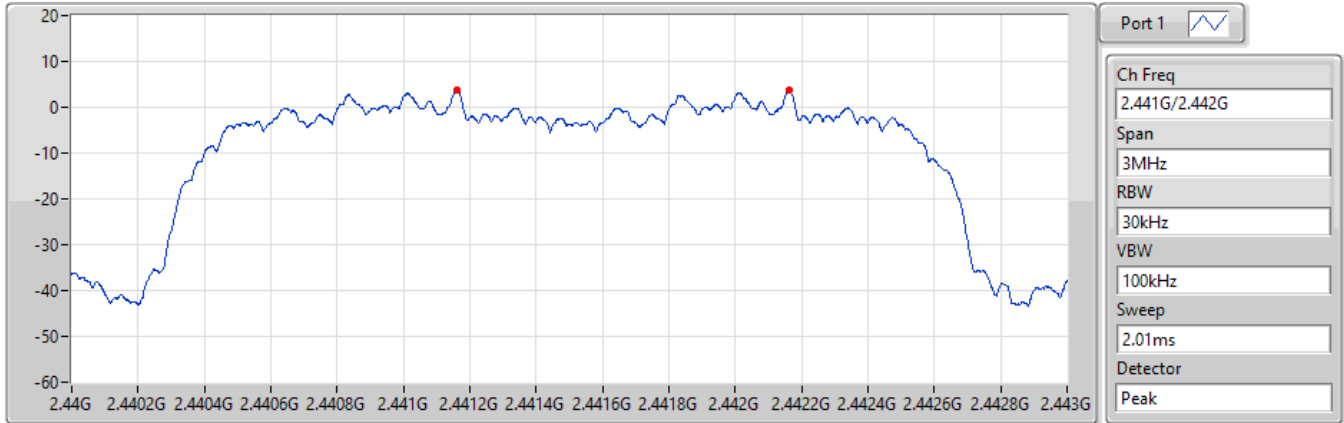

F1(Hz)	Fh(Hz)	Ch.Space(Hz)	Limit(Hz)
2.441161G	2.442162G	1.0005M	857.142k

2.4-2.4835GHz_BT-EDR(2Mbps)

Channel Separation-FS

2.48G/2.479GHz

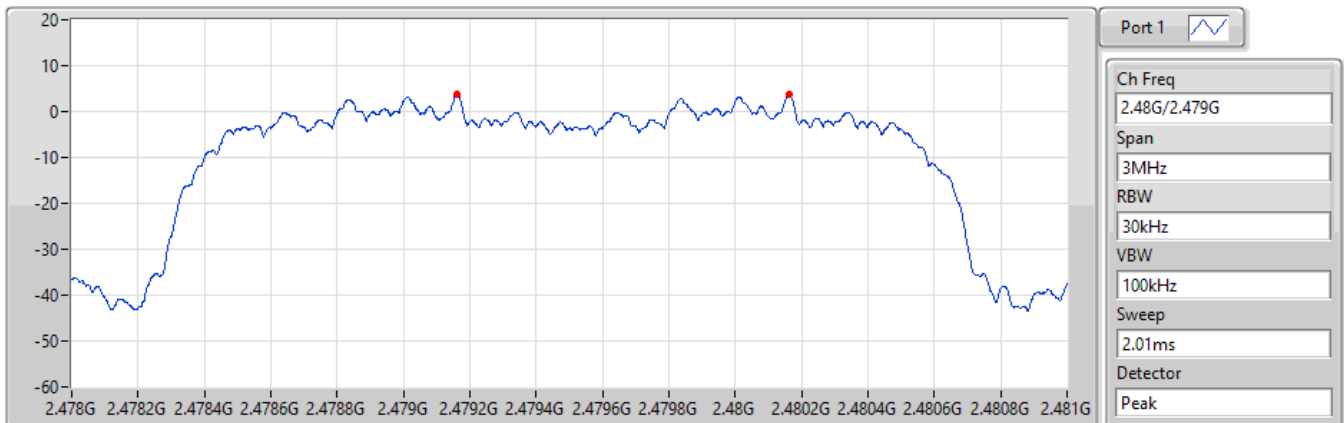

F1(Hz)	Fh(Hz)	Ch.Space(Hz)	Limit(Hz)
2.479161G	2.480162G	1.0005M	879.12k

2.4-2.4835GHz_BT-EDR(3Mbps)

Channel Separation-FS

2.402G/2.403GHz

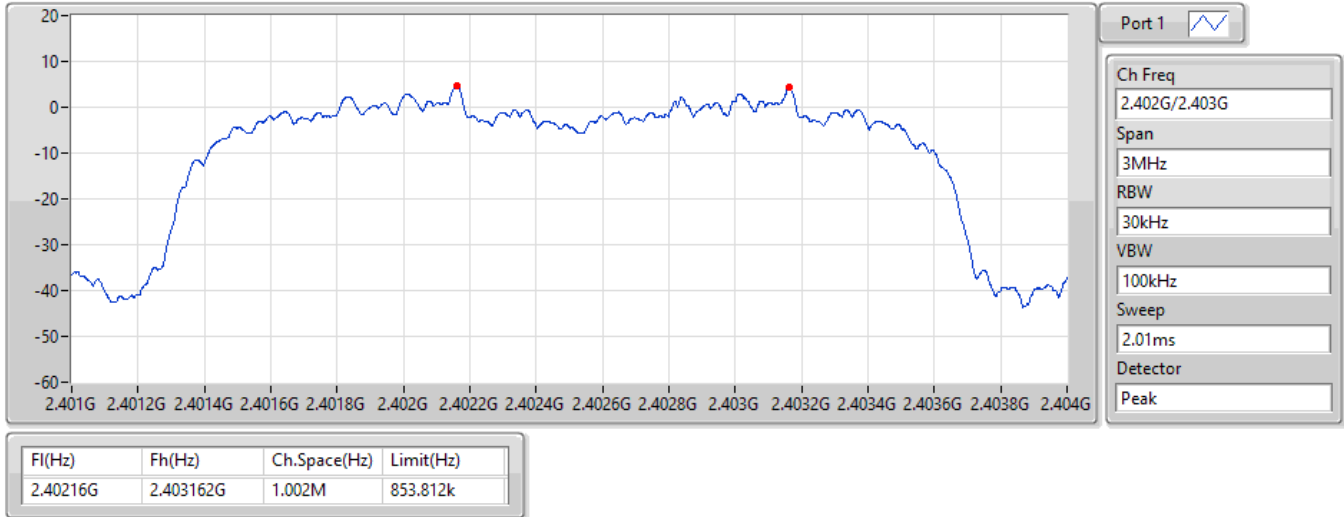

2.4-2.4835GHz_BT-EDR(3Mbps)

Channel Separation-FS

2.441G/2.442GHz

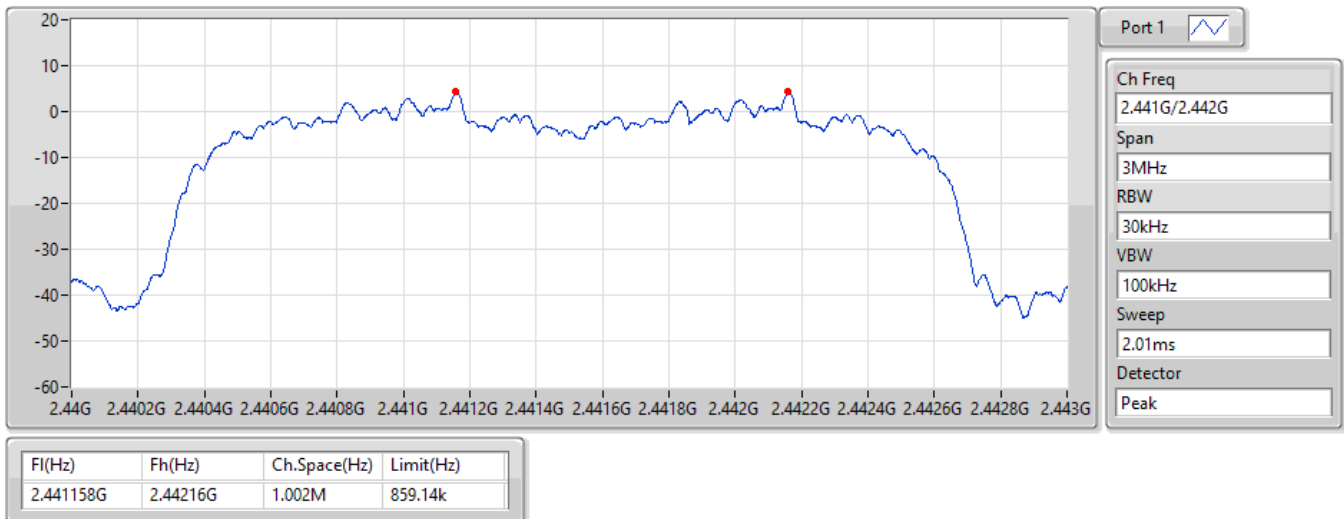



2.4-2.4835GHz_BT-EDR(3Mbps)

Channel Separation-FS

2.48G/2.479GHz



F1(Hz)	Fh(Hz)	Ch.Space(Hz)	Limit(Hz)
2.479157G	2.480159G	1.002M	853.812k



Summary

Mode	Max-Dwell (s)
2.4-2.4835GHz	-
BT-BR(1Mbps)	309.64208m_DH5
BT-BR-AFH(1Mbps)	288.2m_DH5-AFH
BT-EDR(2Mbps)	346.82106m_DH5
BT-EDR-AFH(2Mbps)	288.725m_DH5-AFH
BT-EDR(3Mbps)	347.06122m_DH5
BT-EDR-AFH(3Mbps)	312.093m_DH5-AFH



Result/ Non AFH mode

Mode	Result	Period (s)	Dwell (s)	Limit (s)	Tx On (ms)	Number of transmission in a 5 s
BT-BR(1Mbps)	-	-	-	-	-	-
2402MHz_DH5	PASS	31.6	0.30964	0.4	2.88200	17
BT-EDR(2Mbps)	-	-	-	-	-	-
2402MHz_DH5	PASS	31.6	0.34682	0.4	2.88825	19
BT-EDR(3Mbps)	-	-	-	-	-	-
2402MHz_DH5	PASS	31.6	0.34706	0.4	2.89025	19

Note 1: Dwell time =Number of transmission in a 5 second x Tx On Time x 6.32

Note 2: DH5 was the worst mode.

Result/ AFH mode

Mode	Result	Period (s)	Dwell (s)	Limit (s)	Tx On (ms)	Number of transmission in a 2 s
BT-BR-AFH(1Mbps)	-	-	-	-	-	-
2402MHz_DH5	PASS	8	0.28820	0.4	2.88200	25
BT-EDR-AFH(2Mbps)	-	-	-	-	-	-
2402MHz_DH5	PASS	8	0.28873	0.4	2.88725	25
BT-EDR-AFH(3Mbps)	-	-	-	-	-	-
2402MHz_DH5	PASS	8	0.31209	0.4	2.88975	27

Note 1: Dwell time =Number of transmission in a 2 second x Tx On Time x 4

Note 2: DH5 was the worst mode.



2.4-2.4835GHz_BT-BR(1Mbps)

Dwell-FS

2402MHz



2.4-2.4835GHz_BT-EDR(2Mbps)

Dwell-FS

2402MHz

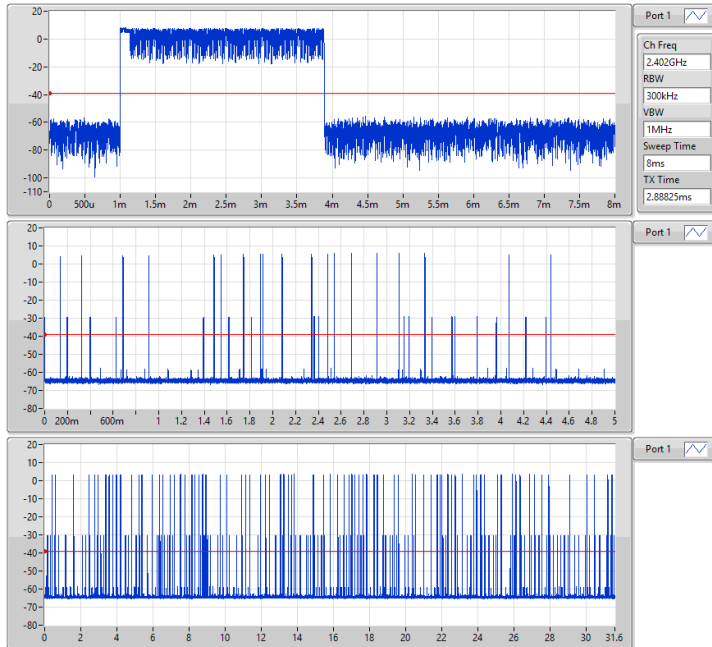

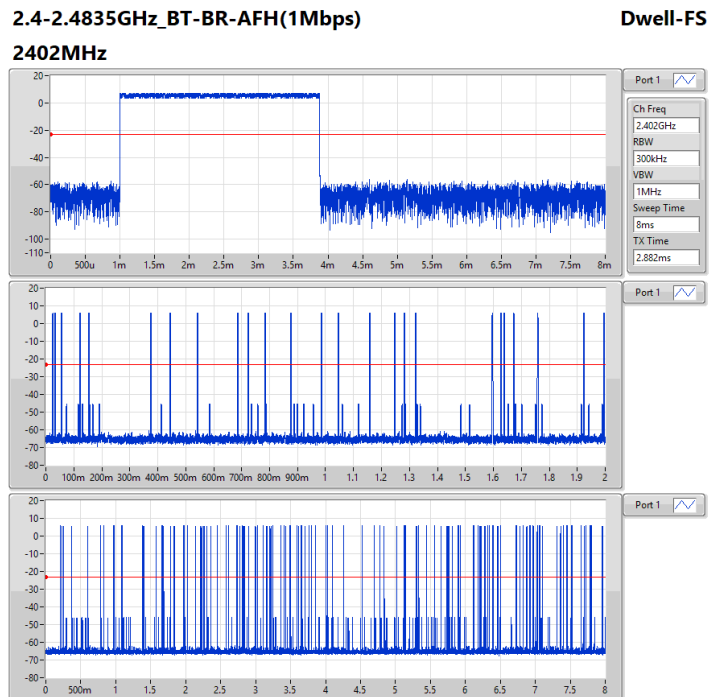
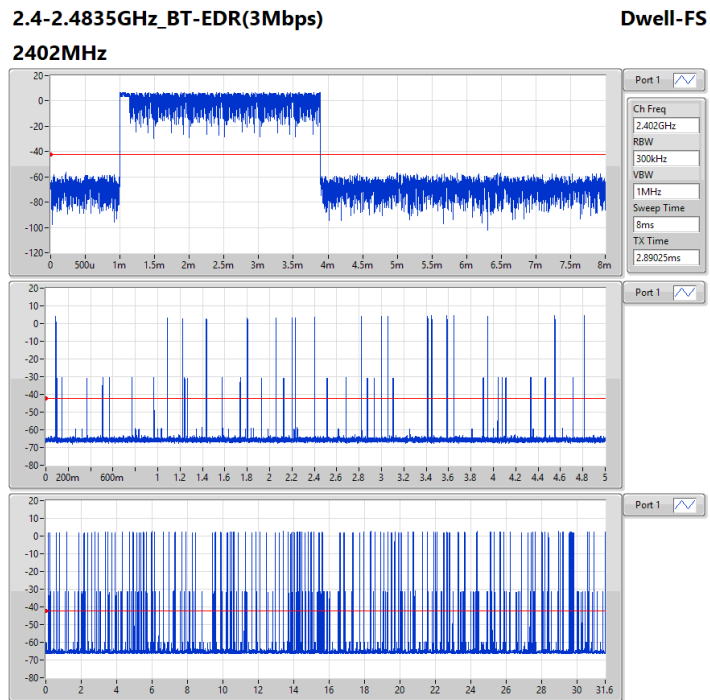

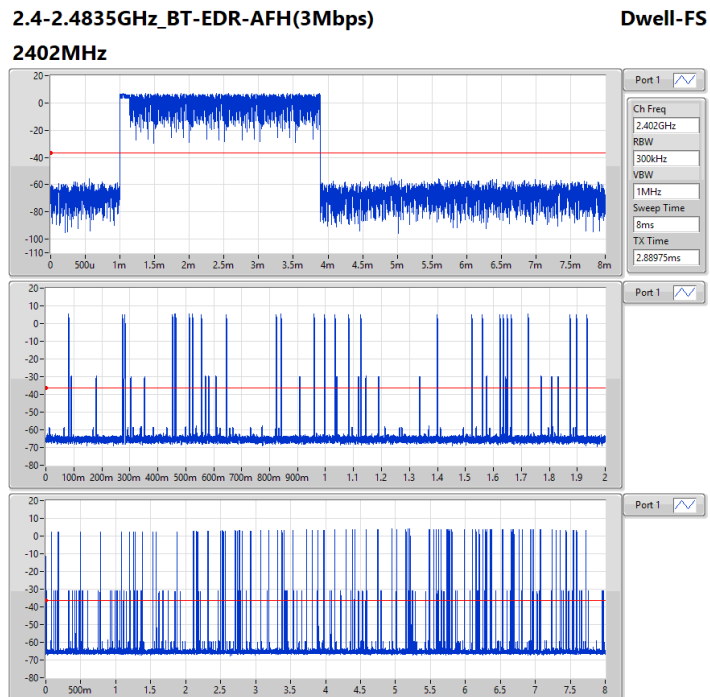
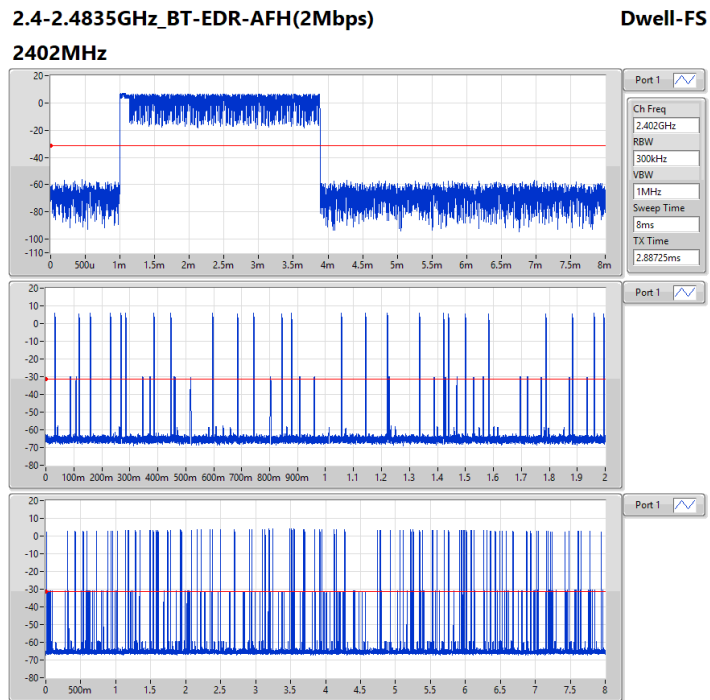



Modulation	8DPSK	Test Freq. (MHz)	2402
Power Phase	Line		

Test by : Joe Liao Temperature: 22°C Humidity: 68%

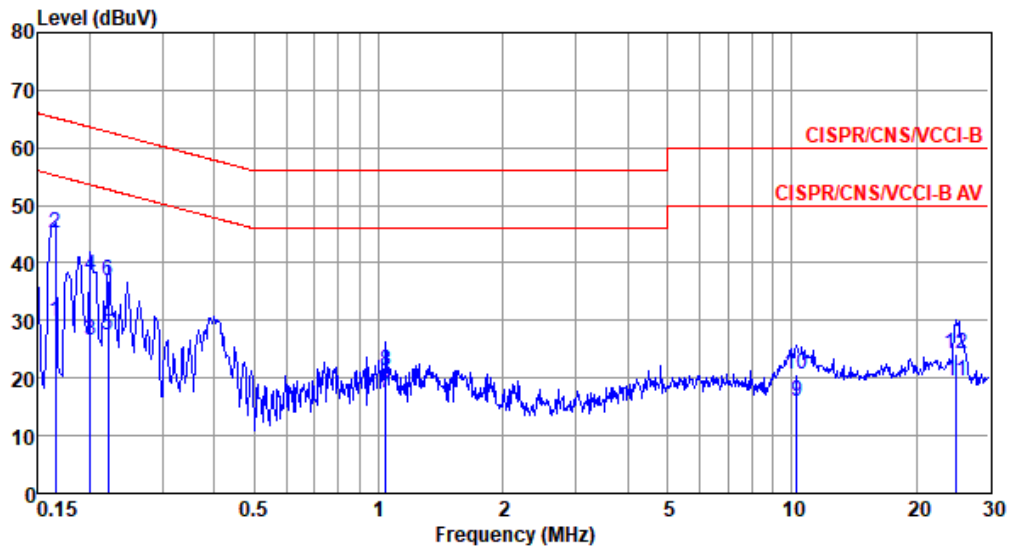

	Freq MHz	Level dBuV	Limit Line dBuV	Over Limit dB	Read Level dBuV	Factor dB	Cable loss dB	Aux dB	Remark
1	0.165	29.88	55.21	-25.33	19.96	9.63	0.07	0.22	Average
2*	0.165	45.19	65.21	-20.02	35.27	9.63	0.07	0.22	QP
3	0.201	26.54	53.58	-27.04	16.61	9.62	0.06	0.25	Average
4	0.201	37.88	63.58	-25.70	27.95	9.62	0.06	0.25	QP
5	0.222	27.34	52.74	-25.40	17.40	9.62	0.06	0.26	Average
6	0.222	36.95	62.74	-25.79	27.01	9.62	0.06	0.26	QP
7	1.043	17.49	46.00	-28.51	7.41	9.63	0.09	0.36	Average
8	1.043	21.15	56.00	-34.85	11.07	9.63	0.09	0.36	QP
9	10.288	16.04	50.00	-33.96	5.54	9.69	0.36	0.45	Average
10	10.288	20.59	60.00	-39.41	10.09	9.69	0.36	0.45	QP
11	25.055	19.55	50.00	-30.45	8.67	9.65	0.54	0.69	Average
12	25.055	24.11	60.00	-35.89	13.23	9.65	0.54	0.69	QP

Note 1: Level (dBuV) = Read Level (dBuV) + LISN Factor (dB) + Cable Loss (dB) + Aux (dB).

2: Over Limit (dB) = Level (dBuV) - Limit Line (dBuV).



Modulation	8DPSK	Test Freq. (MHz)	2402
Power Phase	Neutral		

Test by : Joe Liao Temperature: 22°C Humidity: 68%

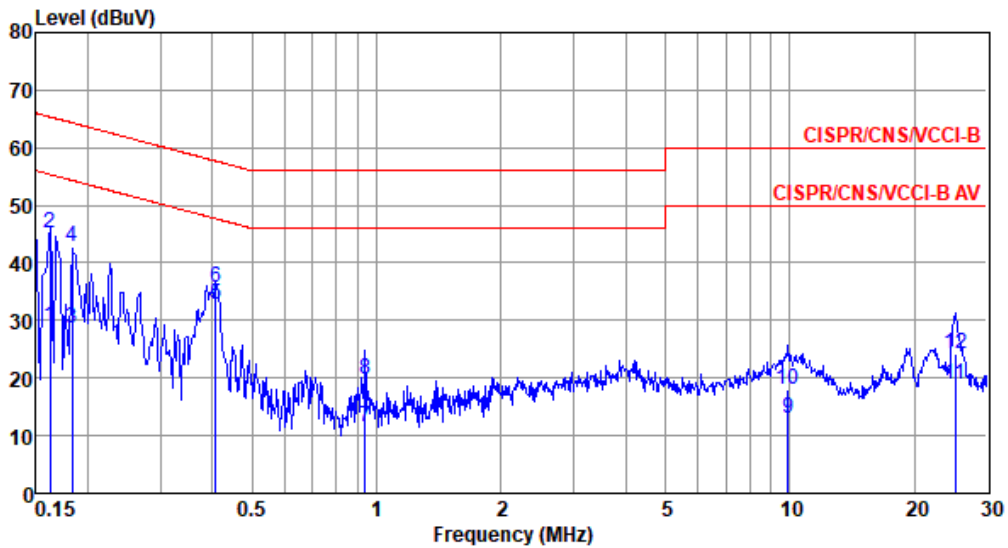

	Freq MHz	Level dBuV	Limit Line dBuV	Over Limit dB	Read Level dBuV	Factor dB	Cable loss dB	Aux dB	Remark
1	0.162	28.94	55.34	-26.40	19.11	9.63	0.07	0.13	Average
2	0.162	45.05	65.34	-20.29	35.22	9.63	0.07	0.13	QP
3	0.183	28.53	54.33	-25.80	18.67	9.63	0.07	0.16	Average
4	0.183	42.71	64.33	-21.62	32.85	9.63	0.07	0.16	QP
5*	0.408	32.70	47.68	-14.98	22.75	9.62	0.08	0.25	Average
6	0.408	35.68	57.68	-22.00	25.73	9.62	0.08	0.25	QP
7	0.938	11.45	46.00	-34.55	1.43	9.63	0.09	0.30	Average
8	0.938	19.67	56.00	-36.33	9.65	9.63	0.09	0.30	QP
9	9.913	13.06	50.00	-36.94	2.58	9.71	0.35	0.42	Average
10	9.913	18.10	60.00	-41.90	7.62	9.71	0.35	0.42	QP
11	25.188	18.92	50.00	-31.08	7.97	9.79	0.54	0.62	Average
12	25.188	24.20	60.00	-35.80	13.25	9.79	0.54	0.62	QP

Note 1: Level (dBuV) = Read Level (dBuV) + LISN Factor (dB) + Cable Loss (dB) + Aux (dB).
 2: Over Limit (dB) = Level (dBuV) – Limit Line (dBuV).