

# FCC Test Report

**FCC ID** : SQG-MSD50NBT  
**Equipment** : 802.11abgn Molex 60-pin board-to-board module w/SDIO interface  
**Model No.** : MSD50NBT  
**Brand Name** : Laird Technologies  
**Applicant** : Laird Technologies  
**Address** : 11160 Thompson Ave., Lenexa, Kansas 66219, USA  
**Standard** : 47 CFR FCC Part 15.407  
**Received Date** : Sep. 11, 2015  
**Tested Date** : Dec. 03, 2015 ~ Jan. 26, 2016

We, International Certification Corp., would like to declare that the tested sample has been evaluated and in compliance with the requirement of the above standards. The test results contained in this report refer exclusively to the product. It may be duplicated completely for legal use with the approval of the applicant. It shall not be reproduced except in full without the written approval of our laboratory.

Approved & Reviewed by:

  
\_\_\_\_\_  
Gary Chang / Manager



---

## Table of Contents

<b>1</b>	<b>GENERAL DESCRIPTION .....</b>	<b>5</b>
1.1	Information.....	5
1.2	Local Support Equipment List .....	9
1.3	Test Setup Chart .....	9
1.4	The Equipment List .....	10
1.5	Testing Applied Standards .....	11
1.6	Measurement Uncertainty .....	11
<b>2</b>	<b>TEST CONFIGURATION .....</b>	<b>12</b>
2.1	Testing Condition .....	12
2.2	The Worst Test Modes and Channel Details .....	12
<b>3</b>	<b>TRANSMITTER TEST RESULTS.....</b>	<b>14</b>
3.1	Conducted Emissions.....	14
3.2	Emission Bandwidth .....	19
3.3	RF Output Power .....	23
3.4	Peak Power Spectral Density .....	26
3.5	Transmitter Radiated and Band Edge Emissions .....	31
3.6	Frequency Stability.....	244
<b>4</b>	<b>TEST LABORATORY INFORMATION .....</b>	<b>247</b>

---

## Release Record

Report No.	Version	Description	Issued Date
FR591103AN	Rev. 01	Initial issue	Feb. 22, 2016

## Summary of Test Results

FCC Rules	Test Items	Measured	Result
15.207	Conducted Emissions	[dBuV]: 18.232MHz 19.77 (Margin -30.23dB) - AV	Pass
15.407(b) 15.209	Radiated Emissions	[dBuV/m at 3m]: 5725.00MHz 53.86 (Margin -0.14dB) - AV	Pass
15.407(a)	Emission Bandwidth	Meet the requirement of limit	Pass
15.407(e)	6dB bandwidth	Meet the requirement of limit	Pass
15.407(a)	RF Output Power	Max Power [dBm]: 5150~5250MHz: 21.65 5250~5350MHz: 21.55 5470~5725MHz: 21.71 5725~5850MHz: 21.34	Pass
15.407(a)	Peak Power Spectral Density	Meet the requirement of limit	Pass
15.407(g)	Frequency Stability	Meet the requirement of limit	Pass
15.203	Antenna Requirement	Meet the requirement of limit	Pass

# 1 General Description

## 1.1 Information

### 1.1.1 Specification of the Equipment under Test (EUT)

RF General Information					
Frequency Range (MHz)	IEEE Std. 802.11	Ch. Freq. (MHz)	Channel Number	Transmit Chains (N <sub>TX</sub> )	Data Rate / MCS
5150-5250 5250-5350 5470-5725 5725-5850	a	5180-5240 5260-5320 5500-5700 5745-5825	36-48 [4] 52-64 [4] 100-140 [11] 149-165 [5]	1 2	6-54 Mbps
5150-5250 5250-5350 5470-5725 5725-5850	n (HT20)	5180-5240 5260-5320 5500-5700 5745-5825	36-48 [4] 52-64 [4] 100-140 [11] 149-165 [5]	1 2 2	MCS 0-7 MCS 0-7 MCS 8-15
5150-5250 5250-5350 5470-5725 5725-5850	n (HT40)	5190-5230 5270-5310 5510-5670 5755-5795	38-46 [2] 54-62 [2] 102-134 [5] 151-159 [2]	1 2 2	MCS 0-7 MCS 0-7 MCS 8-15

Note 1: RF output power specifies that Maximum Conducted Output Power.  
 Note 2: 802.11a/n uses a combination of OFDM-BPSK, QPSK, 16QAM, 64QAM modulation.  
 Note 3: The device supports TX antenna diversity function. The conducted power of single chain is same for 1TX and 2TX operating mode. Therefore, Ant1+Ant2 configuration is chosen for final testing.

### 1.1.2 Antenna Details

Ant. No.	Model	Type	Connector	Operating Frequencies (MHz) / Antenna Gain (dBi)				
				2400~2483.5	5150~5250	5250~5350	5470~5725	5725~5850
1	Laird MAF94051	Dipole	RP-SMA	2.1	2.4	2.6	3.4	3.4
2	Laird NanoBlade-IP04	PCB Dipole	IPEX MHF	2	3.9	3.9	4	4
3	Laird MAF95310 Mini NanoBlade Flex	PCB Dipole	IPEX MHF	2.79	3.38	3.38	3.38	3.38
4	Laird NanoBlue-IP04	PCB Dipole	IPEX MHF	2	---	---	---	---
5	Ethertronics WLAN_1000146	Isolated Magnetic Dipole	IPEX MHF	2.5	3.5	3.5	3.5	3.5

**Note:** Ant. No. 1, 3 & 5 were for 2.4G final test.

Ant. No. 1, 2 & 5 were for 5G final test.

### 1.1.3 Power Supply Type of Equipment under Test (EUT)

<b>Power Supply Type</b>	3.3Vdc from host
--------------------------	------------------

### 1.1.4 Accessories

N/A

### 1.1.5 Channel List

802.11 a / HT20		HT40	
Channel	Frequency(MHz)	Channel	Frequency(MHz)
36	5180	38	5190
40	5200	46	5230
44	5220	54	5270
48	5240	62	5310
52	5260	102	5510
56	5280	110	5550
60	5300	118	5590
64	5320	126	5630
100	5500	134	5670
104	5520	151	5755
108	5540	159	5795
112	5560	---	---
116	5580	---	---
120	5600	---	---
124	5620	---	---
128	5640	---	---
132	5660	---	---
136	5680	---	---
140	5700	---	---
149	5745	---	---
153	5765	---	---
157	5785	---	---
161	5805	---	---
165	5825	---	---

### 1.1.6 Test Tool and Duty Cycle

<b>Test Tool</b>	ART2 GUI, V2.3		
<b>Duty Cycle and Duty Factor</b>	<b>Mode</b>	<b>Duty cycle (%)</b>	<b>Duty factor (dB)</b>
	11a	98.95%	0.05
	HT20	98.87%	0.05
	HT40	98.33%	0.07

### 1.1.7 Power Setting

For Frequency band 5150-5250 MHz		
Modulation Mode	Test Frequency (MHz)	Power Set
11a	5180	20
11a	5200	20
11a	5240	18.5
HT20	5180	20
HT20	5200	18.5
HT20	5240	18.5
HT40	5190	16
HT40	5230	19

For Frequency band 5250~5350 MHz		
Modulation Mode	Test Frequency (MHz)	Power Set
11a	5260	18
11a	5300	19
11a	5320	18.5
HT20	5260	18.5
HT20	5300	18.5
HT20	5320	18.5
HT40	5270	18
HT40	5310	18

For Frequency band 5470~5725 MHz		
Modulation Mode	Test Frequency (MHz)	Power Set
11a	5500	17.5
11a	5580	20
11a	5700	17.5
HT20	5500	17.5
HT20	5580	19
HT20	5700	17
HT40	5510	16
HT40	5590	20
HT40	5670	18.5

For Frequency band 5725~5850 MHz		
Modulation Mode	Test Frequency (MHz)	Power Set
11a	5745	18
11a	5785	20
11a	5825	20
HT20	5745	18
HT20	5785	20
HT20	5825	20.5
HT40	5755	16.5
HT40	5795	21



## 1.2 Local Support Equipment List

Support Equipment List						
No.	Equipment	Brand	Model	S/N	FCC ID	Signal cable / Length (m)
1	DC Power Supply	GW INSTEK	GPC-3060D	EM884797	---	---
2	Notebook	DELL	Latitude E6430	9ZFB4X1	DoC	---
3	Fixture	---	---	---	---	---

Note The Fixture is provided by applicant.

## 1.3 Test Setup Chart

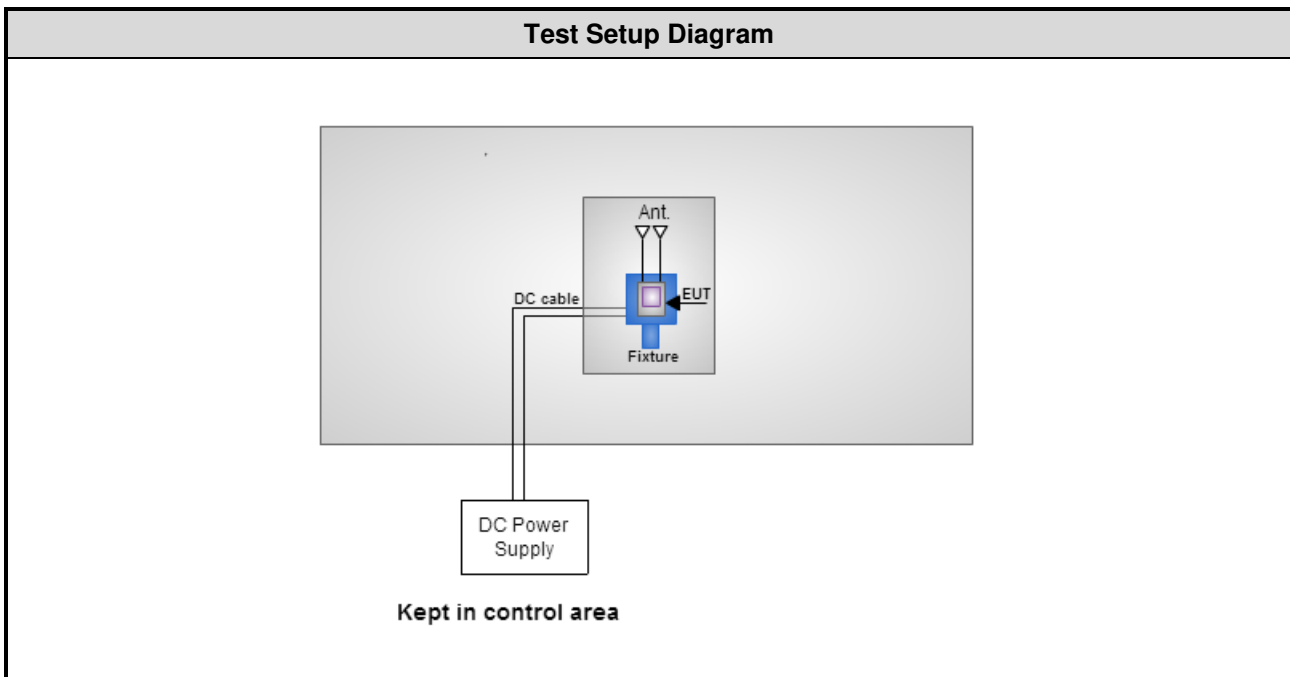

Note: The support notebook was disconnected from EUT and removed from test table when EUT is set to transmit continuously.

## 1.4 The Equipment List

<b>Test Item</b>	Conducted Emission				
<b>Test Site</b>	Conduction room 1 / (CO01-WS)				
<b>Tested Date</b>	Jan. 08, 2016				
<b>Instrument</b>	<b>Manufacturer</b>	<b>Model No.</b>	<b>Serial No.</b>	<b>Calibration Date</b>	<b>Calibration Until</b>
EMC Receiver	R&S	ESCS 30	100169	Oct. 21, 2015	Oct. 20, 2016
LISN	SCHWARZBECK	Schwarzbeck 8127	8127-667	Nov. 13, 2015	Nov. 12, 2016
RF Cable-CON	EMC	EMCCFD300-BM-BM-6000	50821	Dec. 21, 2015	Dec. 20, 2016
Measurement Software	AUDIX	e3	6.120210k	NA	NA
Note: Calibration Interval of instruments listed above is one year.					

<b>Test Item</b>	Radiated Emission				
<b>Test Site</b>	966 chamber 3 / (03CH03-WS)				
<b>Tested Date</b>	Dec. 03, 2015 ~ Jan. 04, 2016				
<b>Instrument</b>	<b>Manufacturer</b>	<b>Model No.</b>	<b>Serial No.</b>	<b>Calibration Date</b>	<b>Calibration Until</b>
Spectrum Analyzer	Agilent	N9010A	MY53400091	Sep. 14, 2015	Sep. 13, 2016
Receiver	Agilent	N9038A	MY53290044	Oct. 14, 2015	Oct. 13, 2016
Bilog Antenna	SCHWARZBECK	VULB9168	VULB9168-522	Aug. 20, 2015	Aug. 19, 2016
Horn Antenna 1G-18G	SCHWARZBECK	BBHA 9120 D	BBHA 9120 D 1206	Feb. 03, 2015	Feb. 02, 2016
Horn Antenna 18G-40G	SCHWARZBECK	BBHA 9170	BBHA 9170517	Nov. 04, 2015	Nov. 03, 2016
Preamplifier	EMC	EMC02325	980187	Sep. 21, 2015	Sep. 20, 2016
Preamplifier	Agilent	83017A	MY53270014	Sep. 07, 2015	Sep. 06, 2016
Preamplifier	EMC	EMC184045B	980192	Sep. 01, 2015	Aug. 31, 2016
RF cable-3M	HUBER+SUHNER	SUCOFLEX104	MY22620/4	Feb. 09, 2015	Feb. 08, 2016
RF cable-8M	HUBER+SUHNER	SUCOFLEX104	MY22600/4	Feb. 09, 2015	Feb. 08, 2016
RF cable-1M	HUBER+SUHNER	SUCOFLEX104	MY22624/4	Feb. 09, 2015	Feb. 08, 2016
LF cable-0.8M	EMC	EMC8D-NM-NM-800	EMC8D-NM-NM-800-001	Feb. 09, 2015	Feb. 08, 2016
LF cable-3M	EMC	EMC8D-NM-NM-3000	131103	Feb. 09, 2015	Feb. 08, 2016
LF cable-13M	EMC	EMC8D-NM-NM-13000	131104	Feb. 09, 2015	Feb. 08, 2016
Measurement Software	AUDIX	e3	6.120210g	NA	NA
Note: Calibration Interval of instruments listed above is one year.					

<b>Test Item</b>	RF Conducted				
<b>Test Site</b>	(TH01-WS)				
<b>Tested Date</b>	Jan. 22 ~ Jan. 26, 2016				
<b>Instrument</b>	<b>Manufacturer</b>	<b>Model No.</b>	<b>Serial No.</b>	<b>Calibration Date</b>	<b>Calibration Until</b>
Spectrum Analyzer	R&S	FSV40	101063	Feb. 03, 2015	Feb. 02, 2016
TEMP&HUMIDITY CHAMBER	GIANT FORCE	GCT-225-40-SP-SD	MAF1212-002	Nov. 27, 2015	Nov. 26, 2016
Power Meter	Anritsu	ML2495A	1241002	Sep. 21, 2015	Sep. 20, 2016
Power Sensor	Anritsu	MA2411B	1207366	Sep. 21, 2015	Sep. 20, 2016
DC POWER SOURCE	GW INSTRON	GPC-3060D	EM884797	Oct. 20, 2015	Oct. 19, 2016
Measurement Software	Sporton	Sporton_1	1.3.30	NA	NA
Note: Calibration Interval of instruments listed above is one year.					

## 1.5 Testing Applied Standards

According to the specification of EUT, the EUT must comply with following standards and KDB documents.

47 CFR FCC Part 15.407

ANSI C63.10-2013

FCC KDB 789033 D02 General UNII Test Procedures New Rules v01r01

FCC KDB 644545 D03 Guidance for IEEE 802.11ac New Rules v01

FCC KDB 662911 D01 Multiple Transmitter Output v02r01

FCC KDB 412172 D01 Determining ERP and EIRP v01r01

## 1.6 Measurement Uncertainty

ISO/IEC 17025 requires that an estimate of the measurement uncertainties associated with the emissions test results be included in the report. The measurement uncertainties given below are based on a 95% confidence level (based on a coverage factor ( $k=2$ )).

Measurement Uncertainty	
Parameters	Uncertainty
Bandwidth	$\pm 34.134$ Hz
Conducted power	$\pm 0.808$ dB
Frequency error	$\pm 34.134$ Hz
Power density	$\pm 0.463$ dB
Conducted emission	$\pm 2.670$ dB
AC conducted emission	$\pm 2.92$ dB
Radiated emission $\leq 1$ GHz	$\pm 3.66$ dB
Radiated emission $> 1$ GHz	$\pm 5.37$ dB
Time	$\pm 0.1\%$
Temperature	$\pm 0.6$ °C

## 2 Test Configuration

### 2.1 Testing Condition

Test Item	Test Site	Ambient Condition	Tested By
AC Conduction	CO01-WS	20°C / 60%	Peter Lin
Radiated Emissions	03CH03-WS	20-23°C / 61-67%	Morgan Lee Warren Lee Aska Huang Anderson Hong Felix Sung Vincent Yeh
RF Conducted	TH01-WS	21°C / 64%	Alex Huang

➤ FCC site registration No.: 390588

➤ IC site registration No.: 10807C-1

### 2.2 The Worst Test Modes and Channel Details

Frequency band 5150~5350 MHz / 5470~5725 MHz				
Test item	Modulation Mode	Test Frequency (MHz)	Data Rate	Test Configuration
Conducted Emissions	HT40	5590	MCS 0	2
Radiated Emissions ≤1GHz	HT40	5590	MCS 0	1, 2, 3
Radiated Emissions >1GHz	11a	5180 / 5200 / 5240 / 5260 / 5300 5320 / 5500 / 5580 / 5700	6 Mbps	1, 2, 3
	HT20	5180 / 5200 / 5240 / 5260 / 5300 5320 / 5500 / 5580 / 5700	MCS 0	
	HT40	5190 / 5230 / 5270 / 5310 / 5510 5590 / 5670	MCS 0	
RF Output Power Emission Bandwidth Peak Power Spectral Density	11a	5180 / 5200 / 5240 / 5260 / 5300 5320 / 5500 / 5580 / 5700	6 Mbps	2
	HT20	5180 / 5200 / 5240 / 5260 / 5300 5320 / 5500 / 5580 / 5700	MCS 0	
	HT40	5190 / 5230 / 5270 / 5310 / 5510 5590 / 5670	MCS 0	
Frequency Stability	Un-modulation	5320	---	---

**NOTE:**

- The EUT was pretested with 3 orientations placed on the table for the radiated emission measurement – X, Y, and Z-plane. The **Y-plane** results were found as the worst case and were shown in this report.
- The following antennas are used for final testing for this module: (See item 1.1.2 for more details.)
  - Configuration 1 : Dipole antenna
  - Configuration 2 : PCB Dipole antenna
  - Configuration 3 : Isolated Magnetic Dipole antenna

Frequency band 5725-5850 MHz				
Test item	Modulation Mode	Test Frequency (MHz)	Data Rate	Test Configuration
Conducted Emissions	HT40	5795	MCS 0	2
Radiated Emissions ≤1GHz	HT40	5795	MCS 0	1, 2, 3
Radiated Emissions >1GHz	11a	5745 / 5785 / 5825	6 Mbps	1, 2, 3
	HT20	5745 / 5785 / 5825	MCS 0	
	HT40	5755 / 5795	MCS 0	
RF Output Power	11a	5745 / 5785 / 5825	6 Mbps	2
Emission Bandwidth	HT20	5745 / 5785 / 5825	MCS 0	
6dB bandwidth	HT40	5755 / 5795	MCS 0	
Peak Power Spectral Density	HT40	5755 / 5795	MCS 0	
Frequency Stability	Un-modulation	5785	---	---
<b>NOTE:</b>				
1. The EUT was pretested with 3 orientations placed on the table for the radiated emission measurement – X, Y, and Z-plane. The <b>Y-plane</b> results were found as the worst case and were shown in this report.				
2. The following antennas are used for final testing for this module: (See item 1.1.2 for more details.)				
1) Configuration 1 : Dipole antenna				
2) Configuration 2 : PCB Dipole antenna				
3) Configuration 3 : Isolated Magnetic Dipole antenna				

## 3 Transmitter Test Results

### 3.1 Conducted Emissions

#### 3.1.1 Limit of Conducted Emissions

Conducted Emissions Limit		
Frequency Emission (MHz)	Quasi-Peak	Average
0.15-0.5	66 - 56 *	56 - 46 *
0.5-5	56	46
5-30	60	50

Note 1: \* Decreases with the logarithm of the frequency.

#### 3.1.2 Test Procedures

1. The device is placed on a test table, raised 80 cm above the reference ground plane. The vertical conducting plane is located 40 cm to the rear of the device.
2. The device is connected to line impedance stabilization network (LISN) and other accessories are connected to other LISN. Measured levels of AC power line conducted emission are across the 50  $\Omega$  LISN port.
3. AC conducted emission measurements is made over frequency range from 150 kHz to 30 MHz.
4. This measurement was performed with AC 120V/60Hz

#### 3.1.3 Test Setup

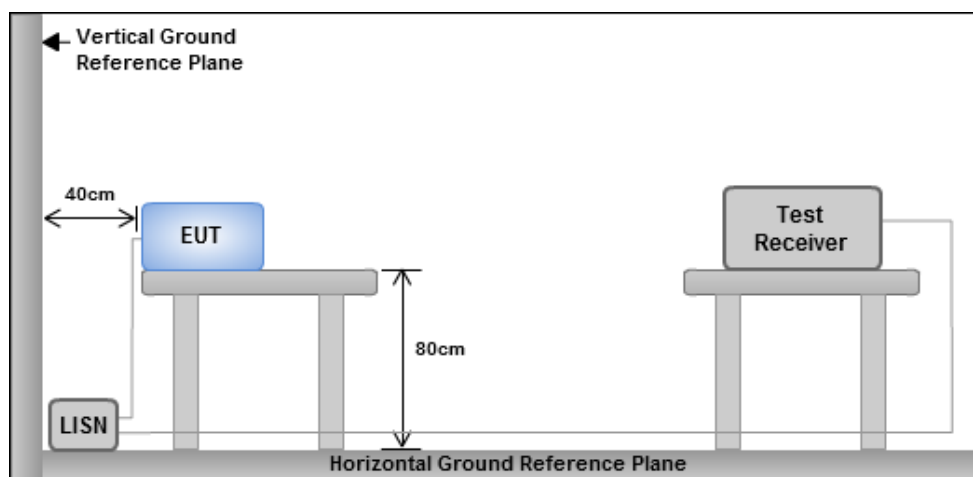

Note: 1. Support units were connected to second LISN.

2. Both of LISNs (AMN) are 80 cm from EUT and at least 80 cm from other units and other metal planes

### 3.1.4 Test Result of Conducted Emissions

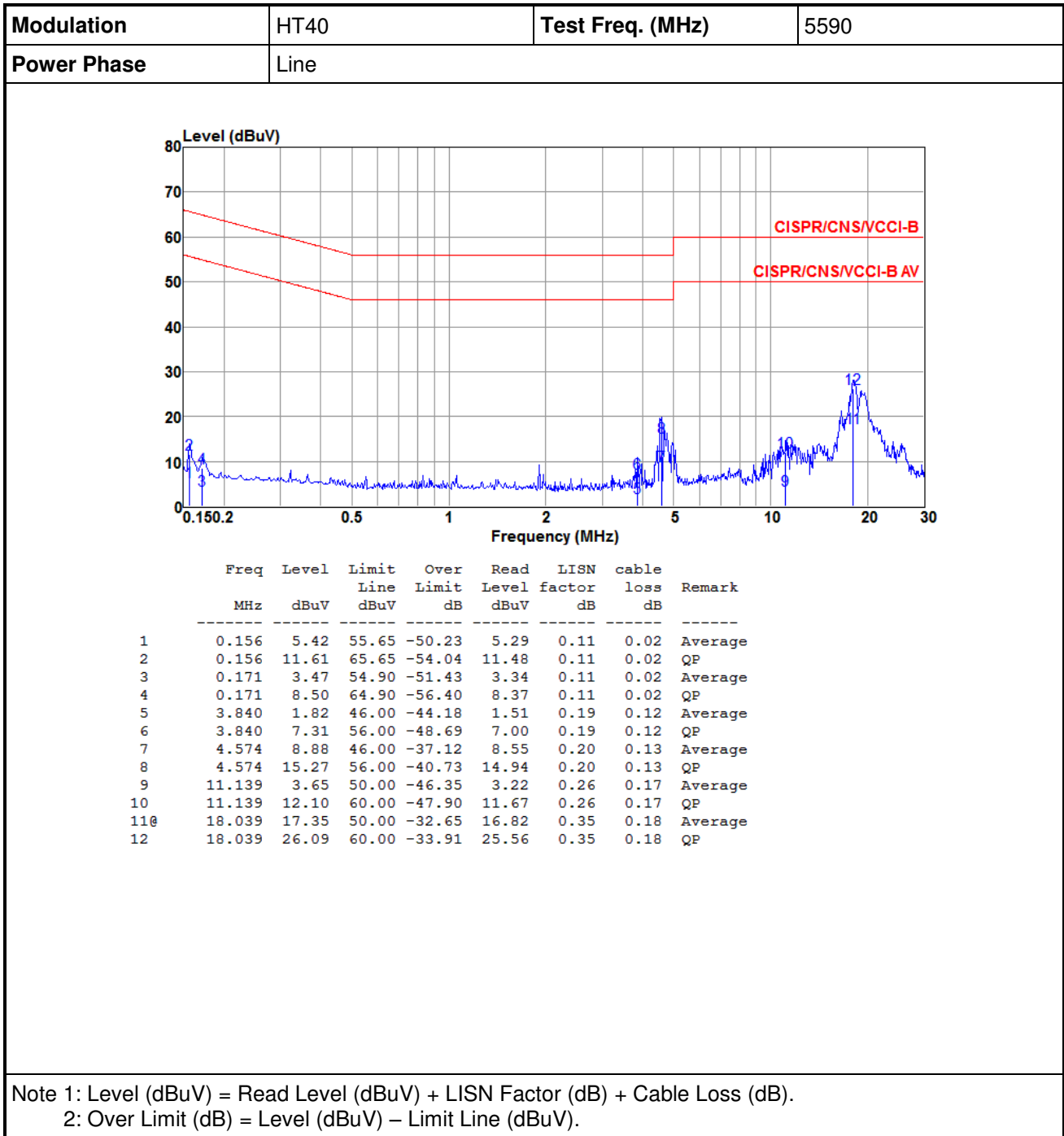

<b>Modulation</b>	HT40	<b>Test Freq. (MHz)</b>	5590
<b>Power Phase</b>	Neutral		

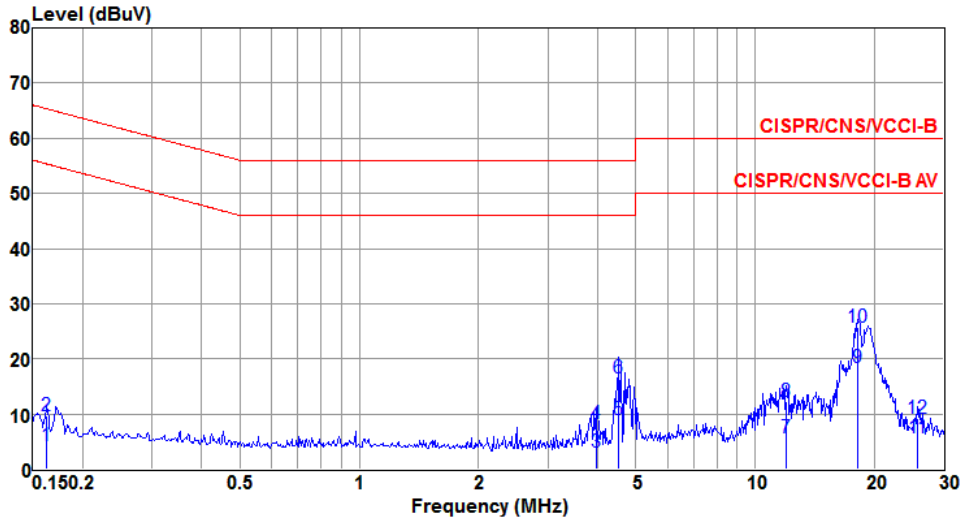

	Freq	Level	Limit	Over	Read	LISN	cable	
	MHz	dBuV	Line	Limit	Level	factor	loss	Remark
			dBuV	dB	dBuV	dB	dB	
1	0.162	4.32	55.34	-51.02	4.18	0.12	0.02	Average
2	0.162	9.71	65.34	-55.63	9.57	0.12	0.02	QP
3	3.964	3.17	46.00	-42.83	2.88	0.17	0.12	Average
4	3.964	8.34	56.00	-47.66	8.05	0.17	0.12	QP
5	4.525	9.04	46.00	-36.96	8.73	0.18	0.13	Average
6	4.525	16.54	56.00	-39.46	16.23	0.18	0.13	QP
7	11.996	5.72	50.00	-44.28	5.24	0.30	0.18	Average
8	11.996	12.19	60.00	-47.81	11.71	0.30	0.18	QP
9	18.135	18.37	50.00	-31.63	17.81	0.38	0.18	Average
10	18.135	25.78	60.00	-34.22	25.22	0.38	0.18	QP
11	25.727	5.59	50.00	-44.41	4.88	0.46	0.25	Average
12	25.727	9.32	60.00	-50.68	8.61	0.46	0.25	QP

Note 1: Level (dBuV) = Read Level (dBuV) + LISN Factor (dB) + Cable Loss (dB).  
 2: Over Limit (dB) = Level (dBuV) - Limit Line (dBuV).



<b>Modulation</b>	HT40	<b>Test Freq. (MHz)</b>	5795
<b>Power Phase</b>	Line		

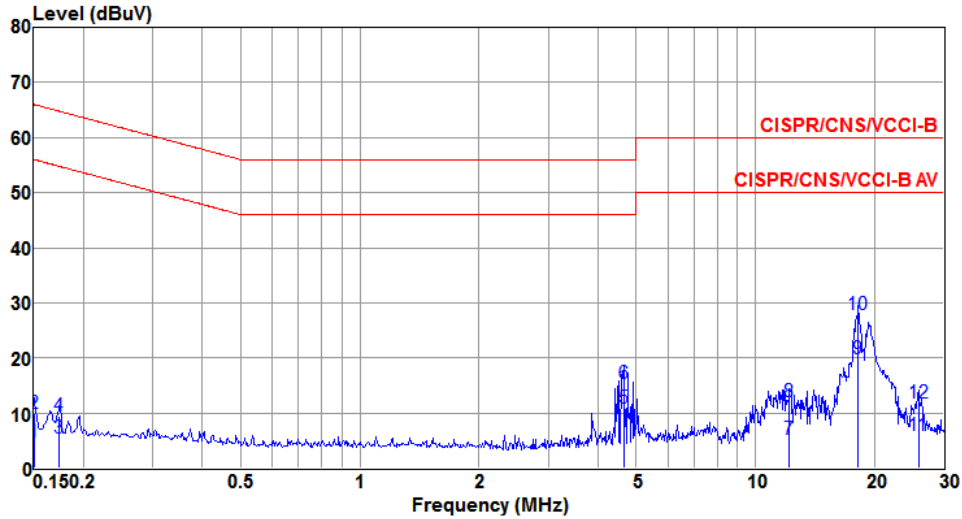

	Freq	Level	Limit	Over	Read	LISN	cable	Remark
	MHz	dBuV	Line	Limit	Level	factor	loss	
			dBuV	dB	dBuV	dB	dB	
1	0.150	4.84	56.00	-51.16	4.71	0.11	0.02	Average
2	0.150	10.02	66.00	-55.98	9.89	0.11	0.02	QP
3	0.174	5.41	54.77	-49.36	5.28	0.11	0.02	Average
4	0.174	9.35	64.77	-55.42	9.22	0.11	0.02	QP
5	4.647	10.83	46.00	-35.17	10.50	0.20	0.13	Average
6	4.647	15.39	56.00	-40.61	15.06	0.20	0.13	QP
7	12.188	5.19	50.00	-44.81	4.73	0.28	0.18	Average
8	12.188	12.05	60.00	-47.95	11.59	0.28	0.18	QP
9	18.232	19.77	50.00	-30.23	19.24	0.35	0.18	Average
10	18.232	27.89	60.00	-32.11	27.36	0.35	0.18	QP
11	25.864	5.88	50.00	-44.12	5.20	0.43	0.25	Average
12	25.864	11.75	60.00	-48.25	11.07	0.43	0.25	QP

Note 1: Level (dBuV) = Read Level (dBuV) + LISN Factor (dB) + Cable Loss (dB).  
 2: Over Limit (dB) = Level (dBuV) – Limit Line (dBuV).

<b>Modulation</b>	HT40	<b>Test Freq. (MHz)</b>	5795
<b>Power Phase</b>	Neutral		

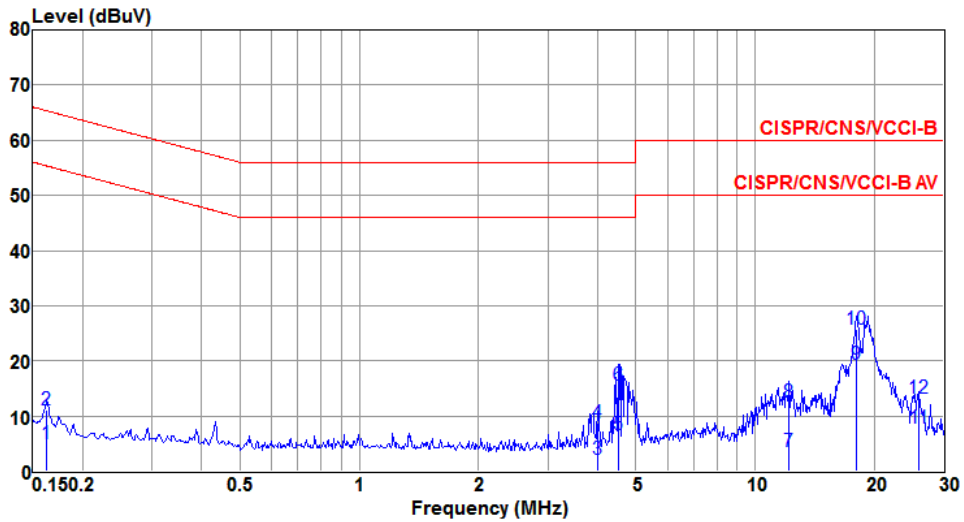

	Freq	Level	Limit	Over	Read	LISN	cable	
	MHz	dBuV	Line	Limit	Level	factor	loss	Remark
			dBuV	dB	dBuV	dB	dB	
1	0.162	5.06	55.34	-50.28	4.92	0.12	0.02	Average
2	0.162	11.05	65.34	-54.29	10.91	0.12	0.02	QP
3	4.006	2.13	46.00	-43.87	1.84	0.17	0.12	Average
4	4.006	8.65	56.00	-47.35	8.36	0.17	0.12	QP
5	4.501	6.70	46.00	-39.30	6.40	0.18	0.12	Average
6	4.501	15.53	56.00	-40.47	15.23	0.18	0.12	QP
7	12.188	3.61	50.00	-46.39	3.12	0.31	0.18	Average
8	12.188	12.51	60.00	-47.49	12.02	0.31	0.18	QP
9 <sup>0</sup>	18.039	19.47	50.00	-30.53	18.91	0.38	0.18	Average
10	18.039	25.81	60.00	-34.19	25.25	0.38	0.18	QP
11	26.001	7.84	50.00	-42.16	7.13	0.46	0.25	Average
12	26.001	13.30	60.00	-46.70	12.59	0.46	0.25	QP

Note 1: Level (dBuV) = Read Level (dBuV) + LISN Factor (dB) + Cable Loss (dB).  
 2: Over Limit (dB) = Level (dBuV) – Limit Line (dBuV).

## 3.2 Emission Bandwidth

### 3.2.1 Limit of Emission Bandwidth

Within the 5.725-5.85 GHz band, the minimum 6 dB bandwidth of U-NII devices shall be at least 500 kHz.

### 3.2.2 Test Procedures

#### 26dB Bandwidth

1. Set RBW = approximately 1% of the emission bandwidth.
2. Set the VBW > RBW, Detector = Peak.
3. Trace mode = max hold.
4. Measure the maximum width of the emission that is 26 dB down from the peak of the emission.

#### Occupied Bandwidth

1. Set RBW = 1 % to 5 % of the OBW
2. Set VBW  $\geq$  3 RBW
3. Sample detection and single sweep mode shall be used
4. Use the 99 % power bandwidth function of the instrument

#### 6dB Bandwidth

1. Set RBW = 100kHz, VBW = 300kHz
2. Detector = Peak, Trace mode = max hold.
3. Allow the trace to stabilize.
4. Measure the maximum width of the emission that is constrained by the frequencies associated with the two outermost amplitude points (upper and lower frequencies) that are attenuated by 6 dB relative to the maximum level measured in the fundamental emission

### 3.2.3 Test Setup

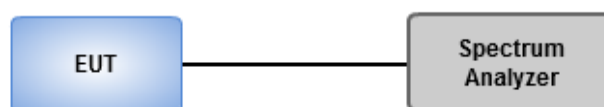

### 3.2.4 Test Result of Emission Bandwidth

For Frequency band 5150~5250 MHz										
Mode	N <sub>TX</sub>	Freq. (MHz)	26dB Bandwidth (MHz)				99% Bandwidth (MHz)			
			Chain 0	Chain 1	Chain 2	Chain 3	Chain 0	Chain 1	Chain 2	Chain 3
11a	2	5180	21.51	30.14	---	---	16.53	16.70	---	---
11a	2	5200	21.68	28.93	---	---	16.56	16.77	---	---
11a	2	5240	21.04	26.14	---	---	16.54	16.61	---	---
HT20	2	5180	22.97	34.35	---	---	17.66	17.73	---	---
HT20	2	5200	21.62	27.48	---	---	17.64	17.73	---	---
HT20	2	5240	21.80	26.96	---	---	17.64	17.71	---	---
HT40	2	5190	42.78	42.67	---	---	35.68	35.76	---	---
HT40	2	5230	44.52	63.88	---	---	35.94	36.32	---	---

For Frequency band 5250~5350 MHz											
Mode	N <sub>TX</sub>	Freq. (MHz)	26dB Bandwidth (MHz)				99% Bandwidth (MHz)				Power Limit (dBm)
			Chain 0	Chain 1	Chain 2	Chain 3	Chain 0	Chain 1	Chain 2	Chain 3	
11a	2	5260	20.87	22.61	---	---	16.52	16.54	---	---	24.00
11a	2	5300	21.16	27.77	---	---	16.54	16.68	---	---	24.00
11a	2	5320	20.99	27.65	---	---	16.53	16.56	---	---	24.00
HT20	2	5260	22.03	27.94	---	---	17.64	17.68	---	---	24.00
HT20	2	5300	22.20	26.09	---	---	17.63	17.74	---	---	24.00
HT20	2	5320	22.09	23.13	---	---	17.64	17.73	---	---	24.00
HT40	2	5270	44.06	51.48	---	---	35.94	36.26	---	---	24.00
HT40	2	5310	43.83	52.41	---	---	35.98	36.16	---	---	24.00

For Frequency band 5470~5725 MHz

Mode	N <sub>TX</sub>	Freq. (MHz)	26dB Bandwidth (MHz)				99% Bandwidth (MHz)				Power Limit (dBm)
			Chain 0	Chain 1	Chain 2	Chain 3	Chain 0	Chain 1	Chain 2	Chain 3	
11a	2	5500	21.39	32.52	---	---	16.56	16.84	---	---	24.00
11a	2	5580	21.91	34.78	---	---	16.63	19.07	---	---	24.00
11a	2	5700	21.10	21.39	---	---	16.59	16.57	---	---	24.00
HT20	2	5500	39.13	38.26	---	---	17.65	17.84	---	---	24.00
HT20	2	5580	22.68	42.22	---	---	17.66	19.02	---	---	24.00
HT20	2	5700	21.45	24.41	---	---	17.64	17.70	---	---	24.00
HT40	2	5510	43.25	44.41	---	---	35.94	36.10	---	---	24.00
HT40	2	5590	47.97	80.00	---	---	36.02	36.88	---	---	24.00
HT40	2	5670	52.06	65.51	---	---	35.94	36.30	---	---	24.00

Worst Plot of 26dB Bandwidth

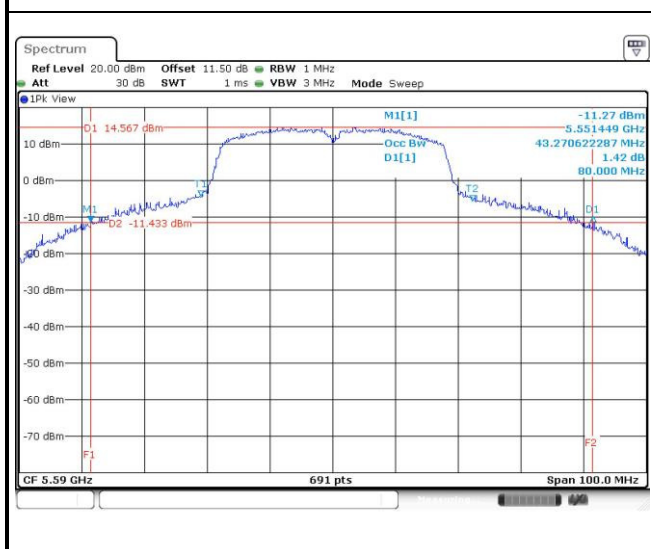

Worst Plot of 99% Bandwidth

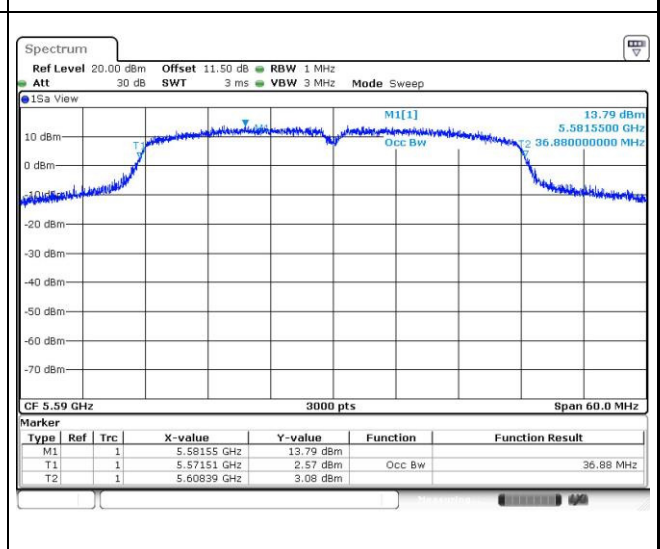

For Frequency band 5725-5850 MHz

Mode	N <sub>TX</sub>	Freq. (MHz)	OBW Bandwidth (MHz)				6dB Bandwidth (MHz)				6dB BW Limit (MHz)
			Chain 0	Chain 1	Chain 2	Chain 3	Chain 0	Chain 1	Chain 2	Chain 3	
11a	2	5745	16.51	16.62	---	---	16.35	16.35	---	---	0.5
11a	2	5785	16.57	16.64	---	---	16.29	16.29	---	---	0.5
11a	2	5825	16.53	17.06	---	---	16.35	16.29	---	---	0.5
HT20	2	5745	17.65	17.69	---	---	16.23	15.13	---	---	0.5
HT20	2	5785	17.72	17.77	---	---	16.52	15.13	---	---	0.5
HT20	2	5825	17.66	18.17	---	---	16.93	15.13	---	---	0.5
HT40	2	5755	35.92	36.04	---	---	35.13	35.13	---	---	0.5
HT40	2	5795	36.26	36.36	---	---	35.13	33.86	---	---	0.5

Worst Plot of 99% Bandwidth

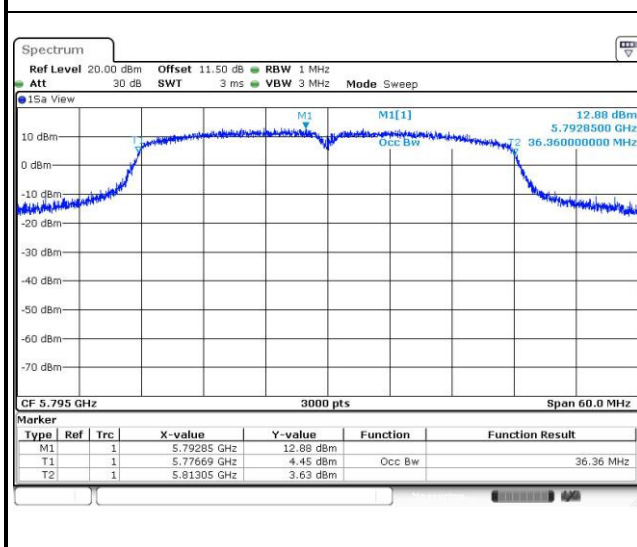

Worst Plot of 6dB Bandwidth

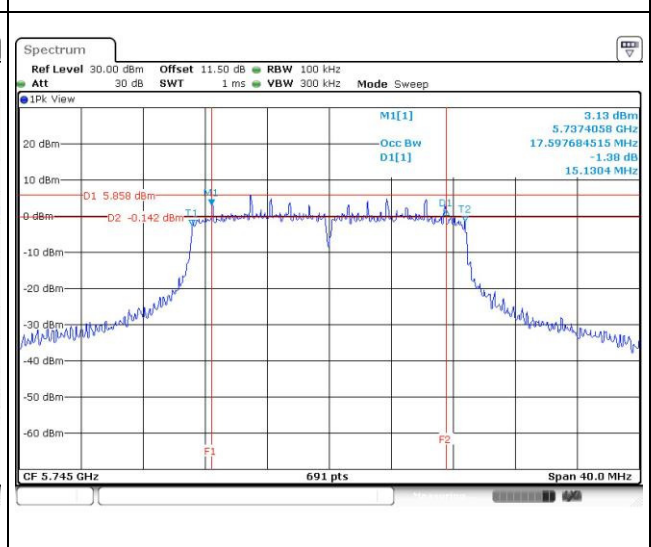

### 3.3 RF Output Power

#### 3.3.1 Limit of RF Output Power

Frequency band 5150-5250 MHz	
Operating Mode	Limit
<input type="checkbox"/> Outdoor access point	Conducted Power: 1 W The maximum e.i.r.p. at any elevation angle above 30 degrees as measured from the horizon must not exceed 125 mW (21 dBm)
<input type="checkbox"/> Indoor access point	Conducted Power: 1 W
<input type="checkbox"/> Fixed point-to-point access points	Conducted Power: 1 W
<input checked="" type="checkbox"/> Mobile and portable client devices	Conducted Power: 250 mW

Frequency Band (MHz)	Limit
<input checked="" type="checkbox"/> 5250 ~ 5350	250mW or 11dBm+10 log B
<input checked="" type="checkbox"/> 5470 ~ 5725	250mW or 11dBm+10 log B
<input checked="" type="checkbox"/> 5725 ~ 5850	1 W

Note: "B" is the 26dB emission bandwidth in MHz.

#### 3.3.2 Test Procedures

- Power meter
  - Measurements is performed using a wideband gated RF power meter provided that the gate parameters are adjusted such that the power is measured only when the EUT is transmitting at its maximum power control level. Since the measurement is made only during the ON time of the transmitter, no duty cycle correction factor is required

#### 3.3.3 Test Setup

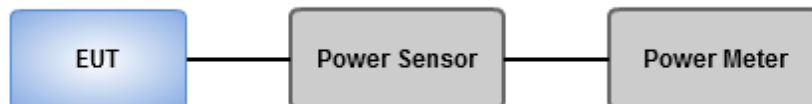

### 3.3.4 Test Result of Maximum Conducted Output Power

For Frequency band 5150~5250 MHz									
Mode	N <sub>TX</sub>	Freq. (MHz)	Conducted Power (dBm)				Total Power (mW)	Total Power (dBm)	Limit (dBm)
			Chain 0	Chain 1	Chain 2	Chain 3			
11a	2	5180	17.64	19.45	---	---	146.181	<b>21.65</b>	24.00
11a	2	5200	17.61	19.32	---	---	143.183	21.56	24.00
11a	2	5240	17.11	18.89	---	---	128.851	21.10	24.00
HT20	2	5180	17.2	19.2	---	---	135.657	21.32	24.00
HT20	2	5200	17.02	18.59	---	---	122.627	20.89	24.00
HT20	2	5240	17.08	18.76	---	---	126.213	21.01	24.00
HT40	2	5190	14.06	17.12	---	---	76.991	18.86	24.00
HT40	2	5230	16.85	19.75	---	---	142.823	21.55	24.00

For Frequency band 5250~5350 MHz									
Mode	N <sub>TX</sub>	Freq. (MHz)	Conducted Power (dBm)				Total Power (mW)	Total Power (dBm)	Limit (dBm)
			Chain 0	Chain 1	Chain 2	Chain 3			
11a	2	5260	17.06	18.01	---	---	114.057	20.57	24.00
11a	2	5300	18.02	19.01	---	---	143.003	<b>21.55</b>	24.00
11a	2	5320	17.45	17.48	---	---	111.566	20.48	24.00
HT20	2	5260	17.12	18.69	---	---	125.483	20.99	24.00
HT20	2	5300	17.02	18.12	---	---	115.214	20.62	24.00
HT20	2	5320	17.3	18.3	---	---	121.311	20.84	24.00
HT40	2	5270	17.58	18.8	---	---	133.137	21.24	24.00
HT40	2	5310	17.44	18.51	---	---	126.420	21.02	24.00

For Frequency band 5470~5725 MHz									
Mode	N <sub>TX</sub>	Freq. (MHz)	Conducted Power (dBm)				Total Power (mW)	Total Power (dBm)	Limit (dBm)
			Chain 0	Chain 1	Chain 2	Chain 3			
11a	2	5500	17.10	17.18	---	---	103.526	20.15	24.00
11a	2	5580	17.21	18.62	---	---	125.380	20.98	24.00
11a	2	5700	15.16	15.62	---	---	69.285	18.41	24.00
HT20	2	5500	16.7	17.9	---	---	108.433	20.35	24.00
HT20	2	5580	16.8	18.46	---	---	118.009	20.72	24.00
HT20	2	5700	15.33	15.82	---	---	72.314	18.59	24.00
HT40	2	5510	15.65	16.36	---	---	79.980	19.03	24.00
HT40	2	5590	17.94	19.35	---	---	148.329	<b>21.71</b>	24.00
HT40	2	5670	17.02	17.47	---	---	106.197	20.26	24.00



For Frequency band 5725-5850 MHz									
Mode	N <sub>TX</sub>	Freq. (MHz)	Conducted Power (dBm)				Total Power (mW)	Total Power (dBm)	Limit (dBm)
			Chain 0	Chain 1	Chain 2	Chain 3			
11a	2	5745	16.23	17.61	---	---	99.653	19.98	30.00
11a	2	5785	17.11	18.03	---	---	114.937	20.60	30.00
11a	2	5825	16.92	18.82	---	---	125.412	20.98	30.00
HT20	2	5745	16.77	16.48	---	---	91.997	19.64	30.00
HT20	2	5785	17.49	17.56	---	---	113.121	20.54	30.00
HT20	2	5825	17.03	18.93	---	---	128.629	21.09	30.00
HT40	2	5755	15.71	16.02	---	---	77.234	18.88	30.00
HT40	2	5795	18.52	18.14	---	---	136.284	<b>21.34</b>	30.00

## 3.4 Peak Power Spectral Density

### 3.4.1 Limit of Peak Power Spectral Density

Frequency band 5150-5250 MHz	
Operating Mode	Limit
<input type="checkbox"/> Outdoor access point	17 dBm / MHz
<input type="checkbox"/> Indoor access point	17 dBm / MHz
<input type="checkbox"/> Fixed point-to-point access points	17 dBm / MHz
<input checked="" type="checkbox"/> Mobile and portable client devices	11 dBm / MHz

Frequency Band (MHz)	Limit
<input checked="" type="checkbox"/> 5250 ~ 5350	11 dBm / MHz
<input checked="" type="checkbox"/> 5470 ~ 5725	11 dBm / MHz
<input checked="" type="checkbox"/> 5725 ~ 5850	30 dBm / 500 kHz

### 3.4.2 Test Procedures

#### For 5150~5250 MHz, 5250~5350 MHz, 5470~5725 MHz

Method SA-1

1. Set RBW = 1 MHz, VBW = 3 MHz, Sweep time = auto, Detector = RMS.
2. Trace average 100 traces.
3. Use the peak marker function to determine the maximum amplitude level.

Method SA-2 Alternative

1. Set RBW = 1 MHz, VBW = 3 MHz, Detector = RMS.
2. Set sweep time  $\geq 10 * (\text{number of points in sweep}) * (\text{total on/off period of the transmitted signal})$ .
3. Perform a single sweep.
4. Use the peak marker function to determine the maximum amplitude level.
5. Add  $10 \log(1/x)$ , where x is the duty cycle.

#### For 5725~5850 MHz

Method SA-1

1. Set RBW = 500 kHz, VBW = 2 MHz, Sweep time = auto, Detector = RMS.
2. Trace average 100 traces.
3. Use the peak marker function to determine the maximum amplitude level.

Method SA-2 Alternative

1. Set RBW = 500 kHz, VBW = 2 MHz, Detector = RMS.
2. Set sweep time  $\geq 10 * (\text{number of points in sweep}) * (\text{total on/off period of the transmitted signal})$ .
3. Perform a single sweep.
4. Use the peak marker function to determine the maximum amplitude level.
5. Add  $10 \log(1/x)$ , where x is the duty cycle.

### 3.4.3 Test Setup

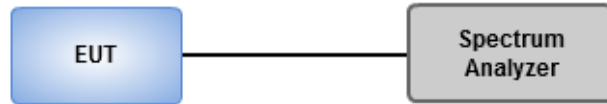

### 3.4.4 Test Result of Peak Power Spectral Density

Frequency band			5150~5250 MHz / 5250~5350 MHz			
Condition			Peak Power Spectral Density (dBm/MHz)			
Mode	N <sub>TX</sub>	Freq. (MHz)	PPSD w/o D.F (dBm/MHz)	Duty Factor (dB)	PPSD with D.F (dBm/MHz)	PPSD Limit (dBm/MHz)
11a	2	5180	8.09	0.00	8.09	10.09
11a	2	5200	8.30	0.00	8.30	10.09
11a	2	5240	8.12	0.00	8.12	10.09
HT20	2	5180	7.33	0.00	7.33	10.09
HT20	2	5200	7.10	0.00	7.10	10.09
HT20	2	5240	7.19	0.00	7.19	10.09
HT40	2	5190	2.32	0.00	2.32	10.09
HT40	2	5230	5.80	0.00	5.80	10.09
11a	2	5260	7.63	0.00	7.63	10.09
11a	2	5300	8.58	0.00	<b>8.58</b>	10.09
11a	2	5320	7.92	0.00	7.92	10.09
HT20	2	5260	7.21	0.00	7.21	10.09
HT20	2	5300	7.42	0.00	7.42	10.09
HT20	2	5320	7.15	0.00	7.15	10.09
HT40	2	5270	5.72	0.00	5.72	10.09
HT40	2	5310	5.89	0.00	5.89	10.09

Note:

1. D.F is duty factor.
2. Test result is bin-by-bin summing measured value of each TX port.
3. Directional gain =  $3.9 + 10 * \log(2/1) = 6.91$  dBi > 6 dBi.  
For 5150~5350MHz:  
Limit shall be reduced to 11 dBm – (6.91 dBi – 6 dBi) = 10.09 dBm.

Frequency band			5470~5725 MHz			
Condition			Peak Power Spectral Density (dBm/MHz)			
Mode	N <sub>TX</sub>	Freq. (MHz)	PPSD w/o D.F (dBm/MHz)	Duty Factor (dB)	PPSD with D.F (dBm/MHz)	PPSD Limit (dBm/MHz)
11a	2	5500	7.65	0.00	7.65	9.99
11a	2	5580	7.24	0.00	7.24	9.99
11a	2	5700	6.30	0.00	6.30	9.99
HT20	2	5500	6.66	0.00	6.66	9.99
HT20	2	5580	6.95	0.00	6.95	9.99
HT20	2	5700	5.60	0.00	5.60	9.99
HT40	2	5510	3.57	0.00	3.57	9.99
HT40	2	5590	5.47	0.00	5.47	9.99
HT40	2	5670	4.28	0.00	4.28	9.99

Note:

1. D.F is duty factor.
2. Test result is bin-by-bin summing measured value of each TX port.
3. Directional gain =  $4 + 10 * \log(2/1) = 7.01 \text{ dBi} > 6 \text{ dBi}$ .  
For 5500~5700MHz:  
Limit shall be reduced to  $11 \text{ dBm} - (7.01 \text{ dBi} - 6 \text{ dBi}) = 9.99 \text{ dBm}$ .

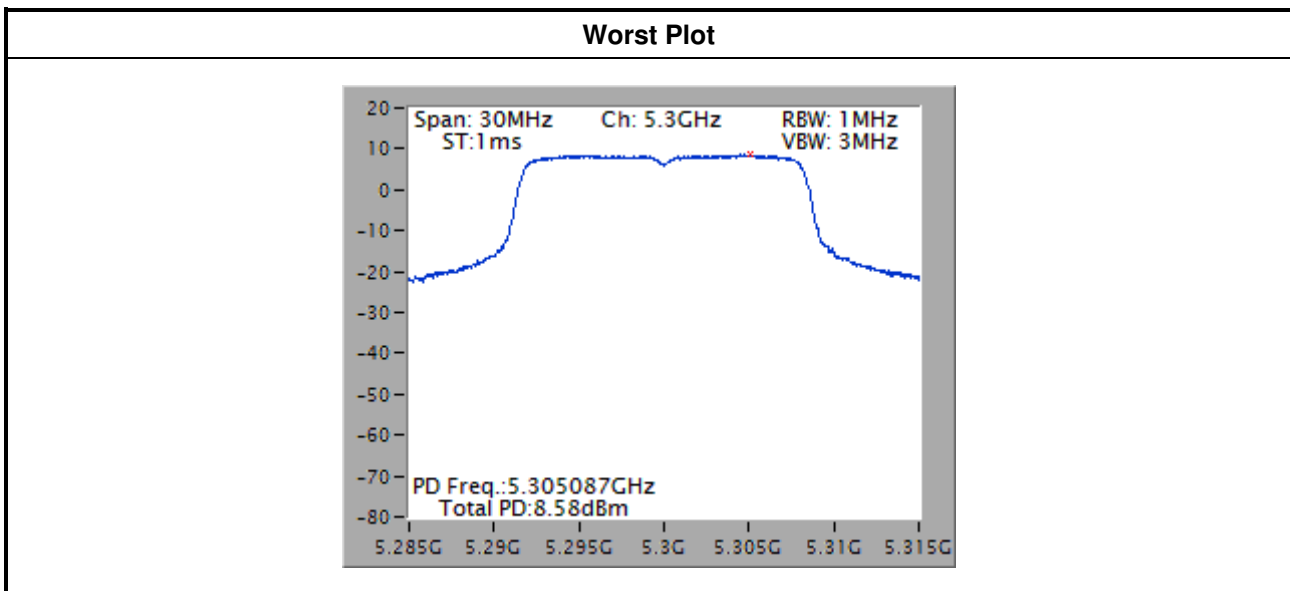

Frequency band			5725-5850 MHz			
Condition			Peak Power Spectral Density (dBm/500kHz)			
Mode	N <sub>TX</sub>	Freq. (MHz)	PPSD w/o D.F (dBm/500kHz)	Duty Factor (dB)	PPSD with D.F (dBm/500kHz)	PPSD Limit (dBm/500kHz)
11a	2	5745	4.62	0.00	4.62	28.99
11a	2	5785	5.19	0.00	5.19	28.99
11a	2	5825	5.71	0.00	<b>5.71</b>	28.99
HT20	2	5745	3.86	0.00	3.86	28.99
HT20	2	5785	4.90	0.00	4.90	28.99
HT20	2	5825	5.49	0.00	5.49	28.99
HT40	2	5755	1.80	0.00	1.80	28.99
HT40	2	5795	3.93	0.00	3.93	28.99

Note:

1. D.F is duty factor.
2. Test result is bin-by-bin summing measured value of each TX port.
3. Directional gain =  $4 + 10 * \log(2/1) = 7.01 \text{ dBi} > 6 \text{ dBi}$ .  
For 5745~5825MHz:  
Limit shall be reduced to  $30 \text{ dBm} - (7.01 \text{ dBi} - 6 \text{ dBi}) = 28.99 \text{ dBm}$ .

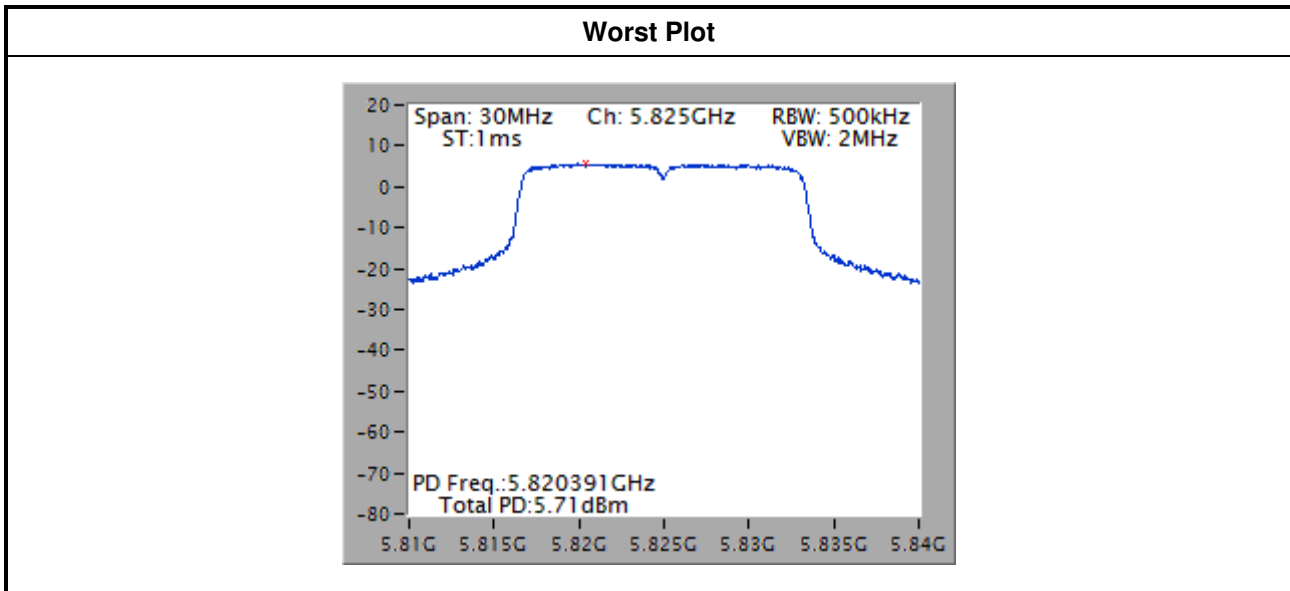

### 3.5 Transmitter Radiated and Band Edge Emissions

#### 3.5.1 Limit of Transmitter Radiated and Band Edge Emissions

Restricted Band Emissions Limit			
Frequency Range (MHz)	Field Strength (uV/m)	Field Strength (dBuV/m)	Measure Distance (m)
0.009~0.490	2400/F(kHz)	48.5 - 13.8	300
0.490~1.705	24000/F(kHz)	33.8 - 23	30
1.705~30.0	30	29	30
30~88	100	40	3
88~216	150	43.5	3
216~960	200	46	3
Above 960	500	54	3

**Note 1:**  
Qusai-Peak value is measured for frequency below 1GHz except for 9–90 kHz, 110–490 kHz frequency band. Peak and average value are measured for frequency above 1GHz. The limit on average radio frequency emission is as above table. The limit on peak radio frequency emissions is 20 dB above the maximum permitted average emission limit

**Note 2:**  
Measurements may be performed at a distance other than what is specified provided. When performing measurements at a distance other than that specified, the results shall be extrapolated to the specified distance using an extrapolation factor as below, Frequency at or above 30 MHz: 20 dB/decade Frequency below 30 MHz: 40 dB/decade.

Un-restricted band emissions above 1GHz Limit	
Operating Band	Limit
5.15 - 5.25 GHz	e.i.r.p. -27 dBm [68.2 dBuV/m@3m]
5.25 - 5.35 GHz	e.i.r.p. -27 dBm [68.2 dBuV/m@3m]
5.47 - 5.725 GHz	e.i.r.p. -27 dBm [68.2 dBuV/m@3m]
5.725 - 5.850 GHz	5.715 5.725 GHz: e.i.r.p. -17 dBm [78.2 dBuV/m@3m] 5.825 5.835 GHz: e.i.r.p. -17 dBm [78.2 dBuV/m@3m] Other un-restricted band: e.i.r.p. -27 dBm [68.2 dBuV/m@3m]

**Note 1:** Measurements may be performed at a distance other than the limit distance provided they are not performed in the near field and the emissions to be measured can be detected by the measurement equipment. When performing measurements at a distance other than that specified, the results shall be extrapolated to the specified distance using an extrapolation factor of 20 dB/decade (inverse of linear distance for field-strength measurements, inverse of linear distance-squared for power-density measurements).

### 3.5.2 Test Procedures

1. Measurement is made at a semi-anechoic chamber that incorporates a turntable allowing a EUT rotation of 360°. A continuously-rotating, remotely-controlled turntable is installed at the test site to support the EUT and facilitate determination of the direction of maximum radiation for each EUT emission frequency. The EUT is placed at test table. For emissions testing at or below 1 GHz, the table height is 80 cm above the reference ground plane. For emission measurements above 1 GHz, the table height is 1.5 m
2. Measurement is made with the antenna positioned in both the horizontal and vertical planes of polarization. The measurement antenna is varied in height (1 m ~ 4m) above the reference ground plane to obtain the maximum signal strength. Distance between EUT and antenna is 3 m.
3. This investigation is performed with the EUT rotated 360°, the antenna height scanned between 1 m and 4 m, and the antenna rotated to repeat the measurements for both the horizontal and vertical antenna polarizations.

Note:

1. 120kHz measurement bandwidth of test receiver and Quasi-peak detector is for radiated emission below 1GHz.
2. RBW=1MHz, VBW=3MHz and Peak detector is for peak measured value of radiated emission above 1GHz.
3. RBW=1MHz, VBW=1/T and Peak detector is for average measured value of radiated emission above 1GHz.



### 3.5.3 Test Setup

#### Radiated Emissions below 1 GHz

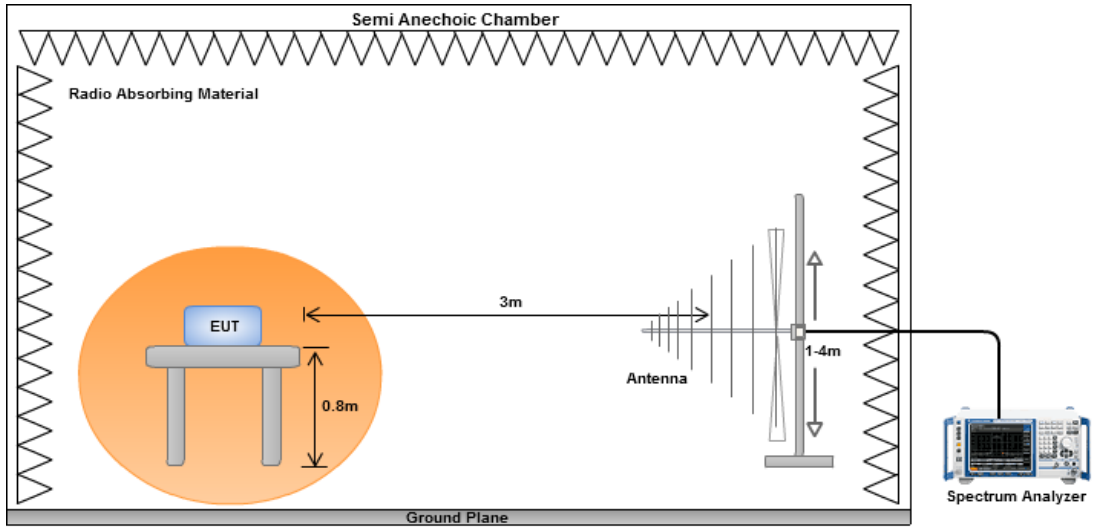

#### Radiated Emissions above 1 GHz

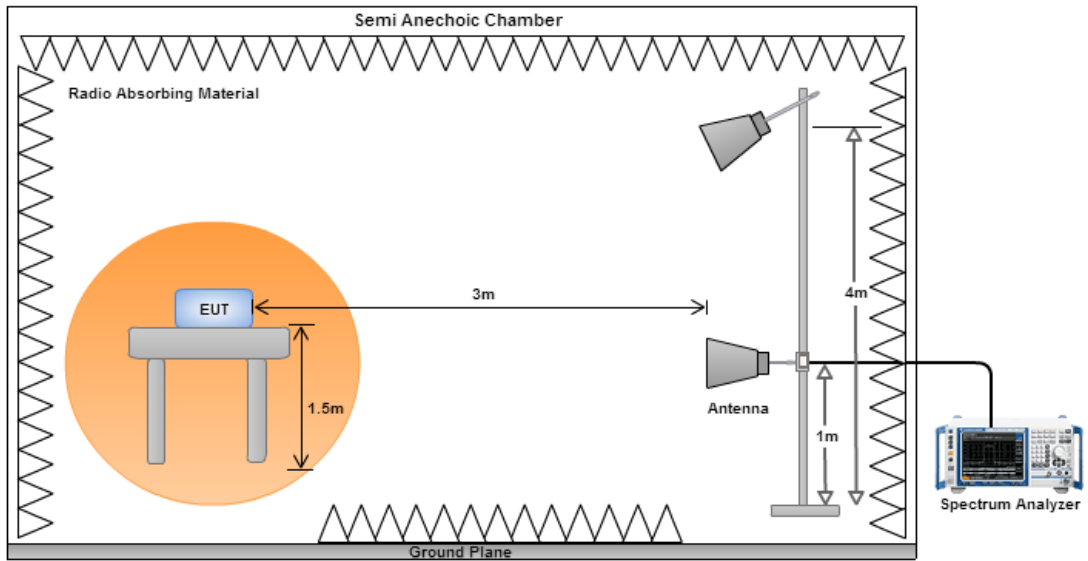

### Test Configuration 1: Dipole antenna

#### 3.5.4 Transmitter Radiated Unwanted Emissions (Below 1GHz)

<b>Modulation</b>	HT40	<b>Test Freq. (MHz)</b>	5590
<b>Polarization</b>	Horizontal	<b>Test Configuration</b>	1

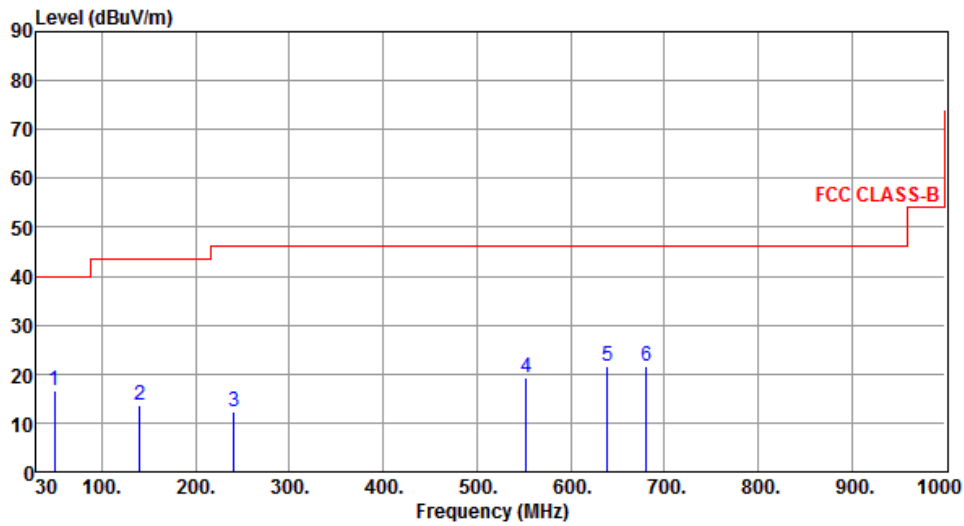

	Freq. MHz	Emission level dBuV/m	Limit dBuV/m	Margin dB	SA reading dBuV	Factor dB	Remark	ANT High cm	Turn Table deg
1	49.40	16.75	40.00	-23.25	29.69	-12.94	Peak	---	---
2	140.58	13.67	43.50	-29.83	27.40	-13.73	Peak	---	---
3	240.49	12.34	46.00	-33.66	27.09	-14.75	Peak	---	---
4	552.83	19.30	46.00	-26.70	26.33	-7.03	Peak	---	---
5	639.16	21.73	46.00	-24.27	26.96	-5.23	Peak	---	---
6	680.87	21.74	46.00	-24.26	26.41	-4.67	Peak	---	---

Note 1: Emission Level (dBuV/m) = SA Reading (dBuV/m) + Factor\* (dB)

\*Factor includes antenna factor , cable loss and amplifier gain

Note 2: Margin (dB) = Emission level (dBuV/m) – Limit (dBuV/m).

Note 3: All spurious emissions below 30MHz are more than 20 dB below the limit.

<b>Modulation</b>	HT40	<b>Test Freq. (MHz)</b>	5590
<b>Polarization</b>	Vertical	<b>Test Configuration</b>	1

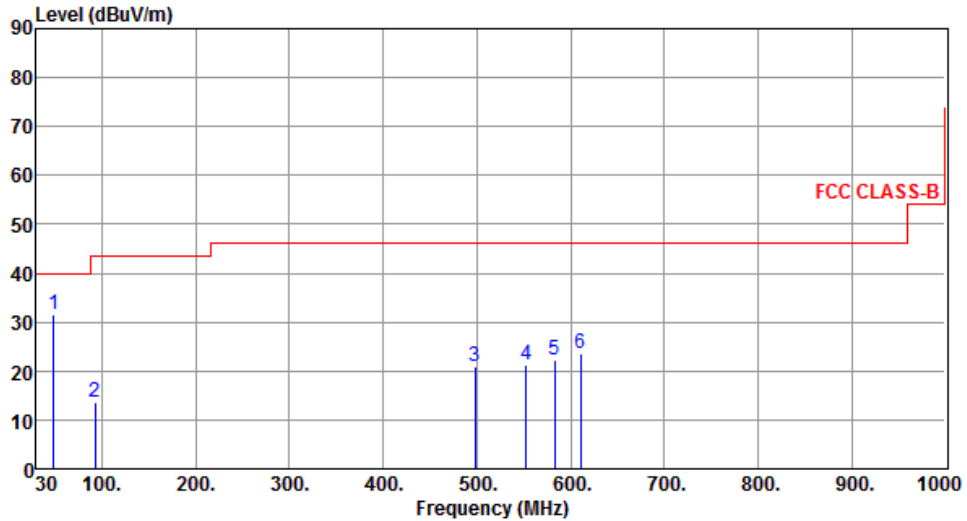

	Freq. MHz	Emission level dBuV/m	Limit dBuV/m	Margin dB	SA reading dBuV	Factor dB	Remark	ANT High cm	Turn Table deg
1	48.43	31.39	40.00	-8.61	44.30	-12.91	Peak	---	---
2	93.05	13.71	43.50	-29.79	32.92	-19.21	Peak	---	---
3	498.51	20.81	46.00	-25.19	28.50	-7.69	Peak	---	---
4	552.83	21.22	46.00	-24.78	28.25	-7.03	Peak	---	---
5	582.90	22.12	46.00	-23.88	28.37	-6.25	Peak	---	---
6	611.03	23.46	46.00	-22.54	29.09	-5.63	Peak	---	---

Note 1: Emission Level (dBuV/m) = SA Reading (dBuV/m) + Factor\* (dB)

\*Factor includes antenna factor , cable loss and amplifier gain

Note 2: Margin (dB) = Emission level (dBuV/m) – Limit (dBuV/m).

Note 3: All spurious emissions below 30MHz are more than 20 dB below the limit.

<b>Modulation</b>	HT40	<b>Test Freq. (MHz)</b>	5795
<b>Polarization</b>	Horizontal	<b>Test Configuration</b>	1

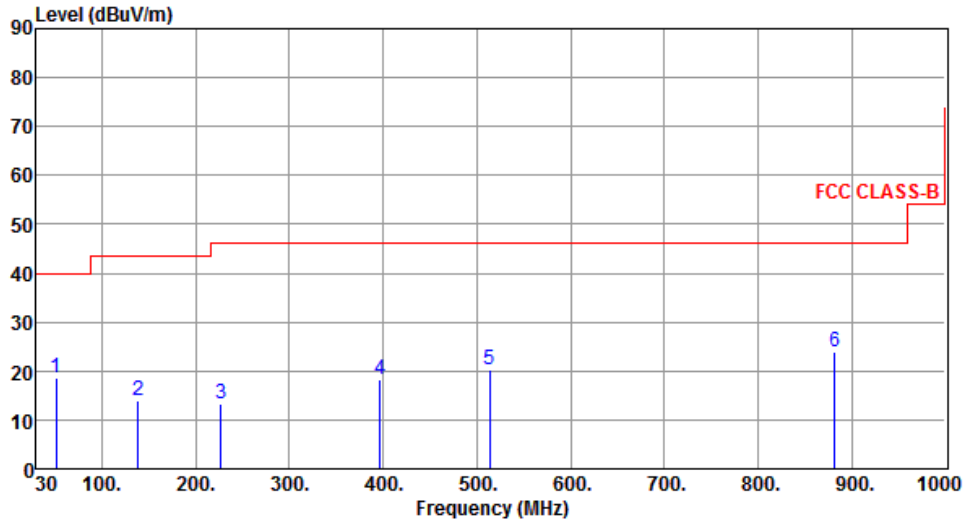

	Freq. MHz	Emission level dBuV/m	Limit dBuV/m	Margin dB	SA reading dBuV	Factor dB	Remark	ANT High cm	Turn Table deg
1	51.34	18.74	40.00	-21.26	31.87	-13.13	Peak	---	---
2	138.64	13.94	43.50	-29.56	27.81	-13.87	Peak	---	---
3	226.91	13.31	46.00	-32.69	28.87	-15.56	Peak	---	---
4	396.66	18.19	46.00	-27.81	28.32	-10.13	Peak	---	---
5	514.03	20.30	46.00	-25.70	27.79	-7.49	Peak	---	---
6	881.66	24.03	46.00	-21.97	25.14	-1.11	Peak	---	---

Note 1: Emission Level (dBuV/m) = SA Reading (dBuV/m) + Factor\* (dB)

\*Factor includes antenna factor , cable loss and amplifier gain

Note 2: Margin (dB) = Emission level (dBuV/m) – Limit (dBuV/m).

Note 3: All spurious emissions below 30MHz are more than 20 dB below the limit.

<b>Modulation</b>	HT40	<b>Test Freq. (MHz)</b>	5795
<b>Polarization</b>	Vertical	<b>Test Configuration</b>	1

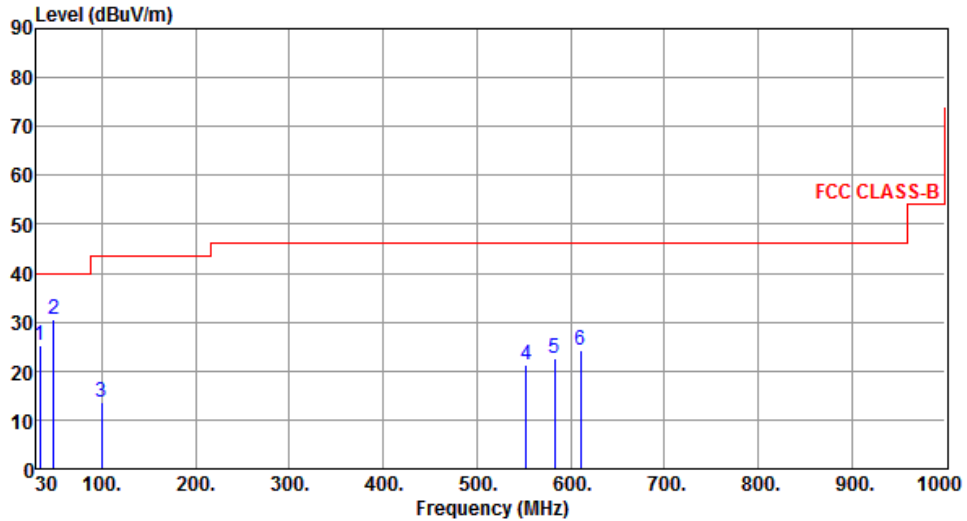

	Freq. MHz	Emission level dBuV/m	Limit dBuV/m	Margin dB	SA reading dBuV	Factor dB	Remark	ANT High cm	Turn Table deg
1	33.88	25.13	40.00	-14.87	38.62	-13.49	Peak	---	---
2	48.43	30.51	40.00	-9.49	43.42	-12.91	Peak	---	---
3	99.84	13.76	43.50	-29.74	32.25	-18.49	Peak	---	---
4	552.83	21.20	46.00	-24.80	28.23	-7.03	Peak	---	---
5	582.90	22.63	46.00	-23.37	28.88	-6.25	Peak	---	---
6	611.03	24.33	46.00	-21.67	29.96	-5.63	Peak	---	---

Note 1: Emission Level (dBuV/m) = SA Reading (dBuV/m) + Factor\* (dB)

\*Factor includes antenna factor , cable loss and amplifier gain

Note 2: Margin (dB) = Emission level (dBuV/m) – Limit (dBuV/m).

Note 3: All spurious emissions below 30MHz are more than 20 dB below the limit.

### 3.5.5 Transmitter Radiated Unwanted Emissions (Above 1GHz) for 11a

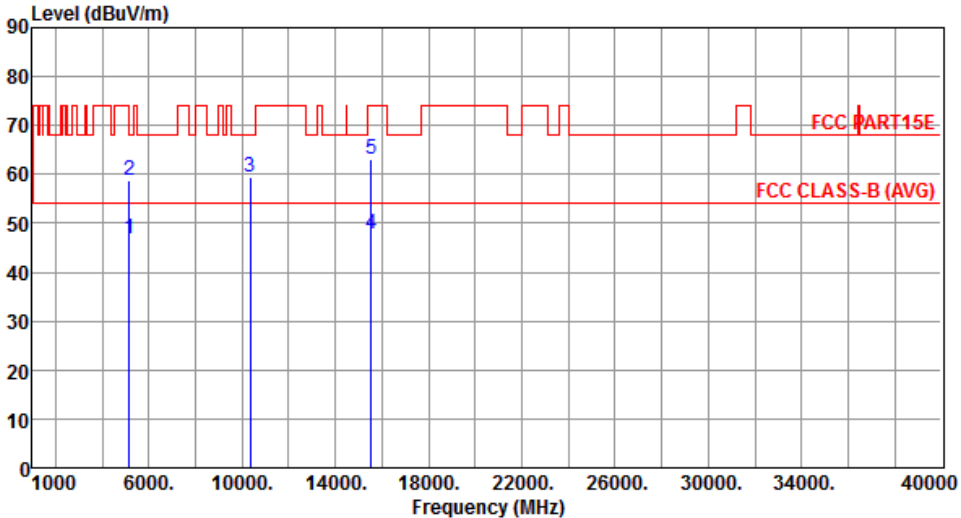
Modulation	11a	Test Freq. (MHz)	5180																																																																					
Polarization	Horizontal	Test Configuration	1																																																																					
																																																																								
	<table border="1"> <thead> <tr> <th>Freq.</th> <th>Emission level</th> <th>Limit</th> <th>Margin</th> <th>SA reading</th> <th>Factor</th> <th>Remark</th> <th>ANT High</th> <th>Turn Table</th> </tr> <tr> <th>MHz</th> <th>dBuV/m</th> <th>dBuV/m</th> <th>dB</th> <th>dBuV</th> <th>dB</th> <th></th> <th>cm</th> <th>deg</th> </tr> </thead> <tbody> <tr> <td>1</td> <td>5150.00</td> <td>46.92</td> <td>54.00</td> <td>-7.08</td> <td>40.61</td> <td>6.31</td> <td>Average</td> <td>150</td> <td>344</td> </tr> <tr> <td>2</td> <td>5150.00</td> <td>58.90</td> <td>74.00</td> <td>-15.10</td> <td>52.59</td> <td>6.31</td> <td>Peak</td> <td>150</td> <td>344</td> </tr> <tr> <td>3</td> <td>10360.00</td> <td>59.60</td> <td>68.20</td> <td>-8.60</td> <td>43.26</td> <td>16.34</td> <td>Peak</td> <td>304</td> <td>56</td> </tr> <tr> <td>4</td> <td>15540.00</td> <td>47.84</td> <td>54.00</td> <td>-6.16</td> <td>30.34</td> <td>17.50</td> <td>Average</td> <td>305</td> <td>300</td> </tr> <tr> <td>5</td> <td>15540.00</td> <td>63.08</td> <td>74.00</td> <td>-10.92</td> <td>45.58</td> <td>17.50</td> <td>Peak</td> <td>305</td> <td>300</td> </tr> </tbody> </table>	Freq.	Emission level	Limit	Margin	SA reading	Factor	Remark	ANT High	Turn Table	MHz	dBuV/m	dBuV/m	dB	dBuV	dB		cm	deg	1	5150.00	46.92	54.00	-7.08	40.61	6.31	Average	150	344	2	5150.00	58.90	74.00	-15.10	52.59	6.31	Peak	150	344	3	10360.00	59.60	68.20	-8.60	43.26	16.34	Peak	304	56	4	15540.00	47.84	54.00	-6.16	30.34	17.50	Average	305	300	5	15540.00	63.08	74.00	-10.92	45.58	17.50	Peak	305	300			
Freq.	Emission level	Limit	Margin	SA reading	Factor	Remark	ANT High	Turn Table																																																																
MHz	dBuV/m	dBuV/m	dB	dBuV	dB		cm	deg																																																																
1	5150.00	46.92	54.00	-7.08	40.61	6.31	Average	150	344																																																															
2	5150.00	58.90	74.00	-15.10	52.59	6.31	Peak	150	344																																																															
3	10360.00	59.60	68.20	-8.60	43.26	16.34	Peak	304	56																																																															
4	15540.00	47.84	54.00	-6.16	30.34	17.50	Average	305	300																																																															
5	15540.00	63.08	74.00	-10.92	45.58	17.50	Peak	305	300																																																															
<p>Note 1: Emission Level (dBuV/m) = SA Reading (dBuV/m) + Factor* (dB)            *Factor includes antenna factor , cable loss and amplifier gain            Note 2: Margin (dB) = Emission level (dBuV/m) – Limit (dBuV/m).</p>																																																																								

<b>Modulation</b>	11a	<b>Test Freq. (MHz)</b>	5180
<b>Polarization</b>	Vertical	<b>Test Configuration</b>	1

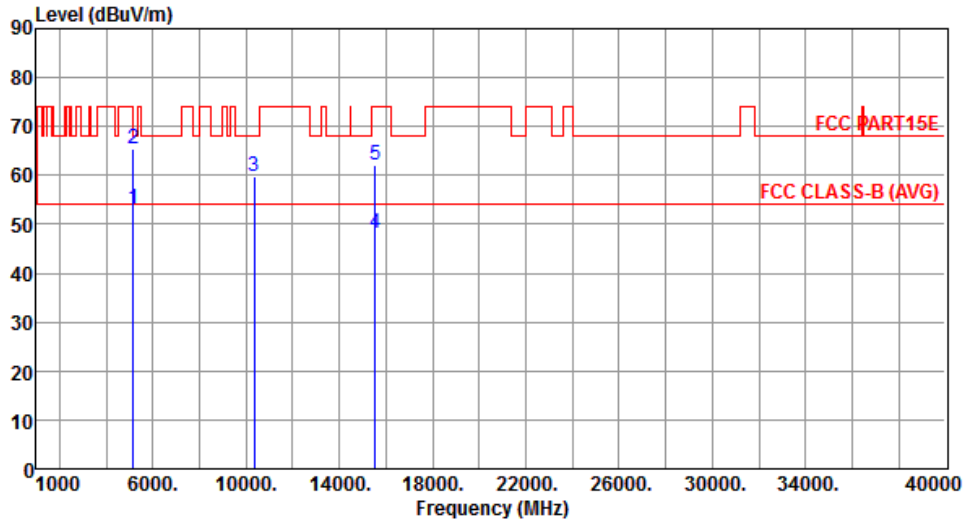

	Freq. MHz	Emission level dBuV/m	Limit dBuV/m	Margin dB	SA reading dBuV	Factor dB	Remark	ANT High cm	Turn Table deg
1	5150.00	53.20	54.00	-0.80	46.89	6.31	Average	155	20
2	5150.00	65.46	74.00	-8.54	59.15	6.31	Peak	155	20
3	10360.00	59.88	68.20	-8.32	43.54	16.34	Peak	284	309
4	15540.00	48.09	54.00	-5.91	30.59	17.50	Average	100	328
5	15540.00	62.02	74.00	-11.98	44.52	17.50	Peak	100	328

Note 1: Emission Level (dBuV/m) = SA Reading (dBuV/m) + Factor\* (dB)

\*Factor includes antenna factor , cable loss and amplifier gain

Note 2: Margin (dB) = Emission level (dBuV/m) – Limit (dBuV/m).

<b>Modulation</b>	11a	<b>Test Freq. (MHz)</b>	5200
<b>Polarization</b>	Horizontal	<b>Test Configuration</b>	1

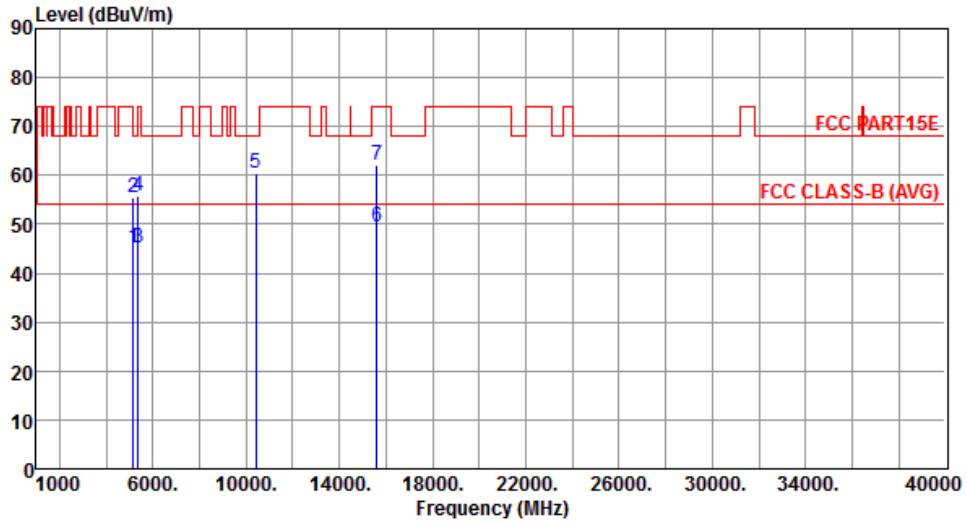

	Freq. MHz	Emission level dBuV/m	Limit dBuV/m	Margin dB	SA reading dBuV	Factor dB	Remark	ANT High cm	Turn Table deg
1	5150.00	45.12	54.00	-8.88	38.81	6.31	Average	318	233
2	5150.00	55.35	74.00	-18.65	49.04	6.31	Peak	318	233
3	5350.00	45.14	54.00	-8.86	38.52	6.62	Average	318	233
4	5350.00	55.68	74.00	-18.32	49.06	6.62	Peak	318	233
5	10400.00	60.43	68.20	-7.77	44.01	16.42	Peak	291	104
6	15600.00	49.64	54.00	-4.36	32.26	17.38	Average	220	31
7	15600.00	61.94	74.00	-12.06	44.56	17.38	Peak	220	31

Note 1: Emission Level (dBuV/m) = SA Reading (dBuV/m) + Factor\* (dB)

\*Factor includes antenna factor , cable loss and amplifier gain

Note 2: Margin (dB) = Emission level (dBuV/m) – Limit (dBuV/m).



<b>Modulation</b>	11a	<b>Test Freq. (MHz)</b>	5200
<b>Polarization</b>	Vertical	<b>Test Configuration</b>	1

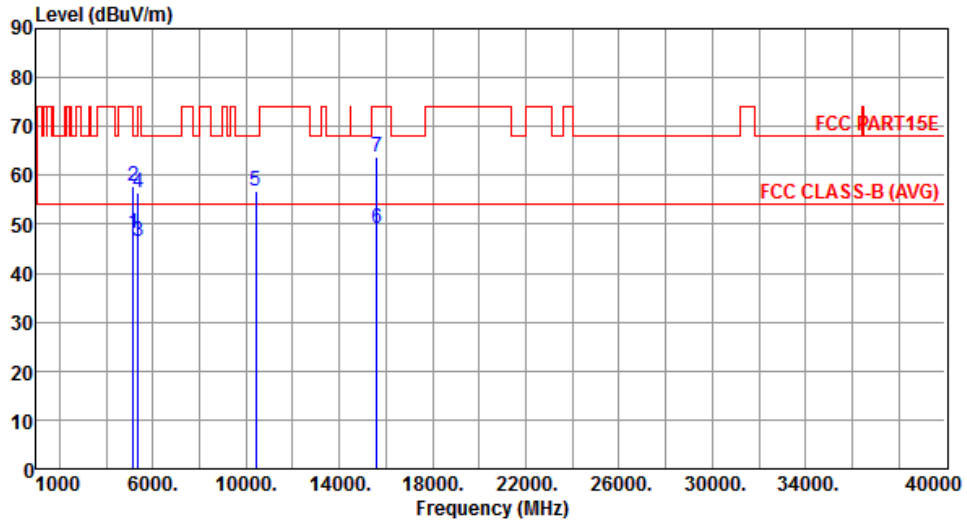

	Freq. MHz	Emission level dBuV/m	Limit dBuV/m	Margin dB	SA reading dBuV	Factor dB	Remark	ANT High cm	Turn Table deg
1	5150.00	48.22	54.00	-5.78	41.91	6.31	Average	142	141
2	5150.00	57.75	74.00	-16.25	51.44	6.31	Peak	142	141
3	5350.00	46.51	54.00	-7.49	39.89	6.62	Average	142	141
4	5350.00	56.40	74.00	-17.60	49.78	6.62	Peak	142	141
5	10400.00	56.67	68.20	-11.53	40.25	16.42	Peak	234	160
6	15600.00	49.05	54.00	-4.95	31.67	17.38	Average	132	358
7	15600.00	63.82	74.00	-10.18	46.44	17.38	Peak	132	358

Note 1: Emission Level (dBuV/m) = SA Reading (dBuV/m) + Factor\* (dB)

\*Factor includes antenna factor , cable loss and amplifier gain

Note 2: Margin (dB) = Emission level (dBuV/m) – Limit (dBuV/m).

<b>Modulation</b>	11a	<b>Test Freq. (MHz)</b>	5240
<b>Polarization</b>	Horizontal	<b>Test Configuration</b>	1

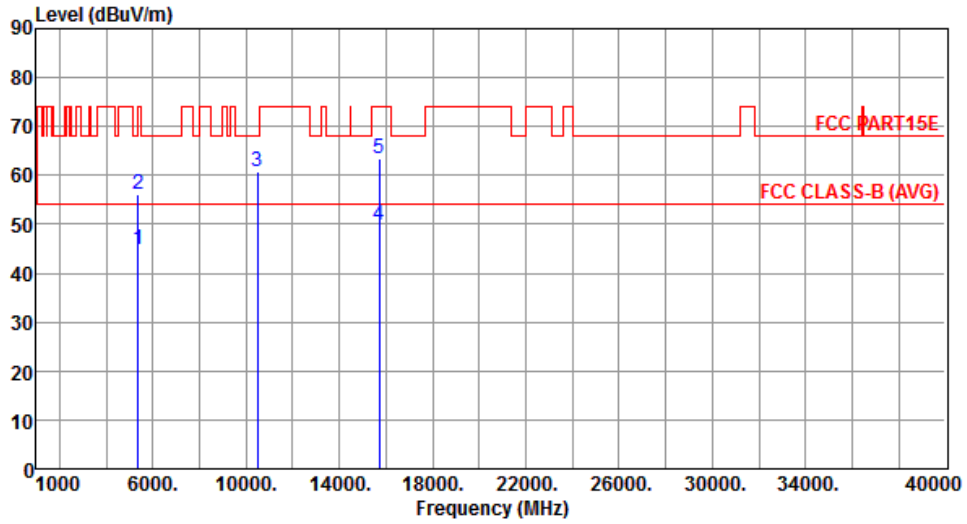

	Freq. MHz	Emission level dBuV/m	Limit dBuV/m	Margin dB	SA reading dBuV	Factor dB	Remark	ANT High cm	Turn Table deg
1	5350.00	44.88	54.00	-9.12	38.26	6.62	Average	322	236
2	5350.00	56.29	74.00	-17.71	49.67	6.62	Peak	322	236
3	10480.00	60.83	68.20	-7.37	44.27	16.56	Peak	189	354
4	15720.00	49.80	54.00	-4.20	32.65	17.15	Average	321	301
5	15720.00	63.36	74.00	-10.64	46.21	17.15	Peak	321	301

Note 1: Emission Level (dBuV/m) = SA Reading (dBuV/m) + Factor\* (dB)

\*Factor includes antenna factor , cable loss and amplifier gain

Note 2: Margin (dB) = Emission level (dBuV/m) – Limit (dBuV/m).

<b>Modulation</b>	11a	<b>Test Freq. (MHz)</b>	5240
<b>Polarization</b>	Vertical	<b>Test Configuration</b>	1

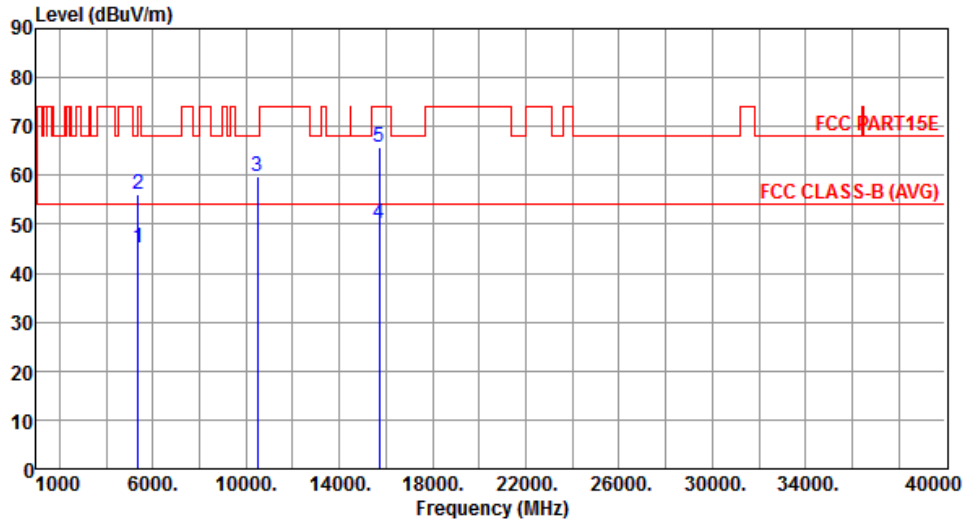

	Freq. MHz	Emission level dBuV/m	Limit dBuV/m	Margin dB	SA reading dBuV	Factor dB	Remark	ANT High cm	Turn Table deg
1	5350.00	45.04	54.00	-8.96	38.42	6.62	Average	132	30
2	5350.00	55.98	74.00	-18.02	49.36	6.62	Peak	132	30
3	10480.00	59.91	68.20	-8.29	43.35	16.56	Peak	281	246
4	15720.00	50.15	54.00	-3.85	33.00	17.15	Average	305	267
5	15720.00	65.82	74.00	-8.18	48.67	17.15	Peak	305	267

Note 1: Emission Level (dBuV/m) = SA Reading (dBuV/m) + Factor\* (dB)

\*Factor includes antenna factor , cable loss and amplifier gain

Note 2: Margin (dB) = Emission level (dBuV/m) – Limit (dBuV/m).

<b>Modulation</b>	11a	<b>Test Freq. (MHz)</b>	5260
<b>Polarization</b>	Horizontal	<b>Test Configuration</b>	1

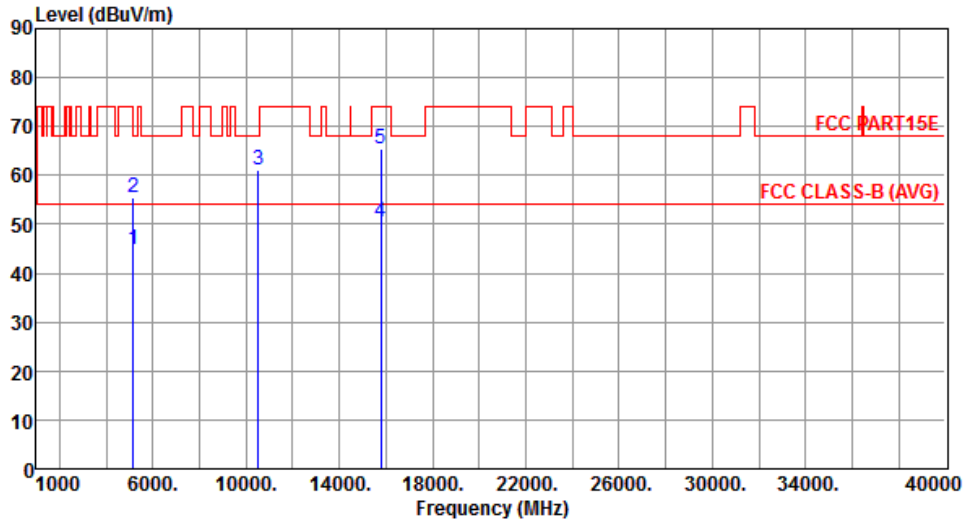

	Freq. MHz	Emission level dBuV/m	Limit dBuV/m	Margin dB	SA reading dBuV	Factor dB	Remark	ANT High cm	Turn Table deg
1	5150.00	44.89	54.00	-9.11	38.58	6.31	Average	302	221
2	5150.00	55.36	74.00	-18.64	49.05	6.31	Peak	302	221
3	10520.00	61.20	68.20	-7.00	44.60	16.60	Peak	236	187
4	15780.00	50.60	54.00	-3.40	33.55	17.05	Average	324	297
5	15780.00	65.28	74.00	-8.72	48.23	17.05	Peak	324	297

Note 1: Emission Level (dBuV/m) = SA Reading (dBuV/m) + Factor\* (dB)

\*Factor includes antenna factor , cable loss and amplifier gain

Note 2: Margin (dB) = Emission level (dBuV/m) – Limit (dBuV/m).

<b>Modulation</b>	11a	<b>Test Freq. (MHz)</b>	5260
<b>Polarization</b>	Vertical	<b>Test Configuration</b>	1

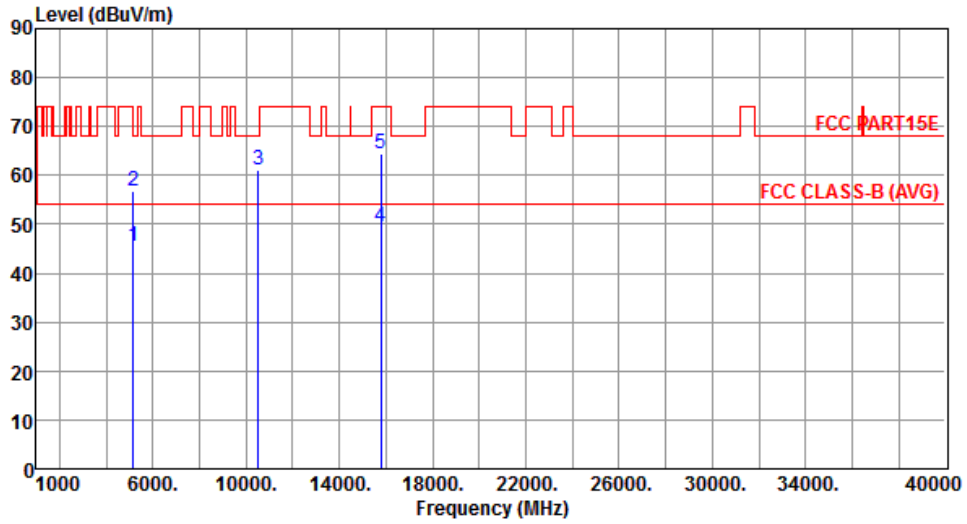

	Freq. MHz	Emission level dBuV/m	Limit dBuV/m	Margin dB	SA reading dBuV	Factor dB	Remark	ANT High cm	Turn Table deg
1	5150.00	45.46	54.00	-8.54	39.15	6.31	Average	140	36
2	5150.00	56.66	74.00	-17.34	50.35	6.31	Peak	140	36
3	10520.00	61.16	68.20	-7.04	44.56	16.60	Peak	139	267
4	15780.00	49.64	54.00	-4.36	32.59	17.05	Average	113	346
5	15780.00	64.41	74.00	-9.59	47.36	17.05	Peak	113	346

Note 1: Emission Level (dBuV/m) = SA Reading (dBuV/m) + Factor\* (dB)

\*Factor includes antenna factor , cable loss and amplifier gain

Note 2: Margin (dB) = Emission level (dBuV/m) – Limit (dBuV/m).

<b>Modulation</b>	11a	<b>Test Freq. (MHz)</b>	5300
<b>Polarization</b>	Horizontal	<b>Test Configuration</b>	1

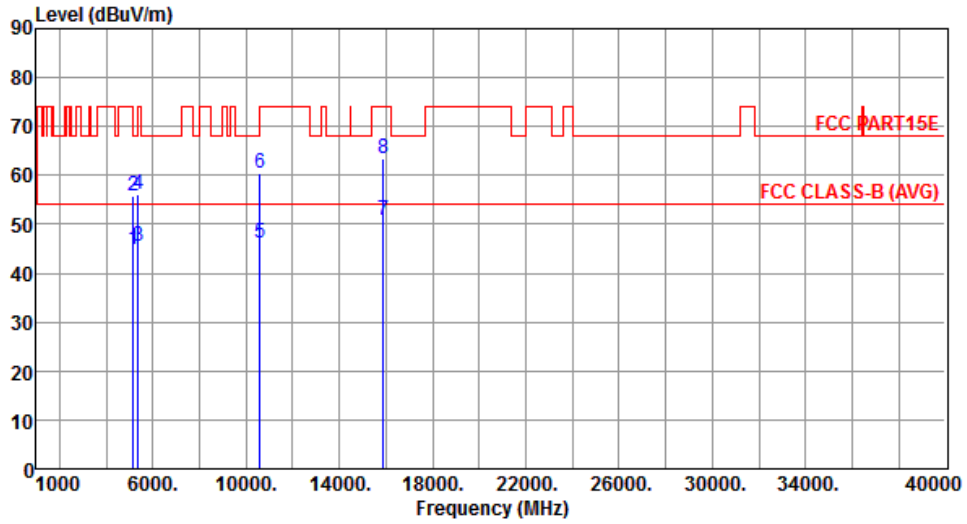

	Freq. MHz	Emission level dBuV/m	Limit dBuV/m	Margin dB	SA reading dBuV	Factor dB	Remark	ANT High cm	Turn Table deg
1	5150.00	44.78	54.00	-9.22	38.47	6.31	Average	308	230
2	5150.00	55.87	74.00	-18.13	49.56	6.31	Peak	308	230
3	5350.00	45.49	54.00	-8.51	38.87	6.62	Average	308	230
4	5350.00	56.01	74.00	-17.99	49.39	6.62	Peak	308	230
5	10600.00	46.07	54.00	-7.93	29.45	16.62	Average	219	290
6	10600.00	60.37	74.00	-13.63	43.75	16.62	Peak	219	290
7	15900.00	50.74	54.00	-3.26	33.92	16.82	Average	230	171
8	15900.00	63.51	74.00	-10.49	46.69	16.82	Peak	230	171

Note 1: Emission Level (dBuV/m) = SA Reading (dBuV/m) + Factor\* (dB)

\*Factor includes antenna factor , cable loss and amplifier gain

Note 2: Margin (dB) = Emission level (dBuV/m) – Limit (dBuV/m).

<b>Modulation</b>	11a	<b>Test Freq. (MHz)</b>	5300
<b>Polarization</b>	Vertical	<b>Test Configuration</b>	1

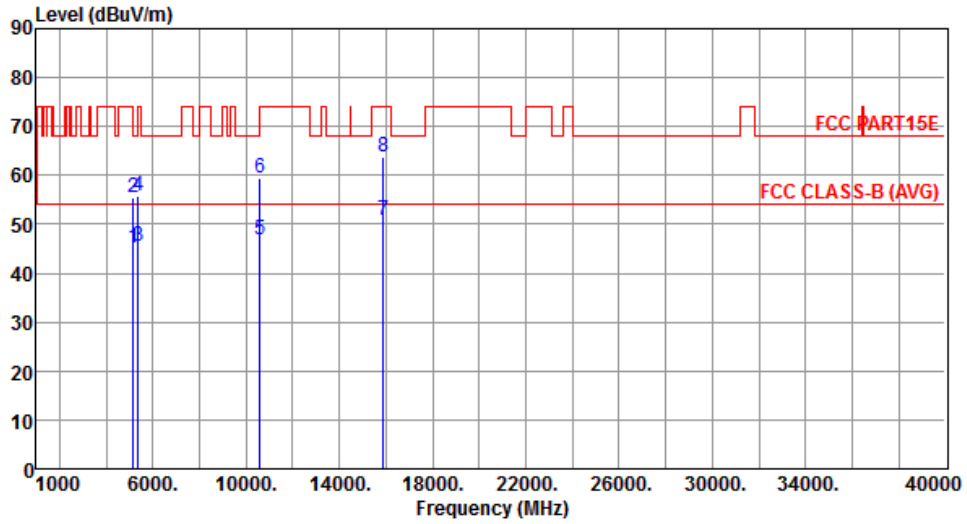

	Freq. MHz	Emission level dBuV/m	Limit dBuV/m	Margin dB	SA reading dBuV	Factor dB	Remark	ANT High cm	Turn Table deg
1	5150.00	45.21	54.00	-8.79	38.90	6.31	Average	134	21
2	5150.00	55.57	74.00	-18.43	49.26	6.31	Peak	134	21
3	5350.00	45.34	54.00	-8.66	38.72	6.62	Average	134	21
4	5350.00	55.78	74.00	-18.22	49.16	6.62	Peak	134	21
5	10600.00	46.88	54.00	-7.12	30.26	16.62	Average	270	60
6	10600.00	59.59	74.00	-14.41	42.97	16.62	Peak	270	60
7	15900.00	50.80	54.00	-3.20	33.98	16.82	Average	350	271
8	15900.00	63.79	74.00	-10.21	46.97	16.82	Peak	350	271

Note 1: Emission Level (dBuV/m) = SA Reading (dBuV/m) + Factor\* (dB)

\*Factor includes antenna factor , cable loss and amplifier gain

Note 2: Margin (dB) = Emission level (dBuV/m) – Limit (dBuV/m).

<b>Modulation</b>	11a	<b>Test Freq. (MHz)</b>	5320
<b>Polarization</b>	Horizontal	<b>Test Configuration</b>	1

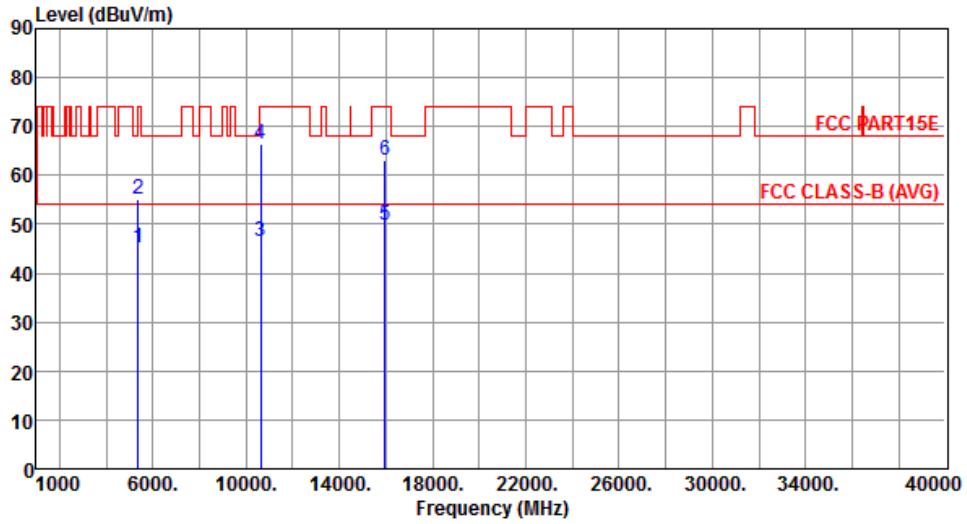

	Freq. MHz	Emission level dBuV/m	Limit dBuV/m	Margin dB	SA reading dBuV	Factor dB	Remark	ANT High cm	Turn Table deg
1	5350.00	45.28	54.00	-8.72	38.66	6.62	Average	309	234
2	5350.00	55.27	74.00	-18.73	48.65	6.62	Peak	309	234
3	10640.00	46.50	54.00	-7.50	29.87	16.63	Average	236	57
4	10640.00	66.39	74.00	-7.61	49.76	16.63	Peak	236	57
5	15960.00	49.97	54.00	-4.03	33.27	16.70	Average	272	122
6	15960.00	63.23	74.00	-10.77	46.53	16.70	Peak	272	122

Note 1: Emission Level (dBuV/m) = SA Reading (dBuV/m) + Factor\* (dB)

\*Factor includes antenna factor , cable loss and amplifier gain

Note 2: Margin (dB) = Emission level (dBuV/m) – Limit (dBuV/m).



<b>Modulation</b>	11a	<b>Test Freq. (MHz)</b>	5320
<b>Polarization</b>	Vertical	<b>Test Configuration</b>	1

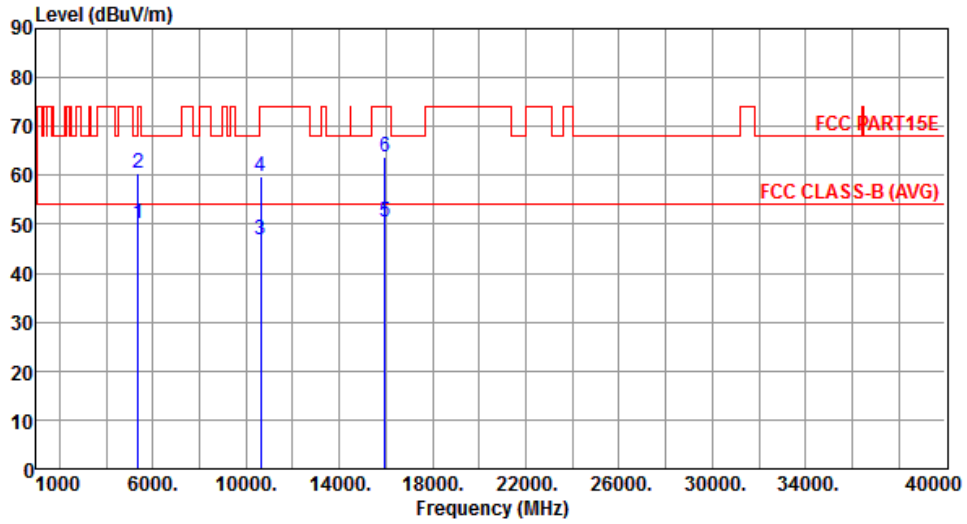

	Freq. MHz	Emission level dBuV/m	Limit dBuV/m	Margin dB	SA reading dBuV	Factor dB	Remark	ANT High cm	Turn Table deg
1	5350.00	50.06	54.00	-3.94	43.44	6.62	Average	161	20
2	5350.00	60.28	74.00	-13.72	53.66	6.62	Peak	161	20
3	10640.00	46.82	54.00	-7.18	30.19	16.63	Average	266	270
4	10640.00	59.92	74.00	-14.08	43.29	16.63	Peak	266	270
5	15960.00	50.61	54.00	-3.39	33.91	16.70	Average	209	271
6	15960.00	63.61	74.00	-10.39	46.91	16.70	Peak	209	271

Note 1: Emission Level (dBuV/m) = SA Reading (dBuV/m) + Factor\* (dB)

\*Factor includes antenna factor , cable loss and amplifier gain

Note 2: Margin (dB) = Emission level (dBuV/m) – Limit (dBuV/m).

<b>Modulation</b>	11a	<b>Test Freq. (MHz)</b>	5500
<b>Polarization</b>	Horizontal	<b>Test Configuration</b>	1

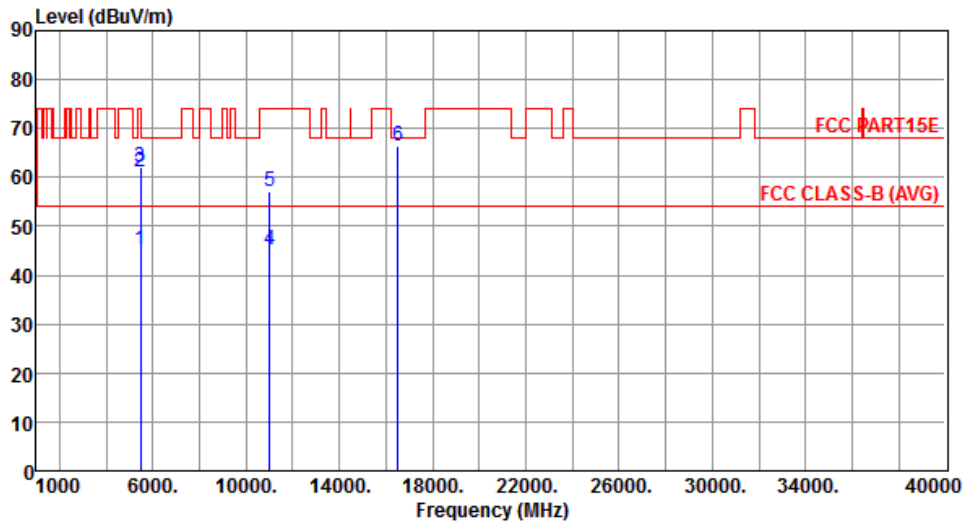

	Freq. MHz	Emission level dBuV/m	Limit dBuV/m	Margin dB	SA reading dBuV	Factor dB	Remark	ANT High cm	Turn Table deg
1	5460.00	45.01	54.00	-8.99	38.25	6.76	Average	305	232
2	5460.00	61.11	74.00	-12.89	54.35	6.76	Peak	305	232
3	5470.00	62.06	68.20	-6.14	55.29	6.77	Peak	305	232
4	11000.00	45.07	54.00	-8.93	28.35	16.72	Average	261	271
5	11000.00	57.09	74.00	-16.91	40.37	16.72	Peak	261	271
6	16500.00	66.41	68.20	-1.79	48.54	17.87	Peak	269	298

Note 1: Emission Level (dBuV/m) = SA Reading (dBuV/m) + Factor\* (dB)

\*Factor includes antenna factor , cable loss and amplifier gain

Note 2: Margin (dB) = Emission level (dBuV/m) – Limit (dBuV/m).

<b>Modulation</b>	11a	<b>Test Freq. (MHz)</b>	5500
<b>Polarization</b>	Vertical	<b>Test Configuration</b>	1

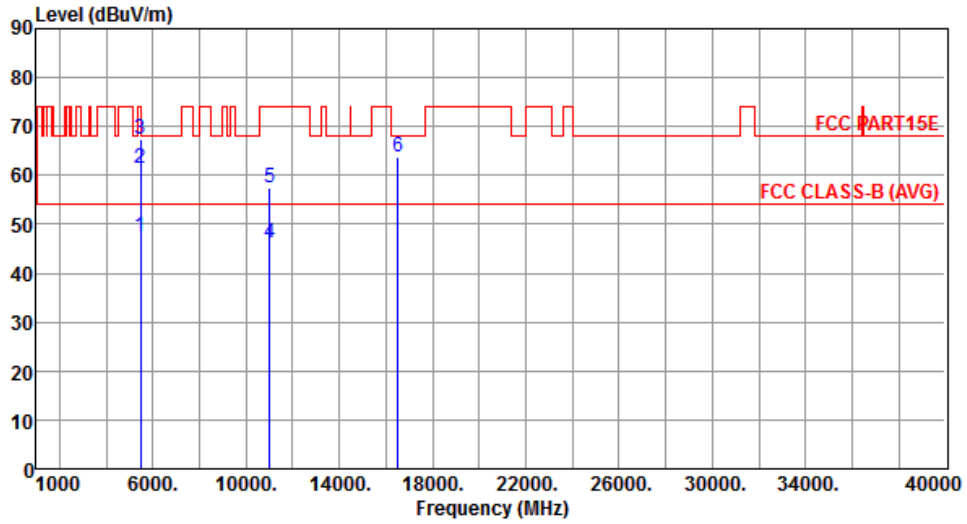

	Freq. MHz	Emission level dBuV/m	Limit dBuV/m	Margin dB	SA reading dBuV	Factor dB	Remark	ANT High cm	Turn Table deg
1	5460.00	47.48	54.00	-6.52	40.72	6.76	Average	157	330
2	5460.00	61.58	74.00	-12.42	54.82	6.76	Peak	157	330
3	5470.00	67.54	68.20	-0.66	60.77	6.77	Peak	157	330
4	11000.00	46.32	54.00	-7.68	29.60	16.72	Average	278	290
5	11000.00	57.29	74.00	-16.71	40.57	16.72	Peak	278	290
6	16500.00	63.69	68.20	-4.51	45.82	17.87	Peak	239	353

Note 1: Emission Level (dBuV/m) = SA Reading (dBuV/m) + Factor\* (dB)

\*Factor includes antenna factor , cable loss and amplifier gain

Note 2: Margin (dB) = Emission level (dBuV/m) – Limit (dBuV/m).

<b>Modulation</b>	11a	<b>Test Freq. (MHz)</b>	5580
<b>Polarization</b>	Horizontal	<b>Test Configuration</b>	1

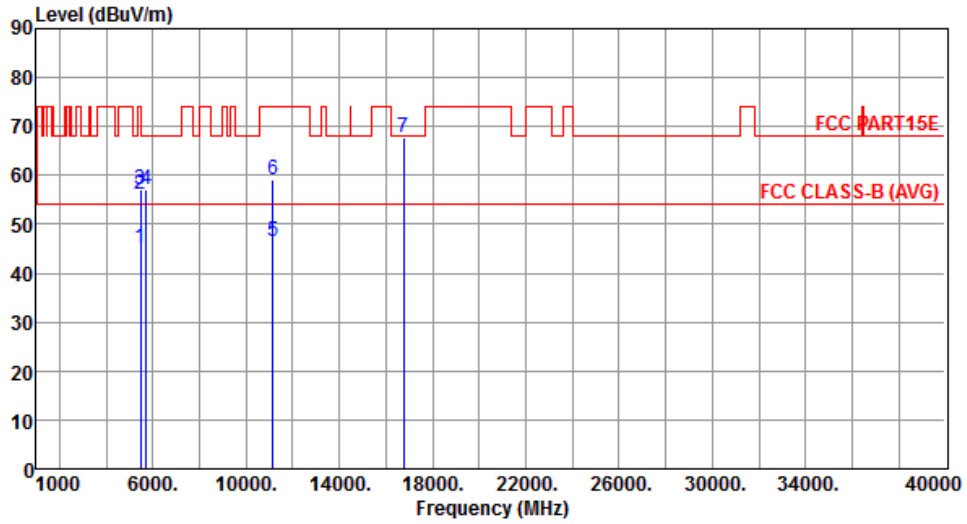

	Freq. MHz	Emission level dBuV/m	Limit dBuV/m	Margin dB	SA reading dBuV	Factor dB	Remark	ANT High cm	Turn Table deg
1	5460.00	45.01	54.00	-8.99	38.25	6.76	Average	304	235
2	5460.00	56.02	74.00	-17.98	49.26	6.76	Peak	304	235
3	5470.00	57.03	68.20	-11.17	50.26	6.77	Peak	304	235
4	5725.00	57.02	68.20	-11.18	49.78	7.24	Peak	304	235
5	11160.00	46.65	54.00	-7.35	29.86	16.79	Average	271	300
6	11160.00	59.15	74.00	-14.85	42.36	16.79	Peak	271	300
7	16740.00	67.70	68.20	-0.50	49.30	18.40	Peak	209	297

Note 1: Emission Level (dBuV/m) = SA Reading (dBuV/m) + Factor\* (dB)

\*Factor includes antenna factor , cable loss and amplifier gain

Note 2: Margin (dB) = Emission level (dBuV/m) – Limit (dBuV/m).

<b>Modulation</b>	11a	<b>Test Freq. (MHz)</b>	5580
<b>Polarization</b>	Vertical	<b>Test Configuration</b>	1

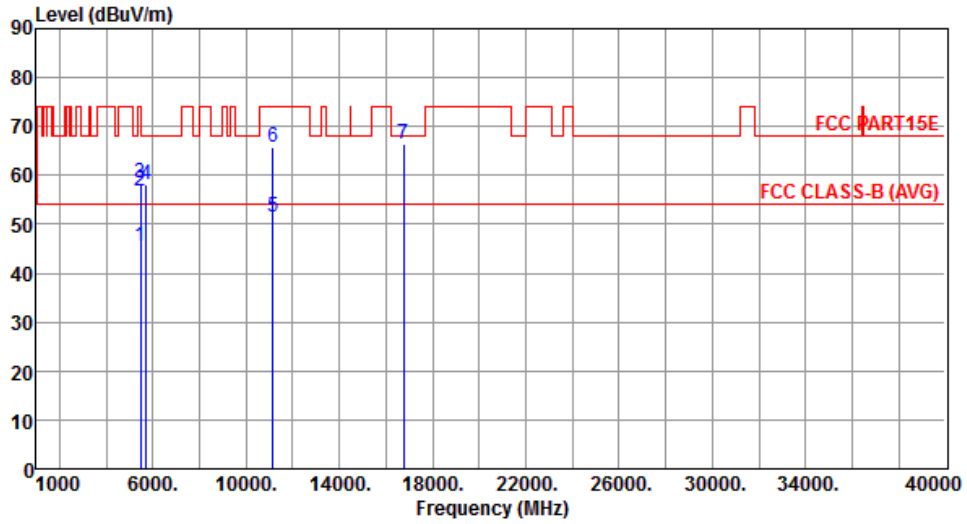

	Freq. MHz	Emission level dBuV/m	Limit dBuV/m	Margin dB	SA reading dBuV	Factor dB	Remark	ANT High cm	Turn Table deg
1	5460.00	45.35	54.00	-8.65	38.59	6.76	Average	157	354
2	5460.00	56.62	74.00	-17.38	49.86	6.76	Peak	157	354
3	5470.00	58.40	68.20	-9.80	51.63	6.77	Peak	157	354
4	5725.00	57.98	68.20	-10.22	50.74	7.24	Peak	157	354
5	11160.00	51.38	54.00	-2.62	34.59	16.79	Average	250	2
6	11160.00	65.66	74.00	-8.34	48.87	16.79	Peak	250	2
7	16740.00	66.27	68.20	-1.93	47.87	18.40	Peak	166	7

Note 1: Emission Level (dBuV/m) = SA Reading (dBuV/m) + Factor\* (dB)

\*Factor includes antenna factor , cable loss and amplifier gain

Note 2: Margin (dB) = Emission level (dBuV/m) – Limit (dBuV/m).

<b>Modulation</b>	11a	<b>Test Freq. (MHz)</b>	5700
<b>Polarization</b>	Horizontal	<b>Test Configuration</b>	1

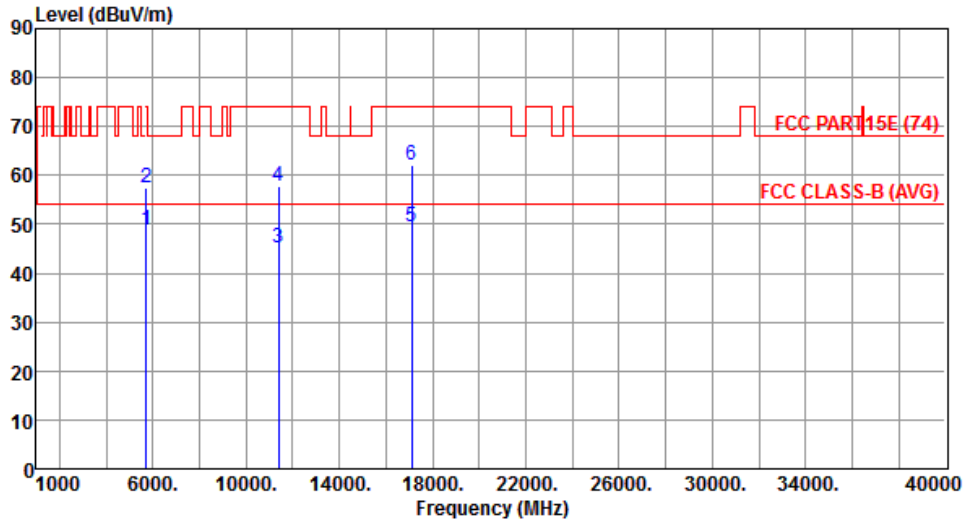

	Freq. MHz	Emission level dBuV/m	Limit dBuV/m	Margin dB	SA reading dBuV	Factor dB	Remark	ANT High cm	Turn Table deg
1	5725.00	48.83	54.00	-5.17	41.59	7.24	Average	303	235
2	5725.00	57.53	74.00	-16.47	50.29	7.24	Peak	303	235
3	11400.00	45.18	54.00	-8.82	28.30	16.88	Average	326	216
4	11400.00	57.86	74.00	-16.14	40.98	16.88	Peak	326	216
5	17100.00	49.41	54.00	-4.59	30.29	19.12	Average	300	175
6	17100.00	62.21	74.00	-11.79	43.09	19.12	Peak	300	175

Note 1: Emission Level (dBuV/m) = SA Reading (dBuV/m) + Factor\* (dB)

\*Factor includes antenna factor , cable loss and amplifier gain

Note 2: Margin (dB) = Emission level (dBuV/m) – Limit (dBuV/m).

<b>Modulation</b>	11a	<b>Test Freq. (MHz)</b>	5700
<b>Polarization</b>	Vertical	<b>Test Configuration</b>	1

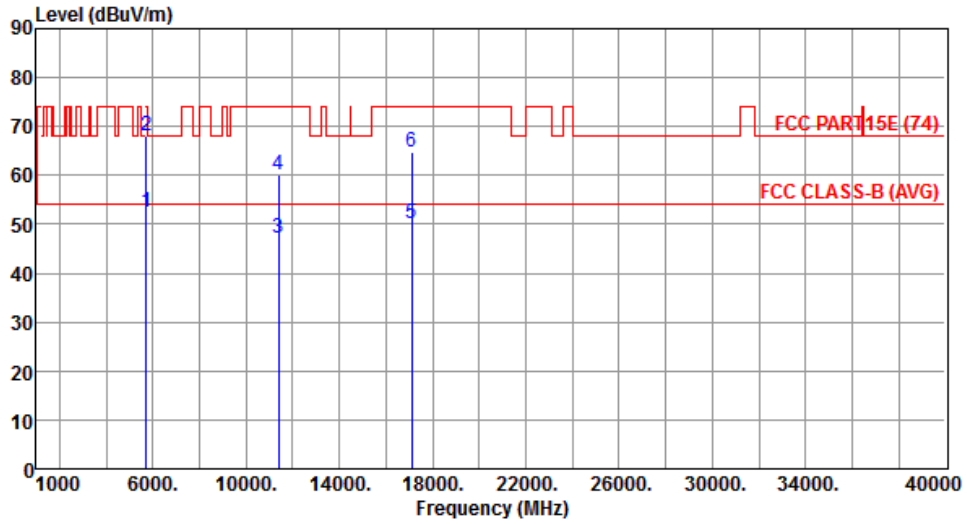

	Freq. MHz	Emission level dBuV/m	Limit dBuV/m	Margin dB	SA reading dBuV	Factor dB	Remark	ANT High cm	Turn Table deg
1	5725.00	52.51	54.00	-1.49	45.27	7.24	Average	130	16
2	5725.00	67.99	74.00	-6.01	60.75	7.24	Peak	130	16
3	11400.00	47.17	54.00	-6.83	30.29	16.88	Average	190	267
4	11400.00	60.14	74.00	-13.86	43.26	16.88	Peak	190	267
5	17100.00	49.99	54.00	-4.01	30.87	19.12	Average	326	305
6	17100.00	64.72	74.00	-9.28	45.60	19.12	Peak	326	305

Note 1: Emission Level (dBuV/m) = SA Reading (dBuV/m) + Factor\* (dB)

\*Factor includes antenna factor , cable loss and amplifier gain

Note 2: Margin (dB) = Emission level (dBuV/m) – Limit (dBuV/m).

<b>Modulation</b>	11a	<b>Test Freq. (MHz)</b>	5745
<b>Polarization</b>	Horizontal	<b>Test Configuration</b>	1

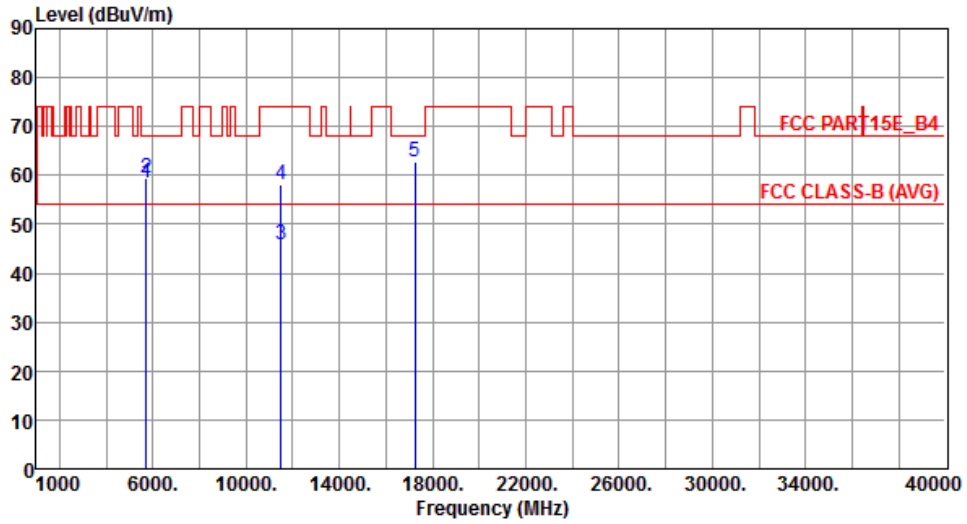

	Freq. MHz	Emission level dBuV/m	Limit dBuV/m	Margin dB	SA reading dBuV	Factor dB	Remark	ANT High cm	Turn Table deg
1	5715.00	58.32	68.20	-9.88	51.12	7.20	Peak	300	225
2	5725.00	59.43	78.20	-18.77	52.19	7.24	Peak	300	225
3	11490.00	45.77	54.00	-8.23	28.86	16.91	Average	303	189
4	11490.00	58.18	74.00	-15.82	41.27	16.91	Peak	303	189
5	17235.00	62.85	68.20	-5.35	43.53	19.32	Peak	322	211

Note 1: Emission Level (dBuV/m) = SA Reading (dBuV/m) + Factor\* (dB)

\*Factor includes antenna factor , cable loss and amplifier gain

Note 2: Margin (dB) = Emission level (dBuV/m) – Limit (dBuV/m).



<b>Modulation</b>	11a	<b>Test Freq. (MHz)</b>	5745
<b>Polarization</b>	Vertical	<b>Test Configuration</b>	1

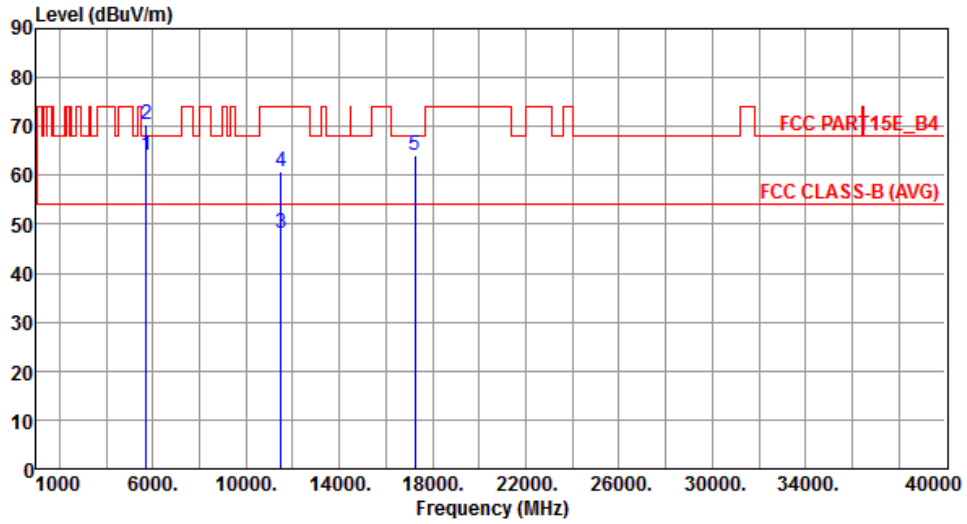

	Freq. MHz	Emission level dBuV/m	Limit dBuV/m	Margin dB	SA reading dBuV	Factor dB	Remark	ANT High cm	Turn Table deg
1	5715.00	64.00	68.20	-4.20	56.80	7.20	Peak	163	17
2	5725.00	70.26	78.20	-7.94	63.02	7.24	Peak	163	17
3	11490.00	48.17	54.00	-5.83	31.26	16.91	Average	199	265
4	11490.00	60.75	74.00	-13.25	43.84	16.91	Peak	199	265
5	17235.00	63.94	68.20	-4.26	44.62	19.32	Peak	303	311

Note 1: Emission Level (dBuV/m) = SA Reading (dBuV/m) + Factor\* (dB)

\*Factor includes antenna factor , cable loss and amplifier gain

Note 2: Margin (dB) = Emission level (dBuV/m) – Limit (dBuV/m).

<b>Modulation</b>	11a	<b>Test Freq. (MHz)</b>	5785
<b>Polarization</b>	Horizontal	<b>Test Configuration</b>	1

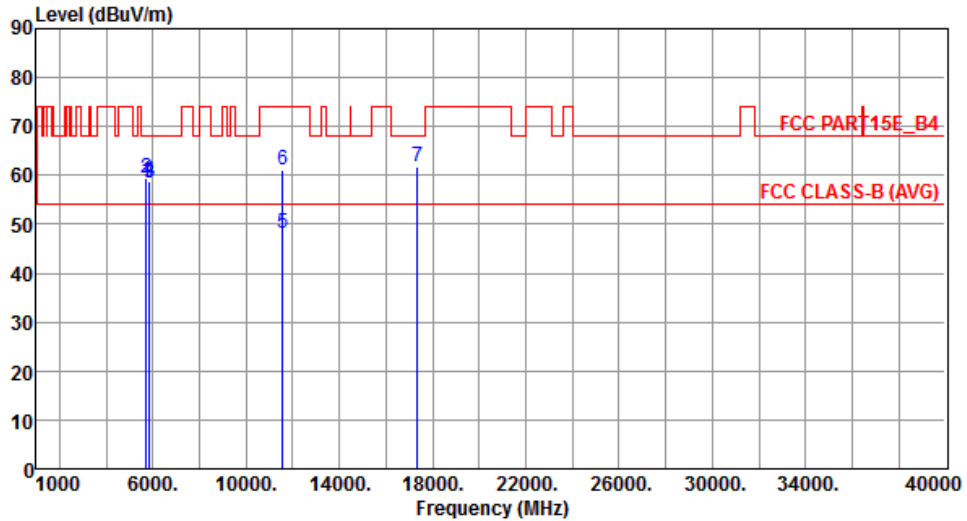

	Freq. MHz	Emission level dBuV/m	Limit dBuV/m	Margin dB	SA reading dBuV	Factor dB	Remark	ANT High cm	Turn Table deg
1	5715.00	58.83	68.20	-9.37	51.63	7.20	Peak	300	226
2	5725.00	59.59	78.20	-18.61	52.35	7.24	Peak	300	226
3	5850.00	58.56	78.20	-19.64	51.06	7.50	Peak	300	226
4	5860.00	58.86	68.20	-9.34	51.35	7.51	Peak	300	226
5	11570.00	48.31	54.00	-5.69	31.51	16.80	Average	286	188
6	11570.00	60.96	74.00	-13.04	44.16	16.80	Peak	286	188
7	17355.00	61.65	68.20	-6.55	42.16	19.49	Peak	311	215

Note 1: Emission Level (dBuV/m) = SA Reading (dBuV/m) + Factor\* (dB)

\*Factor includes antenna factor , cable loss and amplifier gain

Note 2: Margin (dB) = Emission level (dBuV/m) – Limit (dBuV/m).

<b>Modulation</b>	11a	<b>Test Freq. (MHz)</b>	5785
<b>Polarization</b>	Vertical	<b>Test Configuration</b>	1

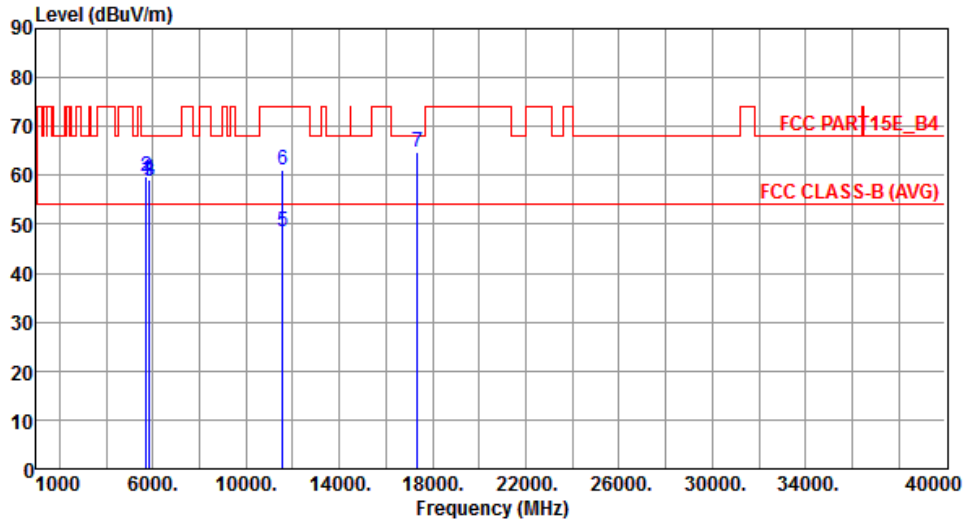

	Freq. MHz	Emission level dBuV/m	Limit dBuV/m	Margin dB	SA reading dBuV	Factor dB	Remark	ANT High cm	Turn Table deg
1	5715.00	59.25	68.20	-8.95	52.05	7.20	Peak	159	14
2	5725.00	59.89	78.20	-18.31	52.65	7.24	Peak	159	14
3	5850.00	58.72	78.20	-19.48	51.22	7.50	Peak	159	14
4	5860.00	59.16	68.20	-9.04	51.65	7.51	Peak	159	14
5	11570.00	48.39	54.00	-5.61	31.59	16.80	Average	199	253
6	11570.00	61.15	74.00	-12.85	44.35	16.80	Peak	199	253
7	17355.00	64.85	68.20	-3.35	45.36	19.49	Peak	299	303

Note 1: Emission Level (dBuV/m) = SA Reading (dBuV/m) + Factor\* (dB)

\*Factor includes antenna factor , cable loss and amplifier gain

Note 2: Margin (dB) = Emission level (dBuV/m) – Limit (dBuV/m).

<b>Modulation</b>	11a	<b>Test Freq. (MHz)</b>	5825
<b>Polarization</b>	Horizontal	<b>Test Configuration</b>	1

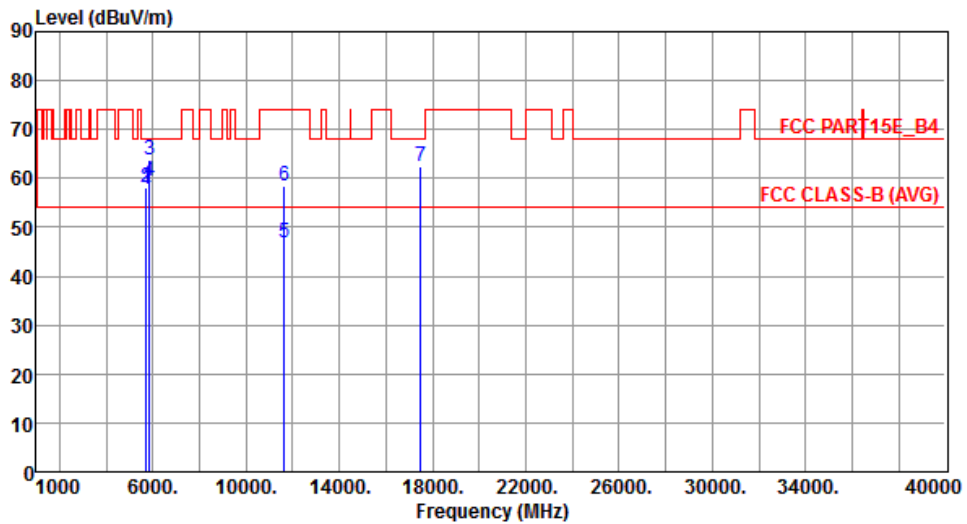

	Freq. MHz	Emission level dBuV/m	Limit dBuV/m	Margin dB	SA reading dBuV	Factor dB	Remark	ANT High cm	Turn Table deg
1	5715.00	57.86	68.20	-10.34	50.66	7.20	Peak	294	223
2	5725.00	58.12	78.20	-20.08	50.88	7.24	Peak	294	223
3	5850.00	63.61	78.20	-14.59	56.11	7.50	Peak	294	223
4	5860.00	59.53	68.20	-8.67	52.02	7.51	Peak	159	13
5	11650.00	46.83	54.00	-7.17	30.18	16.65	Average	300	192
6	11650.00	58.30	74.00	-15.70	41.65	16.65	Peak	300	192
7	17475.00	62.52	68.20	-5.68	42.86	19.66	Peak	311	216

Note 1: Emission Level (dBuV/m) = SA Reading (dBuV/m) + Factor\* (dB)

\*Factor includes antenna factor , cable loss and amplifier gain

Note 2: Margin (dB) = Emission level (dBuV/m) – Limit (dBuV/m).

<b>Modulation</b>	11a	<b>Test Freq. (MHz)</b>	5825
<b>Polarization</b>	Vertical	<b>Test Configuration</b>	1

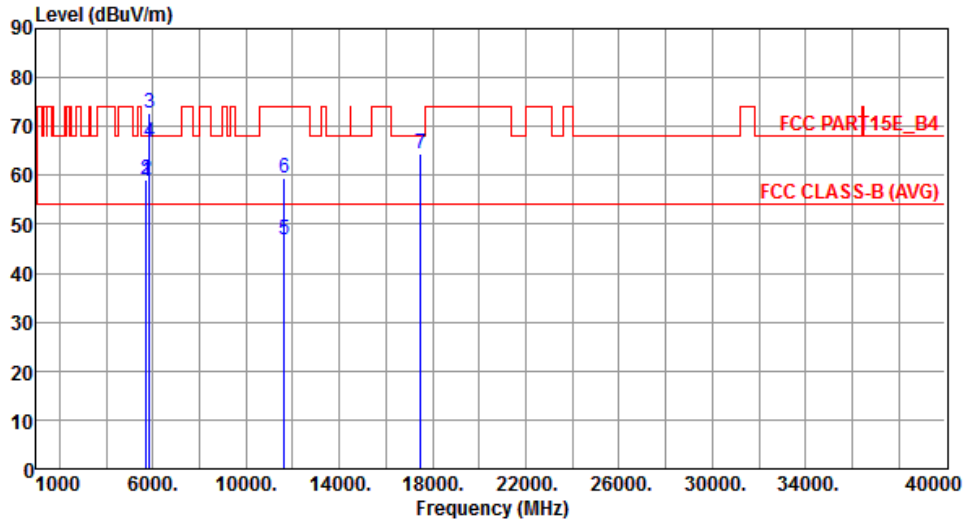

	Freq. MHz	Emission level dBuV/m	Limit dBuV/m	Margin dB	SA reading dBuV	Factor dB	Remark	ANT High cm	Turn Table deg
1	5715.00	58.94	68.20	-9.26	51.74	7.20	Peak	159	13
2	5725.00	59.12	78.20	-19.08	51.88	7.24	Peak	159	13
3	5850.00	72.68	78.20	-5.52	65.18	7.50	Peak	159	13
4	5860.00	66.62	68.20	-1.58	59.11	7.51	Peak	159	13
5	11650.00	46.91	54.00	-7.09	30.26	16.65	Average	199	238
6	11650.00	59.54	74.00	-14.46	42.89	16.65	Peak	199	238
7	17475.00	64.52	68.20	-3.68	44.86	19.66	Peak	296	303

Note 1: Emission Level (dBuV/m) = SA Reading (dBuV/m) + Factor\* (dB)

\*Factor includes antenna factor , cable loss and amplifier gain

Note 2: Margin (dB) = Emission level (dBuV/m) – Limit (dBuV/m).

### 3.5.6 Transmitter Radiated Unwanted Emissions (Above 1GHz) for HT20

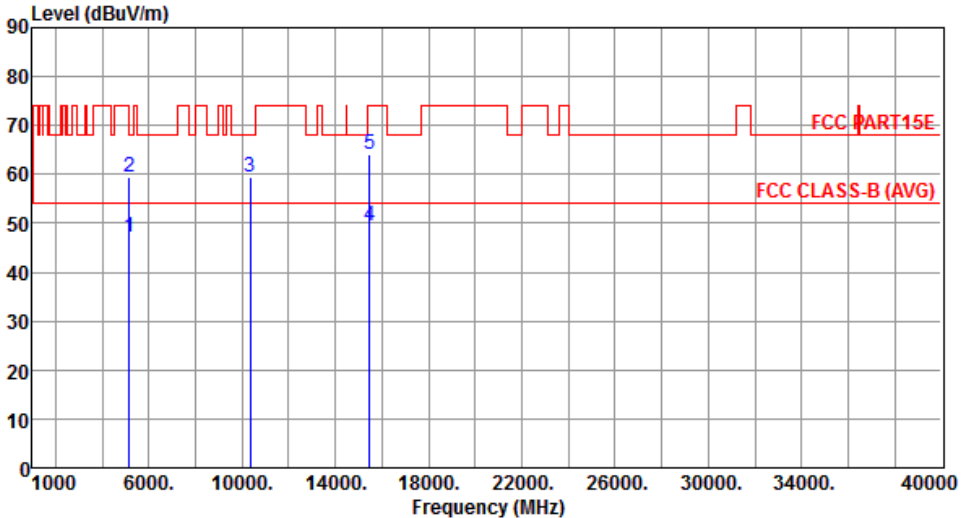
Modulation	HT20	Test Freq. (MHz)	5180																																																																					
Polarization	Horizontal	Test Configuration	1																																																																					
																																																																								
	<table border="1"> <thead> <tr> <th>Freq.</th> <th>Emission level</th> <th>Limit</th> <th>Margin</th> <th>SA reading</th> <th>Factor</th> <th>Remark</th> <th>ANT High</th> <th>Turn Table</th> </tr> <tr> <th>MHz</th> <th>dBuV/m</th> <th>dBuV/m</th> <th>dB</th> <th>dBuV</th> <th>dB</th> <th></th> <th>cm</th> <th>deg</th> </tr> </thead> <tbody> <tr> <td>1</td> <td>5150.00</td> <td>47.15</td> <td>54.00</td> <td>-6.85</td> <td>40.84</td> <td>6.31</td> <td>Average</td> <td>150</td> <td>344</td> </tr> <tr> <td>2</td> <td>5150.00</td> <td>59.50</td> <td>74.00</td> <td>-14.50</td> <td>53.19</td> <td>6.31</td> <td>Peak</td> <td>150</td> <td>344</td> </tr> <tr> <td>3</td> <td>10360.00</td> <td>59.60</td> <td>68.20</td> <td>-8.60</td> <td>43.26</td> <td>16.34</td> <td>Peak</td> <td>300</td> <td>157</td> </tr> <tr> <td>4</td> <td>15450.00</td> <td>49.38</td> <td>54.00</td> <td>-4.62</td> <td>31.60</td> <td>17.78</td> <td>Average</td> <td>307</td> <td>295</td> </tr> <tr> <td>5</td> <td>15450.00</td> <td>64.04</td> <td>74.00</td> <td>-9.96</td> <td>46.26</td> <td>17.78</td> <td>Peak</td> <td>307</td> <td>295</td> </tr> </tbody> </table>	Freq.	Emission level	Limit	Margin	SA reading	Factor	Remark	ANT High	Turn Table	MHz	dBuV/m	dBuV/m	dB	dBuV	dB		cm	deg	1	5150.00	47.15	54.00	-6.85	40.84	6.31	Average	150	344	2	5150.00	59.50	74.00	-14.50	53.19	6.31	Peak	150	344	3	10360.00	59.60	68.20	-8.60	43.26	16.34	Peak	300	157	4	15450.00	49.38	54.00	-4.62	31.60	17.78	Average	307	295	5	15450.00	64.04	74.00	-9.96	46.26	17.78	Peak	307	295			
Freq.	Emission level	Limit	Margin	SA reading	Factor	Remark	ANT High	Turn Table																																																																
MHz	dBuV/m	dBuV/m	dB	dBuV	dB		cm	deg																																																																
1	5150.00	47.15	54.00	-6.85	40.84	6.31	Average	150	344																																																															
2	5150.00	59.50	74.00	-14.50	53.19	6.31	Peak	150	344																																																															
3	10360.00	59.60	68.20	-8.60	43.26	16.34	Peak	300	157																																																															
4	15450.00	49.38	54.00	-4.62	31.60	17.78	Average	307	295																																																															
5	15450.00	64.04	74.00	-9.96	46.26	17.78	Peak	307	295																																																															
<p>Note 1: Emission Level (dBuV/m) = SA Reading (dBuV/m) + Factor* (dB)            *Factor includes antenna factor , cable loss and amplifier gain            Note 2: Margin (dB) = Emission level (dBuV/m) – Limit (dBuV/m).</p>																																																																								

<b>Modulation</b>	HT20	<b>Test Freq. (MHz)</b>	5180
<b>Polarization</b>	Vertical	<b>Test Configuration</b>	1

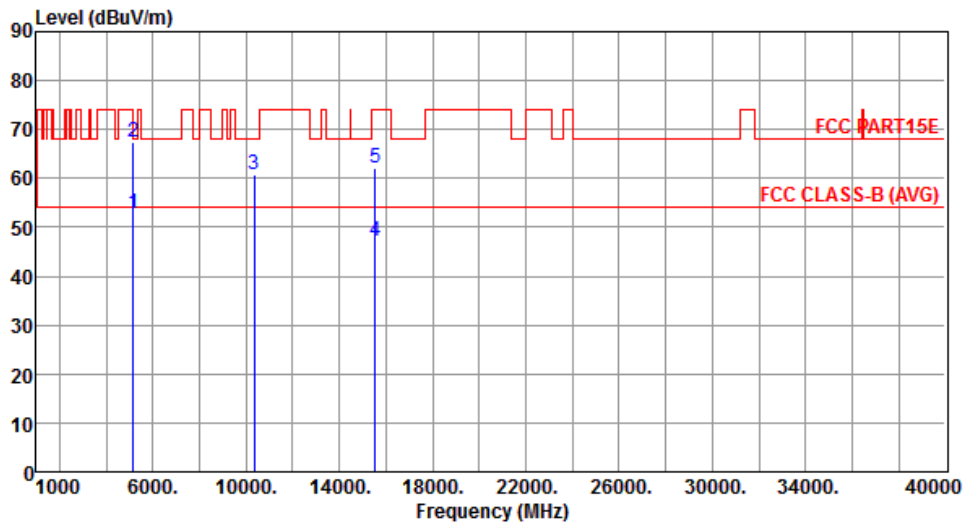

	Freq. MHz	Emission level dBuV/m	Limit dBuV/m	Margin dB	SA reading dBuV	Factor dB	Remark	ANT High cm	Turn Table deg
1	5150.00	52.94	54.00	-1.06	46.63	6.31	Average	155	20
2	5150.00	67.56	74.00	-6.44	61.25	6.31	Peak	155	20
3	10360.00	60.69	68.20	-7.51	44.35	16.34	Peak	287	239
4	15540.00	47.15	54.00	-6.85	29.65	17.50	Average	219	261
5	15540.00	62.21	74.00	-11.79	44.71	17.50	Peak	219	261

Note 1: Emission Level (dBuV/m) = SA Reading (dBuV/m) + Factor\* (dB)

\*Factor includes antenna factor , cable loss and amplifier gain

Note 2: Margin (dB) = Emission level (dBuV/m) – Limit (dBuV/m).

<b>Modulation</b>	HT20	<b>Test Freq. (MHz)</b>	5200
<b>Polarization</b>	Horizontal	<b>Test Configuration</b>	1

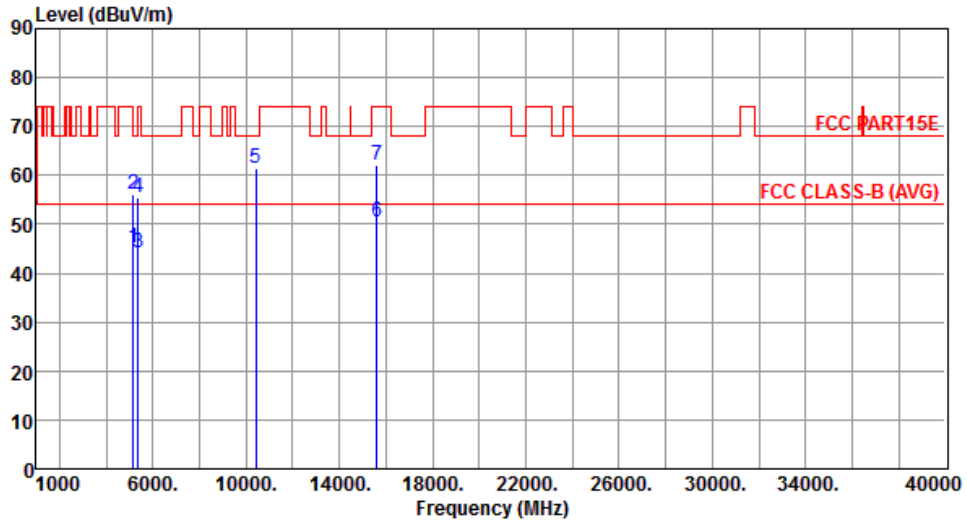

	Freq. MHz	Emission level dBuV/m	Limit dBuV/m	Margin dB	SA reading dBuV	Factor dB	Remark	ANT High cm	Turn Table deg
1	5150.00	45.10	54.00	-8.90	38.79	6.31	Average	153	344
2	5150.00	55.99	74.00	-18.01	49.68	6.31	Peak	153	344
3	5350.00	44.18	54.00	-9.82	37.56	6.62	Average	153	344
4	5350.00	55.51	74.00	-18.49	48.89	6.62	Peak	153	344
5	10400.00	61.34	68.20	-6.86	44.92	16.42	Peak	287	132
6	15600.00	50.47	54.00	-3.53	33.09	17.38	Average	220	31
7	15600.00	62.25	74.00	-11.75	44.87	17.38	Peak	220	31

Note 1: Emission Level (dBuV/m) = SA Reading (dBuV/m) + Factor\* (dB)

\*Factor includes antenna factor , cable loss and amplifier gain

Note 2: Margin (dB) = Emission level (dBuV/m) – Limit (dBuV/m).



<b>Modulation</b>	HT20	<b>Test Freq. (MHz)</b>	5200
<b>Polarization</b>	Vertical	<b>Test Configuration</b>	1

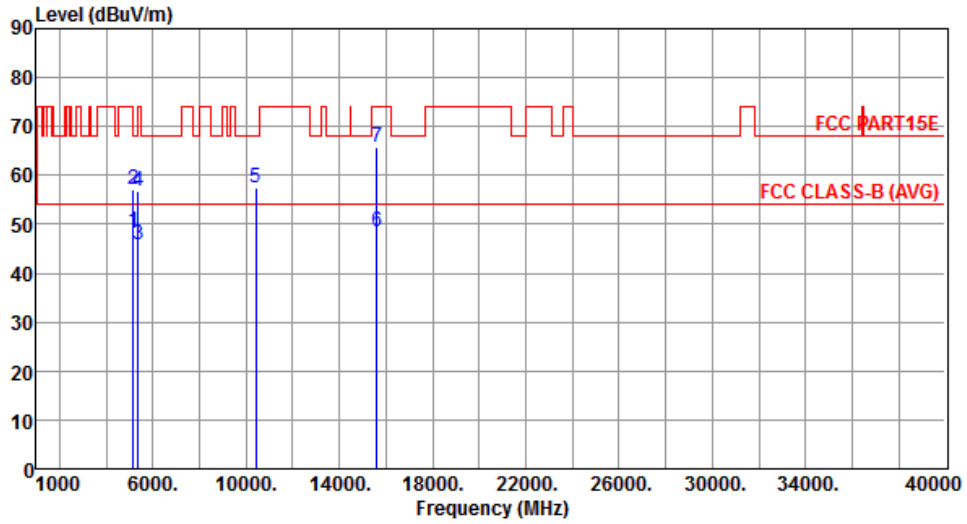

	Freq. MHz	Emission level dBuV/m	Limit dBuV/m	Margin dB	SA reading dBuV	Factor dB	Remark	ANT High cm	Turn Table deg
1	5150.00	48.45	54.00	-5.55	42.14	6.31	Average	142	141
2	5150.00	56.96	74.00	-17.04	50.65	6.31	Peak	142	141
3	5350.00	45.99	54.00	-8.01	39.37	6.62	Average	142	141
4	5350.00	56.89	74.00	-17.11	50.27	6.62	Peak	142	141
5	10400.00	57.39	68.20	-10.81	40.97	16.42	Peak	280	264
6	15600.00	48.36	54.00	-5.64	30.98	17.38	Average	271	227
7	15600.00	65.64	74.00	-8.36	48.26	17.38	Peak	271	227

Note 1: Emission Level (dBuV/m) = SA Reading (dBuV/m) + Factor\* (dB)

\*Factor includes antenna factor , cable loss and amplifier gain

Note 2: Margin (dB) = Emission level (dBuV/m) – Limit (dBuV/m).

<b>Modulation</b>	HT20	<b>Test Freq. (MHz)</b>	5240
<b>Polarization</b>	Horizontal	<b>Test Configuration</b>	1

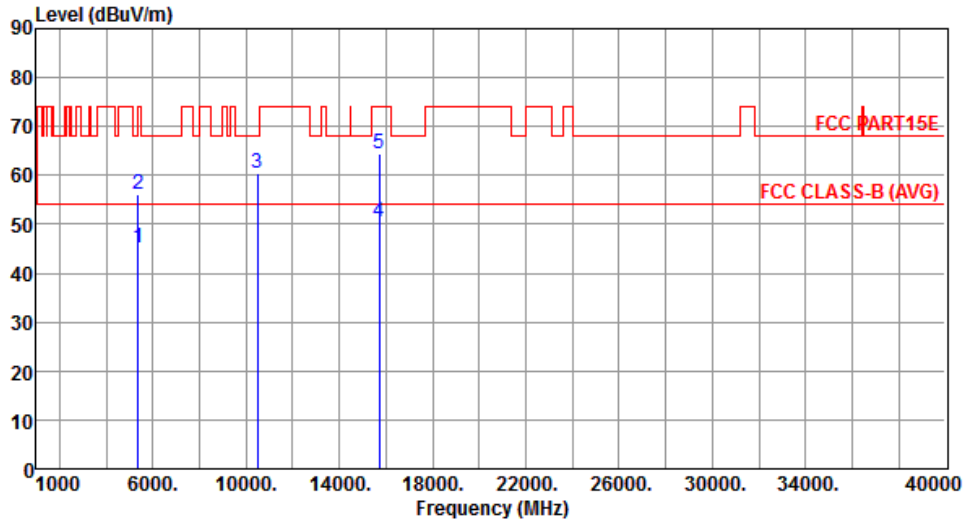

	Freq. MHz	Emission level dBuV/m	Limit dBuV/m	Margin dB	SA reading dBuV	Factor dB	Remark	ANT High cm	Turn Table deg
1	5350.00	45.00	54.00	-9.00	38.38	6.62	Average	322	236
2	5350.00	56.16	74.00	-17.84	49.54	6.62	Peak	322	236
3	10480.00	60.53	68.20	-7.67	43.97	16.56	Peak	248	359
4	15720.00	50.42	54.00	-3.58	33.27	17.15	Average	327	340
5	15720.00	64.42	74.00	-9.58	47.27	17.15	Peak	327	340

Note 1: Emission Level (dBuV/m) = SA Reading (dBuV/m) + Factor\* (dB)

\*Factor includes antenna factor , cable loss and amplifier gain

Note 2: Margin (dB) = Emission level (dBuV/m) – Limit (dBuV/m).

<b>Modulation</b>	HT20	<b>Test Freq. (MHz)</b>	5240
<b>Polarization</b>	Vertical	<b>Test Configuration</b>	1

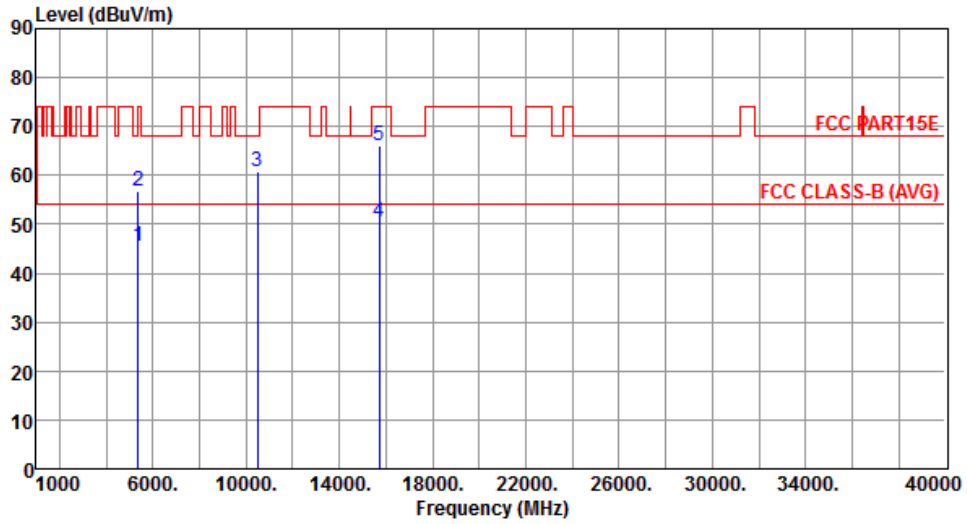

	Freq. MHz	Emission level dBuV/m	Limit dBuV/m	Margin dB	SA reading dBuV	Factor dB	Remark	ANT High cm	Turn Table deg
1	5350.00	45.46	54.00	-8.54	38.84	6.62	Average	132	141
2	5350.00	56.92	74.00	-17.08	50.30	6.62	Peak	132	141
3	10480.00	60.92	68.20	-7.28	44.36	16.56	Peak	291	270
4	15720.00	50.56	54.00	-3.44	33.41	17.15	Average	307	167
5	15720.00	66.19	74.00	-7.81	49.04	17.15	Peak	307	167

Note 1: Emission Level (dBuV/m) = SA Reading (dBuV/m) + Factor\* (dB)

\*Factor includes antenna factor , cable loss and amplifier gain

Note 2: Margin (dB) = Emission level (dBuV/m) – Limit (dBuV/m).

<b>Modulation</b>	HT20	<b>Test Freq. (MHz)</b>	5260
<b>Polarization</b>	Horizontal	<b>Test Configuration</b>	1

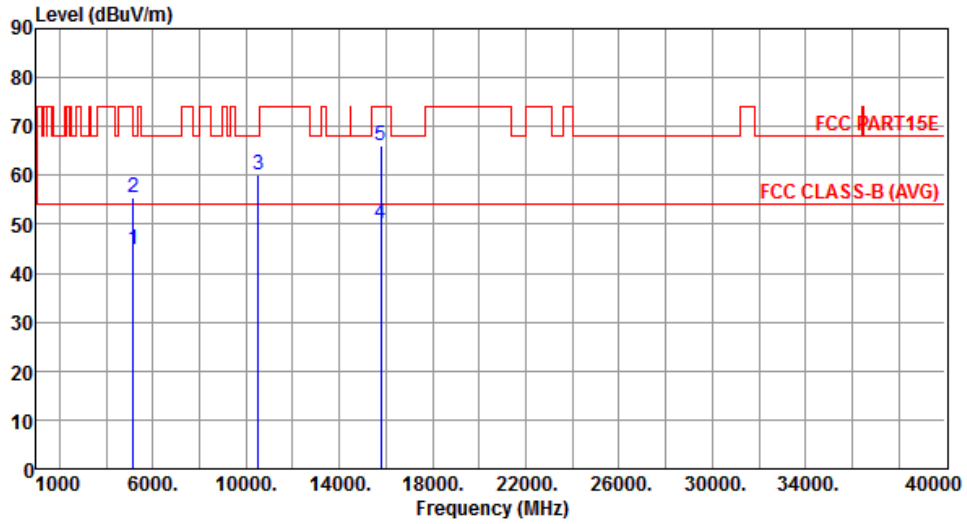

	Freq. MHz	Emission level dBuV/m	Limit dBuV/m	Margin dB	SA reading dBuV	Factor dB	Remark	ANT High cm	Turn Table deg
1	5150.00	44.89	54.00	-9.11	38.58	6.31	Average	302	221
2	5150.00	55.36	74.00	-18.64	49.05	6.31	Peak	302	221
3	10520.00	60.20	68.20	-8.00	43.60	16.60	Peak	282	261
4	15780.00	50.30	54.00	-3.70	33.25	17.05	Average	280	319
5	15780.00	66.07	74.00	-7.93	49.02	17.05	Peak	280	319

Note 1: Emission Level (dBuV/m) = SA Reading (dBuV/m) + Factor\* (dB)

\*Factor includes antenna factor , cable loss and amplifier gain

Note 2: Margin (dB) = Emission level (dBuV/m) – Limit (dBuV/m).

<b>Modulation</b>	HT20	<b>Test Freq. (MHz)</b>	5260
<b>Polarization</b>	Vertical	<b>Test Configuration</b>	1

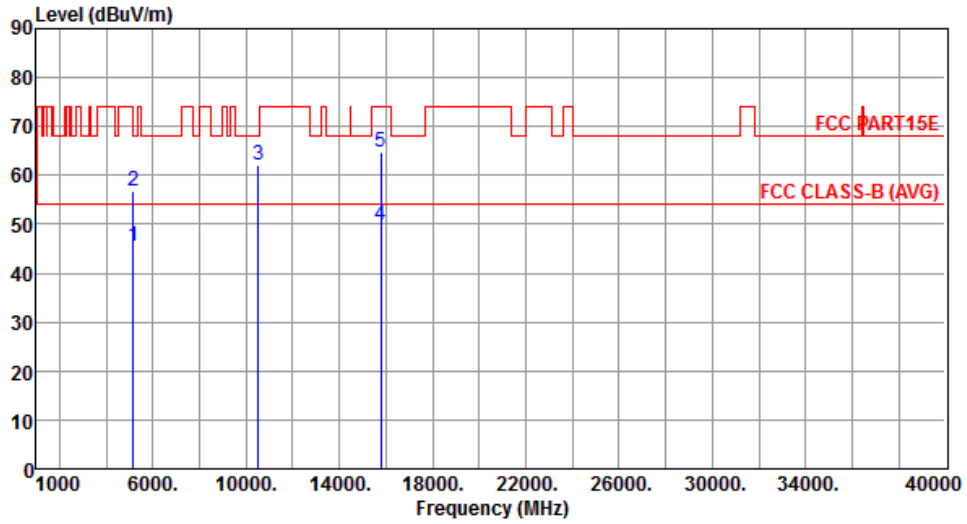

	Freq. MHz	Emission level dBuV/m	Limit dBuV/m	Margin dB	SA reading dBuV	Factor dB	Remark	ANT High cm	Turn Table deg
1	5150.00	45.46	54.00	-8.54	39.15	6.31	Average	140	36
2	5150.00	56.66	74.00	-17.34	50.35	6.31	Peak	140	36
3	10520.00	62.20	68.20	-6.00	45.60	16.60	Peak	141	329
4	15780.00	49.97	54.00	-4.03	32.92	17.05	Average	295	261
5	15780.00	64.67	74.00	-9.33	47.62	17.05	Peak	295	261

Note 1: Emission Level (dBuV/m) = SA Reading (dBuV/m) + Factor\* (dB)

\*Factor includes antenna factor , cable loss and amplifier gain

Note 2: Margin (dB) = Emission level (dBuV/m) – Limit (dBuV/m).

<b>Modulation</b>	HT20	<b>Test Freq. (MHz)</b>	5300
<b>Polarization</b>	Horizontal	<b>Test Configuration</b>	1

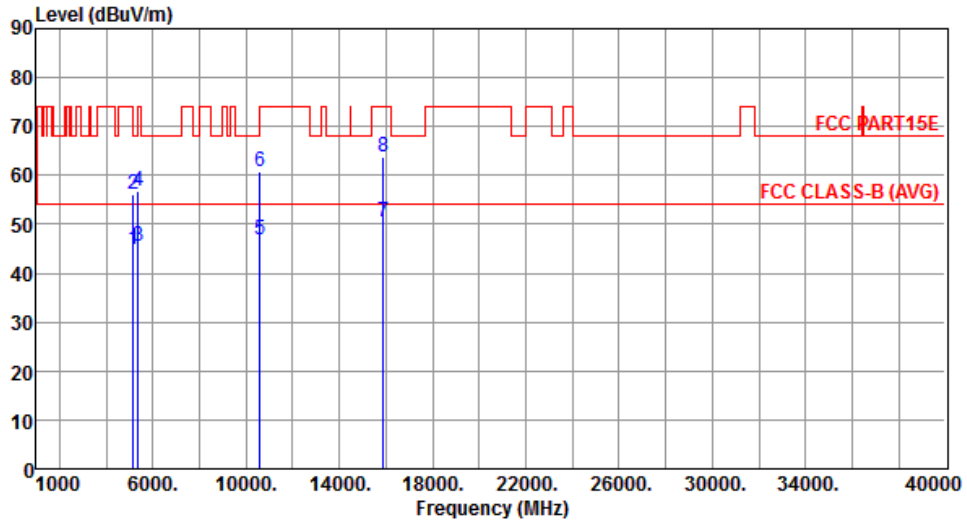

	Freq. MHz	Emission level dBuV/m	Limit dBuV/m	Margin dB	SA reading dBuV	Factor dB	Remark	ANT High cm	Turn Table deg
1	5150.00	44.77	54.00	-9.23	38.46	6.31	Average	308	230
2	5150.00	55.97	74.00	-18.03	49.66	6.31	Peak	308	230
3	5350.00	45.56	54.00	-8.44	38.94	6.62	Average	308	230
4	5350.00	56.85	74.00	-17.15	50.23	6.62	Peak	308	230
5	10600.00	46.82	54.00	-7.18	30.20	16.62	Average	260	113
6	10600.00	60.88	74.00	-13.12	44.26	16.62	Peak	260	113
7	15900.00	50.64	54.00	-3.36	33.82	16.82	Average	261	129
8	15900.00	63.63	74.00	-10.37	46.81	16.82	Peak	261	129

Note 1: Emission Level (dBuV/m) = SA Reading (dBuV/m) + Factor\* (dB)

\*Factor includes antenna factor , cable loss and amplifier gain

Note 2: Margin (dB) = Emission level (dBuV/m) – Limit (dBuV/m).

<b>Modulation</b>	HT20	<b>Test Freq. (MHz)</b>	5300
<b>Polarization</b>	Vertical	<b>Test Configuration</b>	1

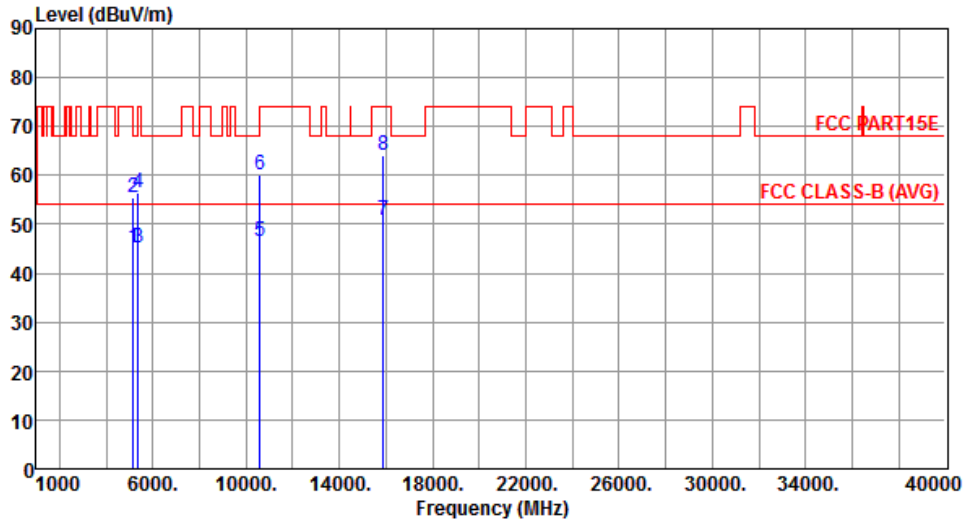

	Freq. MHz	Emission level dBuV/m	Limit dBuV/m	Margin dB	SA reading dBuV	Factor dB	Remark	ANT High cm	Turn Table deg
1	5150.00	45.04	54.00	-8.96	38.73	6.31	Average	134	21
2	5150.00	55.61	74.00	-18.39	49.30	6.31	Peak	134	21
3	5350.00	45.16	54.00	-8.84	38.54	6.62	Average	134	21
4	5350.00	56.40	74.00	-17.60	49.78	6.62	Peak	134	21
5	10600.00	46.49	54.00	-7.51	29.87	16.62	Average	325	67
6	10600.00	60.22	74.00	-13.78	43.60	16.62	Peak	325	67
7	15900.00	50.92	54.00	-3.08	34.10	16.82	Average	351	269
8	15900.00	64.12	74.00	-9.88	47.30	16.82	Peak	351	269

Note 1: Emission Level (dBuV/m) = SA Reading (dBuV/m) + Factor\* (dB)

\*Factor includes antenna factor , cable loss and amplifier gain

Note 2: Margin (dB) = Emission level (dBuV/m) – Limit (dBuV/m).

<b>Modulation</b>	HT20	<b>Test Freq. (MHz)</b>	5320
<b>Polarization</b>	Horizontal	<b>Test Configuration</b>	1

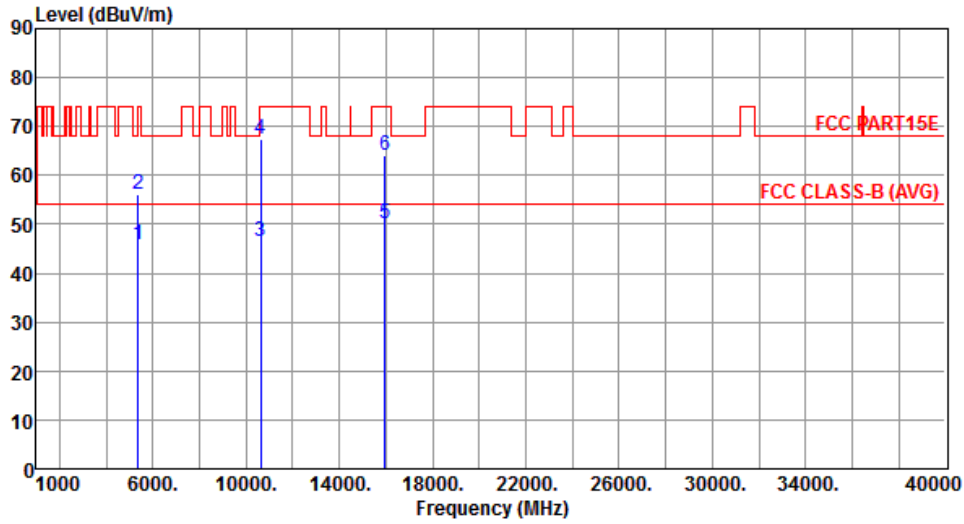

	Freq. MHz	Emission level dBuV/m	Limit dBuV/m	Margin dB	SA reading dBuV	Factor dB	Remark	ANT High cm	Turn Table deg
1	5350.00	45.92	54.00	-8.08	39.30	6.62	Average	310	235
2	5350.00	56.22	74.00	-17.78	49.60	6.62	Peak	310	235
3	10640.00	46.50	54.00	-7.50	29.87	16.63	Average	328	149
4	10640.00	67.26	74.00	-6.74	50.63	16.63	Peak	328	149
5	15960.00	50.28	54.00	-3.72	33.58	16.70	Average	281	122
6	15960.00	64.01	74.00	-9.99	47.31	16.70	Peak	281	122

Note 1: Emission Level (dBuV/m) = SA Reading (dBuV/m) + Factor\* (dB)

\*Factor includes antenna factor , cable loss and amplifier gain

Note 2: Margin (dB) = Emission level (dBuV/m) – Limit (dBuV/m).



<b>Modulation</b>	HT20	<b>Test Freq. (MHz)</b>	5320
<b>Polarization</b>	Vertical	<b>Test Configuration</b>	1

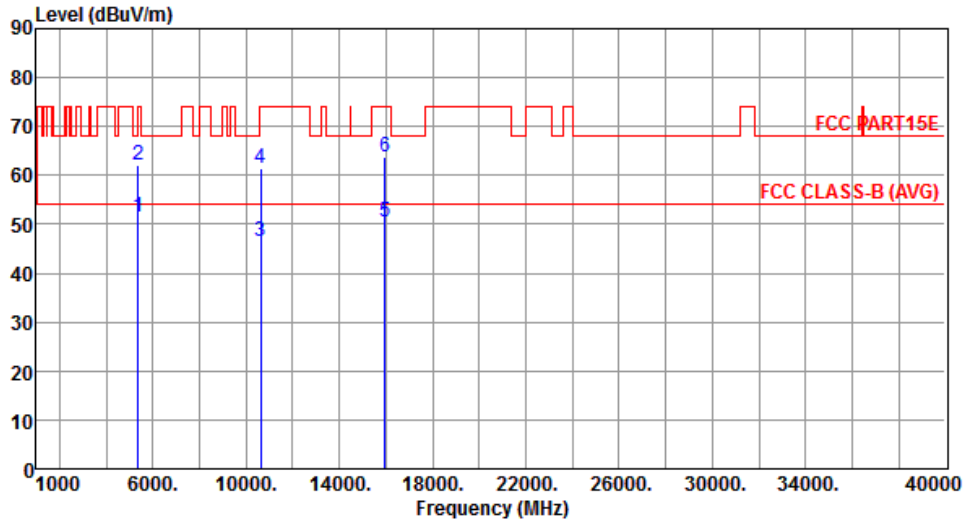

	Freq. MHz	Emission level dBuV/m	Limit dBuV/m	Margin dB	SA reading dBuV	Factor dB	Remark	ANT High cm	Turn Table deg
1	5350.00	51.37	54.00	-2.63	44.75	6.62	Average	161	20
2	5350.00	62.22	74.00	-11.78	55.60	6.62	Peak	161	20
3	10640.00	46.41	54.00	-7.59	29.78	16.63	Average	284	237
4	10640.00	61.54	74.00	-12.46	44.91	16.63	Peak	284	237
5	15960.00	50.49	54.00	-3.51	33.79	16.70	Average	210	280
6	15960.00	63.81	74.00	-10.19	47.11	16.70	Peak	210	280

Note 1: Emission Level (dBuV/m) = SA Reading (dBuV/m) + Factor\* (dB)

\*Factor includes antenna factor , cable loss and amplifier gain

Note 2: Margin (dB) = Emission level (dBuV/m) – Limit (dBuV/m).

<b>Modulation</b>	HT20	<b>Test Freq. (MHz)</b>	5500
<b>Polarization</b>	Horizontal	<b>Test Configuration</b>	1

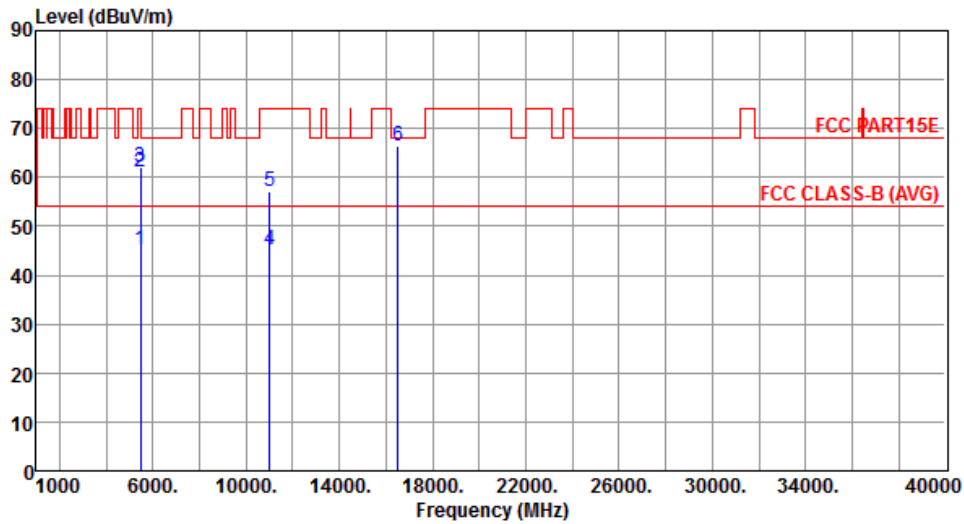

	Freq. MHz	Emission level dBuV/m	Limit dBuV/m	Margin dB	SA reading dBuV	Factor dB	Remark	ANT High cm	Turn Table deg
1	5460.00	45.01	54.00	-8.99	38.25	6.76	Average	305	232
2	5460.00	61.11	74.00	-12.89	54.35	6.76	Peak	305	232
3	5470.00	62.06	68.20	-6.14	55.29	6.77	Peak	305	232
4	11000.00	45.07	54.00	-8.93	28.35	16.72	Average	261	271
5	11000.00	57.09	74.00	-16.91	40.37	16.72	Peak	261	271
6	16500.00	66.41	68.20	-1.79	48.54	17.87	Peak	269	298

Note 1: Emission Level (dBuV/m) = SA Reading (dBuV/m) + Factor\* (dB)

\*Factor includes antenna factor , cable loss and amplifier gain

Note 2: Margin (dB) = Emission level (dBuV/m) – Limit (dBuV/m).

<b>Modulation</b>	HT20	<b>Test Freq. (MHz)</b>	5500
<b>Polarization</b>	Vertical	<b>Test Configuration</b>	1

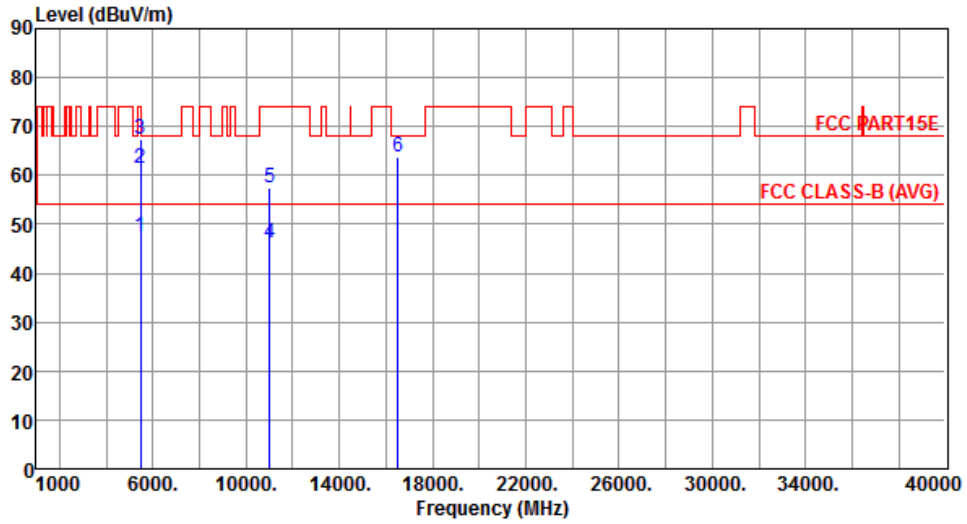

	Freq. MHz	Emission level dBuV/m	Limit dBuV/m	Margin dB	SA reading dBuV	Factor dB	Remark	ANT High cm	Turn Table deg
1	5460.00	47.48	54.00	-6.52	40.72	6.76	Average	157	330
2	5460.00	61.58	74.00	-12.42	54.82	6.76	Peak	157	330
3	5470.00	67.54	68.20	-0.66	60.77	6.77	Peak	157	330
4	11000.00	46.32	54.00	-7.68	29.60	16.72	Average	278	290
5	11000.00	57.29	74.00	-16.71	40.57	16.72	Peak	278	290
6	16500.00	63.69	68.20	-4.51	45.82	17.87	Peak	239	353

Note 1: Emission Level (dBuV/m) = SA Reading (dBuV/m) + Factor\* (dB)

\*Factor includes antenna factor , cable loss and amplifier gain

Note 2: Margin (dB) = Emission level (dBuV/m) – Limit (dBuV/m).

<b>Modulation</b>	HT20	<b>Test Freq. (MHz)</b>	5580
<b>Polarization</b>	Horizontal	<b>Test Configuration</b>	1

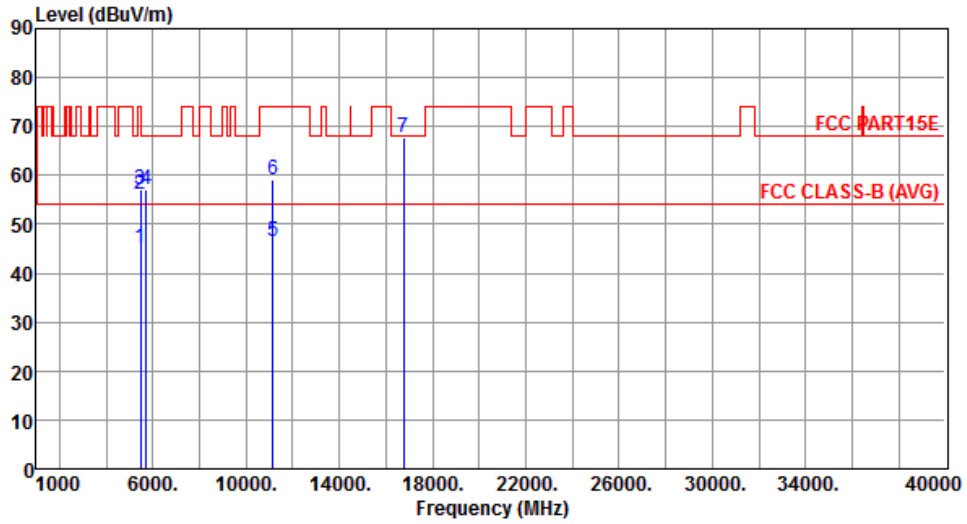

	Freq. MHz	Emission level dBuV/m	Limit dBuV/m	Margin dB	SA reading dBuV	Factor dB	Remark	ANT High cm	Turn Table deg
1	5460.00	45.01	54.00	-8.99	38.25	6.76	Average	304	235
2	5460.00	56.02	74.00	-17.98	49.26	6.76	Peak	304	235
3	5470.00	57.03	68.20	-11.17	50.26	6.77	Peak	304	235
4	5725.00	57.02	68.20	-11.18	49.78	7.24	Peak	304	235
5	11160.00	46.65	54.00	-7.35	29.86	16.79	Average	271	300
6	11160.00	59.15	74.00	-14.85	42.36	16.79	Peak	271	300
7	16740.00	67.70	68.20	-0.50	49.30	18.40	Peak	209	297

Note 1: Emission Level (dBuV/m) = SA Reading (dBuV/m) + Factor\* (dB)

\*Factor includes antenna factor , cable loss and amplifier gain

Note 2: Margin (dB) = Emission level (dBuV/m) – Limit (dBuV/m).

<b>Modulation</b>	HT20	<b>Test Freq. (MHz)</b>	5580
<b>Polarization</b>	Vertical	<b>Test Configuration</b>	1

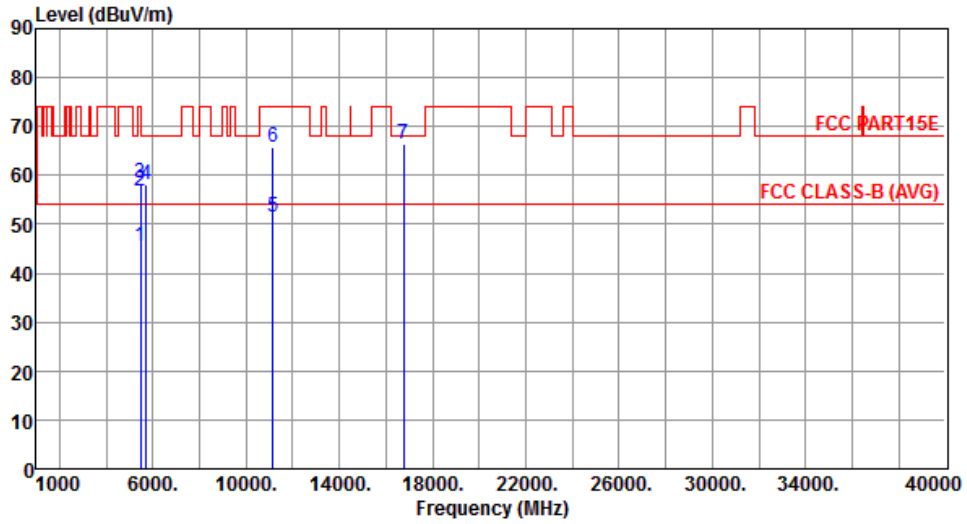

	Freq. MHz	Emission level dBuV/m	Limit dBuV/m	Margin dB	SA reading dBuV	Factor dB	Remark	ANT High cm	Turn Table deg
1	5460.00	45.35	54.00	-8.65	38.59	6.76	Average	157	354
2	5460.00	56.62	74.00	-17.38	49.86	6.76	Peak	157	354
3	5470.00	58.40	68.20	-9.80	51.63	6.77	Peak	157	354
4	5725.00	57.98	68.20	-10.22	50.74	7.24	Peak	157	354
5	11160.00	51.38	54.00	-2.62	34.59	16.79	Average	250	2
6	11160.00	65.66	74.00	-8.34	48.87	16.79	Peak	250	2
7	16740.00	66.27	68.20	-1.93	47.87	18.40	Peak	166	7

Note 1: Emission Level (dBuV/m) = SA Reading (dBuV/m) + Factor\* (dB)

\*Factor includes antenna factor , cable loss and amplifier gain

Note 2: Margin (dB) = Emission level (dBuV/m) – Limit (dBuV/m).

<b>Modulation</b>	HT20	<b>Test Freq. (MHz)</b>	5700
<b>Polarization</b>	Horizontal	<b>Test Configuration</b>	1

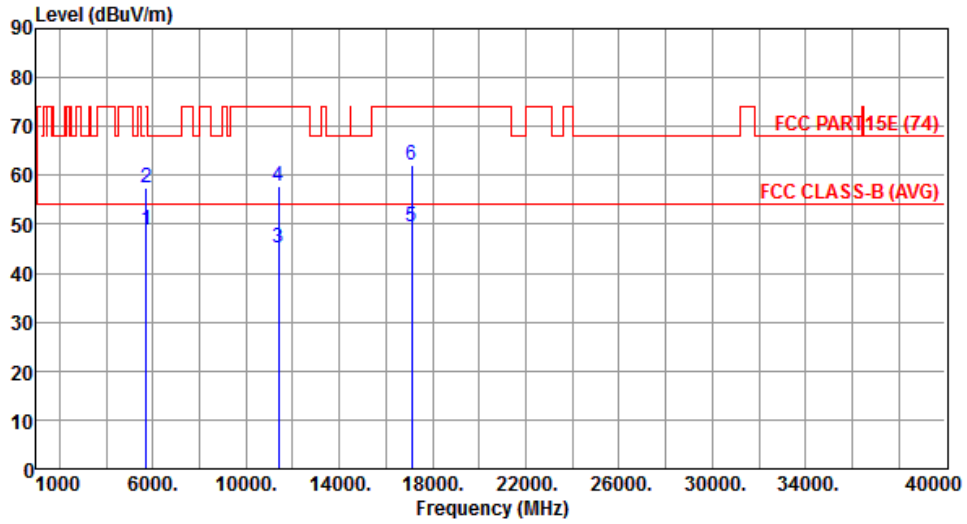

	Freq. MHz	Emission level dBuV/m	Limit dBuV/m	Margin dB	SA reading dBuV	Factor dB	Remark	ANT High cm	Turn Table deg
1	5725.00	48.83	54.00	-5.17	41.59	7.24	Average	303	235
2	5725.00	57.53	74.00	-16.47	50.29	7.24	Peak	303	235
3	11400.00	45.18	54.00	-8.82	28.30	16.88	Average	326	216
4	11400.00	57.86	74.00	-16.14	40.98	16.88	Peak	326	216
5	17100.00	49.41	54.00	-4.59	30.29	19.12	Average	300	175
6	17100.00	62.21	74.00	-11.79	43.09	19.12	Peak	300	175

Note 1: Emission Level (dBuV/m) = SA Reading (dBuV/m) + Factor\* (dB)

\*Factor includes antenna factor , cable loss and amplifier gain

Note 2: Margin (dB) = Emission level (dBuV/m) – Limit (dBuV/m).

<b>Modulation</b>	HT20	<b>Test Freq. (MHz)</b>	5700
<b>Polarization</b>	Vertical	<b>Test Configuration</b>	1

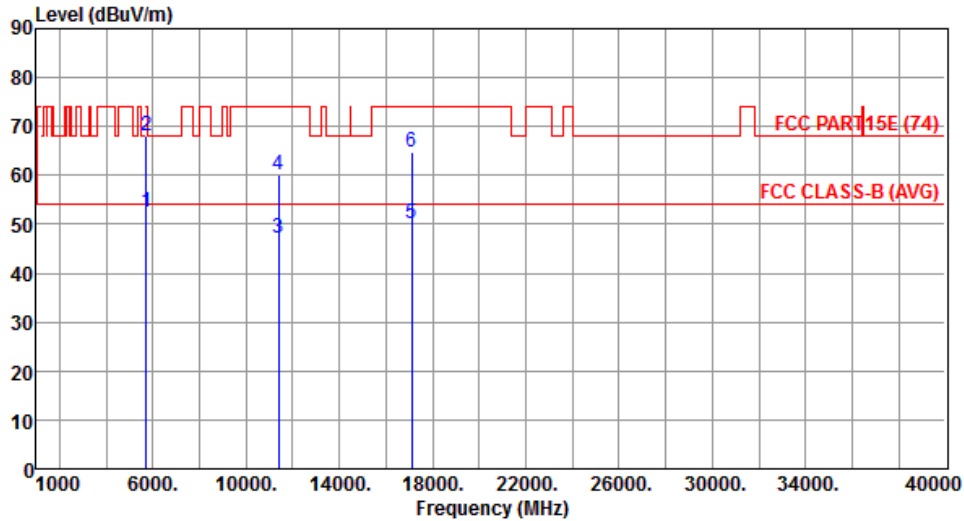

	Freq. MHz	Emission level dBuV/m	Limit dBuV/m	Margin dB	SA reading dBuV	Factor dB	Remark	ANT High cm	Turn Table deg
1	5725.00	52.51	54.00	-1.49	45.27	7.24	Average	130	16
2	5725.00	67.99	74.00	-6.01	60.75	7.24	Peak	130	16
3	11400.00	47.17	54.00	-6.83	30.29	16.88	Average	190	267
4	11400.00	60.14	74.00	-13.86	43.26	16.88	Peak	190	267
5	17100.00	49.99	54.00	-4.01	30.87	19.12	Average	326	305
6	17100.00	64.72	74.00	-9.28	45.60	19.12	Peak	326	305

Note 1: Emission Level (dBuV/m) = SA Reading (dBuV/m) + Factor\* (dB)

\*Factor includes antenna factor , cable loss and amplifier gain

Note 2: Margin (dB) = Emission level (dBuV/m) – Limit (dBuV/m).

<b>Modulation</b>	HT20	<b>Test Freq. (MHz)</b>	5745
<b>Polarization</b>	Horizontal	<b>Test Configuration</b>	1

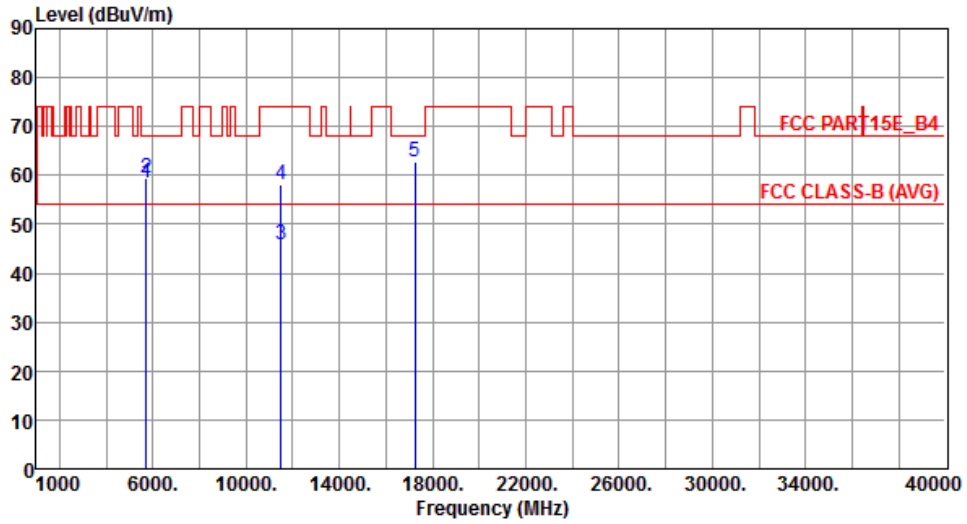

	Freq. MHz	Emission level dBuV/m	Limit dBuV/m	Margin dB	SA reading dBuV	Factor dB	Remark	ANT High cm	Turn Table deg
1	5715.00	58.32	68.20	-9.88	51.12	7.20	Peak	300	225
2	5725.00	59.43	78.20	-18.77	52.19	7.24	Peak	300	225
3	11490.00	45.77	54.00	-8.23	28.86	16.91	Average	303	189
4	11490.00	58.18	74.00	-15.82	41.27	16.91	Peak	303	189
5	17235.00	62.85	68.20	-5.35	43.53	19.32	Peak	322	211

Note 1: Emission Level (dBuV/m) = SA Reading (dBuV/m) + Factor\* (dB)

\*Factor includes antenna factor , cable loss and amplifier gain

Note 2: Margin (dB) = Emission level (dBuV/m) – Limit (dBuV/m).



<b>Modulation</b>	HT20	<b>Test Freq. (MHz)</b>	5745
<b>Polarization</b>	Vertical	<b>Test Configuration</b>	1

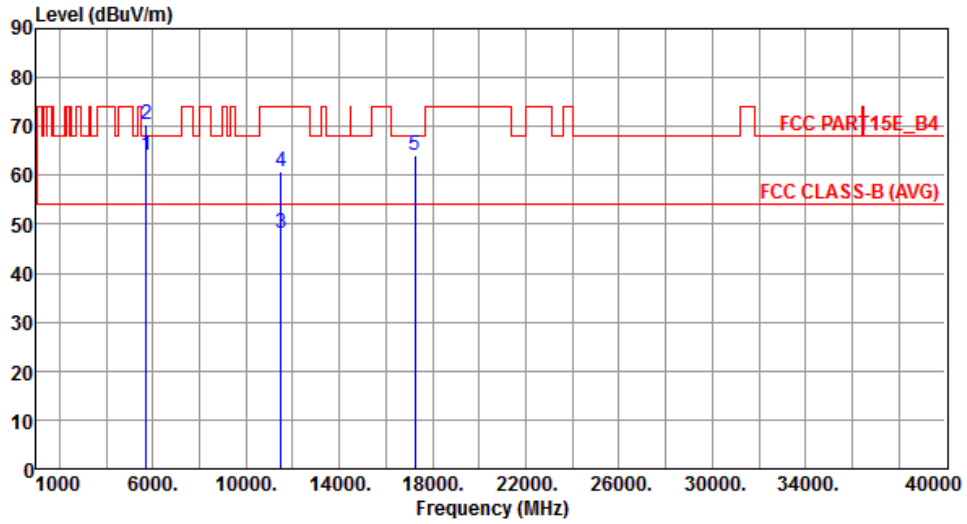

	Freq. MHz	Emission level dBuV/m	Limit dBuV/m	Margin dB	SA reading dBuV	Factor dB	Remark	ANT High cm	Turn Table deg
1	5715.00	64.00	68.20	-4.20	56.80	7.20	Peak	163	17
2	5725.00	70.26	78.20	-7.94	63.02	7.24	Peak	163	17
3	11490.00	48.17	54.00	-5.83	31.26	16.91	Average	199	265
4	11490.00	60.75	74.00	-13.25	43.84	16.91	Peak	199	265
5	17235.00	63.94	68.20	-4.26	44.62	19.32	Peak	303	311

Note 1: Emission Level (dBuV/m) = SA Reading (dBuV/m) + Factor\* (dB)

\*Factor includes antenna factor , cable loss and amplifier gain

Note 2: Margin (dB) = Emission level (dBuV/m) – Limit (dBuV/m).

<b>Modulation</b>	HT20	<b>Test Freq. (MHz)</b>	5785
<b>Polarization</b>	Horizontal	<b>Test Configuration</b>	1

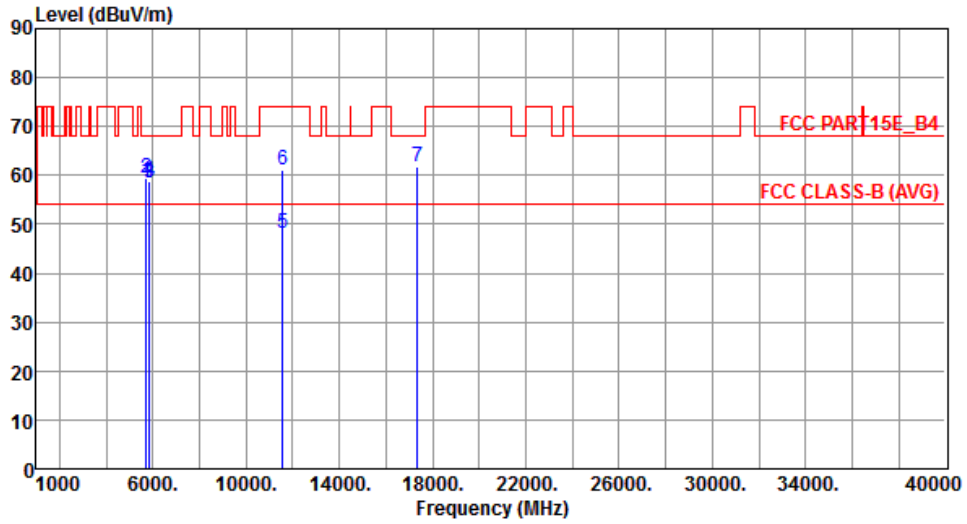

	Freq. MHz	Emission level dBuV/m	Limit dBuV/m	Margin dB	SA reading dBuV	Factor dB	Remark	ANT High cm	Turn Table deg
1	5715.00	58.83	68.20	-9.37	51.63	7.20	Peak	300	226
2	5725.00	59.59	78.20	-18.61	52.35	7.24	Peak	300	226
3	5850.00	58.56	78.20	-19.64	51.06	7.50	Peak	300	226
4	5860.00	58.86	68.20	-9.34	51.35	7.51	Peak	300	226
5	11570.00	48.31	54.00	-5.69	31.51	16.80	Average	286	188
6	11570.00	60.96	74.00	-13.04	44.16	16.80	Peak	286	188
7	17355.00	61.65	68.20	-6.55	42.16	19.49	Peak	311	215

Note 1: Emission Level (dBuV/m) = SA Reading (dBuV/m) + Factor\* (dB)

\*Factor includes antenna factor , cable loss and amplifier gain

Note 2: Margin (dB) = Emission level (dBuV/m) – Limit (dBuV/m).

<b>Modulation</b>	HT20	<b>Test Freq. (MHz)</b>	5785
<b>Polarization</b>	Vertical	<b>Test Configuration</b>	1

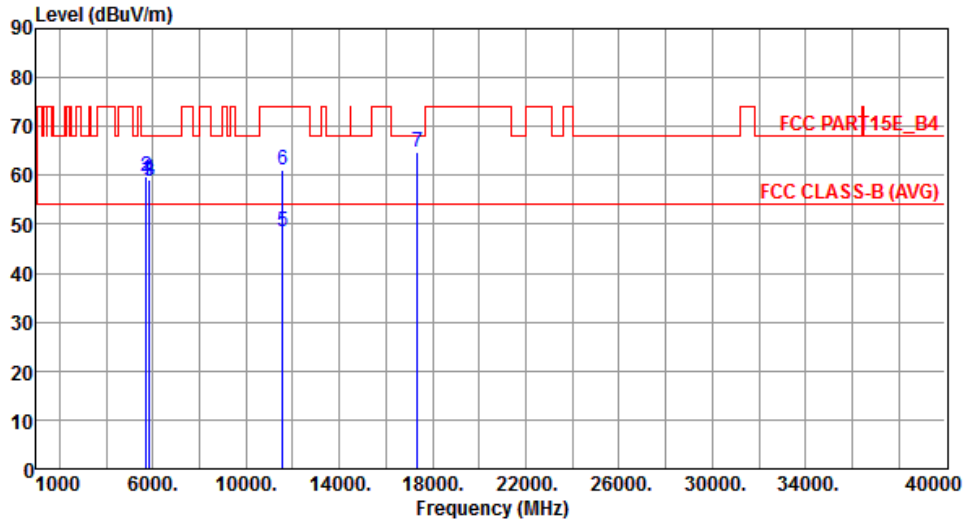

	Freq. MHz	Emission level dBuV/m	Limit dBuV/m	Margin dB	SA reading dBuV	Factor dB	Remark	ANT High cm	Turn Table deg
1	5715.00	59.25	68.20	-8.95	52.05	7.20	Peak	159	14
2	5725.00	59.89	78.20	-18.31	52.65	7.24	Peak	159	14
3	5850.00	58.72	78.20	-19.48	51.22	7.50	Peak	159	14
4	5860.00	59.16	68.20	-9.04	51.65	7.51	Peak	159	14
5	11570.00	48.39	54.00	-5.61	31.59	16.80	Average	199	253
6	11570.00	61.15	74.00	-12.85	44.35	16.80	Peak	199	253
7	17355.00	64.85	68.20	-3.35	45.36	19.49	Peak	299	303

Note 1: Emission Level (dBuV/m) = SA Reading (dBuV/m) + Factor\* (dB)

\*Factor includes antenna factor , cable loss and amplifier gain

Note 2: Margin (dB) = Emission level (dBuV/m) – Limit (dBuV/m).

<b>Modulation</b>	HT20	<b>Test Freq. (MHz)</b>	5825
<b>Polarization</b>	Horizontal	<b>Test Configuration</b>	1

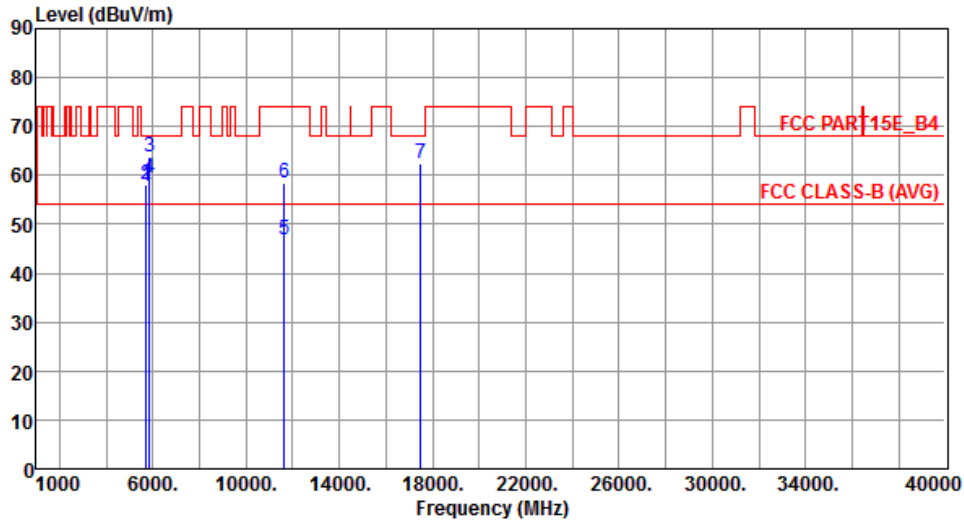

	Freq. MHz	Emission level dBuV/m	Limit dBuV/m	Margin dB	SA reading dBuV	Factor dB	Remark	ANT High cm	Turn Table deg
1	5715.00	57.86	68.20	-10.34	50.66	7.20	Peak	294	223
2	5725.00	58.12	78.20	-20.08	50.88	7.24	Peak	294	223
3	5850.00	63.61	78.20	-14.59	56.11	7.50	Peak	294	223
4	5860.00	59.53	68.20	-8.67	52.02	7.51	Peak	159	13
5	11650.00	46.83	54.00	-7.17	30.18	16.65	Average	300	192
6	11650.00	58.30	74.00	-15.70	41.65	16.65	Peak	300	192
7	17475.00	62.52	68.20	-5.68	42.86	19.66	Peak	311	216

Note 1: Emission Level (dBuV/m) = SA Reading (dBuV/m) + Factor\* (dB)

\*Factor includes antenna factor , cable loss and amplifier gain

Note 2: Margin (dB) = Emission level (dBuV/m) – Limit (dBuV/m).

<b>Modulation</b>	HT20	<b>Test Freq. (MHz)</b>	5825
<b>Polarization</b>	Vertical	<b>Test Configuration</b>	1

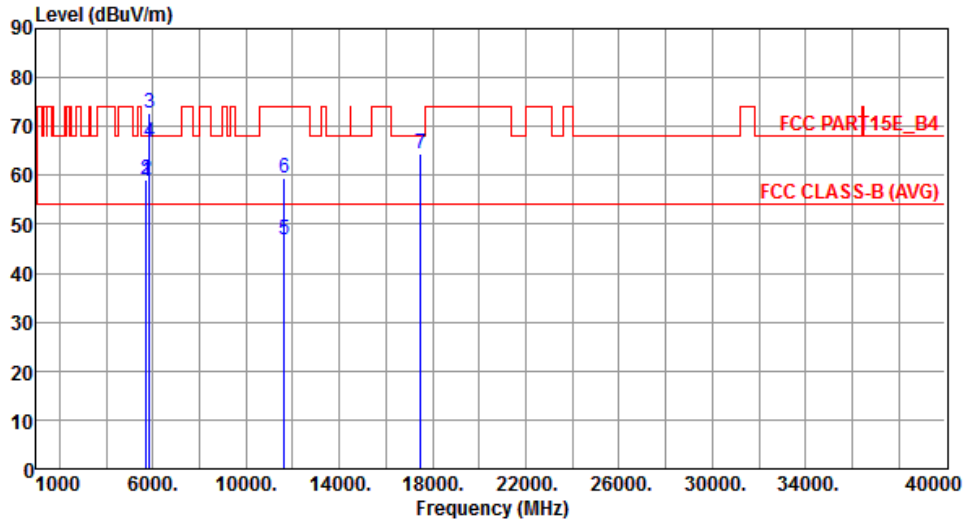

	Freq. MHz	Emission level dBuV/m	Limit dBuV/m	Margin dB	SA reading dBuV	Factor dB	Remark	ANT High cm	Turn Table deg
1	5715.00	58.94	68.20	-9.26	51.74	7.20	Peak	159	13
2	5725.00	59.12	78.20	-19.08	51.88	7.24	Peak	159	13
3	5850.00	72.68	78.20	-5.52	65.18	7.50	Peak	159	13
4	5860.00	66.62	68.20	-1.58	59.11	7.51	Peak	159	13
5	11650.00	46.91	54.00	-7.09	30.26	16.65	Average	199	238
6	11650.00	59.54	74.00	-14.46	42.89	16.65	Peak	199	238
7	17475.00	64.52	68.20	-3.68	44.86	19.66	Peak	296	303

Note 1: Emission Level (dBuV/m) = SA Reading (dBuV/m) + Factor\* (dB)

\*Factor includes antenna factor , cable loss and amplifier gain

Note 2: Margin (dB) = Emission level (dBuV/m) – Limit (dBuV/m).

### 3.5.7 Transmitter Radiated Unwanted Emissions (Above 1GHz) for HT40

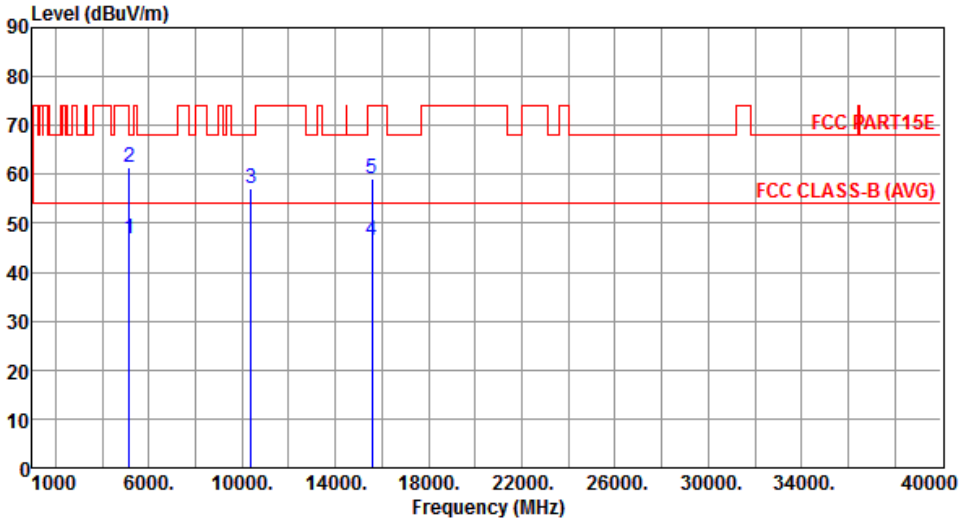
Modulation	HT40	Test Freq. (MHz)	5190																																																																									
Polarization	Horizontal	Test Configuration	1																																																																									
																																																																												
	<table border="1"> <thead> <tr> <th>Freq.</th> <th>Emission level</th> <th>Limit</th> <th>Margin</th> <th>SA reading</th> <th>Factor</th> <th>Remark</th> <th>ANT High</th> <th>Turn Table</th> </tr> <tr> <th>MHz</th> <th>dBuV/m</th> <th>dBuV/m</th> <th>dB</th> <th>dBuV</th> <th>dB</th> <th></th> <th>cm</th> <th>deg</th> </tr> </thead> <tbody> <tr> <td>1</td> <td>5150.00</td> <td>46.92</td> <td>54.00</td> <td>-7.08</td> <td>40.61</td> <td>6.31</td> <td>Average</td> <td>320</td> <td>226</td> </tr> <tr> <td>2</td> <td>5150.00</td> <td>61.36</td> <td>74.00</td> <td>-12.64</td> <td>55.05</td> <td>6.31</td> <td>Peak</td> <td>320</td> <td>226</td> </tr> <tr> <td>3</td> <td>10380.00</td> <td>57.26</td> <td>68.20</td> <td>-10.94</td> <td>40.89</td> <td>16.37</td> <td>Peak</td> <td>311</td> <td>221</td> </tr> <tr> <td>4</td> <td>15570.00</td> <td>46.58</td> <td>54.00</td> <td>-7.42</td> <td>29.15</td> <td>17.43</td> <td>Average</td> <td>300</td> <td>256</td> </tr> <tr> <td>5</td> <td>15570.00</td> <td>58.99</td> <td>74.00</td> <td>-15.01</td> <td>41.56</td> <td>17.43</td> <td>Peak</td> <td>300</td> <td>256</td> </tr> </tbody> </table>	Freq.	Emission level	Limit	Margin	SA reading	Factor	Remark	ANT High	Turn Table	MHz	dBuV/m	dBuV/m	dB	dBuV	dB		cm	deg	1	5150.00	46.92	54.00	-7.08	40.61	6.31	Average	320	226	2	5150.00	61.36	74.00	-12.64	55.05	6.31	Peak	320	226	3	10380.00	57.26	68.20	-10.94	40.89	16.37	Peak	311	221	4	15570.00	46.58	54.00	-7.42	29.15	17.43	Average	300	256	5	15570.00	58.99	74.00	-15.01	41.56	17.43	Peak	300	256							
Freq.	Emission level	Limit	Margin	SA reading	Factor	Remark	ANT High	Turn Table																																																																				
MHz	dBuV/m	dBuV/m	dB	dBuV	dB		cm	deg																																																																				
1	5150.00	46.92	54.00	-7.08	40.61	6.31	Average	320	226																																																																			
2	5150.00	61.36	74.00	-12.64	55.05	6.31	Peak	320	226																																																																			
3	10380.00	57.26	68.20	-10.94	40.89	16.37	Peak	311	221																																																																			
4	15570.00	46.58	54.00	-7.42	29.15	17.43	Average	300	256																																																																			
5	15570.00	58.99	74.00	-15.01	41.56	17.43	Peak	300	256																																																																			
<p>Note 1: Emission Level (dBuV/m) = SA Reading (dBuV/m) + Factor* (dB)            *Factor includes antenna factor , cable loss and amplifier gain            Note 2: Margin (dB) = Emission level (dBuV/m) – Limit (dBuV/m).</p>																																																																												

<b>Modulation</b>	HT40	<b>Test Freq. (MHz)</b>	5190
<b>Polarization</b>	Vertical	<b>Test Configuration</b>	1

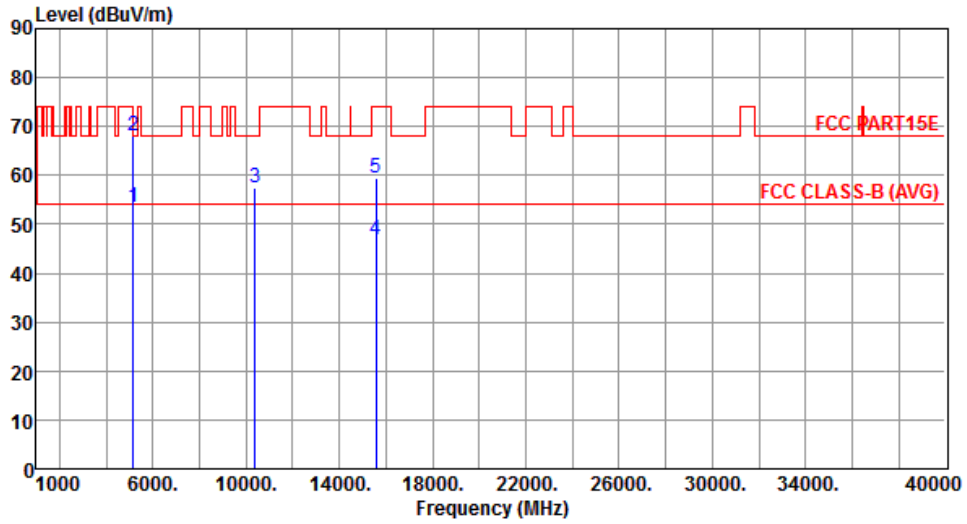

	Freq. MHz	Emission level dBuV/m	Limit dBuV/m	Margin dB	SA reading dBuV	Factor dB	Remark	ANT High cm	Turn Table deg
1	5150.00	53.36	54.00	-0.64	47.05	6.31	Average	162	25
2	5150.00	68.19	74.00	-5.81	61.88	6.31	Peak	162	25
3	10380.00	57.43	68.20	-10.77	41.06	16.37	Peak	188	293
4	15570.00	46.99	54.00	-7.01	29.56	17.43	Average	183	246
5	15570.00	59.54	74.00	-14.46	42.11	17.43	Peak	183	246

Note 1: Emission Level (dBuV/m) = SA Reading (dBuV/m) + Factor\* (dB)

\*Factor includes antenna factor , cable loss and amplifier gain

Note 2: Margin (dB) = Emission level (dBuV/m) – Limit (dBuV/m).

<b>Modulation</b>	HT40	<b>Test Freq. (MHz)</b>	5230
<b>Polarization</b>	Horizontal	<b>Test Configuration</b>	1

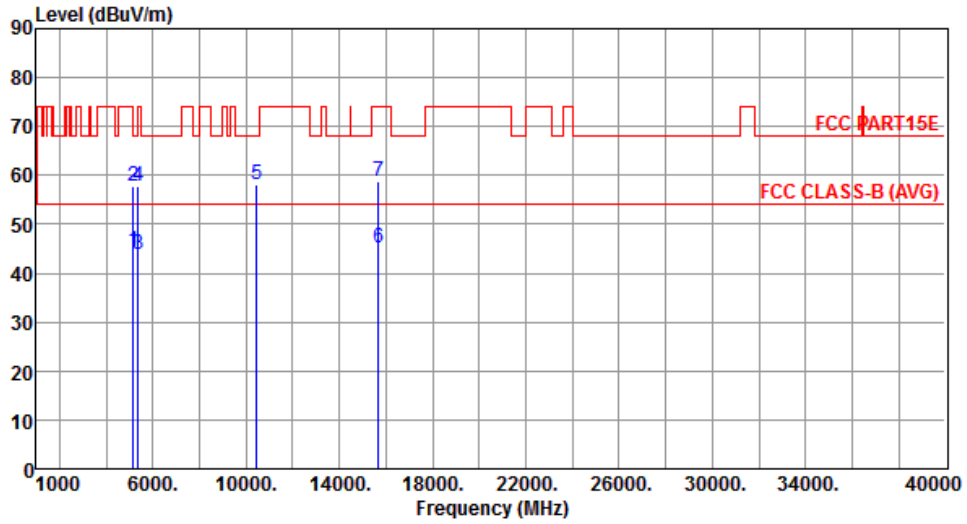

	Freq. MHz	Emission level dBuV/m	Limit dBuV/m	Margin dB	SA reading dBuV	Factor dB	Remark	ANT High cm	Turn Table deg
1	5150.00	44.36	54.00	-9.64	38.05	6.31	Average	321	229
2	5150.00	57.85	74.00	-16.15	51.54	6.31	Peak	321	229
3	5350.00	43.93	54.00	-10.07	37.31	6.62	Average	321	229
4	5350.00	57.71	74.00	-16.29	51.09	6.62	Peak	321	229
5	10460.00	58.25	68.20	-9.95	41.72	16.53	Peak	299	253
6	15690.00	45.10	54.00	-8.90	27.88	17.22	Average	311	283
7	15690.00	58.80	74.00	-15.20	41.58	17.22	Peak	311	283

Note 1: Emission Level (dBuV/m) = SA Reading (dBuV/m) + Factor\* (dB)

\*Factor includes antenna factor , cable loss and amplifier gain

Note 2: Margin (dB) = Emission level (dBuV/m) – Limit (dBuV/m).



<b>Modulation</b>	HT40	<b>Test Freq. (MHz)</b>	5230
<b>Polarization</b>	Vertical	<b>Test Configuration</b>	1

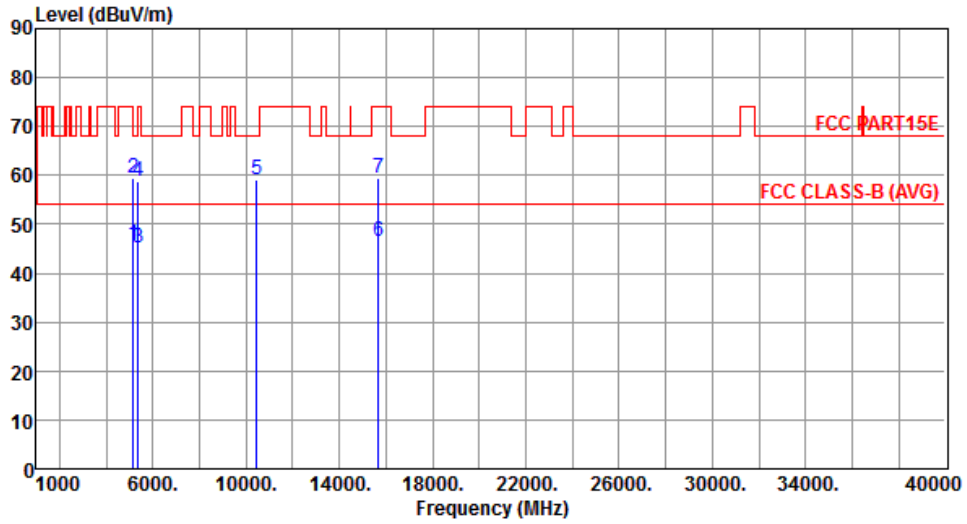

	Freq. MHz	Emission level dBuV/m	Limit dBuV/m	Margin dB	SA reading dBuV	Factor dB	Remark	ANT High cm	Turn Table deg
1	5150.00	45.73	54.00	-8.27	39.42	6.31	Average	161	23
2	5150.00	59.41	74.00	-14.59	53.10	6.31	Peak	161	23
3	5350.00	45.08	54.00	-8.92	38.46	6.62	Average	161	23
4	5350.00	58.73	74.00	-15.27	52.11	6.62	Peak	161	23
5	10460.00	59.11	68.20	-9.09	42.58	16.53	Peak	186	243
6	15690.00	46.36	54.00	-7.64	29.14	17.22	Average	235	288
7	15690.00	59.32	74.00	-14.68	42.10	17.22	Peak	235	288

Note 1: Emission Level (dBuV/m) = SA Reading (dBuV/m) + Factor\* (dB)

\*Factor includes antenna factor , cable loss and amplifier gain

Note 2: Margin (dB) = Emission level (dBuV/m) – Limit (dBuV/m).

<b>Modulation</b>	HT40	<b>Test Freq. (MHz)</b>	5270
<b>Polarization</b>	Horizontal	<b>Test Configuration</b>	1

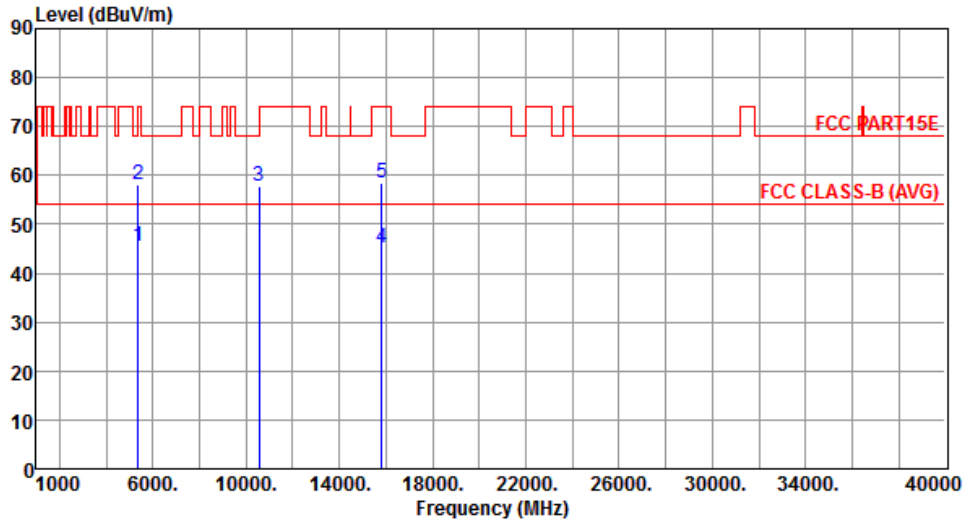

	Freq. MHz	Emission level dBuV/m	Limit dBuV/m	Margin dB	SA reading dBuV	Factor dB	Remark	ANT High cm	Turn Table deg
1	5350.00	45.60	54.00	-8.40	38.98	6.62	Average	298	231
2	5350.00	58.27	74.00	-15.73	51.65	6.62	Peak	298	231
3	10540.00	57.70	68.20	-10.50	41.10	16.60	Peak	300	196
4	15810.00	45.28	54.00	-8.72	28.30	16.98	Average	298	306
5	15810.00	58.34	74.00	-15.66	41.36	16.98	Peak	298	306

Note 1: Emission Level (dBuV/m) = SA Reading (dBuV/m) + Factor\* (dB)

\*Factor includes antenna factor , cable loss and amplifier gain

Note 2: Margin (dB) = Emission level (dBuV/m) – Limit (dBuV/m).

<b>Modulation</b>	HT40	<b>Test Freq. (MHz)</b>	5270
<b>Polarization</b>	Vertical	<b>Test Configuration</b>	1

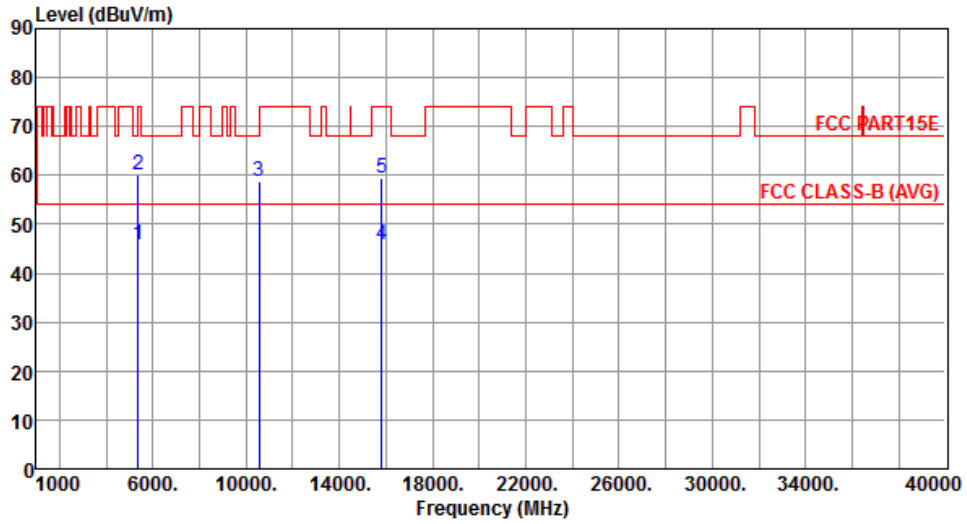

	Freq. MHz	Emission level dBuV/m	Limit dBuV/m	Margin dB	SA reading dBuV	Factor dB	Remark	ANT High cm	Turn Table deg
1	5350.00	45.83	54.00	-8.17	39.21	6.62	Average	155	23
2	5350.00	59.97	74.00	-14.03	53.35	6.62	Peak	155	23
3	10540.00	58.72	68.20	-9.48	42.12	16.60	Peak	183	265
4	15810.00	45.88	54.00	-8.12	28.90	16.98	Average	222	298
5	15810.00	59.38	74.00	-14.62	42.40	16.98	Peak	222	298

Note 1: Emission Level (dBuV/m) = SA Reading (dBuV/m) + Factor\* (dB)

\*Factor includes antenna factor , cable loss and amplifier gain

Note 2: Margin (dB) = Emission level (dBuV/m) – Limit (dBuV/m).

<b>Modulation</b>	HT40	<b>Test Freq. (MHz)</b>	5310
<b>Polarization</b>	Horizontal	<b>Test Configuration</b>	1

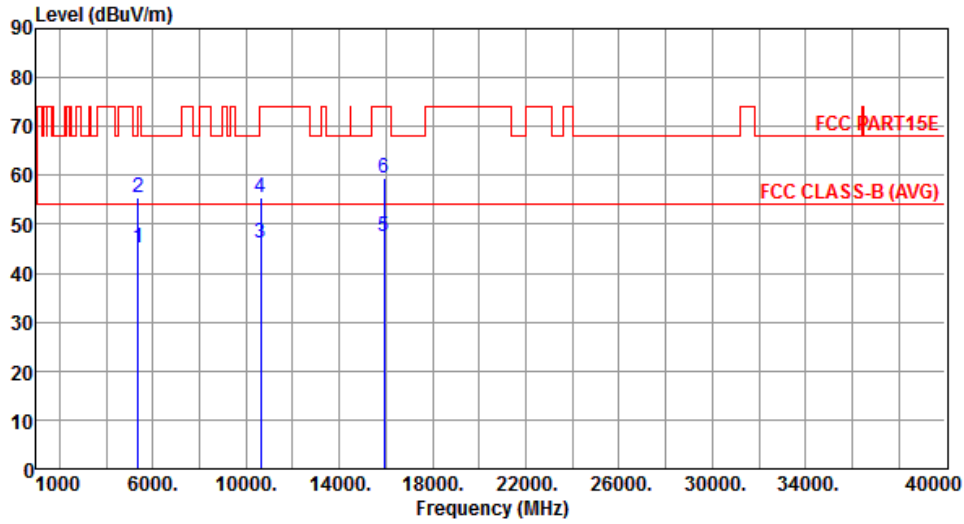

	Freq. MHz	Emission level dBuV/m	Limit dBuV/m	Margin dB	SA reading dBuV	Factor dB	Remark	ANT High cm	Turn Table deg
1	5350.00	45.02	54.00	-8.98	38.40	6.62	Average	297	347
2	5350.00	55.48	74.00	-18.52	48.86	6.62	Peak	297	347
3	10620.00	46.31	54.00	-7.69	29.69	16.62	Average	173	267
4	10620.00	55.61	74.00	-18.39	38.99	16.62	Peak	173	267
5	15930.00	47.55	54.00	-6.45	30.78	16.77	Average	288	305
6	15930.00	59.55	74.00	-14.45	42.78	16.77	Peak	288	305

Note 1: Emission Level (dBuV/m) = SA Reading (dBuV/m) + Factor\* (dB)

\*Factor includes antenna factor , cable loss and amplifier gain

Note 2: Margin (dB) = Emission level (dBuV/m) – Limit (dBuV/m).

<b>Modulation</b>	HT40	<b>Test Freq. (MHz)</b>	5310
<b>Polarization</b>	Vertical	<b>Test Configuration</b>	1

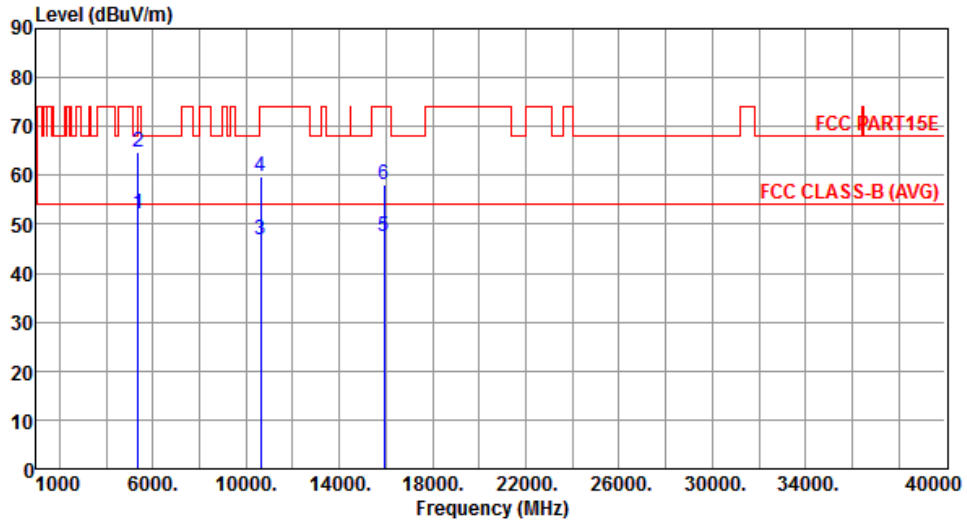

	Freq. MHz	Emission level dBuV/m	Limit dBuV/m	Margin dB	SA reading dBuV	Factor dB	Remark	ANT High cm	Turn Table deg
1	5350.00	52.29	54.00	-1.71	45.67	6.62	Average	130	333
2	5350.00	64.83	74.00	-9.17	58.21	6.62	Peak	130	333
3	10620.00	46.87	54.00	-7.13	30.25	16.62	Average	307	276
4	10620.00	59.61	74.00	-14.39	42.99	16.62	Peak	307	276
5	15930.00	47.47	54.00	-6.53	30.70	16.77	Average	241	98
6	15930.00	58.16	74.00	-15.84	41.39	16.77	Peak	241	98

Note 1: Emission Level (dBuV/m) = SA Reading (dBuV/m) + Factor\* (dB)

\*Factor includes antenna factor , cable loss and amplifier gain

Note 2: Margin (dB) = Emission level (dBuV/m) – Limit (dBuV/m).

<b>Modulation</b>	HT40	<b>Test Freq. (MHz)</b>	5510
<b>Polarization</b>	Horizontal	<b>Test Configuration</b>	1

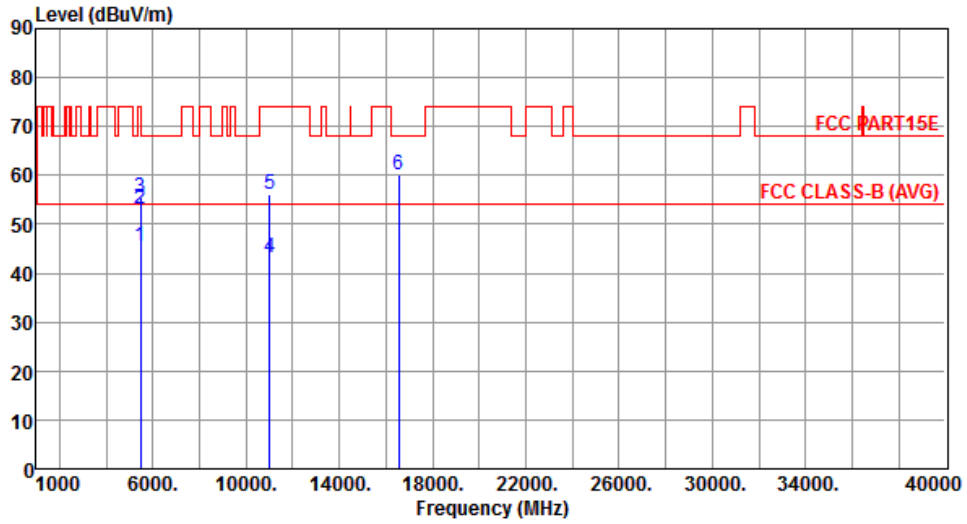

	Freq. MHz	Emission level dBuV/m	Limit dBuV/m	Margin dB	SA reading dBuV	Factor dB	Remark	ANT High cm	Turn Table deg
1	5460.00	45.65	54.00	-8.35	38.89	6.76	Average	314	8
2	5460.00	53.29	74.00	-20.71	46.53	6.76	Peak	314	8
3	5470.00	55.54	68.20	-12.66	48.77	6.77	Peak	314	8
4	11020.00	43.17	54.00	-10.83	26.44	16.73	Average	241	159
5	11020.00	55.99	74.00	-18.01	39.26	16.73	Peak	241	159
6	16530.00	60.20	68.20	-8.00	42.26	17.94	Peak	130	17

Note 1: Emission Level (dBuV/m) = SA Reading (dBuV/m) + Factor\* (dB)

\*Factor includes antenna factor , cable loss and amplifier gain

Note 2: Margin (dB) = Emission level (dBuV/m) – Limit (dBuV/m).

<b>Modulation</b>	HT40	<b>Test Freq. (MHz)</b>	5510
<b>Polarization</b>	Vertical	<b>Test Configuration</b>	1

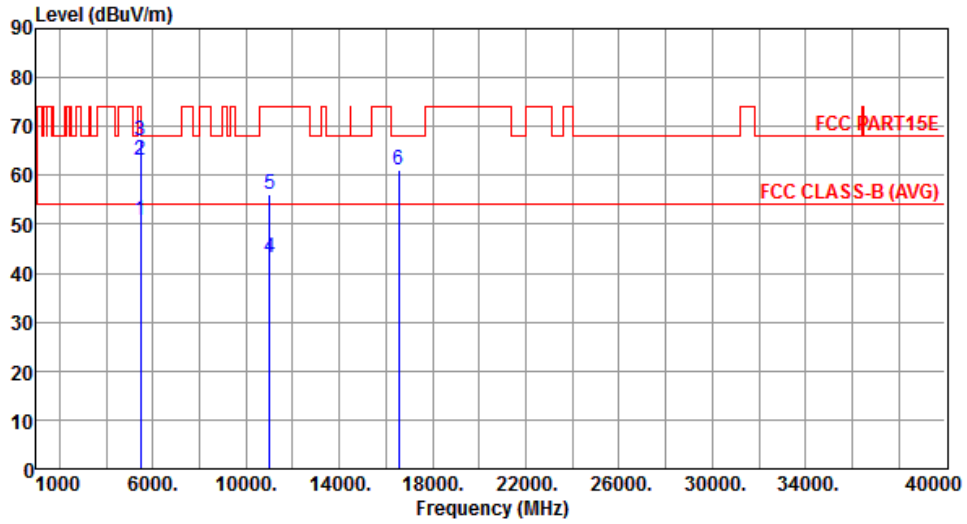

	Freq. MHz	Emission level dBuV/m	Limit dBuV/m	Margin dB	SA reading dBuV	Factor dB	Remark	ANT High cm	Turn Table deg
1	5460.00	50.81	54.00	-3.19	44.05	6.76	Average	155	336
2	5460.00	63.14	74.00	-10.86	56.38	6.76	Peak	155	336
3	5470.00	66.96	68.20	-1.24	60.19	6.77	Peak	155	336
4	11020.00	43.08	54.00	-10.92	26.35	16.73	Average	325	127
5	11020.00	56.19	74.00	-17.81	39.46	16.73	Peak	325	127
6	16530.00	61.20	68.20	-7.00	43.26	17.94	Peak	270	20

Note 1: Emission Level (dBuV/m) = SA Reading (dBuV/m) + Factor\* (dB)

\*Factor includes antenna factor , cable loss and amplifier gain

Note 2: Margin (dB) = Emission level (dBuV/m) – Limit (dBuV/m).

<b>Modulation</b>	HT40	<b>Test Freq. (MHz)</b>	5590
<b>Polarization</b>	Horizontal	<b>Test Configuration</b>	1

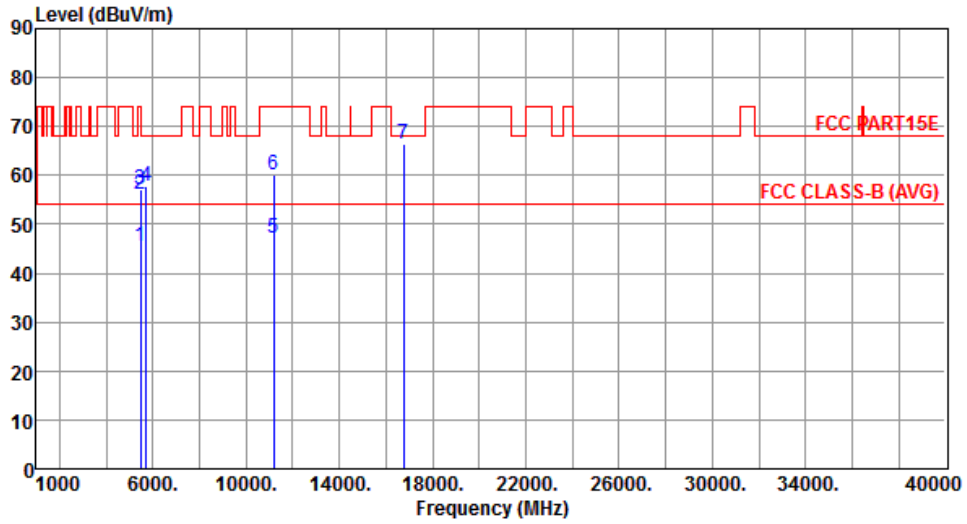

	Freq. MHz	Emission level dBuV/m	Limit dBuV/m	Margin dB	SA reading dBuV	Factor dB	Remark	ANT High cm	Turn Table deg
1	5460.00	45.54	54.00	-8.46	38.78	6.76	Average	302	56
2	5460.00	56.05	74.00	-17.95	49.29	6.76	Peak	302	56
3	5470.00	57.12	68.20	-11.08	50.35	6.77	Peak	302	56
4	5725.00	57.62	68.20	-10.58	50.38	7.24	Peak	302	56
5	11180.00	47.09	54.00	-6.91	30.30	16.79	Average	189	0
6	11180.00	60.05	74.00	-13.95	43.26	16.79	Peak	189	0
7	16770.00	66.44	68.20	-1.76	47.97	18.47	Peak	249	297

Note 1: Emission Level (dBuV/m) = SA Reading (dBuV/m) + Factor\* (dB)

\*Factor includes antenna factor , cable loss and amplifier gain

Note 2: Margin (dB) = Emission level (dBuV/m) – Limit (dBuV/m).



<b>Modulation</b>	HT40	<b>Test Freq. (MHz)</b>	5590
<b>Polarization</b>	Vertical	<b>Test Configuration</b>	1

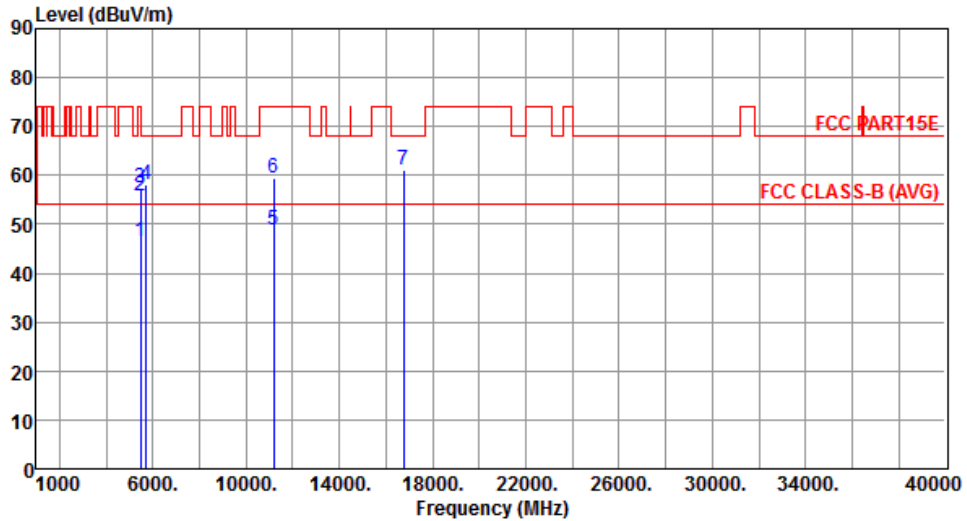

	Freq. MHz	Emission level dBuV/m	Limit dBuV/m	Margin dB	SA reading dBuV	Factor dB	Remark	ANT High cm	Turn Table deg
1	5460.00	46.34	54.00	-7.66	39.58	6.76	Average	155	9
2	5460.00	55.95	74.00	-18.05	49.19	6.76	Peak	155	9
3	5470.00	57.45	68.20	-10.75	50.68	6.77	Peak	155	9
4	5725.00	58.08	68.20	-10.12	50.84	7.24	Peak	155	9
5	11180.00	48.87	54.00	-5.13	32.08	16.79	Average	235	354
6	11180.00	59.35	74.00	-14.65	42.56	16.79	Peak	235	354
7	16770.00	61.27	68.20	-6.93	42.80	18.47	Peak	175	5

Note 1: Emission Level (dBuV/m) = SA Reading (dBuV/m) + Factor\* (dB)

\*Factor includes antenna factor , cable loss and amplifier gain

Note 2: Margin (dB) = Emission level (dBuV/m) – Limit (dBuV/m).

<b>Modulation</b>	HT40	<b>Test Freq. (MHz)</b>	5670
<b>Polarization</b>	Horizontal	<b>Test Configuration</b>	1

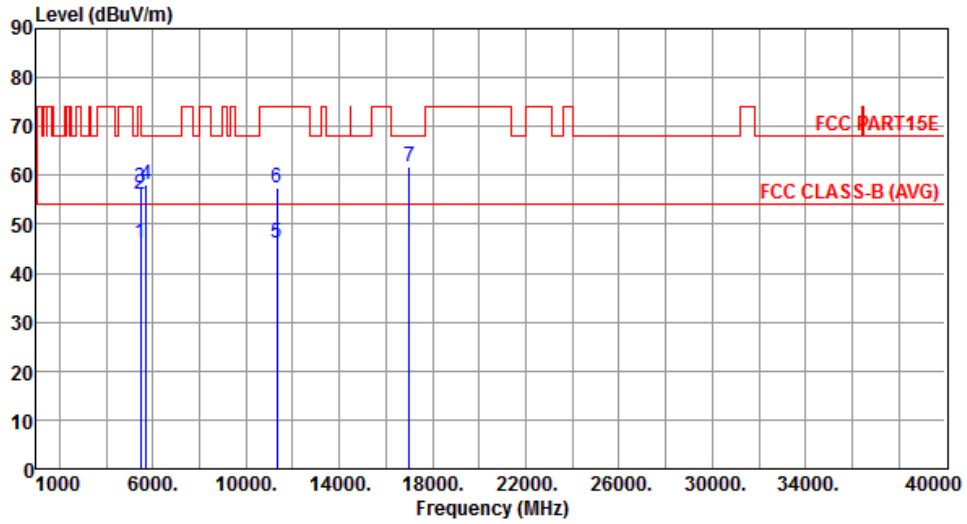

	Freq. MHz	Emission level dBuV/m	Limit dBuV/m	Margin dB	SA reading dBuV	Factor dB	Remark	ANT High cm	Turn Table deg
1	5460.00	46.01	54.00	-7.99	39.25	6.76	Average	285	49
2	5460.00	56.01	74.00	-17.99	49.25	6.76	Peak	285	49
3	5470.00	57.36	68.20	-10.84	50.59	6.77	Peak	285	49
4	5725.00	58.22	68.20	-9.98	50.98	7.24	Peak	285	49
5	11340.00	46.12	54.00	-7.88	29.27	16.85	Average	280	269
6	11340.00	57.52	74.00	-16.48	40.67	16.85	Peak	280	269
7	17010.00	61.66	68.20	-6.54	42.67	18.99	Peak	329	137

Note 1: Emission Level (dBuV/m) = SA Reading (dBuV/m) + Factor\* (dB)

\*Factor includes antenna factor , cable loss and amplifier gain

Note 2: Margin (dB) = Emission level (dBuV/m) – Limit (dBuV/m).

<b>Modulation</b>	HT40	<b>Test Freq. (MHz)</b>	5670
<b>Polarization</b>	Vertical	<b>Test Configuration</b>	1

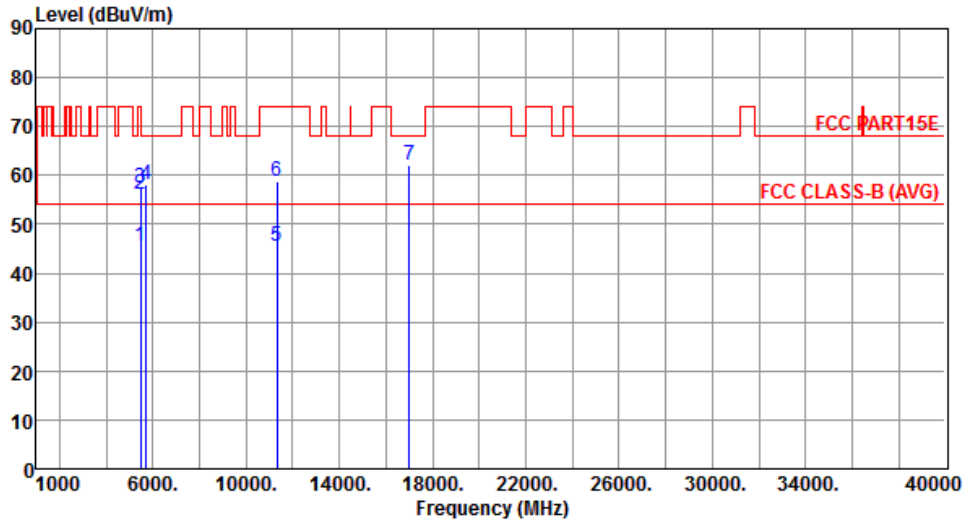

	Freq. MHz	Emission level dBuV/m	Limit dBuV/m	Margin dB	SA reading dBuV	Factor dB	Remark	ANT High cm	Turn Table deg
1	5460.00	45.54	54.00	-8.46	38.78	6.76	Average	156	15
2	5460.00	56.02	74.00	-17.98	49.26	6.76	Peak	156	15
3	5470.00	57.43	68.20	-10.77	50.66	6.77	Peak	156	15
4	5725.00	58.02	68.20	-10.18	50.78	7.24	Peak	156	15
5	11340.00	45.55	54.00	-8.45	28.70	16.85	Average	198	288
6	11340.00	58.82	74.00	-15.18	41.97	16.85	Peak	198	288
7	17010.00	62.25	68.20	-5.95	43.26	18.99	Peak	247	59

Note 1: Emission Level (dBuV/m) = SA Reading (dBuV/m) + Factor\* (dB)

\*Factor includes antenna factor , cable loss and amplifier gain

Note 2: Margin (dB) = Emission level (dBuV/m) – Limit (dBuV/m).

<b>Modulation</b>	HT40	<b>Test Freq. (MHz)</b>	5755
<b>Polarization</b>	Horizontal	<b>Test Configuration</b>	1

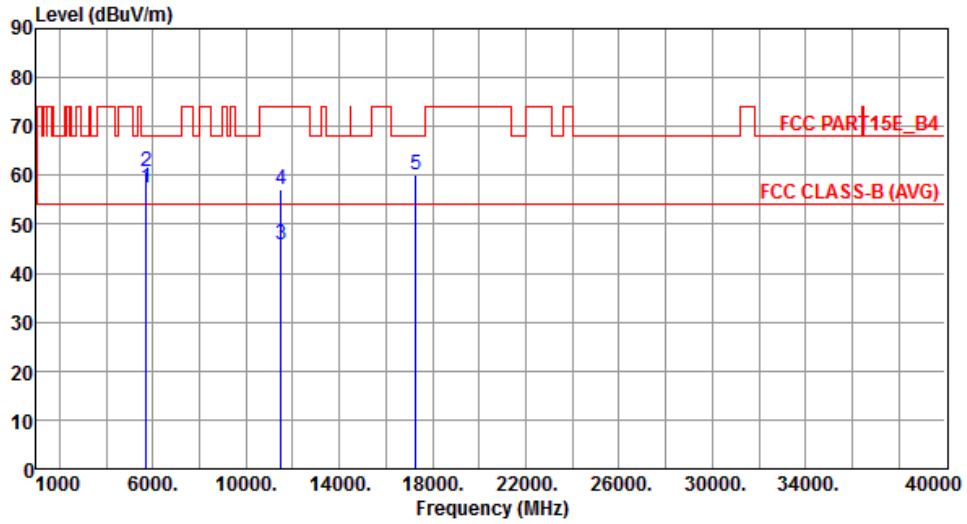

	Freq. MHz	Emission level dBuV/m	Limit dBuV/m	Margin dB	SA reading dBuV	Factor dB	Remark	ANT High cm	Turn Table deg
1	5715.00	57.57	68.20	-10.63	50.37	7.20	Peak	177	136
2	5725.00	60.90	78.20	-17.30	53.66	7.24	Peak	177	136
3	11510.00	45.80	54.00	-8.20	28.90	16.90	Average	297	271
4	11510.00	57.26	74.00	-16.74	40.36	16.90	Peak	297	271
5	17265.00	60.05	68.20	-8.15	40.69	19.36	Peak	307	271

Note 1: Emission Level (dBuV/m) = SA Reading (dBuV/m) + Factor\* (dB)

\*Factor includes antenna factor , cable loss and amplifier gain

Note 2: Margin (dB) = Emission level (dBuV/m) – Limit (dBuV/m).

<b>Modulation</b>	HT40	<b>Test Freq. (MHz)</b>	5755
<b>Polarization</b>	Vertical	<b>Test Configuration</b>	1

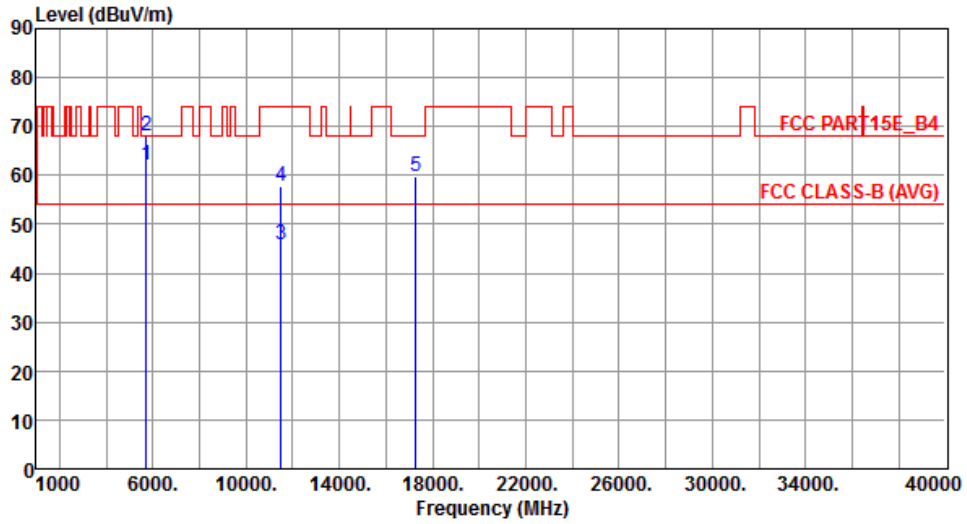

	Freq. MHz	Emission level dBuV/m	Limit dBuV/m	Margin dB	SA reading dBuV	Factor dB	Remark	ANT High cm	Turn Table deg
1	5715.00	62.00	68.20	-6.20	54.80	7.20	Peak	147	11
2	5725.00	67.97	78.20	-10.23	60.73	7.24	Peak	147	11
3	11510.00	45.87	54.00	-8.13	28.97	16.90	Average	320	274
4	11510.00	57.87	74.00	-16.13	40.97	16.90	Peak	320	274
5	17265.00	59.72	68.20	-8.48	40.36	19.36	Peak	326	174

Note 1: Emission Level (dBuV/m) = SA Reading (dBuV/m) + Factor\* (dB)

\*Factor includes antenna factor , cable loss and amplifier gain

Note 2: Margin (dB) = Emission level (dBuV/m) – Limit (dBuV/m).

<b>Modulation</b>	HT40	<b>Test Freq. (MHz)</b>	5795
<b>Polarization</b>	Horizontal	<b>Test Configuration</b>	1

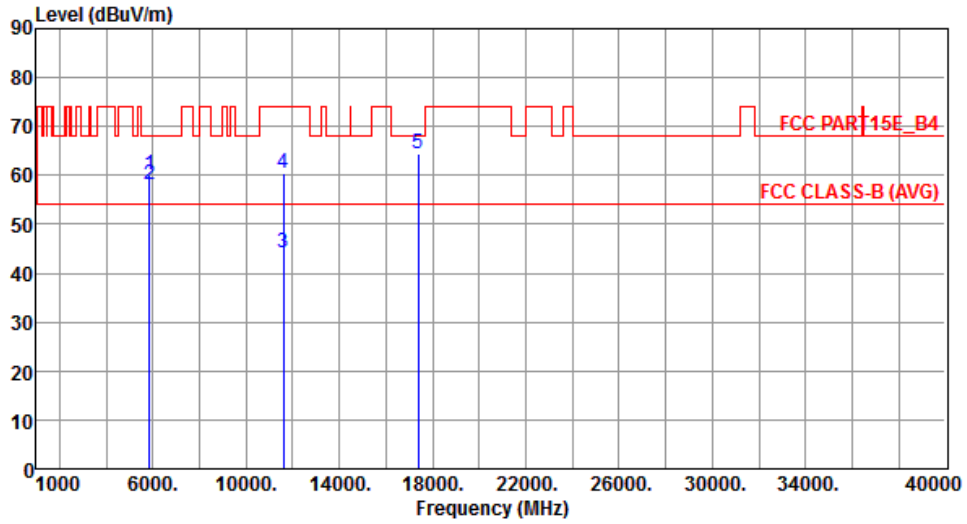

	Freq. MHz	Emission level dBuV/m	Limit dBuV/m	Margin dB	SA reading dBuV	Factor dB	Remark	ANT High cm	Turn Table deg
1	5850.00	60.14	78.20	-18.06	52.64	7.50	Peak	137	221
2	5860.00	58.19	68.20	-10.01	50.68	7.51	Peak	137	221
3	11590.00	44.06	54.00	-9.94	27.30	16.76	Average	277	275
4	11590.00	60.42	74.00	-13.58	43.66	16.76	Peak	277	275
5	17385.00	64.43	68.20	-3.77	44.89	19.54	Peak	145	352

Note 1: Emission Level (dBuV/m) = SA Reading (dBuV/m) + Factor\* (dB)

\*Factor includes antenna factor , cable loss and amplifier gain

Note 2: Margin (dB) = Emission level (dBuV/m) – Limit (dBuV/m).

<b>Modulation</b>	HT40	<b>Test Freq. (MHz)</b>	5795
<b>Polarization</b>	Vertical	<b>Test Configuration</b>	1

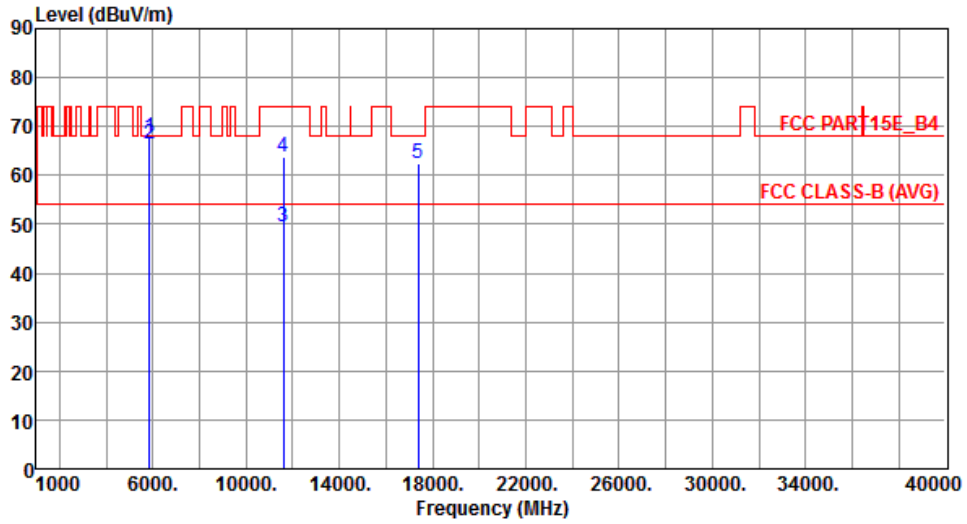

	Freq. MHz	Emission level dBuV/m	Limit dBuV/m	Margin dB	SA reading dBuV	Factor dB	Remark	ANT High cm	Turn Table deg
1	5850.00	67.89	78.20	-10.31	60.39	7.50	Peak	153	10
2	5860.00	66.30	68.20	-1.90	58.79	7.51	Peak	153	10
3	11590.00	49.36	54.00	-4.64	32.60	16.76	Average	278	6
4	11590.00	63.66	74.00	-10.34	46.90	16.76	Peak	278	6
5	17385.00	62.40	68.20	-5.80	42.86	19.54	Peak	132	0

Note 1: Emission Level (dBuV/m) = SA Reading (dBuV/m) + Factor\* (dB)

\*Factor includes antenna factor , cable loss and amplifier gain

Note 2: Margin (dB) = Emission level (dBuV/m) – Limit (dBuV/m).

## Test Configuration 2: PCB Dipole antenna

### 3.5.8 Transmitter Radiated Unwanted Emissions (Below 1GHz)

<b>Modulation</b>	HT40	<b>Test Freq. (MHz)</b>	5590
<b>Polarization</b>	Horizontal	<b>Test Configuration</b>	2

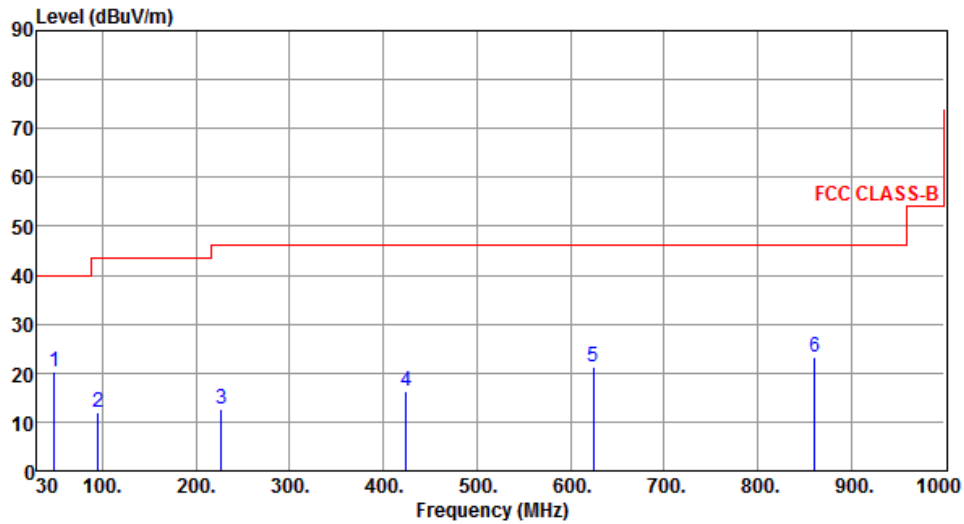

	Freq. MHz	Emission level dBuV/m	Limit dBuV/m	Margin dB	SA reading dBuV	Factor dB	Remark	ANT High cm	Turn Table deg
1	48.43	20.12	40.00	-19.88	33.03	-12.91	Peak	---	---
2	94.99	12.10	43.50	-31.40	31.10	-19.00	Peak	---	---
3	226.91	12.50	46.00	-33.50	28.06	-15.56	Peak	---	---
4	424.79	16.30	46.00	-29.70	25.71	-9.41	Peak	---	---
5	624.61	21.24	46.00	-24.76	26.68	-5.44	Peak	---	---
6	861.29	23.28	46.00	-22.72	24.84	-1.56	Peak	---	---

Note 1: Emission Level (dBuV/m) = SA Reading (dBuV/m) + Factor\* (dB)

\*Factor includes antenna factor, cable loss and amplifier gain

Note 2: Margin (dB) = Emission level (dBuV/m) – Limit (dBuV/m).

Note 3: All spurious emissions below 30MHz are more than 20 dB below the limit.



<b>Modulation</b>	HT40	<b>Test Freq. (MHz)</b>	5590
<b>Polarization</b>	Vertical	<b>Test Configuration</b>	2

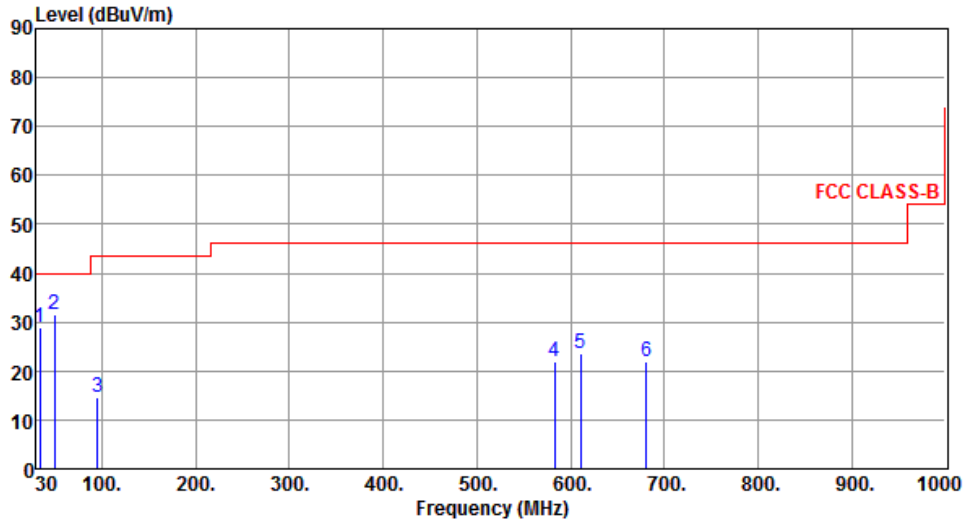

	Freq. MHz	Emission level dBuV/m	Limit dBuV/m	Margin dB	SA reading dBuV	Factor dB	Remark	ANT High cm	Turn Table deg
1	33.88	28.84	40.00	-11.16	42.33	-13.49	Peak	---	---
2	49.40	31.63	40.00	-8.37	44.57	-12.94	Peak	---	---
3	94.99	14.62	43.50	-28.88	33.62	-19.00	Peak	---	---
4	582.90	21.94	46.00	-24.06	28.19	-6.25	Peak	---	---
5	611.03	23.70	46.00	-22.30	29.33	-5.63	Peak	---	---
6	680.87	21.76	46.00	-24.24	26.43	-4.67	Peak	---	---

Note 1: Emission Level (dBuV/m) = SA Reading (dBuV/m) + Factor\* (dB)

\*Factor includes antenna factor , cable loss and amplifier gain

Note 2: Margin (dB) = Emission level (dBuV/m) – Limit (dBuV/m).

Note 3: All spurious emissions below 30MHz are more than 20 dB below the limit.

<b>Modulation</b>	HT40	<b>Test Freq. (MHz)</b>	5795
<b>Polarization</b>	Horizontal	<b>Test Configuration</b>	2

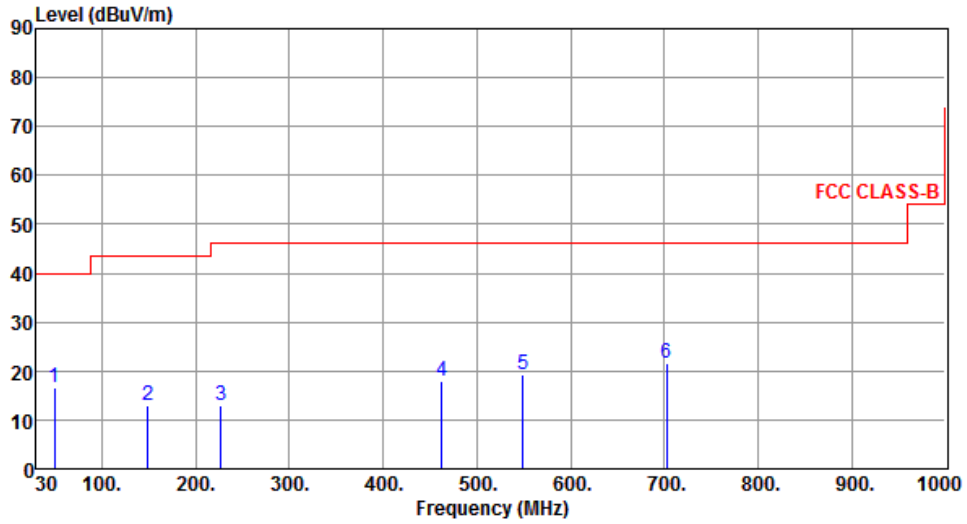

	Freq. MHz	Emission level dBuV/m	Limit dBuV/m	Margin dB	SA reading dBuV	Factor dB	Remark	ANT High cm	Turn Table deg
1	49.40	16.56	40.00	-23.44	29.50	-12.94	Peak	---	---
2	149.31	12.91	43.50	-30.59	26.36	-13.45	Peak	---	---
3	226.91	12.91	46.00	-33.09	28.47	-15.56	Peak	---	---
4	462.62	17.83	46.00	-28.17	26.33	-8.50	Peak	---	---
5	548.95	19.22	46.00	-26.78	26.34	-7.12	Peak	---	---
6	702.21	21.45	46.00	-24.55	25.82	-4.37	Peak	---	---

Note 1: Emission Level (dBuV/m) = SA Reading (dBuV/m) + Factor\* (dB)

\*Factor includes antenna factor , cable loss and amplifier gain

Note 2: Margin (dB) = Emission level (dBuV/m) – Limit (dBuV/m).

Note 3: All spurious emissions below 30MHz are more than 20 dB below the limit.

<b>Modulation</b>	HT40	<b>Test Freq. (MHz)</b>	5795
<b>Polarization</b>	Vertical	<b>Test Configuration</b>	2

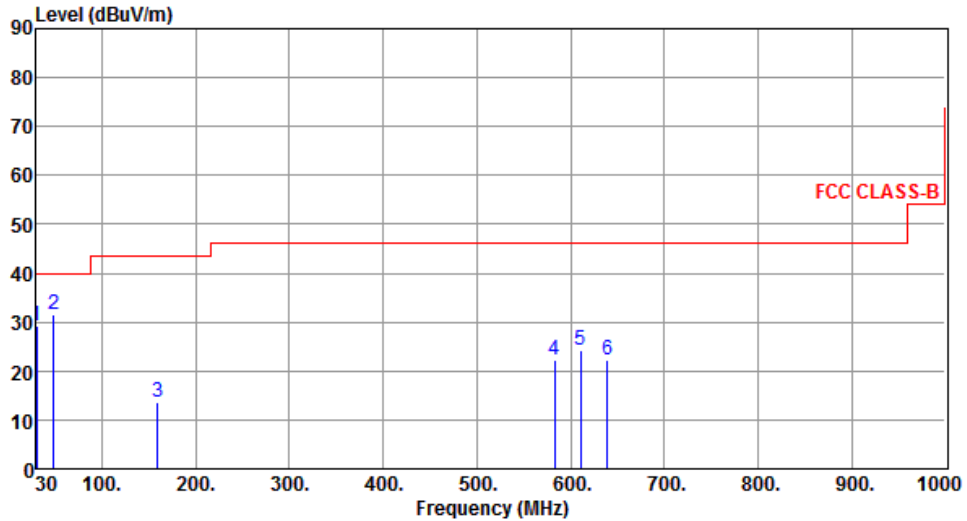

	Freq. MHz	Emission level dBuV/m	Limit dBuV/m	Margin dB	SA reading dBuV	Factor dB	Remark	ANT High cm	Turn Table deg
1	30.00	29.12	40.00	-10.88	42.63	-13.51	Peak	---	---
2	48.43	31.54	40.00	-8.46	44.45	-12.91	Peak	---	---
3	159.01	13.62	43.50	-29.88	27.22	-13.60	Peak	---	---
4	582.90	22.31	46.00	-23.69	28.56	-6.25	Peak	---	---
5	611.03	24.26	46.00	-21.74	29.89	-5.63	Peak	---	---
6	639.16	22.10	46.00	-23.90	27.33	-5.23	Peak	---	---

Note 1: Emission Level (dBuV/m) = SA Reading (dBuV/m) + Factor\* (dB)

\*Factor includes antenna factor , cable loss and amplifier gain

Note 2: Margin (dB) = Emission level (dBuV/m) – Limit (dBuV/m).

Note 3: All spurious emissions below 30MHz are more than 20 dB below the limit.

### 3.5.9 Transmitter Radiated Unwanted Emissions (Above 1GHz) for 11a

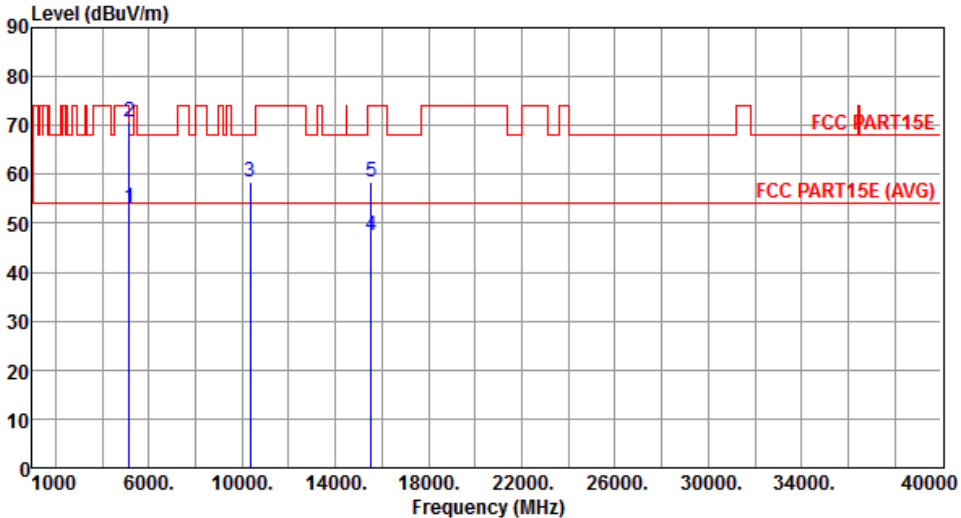
Modulation	11a	Test Freq. (MHz)	5180																																																																					
Polarization	Horizontal	Test Configuration	2																																																																					
																																																																								
	<table border="1"> <thead> <tr> <th>Freq.</th> <th>Emission level</th> <th>Limit</th> <th>Margin</th> <th>SA reading</th> <th>Factor</th> <th>Remark</th> <th>ANT High</th> <th>Turn Table</th> </tr> <tr> <th>MHz</th> <th>dBuV/m</th> <th>dBuV/m</th> <th>dB</th> <th>dBuV</th> <th>dB</th> <th></th> <th>cm</th> <th>deg</th> </tr> </thead> <tbody> <tr> <td>1</td> <td>5150.00</td> <td>53.13</td> <td>54.00</td> <td>-0.87</td> <td>46.82</td> <td>6.31</td> <td>Average</td> <td>150</td> <td>15</td> </tr> <tr> <td>2</td> <td>5150.00</td> <td>70.70</td> <td>74.00</td> <td>-3.30</td> <td>64.39</td> <td>6.31</td> <td>Peak</td> <td>150</td> <td>15</td> </tr> <tr> <td>3</td> <td>10360.00</td> <td>58.52</td> <td>68.20</td> <td>-9.68</td> <td>42.18</td> <td>16.34</td> <td>Peak</td> <td>301</td> <td>113</td> </tr> <tr> <td>4</td> <td>15540.00</td> <td>47.66</td> <td>54.00</td> <td>-6.34</td> <td>30.16</td> <td>17.50</td> <td>Average</td> <td>198</td> <td>224</td> </tr> <tr> <td>5</td> <td>15540.00</td> <td>58.52</td> <td>74.00</td> <td>-15.48</td> <td>41.02</td> <td>17.50</td> <td>Peak</td> <td>198</td> <td>224</td> </tr> </tbody> </table>	Freq.	Emission level	Limit	Margin	SA reading	Factor	Remark	ANT High	Turn Table	MHz	dBuV/m	dBuV/m	dB	dBuV	dB		cm	deg	1	5150.00	53.13	54.00	-0.87	46.82	6.31	Average	150	15	2	5150.00	70.70	74.00	-3.30	64.39	6.31	Peak	150	15	3	10360.00	58.52	68.20	-9.68	42.18	16.34	Peak	301	113	4	15540.00	47.66	54.00	-6.34	30.16	17.50	Average	198	224	5	15540.00	58.52	74.00	-15.48	41.02	17.50	Peak	198	224			
Freq.	Emission level	Limit	Margin	SA reading	Factor	Remark	ANT High	Turn Table																																																																
MHz	dBuV/m	dBuV/m	dB	dBuV	dB		cm	deg																																																																
1	5150.00	53.13	54.00	-0.87	46.82	6.31	Average	150	15																																																															
2	5150.00	70.70	74.00	-3.30	64.39	6.31	Peak	150	15																																																															
3	10360.00	58.52	68.20	-9.68	42.18	16.34	Peak	301	113																																																															
4	15540.00	47.66	54.00	-6.34	30.16	17.50	Average	198	224																																																															
5	15540.00	58.52	74.00	-15.48	41.02	17.50	Peak	198	224																																																															
<p>Note 1: Emission Level (dBuV/m) = SA Reading (dBuV/m) + Factor* (dB)            *Factor includes antenna factor , cable loss and amplifier gain            Note 2: Margin (dB) = Emission level (dBuV/m) – Limit (dBuV/m).</p>																																																																								

<b>Modulation</b>	11a	<b>Test Freq. (MHz)</b>	5180
<b>Polarization</b>	Vertical	<b>Test Configuration</b>	2

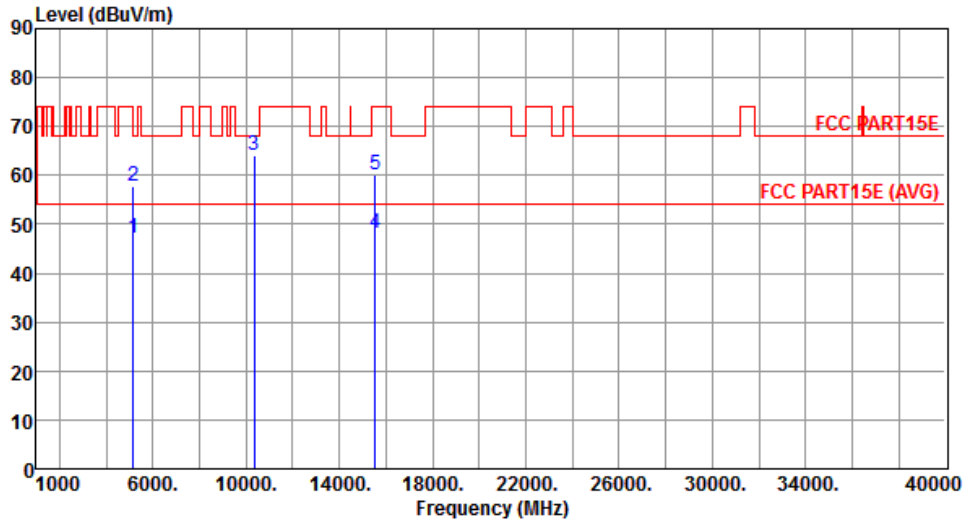

	Freq. MHz	Emission level dBuV/m	Limit dBuV/m	Margin dB	SA reading dBuV	Factor dB	Remark	ANT High cm	Turn Table deg
1	5150.00	47.08	54.00	-6.92	40.77	6.31	Average	150	145
2	5150.00	57.87	74.00	-16.13	51.56	6.31	Peak	150	145
3	10360.00	64.21	68.20	-3.99	47.87	16.34	Peak	385	179
4	15540.00	48.13	54.00	-5.87	30.63	17.50	Average	173	177
5	15540.00	60.24	74.00	-13.76	42.74	17.50	Peak	173	177

Note 1: Emission Level (dBuV/m) = SA Reading (dBuV/m) + Factor\* (dB)

\*Factor includes antenna factor , cable loss and amplifier gain

Note 2: Margin (dB) = Emission level (dBuV/m) – Limit (dBuV/m).

<b>Modulation</b>	11a	<b>Test Freq. (MHz)</b>	5200
<b>Polarization</b>	Horizontal	<b>Test Configuration</b>	2

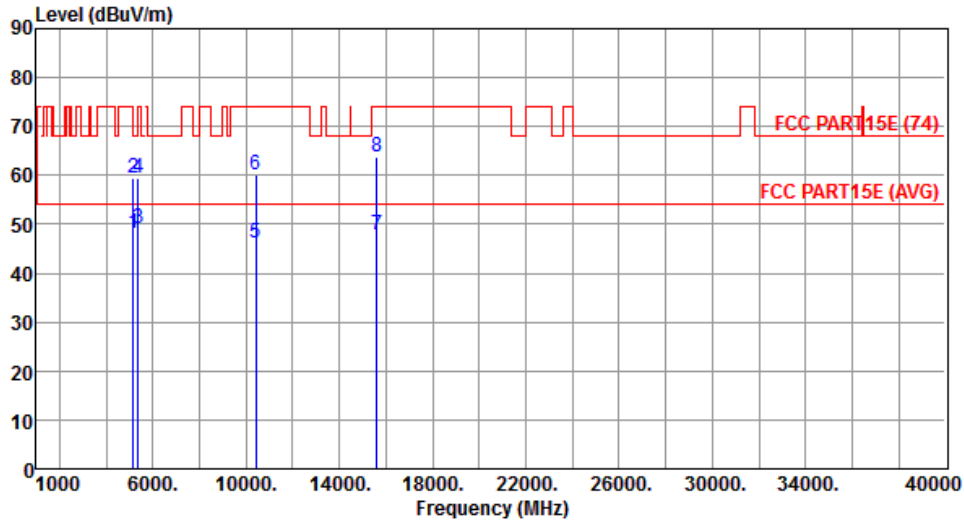

	Freq. MHz	Emission level dBUV/m	Limit dBUV/m	Margin dB	SA reading dBUV	Factor dB	Remark	ANT High cm	Turn Table deg
1	5150.00	48.03	54.00	-5.97	41.72	6.31	Average	152	349
2	5150.00	59.45	74.00	-14.55	53.14	6.31	Peak	152	349
3	5350.00	49.16	54.00	-4.84	42.54	6.62	Average	152	349
4	5350.00	59.58	74.00	-14.42	52.96	6.62	Peak	152	349
5	10400.00	46.22	54.00	-7.78	29.80	16.42	Average	216	89
6	10400.00	60.12	74.00	-13.88	43.70	16.42	Peak	216	89
7	15600.00	47.92	54.00	-6.08	30.54	17.38	Average	229	150
8	15600.00	63.65	74.00	-10.35	46.27	17.38	Peak	229	150

Note 1: Emission Level (dBUV/m) = SA Reading (dBUV/m) + Factor\* (dB)

\*Factor includes antenna factor , cable loss and amplifier gain

Note 2: Margin (dB) = Emission level (dBUV/m) – Limit (dBUV/m).

<b>Modulation</b>	11a	<b>Test Freq. (MHz)</b>	5200
<b>Polarization</b>	Vertical	<b>Test Configuration</b>	2

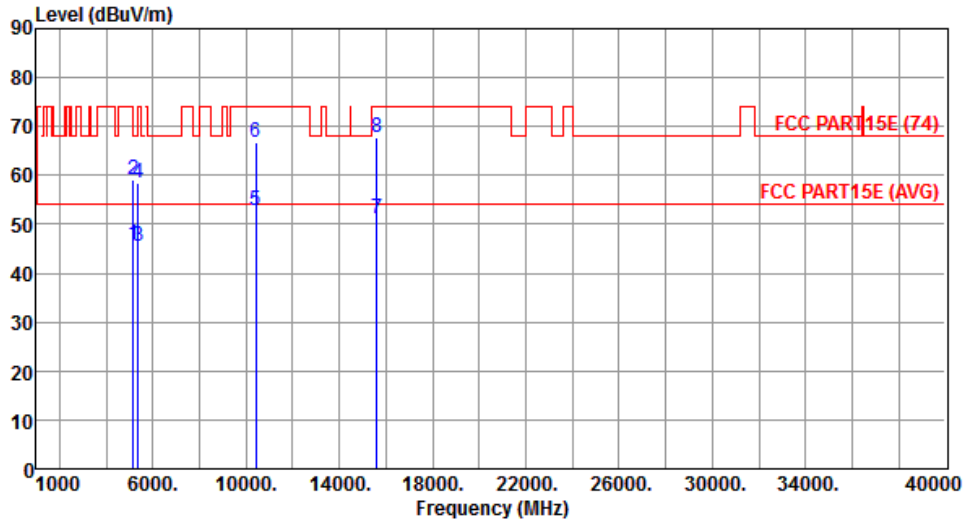

	Freq. MHz	Emission level dBuV/m	Limit dBuV/m	Margin dB	SA reading dBuV	Factor dB	Remark	ANT High cm	Turn Table deg
1	5150.00	45.76	54.00	-8.24	39.45	6.31	Average	210	72
2	5150.00	59.21	74.00	-14.79	52.90	6.31	Peak	210	72
3	5350.00	45.59	54.00	-8.41	38.97	6.62	Average	210	72
4	5350.00	58.43	74.00	-15.57	51.81	6.62	Peak	210	72
5	10400.00	52.81	54.00	-1.19	36.39	16.42	Average	261	89
6	10400.00	66.64	74.00	-7.36	50.22	16.42	Peak	261	89
7	15600.00	51.25	54.00	-2.75	33.87	17.38	Average	109	89
8	15600.00	67.91	74.00	-6.09	50.53	17.38	Peak	109	89

Note 1: Emission Level (dBuV/m) = SA Reading (dBuV/m) + Factor\* (dB)

\*Factor includes antenna factor , cable loss and amplifier gain

Note 2: Margin (dB) = Emission level (dBuV/m) – Limit (dBuV/m).

<b>Modulation</b>	11a	<b>Test Freq. (MHz)</b>	5240
<b>Polarization</b>	Horizontal	<b>Test Configuration</b>	2

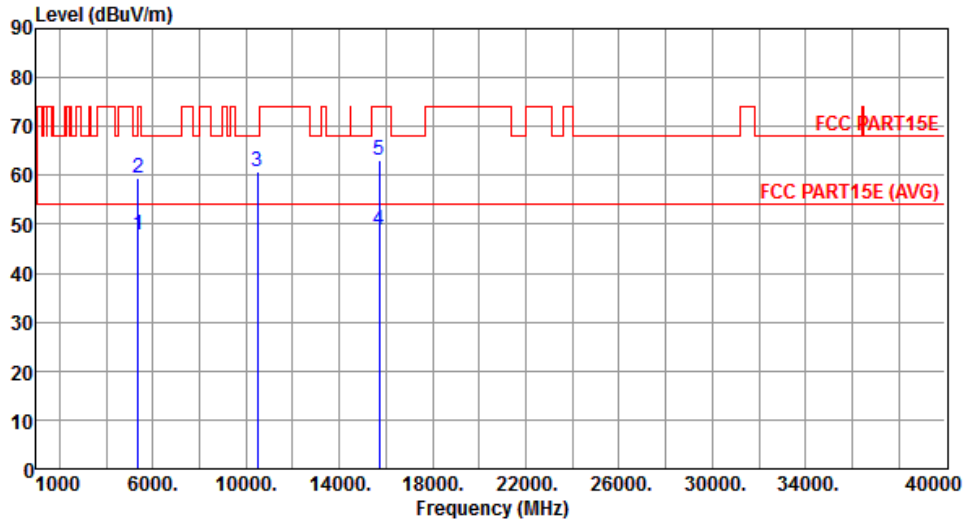

	Freq. MHz	Emission level dBuV/m	Limit dBuV/m	Margin dB	SA reading dBuV	Factor dB	Remark	ANT High cm	Turn Table deg
1	5350.00	47.68	54.00	-6.32	41.06	6.62	Average	150	344
2	5350.00	59.45	74.00	-14.55	52.83	6.62	Peak	150	344
3	10480.00	60.63	68.20	-7.57	44.07	16.56	Peak	320	118
4	15720.00	48.78	54.00	-5.22	31.63	17.15	Average	150	344
5	15720.00	63.24	74.00	-10.76	46.09	17.15	Peak	150	344

Note 1: Emission Level (dBuV/m) = SA Reading (dBuV/m) + Factor\* (dB)

\*Factor includes antenna factor , cable loss and amplifier gain

Note 2: Margin (dB) = Emission level (dBuV/m) – Limit (dBuV/m).



<b>Modulation</b>	11a	<b>Test Freq. (MHz)</b>	5240
<b>Polarization</b>	Vertical	<b>Test Configuration</b>	2

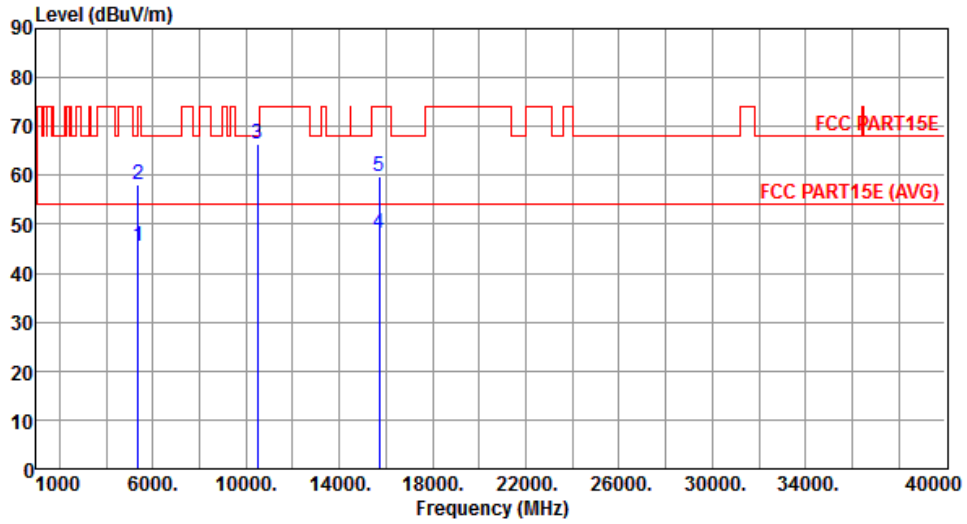

	Freq. MHz	Emission level dBuV/m	Limit dBuV/m	Margin dB	SA reading dBuV	Factor dB	Remark	ANT High cm	Turn Table deg
1	5350.00	45.44	54.00	-8.56	38.82	6.62	Average	200	85
2	5350.00	58.11	74.00	-15.89	51.49	6.62	Peak	200	85
3	10480.00	66.41	68.20	-1.79	49.85	16.56	Peak	364	183
4	15720.00	48.21	54.00	-5.79	31.06	17.15	Average	255	133
5	15720.00	59.85	74.00	-14.15	42.70	17.15	Peak	255	133

Note 1: Emission Level (dBuV/m) = SA Reading (dBuV/m) + Factor\* (dB)

\*Factor includes antenna factor , cable loss and amplifier gain

Note 2: Margin (dB) = Emission level (dBuV/m) – Limit (dBuV/m).

<b>Modulation</b>	11a	<b>Test Freq. (MHz)</b>	5260
<b>Polarization</b>	Horizontal	<b>Test Configuration</b>	2

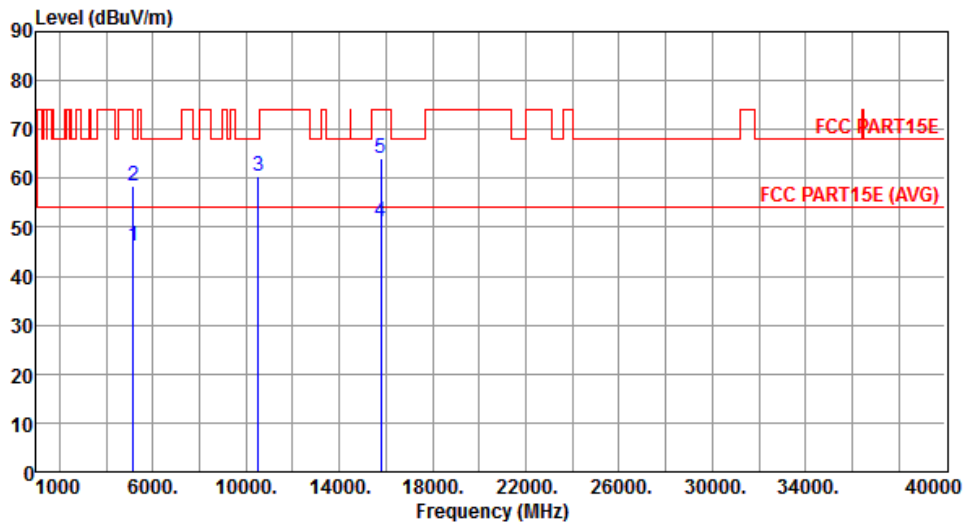

	Freq. MHz	Emission level dBuV/m	Limit dBuV/m	Margin dB	SA reading dBuV	Factor dB	Remark	ANT High cm	Turn Table deg
1	5150.00	46.17	54.00	-7.83	39.86	6.31	Average	150	2
2	5150.00	58.38	74.00	-15.62	52.07	6.31	Peak	150	2
3	10520.00	60.40	68.20	-7.80	43.80	16.60	Peak	225	190
4	15780.00	51.05	54.00	-2.95	34.00	17.05	Average	228	175
5	15780.00	64.18	74.00	-9.82	47.13	17.05	Peak	228	175

Note 1: Emission Level (dBuV/m) = SA Reading (dBuV/m) + Factor\* (dB)

\*Factor includes antenna factor , cable loss and amplifier gain

Note 2: Margin (dB) = Emission level (dBuV/m) – Limit (dBuV/m).

<b>Modulation</b>	11a	<b>Test Freq. (MHz)</b>	5260
<b>Polarization</b>	Vertical	<b>Test Configuration</b>	2

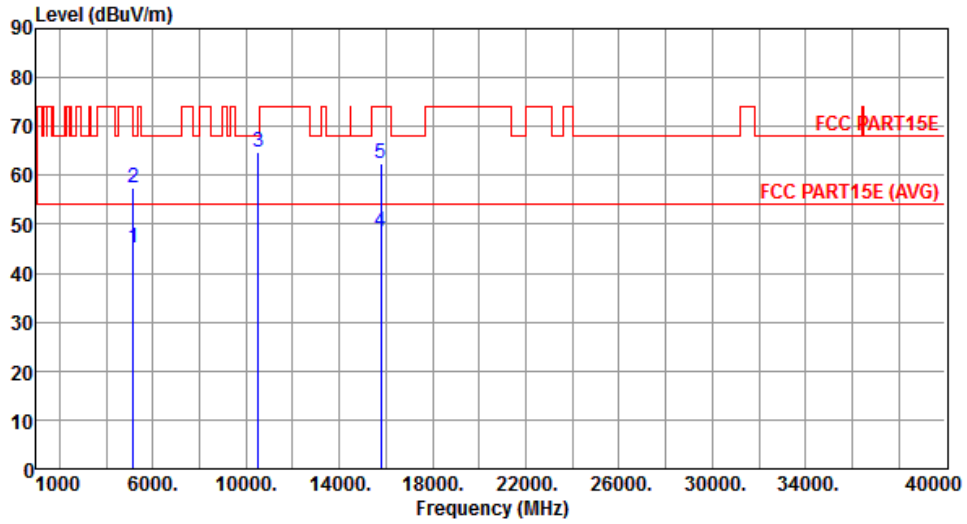

	Freq. MHz	Emission level dBuV/m	Limit dBuV/m	Margin dB	SA reading dBuV	Factor dB	Remark	ANT High cm	Turn Table deg
1	5150.00	45.03	54.00	-8.97	38.72	6.31	Average	157	200
2	5150.00	57.59	74.00	-16.41	51.28	6.31	Peak	157	200
3	10520.00	64.88	68.20	-3.32	48.28	16.60	Peak	382	178
4	15780.00	48.37	54.00	-5.63	31.32	17.05	Average	382	139
5	15780.00	62.49	74.00	-11.51	45.44	17.05	Peak	382	139

Note 1: Emission Level (dBuV/m) = SA Reading (dBuV/m) + Factor\* (dB)

\*Factor includes antenna factor , cable loss and amplifier gain

Note 2: Margin (dB) = Emission level (dBuV/m) – Limit (dBuV/m).

<b>Modulation</b>	11a	<b>Test Freq. (MHz)</b>	5300
<b>Polarization</b>	Horizontal	<b>Test Configuration</b>	2

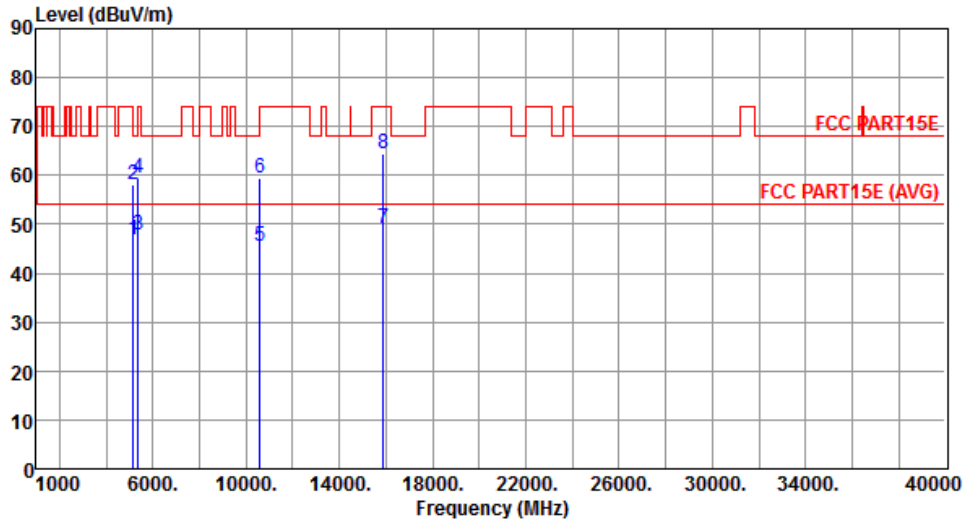

	Freq. MHz	Emission level dBuV/m	Limit dBuV/m	Margin dB	SA reading dBuV	Factor dB	Remark	ANT High cm	Turn Table deg
1	5150.00	46.97	54.00	-7.03	40.66	6.31	Average	173	350
2	5150.00	58.20	74.00	-15.80	51.89	6.31	Peak	173	350
3	5350.00	47.96	54.00	-6.04	41.34	6.62	Average	173	350
4	5350.00	59.30	74.00	-14.70	52.68	6.62	Peak	173	350
5	10600.00	45.62	54.00	-8.38	29.00	16.62	Average	296	92
6	10600.00	59.61	74.00	-14.39	42.99	16.62	Peak	296	92
7	15900.00	49.22	54.00	-4.78	32.40	16.82	Average	269	63
8	15900.00	64.43	74.00	-9.57	47.61	16.82	Peak	269	63

Note 1: Emission Level (dBuV/m) = SA Reading (dBuV/m) + Factor\* (dB)

\*Factor includes antenna factor , cable loss and amplifier gain

Note 2: Margin (dB) = Emission level (dBuV/m) – Limit (dBuV/m).

<b>Modulation</b>	11a	<b>Test Freq. (MHz)</b>	5300
<b>Polarization</b>	Vertical	<b>Test Configuration</b>	2

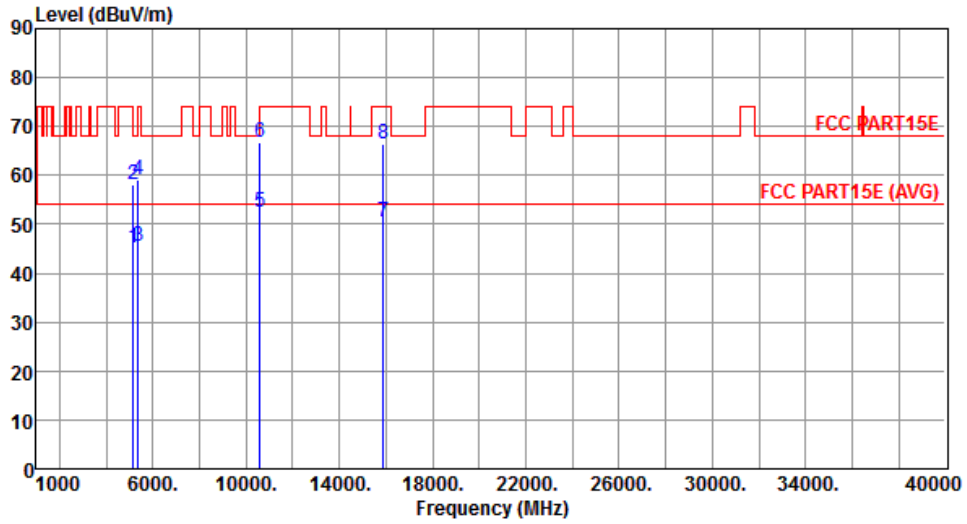

	Freq. MHz	Emission level dBuV/m	Limit dBuV/m	Margin dB	SA reading dBuV	Factor dB	Remark	ANT High cm	Turn Table deg
1	5150.00	45.10	54.00	-8.90	38.79	6.31	Average	157	88
2	5150.00	58.26	74.00	-15.74	51.95	6.31	Peak	157	88
3	5350.00	45.60	54.00	-8.40	38.98	6.62	Average	157	88
4	5350.00	58.98	74.00	-15.02	52.36	6.62	Peak	157	88
5	10600.00	52.53	54.00	-1.47	35.91	16.62	Average	316	82
6	10600.00	66.65	74.00	-7.35	50.03	16.62	Peak	316	82
7	15900.00	50.57	54.00	-3.43	33.75	16.82	Average	111	87
8	15900.00	66.34	74.00	-7.66	49.52	16.82	Peak	111	87

Note 1: Emission Level (dBuV/m) = SA Reading (dBuV/m) + Factor\* (dB)

\*Factor includes antenna factor , cable loss and amplifier gain

Note 2: Margin (dB) = Emission level (dBuV/m) – Limit (dBuV/m).

<b>Modulation</b>	11a	<b>Test Freq. (MHz)</b>	5320
<b>Polarization</b>	Horizontal	<b>Test Configuration</b>	2

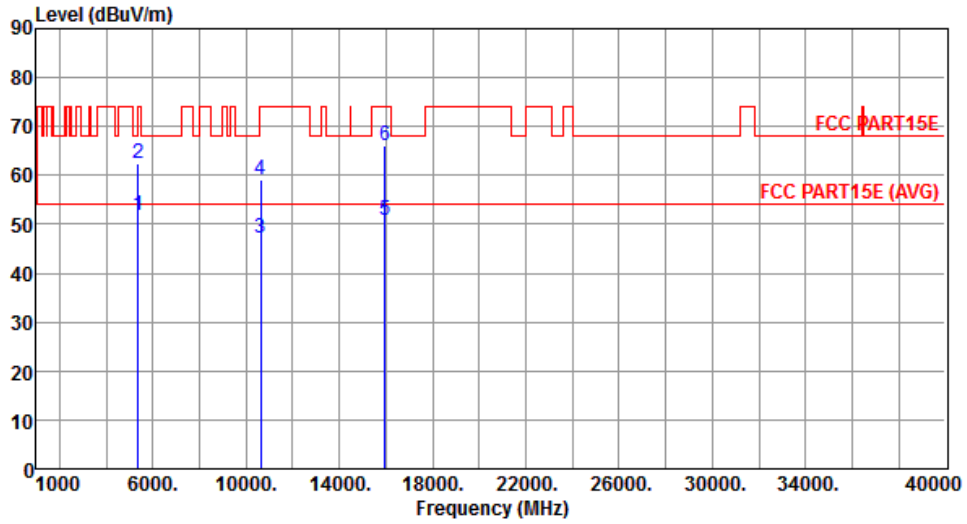

	Freq. MHz	Emission level dBuV/m	Limit dBuV/m	Margin dB	SA reading dBuV	Factor dB	Remark	ANT High cm	Turn Table deg
1	5350.00	51.86	54.00	-2.14	45.24	6.62	Average	153	352
2	5350.00	62.57	74.00	-11.43	55.95	6.62	Peak	153	352
3	10640.00	47.09	54.00	-6.91	30.46	16.63	Average	310	110
4	10640.00	59.16	74.00	-14.84	42.53	16.63	Peak	310	110
5	15960.00	50.85	54.00	-3.15	34.15	16.70	Average	254	174
6	15960.00	66.06	74.00	-7.94	49.36	16.70	Peak	254	174

Note 1: Emission Level (dBuV/m) = SA Reading (dBuV/m) + Factor\* (dB)

\*Factor includes antenna factor , cable loss and amplifier gain

Note 2: Margin (dB) = Emission level (dBuV/m) – Limit (dBuV/m).

<b>Modulation</b>	11a	<b>Test Freq. (MHz)</b>	5320
<b>Polarization</b>	Vertical	<b>Test Configuration</b>	2

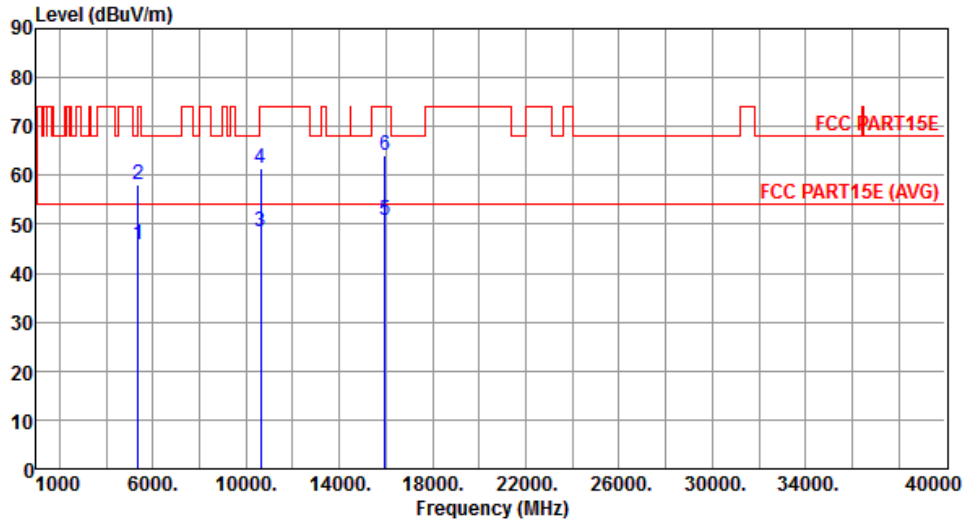

	Freq. MHz	Emission level dBuV/m	Limit dBuV/m	Margin dB	SA reading dBuV	Factor dB	Remark	ANT High cm	Turn Table deg
1	5350.00	45.68	54.00	-8.32	39.06	6.62	Average	152	200
2	5350.00	58.10	74.00	-15.90	51.48	6.62	Peak	152	200
3	10640.00	48.49	54.00	-5.51	31.86	16.63	Average	150	160
4	10640.00	61.41	74.00	-12.59	44.78	16.63	Peak	150	160
5	15960.00	50.95	54.00	-3.05	34.25	16.70	Average	150	185
6	15960.00	64.08	74.00	-9.92	47.38	16.70	Peak	150	185

Note 1: Emission Level (dBuV/m) = SA Reading (dBuV/m) + Factor\* (dB)

\*Factor includes antenna factor , cable loss and amplifier gain

Note 2: Margin (dB) = Emission level (dBuV/m) – Limit (dBuV/m).

<b>Modulation</b>	11a	<b>Test Freq. (MHz)</b>	5500
<b>Polarization</b>	Horizontal	<b>Test Configuration</b>	2

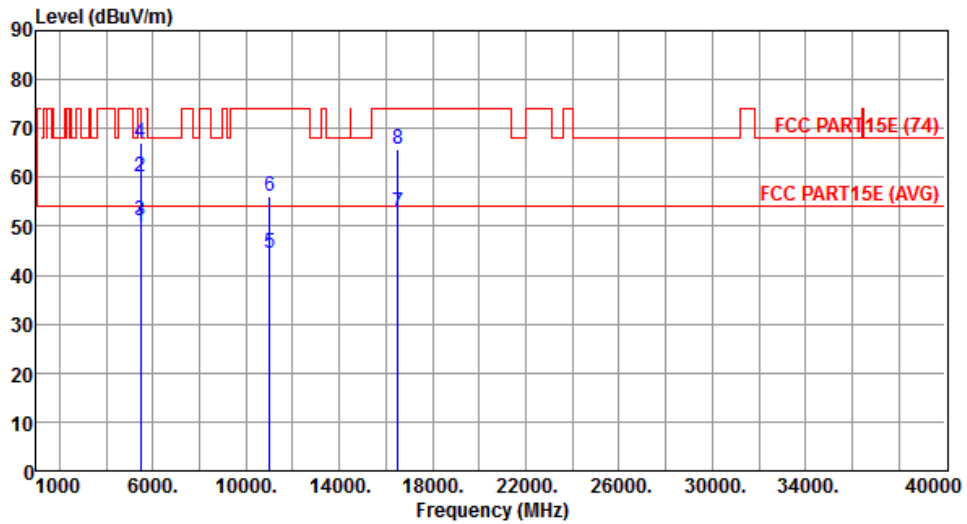

	Freq. MHz	Emission level dBuV/m	Limit dBuV/m	Margin dB	SA reading dBuV	Factor dB	Remark	ANT High cm	Turn Table deg
1	5460.00	49.68	54.00	-4.32	42.92	6.76	Average	150	3
2	5460.00	60.25	74.00	-13.75	53.49	6.76	Peak	150	3
3	5470.00	51.13	54.00	-2.87	44.36	6.77	Average	150	3
4	5470.00	67.15	74.00	-6.85	60.38	6.77	Peak	150	3
5	11000.00	44.65	54.00	-9.35	27.93	16.72	Average	173	267
6	11000.00	56.11	74.00	-17.89	39.39	16.72	Peak	173	267
7	16500.00	52.84	54.00	-1.16	34.97	17.87	Average	176	117
8	16500.00	65.68	74.00	-8.32	47.81	17.87	Peak	176	117

Note 1: Emission Level (dBuV/m) = SA Reading (dBuV/m) + Factor\* (dB)

\*Factor includes antenna factor , cable loss and amplifier gain

Note 2: Margin (dB) = Emission level (dBuV/m) – Limit (dBuV/m).



<b>Modulation</b>	11a	<b>Test Freq. (MHz)</b>	5500
<b>Polarization</b>	Vertical	<b>Test Configuration</b>	2

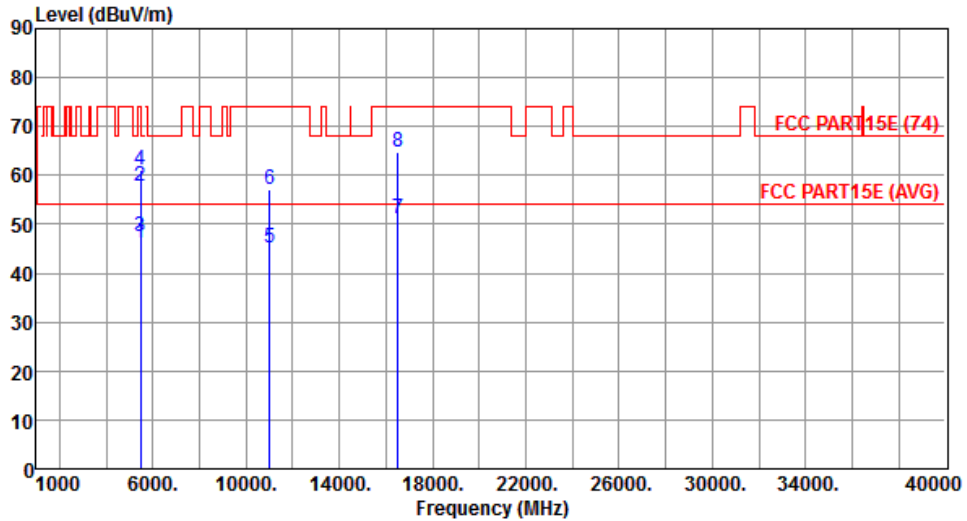

	Freq. MHz	Emission level dBuV/m	Limit dBuV/m	Margin dB	SA reading dBuV	Factor dB	Remark	ANT High cm	Turn Table deg
1	5460.00	46.30	54.00	-7.70	39.54	6.76	Average	365	63
2	5460.00	57.77	74.00	-16.23	51.01	6.76	Peak	365	63
3	5470.00	47.39	54.00	-6.61	40.62	6.77	Average	365	63
4	5470.00	61.14	74.00	-12.86	54.37	6.77	Peak	365	63
5	11000.00	45.08	54.00	-8.92	28.36	16.72	Average	271	69
6	11000.00	57.06	74.00	-16.94	40.34	16.72	Peak	271	69
7	16500.00	51.13	54.00	-2.87	33.26	17.87	Average	180	114
8	16500.00	64.65	74.00	-9.35	46.78	17.87	Peak	180	114

Note 1: Emission Level (dBuV/m) = SA Reading (dBuV/m) + Factor\* (dB)

\*Factor includes antenna factor , cable loss and amplifier gain

Note 2: Margin (dB) = Emission level (dBuV/m) – Limit (dBuV/m).

<b>Modulation</b>	11a	<b>Test Freq. (MHz)</b>	5580
<b>Polarization</b>	Horizontal	<b>Test Configuration</b>	2

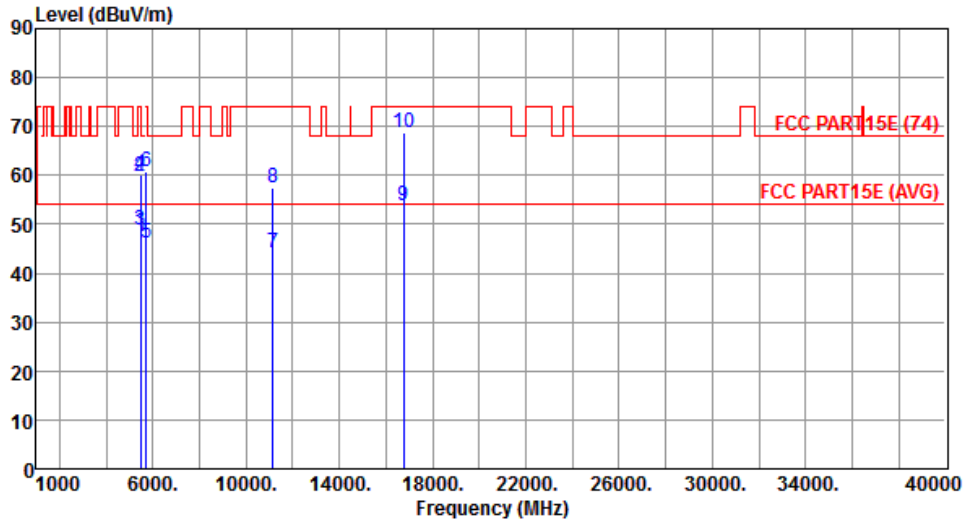

	Freq. MHz	Emission level dBuV/m	Limit dBuV/m	Margin dB	SA reading dBuV	Factor dB	Remark	ANT High cm	Turn Table deg
1	5460.00	48.38	54.00	-5.62	41.62	6.76	Average	288	87
2	5460.00	59.67	74.00	-14.33	52.91	6.76	Peak	288	87
3	5470.00	48.73	54.00	-5.27	41.96	6.77	Average	288	87
4	5470.00	60.10	74.00	-13.90	53.33	6.77	Peak	288	87
5	5725.00	46.09	54.00	-7.91	38.85	7.24	Average	250	186
6	5725.00	60.64	74.00	-13.36	53.40	7.24	Peak	250	186
7	11160.00	44.15	54.00	-9.85	27.36	16.79	Average	104	107
8	11160.00	57.43	74.00	-16.57	40.64	16.79	Peak	104	107
9	16740.00	53.68	54.00	-0.32	35.28	18.40	Average	288	87
10	16740.00	68.65	74.00	-5.35	50.25	18.40	Peak	288	87

Note 1: Emission Level (dBuV/m) = SA Reading (dBuV/m) + Factor\* (dB)

\*Factor includes antenna factor , cable loss and amplifier gain

Note 2: Margin (dB) = Emission level (dBuV/m) – Limit (dBuV/m).

<b>Modulation</b>	11a	<b>Test Freq. (MHz)</b>	5580
<b>Polarization</b>	Vertical	<b>Test Configuration</b>	2

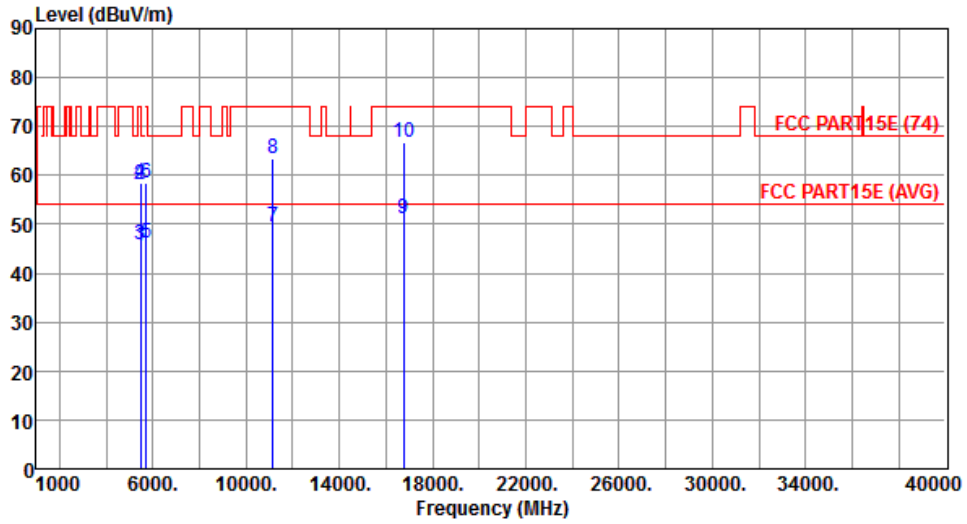

	Freq. MHz	Emission level dBuV/m	Limit dBuV/m	Margin dB	SA reading dBuV	Factor dB	Remark	ANT High cm	Turn Table deg
1	5460.00	45.61	54.00	-8.39	38.85	6.76	Average	353	56
2	5460.00	57.96	74.00	-16.04	51.20	6.76	Peak	353	56
3	5470.00	45.87	54.00	-8.13	39.10	6.77	Average	353	56
4	5470.00	58.31	74.00	-15.69	51.54	6.77	Peak	353	56
5	5725.00	46.05	54.00	-7.95	38.81	7.24	Average	353	56
6	5725.00	58.60	74.00	-15.40	51.36	7.24	Peak	353	56
7	11160.00	49.61	54.00	-4.39	32.82	16.79	Average	316	88
8	11160.00	63.46	74.00	-10.54	46.67	16.79	Peak	316	88
9	16740.00	51.16	54.00	-2.84	32.76	18.40	Average	105	105
10	16740.00	66.87	74.00	-7.13	48.47	18.40	Peak	105	105

Note 1: Emission Level (dBuV/m) = SA Reading (dBuV/m) + Factor\* (dB)

\*Factor includes antenna factor , cable loss and amplifier gain

Note 2: Margin (dB) = Emission level (dBuV/m) – Limit (dBuV/m).

<b>Modulation</b>	11a	<b>Test Freq. (MHz)</b>	5700
<b>Polarization</b>	Horizontal	<b>Test Configuration</b>	2

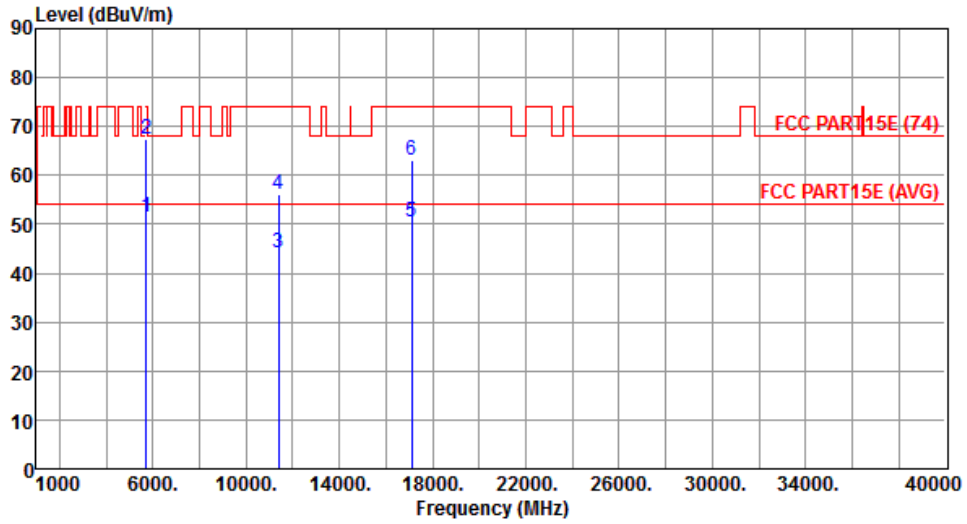

	Freq. MHz	Emission level dBuV/m	Limit dBuV/m	Margin dB	SA reading dBuV	Factor dB	Remark	ANT High cm	Turn Table deg
1	5725.00	51.39	54.00	-2.61	44.15	7.24	Average	236	192
2	5725.00	67.29	74.00	-6.71	60.05	7.24	Peak	236	192
3	11400.00	44.04	54.00	-9.96	27.16	16.88	Average	266	338
4	11400.00	56.01	74.00	-17.99	39.13	16.88	Peak	266	338
5	17100.00	50.58	54.00	-3.42	31.46	19.12	Average	228	180
6	17100.00	63.16	74.00	-10.84	44.04	19.12	Peak	228	180

Note 1: Emission Level (dBuV/m) = SA Reading (dBuV/m) + Factor\* (dB)

\*Factor includes antenna factor , cable loss and amplifier gain

Note 2: Margin (dB) = Emission level (dBuV/m) – Limit (dBuV/m).

<b>Modulation</b>	11a	<b>Test Freq. (MHz)</b>	5700
<b>Polarization</b>	Vertical	<b>Test Configuration</b>	2

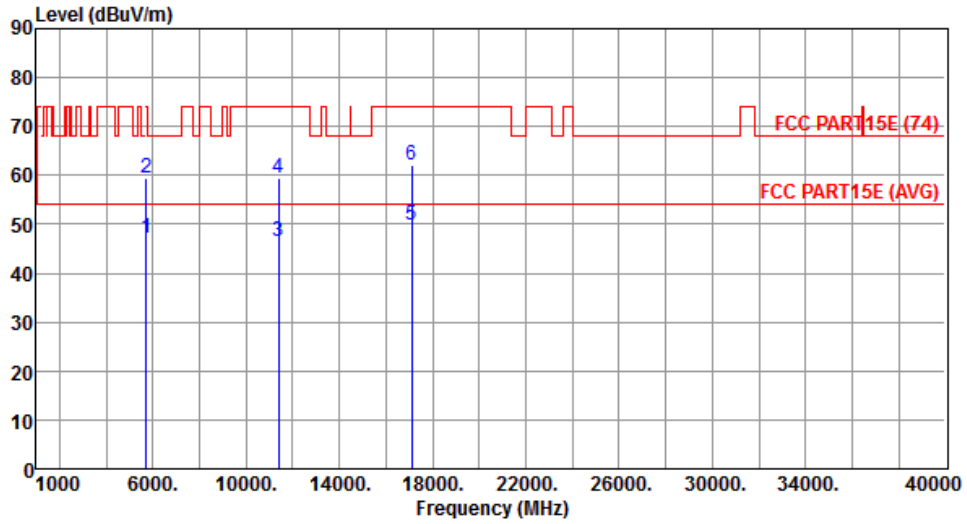

	Freq. MHz	Emission level dBuV/m	Limit dBuV/m	Margin dB	SA reading dBuV	Factor dB	Remark	ANT High cm	Turn Table deg
1	5725.00	47.23	54.00	-6.77	39.99	7.24	Average	343	92
2	5725.00	59.32	74.00	-14.68	52.08	7.24	Peak	343	92
3	11400.00	46.63	54.00	-7.37	29.75	16.88	Average	233	174
4	11400.00	59.60	74.00	-14.40	42.72	16.88	Peak	233	174
5	17100.00	49.77	54.00	-4.23	30.65	19.12	Average	208	122
6	17100.00	62.05	74.00	-11.95	42.93	19.12	Peak	208	122

Note 1: Emission Level (dBuV/m) = SA Reading (dBuV/m) + Factor\* (dB)

\*Factor includes antenna factor , cable loss and amplifier gain

Note 2: Margin (dB) = Emission level (dBuV/m) – Limit (dBuV/m).

<b>Modulation</b>	11a	<b>Test Freq. (MHz)</b>	5745
<b>Polarization</b>	Horizontal	<b>Test Configuration</b>	2

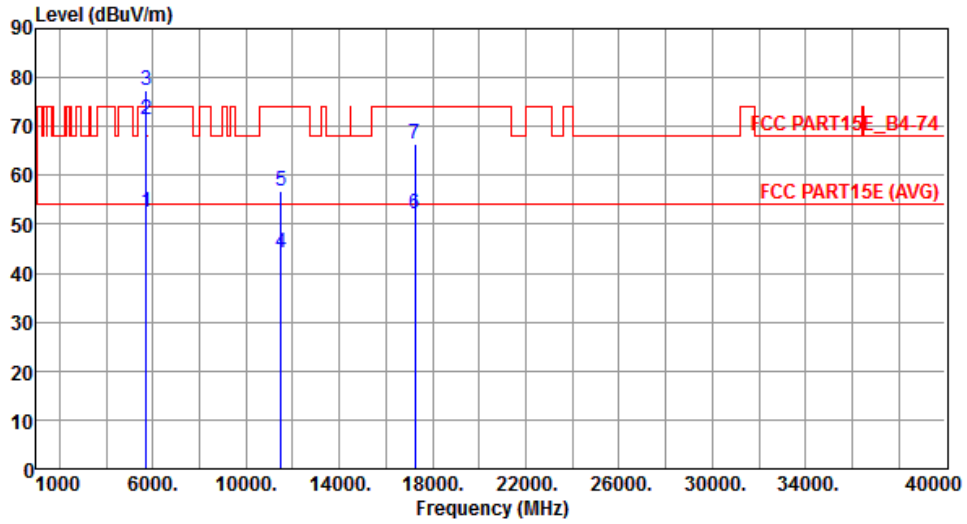

	Freq. MHz	Emission level dBuV/m	Limit dBuV/m	Margin dB	SA reading dBuV	Factor dB	Remark	ANT High cm	Turn Table deg
1	5715.00	52.53	54.00	-1.47	45.33	7.20	Average	212	199
2	5715.00	71.51	74.00	-2.49	64.31	7.20	Peak	212	199
3	5725.00	77.22	78.20	-0.98	69.98	7.24	Peak	212	199
4	11490.00	44.02	54.00	-9.98	27.11	16.91	Average	239	72
5	11490.00	56.90	74.00	-17.10	39.99	16.91	Peak	239	72
6	17235.00	52.06	54.00	-1.94	32.74	19.32	Average	180	128
7	17235.00	66.58	74.00	-7.42	47.26	19.32	Peak	180	128

Note 1: Emission Level (dBuV/m) = SA Reading (dBuV/m) + Factor\* (dB)

\*Factor includes antenna factor , cable loss and amplifier gain

Note 2: Margin (dB) = Emission level (dBuV/m) – Limit (dBuV/m).

<b>Modulation</b>	11a	<b>Test Freq. (MHz)</b>	5745
<b>Polarization</b>	Vertical	<b>Test Configuration</b>	2

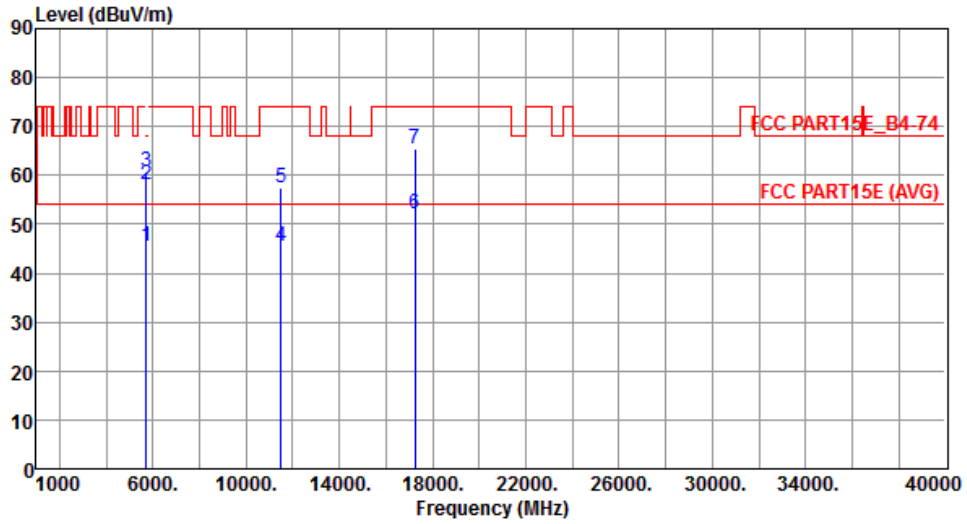

	Freq. MHz	Emission level dBuV/m	Limit dBuV/m	Margin dB	SA reading dBuV	Factor dB	Remark	ANT High cm	Turn Table deg
1	5715.00	45.61	54.00	-8.39	38.41	7.20	Average	271	194
2	5715.00	58.19	74.00	-15.81	50.99	7.20	Peak	271	194
3	5725.00	60.65	78.20	-17.55	53.41	7.24	Peak	271	194
4	11490.00	45.46	54.00	-8.54	28.55	16.91	Average	271	194
5	11490.00	57.50	74.00	-16.50	40.59	16.91	Peak	271	194
6	17235.00	52.14	54.00	-1.86	32.82	19.32	Average	181	127
7	17235.00	65.38	74.00	-8.62	46.06	19.32	Peak	181	127

Note 1: Emission Level (dBuV/m) = SA Reading (dBuV/m) + Factor\* (dB)

\*Factor includes antenna factor , cable loss and amplifier gain

Note 2: Margin (dB) = Emission level (dBuV/m) – Limit (dBuV/m).

<b>Modulation</b>	11a	<b>Test Freq. (MHz)</b>	5785
<b>Polarization</b>	Horizontal	<b>Test Configuration</b>	2

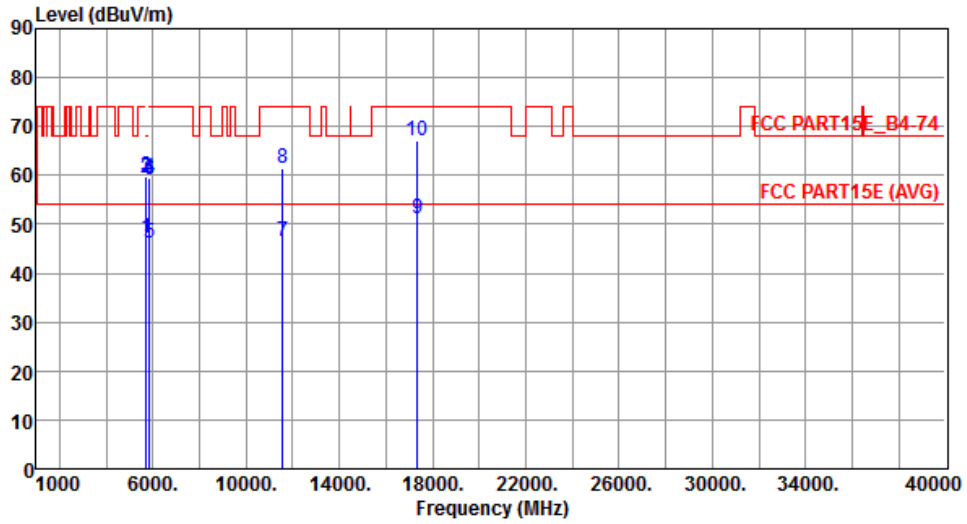

	Freq. MHz	Emission level dBuV/m	Limit dBuV/m	Margin dB	SA reading dBuV	Factor dB	Remark	ANT High cm	Turn Table deg
1	5715.00	47.16	54.00	-6.84	39.96	7.20	Average	169	337
2	5715.00	59.34	74.00	-14.66	52.14	7.20	Peak	169	337
3	5725.00	59.71	78.20	-18.49	52.47	7.24	Peak	169	337
4	5850.00	59.44	78.20	-18.76	51.94	7.50	Peak	169	337
5	5860.00	46.27	54.00	-7.73	38.76	7.51	Average	169	337
6	5860.00	59.13	74.00	-14.87	51.62	7.51	Peak	169	337
7	11570.00	46.47	54.00	-7.53	29.67	16.80	Average	338	55
8	11570.00	61.58	74.00	-12.42	44.78	16.80	Peak	338	55
9	17355.00	50.99	54.00	-3.01	31.50	19.49	Average	182	81
10	17355.00	66.96	74.00	-7.04	47.47	19.49	Peak	182	81

Note 1: Emission Level (dBuV/m) = SA Reading (dBuV/m) + Factor\* (dB)

\*Factor includes antenna factor , cable loss and amplifier gain

Note 2: Margin (dB) = Emission level (dBuV/m) – Limit (dBuV/m).



<b>Modulation</b>	11a	<b>Test Freq. (MHz)</b>	5785
<b>Polarization</b>	Vertical	<b>Test Configuration</b>	2

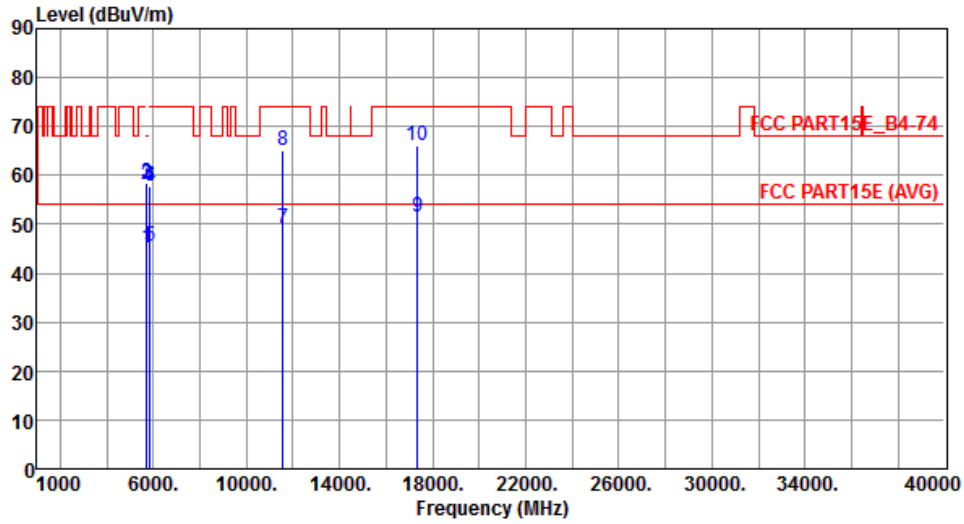

	Freq. MHz	Emission level dBuV/m	Limit dBuV/m	Margin dB	SA reading dBuV	Factor dB	Remark	ANT High cm	Turn Table deg
1	5715.00	45.32	54.00	-8.68	38.12	7.20	Average	353	67
2	5715.00	58.18	74.00	-15.82	50.98	7.20	Peak	353	67
3	5725.00	58.48	78.20	-19.72	51.24	7.24	Peak	353	67
4	5850.00	57.92	78.20	-20.28	50.42	7.50	Peak	353	67
5	5860.00	45.36	54.00	-8.64	37.85	7.51	Average	353	67
6	5860.00	57.72	74.00	-16.28	50.21	7.51	Peak	353	67
7	11570.00	49.28	54.00	-4.72	32.48	16.80	Average	333	63
8	11570.00	65.01	74.00	-8.99	48.21	16.80	Peak	333	63
9	17355.00	51.52	54.00	-2.48	32.03	19.49	Average	100	90
10	17355.00	66.06	74.00	-7.94	46.57	19.49	Peak	100	90

Note 1: Emission Level (dBuV/m) = SA Reading (dBuV/m) + Factor\* (dB)

\*Factor includes antenna factor , cable loss and amplifier gain

Note 2: Margin (dB) = Emission level (dBuV/m) – Limit (dBuV/m).

<b>Modulation</b>	11a	<b>Test Freq. (MHz)</b>	5825
<b>Polarization</b>	Horizontal	<b>Test Configuration</b>	2

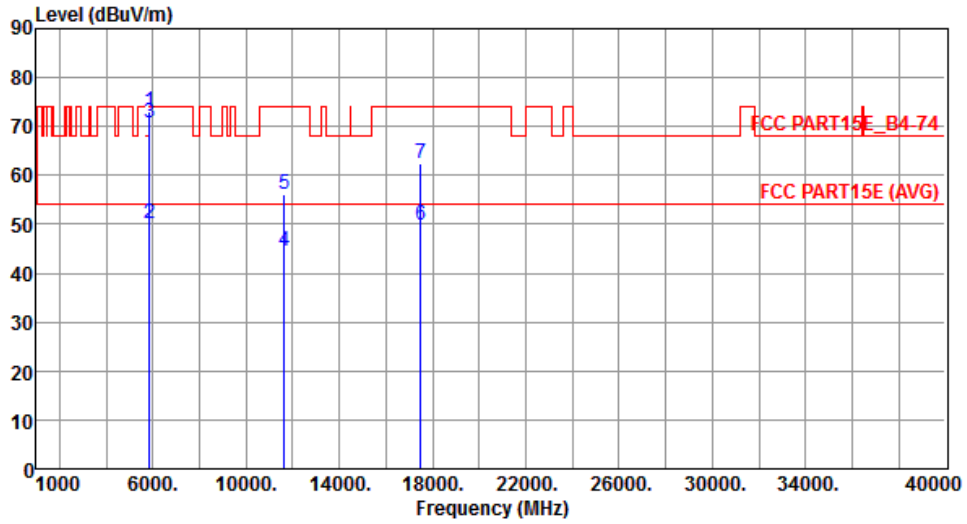

	Freq. MHz	Emission level dBuV/m	Limit dBuV/m	Margin dB	SA reading dBuV	Factor dB	Remark	ANT High cm	Turn Table deg
1	5850.00	73.03	78.20	-5.17	65.53	7.50	Peak	130	83
2	5860.00	50.08	54.00	-3.92	42.57	7.51	Average	130	83
3	5860.00	70.66	74.00	-3.34	63.15	7.51	Peak	130	83
4	11650.00	44.48	54.00	-9.52	27.83	16.65	Average	163	34
5	11650.00	55.99	74.00	-18.01	39.34	16.65	Peak	163	34
6	17475.00	49.79	54.00	-4.21	30.13	19.66	Average	191	145
7	17475.00	62.59	74.00	-11.41	42.93	19.66	Peak	191	145

Note 1: Emission Level (dBuV/m) = SA Reading (dBuV/m) + Factor\* (dB)

\*Factor includes antenna factor , cable loss and amplifier gain

Note 2: Margin (dB) = Emission level (dBuV/m) – Limit (dBuV/m).

<b>Modulation</b>	11a	<b>Test Freq. (MHz)</b>	5825
<b>Polarization</b>	Vertical	<b>Test Configuration</b>	2

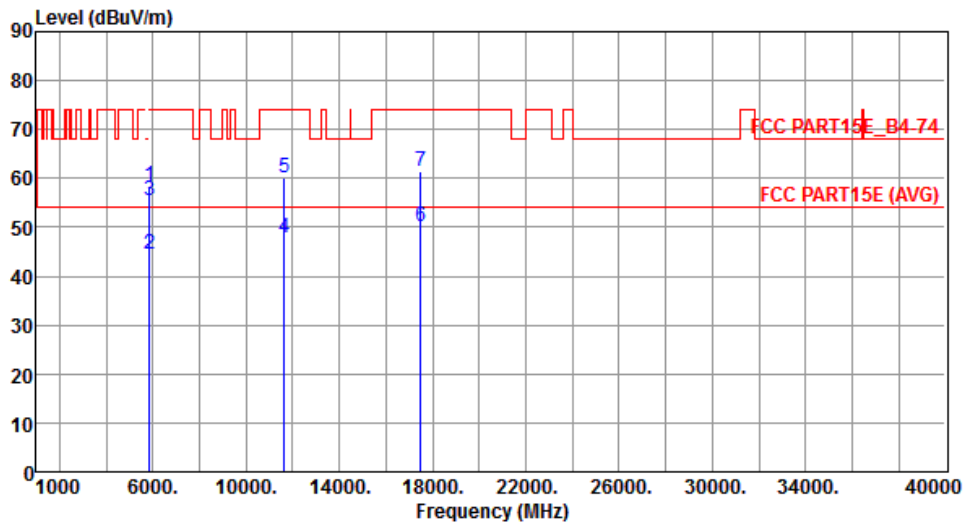

	Freq. MHz	Emission level dBuV/m	Limit dBuV/m	Margin dB	SA reading dBuV	Factor dB	Remark	ANT High cm	Turn Table deg
1	5850.00	58.43	78.20	-19.77	50.93	7.50	Peak	100	218
2	5860.00	44.51	54.00	-9.49	37.00	7.51	Average	100	218
3	5860.00	55.31	74.00	-18.69	47.80	7.51	Peak	100	218
4	11650.00	47.70	54.00	-6.30	31.05	16.65	Average	100	218
5	11650.00	59.99	74.00	-14.01	43.34	16.65	Peak	100	218
6	17475.00	50.24	54.00	-3.76	30.58	19.66	Average	239	141
7	17475.00	61.31	74.00	-12.69	41.65	19.66	Peak	239	141

Note 1: Emission Level (dBuV/m) = SA Reading (dBuV/m) + Factor\* (dB)

\*Factor includes antenna factor , cable loss and amplifier gain

Note 2: Margin (dB) = Emission level (dBuV/m) – Limit (dBuV/m).

### 3.5.10 Transmitter Radiated Unwanted Emissions (Above 1GHz) for HT20

<b>Modulation</b>	HT20	<b>Test Freq. (MHz)</b>	5180
<b>Polarization</b>	Horizontal	<b>Test Configuration</b>	2

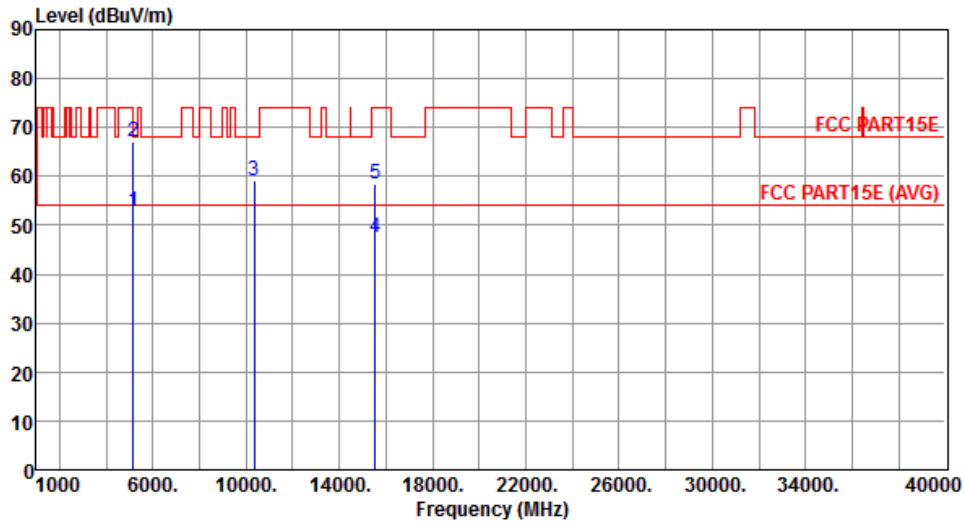

	Freq. MHz	Emission level dBuV/m	Limit dBuV/m	Margin dB	SA reading dBuV	Factor dB	Remark	ANT High cm	Turn Table deg
1	5150.00	52.89	54.00	-1.11	46.58	6.31	Average	185	348
2	5150.00	67.03	74.00	-6.97	60.72	6.31	Peak	185	348
3	10360.00	58.96	68.20	-9.24	42.62	16.34	Peak	300	115
4	15540.00	47.53	54.00	-6.47	30.03	17.50	Average	180	175
5	15540.00	58.51	74.00	-15.49	41.01	17.50	Peak	180	175

Note 1: Emission Level (dBuV/m) = SA Reading (dBuV/m) + Factor\* (dB)

\*Factor includes antenna factor , cable loss and amplifier gain

Note 2: Margin (dB) = Emission level (dBuV/m) – Limit (dBuV/m).

<b>Modulation</b>	HT20	<b>Test Freq. (MHz)</b>	5180
<b>Polarization</b>	Vertical	<b>Test Configuration</b>	2

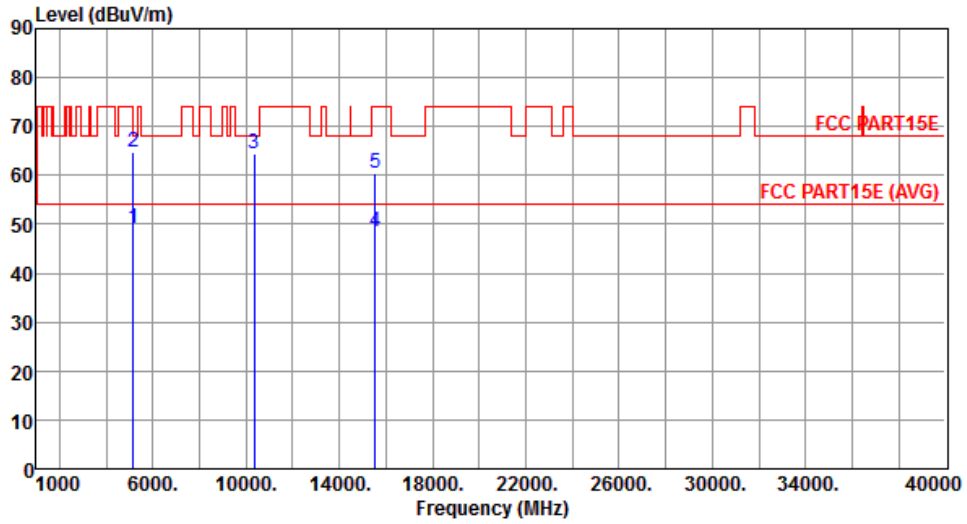

	Freq. MHz	Emission level dBuV/m	Limit dBuV/m	Margin dB	SA reading dBuV	Factor dB	Remark	ANT High cm	Turn Table deg
1	5150.00	49.20	54.00	-4.80	42.89	6.31	Average	184	91
2	5150.00	64.77	74.00	-9.23	58.46	6.31	Peak	184	91
3	10360.00	64.58	68.20	-3.62	48.24	16.34	Peak	188	151
4	15540.00	48.51	54.00	-5.49	31.01	17.50	Average	155	168
5	15540.00	60.51	74.00	-13.49	43.01	17.50	Peak	155	168

Note 1: Emission Level (dBuV/m) = SA Reading (dBuV/m) + Factor\* (dB)

\*Factor includes antenna factor , cable loss and amplifier gain

Note 2: Margin (dB) = Emission level (dBuV/m) – Limit (dBuV/m).

<b>Modulation</b>	HT20	<b>Test Freq. (MHz)</b>	5200
<b>Polarization</b>	Horizontal	<b>Test Configuration</b>	2

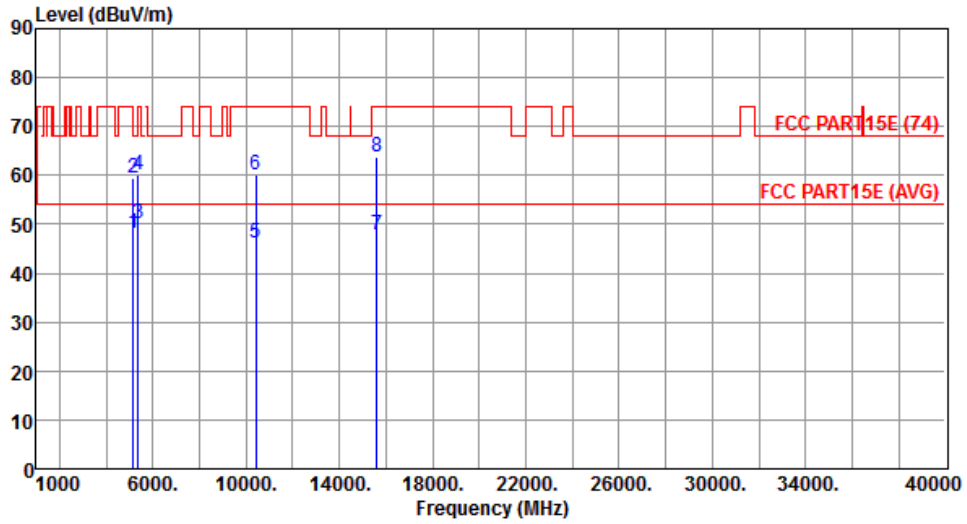

	Freq. MHz	Emission level dBuV/m	Limit dBuV/m	Margin dB	SA reading dBuV	Factor dB	Remark	ANT High cm	Turn Table deg
1	5150.00	48.16	54.00	-5.84	41.85	6.31	Average	150	351
2	5150.00	59.52	74.00	-14.48	53.21	6.31	Peak	150	351
3	5350.00	49.99	54.00	-4.01	43.37	6.62	Average	150	351
4	5350.00	59.95	74.00	-14.05	53.33	6.62	Peak	150	351
5	10400.00	46.07	54.00	-7.93	29.65	16.42	Average	251	68
6	10400.00	59.96	74.00	-14.04	43.54	16.42	Peak	251	68
7	15600.00	47.94	54.00	-6.06	30.56	17.38	Average	225	155
8	15600.00	63.85	74.00	-10.15	46.47	17.38	Peak	225	155

Note 1: Emission Level (dBuV/m) = SA Reading (dBuV/m) + Factor\* (dB)

\*Factor includes antenna factor , cable loss and amplifier gain

Note 2: Margin (dB) = Emission level (dBuV/m) – Limit (dBuV/m).

<b>Modulation</b>	HT20	<b>Test Freq. (MHz)</b>	5200
<b>Polarization</b>	Vertical	<b>Test Configuration</b>	2

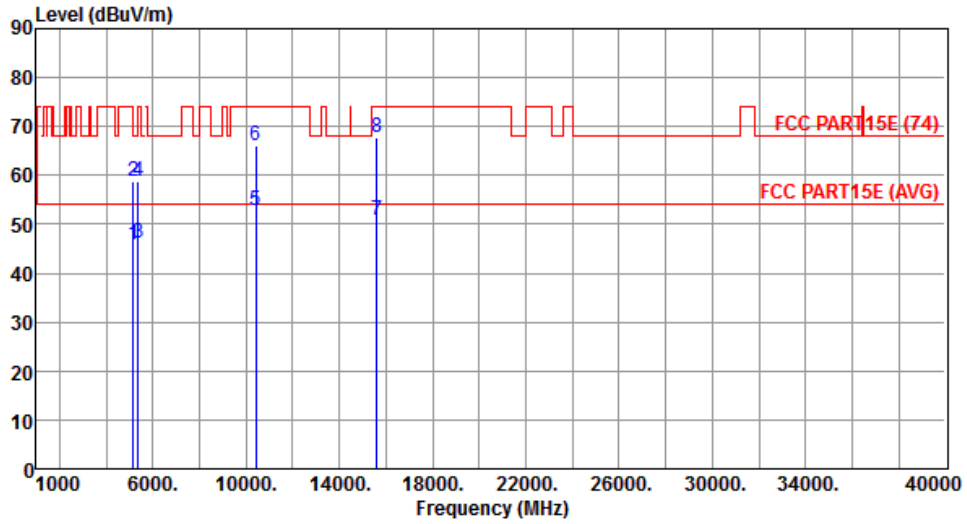

	Freq. MHz	Emission level dBuV/m	Limit dBuV/m	Margin dB	SA reading dBuV	Factor dB	Remark	ANT High cm	Turn Table deg
1	5150.00	45.93	54.00	-8.07	39.62	6.31	Average	200	85
2	5150.00	58.86	74.00	-15.14	52.55	6.31	Peak	200	85
3	5350.00	46.14	54.00	-7.86	39.52	6.62	Average	200	85
4	5350.00	58.90	74.00	-15.10	52.28	6.62	Peak	200	85
5	10400.00	52.86	54.00	-1.14	36.44	16.42	Average	242	96
6	10400.00	65.94	74.00	-8.06	49.52	16.42	Peak	242	96
7	15600.00	50.90	54.00	-3.10	33.52	17.38	Average	109	75
8	15600.00	67.85	74.00	-6.15	50.47	17.38	Peak	109	75

Note 1: Emission Level (dBuV/m) = SA Reading (dBuV/m) + Factor\* (dB)

\*Factor includes antenna factor , cable loss and amplifier gain

Note 2: Margin (dB) = Emission level (dBuV/m) – Limit (dBuV/m).

<b>Modulation</b>	HT20	<b>Test Freq. (MHz)</b>	5240
<b>Polarization</b>	Horizontal	<b>Test Configuration</b>	2

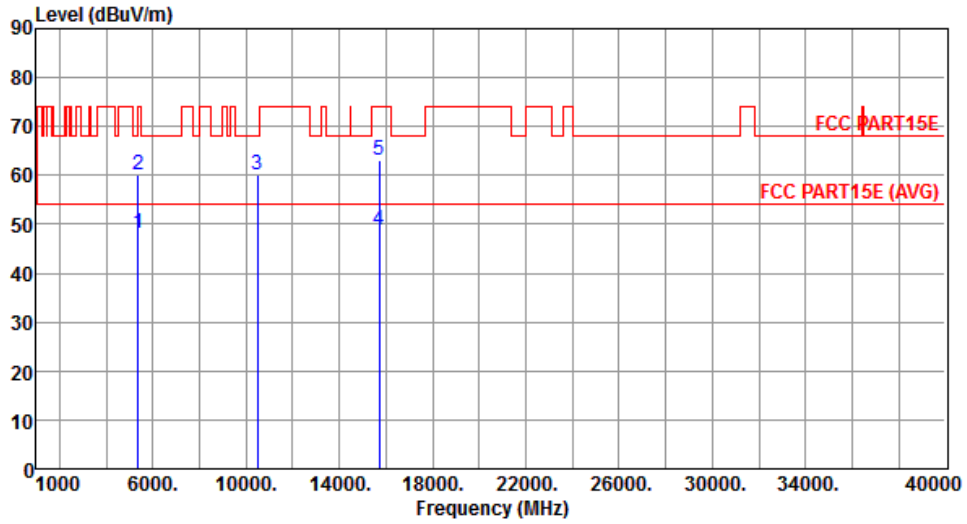

	Freq. MHz	Emission level dBuV/m	Limit dBuV/m	Margin dB	SA reading dBuV	Factor dB	Remark	ANT High cm	Turn Table deg
1	5350.00	48.28	54.00	-5.72	41.66	6.62	Average	148	352
2	5350.00	59.95	74.00	-14.05	53.33	6.62	Peak	148	352
3	10480.00	60.08	68.20	-8.12	43.52	16.56	Peak	318	115
4	15720.00	48.68	54.00	-5.32	31.53	17.15	Average	150	212
5	15720.00	63.02	74.00	-10.98	45.87	17.15	Peak	150	212

Note 1: Emission Level (dBuV/m) = SA Reading (dBuV/m) + Factor\* (dB)

\*Factor includes antenna factor , cable loss and amplifier gain

Note 2: Margin (dB) = Emission level (dBuV/m) – Limit (dBuV/m).



<b>Modulation</b>	HT20	<b>Test Freq. (MHz)</b>	5240
<b>Polarization</b>	Vertical	<b>Test Configuration</b>	2

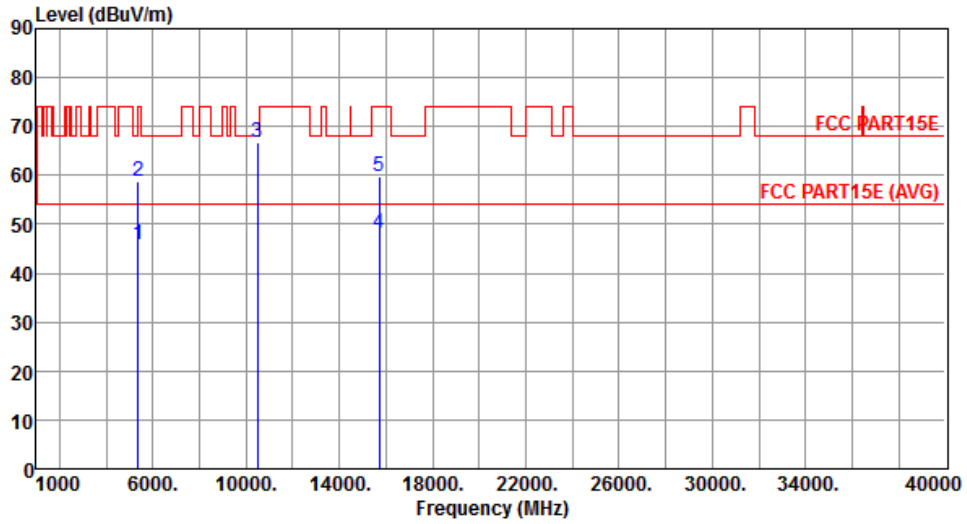

	Freq. MHz	Emission level dBuV/m	Limit dBuV/m	Margin dB	SA reading dBuV	Factor dB	Remark	ANT High cm	Turn Table deg
1	5350.00	45.74	54.00	-8.26	39.12	6.62	Average	188	80
2	5350.00	58.83	74.00	-15.17	52.21	6.62	Peak	188	80
3	10480.00	66.76	68.20	-1.44	50.20	16.56	Peak	360	185
4	15720.00	48.22	54.00	-5.78	31.07	17.15	Average	255	145
5	15720.00	59.69	74.00	-14.31	42.54	17.15	Peak	255	145

Note 1: Emission Level (dBuV/m) = SA Reading (dBuV/m) + Factor\* (dB)

\*Factor includes antenna factor , cable loss and amplifier gain

Note 2: Margin (dB) = Emission level (dBuV/m) – Limit (dBuV/m).

<b>Modulation</b>	HT20	<b>Test Freq. (MHz)</b>	5260
<b>Polarization</b>	Horizontal	<b>Test Configuration</b>	2

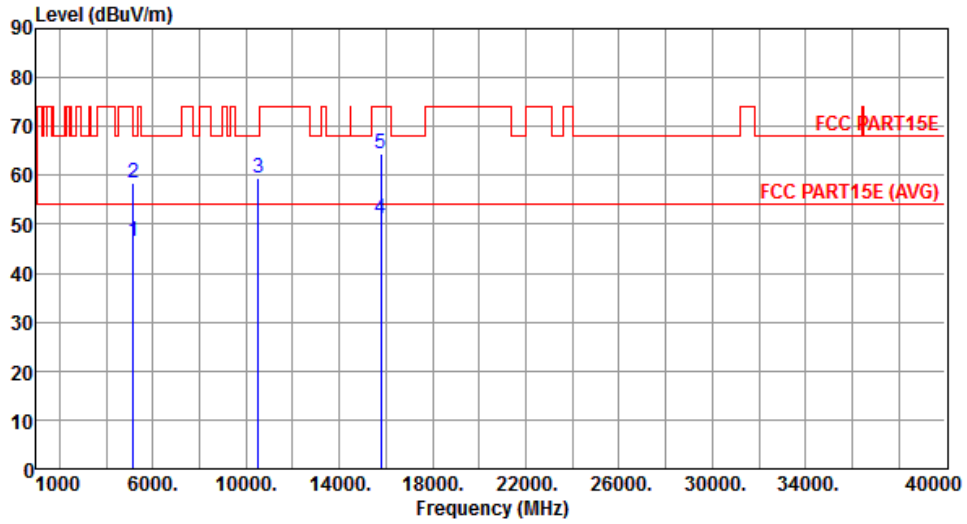

	Freq. MHz	Emission level dBuV/m	Limit dBuV/m	Margin dB	SA reading dBuV	Factor dB	Remark	ANT High cm	Turn Table deg
1	5150.00	46.42	54.00	-7.58	40.11	6.31	Average	150	0
2	5150.00	58.45	74.00	-15.55	52.14	6.31	Peak	150	0
3	10520.00	59.46	68.20	-8.74	42.86	16.60	Peak	222	185
4	15780.00	51.27	54.00	-2.73	34.22	17.05	Average	255	180
5	15780.00	64.27	74.00	-9.73	47.22	17.05	Peak	225	180

Note 1: Emission Level (dBuV/m) = SA Reading (dBuV/m) + Factor\* (dB)

\*Factor includes antenna factor , cable loss and amplifier gain

Note 2: Margin (dB) = Emission level (dBuV/m) – Limit (dBuV/m).

<b>Modulation</b>	HT20	<b>Test Freq. (MHz)</b>	5260
<b>Polarization</b>	Vertical	<b>Test Configuration</b>	2

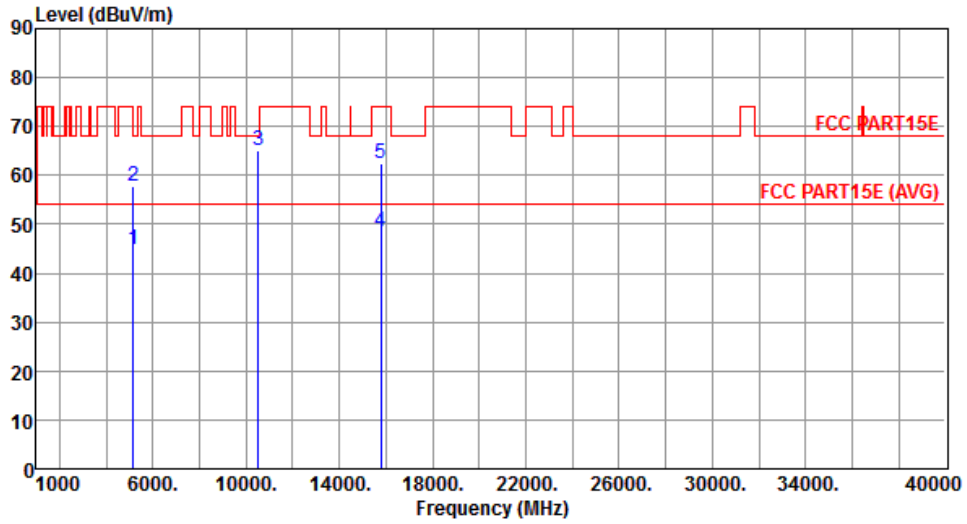

	Freq. MHz	Emission level dBuV/m	Limit dBuV/m	Margin dB	SA reading dBuV	Factor dB	Remark	ANT High cm	Turn Table deg
1	5150.00	44.86	54.00	-9.14	38.55	6.31	Average	152	185
2	5150.00	57.72	74.00	-16.28	51.41	6.31	Peak	152	185
3	10520.00	64.95	68.20	-3.25	48.35	16.60	Peak	355	173
4	15780.00	48.58	54.00	-5.42	31.53	17.05	Average	355	173
5	15780.00	62.30	74.00	-11.70	45.25	17.05	Peak	355	173

Note 1: Emission Level (dBuV/m) = SA Reading (dBuV/m) + Factor\* (dB)

\*Factor includes antenna factor , cable loss and amplifier gain

Note 2: Margin (dB) = Emission level (dBuV/m) – Limit (dBuV/m).

<b>Modulation</b>	HT20	<b>Test Freq. (MHz)</b>	5300
<b>Polarization</b>	Horizontal	<b>Test Configuration</b>	2

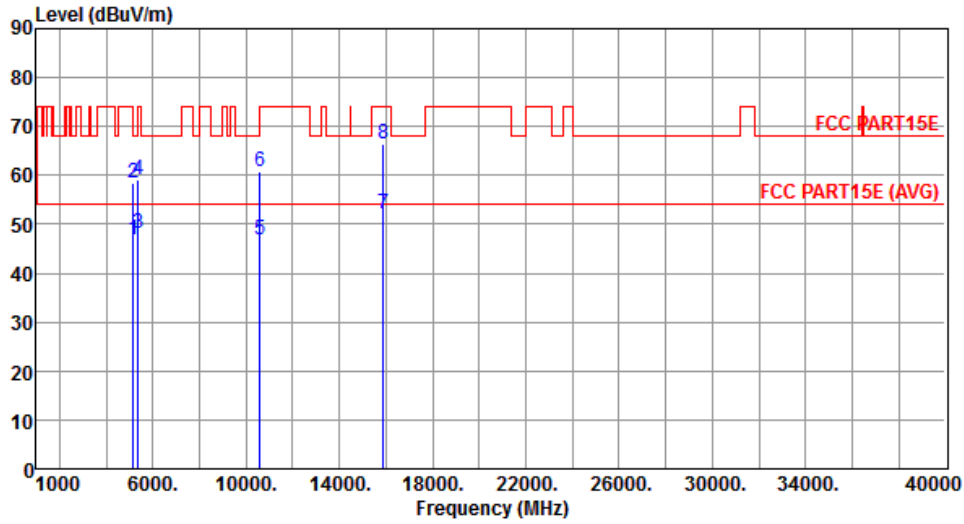

	Freq. MHz	Emission level dBuV/m	Limit dBuV/m	Margin dB	SA reading dBuV	Factor dB	Remark	ANT High cm	Turn Table deg
1	5150.00	46.83	54.00	-7.17	40.52	6.31	Average	180	345
2	5150.00	58.51	74.00	-15.49	52.20	6.31	Peak	180	345
3	5350.00	48.14	54.00	-5.86	41.52	6.62	Average	180	345
4	5350.00	59.17	74.00	-14.83	52.55	6.62	Peak	180	345
5	10600.00	46.97	54.00	-7.03	30.35	16.62	Average	212	167
6	10600.00	60.75	74.00	-13.25	44.13	16.62	Peak	221	167
7	15900.00	52.06	54.00	-1.94	35.24	16.82	Average	290	157
8	15900.00	66.58	74.00	-7.42	49.76	16.82	Peak	290	157

Note 1: Emission Level (dBuV/m) = SA Reading (dBuV/m) + Factor\* (dB)

\*Factor includes antenna factor , cable loss and amplifier gain

Note 2: Margin (dB) = Emission level (dBuV/m) – Limit (dBuV/m).

<b>Modulation</b>	HT20	<b>Test Freq. (MHz)</b>	5300
<b>Polarization</b>	Vertical	<b>Test Configuration</b>	2

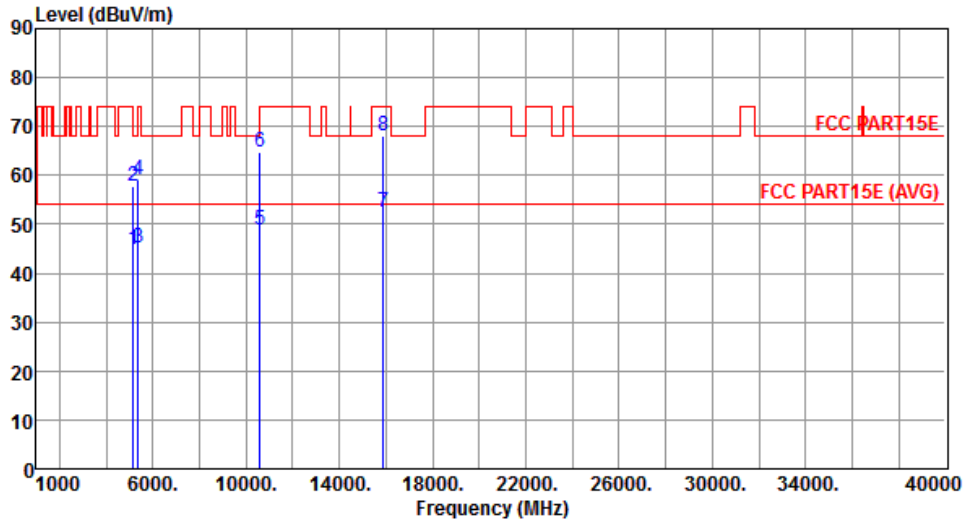

	Freq. MHz	Emission level dBuV/m	Limit dBuV/m	Margin dB	SA reading dBuV	Factor dB	Remark	ANT High cm	Turn Table deg
1	5150.00	44.82	54.00	-9.18	38.51	6.31	Average	155	42
2	5150.00	57.86	74.00	-16.14	51.55	6.31	Peak	155	42
3	5350.00	45.18	54.00	-8.82	38.56	6.62	Average	155	42
4	5350.00	59.16	74.00	-14.84	52.54	6.62	Peak	155	42
5	10600.00	48.92	54.00	-5.08	32.30	16.62	Average	320	185
6	10600.00	64.92	74.00	-9.08	48.30	16.62	Peak	320	185
7	15900.00	52.55	54.00	-1.45	35.73	16.82	Average	151	185
8	15900.00	68.08	74.00	-5.92	51.26	16.82	Peak	151	185

Note 1: Emission Level (dBuV/m) = SA Reading (dBuV/m) + Factor\* (dB)

\*Factor includes antenna factor , cable loss and amplifier gain

Note 2: Margin (dB) = Emission level (dBuV/m) – Limit (dBuV/m).

<b>Modulation</b>	HT20	<b>Test Freq. (MHz)</b>	5320
<b>Polarization</b>	Horizontal	<b>Test Configuration</b>	2

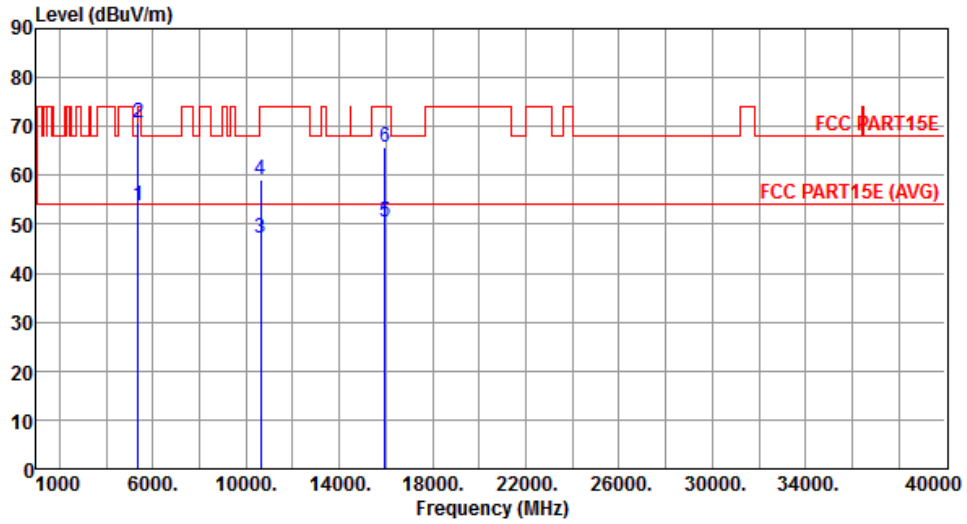

	Freq. MHz	Emission level dBuV/m	Limit dBuV/m	Margin dB	SA reading dBuV	Factor dB	Remark	ANT High cm	Turn Table deg
1	5350.00	53.66	54.00	-0.34	47.04	6.62	Average	150	347
2	5350.00	70.73	74.00	-3.27	64.11	6.62	Peak	150	347
3	10640.00	47.25	54.00	-6.75	30.62	16.63	Average	150	148
4	10640.00	59.24	74.00	-14.76	42.61	16.63	Peak	150	148
5	15960.00	50.35	54.00	-3.65	33.65	16.70	Average	166	185
6	15960.00	65.65	74.00	-8.35	48.95	16.70	Peak	166	185

Note 1: Emission Level (dBuV/m) = SA Reading (dBuV/m) + Factor\* (dB)

\*Factor includes antenna factor , cable loss and amplifier gain

Note 2: Margin (dB) = Emission level (dBuV/m) – Limit (dBuV/m).

<b>Modulation</b>	HT20	<b>Test Freq. (MHz)</b>	5320
<b>Polarization</b>	Vertical	<b>Test Configuration</b>	2

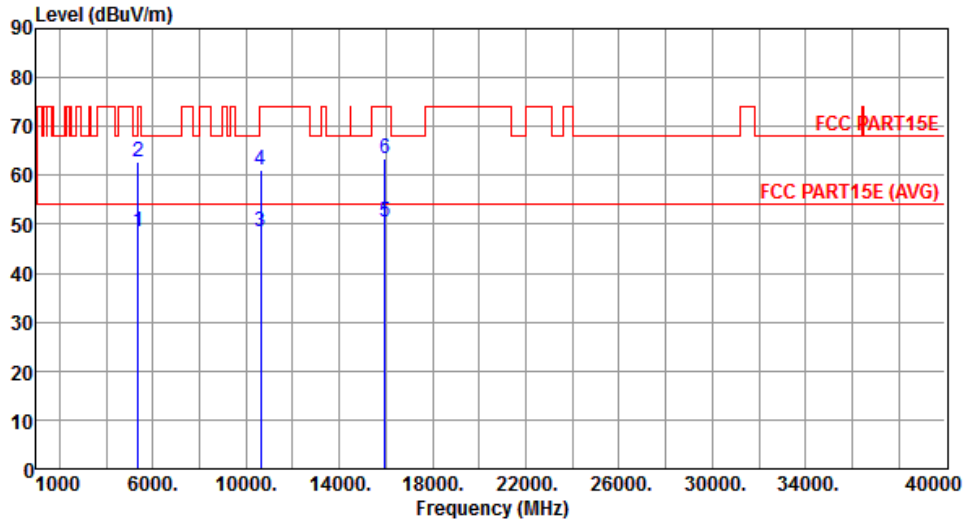

	Freq. MHz	Emission level dBuV/m	Limit dBuV/m	Margin dB	SA reading dBuV	Factor dB	Remark	ANT High cm	Turn Table deg
1	5350.00	48.36	54.00	-5.64	41.74	6.62	Average	202	57
2	5350.00	62.75	74.00	-11.25	56.13	6.62	Peak	202	57
3	10640.00	48.35	54.00	-5.65	31.72	16.63	Average	155	143
4	10640.00	61.21	74.00	-12.79	44.58	16.63	Peak	155	143
5	15960.00	50.53	54.00	-3.47	33.83	16.70	Average	155	143
6	15960.00	63.28	74.00	-10.72	46.58	16.70	Peak	155	143

Note 1: Emission Level (dBuV/m) = SA Reading (dBuV/m) + Factor\* (dB)

\*Factor includes antenna factor , cable loss and amplifier gain

Note 2: Margin (dB) = Emission level (dBuV/m) – Limit (dBuV/m).

<b>Modulation</b>	HT20	<b>Test Freq. (MHz)</b>	5500
<b>Polarization</b>	Horizontal	<b>Test Configuration</b>	2

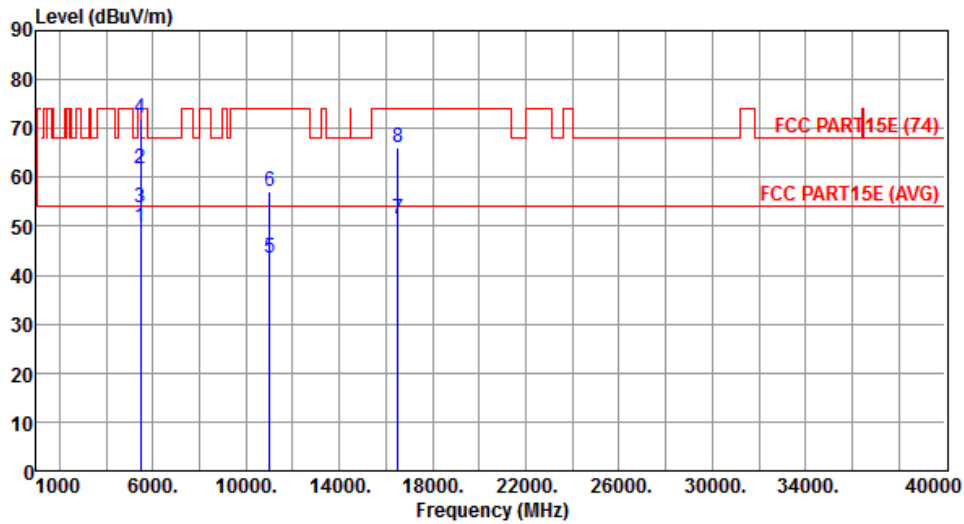

	Freq. MHz	Emission level dBuV/m	Limit dBuV/m	Margin dB	SA reading dBuV	Factor dB	Remark	ANT High cm	Turn Table deg
1	5460.00	49.91	54.00	-4.09	43.15	6.76	Average	150	357
2	5460.00	61.67	74.00	-12.33	54.91	6.76	Peak	150	357
3	5470.00	53.82	54.00	-0.18	47.05	6.77	Average	150	357
4	5470.00	71.95	74.00	-2.05	65.18	6.77	Peak	150	357
5	11000.00	43.65	54.00	-10.35	26.93	16.72	Average	150	357
6	11000.00	57.28	74.00	-16.72	40.56	16.72	Peak	150	357
7	16500.00	51.39	54.00	-2.61	33.52	17.87	Average	188	155
8	16500.00	66.04	74.00	-7.96	48.17	17.87	Peak	188	155

Note 1: Emission Level (dBuV/m) = SA Reading (dBuV/m) + Factor\* (dB)

\*Factor includes antenna factor , cable loss and amplifier gain

Note 2: Margin (dB) = Emission level (dBuV/m) – Limit (dBuV/m).



<b>Modulation</b>	HT20	<b>Test Freq. (MHz)</b>	5500
<b>Polarization</b>	Vertical	<b>Test Configuration</b>	2

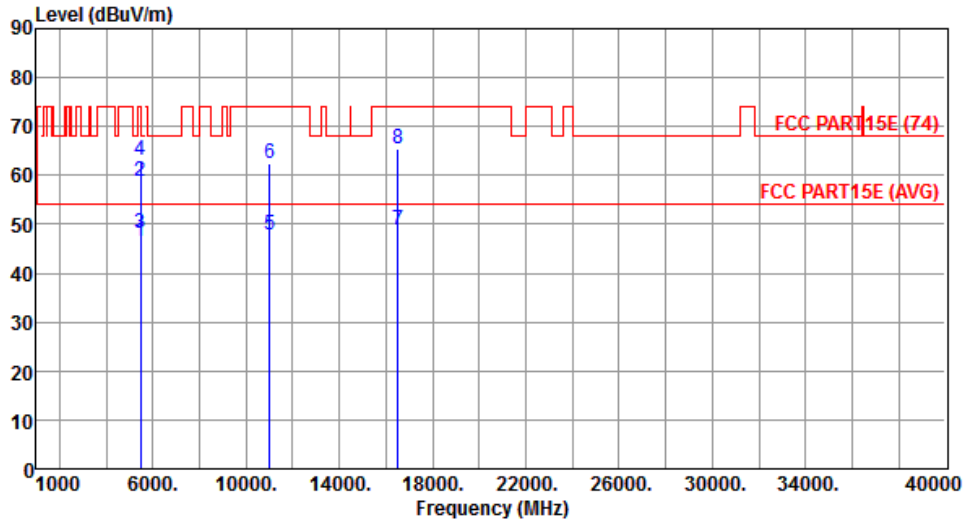

	Freq. MHz	Emission level dBuV/m	Limit dBuV/m	Margin dB	SA reading dBuV	Factor dB	Remark	ANT High cm	Turn Table deg
1	5460.00	46.36	54.00	-7.64	39.60	6.76	Average	195	60
2	5460.00	58.86	74.00	-15.14	52.10	6.76	Peak	195	60
3	5470.00	48.31	54.00	-5.69	41.54	6.77	Average	195	60
4	5470.00	63.09	74.00	-10.91	56.32	6.77	Peak	195	60
5	11000.00	47.67	54.00	-6.33	30.95	16.72	Average	166	185
6	11000.00	62.58	74.00	-11.42	45.86	16.72	Peak	166	185
7	16500.00	48.89	54.00	-5.11	31.02	17.87	Average	166	173
8	16500.00	65.40	74.00	-8.60	47.53	17.87	Peak	166	173

Note 1: Emission Level (dBuV/m) = SA Reading (dBuV/m) + Factor\* (dB)

\*Factor includes antenna factor , cable loss and amplifier gain

Note 2: Margin (dB) = Emission level (dBuV/m) – Limit (dBuV/m).

<b>Modulation</b>	HT20	<b>Test Freq. (MHz)</b>	5580
<b>Polarization</b>	Horizontal	<b>Test Configuration</b>	2

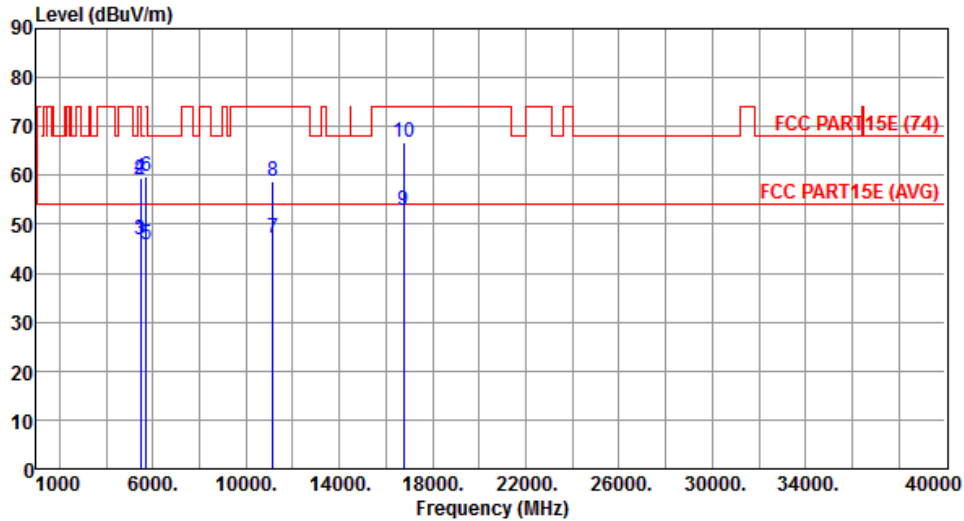

	Freq. MHz	Emission level dBuV/m	Limit dBuV/m	Margin dB	SA reading dBuV	Factor dB	Remark	ANT High cm	Turn Table deg
1	5460.00	46.78	54.00	-7.22	40.02	6.76	Average	223	320
2	5460.00	59.06	74.00	-14.94	52.30	6.76	Peak	223	320
3	5470.00	46.88	54.00	-7.12	40.11	6.77	Average	223	320
4	5470.00	59.38	74.00	-14.62	52.61	6.77	Peak	223	320
5	5725.00	45.87	54.00	-8.13	38.63	7.24	Average	223	320
6	5725.00	59.78	74.00	-14.22	52.54	7.24	Peak	223	320
7	11160.00	47.19	54.00	-6.81	30.40	16.79	Average	248	128
8	11160.00	58.83	74.00	-15.17	42.04	16.79	Peak	248	128
9	16740.00	52.82	54.00	-1.18	34.42	18.40	Average	150	145
10	16740.00	66.85	74.00	-7.15	48.45	18.40	Peak	150	145

Note 1: Emission Level (dBuV/m) = SA Reading (dBuV/m) + Factor\* (dB)

\*Factor includes antenna factor , cable loss and amplifier gain

Note 2: Margin (dB) = Emission level (dBuV/m) – Limit (dBuV/m).

<b>Modulation</b>	HT20	<b>Test Freq. (MHz)</b>	5580
<b>Polarization</b>	Vertical	<b>Test Configuration</b>	2

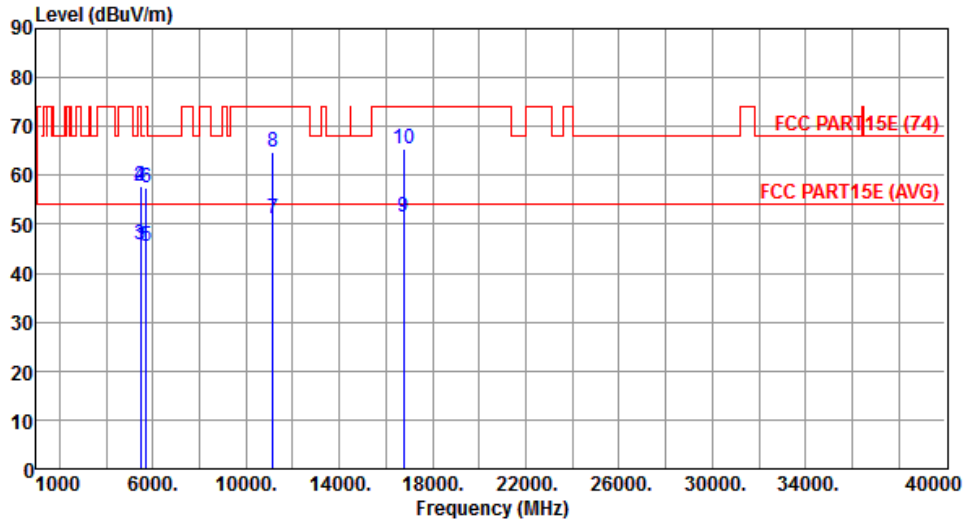

	Freq. MHz	Emission level dBuV/m	Limit dBuV/m	Margin dB	SA reading dBuV	Factor dB	Remark	ANT High cm	Turn Table deg
1	5460.00	45.57	54.00	-8.43	38.81	6.76	Average	264	98
2	5460.00	57.70	74.00	-16.30	50.94	6.76	Peak	264	98
3	5470.00	45.72	54.00	-8.28	38.95	6.77	Average	264	98
4	5470.00	57.88	74.00	-16.12	51.11	6.77	Peak	264	98
5	5725.00	45.34	54.00	-8.66	38.10	7.24	Average	264	98
6	5725.00	57.50	74.00	-16.50	50.26	7.24	Peak	264	98
7	11160.00	50.99	54.00	-3.01	34.20	16.79	Average	164	181
8	11160.00	64.84	74.00	-9.16	48.05	16.79	Peak	164	181
9	16740.00	51.57	54.00	-2.43	33.17	18.40	Average	150	172
10	16740.00	65.30	74.00	-8.70	46.90	18.40	Peak	150	172

Note 1: Emission Level (dBuV/m) = SA Reading (dBuV/m) + Factor\* (dB)

\*Factor includes antenna factor , cable loss and amplifier gain

Note 2: Margin (dB) = Emission level (dBuV/m) – Limit (dBuV/m).

<b>Modulation</b>	HT20	<b>Test Freq. (MHz)</b>	5700
<b>Polarization</b>	Horizontal	<b>Test Configuration</b>	2

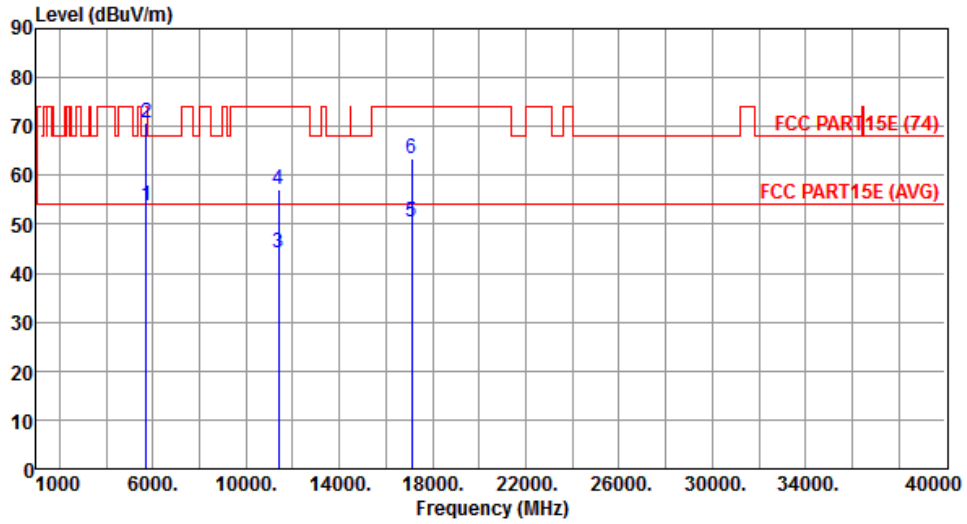

	Freq. MHz	Emission level dBuV/m	Limit dBuV/m	Margin dB	SA reading dBuV	Factor dB	Remark	ANT High cm	Turn Table deg
1	5725.00	53.86	54.00	-0.14	46.62	7.24	Average	150	337
2	5725.00	70.67	74.00	-3.33	63.43	7.24	Peak	150	337
3	11400.00	44.10	54.00	-9.90	27.22	16.88	Average	145	212
4	11400.00	57.04	74.00	-16.96	40.16	16.88	Peak	145	212
5	17100.00	50.40	54.00	-3.60	31.28	19.12	Average	165	185
6	17100.00	63.45	74.00	-10.55	44.33	19.12	Peak	165	185

Note 1: Emission Level (dBuV/m) = SA Reading (dBuV/m) + Factor\* (dB)

\*Factor includes antenna factor , cable loss and amplifier gain

Note 2: Margin (dB) = Emission level (dBuV/m) – Limit (dBuV/m).

<b>Modulation</b>	HT20	<b>Test Freq. (MHz)</b>	5700
<b>Polarization</b>	Vertical	<b>Test Configuration</b>	2

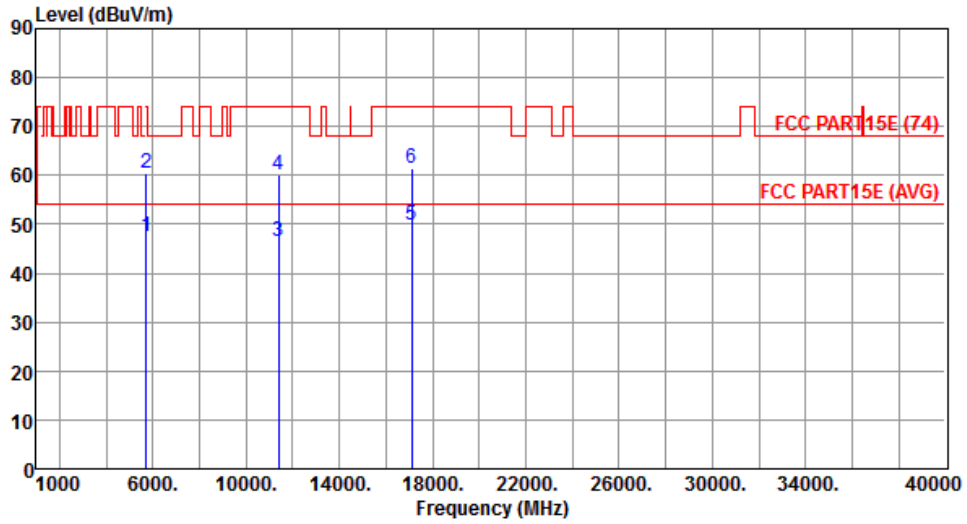

	Freq. MHz	Emission level dBuV/m	Limit dBuV/m	Margin dB	SA reading dBuV	Factor dB	Remark	ANT High cm	Turn Table deg
1	5725.00	47.39	54.00	-6.61	40.15	7.24	Average	343	92
2	5725.00	60.51	74.00	-13.49	53.27	7.24	Peak	343	92
3	11400.00	46.44	54.00	-7.56	29.56	16.88	Average	233	174
4	11400.00	60.19	74.00	-13.81	43.31	16.88	Peak	233	174
5	17100.00	49.94	54.00	-4.06	30.82	19.12	Average	208	122
6	17100.00	61.60	74.00	-12.40	42.48	19.12	Peak	208	122

Note 1: Emission Level (dBuV/m) = SA Reading (dBuV/m) + Factor\* (dB)

\*Factor includes antenna factor , cable loss and amplifier gain

Note 2: Margin (dB) = Emission level (dBuV/m) – Limit (dBuV/m).

<b>Modulation</b>	HT20	<b>Test Freq. (MHz)</b>	5745
<b>Polarization</b>	Horizontal	<b>Test Configuration</b>	2

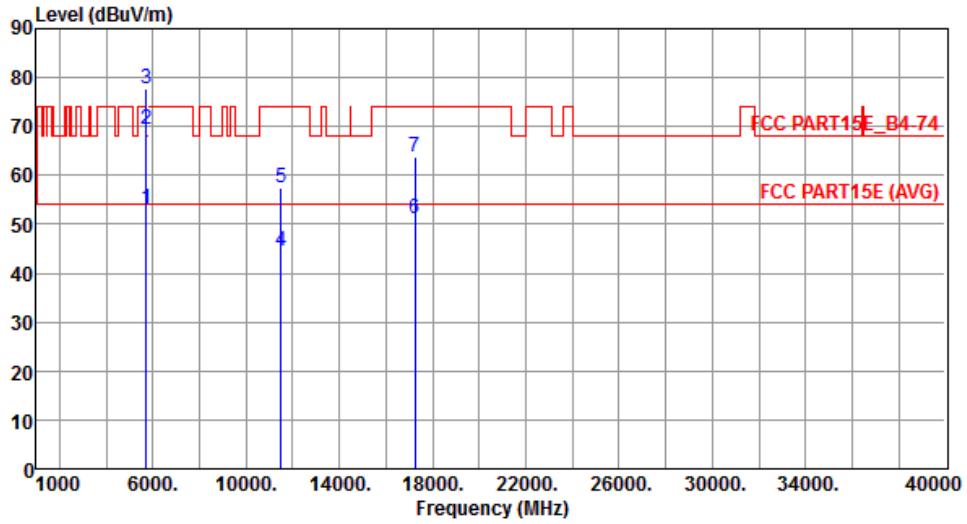

	Freq. MHz	Emission level dBuV/m	Limit dBuV/m	Margin dB	SA reading dBuV	Factor dB	Remark	ANT High cm	Turn Table deg
1	5715.00	53.18	54.00	-0.82	45.98	7.20	Average	191	203
2	5715.00	69.38	74.00	-4.62	62.18	7.20	Peak	191	203
3	5725.00	77.56	78.20	-0.64	70.32	7.24	Peak	191	203
4	11490.00	44.44	54.00	-9.56	27.53	16.91	Average	166	218
5	11490.00	57.35	74.00	-16.65	40.44	16.91	Peak	166	218
6	17235.00	51.11	54.00	-2.89	31.79	19.32	Average	192	110
7	17235.00	63.89	74.00	-10.11	44.57	19.32	Peak	192	110

Note 1: Emission Level (dBuV/m) = SA Reading (dBuV/m) + Factor\* (dB)

\*Factor includes antenna factor , cable loss and amplifier gain

Note 2: Margin (dB) = Emission level (dBuV/m) – Limit (dBuV/m).

<b>Modulation</b>	HT20	<b>Test Freq. (MHz)</b>	5745
<b>Polarization</b>	Vertical	<b>Test Configuration</b>	2

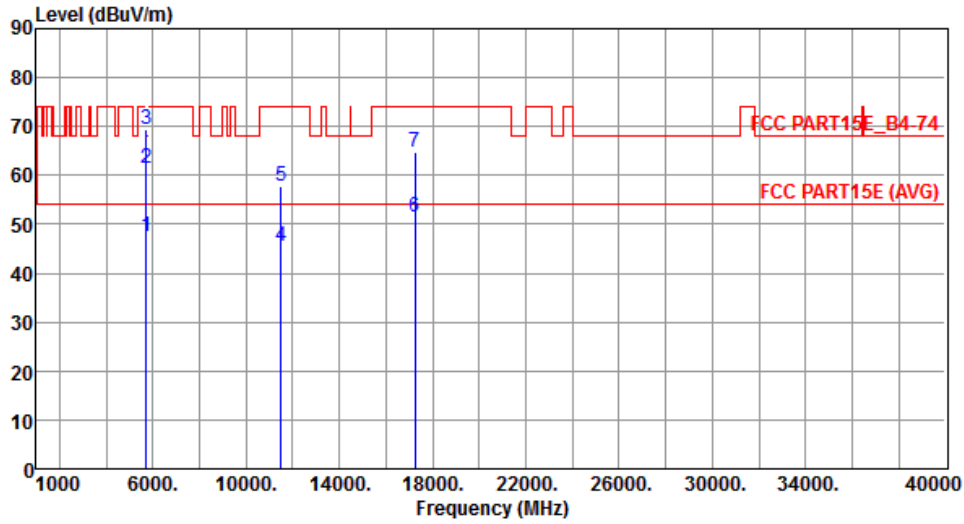

	Freq. MHz	Emission level dBuV/m	Limit dBuV/m	Margin dB	SA reading dBuV	Factor dB	Remark	ANT High cm	Turn Table deg
1	5715.00	47.58	54.00	-6.42	40.38	7.20	Average	267	54
2	5715.00	61.48	74.00	-12.52	54.28	7.20	Peak	267	54
3	5725.00	69.35	78.20	-8.85	62.11	7.24	Peak	267	54
4	11490.00	45.57	54.00	-8.43	28.66	16.91	Average	188	202
5	11490.00	57.65	74.00	-16.35	40.74	16.91	Peak	188	202
6	17235.00	51.38	54.00	-2.62	32.06	19.32	Average	193	138
7	17235.00	64.64	74.00	-9.36	45.32	19.32	Peak	193	138

Note 1: Emission Level (dBuV/m) = SA Reading (dBuV/m) + Factor\* (dB)

\*Factor includes antenna factor , cable loss and amplifier gain

Note 2: Margin (dB) = Emission level (dBuV/m) – Limit (dBuV/m).

<b>Modulation</b>	HT20	<b>Test Freq. (MHz)</b>	5785
<b>Polarization</b>	Horizontal	<b>Test Configuration</b>	2

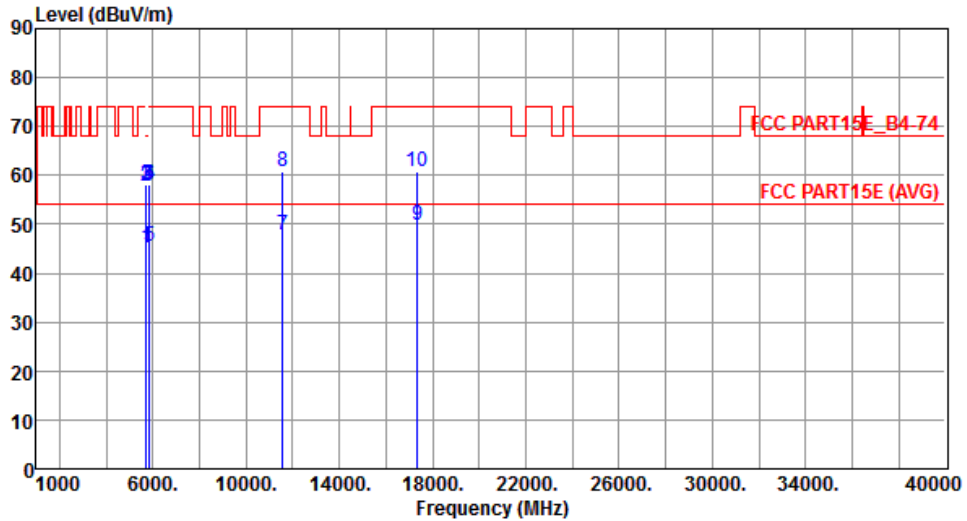

	Freq. MHz	Emission level dBuV/m	Limit dBuV/m	Margin dB	SA reading dBuV	Factor dB	Remark	ANT High cm	Turn Table deg
1	5715.00	45.13	54.00	-8.87	37.93	7.20	Average	333	75
2	5715.00	57.86	74.00	-16.14	50.66	7.20	Peak	333	75
3	5725.00	58.21	78.20	-19.99	50.97	7.24	Peak	333	75
4	5850.00	58.22	78.20	-19.98	50.72	7.50	Peak	333	75
5	5860.00	45.39	54.00	-8.61	37.88	7.51	Average	333	75
6	5860.00	58.04	74.00	-15.96	50.53	7.51	Peak	333	75
7	11570.00	47.98	54.00	-6.02	31.18	16.80	Average	303	187
8	11570.00	60.93	74.00	-13.07	44.13	16.80	Peak	303	187
9	17355.00	49.70	54.00	-4.30	30.21	19.49	Average	150	167
10	17355.00	60.63	74.00	-13.37	41.14	19.49	Peak	150	167

Note 1: Emission Level (dBuV/m) = SA Reading (dBuV/m) + Factor\* (dB)

\*Factor includes antenna factor , cable loss and amplifier gain

Note 2: Margin (dB) = Emission level (dBuV/m) – Limit (dBuV/m).



<b>Modulation</b>	HT20	<b>Test Freq. (MHz)</b>	5785
<b>Polarization</b>	Vertical	<b>Test Configuration</b>	2

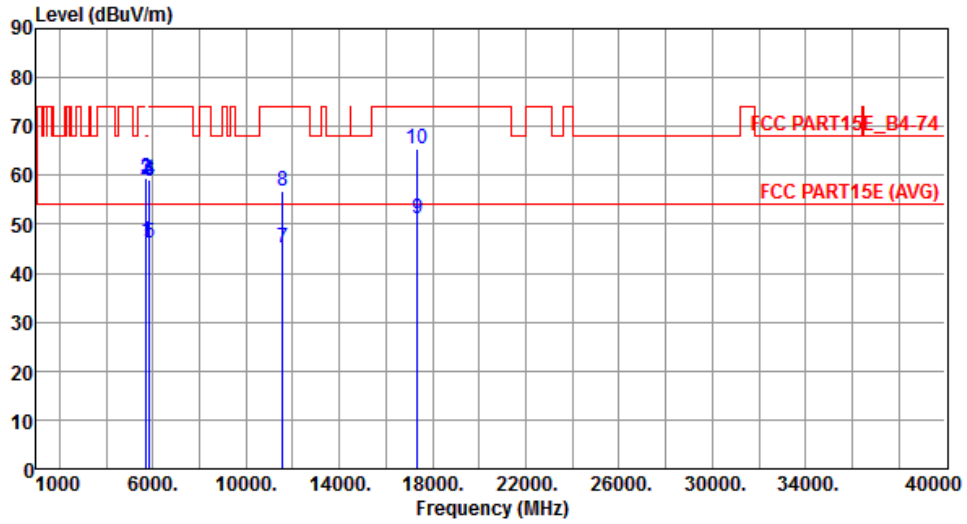

	Freq. MHz	Emission level dBuV/m	Limit dBuV/m	Margin dB	SA reading dBuV	Factor dB	Remark	ANT High cm	Turn Table deg
1	5715.00	46.33	54.00	-7.67	39.13	7.20	Average	232	181
2	5715.00	59.24	74.00	-14.76	52.04	7.20	Peak	232	181
3	5725.00	59.60	78.20	-18.60	52.36	7.24	Peak	232	181
4	5850.00	59.27	78.20	-18.93	51.77	7.50	Peak	232	181
5	5860.00	46.17	54.00	-7.83	38.66	7.51	Average	232	181
6	5860.00	58.94	74.00	-15.06	51.43	7.51	Peak	232	181
7	11570.00	45.28	54.00	-8.72	28.48	16.80	Average	203	125
8	11570.00	56.92	74.00	-17.08	40.12	16.80	Peak	203	125
9	17355.00	51.23	54.00	-2.77	31.74	19.49	Average	228	173
10	17355.00	65.58	74.00	-8.42	46.09	19.49	Peak	228	173

Note 1: Emission Level (dBuV/m) = SA Reading (dBuV/m) + Factor\* (dB)

\*Factor includes antenna factor , cable loss and amplifier gain

Note 2: Margin (dB) = Emission level (dBuV/m) – Limit (dBuV/m).

<b>Modulation</b>	HT20	<b>Test Freq. (MHz)</b>	5825
<b>Polarization</b>	Horizontal	<b>Test Configuration</b>	2

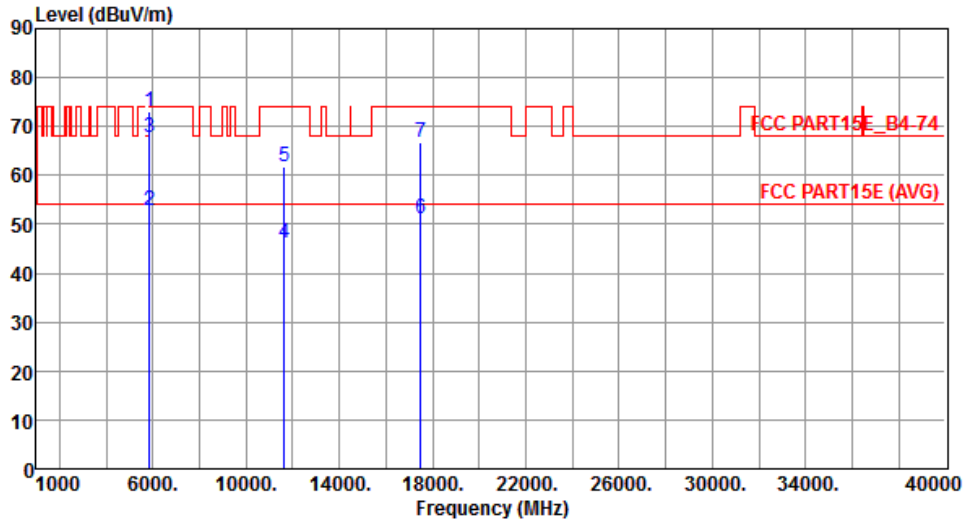

	Freq. MHz	Emission level dBuV/m	Limit dBuV/m	Margin dB	SA reading dBuV	Factor dB	Remark	ANT High cm	Turn Table deg
1	5850.00	73.01	78.20	-5.19	65.51	7.50	Peak	150	349
2	5860.00	52.68	54.00	-1.32	45.17	7.51	Average	150	349
3	5860.00	67.61	74.00	-6.39	60.10	7.51	Peak	150	349
4	11650.00	46.18	54.00	-7.82	29.53	16.65	Average	165	200
5	11650.00	61.61	74.00	-12.39	44.96	16.65	Peak	165	200
6	17475.00	51.11	54.00	-2.89	31.45	19.66	Average	158	168
7	17475.00	66.72	74.00	-7.28	47.06	19.66	Peak	158	168

Note 1: Emission Level (dBuV/m) = SA Reading (dBuV/m) + Factor\* (dB)

\*Factor includes antenna factor , cable loss and amplifier gain

Note 2: Margin (dB) = Emission level (dBuV/m) – Limit (dBuV/m).

<b>Modulation</b>	HT20	<b>Test Freq. (MHz)</b>	5825
<b>Polarization</b>	Vertical	<b>Test Configuration</b>	2

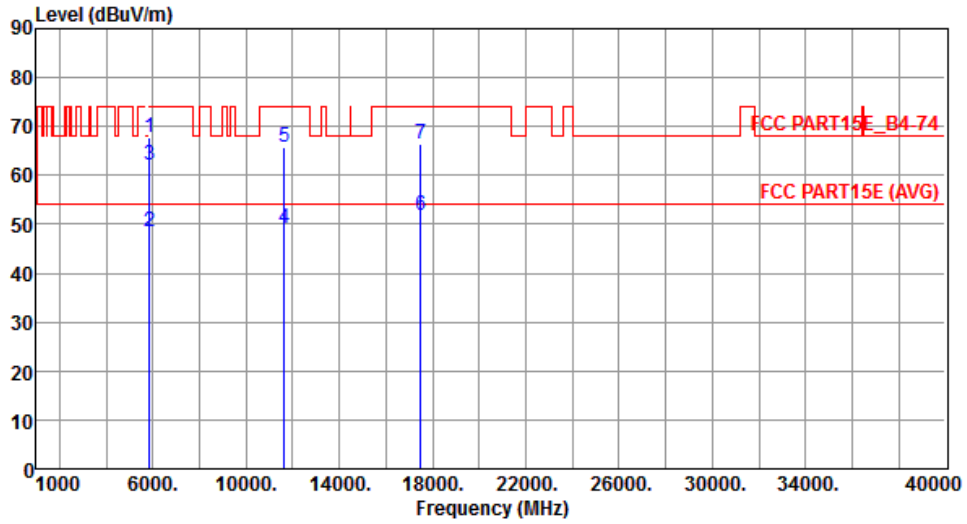

	Freq. MHz	Emission level dBuV/m	Limit dBuV/m	Margin dB	SA reading dBuV	Factor dB	Remark	ANT High cm	Turn Table deg
1	5850.00	67.84	78.20	-10.36	60.34	7.50	Peak	359	80
2	5860.00	48.64	54.00	-5.36	41.13	7.51	Average	359	80
3	5860.00	62.04	74.00	-11.96	54.53	7.51	Peak	359	80
4	11650.00	49.18	54.00	-4.82	32.53	16.65	Average	165	188
5	11650.00	65.61	74.00	-8.39	48.96	16.65	Peak	165	188
6	17475.00	51.89	54.00	-2.11	32.23	19.66	Average	300	162
7	17475.00	66.38	74.00	-7.62	46.72	19.66	Peak	300	162

Note 1: Emission Level (dBuV/m) = SA Reading (dBuV/m) + Factor\* (dB)

\*Factor includes antenna factor , cable loss and amplifier gain

Note 2: Margin (dB) = Emission level (dBuV/m) – Limit (dBuV/m).

### 3.5.11 Transmitter Radiated Unwanted Emissions (Above 1GHz) for HT40

Modulation	HT40	Test Freq. (MHz)	5190																																																																		
Polarization	Horizontal	Test Configuration	2																																																																		
	<table border="1"> <thead> <tr> <th>Freq.</th> <th>Emission level</th> <th>Limit</th> <th>Margin</th> <th>SA reading</th> <th>Factor</th> <th>Remark</th> <th>ANT High</th> <th>Turn Table</th> </tr> <tr> <th>MHz</th> <th>dBuV/m</th> <th>dBuV/m</th> <th>dB</th> <th>dBuV</th> <th>dB</th> <th></th> <th>cm</th> <th>deg</th> </tr> </thead> <tbody> <tr> <td>1</td> <td>5150.00</td> <td>52.35</td> <td>54.00</td> <td>-1.65</td> <td>46.04</td> <td>6.31</td> <td>Average</td> <td>150</td> <td>175</td> </tr> <tr> <td>2</td> <td>5150.00</td> <td>68.54</td> <td>74.00</td> <td>-5.46</td> <td>62.23</td> <td>6.31</td> <td>Peak</td> <td>150</td> <td>175</td> </tr> <tr> <td>3</td> <td>10380.00</td> <td>57.27</td> <td>68.20</td> <td>-10.93</td> <td>40.90</td> <td>16.37</td> <td>Peak</td> <td>270</td> <td>56</td> </tr> <tr> <td>4</td> <td>15570.00</td> <td>45.33</td> <td>54.00</td> <td>-8.67</td> <td>27.90</td> <td>17.43</td> <td>Average</td> <td>300</td> <td>267</td> </tr> <tr> <td>5</td> <td>15570.00</td> <td>56.09</td> <td>74.00</td> <td>-17.91</td> <td>38.66</td> <td>17.43</td> <td>Peak</td> <td>300</td> <td>267</td> </tr> </tbody> </table>	Freq.	Emission level	Limit	Margin	SA reading	Factor	Remark	ANT High	Turn Table	MHz	dBuV/m	dBuV/m	dB	dBuV	dB		cm	deg	1	5150.00	52.35	54.00	-1.65	46.04	6.31	Average	150	175	2	5150.00	68.54	74.00	-5.46	62.23	6.31	Peak	150	175	3	10380.00	57.27	68.20	-10.93	40.90	16.37	Peak	270	56	4	15570.00	45.33	54.00	-8.67	27.90	17.43	Average	300	267	5	15570.00	56.09	74.00	-17.91	38.66	17.43	Peak	300	267
Freq.	Emission level	Limit	Margin	SA reading	Factor	Remark	ANT High	Turn Table																																																													
MHz	dBuV/m	dBuV/m	dB	dBuV	dB		cm	deg																																																													
1	5150.00	52.35	54.00	-1.65	46.04	6.31	Average	150	175																																																												
2	5150.00	68.54	74.00	-5.46	62.23	6.31	Peak	150	175																																																												
3	10380.00	57.27	68.20	-10.93	40.90	16.37	Peak	270	56																																																												
4	15570.00	45.33	54.00	-8.67	27.90	17.43	Average	300	267																																																												
5	15570.00	56.09	74.00	-17.91	38.66	17.43	Peak	300	267																																																												
<p>Note 1: Emission Level (dBuV/m) = SA Reading (dBuV/m) + Factor* (dB)            *Factor includes antenna factor , cable loss and amplifier gain            Note 2: Margin (dB) = Emission level (dBuV/m) – Limit (dBuV/m).</p>																																																																					

<b>Modulation</b>	HT40	<b>Test Freq. (MHz)</b>	5190
<b>Polarization</b>	Vertical	<b>Test Configuration</b>	2

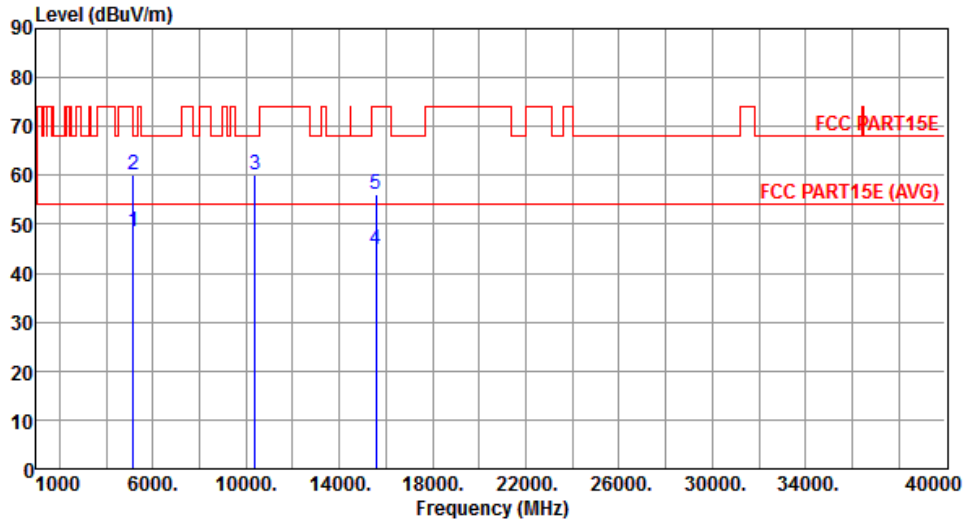

	Freq. MHz	Emission level dBuV/m	Limit dBuV/m	Margin dB	SA reading dBuV	Factor dB	Remark	ANT High cm	Turn Table deg
1	5150.00	48.52	54.00	-5.48	42.21	6.31	Average	150	113
2	5150.00	60.10	74.00	-13.90	53.79	6.31	Peak	150	113
3	10380.00	60.21	68.20	-7.99	43.84	16.37	Peak	372	175
4	15570.00	44.89	54.00	-9.11	27.46	17.43	Average	198	203
5	15570.00	55.99	74.00	-18.01	38.56	17.43	Peak	198	203

Note 1: Emission Level (dBuV/m) = SA Reading (dBuV/m) + Factor\* (dB)

\*Factor includes antenna factor , cable loss and amplifier gain

Note 2: Margin (dB) = Emission level (dBuV/m) – Limit (dBuV/m).

<b>Modulation</b>	HT40	<b>Test Freq. (MHz)</b>	5230
<b>Polarization</b>	Horizontal	<b>Test Configuration</b>	2

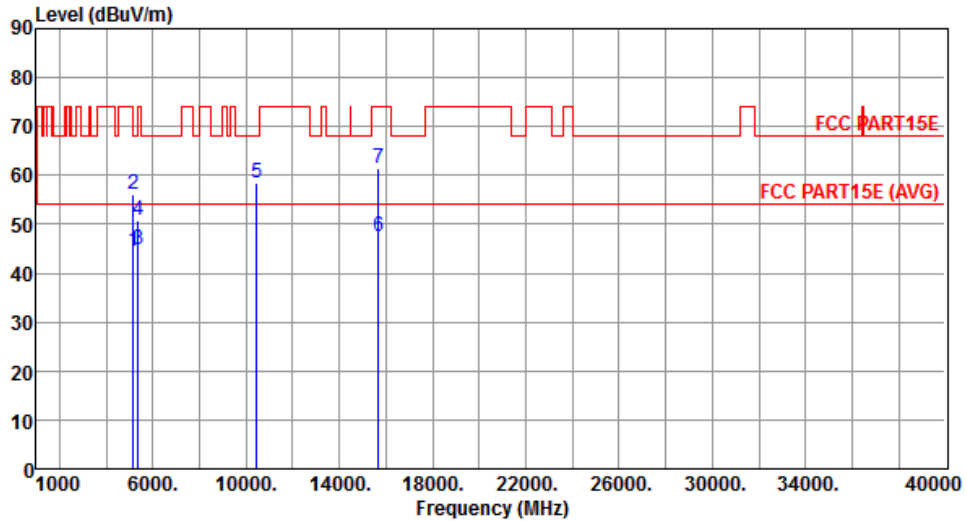

	Freq. MHz	Emission level dBuV/m	Limit dBuV/m	Margin dB	SA reading dBuV	Factor dB	Remark	ANT High cm	Turn Table deg
1	5150.00	44.56	54.00	-9.44	38.25	6.31	Average	150	175
2	5150.00	56.16	74.00	-17.84	49.85	6.31	Peak	150	175
3	5350.00	44.87	54.00	-9.13	38.25	6.62	Average	150	175
4	5350.00	50.88	74.00	-23.12	44.26	6.62	Peak	150	175
5	10460.00	58.38	68.20	-9.82	41.85	16.53	Peak	167	188
6	15690.00	47.47	54.00	-6.53	30.25	17.22	Average	242	212
7	15690.00	61.47	74.00	-12.53	44.25	17.22	Peak	242	212

Note 1: Emission Level (dBuV/m) = SA Reading (dBuV/m) + Factor\* (dB)

\*Factor includes antenna factor , cable loss and amplifier gain

Note 2: Margin (dB) = Emission level (dBuV/m) – Limit (dBuV/m).

<b>Modulation</b>	HT40	<b>Test Freq. (MHz)</b>	5230
<b>Polarization</b>	Vertical	<b>Test Configuration</b>	2

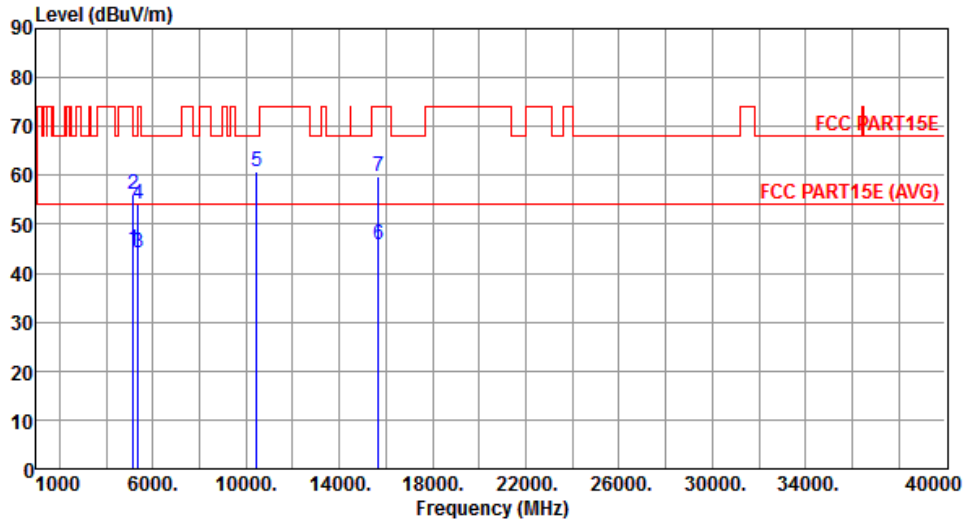

	Freq. MHz	Emission level dBuV/m	Limit dBuV/m	Margin dB	SA reading dBuV	Factor dB	Remark	ANT High cm	Turn Table deg
1	5150.00	44.80	54.00	-9.20	38.49	6.31	Average	170	92
2	5150.00	56.20	74.00	-17.80	49.89	6.31	Peak	170	92
3	5350.00	44.22	54.00	-9.78	37.60	6.62	Average	170	92
4	5350.00	54.18	74.00	-19.82	47.56	6.62	Peak	170	92
5	10460.00	60.78	68.20	-7.42	44.25	16.53	Peak	376	175
6	15690.00	45.77	54.00	-8.23	28.55	17.22	Average	361	141
7	15690.00	59.77	74.00	-14.23	42.55	17.22	Peak	361	141

Note 1: Emission Level (dBuV/m) = SA Reading (dBuV/m) + Factor\* (dB)

\*Factor includes antenna factor , cable loss and amplifier gain

Note 2: Margin (dB) = Emission level (dBuV/m) – Limit (dBuV/m).

<b>Modulation</b>	HT40	<b>Test Freq. (MHz)</b>	5270
<b>Polarization</b>	Horizontal	<b>Test Configuration</b>	2

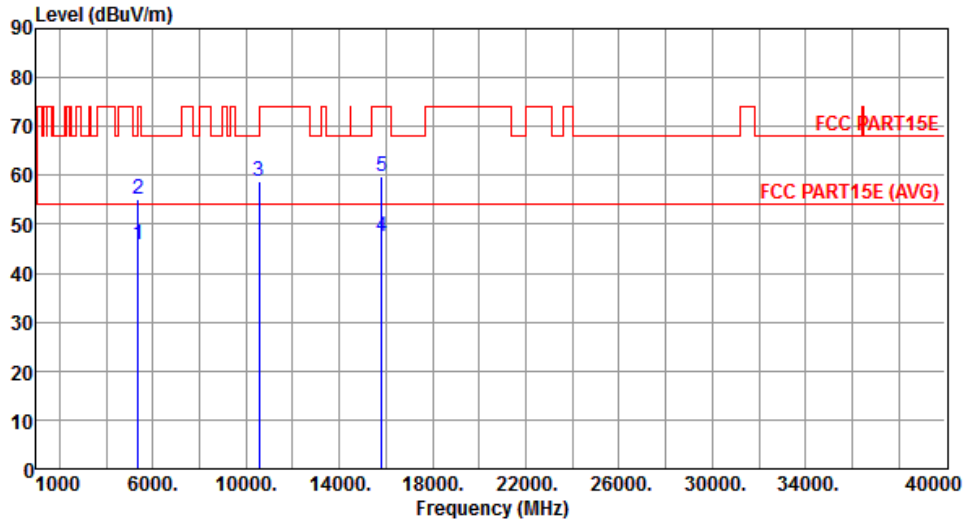

	Freq. MHz	Emission level dBuV/m	Limit dBuV/m	Margin dB	SA reading dBuV	Factor dB	Remark	ANT High cm	Turn Table deg
1	5350.00	45.68	54.00	-8.32	39.06	6.62	Average	150	177
2	5350.00	54.97	74.00	-19.03	48.35	6.62	Peak	150	177
3	10540.00	58.90	68.20	-9.30	42.30	16.60	Peak	269	208
4	15810.00	47.53	54.00	-6.47	30.55	16.98	Average	150	211
5	15810.00	59.64	74.00	-14.36	42.66	16.98	Peak	150	211

Note 1: Emission Level (dBuV/m) = SA Reading (dBuV/m) + Factor\* (dB)

\*Factor includes antenna factor , cable loss and amplifier gain

Note 2: Margin (dB) = Emission level (dBuV/m) – Limit (dBuV/m).



<b>Modulation</b>	HT40	<b>Test Freq. (MHz)</b>	5270
<b>Polarization</b>	Vertical	<b>Test Configuration</b>	2

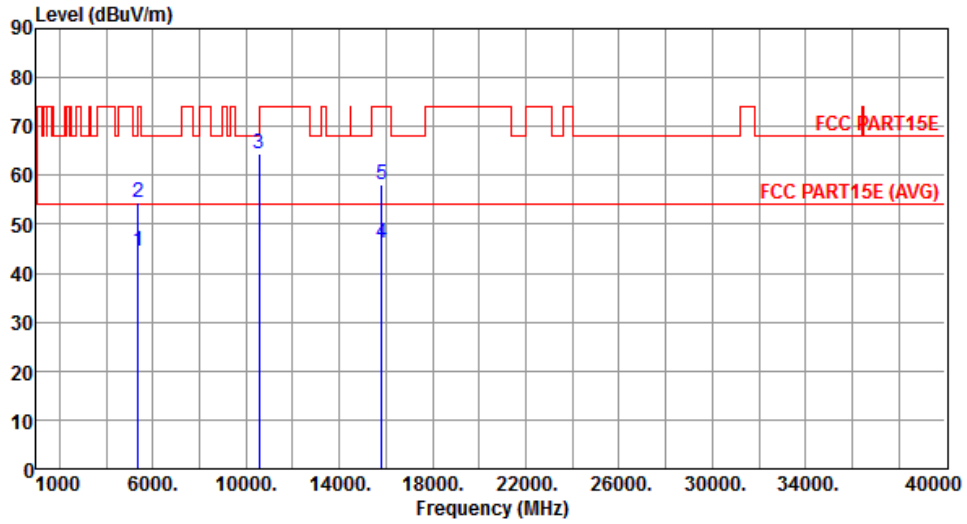

	Freq. MHz	Emission level dBuV/m	Limit dBuV/m	Margin dB	SA reading dBuV	Factor dB	Remark	ANT High cm	Turn Table deg
1	5350.00	44.42	54.00	-9.58	37.80	6.62	Average	150	75
2	5350.00	54.42	74.00	-19.58	47.80	6.62	Peak	150	75
3	10540.00	64.41	68.20	-3.79	47.81	16.60	Peak	150	75
4	15810.00	46.19	54.00	-7.81	29.21	16.98	Average	389	134
5	15810.00	58.05	74.00	-15.95	41.07	16.98	Peak	389	134

Note 1: Emission Level (dBuV/m) = SA Reading (dBuV/m) + Factor\* (dB)

\*Factor includes antenna factor , cable loss and amplifier gain

Note 2: Margin (dB) = Emission level (dBuV/m) – Limit (dBuV/m).

<b>Modulation</b>	HT40	<b>Test Freq. (MHz)</b>	5310
<b>Polarization</b>	Horizontal	<b>Test Configuration</b>	2

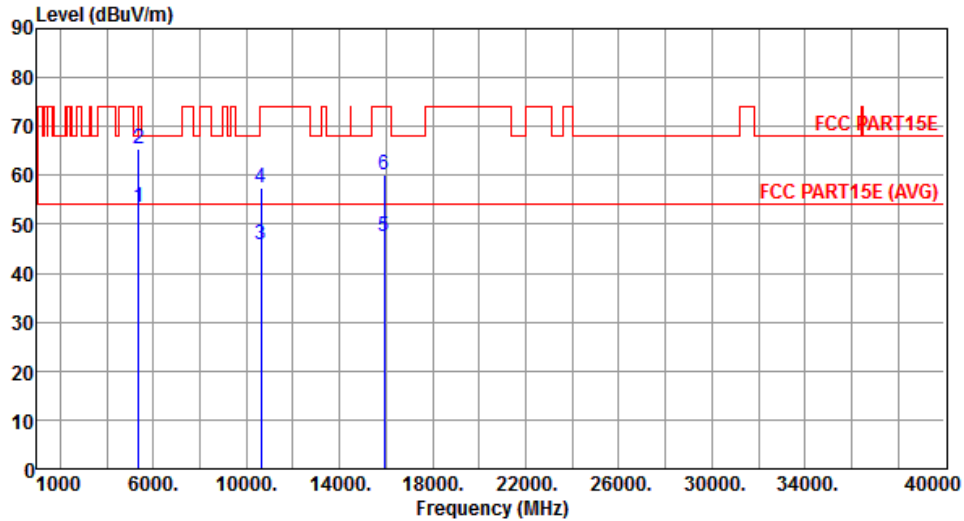

	Freq. MHz	Emission level dBuV/m	Limit dBuV/m	Margin dB	SA reading dBuV	Factor dB	Remark	ANT High cm	Turn Table deg
1	5350.00	53.45	54.00	-0.55	46.83	6.62	Average	150	177
2	5350.00	65.52	74.00	-8.48	58.90	6.62	Peak	150	177
3	10620.00	45.98	54.00	-8.02	29.36	16.62	Average	216	94
4	10620.00	57.34	74.00	-16.66	40.72	16.62	Peak	216	94
5	15930.00	47.57	54.00	-6.43	30.80	16.77	Average	249	170
6	15930.00	60.27	74.00	-13.73	43.50	16.77	Peak	249	170

Note 1: Emission Level (dBuV/m) = SA Reading (dBuV/m) + Factor\* (dB)

\*Factor includes antenna factor , cable loss and amplifier gain

Note 2: Margin (dB) = Emission level (dBuV/m) – Limit (dBuV/m).

<b>Modulation</b>	HT40	<b>Test Freq. (MHz)</b>	5310
<b>Polarization</b>	Vertical	<b>Test Configuration</b>	2

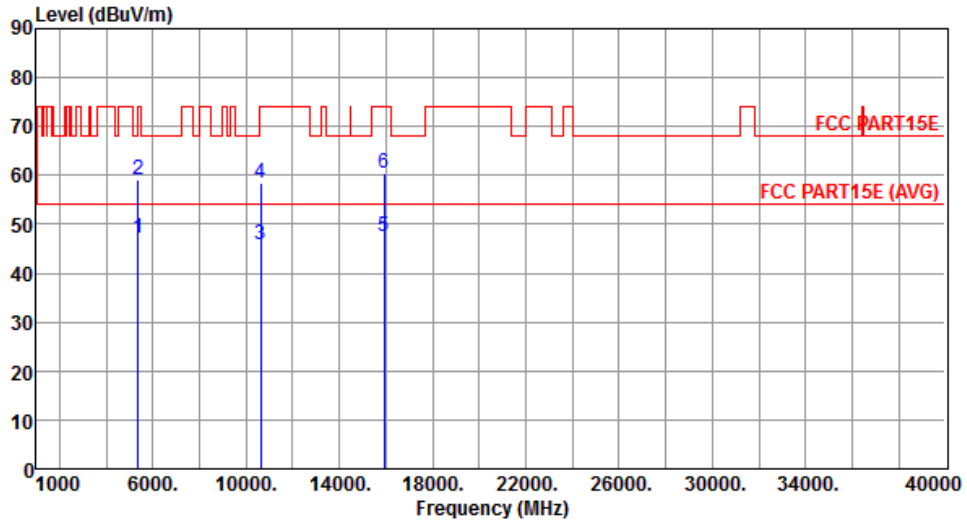

	Freq. MHz	Emission level dBuV/m	Limit dBuV/m	Margin dB	SA reading dBuV	Factor dB	Remark	ANT High cm	Turn Table deg
1	5350.00	47.22	54.00	-6.78	40.60	6.62	Average	173	80
2	5350.00	58.98	74.00	-15.02	52.36	6.62	Peak	173	80
3	10620.00	45.83	54.00	-8.17	29.21	16.62	Average	309	159
4	10620.00	58.48	74.00	-15.52	41.86	16.62	Peak	309	159
5	15930.00	47.37	54.00	-6.63	30.60	16.77	Average	150	171
6	15930.00	60.37	74.00	-13.63	43.60	16.77	Peak	150	171

Note 1: Emission Level (dBuV/m) = SA Reading (dBuV/m) + Factor\* (dB)

\*Factor includes antenna factor , cable loss and amplifier gain

Note 2: Margin (dB) = Emission level (dBuV/m) – Limit (dBuV/m).

<b>Modulation</b>	HT40	<b>Test Freq. (MHz)</b>	5510
<b>Polarization</b>	Horizontal	<b>Test Configuration</b>	2

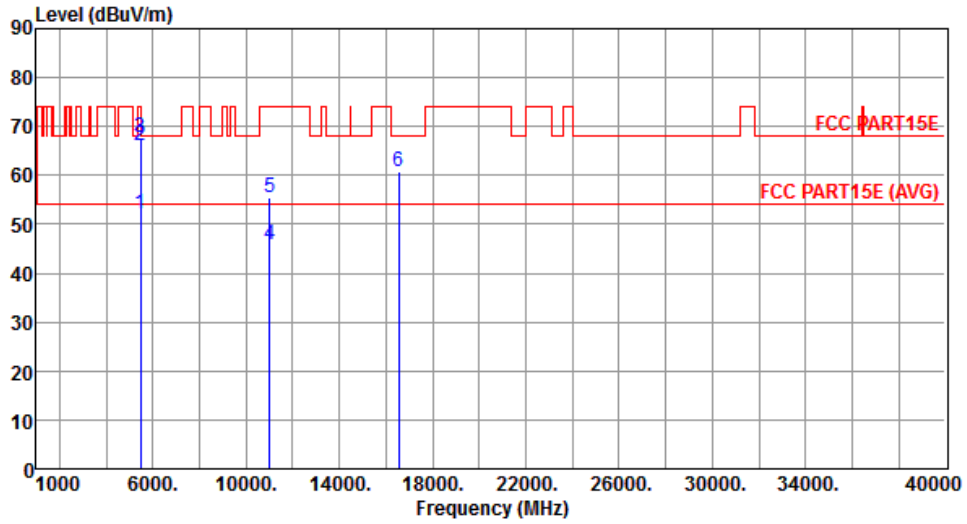

	Freq. MHz	Emission level dBuV/m	Limit dBuV/m	Margin dB	SA reading dBuV	Factor dB	Remark	ANT High cm	Turn Table deg
1	5460.00	52.15	54.00	-1.85	45.39	6.76	Average	150	177
2	5460.00	65.98	74.00	-8.02	59.22	6.76	Peak	150	177
3	5470.00	67.76	68.20	-0.44	60.99	6.77	Peak	150	346
4	11020.00	45.99	54.00	-8.01	29.26	16.73	Average	203	56
5	11020.00	55.42	74.00	-18.58	38.69	16.73	Peak	203	56
6	16530.00	60.93	68.20	-7.27	42.99	17.94	Peak	216	133

Note 1: Emission Level (dBuV/m) = SA Reading (dBuV/m) + Factor\* (dB)

\*Factor includes antenna factor , cable loss and amplifier gain

Note 2: Margin (dB) = Emission level (dBuV/m) – Limit (dBuV/m).

<b>Modulation</b>	HT40	<b>Test Freq. (MHz)</b>	5510
<b>Polarization</b>	Vertical	<b>Test Configuration</b>	2

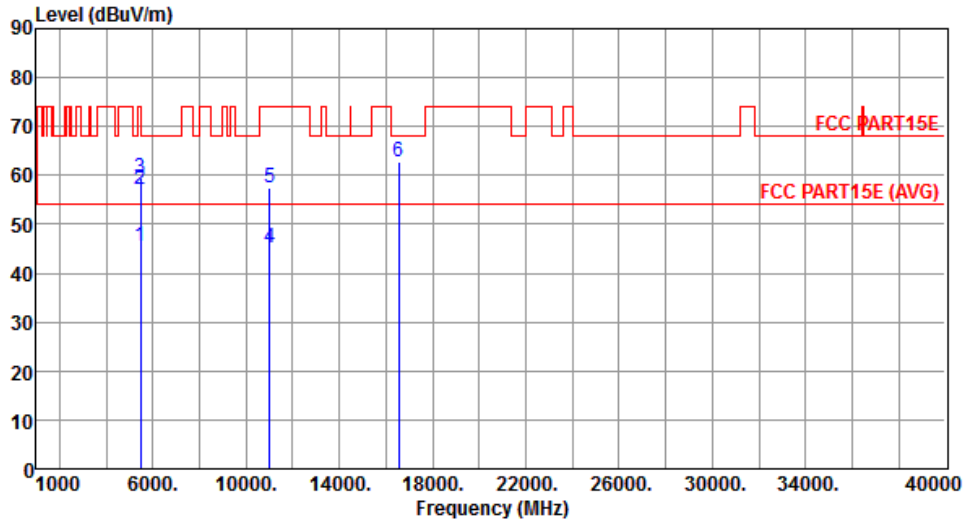

	Freq. MHz	Emission level dBuV/m	Limit dBuV/m	Margin dB	SA reading dBuV	Factor dB	Remark	ANT High cm	Turn Table deg
1	5460.00	45.45	54.00	-8.55	38.69	6.76	Average	250	159
2	5460.00	57.01	74.00	-16.99	50.25	6.76	Peak	250	159
3	5470.00	59.46	68.20	-8.74	52.69	6.77	Peak	250	159
4	11020.00	45.18	54.00	-8.82	28.45	16.73	Average	308	249
5	11020.00	57.39	74.00	-16.61	40.66	16.73	Peak	308	249
6	16530.00	62.74	68.20	-5.46	44.80	17.94	Peak	176	174

Note 1: Emission Level (dBuV/m) = SA Reading (dBuV/m) + Factor\* (dB)

\*Factor includes antenna factor , cable loss and amplifier gain

Note 2: Margin (dB) = Emission level (dBuV/m) – Limit (dBuV/m).

<b>Modulation</b>	HT40	<b>Test Freq. (MHz)</b>	5590
<b>Polarization</b>	Horizontal	<b>Test Configuration</b>	2

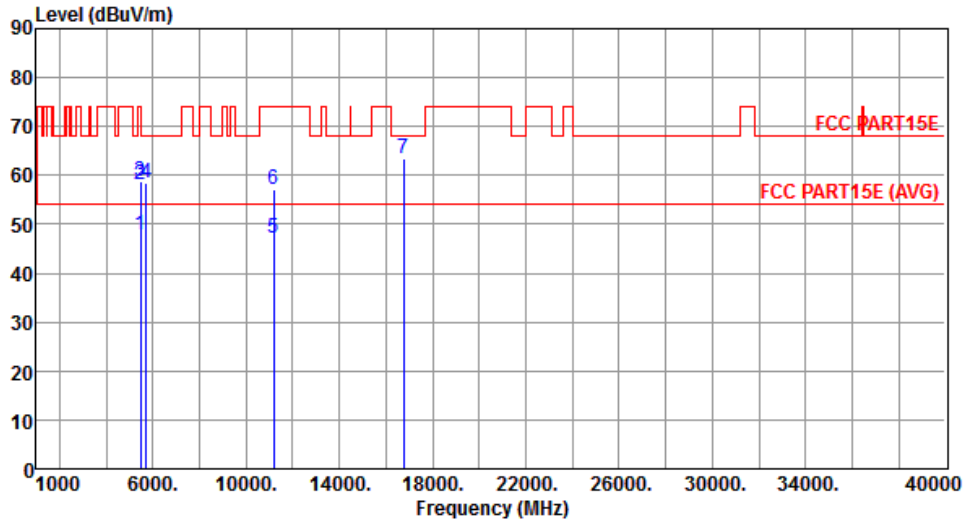

	Freq. MHz	Emission level dBuV/m	Limit dBuV/m	Margin dB	SA reading dBuV	Factor dB	Remark	ANT High cm	Turn Table deg
1	5460.00	47.70	54.00	-6.30	40.94	6.76	Average	152	320
2	5460.00	58.01	74.00	-15.99	51.25	6.76	Peak	152	320
3	5470.00	58.73	68.20	-9.47	51.96	6.77	Peak	152	320
4	5725.00	58.60	68.20	-9.60	51.36	7.24	Peak	152	320
5	11180.00	47.12	54.00	-6.88	30.33	16.79	Average	211	357
6	11180.00	57.16	74.00	-16.84	40.37	16.79	Peak	311	357
7	16770.00	63.47	68.20	-4.73	45.00	18.47	Peak	176	133

Note 1: Emission Level (dBuV/m) = SA Reading (dBuV/m) + Factor\* (dB)

\*Factor includes antenna factor , cable loss and amplifier gain

Note 2: Margin (dB) = Emission level (dBuV/m) – Limit (dBuV/m).

<b>Modulation</b>	HT40	<b>Test Freq. (MHz)</b>	5590
<b>Polarization</b>	Vertical	<b>Test Configuration</b>	2

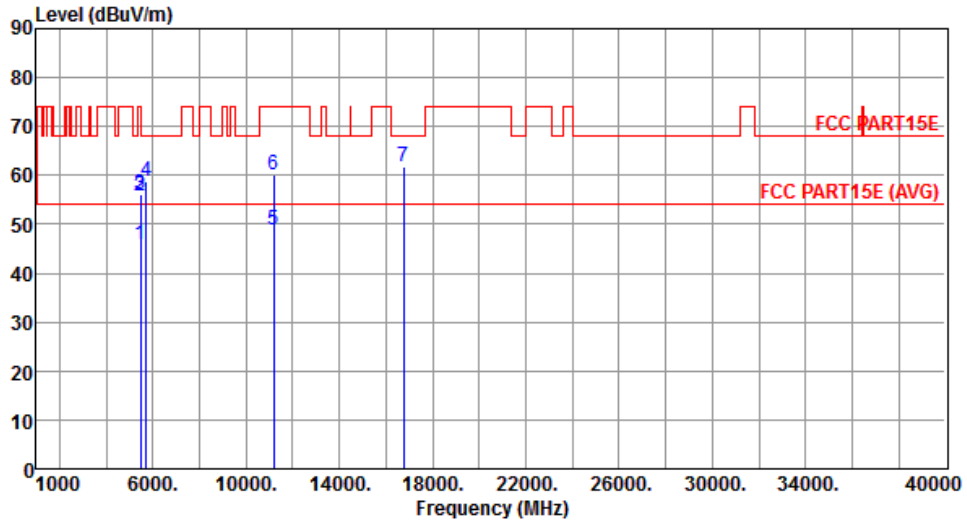

	Freq. MHz	Emission level dBuV/m	Limit dBuV/m	Margin dB	SA reading dBuV	Factor dB	Remark	ANT High cm	Turn Table deg
1	5460.00	45.73	54.00	-8.27	38.97	6.76	Average	342	60
2	5460.00	55.95	74.00	-18.05	49.19	6.76	Peak	342	60
3	5470.00	56.26	68.20	-11.94	49.49	6.77	Peak	342	60
4	5725.00	58.86	68.20	-9.34	51.62	7.24	Peak	342	60
5	11180.00	48.82	54.00	-5.18	32.03	16.79	Average	238	165
6	11180.00	60.01	74.00	-13.99	43.22	16.79	Peak	238	165
7	16770.00	61.76	68.20	-6.44	43.29	18.47	Peak	168	194

Note 1: Emission Level (dBuV/m) = SA Reading (dBuV/m) + Factor\* (dB)

\*Factor includes antenna factor , cable loss and amplifier gain

Note 2: Margin (dB) = Emission level (dBuV/m) – Limit (dBuV/m).

<b>Modulation</b>	HT40	<b>Test Freq. (MHz)</b>	5670
<b>Polarization</b>	Horizontal	<b>Test Configuration</b>	2

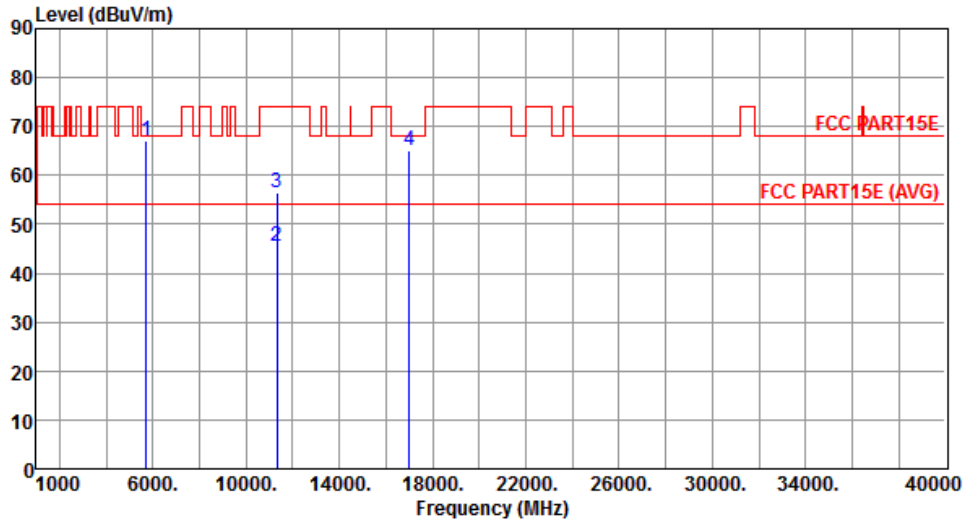

	Freq. MHz	Emission level dBuV/m	Limit dBuV/m	Margin dB	SA reading dBuV	Factor dB	Remark	ANT High cm	Turn Table deg
1	5725.00	67.03	68.20	-1.17	59.79	7.24	Peak	156	341
2	11340.00	45.36	54.00	-8.64	28.51	16.85	Average	183	241
3	11340.00	56.45	74.00	-17.55	39.60	16.85	Peak	183	241
4	17010.00	64.93	68.20	-3.27	45.94	18.99	Peak	179	133

Note 1: Emission Level (dBuV/m) = SA Reading (dBuV/m) + Factor\* (dB)

\*Factor includes antenna factor , cable loss and amplifier gain

Note 2: Margin (dB) = Emission level (dBuV/m) – Limit (dBuV/m).



<b>Modulation</b>	HT40	<b>Test Freq. (MHz)</b>	5670
<b>Polarization</b>	Vertical	<b>Test Configuration</b>	2

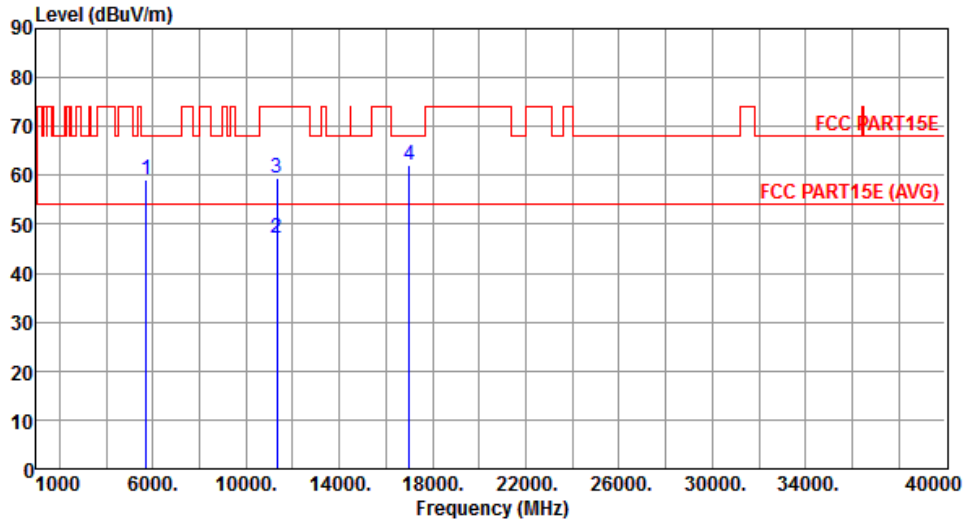

	Freq. MHz	Emission level dBuV/m	Limit dBuV/m	Margin dB	SA reading dBuV	Factor dB	Remark	ANT High cm	Turn Table deg
1	5725.00	59.03	68.20	-9.17	51.79	7.24	Peak	363	63
2	11340.00	47.12	54.00	-6.88	30.27	16.85	Average	271	56
3	11340.00	59.42	74.00	-14.58	42.57	16.85	Peak	271	56
4	17010.00	61.95	68.20	-6.25	42.96	18.99	Peak	161	170

Note 1: Emission Level (dBuV/m) = SA Reading (dBuV/m) + Factor\* (dB)

\*Factor includes antenna factor , cable loss and amplifier gain

Note 2: Margin (dB) = Emission level (dBuV/m) – Limit (dBuV/m).

<b>Modulation</b>	HT40	<b>Test Freq. (MHz)</b>	5755
<b>Polarization</b>	Horizontal	<b>Test Configuration</b>	2

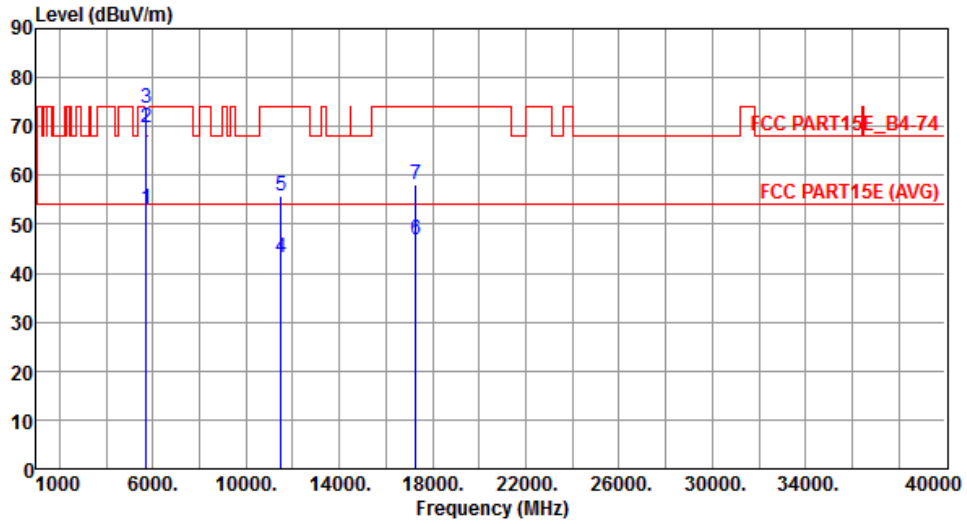

	Freq. MHz	Emission level dBuV/m	Limit dBuV/m	Margin dB	SA reading dBuV	Factor dB	Remark	ANT High cm	Turn Table deg
1	5715.00	53.15	54.00	-0.85	45.95	7.20	Average	150	5
2	5715.00	69.78	74.00	-4.22	62.58	7.20	Peak	150	5
3	5725.00	73.67	78.20	-4.53	66.43	7.24	Peak	150	5
4	11510.00	43.33	54.00	-10.67	26.43	16.90	Average	209	210
5	11510.00	55.72	74.00	-18.28	38.82	16.90	Peak	209	210
6	17265.00	46.71	54.00	-7.29	27.35	19.36	Average	347	276
7	17265.00	58.23	74.00	-15.77	38.87	19.36	Peak	347	276

Note 1: Emission Level (dBuV/m) = SA Reading (dBuV/m) + Factor\* (dB)

\*Factor includes antenna factor , cable loss and amplifier gain

Note 2: Margin (dB) = Emission level (dBuV/m) – Limit (dBuV/m).

<b>Modulation</b>	HT40	<b>Test Freq. (MHz)</b>	5755
<b>Polarization</b>	Vertical	<b>Test Configuration</b>	2

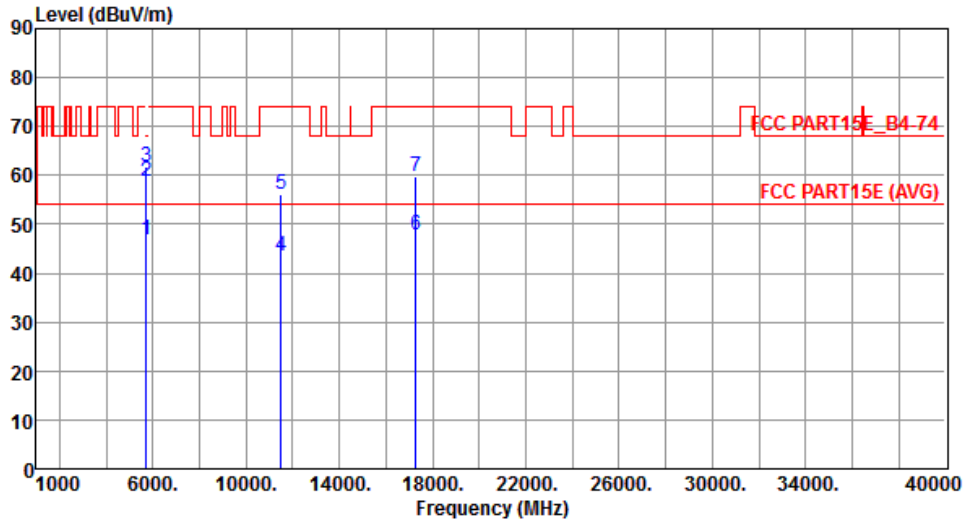

	Freq. MHz	Emission level dBuV/m	Limit dBuV/m	Margin dB	SA reading dBuV	Factor dB	Remark	ANT High cm	Turn Table deg
1	5715.00	46.81	54.00	-7.19	39.61	7.20	Average	150	27
2	5715.00	58.81	74.00	-15.19	51.61	7.20	Peak	150	27
3	5725.00	61.94	78.20	-16.26	54.70	7.24	Peak	150	27
4	11510.00	43.65	54.00	-10.35	26.75	16.90	Average	168	208
5	11510.00	56.10	74.00	-17.90	39.20	16.90	Peak	168	208
6	17265.00	47.96	54.00	-6.04	28.60	19.36	Average	327	291
7	17265.00	59.66	74.00	-14.34	40.30	19.36	Peak	327	291

Note 1: Emission Level (dBuV/m) = SA Reading (dBuV/m) + Factor\* (dB)

\*Factor includes antenna factor , cable loss and amplifier gain

Note 2: Margin (dB) = Emission level (dBuV/m) – Limit (dBuV/m).

<b>Modulation</b>	HT40	<b>Test Freq. (MHz)</b>	5795
<b>Polarization</b>	Horizontal	<b>Test Configuration</b>	2

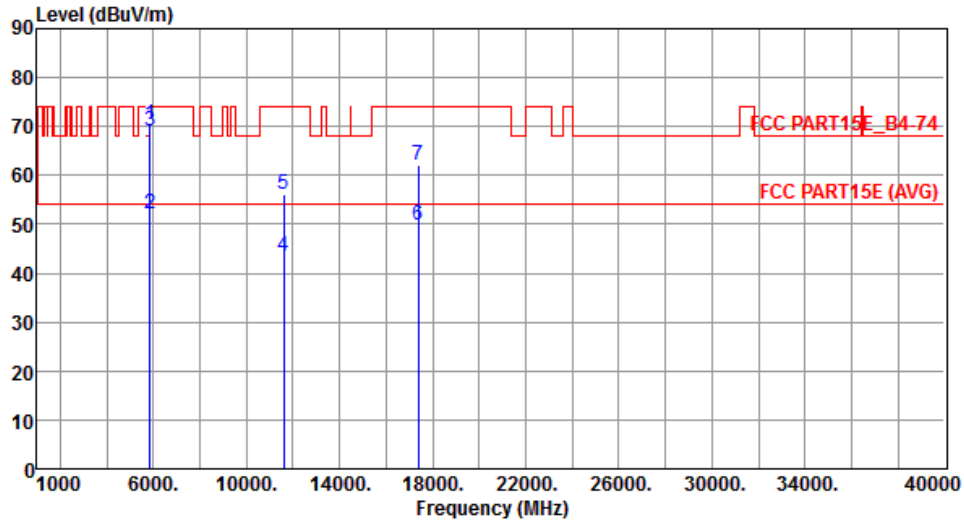

	Freq. MHz	Emission level dBuV/m	Limit dBuV/m	Margin dB	SA reading dBuV	Factor dB	Remark	ANT High cm	Turn Table deg
1	5850.00	70.46	78.20	-7.74	62.96	7.50	Peak	150	18
2	5860.00	52.19	54.00	-1.81	44.68	7.51	Average	150	18
3	5860.00	69.01	74.00	-4.99	61.50	7.51	Peak	150	18
4	11590.00	43.41	54.00	-10.59	26.65	16.76	Average	209	118
5	11590.00	56.15	74.00	-17.85	39.39	16.76	Peak	209	118
6	17385.00	49.80	54.00	-4.20	30.26	19.54	Average	150	7
7	17385.00	62.22	74.00	-11.78	42.68	19.54	Peak	150	7

Note 1: Emission Level (dBuV/m) = SA Reading (dBuV/m) + Factor\* (dB)

\*Factor includes antenna factor , cable loss and amplifier gain

Note 2: Margin (dB) = Emission level (dBuV/m) – Limit (dBuV/m).

<b>Modulation</b>	HT40	<b>Test Freq. (MHz)</b>	5795
<b>Polarization</b>	Vertical	<b>Test Configuration</b>	2

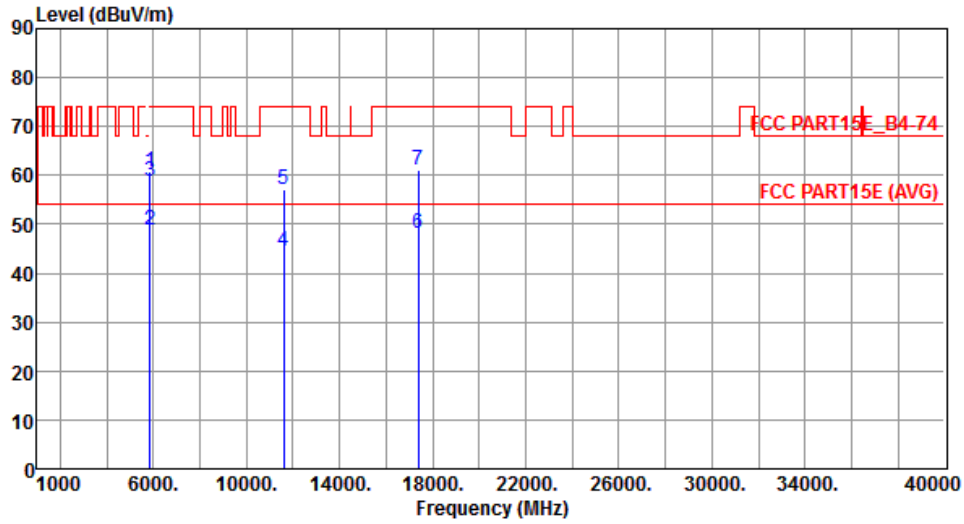

	Freq. MHz	Emission level dBuV/m	Limit dBuV/m	Margin dB	SA reading dBuV	Factor dB	Remark	ANT High cm	Turn Table deg
1	5850.00	60.90	78.20	-17.30	53.40	7.50	Peak	150	162
2	5860.00	48.83	54.00	-5.17	41.32	7.51	Average	150	162
3	5860.00	58.91	74.00	-15.09	51.40	7.51	Peak	150	162
4	11590.00	44.36	54.00	-9.64	27.60	16.76	Average	341	290
5	11590.00	57.15	74.00	-16.85	40.39	16.76	Peak	341	290
6	17385.00	48.17	54.00	-5.83	28.63	19.54	Average	251	190
7	17385.00	61.17	74.00	-12.83	41.63	19.54	Peak	251	190

Note 1: Emission Level (dBuV/m) = SA Reading (dBuV/m) + Factor\* (dB)

\*Factor includes antenna factor , cable loss and amplifier gain

Note 2: Margin (dB) = Emission level (dBuV/m) – Limit (dBuV/m).

### Test Configuration 3: Isolated Magnetic Dipole antenna

#### 3.5.12 Transmitter Radiated Unwanted Emissions (Below 1GHz)

<b>Modulation</b>	HT40	<b>Test Freq. (MHz)</b>	5590
<b>Polarization</b>	Horizontal	<b>Test Configuration</b>	3

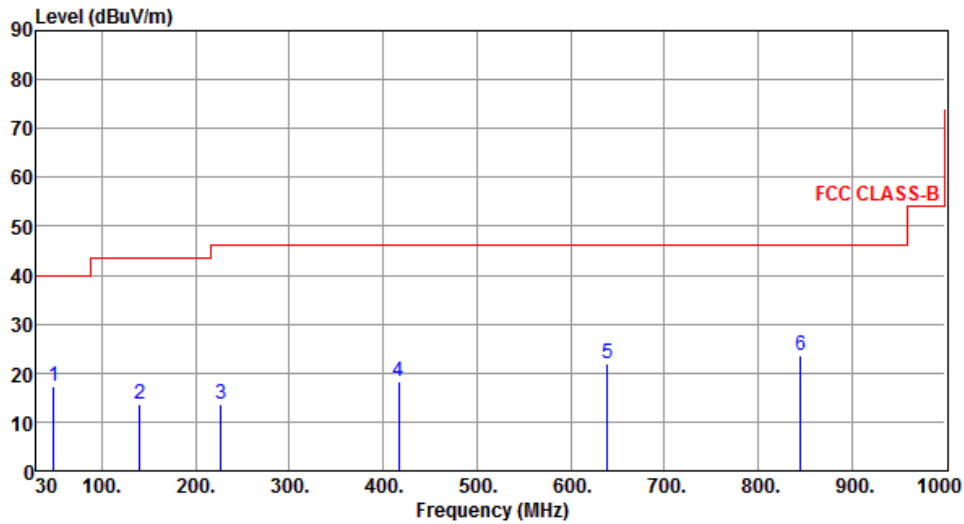

	Freq. MHz	Emission level dBuV/m	Limit dBuV/m	Margin dB	SA reading dBuV	Factor dB	Remark	ANT High cm	Turn Table deg
1	48.43	17.27	40.00	-22.73	30.18	-12.91	Peak	---	---
2	140.58	13.62	43.50	-29.88	27.35	-13.73	Peak	---	---
3	226.91	13.75	46.00	-32.25	29.31	-15.56	Peak	---	---
4	417.03	18.12	46.00	-27.88	27.73	-9.61	Peak	---	---
5	639.16	21.93	46.00	-24.07	27.16	-5.23	Peak	---	---
6	845.77	23.64	46.00	-22.36	25.51	-1.87	Peak	---	---

Note 1: Emission Level (dBuV/m) = SA Reading (dBuV/m) + Factor\* (dB)

\*Factor includes antenna factor , cable loss and amplifier gain

Note 2: Margin (dB) = Emission level (dBuV/m) – Limit (dBuV/m).

Note 3: All spurious emissions below 30MHz are more than 20 dB below the limit.

<b>Modulation</b>	HT40	<b>Test Freq. (MHz)</b>	5590
<b>Polarization</b>	Vertical	<b>Test Configuration</b>	3

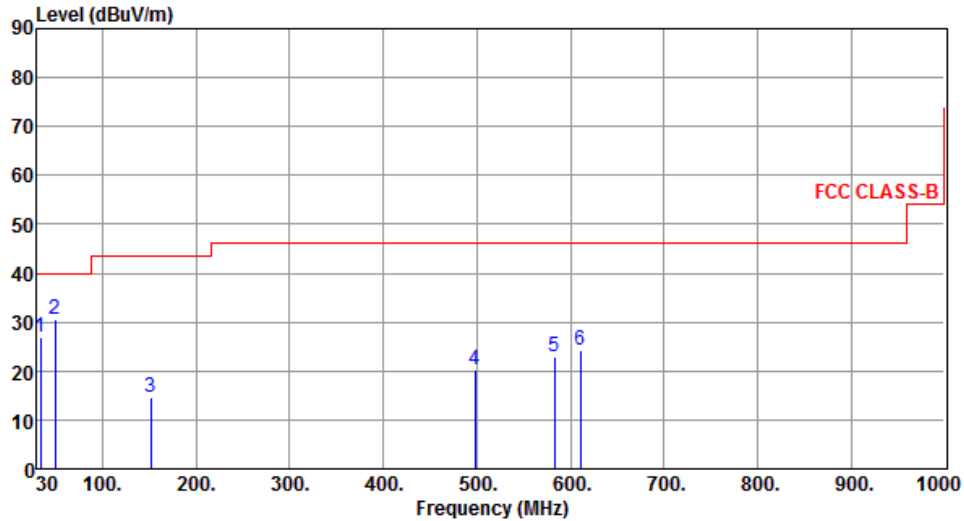

	Freq. MHz	Emission level dBuV/m	Limit dBuV/m	Margin dB	SA reading dBuV	Factor dB	Remark	ANT High cm	Turn Table deg
1	33.88	26.93	40.00	-13.07	40.42	-13.49	Peak	---	---
2	49.40	30.57	40.00	-9.43	43.51	-12.94	Peak	---	---
3	151.25	14.73	43.50	-28.77	28.19	-13.46	Peak	---	---
4	498.51	20.31	46.00	-25.69	28.00	-7.69	Peak	---	---
5	582.90	22.84	46.00	-23.16	29.09	-6.25	Peak	---	---
6	611.03	24.27	46.00	-21.73	29.90	-5.63	Peak	---	---

Note 1: Emission Level (dBuV/m) = SA Reading (dBuV/m) + Factor\* (dB)

\*Factor includes antenna factor , cable loss and amplifier gain

Note 2: Margin (dB) = Emission level (dBuV/m) – Limit (dBuV/m).

Note 3: All spurious emissions below 30MHz are more than 20 dB below the limit.

<b>Modulation</b>	HT40	<b>Test Freq. (MHz)</b>	5795
<b>Polarization</b>	Horizontal	<b>Test Configuration</b>	3

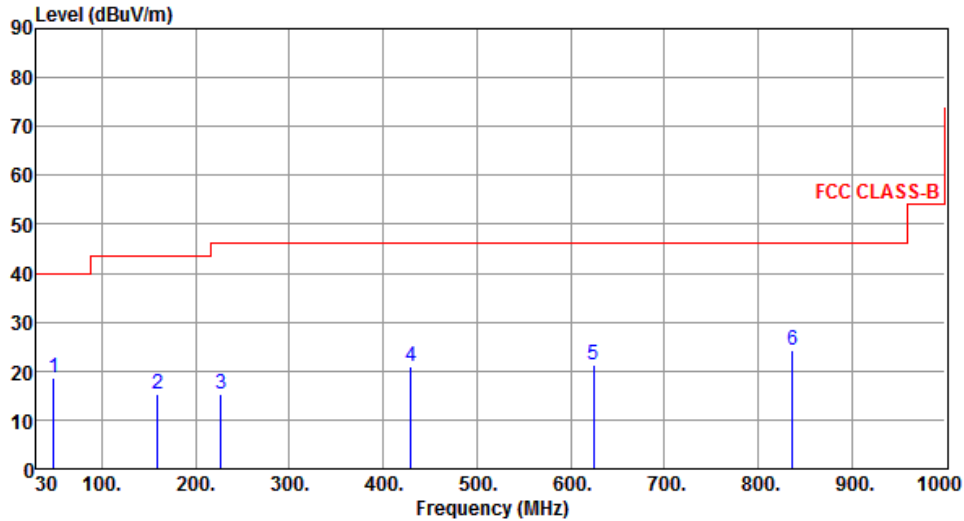

	Freq. MHz	Emission level dBuV/m	Limit dBuV/m	Margin dB	SA reading dBuV	Factor dB	Remark	ANT High cm	Turn Table deg
1	48.43	18.53	40.00	-21.47	31.44	-12.91	Peak	---	---
2	159.01	15.29	43.50	-28.21	28.89	-13.60	Peak	---	---
3	226.91	15.20	46.00	-30.80	30.76	-15.56	Peak	---	---
4	429.64	20.99	46.00	-25.01	30.28	-9.29	Peak	---	---
5	624.61	21.37	46.00	-24.63	26.81	-5.44	Peak	---	---
6	837.04	24.17	46.00	-21.83	26.19	-2.02	Peak	---	---

Note 1: Emission Level (dBuV/m) = SA Reading (dBuV/m) + Factor\* (dB)

\*Factor includes antenna factor , cable loss and amplifier gain

Note 2: Margin (dB) = Emission level (dBuV/m) – Limit (dBuV/m).

Note 3: All spurious emissions below 30MHz are more than 20 dB below the limit.



<b>Modulation</b>	HT40	<b>Test Freq. (MHz)</b>	5795
<b>Polarization</b>	Vertical	<b>Test Configuration</b>	3

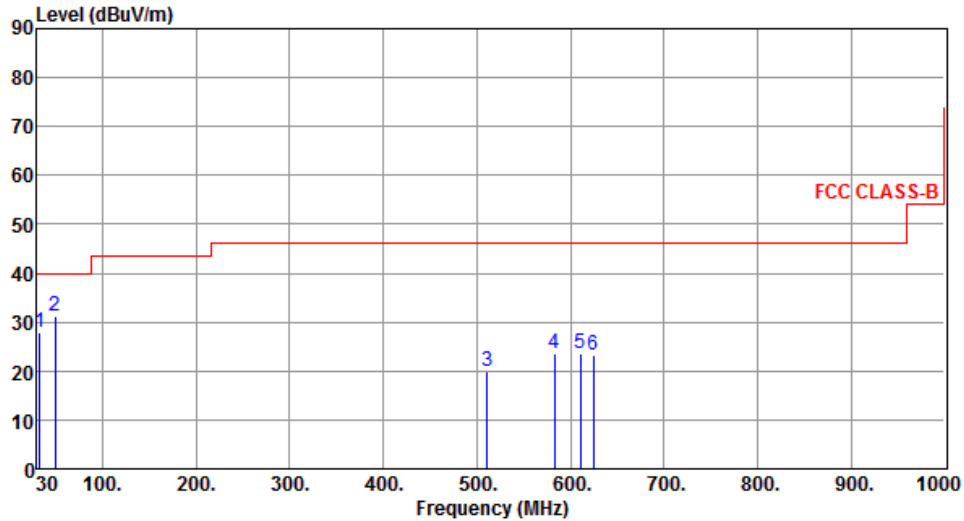

	Freq. MHz	Emission level dBuV/m	Limit dBuV/m	Margin dB	SA reading dBuV	Factor dB	Remark	ANT High cm	Turn Table deg
1	32.91	27.81	40.00	-12.19	41.31	-13.50	Peak	---	---
2	49.40	31.19	40.00	-8.81	44.13	-12.94	Peak	---	---
3	511.12	19.81	46.00	-26.19	27.35	-7.54	Peak	---	---
4	582.90	23.50	46.00	-22.50	29.75	-6.25	Peak	---	---
5	611.03	23.53	46.00	-22.47	29.16	-5.63	Peak	---	---
6	624.61	23.28	46.00	-22.72	28.72	-5.44	Peak	---	---

Note 1: Emission Level (dBuV/m) = SA Reading (dBuV/m) + Factor\* (dB)

\*Factor includes antenna factor , cable loss and amplifier gain

Note 2: Margin (dB) = Emission level (dBuV/m) – Limit (dBuV/m).

Note 3: All spurious emissions below 30MHz are more than 20 dB below the limit.

### 3.5.13 Transmitter Radiated Unwanted Emissions (Above 1GHz) for 11a

<b>Modulation</b>	11a	<b>Test Freq. (MHz)</b>	5180
<b>Polarization</b>	Horizontal	<b>Test Configuration</b>	3

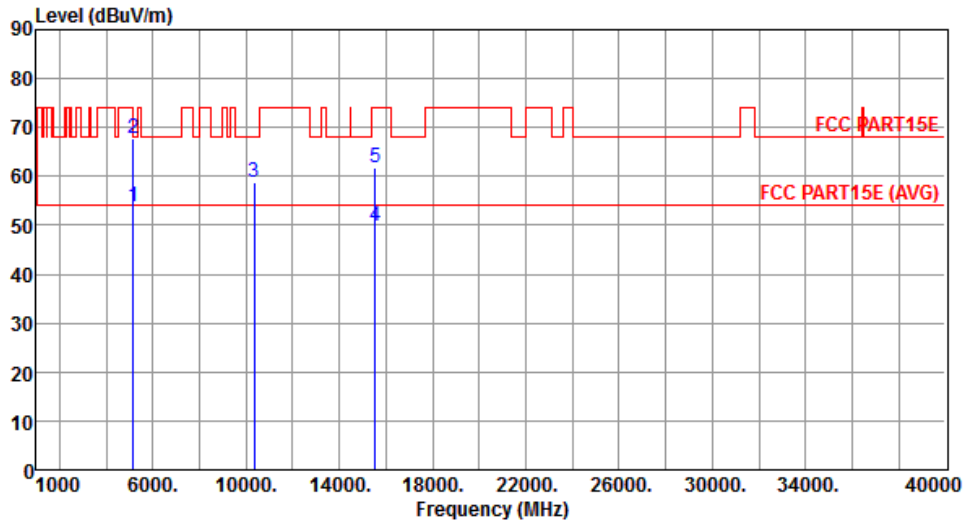

	Freq. MHz	Emission level dBuV/m	Limit dBuV/m	Margin dB	SA reading dBuV	Factor dB	Remark	ANT High cm	Turn Table deg
1	5150.00	53.84	54.00	-0.16	47.53	6.31	Average	251	223
2	5150.00	67.66	74.00	-6.34	61.35	6.31	Peak	251	223
3	10360.00	58.65	68.20	-9.55	42.31	16.34	Peak	261	189
4	15540.00	49.71	54.00	-4.29	32.21	17.50	Average	240	298
5	15540.00	61.94	74.00	-12.06	44.44	17.50	Peak	240	298

Note 1: Emission Level (dBuV/m) = SA Reading (dBuV/m) + Factor\* (dB)

\*Factor includes antenna factor , cable loss and amplifier gain

Note 2: Margin (dB) = Emission level (dBuV/m) – Limit (dBuV/m).

<b>Modulation</b>	11a	<b>Test Freq. (MHz)</b>	5180
<b>Polarization</b>	Vertical	<b>Test Configuration</b>	3

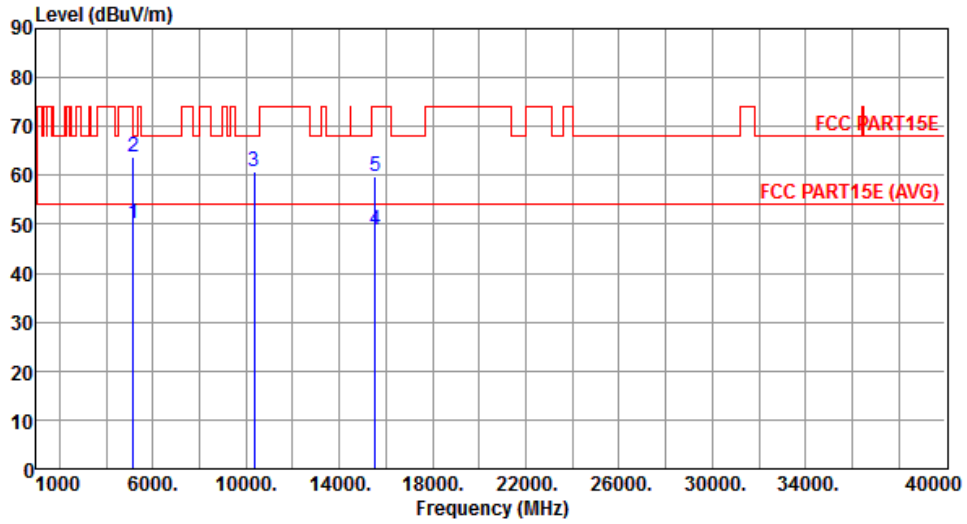

	Freq. MHz	Emission level dBuV/m	Limit dBuV/m	Margin dB	SA reading dBuV	Factor dB	Remark	ANT High cm	Turn Table deg
1	5150.00	49.99	54.00	-4.01	43.68	6.31	Average	290	241
2	5150.00	63.76	74.00	-10.24	57.45	6.31	Peak	290	241
3	10360.00	60.71	68.20	-7.49	44.37	16.34	Peak	371	19
4	15540.00	48.79	54.00	-5.21	31.29	17.50	Average	270	91
5	15540.00	59.85	74.00	-14.15	42.35	17.50	Peak	270	91

Note 1: Emission Level (dBuV/m) = SA Reading (dBuV/m) + Factor\* (dB)

\*Factor includes antenna factor , cable loss and amplifier gain

Note 2: Margin (dB) = Emission level (dBuV/m) – Limit (dBuV/m).

<b>Modulation</b>	11a	<b>Test Freq. (MHz)</b>	5200
<b>Polarization</b>	Horizontal	<b>Test Configuration</b>	3

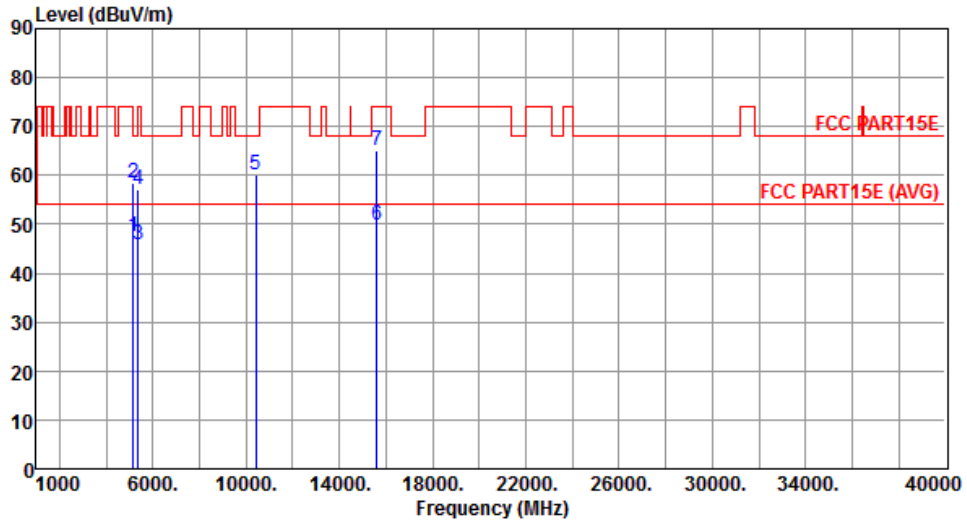

	Freq. MHz	Emission level dBuV/m	Limit dBuV/m	Margin dB	SA reading dBuV	Factor dB	Remark	ANT High cm	Turn Table deg
1	5150.00	47.36	54.00	-6.64	41.05	6.31	Average	223	240
2	5150.00	58.56	74.00	-15.44	52.25	6.31	Peak	223	240
3	5350.00	45.77	54.00	-8.23	39.15	6.62	Average	223	240
4	5350.00	56.97	74.00	-17.03	50.35	6.62	Peak	223	240
5	10400.00	60.26	68.20	-7.94	43.84	16.42	Peak	261	0
6	15600.00	49.95	54.00	-4.05	32.57	17.38	Average	305	300
7	15600.00	64.97	74.00	-9.03	47.59	17.38	Peak	305	300

Note 1: Emission Level (dBuV/m) = SA Reading (dBuV/m) + Factor\* (dB)

\*Factor includes antenna factor , cable loss and amplifier gain

Note 2: Margin (dB) = Emission level (dBuV/m) – Limit (dBuV/m).

<b>Modulation</b>	11a	<b>Test Freq. (MHz)</b>	5200
<b>Polarization</b>	Vertical	<b>Test Configuration</b>	3

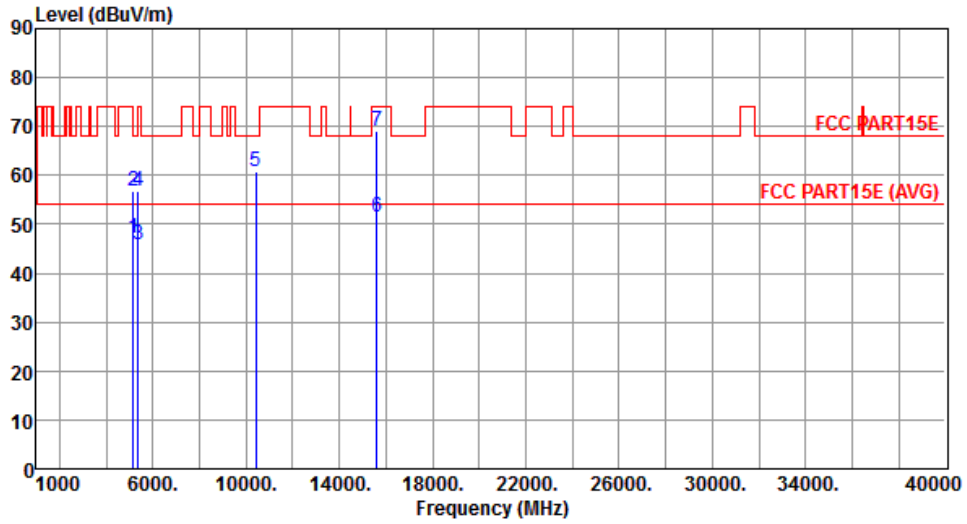

	Freq. MHz	Emission level dBuV/m	Limit dBuV/m	Margin dB	SA reading dBuV	Factor dB	Remark	ANT High cm	Turn Table deg
1	5150.00	47.16	54.00	-6.84	40.85	6.31	Average	290	235
2	5150.00	56.70	74.00	-17.30	50.39	6.31	Peak	290	235
3	5350.00	45.78	54.00	-8.22	39.16	6.62	Average	290	235
4	5350.00	56.91	74.00	-17.09	50.29	6.62	Peak	290	235
5	10400.00	60.86	68.20	-7.34	44.44	16.42	Peak	325	18
6	15600.00	51.35	54.00	-2.65	33.97	17.38	Average	114	0
7	15600.00	69.01	74.00	-4.99	51.63	17.38	Peak	114	0

Note 1: Emission Level (dBuV/m) = SA Reading (dBuV/m) + Factor\* (dB)

\*Factor includes antenna factor , cable loss and amplifier gain

Note 2: Margin (dB) = Emission level (dBuV/m) – Limit (dBuV/m).

<b>Modulation</b>	11a	<b>Test Freq. (MHz)</b>	5240
<b>Polarization</b>	Horizontal	<b>Test Configuration</b>	3

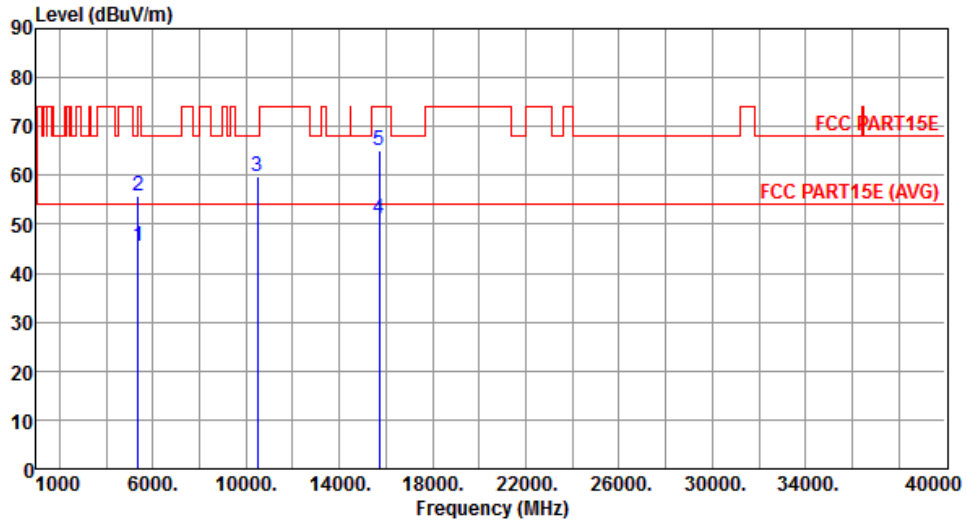

	Freq. MHz	Emission level dBuV/m	Limit dBuV/m	Margin dB	SA reading dBuV	Factor dB	Remark	ANT High cm	Turn Table deg
1	5350.00	45.51	54.00	-8.49	38.89	6.62	Average	171	220
2	5350.00	55.90	74.00	-18.10	49.28	6.62	Peak	171	220
3	10480.00	59.82	68.20	-8.38	43.26	16.56	Peak	295	349
4	15720.00	51.05	54.00	-2.95	33.90	17.15	Average	306	301
5	15720.00	65.22	74.00	-8.78	48.07	17.15	Peak	306	301

Note 1: Emission Level (dBuV/m) = SA Reading (dBuV/m) + Factor\* (dB)

\*Factor includes antenna factor , cable loss and amplifier gain

Note 2: Margin (dB) = Emission level (dBuV/m) – Limit (dBuV/m).

<b>Modulation</b>	11a	<b>Test Freq. (MHz)</b>	5240
<b>Polarization</b>	Vertical	<b>Test Configuration</b>	3

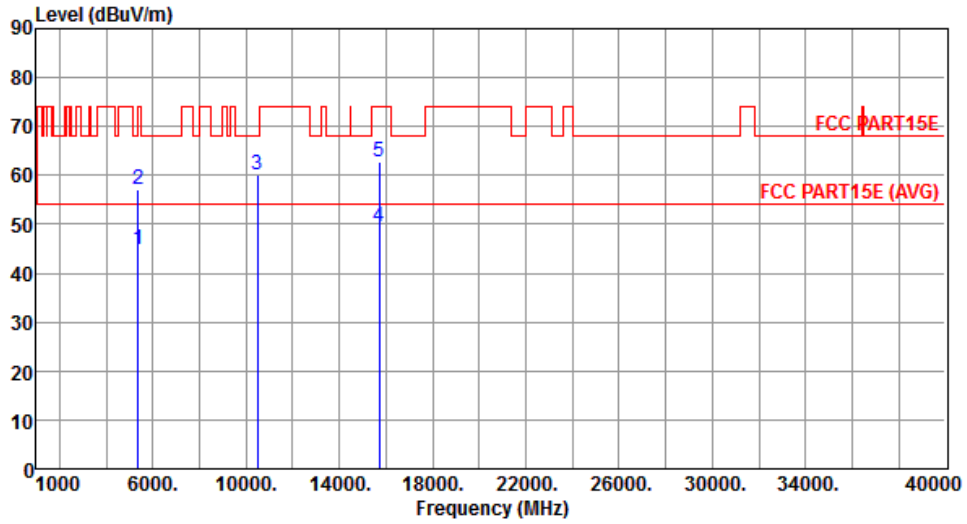

	Freq. MHz	Emission level dBuV/m	Limit dBuV/m	Margin dB	SA reading dBuV	Factor dB	Remark	ANT High cm	Turn Table deg
1	5350.00	44.88	54.00	-9.12	38.26	6.62	Average	296	236
2	5350.00	57.22	74.00	-16.78	50.60	6.62	Peak	296	236
3	10480.00	60.25	68.20	-7.95	43.69	16.56	Peak	328	352
4	15720.00	49.42	54.00	-4.58	32.27	17.15	Average	100	354
5	15720.00	62.69	74.00	-11.31	45.54	17.15	Peak	100	354

Note 1: Emission Level (dBuV/m) = SA Reading (dBuV/m) + Factor\* (dB)

\*Factor includes antenna factor , cable loss and amplifier gain

Note 2: Margin (dB) = Emission level (dBuV/m) – Limit (dBuV/m).

<b>Modulation</b>	11a	<b>Test Freq. (MHz)</b>	5260
<b>Polarization</b>	Horizontal	<b>Test Configuration</b>	3

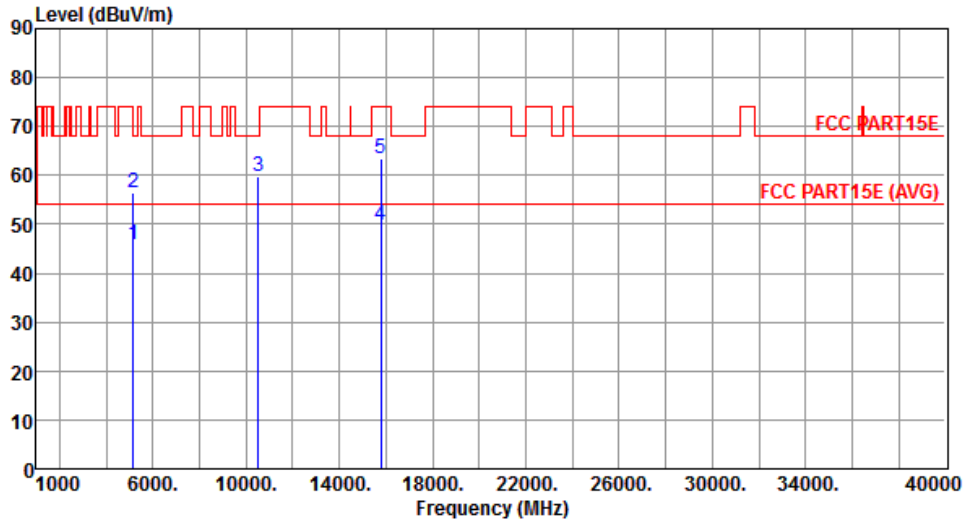

	Freq. MHz	Emission level dBuV/m	Limit dBuV/m	Margin dB	SA reading dBuV	Factor dB	Remark	ANT High cm	Turn Table deg
1	5150.00	45.77	54.00	-8.23	39.46	6.31	Average	223	221
2	5150.00	56.45	74.00	-17.55	50.14	6.31	Peak	223	221
3	10520.00	59.86	68.20	-8.34	43.26	16.60	Peak	261	55
4	15780.00	49.84	54.00	-4.16	32.79	17.05	Average	300	305
5	15780.00	63.32	74.00	-10.68	46.27	17.05	Peak	300	305

Note 1: Emission Level (dBuV/m) = SA Reading (dBuV/m) + Factor\* (dB)

\*Factor includes antenna factor , cable loss and amplifier gain

Note 2: Margin (dB) = Emission level (dBuV/m) – Limit (dBuV/m).



<b>Modulation</b>	11a	<b>Test Freq. (MHz)</b>	5260
<b>Polarization</b>	Vertical	<b>Test Configuration</b>	3

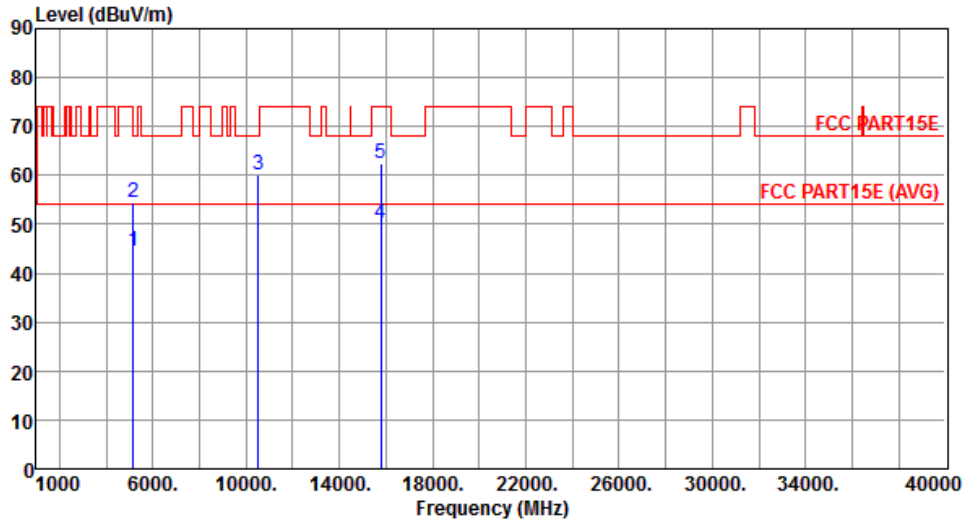

	Freq. MHz	Emission level dBuV/m	Limit dBuV/m	Margin dB	SA reading dBuV	Factor dB	Remark	ANT High cm	Turn Table deg
1	5150.00	44.56	54.00	-9.44	38.25	6.31	Average	294	239
2	5150.00	54.56	74.00	-19.44	48.25	6.31	Peak	294	239
3	10520.00	60.20	68.20	-8.00	43.60	16.60	Peak	267	113
4	15780.00	50.30	54.00	-3.70	33.25	17.05	Average	100	353
5	15780.00	62.30	74.00	-11.70	45.25	17.05	Peak	100	353

Note 1: Emission Level (dBuV/m) = SA Reading (dBuV/m) + Factor\* (dB)

\*Factor includes antenna factor , cable loss and amplifier gain

Note 2: Margin (dB) = Emission level (dBuV/m) – Limit (dBuV/m).

<b>Modulation</b>	11a	<b>Test Freq. (MHz)</b>	5300
<b>Polarization</b>	Horizontal	<b>Test Configuration</b>	3

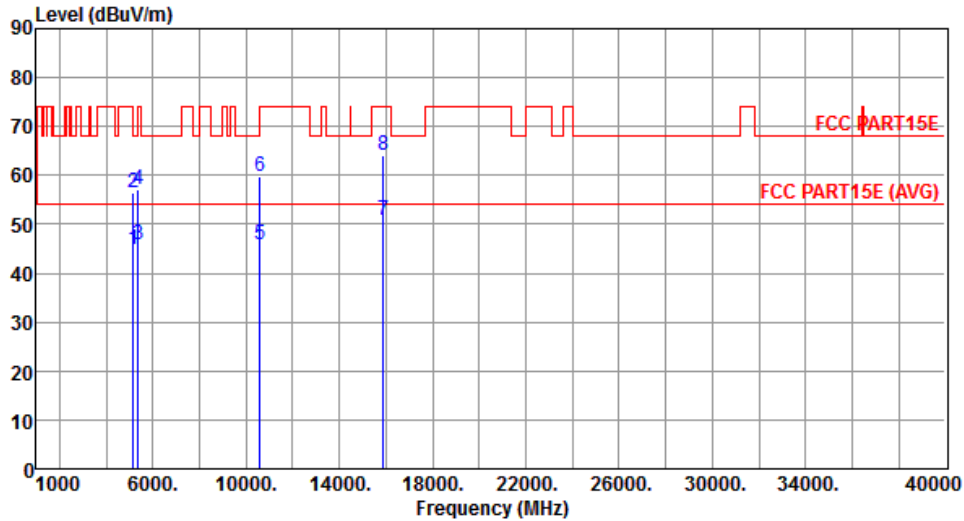

	Freq. MHz	Emission level dBuV/m	Limit dBuV/m	Margin dB	SA reading dBuV	Factor dB	Remark	ANT High cm	Turn Table deg
1	5150.00	44.92	54.00	-9.08	38.61	6.31	Average	217	222
2	5150.00	56.44	74.00	-17.56	50.13	6.31	Peak	217	222
3	5350.00	45.67	54.00	-8.33	39.05	6.62	Average	217	222
4	5350.00	57.11	74.00	-16.89	50.49	6.62	Peak	217	222
5	10600.00	45.98	54.00	-8.02	29.36	16.62	Average	296	0
6	10600.00	59.88	74.00	-14.12	43.26	16.62	Peak	296	0
7	15900.00	50.88	54.00	-3.12	34.06	16.82	Average	304	304
8	15900.00	64.25	74.00	-9.75	47.43	16.82	Peak	304	304

Note 1: Emission Level (dBuV/m) = SA Reading (dBuV/m) + Factor\* (dB)

\*Factor includes antenna factor , cable loss and amplifier gain

Note 2: Margin (dB) = Emission level (dBuV/m) – Limit (dBuV/m).

<b>Modulation</b>	11a	<b>Test Freq. (MHz)</b>	5300
<b>Polarization</b>	Vertical	<b>Test Configuration</b>	3

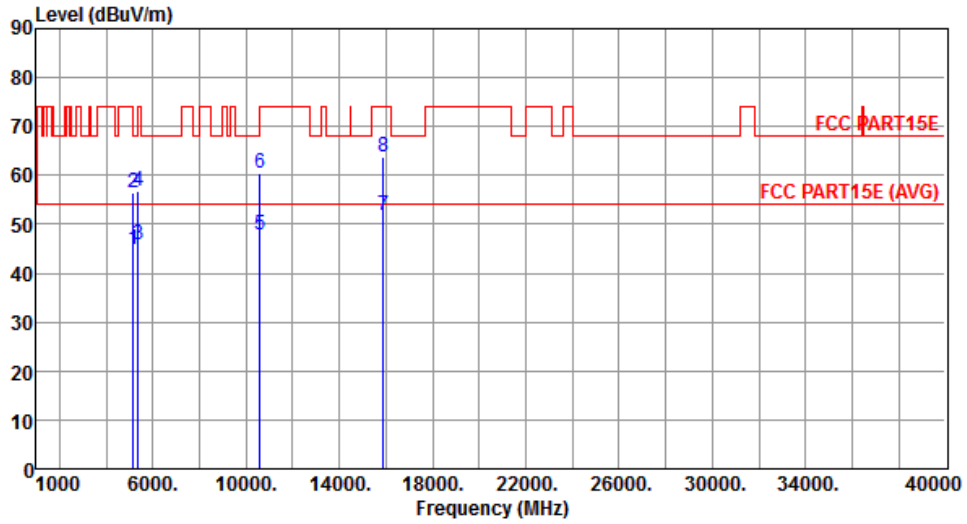

	Freq. MHz	Emission level dBuV/m	Limit dBuV/m	Margin dB	SA reading dBuV	Factor dB	Remark	ANT High cm	Turn Table deg
1	5150.00	44.98	54.00	-9.02	38.67	6.31	Average	295	237
2	5150.00	56.56	74.00	-17.44	50.25	6.31	Peak	295	237
3	5350.00	45.79	54.00	-8.21	39.17	6.62	Average	295	237
4	5350.00	56.88	74.00	-17.12	50.26	6.62	Peak	295	237
5	10600.00	47.88	54.00	-6.12	31.26	16.62	Average	305	358
6	10600.00	60.49	74.00	-13.51	43.87	16.62	Peak	305	358
7	15900.00	51.71	54.00	-2.29	34.89	16.82	Average	100	355
8	15900.00	63.88	74.00	-10.12	47.06	16.82	Peak	100	355

Note 1: Emission Level (dBuV/m) = SA Reading (dBuV/m) + Factor\* (dB)

\*Factor includes antenna factor , cable loss and amplifier gain

Note 2: Margin (dB) = Emission level (dBuV/m) – Limit (dBuV/m).

<b>Modulation</b>	11a	<b>Test Freq. (MHz)</b>	5320
<b>Polarization</b>	Horizontal	<b>Test Configuration</b>	3

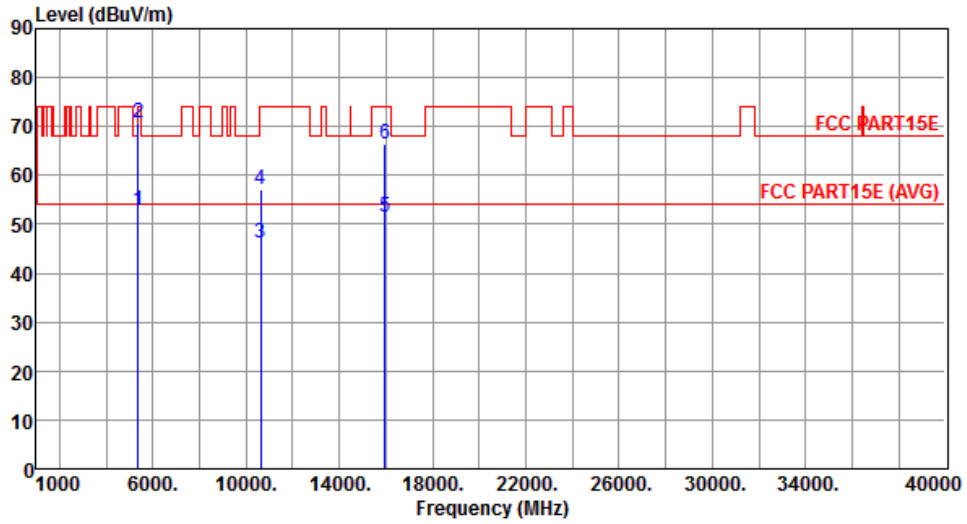

	Freq. MHz	Emission level dBuV/m	Limit dBuV/m	Margin dB	SA reading dBuV	Factor dB	Remark	ANT High cm	Turn Table deg
1	5350.00	52.75	54.00	-1.25	46.13	6.62	Average	216	222
2	5350.00	70.89	74.00	-3.11	64.27	6.62	Peak	216	222
3	10640.00	46.23	54.00	-7.77	29.60	16.63	Average	215	16
4	10640.00	57.13	74.00	-16.87	40.50	16.63	Peak	215	16
5	15960.00	51.61	54.00	-2.39	34.91	16.70	Average	219	353
6	15960.00	66.37	74.00	-7.63	49.67	16.70	Peak	219	353

Note 1: Emission Level (dBuV/m) = SA Reading (dBuV/m) + Factor\* (dB)

\*Factor includes antenna factor , cable loss and amplifier gain

Note 2: Margin (dB) = Emission level (dBuV/m) – Limit (dBuV/m).

<b>Modulation</b>	11a	<b>Test Freq. (MHz)</b>	5320
<b>Polarization</b>	Vertical	<b>Test Configuration</b>	3

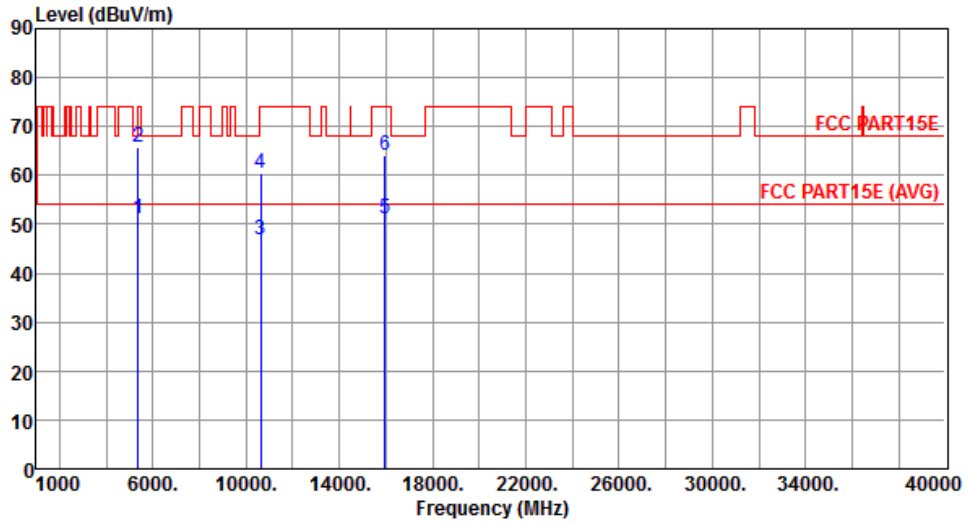

	Freq. MHz	Emission level dBuV/m	Limit dBuV/m	Margin dB	SA reading dBuV	Factor dB	Remark	ANT High cm	Turn Table deg
1	5350.00	50.98	54.00	-3.02	44.36	6.62	Average	293	94
2	5350.00	65.88	74.00	-8.12	59.26	6.62	Peak	293	94
3	10640.00	46.92	54.00	-7.08	30.29	16.63	Average	398	20
4	10640.00	60.33	74.00	-13.67	43.70	16.63	Peak	398	20
5	15960.00	51.16	54.00	-2.84	34.46	16.70	Average	121	353
6	15960.00	64.16	74.00	-9.84	47.46	16.70	Peak	121	353

Note 1: Emission Level (dBuV/m) = SA Reading (dBuV/m) + Factor\* (dB)

\*Factor includes antenna factor , cable loss and amplifier gain

Note 2: Margin (dB) = Emission level (dBuV/m) – Limit (dBuV/m).

<b>Modulation</b>	11a	<b>Test Freq. (MHz)</b>	5500
<b>Polarization</b>	Horizontal	<b>Test Configuration</b>	3

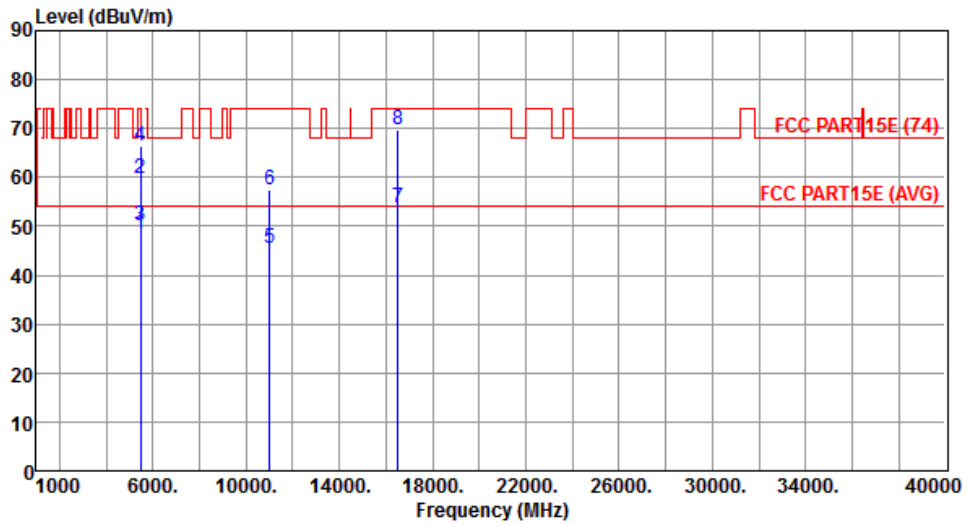

	Freq. MHz	Emission level dBuV/m	Limit dBuV/m	Margin dB	SA reading dBuV	Factor dB	Remark	ANT High cm	Turn Table deg
1	5460.00	48.41	54.00	-5.59	41.65	6.76	Average	285	232
2	5460.00	59.92	74.00	-14.08	53.16	6.76	Peak	285	232
3	5470.00	50.02	54.00	-3.98	43.25	6.77	Average	285	232
4	5470.00	66.45	74.00	-7.55	59.68	6.77	Peak	285	232
5	11000.00	45.38	54.00	-8.62	28.66	16.72	Average	248	22
6	11000.00	57.47	74.00	-16.53	40.75	16.72	Peak	248	22
7	16500.00	53.80	54.00	-0.20	35.93	17.87	Average	236	0
8	16500.00	69.80	74.00	-4.20	51.93	17.87	Peak	236	0

Note 1: Emission Level (dBuV/m) = SA Reading (dBuV/m) + Factor\* (dB)

\*Factor includes antenna factor , cable loss and amplifier gain

Note 2: Margin (dB) = Emission level (dBuV/m) – Limit (dBuV/m).

<b>Modulation</b>	11a	<b>Test Freq. (MHz)</b>	5500
<b>Polarization</b>	Vertical	<b>Test Configuration</b>	3

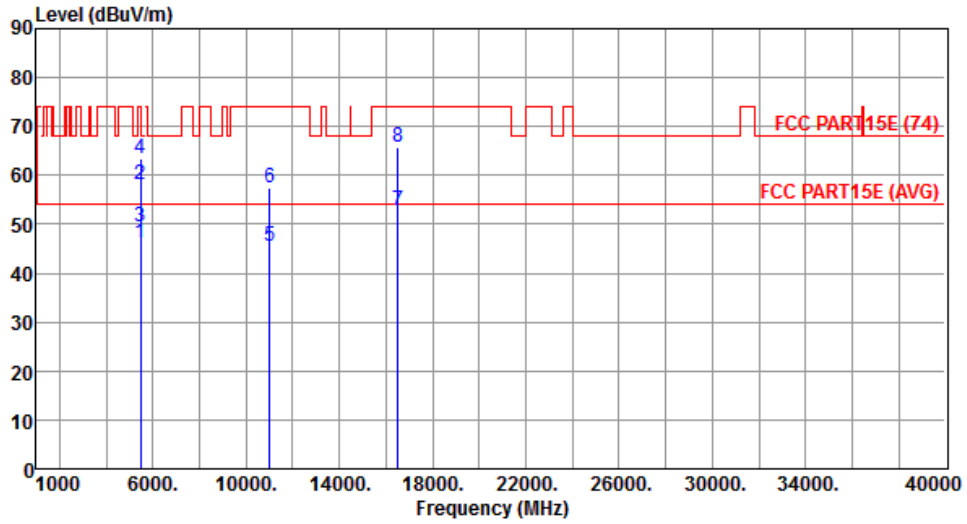

	Freq. MHz	Emission level dBuV/m	Limit dBuV/m	Margin dB	SA reading dBuV	Factor dB	Remark	ANT High cm	Turn Table deg
1	5460.00	46.06	54.00	-7.94	39.30	6.76	Average	216	230
2	5460.00	58.09	74.00	-15.91	51.33	6.76	Peak	216	230
3	5470.00	49.36	54.00	-4.64	42.59	6.77	Average	216	230
4	5470.00	63.29	74.00	-10.71	56.52	6.77	Peak	216	230
5	11000.00	45.64	54.00	-8.36	28.92	16.72	Average	206	82
6	11000.00	57.36	74.00	-16.64	40.64	16.72	Peak	206	82
7	16500.00	52.67	54.00	-1.33	34.80	17.87	Average	216	230
8	16500.00	65.77	74.00	-8.23	47.90	17.87	Peak	216	230

Note 1: Emission Level (dBuV/m) = SA Reading (dBuV/m) + Factor\* (dB)

\*Factor includes antenna factor , cable loss and amplifier gain

Note 2: Margin (dB) = Emission level (dBuV/m) – Limit (dBuV/m).

<b>Modulation</b>	11a	<b>Test Freq. (MHz)</b>	5580
<b>Polarization</b>	Horizontal	<b>Test Configuration</b>	3

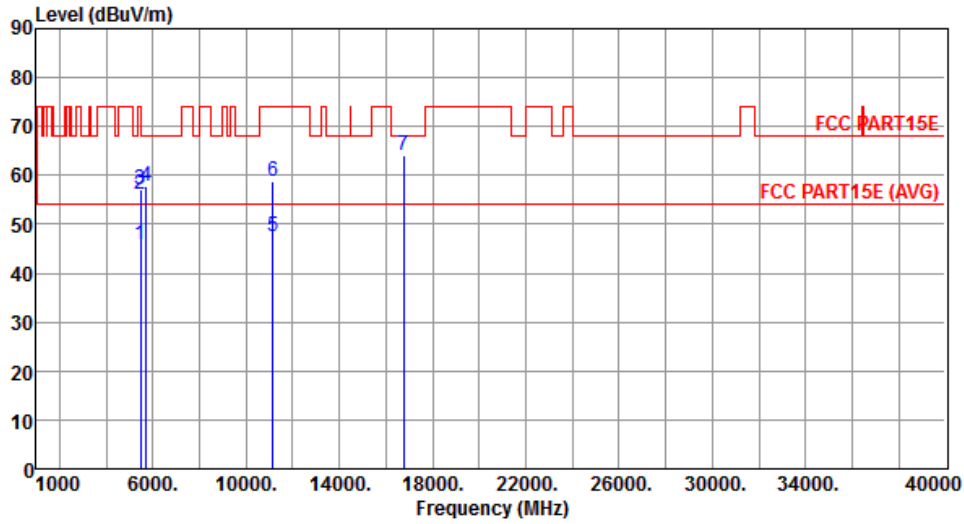

	Freq. MHz	Emission level dBuV/m	Limit dBuV/m	Margin dB	SA reading dBuV	Factor dB	Remark	ANT High cm	Turn Table deg
1	5460.00	45.69	54.00	-8.31	38.93	6.76	Average	278	232
2	5460.00	56.06	74.00	-17.94	49.30	6.76	Peak	278	232
3	5470.00	57.14	68.20	-11.06	50.37	6.77	Peak	278	232
4	5725.00	57.92	68.20	-10.28	50.68	7.24	Peak	278	232
5	11160.00	47.38	54.00	-6.62	30.59	16.79	Average	272	2
6	11160.00	58.85	74.00	-15.15	42.06	16.79	Peak	272	2
7	16740.00	64.00	68.20	-4.20	45.60	18.40	Peak	100	355

Note 1: Emission Level (dBuV/m) = SA Reading (dBuV/m) + Factor\* (dB)

\*Factor includes antenna factor , cable loss and amplifier gain

Note 2: Margin (dB) = Emission level (dBuV/m) – Limit (dBuV/m).



<b>Modulation</b>	11a	<b>Test Freq. (MHz)</b>	5580
<b>Polarization</b>	Vertical	<b>Test Configuration</b>	3

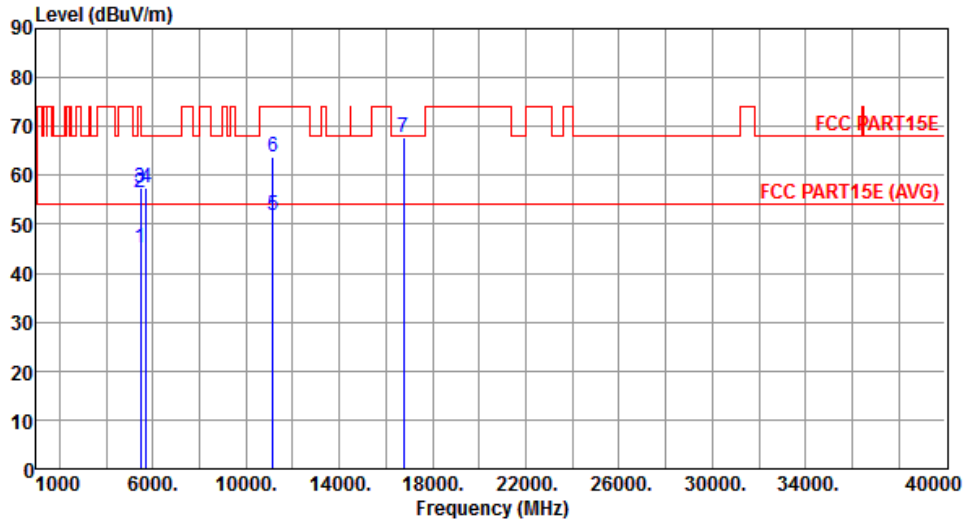

	Freq. MHz	Emission level dBuV/m	Limit dBuV/m	Margin dB	SA reading dBuV	Factor dB	Remark	ANT High cm	Turn Table deg
1	5460.00	45.01	54.00	-8.99	38.25	6.76	Average	216	235
2	5460.00	56.42	74.00	-17.58	49.66	6.76	Peak	216	235
3	5470.00	57.43	68.20	-10.77	50.66	6.77	Peak	216	235
4	5725.00	57.50	68.20	-10.70	50.26	7.24	Peak	216	235
5	11160.00	51.80	54.00	-2.20	35.01	16.79	Average	280	0
6	11160.00	63.84	74.00	-10.16	47.05	16.79	Peak	280	0
7	16740.00	67.80	68.20	-0.40	49.40	18.40	Peak	112	356

Note 1: Emission Level (dBuV/m) = SA Reading (dBuV/m) + Factor\* (dB)

\*Factor includes antenna factor , cable loss and amplifier gain

Note 2: Margin (dB) = Emission level (dBuV/m) – Limit (dBuV/m).

<b>Modulation</b>	11a	<b>Test Freq. (MHz)</b>	5700
<b>Polarization</b>	Horizontal	<b>Test Configuration</b>	3

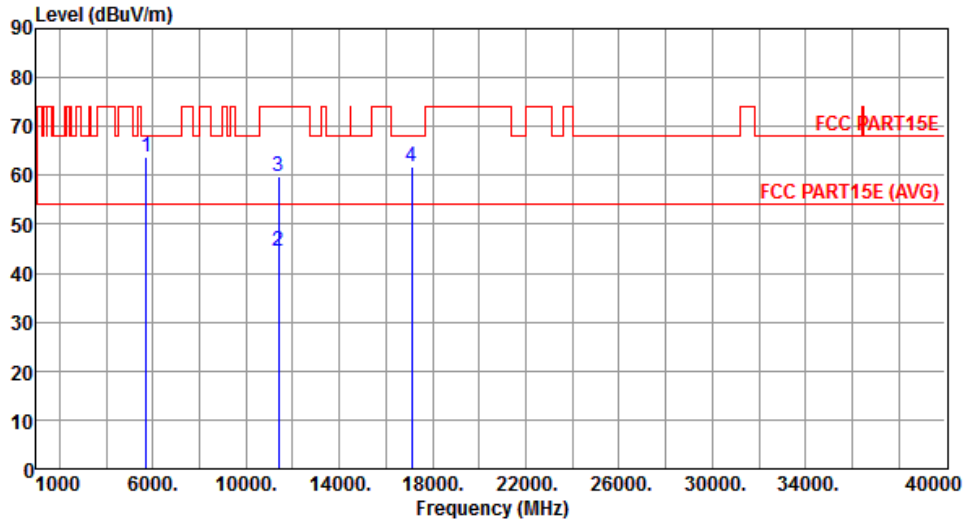

	Freq. MHz	Emission level dBuV/m	Limit dBuV/m	Margin dB	SA reading dBuV	Factor dB	Remark	ANT High cm	Turn Table deg
1	5725.00	63.64	68.20	-4.56	56.40	7.24	Peak	101	320
2	11400.00	44.58	54.00	-9.42	27.70	16.88	Average	272	17
3	11400.00	59.84	74.00	-14.16	42.96	16.88	Peak	272	17
4	17100.00	61.77	68.20	-6.43	42.65	19.12	Peak	236	26

Note 1: Emission Level (dBuV/m) = SA Reading (dBuV/m) + Factor\* (dB)

\*Factor includes antenna factor , cable loss and amplifier gain

Note 2: Margin (dB) = Emission level (dBuV/m) – Limit (dBuV/m).

<b>Modulation</b>	11a	<b>Test Freq. (MHz)</b>	5700
<b>Polarization</b>	Vertical	<b>Test Configuration</b>	3

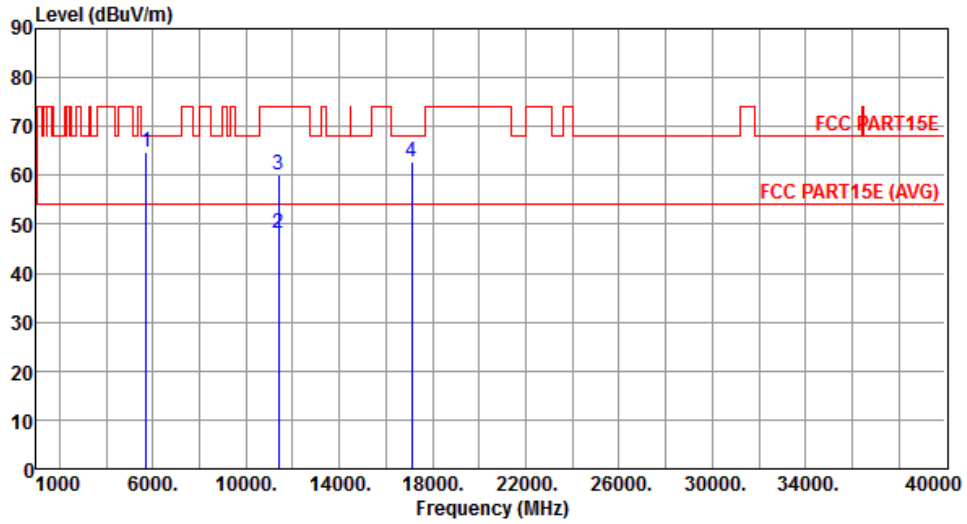

	Freq. MHz	Emission level dBuV/m	Limit dBuV/m	Margin dB	SA reading dBuV	Factor dB	Remark	ANT High cm	Turn Table deg
1	5725.00	64.84	68.20	-3.36	57.60	7.24	Peak	259	234
2	11400.00	48.18	54.00	-5.82	31.30	16.88	Average	280	2
3	11400.00	60.26	74.00	-13.74	43.38	16.88	Peak	280	2
4	17100.00	62.78	68.20	-5.42	43.66	19.12	Peak	100	359

Note 1: Emission Level (dBuV/m) = SA Reading (dBuV/m) + Factor\* (dB)

\*Factor includes antenna factor , cable loss and amplifier gain

Note 2: Margin (dB) = Emission level (dBuV/m) – Limit (dBuV/m).

<b>Modulation</b>	11a	<b>Test Freq. (MHz)</b>	5745
<b>Polarization</b>	Horizontal	<b>Test Configuration</b>	3

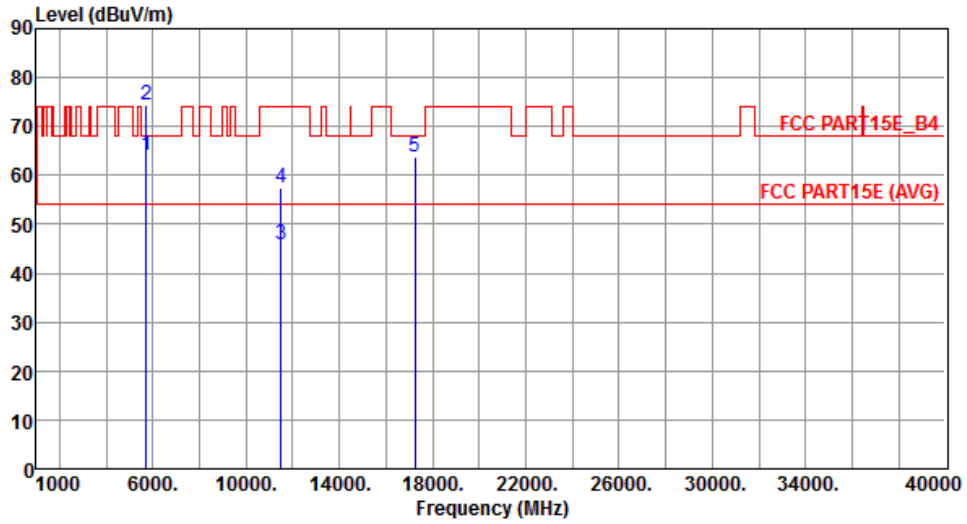

	Freq. MHz	Emission level dBuV/m	Limit dBuV/m	Margin dB	SA reading dBuV	Factor dB	Remark	ANT High cm	Turn Table deg
1	5715.00	64.11	68.20	-4.09	56.91	7.20	Peak	100	209
2	5725.00	74.39	78.20	-3.81	67.15	7.24	Peak	100	209
3	11490.00	45.72	54.00	-8.28	28.81	16.91	Average	296	3
4	11490.00	57.56	74.00	-16.44	40.65	16.91	Peak	296	3
5	17235.00	63.91	68.20	-4.29	44.59	19.32	Peak	262	339

Note 1: Emission Level (dBuV/m) = SA Reading (dBuV/m) + Factor\* (dB)

\*Factor includes antenna factor , cable loss and amplifier gain

Note 2: Margin (dB) = Emission level (dBuV/m) – Limit (dBuV/m).

<b>Modulation</b>	11a	<b>Test Freq. (MHz)</b>	5745
<b>Polarization</b>	Vertical	<b>Test Configuration</b>	3

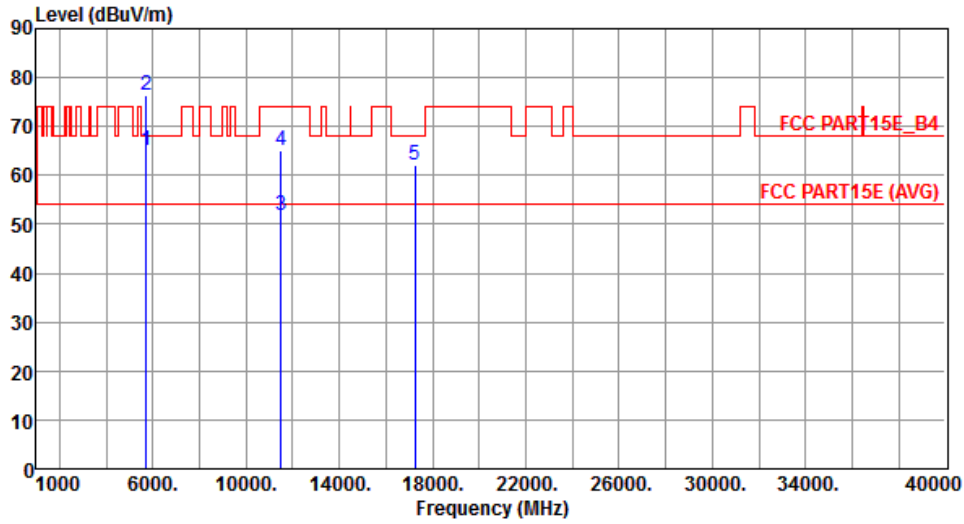

	Freq. MHz	Emission level dBuV/m	Limit dBuV/m	Margin dB	SA reading dBuV	Factor dB	Remark	ANT High cm	Turn Table deg
1	5715.00	64.97	68.20	-3.23	57.77	7.20	Peak	265	251
2	5725.00	76.54	78.20	-1.66	69.30	7.24	Peak	265	251
3	11490.00	51.77	54.00	-2.23	34.86	16.91	Average	235	11
4	11490.00	65.18	74.00	-8.82	48.27	16.91	Peak	235	11
5	17235.00	62.26	68.20	-5.94	42.94	19.32	Peak	113	358

Note 1: Emission Level (dBuV/m) = SA Reading (dBuV/m) + Factor\* (dB)

\*Factor includes antenna factor , cable loss and amplifier gain

Note 2: Margin (dB) = Emission level (dBuV/m) – Limit (dBuV/m).

<b>Modulation</b>	11a	<b>Test Freq. (MHz)</b>	5785
<b>Polarization</b>	Horizontal	<b>Test Configuration</b>	3

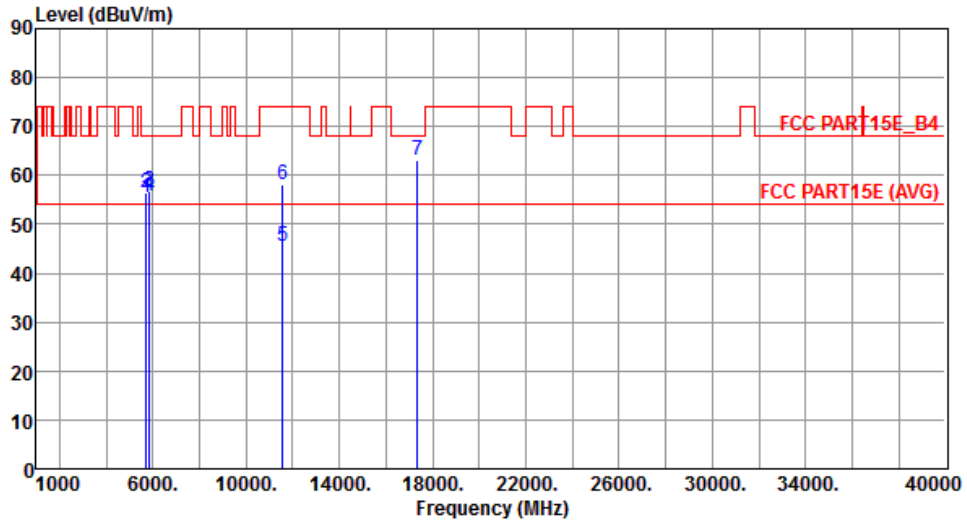

	Freq. MHz	Emission level dBuV/m	Limit dBuV/m	Margin dB	SA reading dBuV	Factor dB	Remark	ANT High cm	Turn Table deg
1	5715.00	55.59	68.20	-12.61	48.39	7.20	Peak	226	19
2	5725.00	56.50	78.20	-21.70	49.26	7.24	Peak	226	19
3	5850.00	56.88	78.20	-21.32	49.38	7.50	Peak	226	19
4	5860.00	55.88	68.20	-12.32	48.37	7.51	Peak	226	19
5	11570.00	45.46	54.00	-8.54	28.66	16.80	Average	248	215
6	11570.00	58.16	74.00	-15.84	41.36	16.80	Peak	248	215
7	17355.00	63.16	68.20	-5.04	43.67	19.49	Peak	262	339

Note 1: Emission Level (dBuV/m) = SA Reading (dBuV/m) + Factor\* (dB)

\*Factor includes antenna factor , cable loss and amplifier gain

Note 2: Margin (dB) = Emission level (dBuV/m) – Limit (dBuV/m).

<b>Modulation</b>	11a	<b>Test Freq. (MHz)</b>	5785
<b>Polarization</b>	Vertical	<b>Test Configuration</b>	3

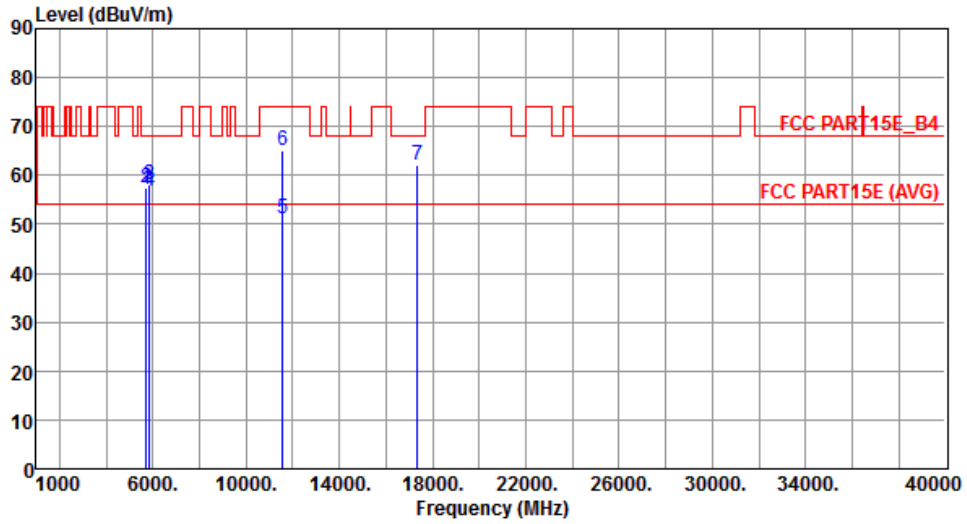

	Freq. MHz	Emission level dBuV/m	Limit dBuV/m	Margin dB	SA reading dBuV	Factor dB	Remark	ANT High cm	Turn Table deg
1	5715.00	57.09	68.20	-11.11	49.89	7.20	Peak	160	239
2	5725.00	57.50	78.20	-20.70	50.26	7.24	Peak	160	239
3	5850.00	58.13	78.20	-20.07	50.63	7.50	Peak	160	239
4	5860.00	56.82	68.20	-11.38	49.31	7.51	Peak	160	239
5	11570.00	51.11	54.00	-2.89	34.31	16.80	Average	275	0
6	11570.00	65.02	74.00	-8.98	48.22	16.80	Peak	275	0
7	17355.00	62.18	68.20	-6.02	42.69	19.49	Peak	100	353

Note 1: Emission Level (dBuV/m) = SA Reading (dBuV/m) + Factor\* (dB)

\*Factor includes antenna factor , cable loss and amplifier gain

Note 2: Margin (dB) = Emission level (dBuV/m) – Limit (dBuV/m).

<b>Modulation</b>	11a	<b>Test Freq. (MHz)</b>	5825
<b>Polarization</b>	Horizontal	<b>Test Configuration</b>	3

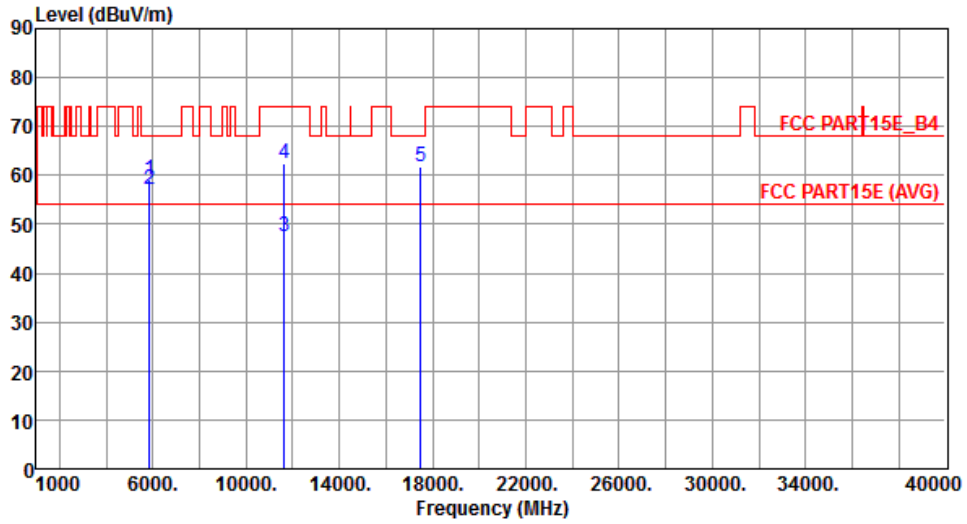

	Freq. MHz	Emission level dBuV/m	Limit dBuV/m	Margin dB	SA reading dBuV	Factor dB	Remark	ANT High cm	Turn Table deg
1	5850.00	59.10	78.20	-19.10	51.60	7.50	Peak	232	19
2	5860.00	57.17	68.20	-11.03	49.66	7.51	Peak	232	19
3	11650.00	47.62	54.00	-6.38	30.97	16.65	Average	234	210
4	11650.00	62.31	74.00	-11.69	45.66	16.65	Peak	234	210
5	17475.00	61.88	68.20	-6.32	42.22	19.66	Peak	262	339

Note 1: Emission Level (dBuV/m) = SA Reading (dBuV/m) + Factor\* (dB)

\*Factor includes antenna factor , cable loss and amplifier gain

Note 2: Margin (dB) = Emission level (dBuV/m) – Limit (dBuV/m).



<b>Modulation</b>	11a	<b>Test Freq. (MHz)</b>	5825
<b>Polarization</b>	Vertical	<b>Test Configuration</b>	3

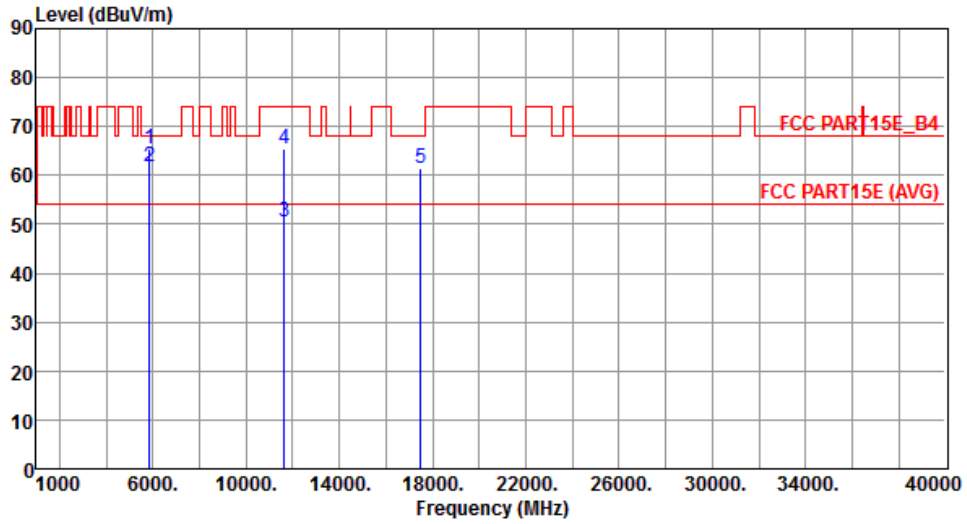

	Freq. MHz	Emission level dBuV/m	Limit dBuV/m	Margin dB	SA reading dBuV	Factor dB	Remark	ANT High cm	Turn Table deg
1	5850.00	65.49	78.20	-12.71	57.99	7.50	Peak	192	258
2	5860.00	61.82	68.20	-6.38	54.31	7.51	Peak	192	258
3	11650.00	50.50	54.00	-3.50	33.85	16.65	Average	249	157
4	11650.00	65.35	74.00	-8.65	48.70	16.65	Peak	249	157
5	17475.00	61.32	68.20	-6.88	41.66	19.66	Peak	115	358

Note 1: Emission Level (dBuV/m) = SA Reading (dBuV/m) + Factor\* (dB)

\*Factor includes antenna factor , cable loss and amplifier gain

Note 2: Margin (dB) = Emission level (dBuV/m) – Limit (dBuV/m).

### 3.5.14 Transmitter Radiated Unwanted Emissions (Above 1GHz) for HT20

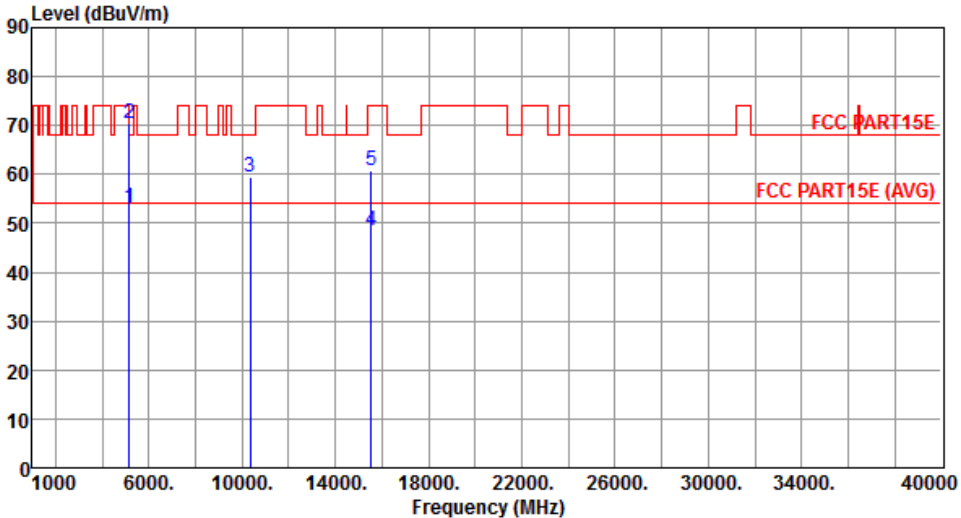
Modulation	HT20	Test Freq. (MHz)	5180																																																																					
Polarization	Horizontal	Test Configuration	3																																																																					
																																																																								
	<table border="1"> <thead> <tr> <th>Freq.</th> <th>Emission level</th> <th>Limit</th> <th>Margin</th> <th>SA reading</th> <th>Factor</th> <th>Remark</th> <th>ANT High</th> <th>Turn Table</th> </tr> <tr> <th>MHz</th> <th>dBuV/m</th> <th>dBuV/m</th> <th>dB</th> <th>dBuV</th> <th>dB</th> <th></th> <th>cm</th> <th>deg</th> </tr> </thead> <tbody> <tr> <td>1</td> <td>5150.00</td> <td>53.09</td> <td>54.00</td> <td>-0.91</td> <td>46.78</td> <td>6.31</td> <td>Average</td> <td>250</td> <td>222</td> </tr> <tr> <td>2</td> <td>5150.00</td> <td>70.41</td> <td>74.00</td> <td>-3.59</td> <td>64.10</td> <td>6.31</td> <td>Peak</td> <td>250</td> <td>222</td> </tr> <tr> <td>3</td> <td>10360.00</td> <td>59.40</td> <td>68.20</td> <td>-8.80</td> <td>43.06</td> <td>16.34</td> <td>Peak</td> <td>278</td> <td>216</td> </tr> <tr> <td>4</td> <td>15540.00</td> <td>48.55</td> <td>54.00</td> <td>-5.45</td> <td>31.05</td> <td>17.50</td> <td>Average</td> <td>239</td> <td>271</td> </tr> <tr> <td>5</td> <td>15540.00</td> <td>60.90</td> <td>74.00</td> <td>-13.10</td> <td>43.40</td> <td>17.50</td> <td>Peak</td> <td>239</td> <td>271</td> </tr> </tbody> </table>	Freq.	Emission level	Limit	Margin	SA reading	Factor	Remark	ANT High	Turn Table	MHz	dBuV/m	dBuV/m	dB	dBuV	dB		cm	deg	1	5150.00	53.09	54.00	-0.91	46.78	6.31	Average	250	222	2	5150.00	70.41	74.00	-3.59	64.10	6.31	Peak	250	222	3	10360.00	59.40	68.20	-8.80	43.06	16.34	Peak	278	216	4	15540.00	48.55	54.00	-5.45	31.05	17.50	Average	239	271	5	15540.00	60.90	74.00	-13.10	43.40	17.50	Peak	239	271			
Freq.	Emission level	Limit	Margin	SA reading	Factor	Remark	ANT High	Turn Table																																																																
MHz	dBuV/m	dBuV/m	dB	dBuV	dB		cm	deg																																																																
1	5150.00	53.09	54.00	-0.91	46.78	6.31	Average	250	222																																																															
2	5150.00	70.41	74.00	-3.59	64.10	6.31	Peak	250	222																																																															
3	10360.00	59.40	68.20	-8.80	43.06	16.34	Peak	278	216																																																															
4	15540.00	48.55	54.00	-5.45	31.05	17.50	Average	239	271																																																															
5	15540.00	60.90	74.00	-13.10	43.40	17.50	Peak	239	271																																																															
<p>Note 1: Emission Level (dBuV/m) = SA Reading (dBuV/m) + Factor* (dB)            *Factor includes antenna factor , cable loss and amplifier gain            Note 2: Margin (dB) = Emission level (dBuV/m) – Limit (dBuV/m).</p>																																																																								

<b>Modulation</b>	HT20	<b>Test Freq. (MHz)</b>	5180
<b>Polarization</b>	Vertical	<b>Test Configuration</b>	3

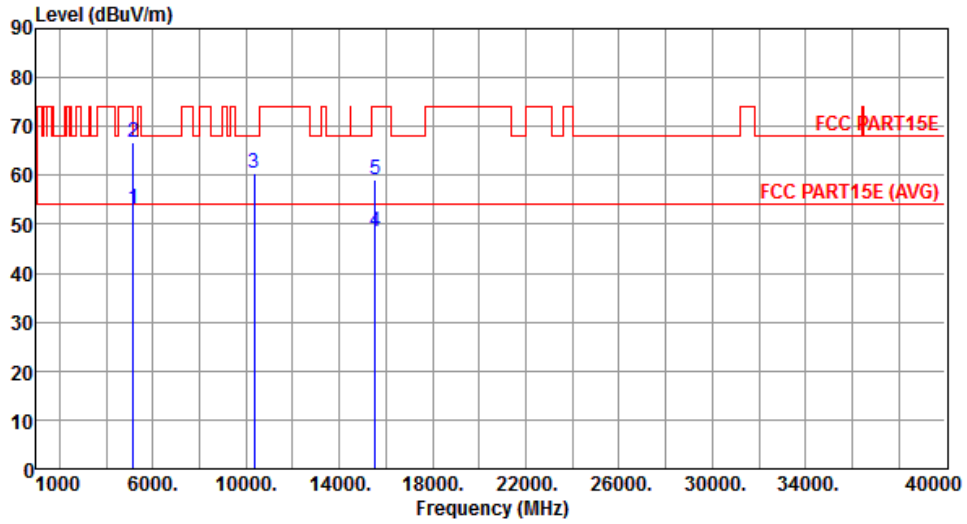

	Freq. MHz	Emission level dBuV/m	Limit dBuV/m	Margin dB	SA reading dBuV	Factor dB	Remark	ANT High cm	Turn Table deg
1	5150.00	53.06	54.00	-0.94	46.75	6.31	Average	291	240
2	5150.00	66.79	74.00	-7.21	60.48	6.31	Peak	291	240
3	10360.00	60.34	68.20	-7.86	44.00	16.34	Peak	272	209
4	15540.00	48.45	54.00	-5.55	30.95	17.50	Average	206	173
5	15540.00	59.09	74.00	-14.91	41.59	17.50	Peak	206	173

Note 1: Emission Level (dBuV/m) = SA Reading (dBuV/m) + Factor\* (dB)

\*Factor includes antenna factor , cable loss and amplifier gain

Note 2: Margin (dB) = Emission level (dBuV/m) – Limit (dBuV/m).

<b>Modulation</b>	HT20	<b>Test Freq. (MHz)</b>	5200
<b>Polarization</b>	Horizontal	<b>Test Configuration</b>	3

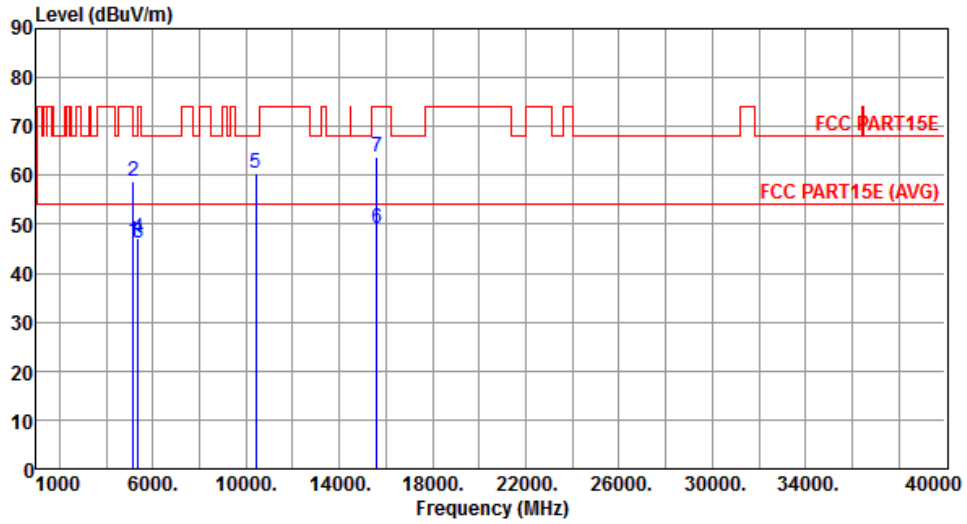

	Freq. MHz	Emission level dBuV/m	Limit dBuV/m	Margin dB	SA reading dBuV	Factor dB	Remark	ANT High cm	Turn Table deg
1	5150.00	46.36	54.00	-7.64	40.05	6.31	Average	251	223
2	5150.00	58.70	74.00	-15.30	52.39	6.31	Peak	251	223
3	5350.00	46.22	54.00	-7.78	39.60	6.62	Average	251	223
4	5350.00	47.01	74.00	-26.99	40.39	6.62	Peak	251	223
5	10400.00	60.35	68.20	-7.85	43.93	16.42	Peak	261	0
6	15600.00	49.26	54.00	-4.74	31.88	17.38	Average	305	300
7	15600.00	63.60	74.00	-10.40	46.22	17.38	Peak	305	300

Note 1: Emission Level (dBuV/m) = SA Reading (dBuV/m) + Factor\* (dB)

\*Factor includes antenna factor , cable loss and amplifier gain

Note 2: Margin (dB) = Emission level (dBuV/m) – Limit (dBuV/m).

<b>Modulation</b>	HT20	<b>Test Freq. (MHz)</b>	5200
<b>Polarization</b>	Vertical	<b>Test Configuration</b>	3

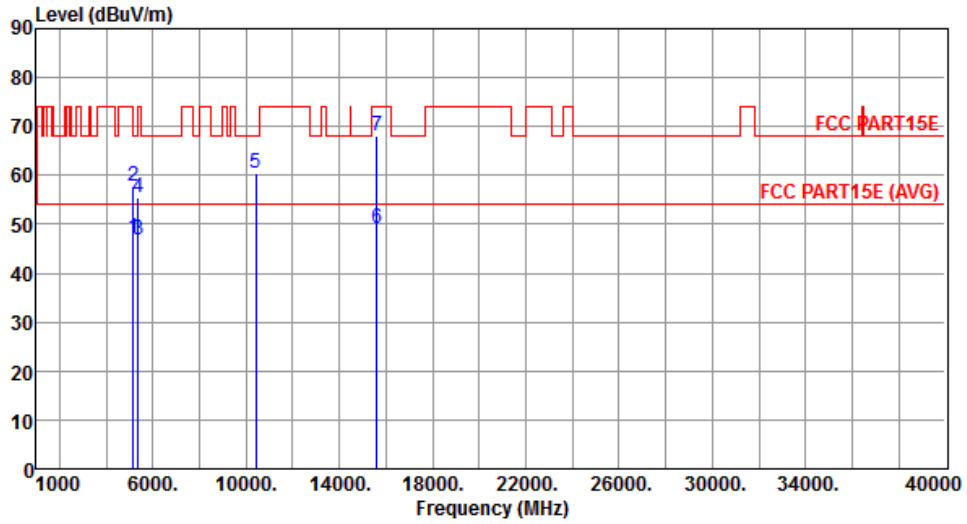

	Freq. MHz	Emission level dBuV/m	Limit dBuV/m	Margin dB	SA reading dBuV	Factor dB	Remark	ANT High cm	Turn Table deg
1	5150.00	47.26	54.00	-6.74	40.95	6.31	Average	290	235
2	5150.00	57.90	74.00	-16.10	51.59	6.31	Peak	290	235
3	5350.00	46.98	54.00	-7.02	40.36	6.62	Average	290	235
4	5350.00	55.59	74.00	-18.41	48.97	6.62	Peak	290	235
5	10400.00	60.47	68.20	-7.73	44.05	16.42	Peak	325	18
6	15600.00	49.25	54.00	-4.75	31.87	17.38	Average	100	357
7	15600.00	67.98	74.00	-6.02	50.60	17.38	Peak	100	357

Note 1: Emission Level (dBuV/m) = SA Reading (dBuV/m) + Factor\* (dB)

\*Factor includes antenna factor , cable loss and amplifier gain

Note 2: Margin (dB) = Emission level (dBuV/m) – Limit (dBuV/m).

<b>Modulation</b>	HT20	<b>Test Freq. (MHz)</b>	5240
<b>Polarization</b>	Horizontal	<b>Test Configuration</b>	3

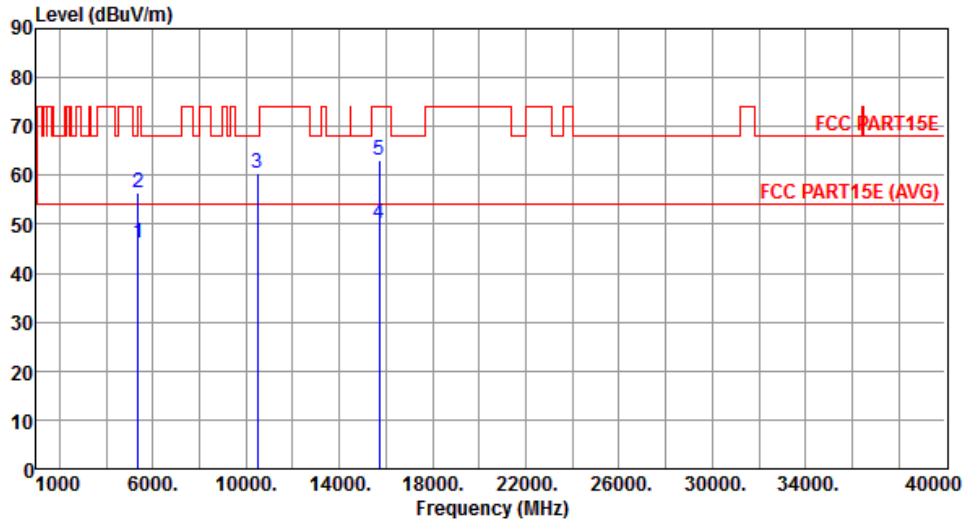

	Freq. MHz	Emission level dBuV/m	Limit dBuV/m	Margin dB	SA reading dBuV	Factor dB	Remark	ANT High cm	Turn Table deg
1	5350.00	46.30	54.00	-7.70	39.68	6.62	Average	250	220
2	5350.00	56.36	74.00	-17.64	49.74	6.62	Peak	250	220
3	10480.00	60.39	68.20	-7.81	43.83	16.56	Peak	295	349
4	15720.00	50.19	54.00	-3.81	33.04	17.15	Average	306	301
5	15720.00	63.26	74.00	-10.74	46.11	17.15	Peak	306	301

Note 1: Emission Level (dBuV/m) = SA Reading (dBuV/m) + Factor\* (dB)

\*Factor includes antenna factor , cable loss and amplifier gain

Note 2: Margin (dB) = Emission level (dBuV/m) – Limit (dBuV/m).

<b>Modulation</b>	HT20	<b>Test Freq. (MHz)</b>	5240
<b>Polarization</b>	Vertical	<b>Test Configuration</b>	3

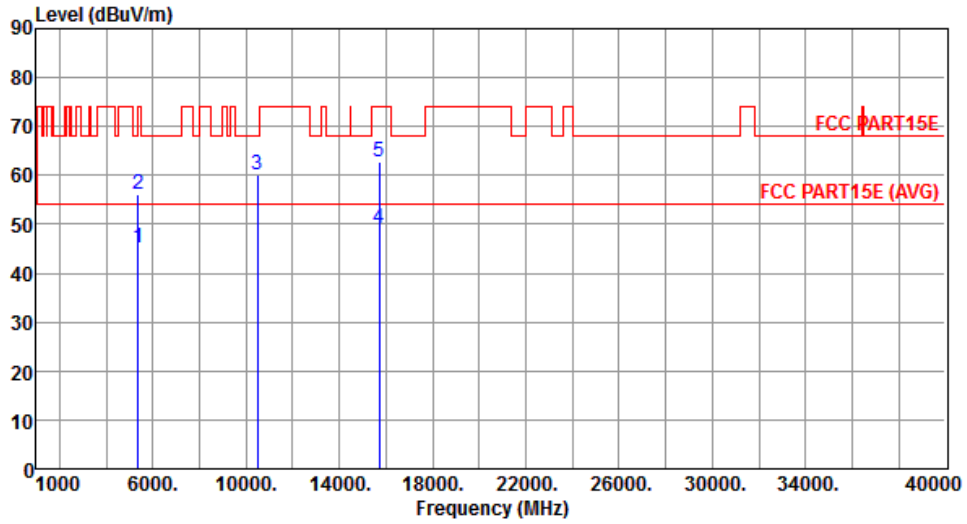

	Freq. MHz	Emission level dBuV/m	Limit dBuV/m	Margin dB	SA reading dBuV	Factor dB	Remark	ANT High cm	Turn Table deg
1	5350.00	45.26	54.00	-8.74	38.64	6.62	Average	296	236
2	5350.00	56.26	74.00	-17.74	49.64	6.62	Peak	296	236
3	10480.00	60.27	68.20	-7.93	43.71	16.56	Peak	328	352
4	15720.00	49.24	54.00	-4.76	32.09	17.15	Average	100	357
5	15720.00	62.85	74.00	-11.15	45.70	17.15	Peak	100	357

Note 1: Emission Level (dBuV/m) = SA Reading (dBuV/m) + Factor\* (dB)

\*Factor includes antenna factor , cable loss and amplifier gain

Note 2: Margin (dB) = Emission level (dBuV/m) – Limit (dBuV/m).

<b>Modulation</b>	HT20	<b>Test Freq. (MHz)</b>	5260
<b>Polarization</b>	Horizontal	<b>Test Configuration</b>	3

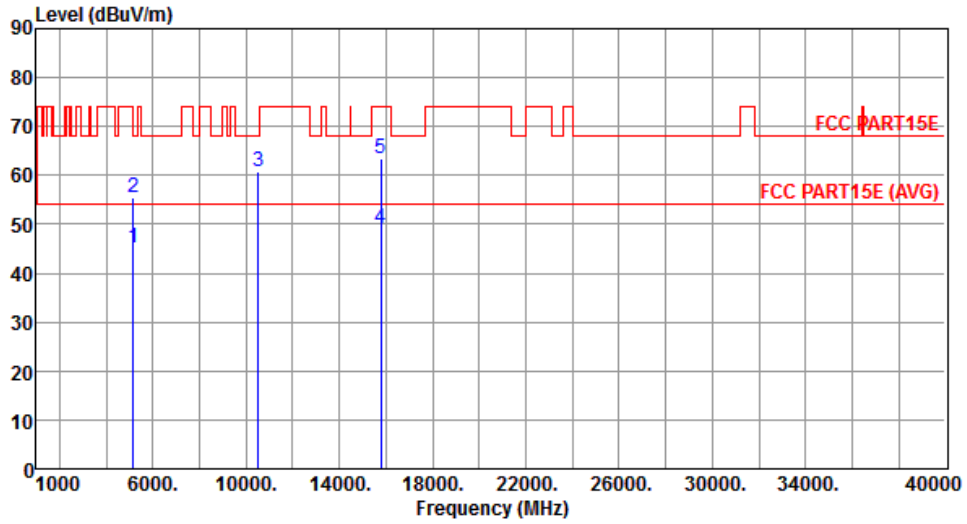

	Freq. MHz	Emission level dBuV/m	Limit dBuV/m	Margin dB	SA reading dBuV	Factor dB	Remark	ANT High cm	Turn Table deg
1	5150.00	45.09	54.00	-8.91	38.78	6.31	Average	250	221
2	5150.00	55.56	74.00	-18.44	49.25	6.31	Peak	250	221
3	10520.00	60.86	68.20	-7.34	44.26	16.60	Peak	261	55
4	15780.00	49.22	54.00	-4.78	32.17	17.05	Average	300	305
5	15780.00	63.30	74.00	-10.70	46.25	17.05	Peak	300	305

Note 1: Emission Level (dBuV/m) = SA Reading (dBuV/m) + Factor\* (dB)

\*Factor includes antenna factor , cable loss and amplifier gain

Note 2: Margin (dB) = Emission level (dBuV/m) – Limit (dBuV/m).



<b>Modulation</b>	HT20	<b>Test Freq. (MHz)</b>	5260
<b>Polarization</b>	Vertical	<b>Test Configuration</b>	3

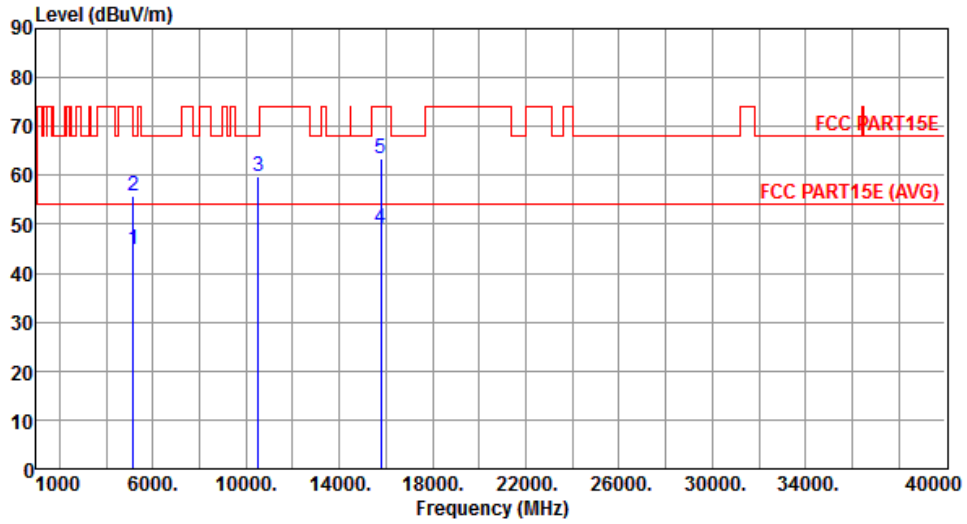

	Freq. MHz	Emission level dBuV/m	Limit dBuV/m	Margin dB	SA reading dBuV	Factor dB	Remark	ANT High cm	Turn Table deg
1	5150.00	44.90	54.00	-9.10	38.59	6.31	Average	294	239
2	5150.00	55.68	74.00	-18.32	49.37	6.31	Peak	294	239
3	10520.00	59.86	68.20	-8.34	43.26	16.60	Peak	267	113
4	15780.00	49.30	54.00	-4.70	32.25	17.05	Average	100	353
5	15780.00	63.30	74.00	-10.70	46.25	17.05	Peak	100	353

Note 1: Emission Level (dBuV/m) = SA Reading (dBuV/m) + Factor\* (dB)

\*Factor includes antenna factor , cable loss and amplifier gain

Note 2: Margin (dB) = Emission level (dBuV/m) – Limit (dBuV/m).

<b>Modulation</b>	HT20	<b>Test Freq. (MHz)</b>	5300
<b>Polarization</b>	Horizontal	<b>Test Configuration</b>	3

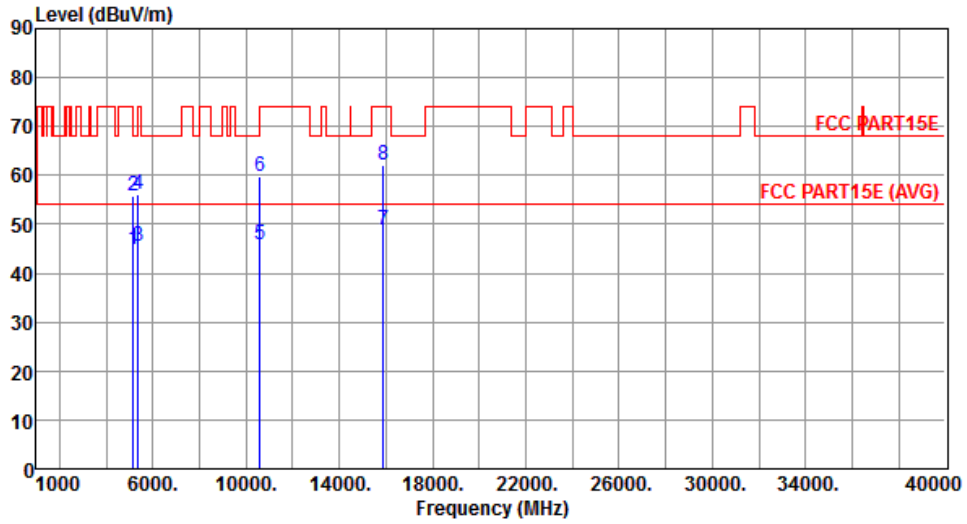

	Freq. MHz	Emission level dBuV/m	Limit dBuV/m	Margin dB	SA reading dBuV	Factor dB	Remark	ANT High cm	Turn Table deg
1	5150.00	44.72	54.00	-9.28	38.41	6.31	Average	250	221
2	5150.00	55.88	74.00	-18.12	49.57	6.31	Peak	250	221
3	5350.00	45.61	54.00	-8.39	38.99	6.62	Average	250	221
4	5350.00	56.28	74.00	-17.72	49.66	6.62	Peak	250	221
5	10600.00	45.98	54.00	-8.02	29.36	16.62	Average	296	0
6	10600.00	59.88	74.00	-14.12	43.26	16.62	Peak	296	0
7	15900.00	48.88	54.00	-5.12	32.06	16.82	Average	304	304
8	15900.00	62.25	74.00	-11.75	45.43	16.82	Peak	304	304

Note 1: Emission Level (dBuV/m) = SA Reading (dBuV/m) + Factor\* (dB)

\*Factor includes antenna factor , cable loss and amplifier gain

Note 2: Margin (dB) = Emission level (dBuV/m) – Limit (dBuV/m).

<b>Modulation</b>	HT20	<b>Test Freq. (MHz)</b>	5300
<b>Polarization</b>	Vertical	<b>Test Configuration</b>	3

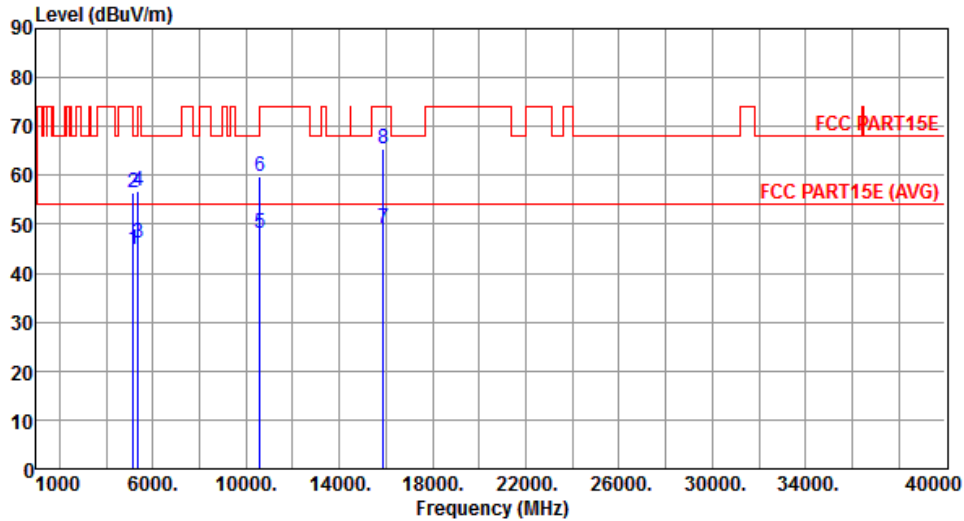

	Freq. MHz	Emission level dBuV/m	Limit dBuV/m	Margin dB	SA reading dBuV	Factor dB	Remark	ANT High cm	Turn Table deg
1	5150.00	44.90	54.00	-9.10	38.59	6.31	Average	295	237
2	5150.00	56.59	74.00	-17.41	50.28	6.31	Peak	295	237
3	5350.00	46.22	54.00	-7.78	39.60	6.62	Average	295	237
4	5350.00	56.66	74.00	-17.34	50.04	6.62	Peak	295	237
5	10600.00	48.06	54.00	-5.94	31.44	16.62	Average	305	358
6	10600.00	59.71	74.00	-14.29	43.09	16.62	Peak	305	358
7	15900.00	49.06	54.00	-4.94	32.24	16.82	Average	100	355
8	15900.00	65.27	74.00	-8.73	48.45	16.82	Peak	100	355

Note 1: Emission Level (dBuV/m) = SA Reading (dBuV/m) + Factor\* (dB)

\*Factor includes antenna factor , cable loss and amplifier gain

Note 2: Margin (dB) = Emission level (dBuV/m) – Limit (dBuV/m).

<b>Modulation</b>	HT20	<b>Test Freq. (MHz)</b>	5320
<b>Polarization</b>	Horizontal	<b>Test Configuration</b>	3

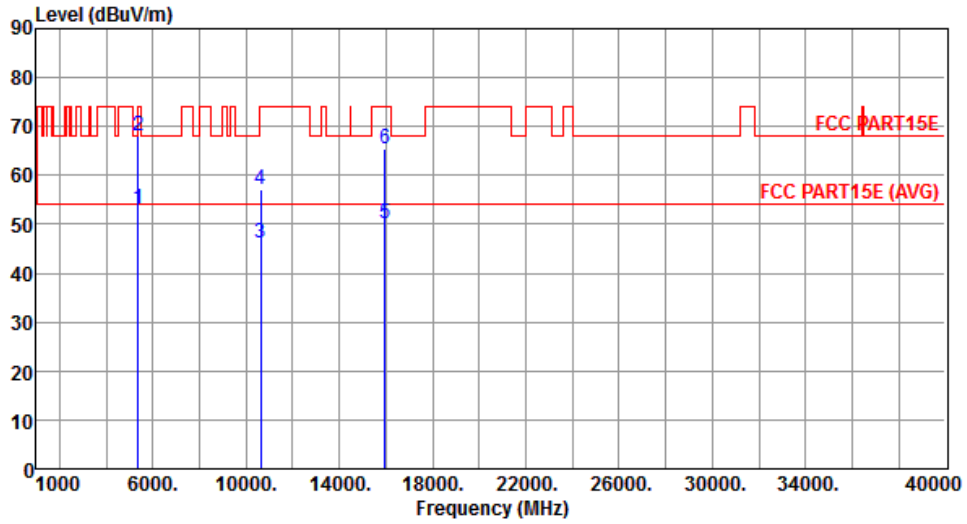

	Freq. MHz	Emission level dBuV/m	Limit dBuV/m	Margin dB	SA reading dBuV	Factor dB	Remark	ANT High cm	Turn Table deg
1	5350.00	53.17	54.00	-0.83	46.55	6.62	Average	249	230
2	5350.00	68.07	74.00	-5.93	61.45	6.62	Peak	249	230
3	10640.00	46.20	54.00	-7.80	29.57	16.63	Average	215	16
4	10640.00	57.02	74.00	-16.98	40.39	16.63	Peak	215	16
5	15960.00	50.19	54.00	-3.81	33.49	16.70	Average	219	353
6	15960.00	65.35	74.00	-8.65	48.65	16.70	Peak	219	353

Note 1: Emission Level (dBuV/m) = SA Reading (dBuV/m) + Factor\* (dB)

\*Factor includes antenna factor , cable loss and amplifier gain

Note 2: Margin (dB) = Emission level (dBuV/m) – Limit (dBuV/m).

<b>Modulation</b>	HT20	<b>Test Freq. (MHz)</b>	5320
<b>Polarization</b>	Vertical	<b>Test Configuration</b>	3

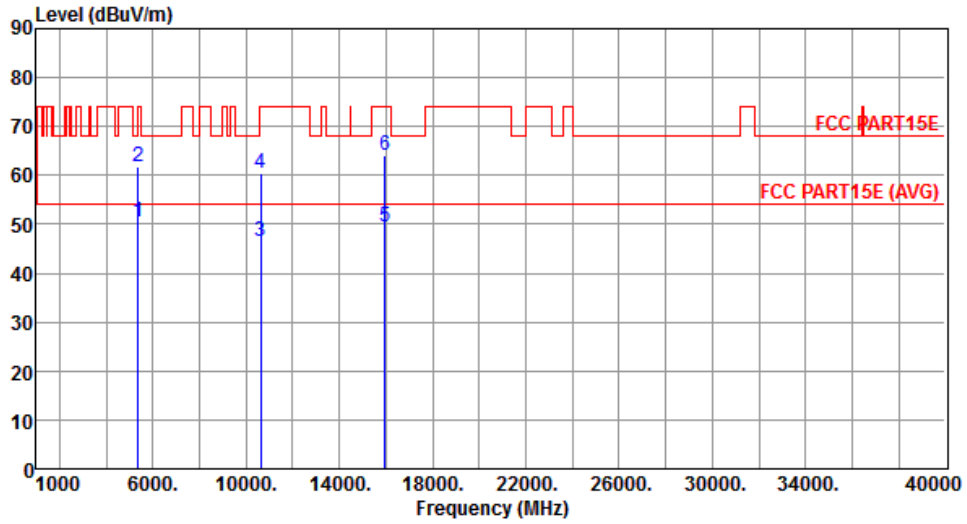

	Freq. MHz	Emission level dBuV/m	Limit dBuV/m	Margin dB	SA reading dBuV	Factor dB	Remark	ANT High cm	Turn Table deg
1	5350.00	50.52	54.00	-3.48	43.90	6.62	Average	280	246
2	5350.00	61.88	74.00	-12.12	55.26	6.62	Peak	280	246
3	10640.00	46.60	54.00	-7.40	29.97	16.63	Average	398	20
4	10640.00	60.50	74.00	-13.50	43.87	16.63	Peak	398	20
5	15960.00	49.36	54.00	-4.64	32.66	16.70	Average	121	353
6	15960.00	64.07	74.00	-9.93	47.37	16.70	Peak	121	353

Note 1: Emission Level (dBuV/m) = SA Reading (dBuV/m) + Factor\* (dB)

\*Factor includes antenna factor , cable loss and amplifier gain

Note 2: Margin (dB) = Emission level (dBuV/m) – Limit (dBuV/m).

<b>Modulation</b>	HT20	<b>Test Freq. (MHz)</b>	5500
<b>Polarization</b>	Horizontal	<b>Test Configuration</b>	3

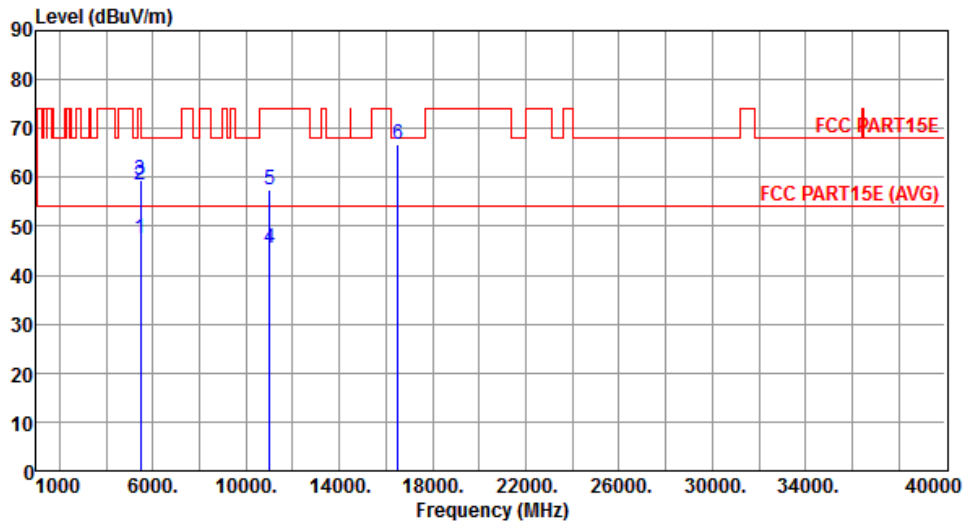

	Freq. MHz	Emission level dBuV/m	Limit dBuV/m	Margin dB	SA reading dBuV	Factor dB	Remark	ANT High cm	Turn Table deg
1	5460.00	47.38	54.00	-6.62	40.62	6.76	Average	280	231
2	5460.00	58.35	74.00	-15.65	51.59	6.76	Peak	280	231
3	5470.00	59.42	68.20	-8.78	52.65	6.77	Peak	281	231
4	11000.00	45.38	54.00	-8.62	28.66	16.72	Average	248	22
5	11000.00	57.47	74.00	-16.53	40.75	16.72	Peak	248	22
6	16500.00	66.86	68.20	-1.34	48.99	17.87	Peak	236	0

Note 1: Emission Level (dBuV/m) = SA Reading (dBuV/m) + Factor\* (dB)

\*Factor includes antenna factor , cable loss and amplifier gain

Note 2: Margin (dB) = Emission level (dBuV/m) – Limit (dBuV/m).

<b>Modulation</b>	HT20	<b>Test Freq. (MHz)</b>	5500
<b>Polarization</b>	Vertical	<b>Test Configuration</b>	3

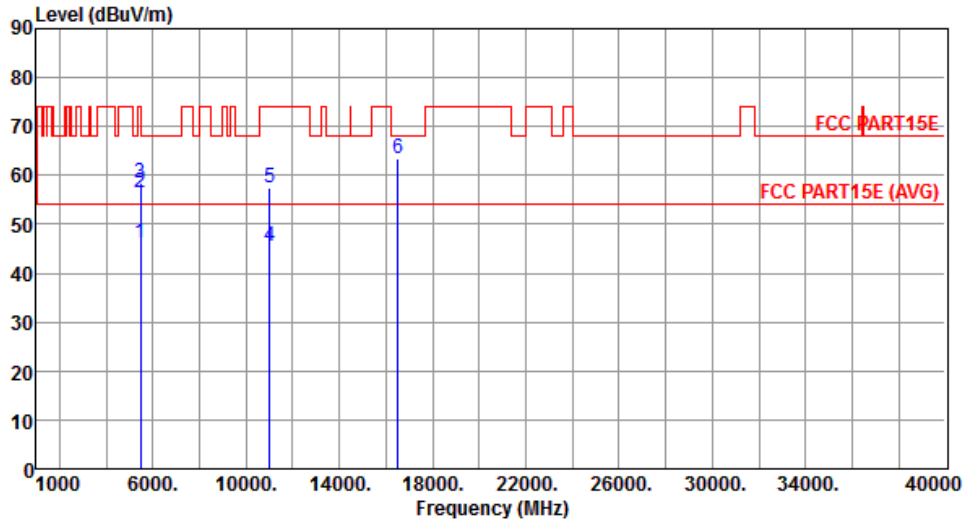

	Freq. MHz	Emission level dBuV/m	Limit dBuV/m	Margin dB	SA reading dBuV	Factor dB	Remark	ANT High cm	Turn Table deg
1	5460.00	46.01	54.00	-7.99	39.25	6.76	Average	216	230
2	5460.00	56.47	74.00	-17.53	49.71	6.76	Peak	216	230
3	5470.00	58.29	68.20	-9.91	51.52	6.77	Peak	216	230
4	11000.00	45.64	54.00	-8.36	28.92	16.72	Average	206	82
5	11000.00	57.36	74.00	-16.64	40.64	16.72	Peak	206	82
6	16500.00	63.57	68.20	-4.63	45.70	17.87	Peak	278	308

Note 1: Emission Level (dBuV/m) = SA Reading (dBuV/m) + Factor\* (dB)

\*Factor includes antenna factor , cable loss and amplifier gain

Note 2: Margin (dB) = Emission level (dBuV/m) – Limit (dBuV/m).

<b>Modulation</b>	HT20	<b>Test Freq. (MHz)</b>	5580
<b>Polarization</b>	Horizontal	<b>Test Configuration</b>	3

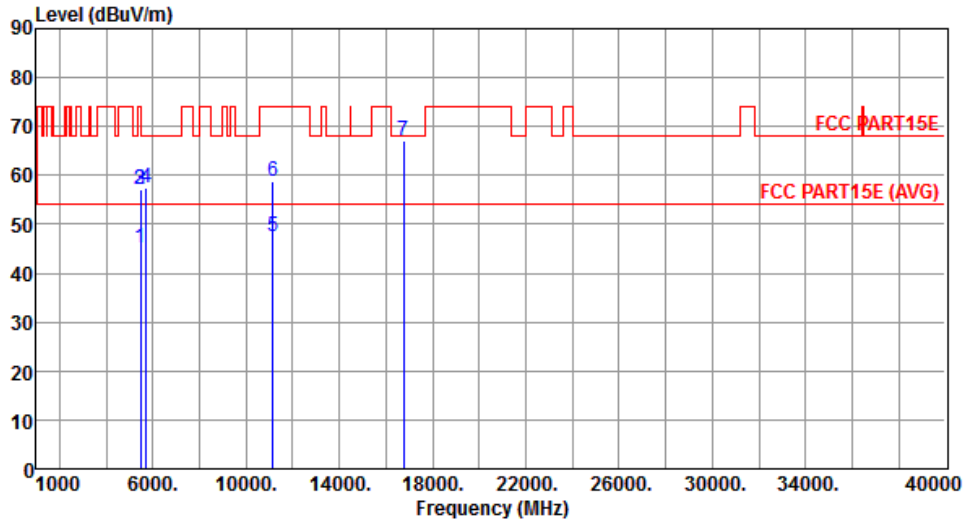

	Freq. MHz	Emission level dBUV/m	Limit dBUV/m	Margin dB	SA reading dBUV	Factor dB	Remark	ANT High cm	Turn Table deg
1	5460.00	45.32	54.00	-8.68	38.56	6.76	Average	287	230
2	5460.00	57.12	74.00	-16.88	50.36	6.76	Peak	287	230
3	5470.00	57.02	68.20	-11.18	50.25	6.77	Peak	287	230
4	5725.00	57.43	68.20	-10.77	50.19	7.24	Peak	287	230
5	11160.00	47.38	54.00	-6.62	30.59	16.79	Average	272	2
6	11160.00	58.85	74.00	-15.15	42.06	16.79	Peak	272	2
7	16740.00	67.04	68.20	-1.16	48.64	18.40	Peak	247	354

Note 1: Emission Level (dBUV/m) = SA Reading (dBUV/m) + Factor\* (dB)

\*Factor includes antenna factor , cable loss and amplifier gain

Note 2: Margin (dB) = Emission level (dBUV/m) – Limit (dBUV/m).



<b>Modulation</b>	HT20	<b>Test Freq. (MHz)</b>	5580
<b>Polarization</b>	Vertical	<b>Test Configuration</b>	3

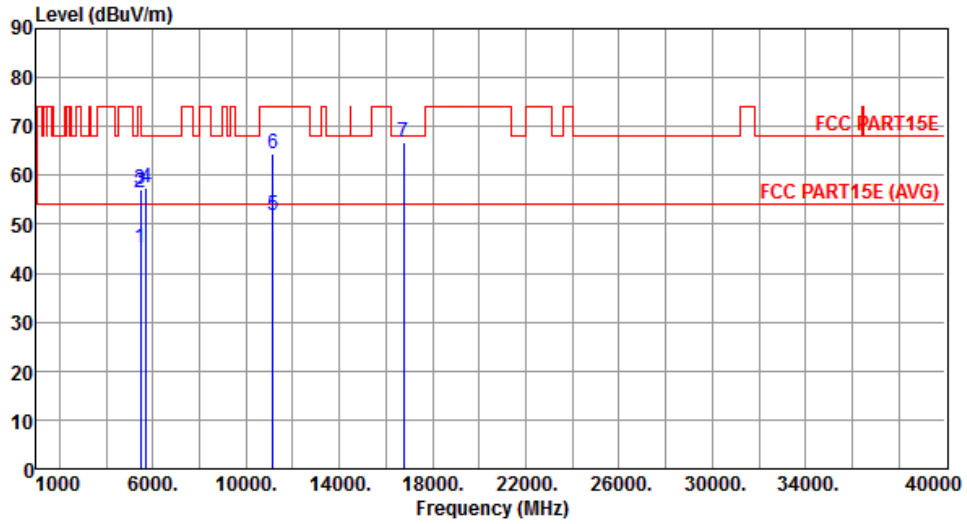

	Freq. MHz	Emission level dBuV/m	Limit dBuV/m	Margin dB	SA reading dBuV	Factor dB	Remark	ANT High cm	Turn Table deg
1	5460.00	45.20	54.00	-8.80	38.44	6.76	Average	216	230
2	5460.00	56.42	74.00	-17.58	49.66	6.76	Peak	216	230
3	5470.00	57.08	68.20	-11.12	50.31	6.77	Peak	216	230
4	5725.00	57.50	68.20	-10.70	50.26	7.24	Peak	216	235
5	11160.00	51.75	54.00	-2.25	34.96	16.79	Average	280	0
6	11160.00	64.47	74.00	-9.53	47.68	16.79	Peak	280	0
7	16740.00	66.74	68.20	-1.46	48.34	18.40	Peak	110	357

Note 1: Emission Level (dBuV/m) = SA Reading (dBuV/m) + Factor\* (dB)

\*Factor includes antenna factor , cable loss and amplifier gain

Note 2: Margin (dB) = Emission level (dBuV/m) – Limit (dBuV/m).

<b>Modulation</b>	HT20	<b>Test Freq. (MHz)</b>	5700
<b>Polarization</b>	Horizontal	<b>Test Configuration</b>	3

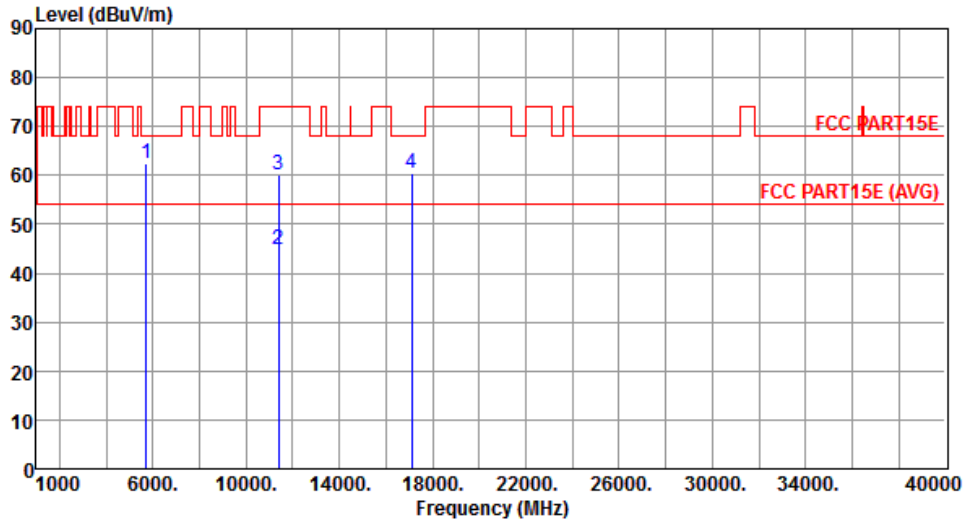

	Freq. MHz	Emission level dBuV/m	Limit dBuV/m	Margin dB	SA reading dBuV	Factor dB	Remark	ANT High cm	Turn Table deg
1	5725.00	62.50	68.20	-5.70	55.26	7.24	Peak	101	320
2	11400.00	44.85	54.00	-9.15	27.97	16.88	Average	272	17
3	11400.00	60.08	74.00	-13.92	43.20	16.88	Peak	272	17
4	17100.00	60.51	68.20	-7.69	41.39	19.12	Peak	236	26

Note 1: Emission Level (dBuV/m) = SA Reading (dBuV/m) + Factor\* (dB)

\*Factor includes antenna factor , cable loss and amplifier gain

Note 2: Margin (dB) = Emission level (dBuV/m) – Limit (dBuV/m).

<b>Modulation</b>	HT20	<b>Test Freq. (MHz)</b>	5700
<b>Polarization</b>	Vertical	<b>Test Configuration</b>	3

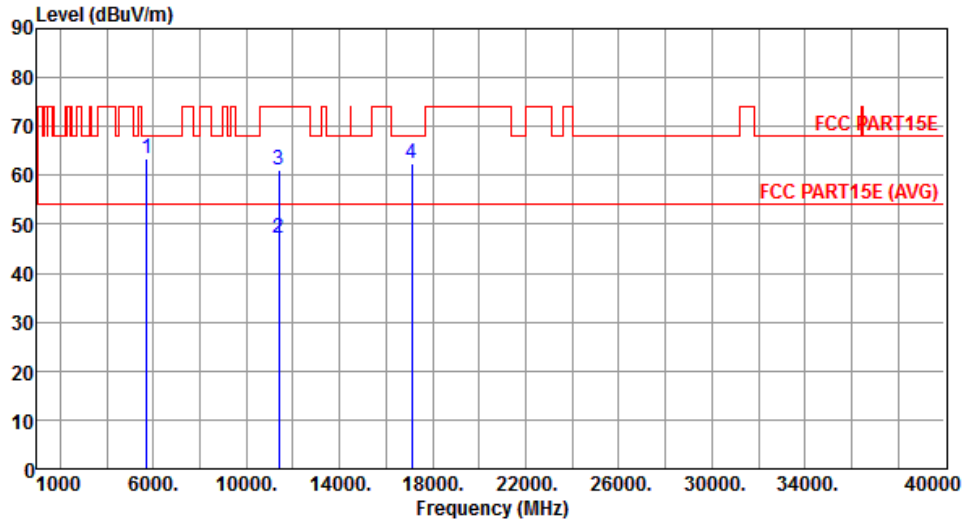

	Freq. MHz	Emission level dBuV/m	Limit dBuV/m	Margin dB	SA reading dBuV	Factor dB	Remark	ANT High cm	Turn Table deg
1	5725.00	63.60	68.20	-4.60	56.36	7.24	Peak	259	234
2	11400.00	47.17	54.00	-6.83	30.29	16.88	Average	280	2
3	11400.00	61.16	74.00	-12.84	44.28	16.88	Peak	280	2
4	17100.00	62.32	68.20	-5.88	43.20	19.12	Peak	100	359

Note 1: Emission Level (dBuV/m) = SA Reading (dBuV/m) + Factor\* (dB)

\*Factor includes antenna factor , cable loss and amplifier gain

Note 2: Margin (dB) = Emission level (dBuV/m) – Limit (dBuV/m).

<b>Modulation</b>	HT20	<b>Test Freq. (MHz)</b>	5745
<b>Polarization</b>	Horizontal	<b>Test Configuration</b>	3

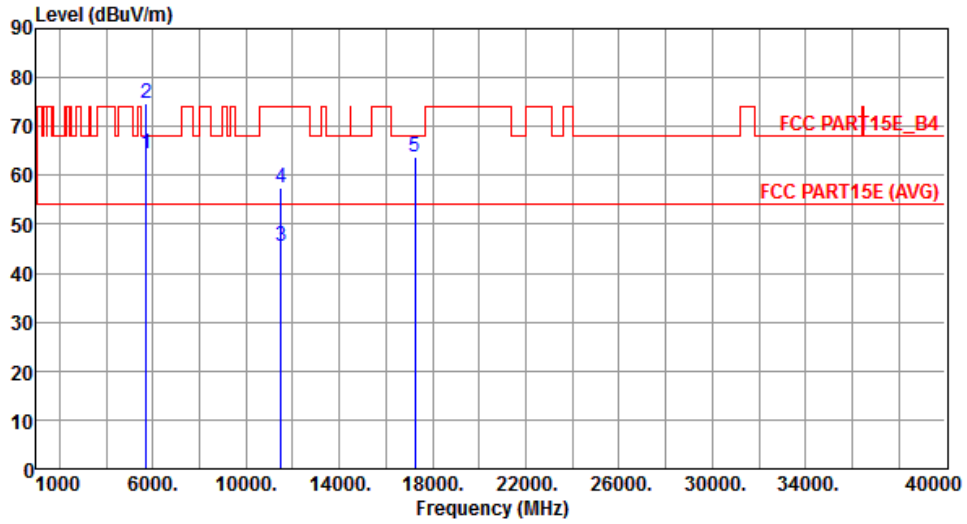

	Freq. MHz	Emission level dBuV/m	Limit dBuV/m	Margin dB	SA reading dBuV	Factor dB	Remark	ANT High cm	Turn Table deg
1	5715.00	64.45	68.20	-3.75	57.25	7.20	Peak	108	205
2	5725.00	74.77	78.20	-3.43	67.53	7.24	Peak	108	205
3	11490.00	45.43	54.00	-8.57	28.52	16.91	Average	287	4
4	11490.00	57.43	74.00	-16.57	40.52	16.91	Peak	287	4
5	17235.00	63.64	68.20	-4.56	44.32	19.32	Peak	259	333

Note 1: Emission Level (dBuV/m) = SA Reading (dBuV/m) + Factor\* (dB)

\*Factor includes antenna factor , cable loss and amplifier gain

Note 2: Margin (dB) = Emission level (dBuV/m) – Limit (dBuV/m).

<b>Modulation</b>	HT20	<b>Test Freq. (MHz)</b>	5745
<b>Polarization</b>	Vertical	<b>Test Configuration</b>	3

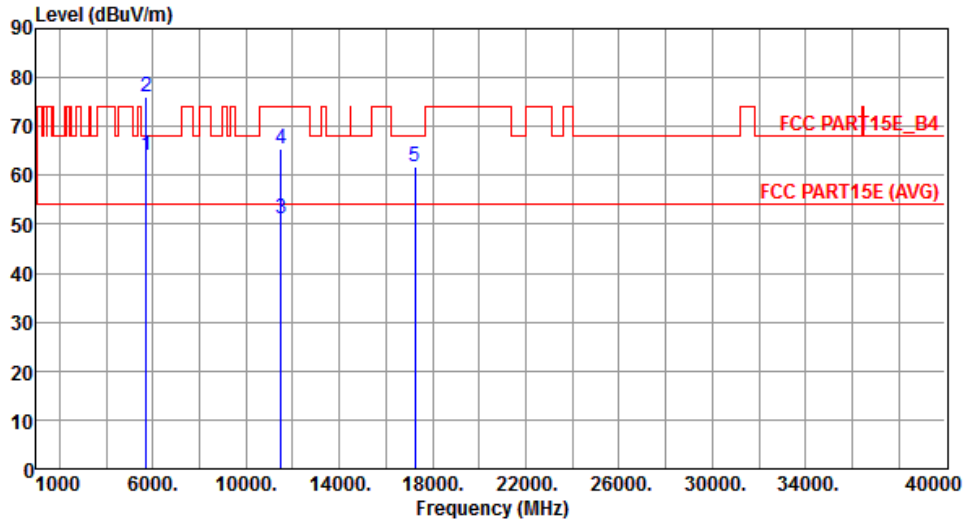

	Freq. MHz	Emission level dBuV/m	Limit dBuV/m	Margin dB	SA reading dBuV	Factor dB	Remark	ANT High cm	Turn Table deg
1	5715.00	64.04	68.20	-4.16	56.84	7.20	Peak	190	256
2	5725.00	76.03	78.20	-2.17	68.79	7.24	Peak	190	256
3	11490.00	51.05	54.00	-2.95	34.14	16.91	Average	241	1
4	11490.00	65.36	74.00	-8.64	48.45	16.91	Peak	241	1
5	17235.00	61.89	68.20	-6.31	42.57	19.32	Peak	111	351

Note 1: Emission Level (dBuV/m) = SA Reading (dBuV/m) + Factor\* (dB)

\*Factor includes antenna factor , cable loss and amplifier gain

Note 2: Margin (dB) = Emission level (dBuV/m) – Limit (dBuV/m).

<b>Modulation</b>	HT20	<b>Test Freq. (MHz)</b>	5785
<b>Polarization</b>	Horizontal	<b>Test Configuration</b>	3

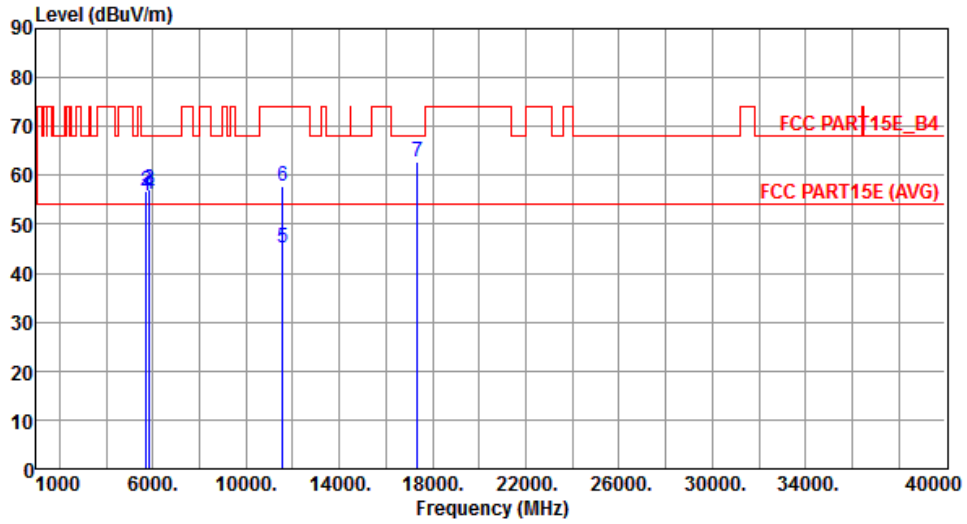

	Freq. MHz	Emission level dBuV/m	Limit dBuV/m	Margin dB	SA reading dBuV	Factor dB	Remark	ANT High cm	Turn Table deg
1	5715.00	55.93	68.20	-12.27	48.73	7.20	Peak	221	13
2	5725.00	56.94	78.20	-21.26	49.70	7.24	Peak	221	13
3	5850.00	57.28	78.20	-20.92	49.78	7.50	Peak	221	13
4	5860.00	56.12	68.20	-12.08	48.61	7.51	Peak	221	13
5	11570.00	45.02	54.00	-8.98	28.22	16.80	Average	244	213
6	11570.00	57.92	74.00	-16.08	41.12	16.80	Peak	244	213
7	17355.00	62.89	68.20	-5.31	43.40	19.49	Peak	257	331

Note 1: Emission Level (dBuV/m) = SA Reading (dBuV/m) + Factor\* (dB)

\*Factor includes antenna factor , cable loss and amplifier gain

Note 2: Margin (dB) = Emission level (dBuV/m) – Limit (dBuV/m).

<b>Modulation</b>	HT20	<b>Test Freq. (MHz)</b>	5785
<b>Polarization</b>	Vertical	<b>Test Configuration</b>	3

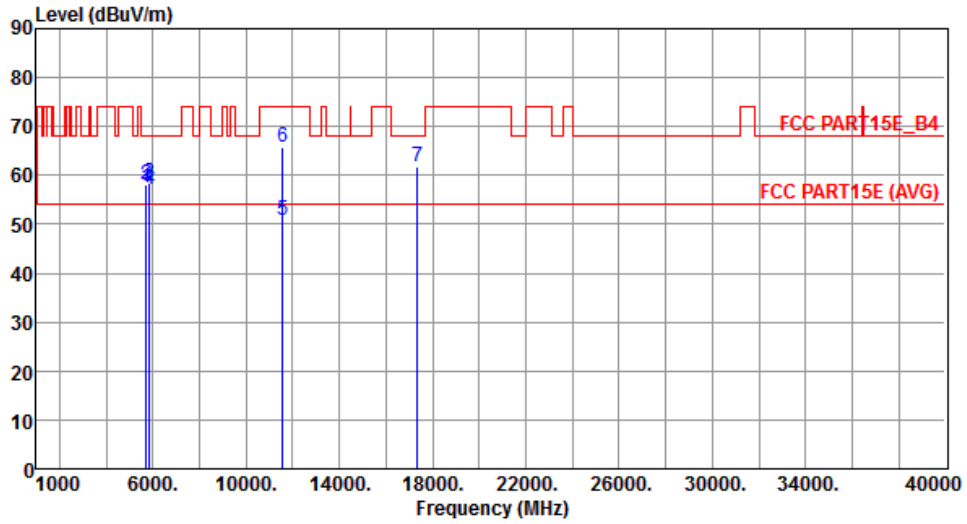

	Freq. MHz	Emission level dBuV/m	Limit dBuV/m	Margin dB	SA reading dBuV	Factor dB	Remark	ANT High cm	Turn Table deg
1	5715.00	57.33	68.20	-10.87	50.13	7.20	Peak	163	234
2	5725.00	57.96	78.20	-20.24	50.72	7.24	Peak	163	234
3	5850.00	58.56	78.20	-19.64	51.06	7.50	Peak	163	234
4	5860.00	57.11	68.20	-11.09	49.60	7.51	Peak	163	234
5	11570.00	50.89	54.00	-3.11	34.09	16.80	Average	229	19
6	11570.00	65.90	74.00	-8.10	49.10	16.80	Peak	229	19
7	17355.00	61.83	68.20	-6.37	42.34	19.49	Peak	104	341

Note 1: Emission Level (dBuV/m) = SA Reading (dBuV/m) + Factor\* (dB)

\*Factor includes antenna factor , cable loss and amplifier gain

Note 2: Margin (dB) = Emission level (dBuV/m) – Limit (dBuV/m).

<b>Modulation</b>	HT20	<b>Test Freq. (MHz)</b>	5825
<b>Polarization</b>	Horizontal	<b>Test Configuration</b>	3

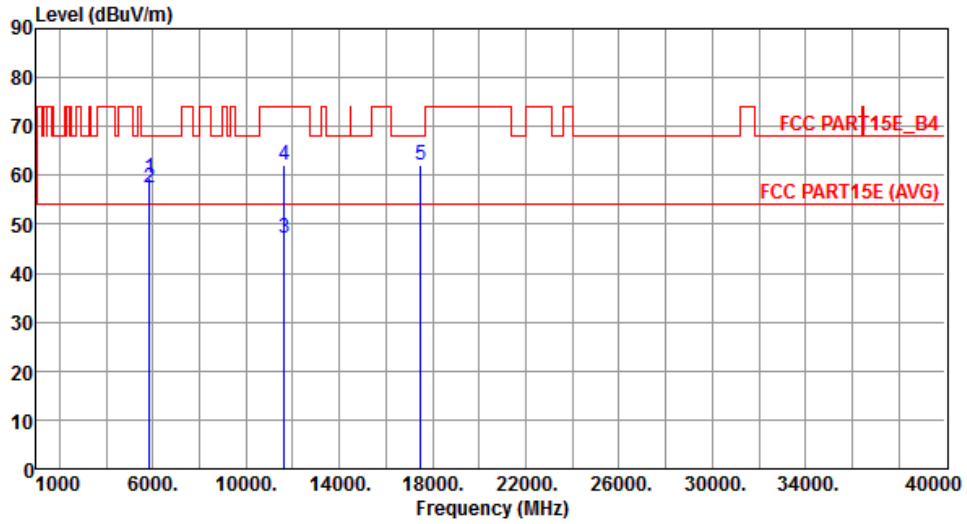

	Freq. MHz	Emission level dBuV/m	Limit dBuV/m	Margin dB	SA reading dBuV	Factor dB	Remark	ANT High cm	Turn Table deg
1	5850.00	59.43	78.20	-18.77	51.93	7.50	Peak	238	16
2	5860.00	57.35	68.20	-10.85	49.84	7.51	Peak	238	16
3	11650.00	47.26	54.00	-6.74	30.61	16.65	Average	233	215
4	11650.00	62.12	74.00	-11.88	45.47	16.65	Peak	238	219
5	17475.00	62.04	68.20	-6.16	42.38	19.66	Peak	269	334

Note 1: Emission Level (dBuV/m) = SA Reading (dBuV/m) + Factor\* (dB)

\*Factor includes antenna factor , cable loss and amplifier gain

Note 2: Margin (dB) = Emission level (dBuV/m) – Limit (dBuV/m).



<b>Modulation</b>	HT20	<b>Test Freq. (MHz)</b>	5825
<b>Polarization</b>	Vertical	<b>Test Configuration</b>	3

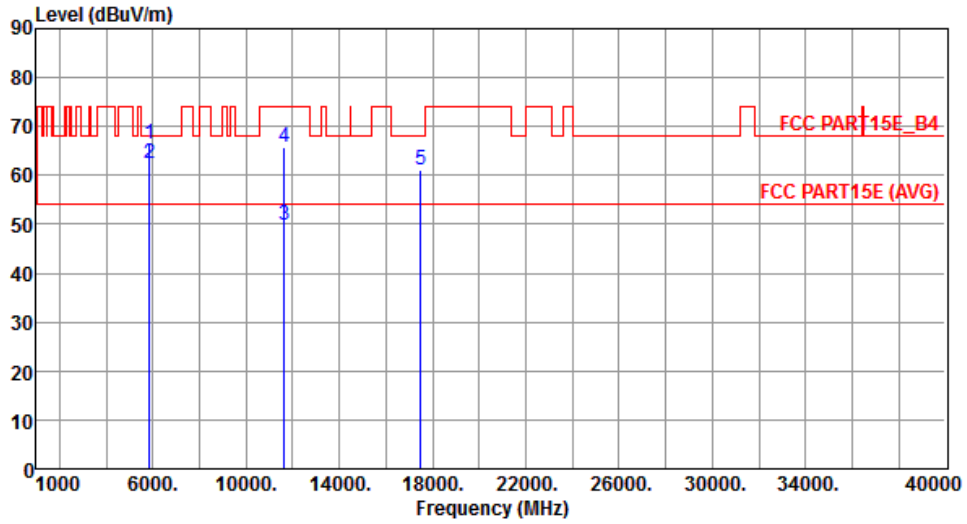

	Freq. MHz	Emission level dBuV/m	Limit dBuV/m	Margin dB	SA reading dBuV	Factor dB	Remark	ANT High cm	Turn Table deg
1	5850.00	66.47	78.20	-11.73	58.97	7.50	Peak	176	220
2	5860.00	62.31	68.20	-5.89	54.80	7.51	Peak	176	220
3	11650.00	49.93	54.00	-4.07	33.28	16.65	Average	247	9
4	11650.00	65.74	74.00	-8.26	49.09	16.65	Peak	247	9
5	17475.00	61.08	68.20	-7.12	41.42	19.66	Peak	111	354

Note 1: Emission Level (dBuV/m) = SA Reading (dBuV/m) + Factor\* (dB)

\*Factor includes antenna factor , cable loss and amplifier gain

Note 2: Margin (dB) = Emission level (dBuV/m) – Limit (dBuV/m).

### 3.5.15 Transmitter Radiated Unwanted Emissions (Above 1GHz) for HT40

<b>Modulation</b>	HT40	<b>Test Freq. (MHz)</b>	5190
<b>Polarization</b>	Horizontal	<b>Test Configuration</b>	3

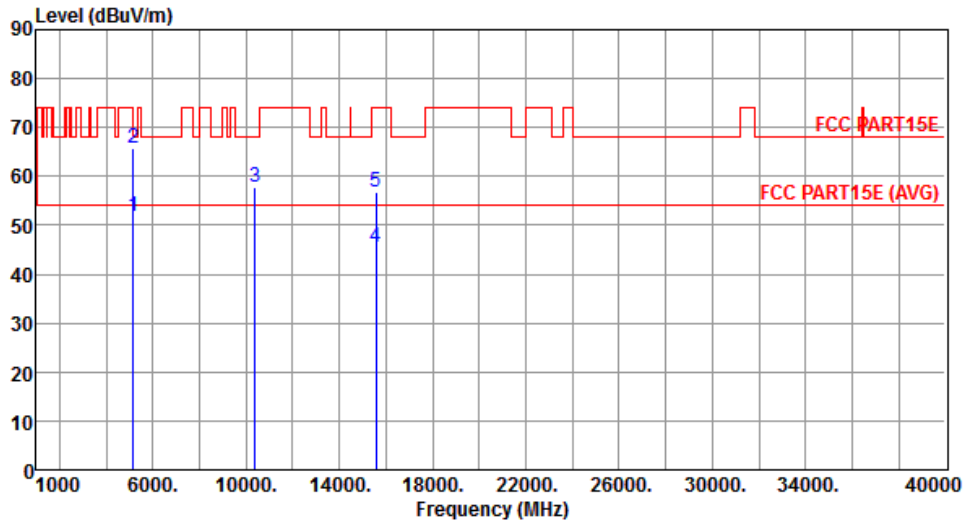

	Freq. MHz	Emission level dBuV/m	Limit dBuV/m	Margin dB	SA reading dBuV	Factor dB	Remark	ANT High cm	Turn Table deg
1	5150.00	51.73	54.00	-2.27	45.42	6.31	Average	139	251
2	5150.00	65.74	74.00	-8.26	59.43	6.31	Peak	139	251
3	10380.00	57.64	68.20	-10.56	41.27	16.37	Peak	216	17
4	15570.00	45.42	54.00	-8.58	27.99	17.43	Average	211	350
5	15570.00	56.75	74.00	-17.25	39.32	17.43	Peak	211	350

Note 1: Emission Level (dBuV/m) = SA Reading (dBuV/m) + Factor\* (dB)

\*Factor includes antenna factor , cable loss and amplifier gain

Note 2: Margin (dB) = Emission level (dBuV/m) – Limit (dBuV/m).

<b>Modulation</b>	HT40	<b>Test Freq. (MHz)</b>	5190
<b>Polarization</b>	Vertical	<b>Test Configuration</b>	3

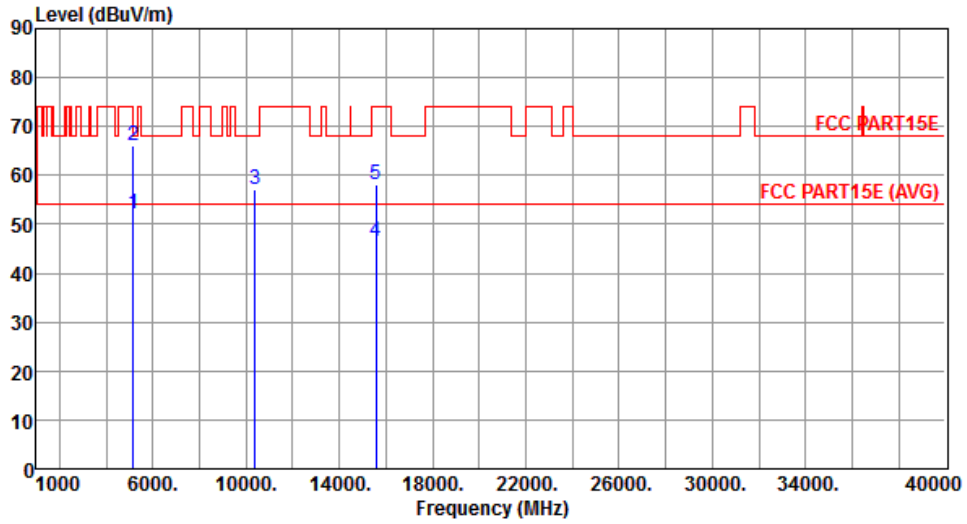

	Freq. MHz	Emission level dBuV/m	Limit dBuV/m	Margin dB	SA reading dBuV	Factor dB	Remark	ANT High cm	Turn Table deg
1	5150.00	52.06	54.00	-1.94	45.75	6.31	Average	145	24
2	5150.00	65.95	74.00	-8.05	59.64	6.31	Peak	145	24
3	10380.00	57.11	68.20	-11.09	40.74	16.37	Peak	231	354
4	15570.00	46.43	54.00	-7.57	29.00	17.43	Average	253	19
5	15570.00	58.05	74.00	-15.95	40.62	17.43	Peak	253	19

Note 1: Emission Level (dBuV/m) = SA Reading (dBuV/m) + Factor\* (dB)

\*Factor includes antenna factor , cable loss and amplifier gain

Note 2: Margin (dB) = Emission level (dBuV/m) – Limit (dBuV/m).

<b>Modulation</b>	HT40	<b>Test Freq. (MHz)</b>	5230
<b>Polarization</b>	Horizontal	<b>Test Configuration</b>	3

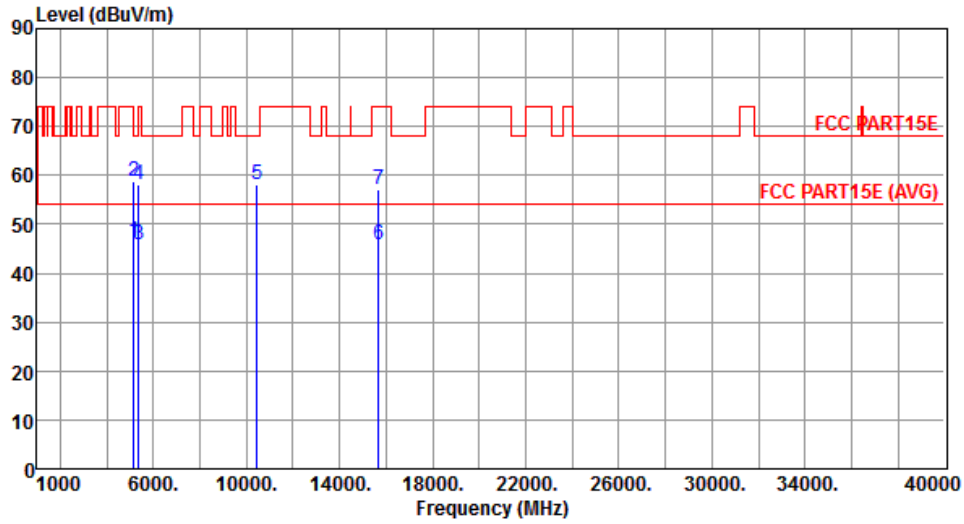

	Freq. MHz	Emission level dBuV/m	Limit dBuV/m	Margin dB	SA reading dBuV	Factor dB	Remark	ANT High cm	Turn Table deg
1	5150.00	46.43	54.00	-7.57	40.12	6.31	Average	228	229
2	5150.00	58.80	74.00	-15.20	52.49	6.31	Peak	228	229
3	5350.00	45.72	54.00	-8.28	39.10	6.62	Average	228	229
4	5350.00	58.12	74.00	-15.88	51.50	6.62	Peak	228	229
5	10460.00	58.20	68.20	-10.00	41.67	16.53	Peak	213	7
6	15690.00	45.97	54.00	-8.03	28.75	17.22	Average	213	341
7	15690.00	57.02	74.00	-16.98	39.80	17.22	Peak	213	341

Note 1: Emission Level (dBuV/m) = SA Reading (dBuV/m) + Factor\* (dB)

\*Factor includes antenna factor , cable loss and amplifier gain

Note 2: Margin (dB) = Emission level (dBuV/m) – Limit (dBuV/m).

<b>Modulation</b>	HT40	<b>Test Freq. (MHz)</b>	5230
<b>Polarization</b>	Vertical	<b>Test Configuration</b>	3

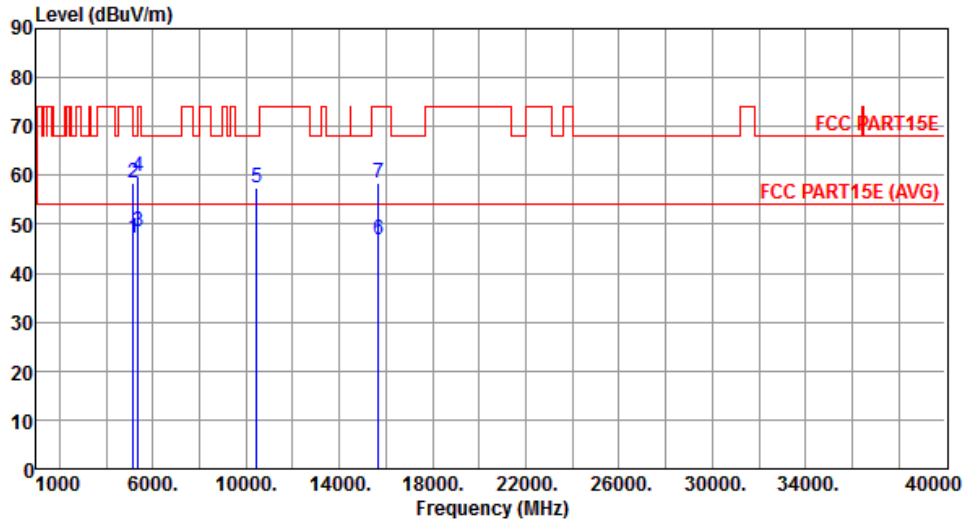

	Freq. MHz	Emission level dBuV/m	Limit dBuV/m	Margin dB	SA reading dBuV	Factor dB	Remark	ANT High cm	Turn Table deg
1	5150.00	47.27	54.00	-6.73	40.96	6.31	Average	103	223
2	5150.00	58.41	74.00	-15.59	52.10	6.31	Peak	103	223
3	5350.00	48.63	54.00	-5.37	42.01	6.62	Average	103	223
4	5350.00	59.77	74.00	-14.23	53.15	6.62	Peak	103	223
5	10460.00	57.60	68.20	-10.60	41.07	16.53	Peak	238	354
6	15690.00	46.81	54.00	-7.19	29.59	17.22	Average	259	13
7	15690.00	58.43	74.00	-15.57	41.21	17.22	Peak	259	13

Note 1: Emission Level (dBuV/m) = SA Reading (dBuV/m) + Factor\* (dB)

\*Factor includes antenna factor , cable loss and amplifier gain

Note 2: Margin (dB) = Emission level (dBuV/m) – Limit (dBuV/m).

<b>Modulation</b>	HT40	<b>Test Freq. (MHz)</b>	5270
<b>Polarization</b>	Horizontal	<b>Test Configuration</b>	3

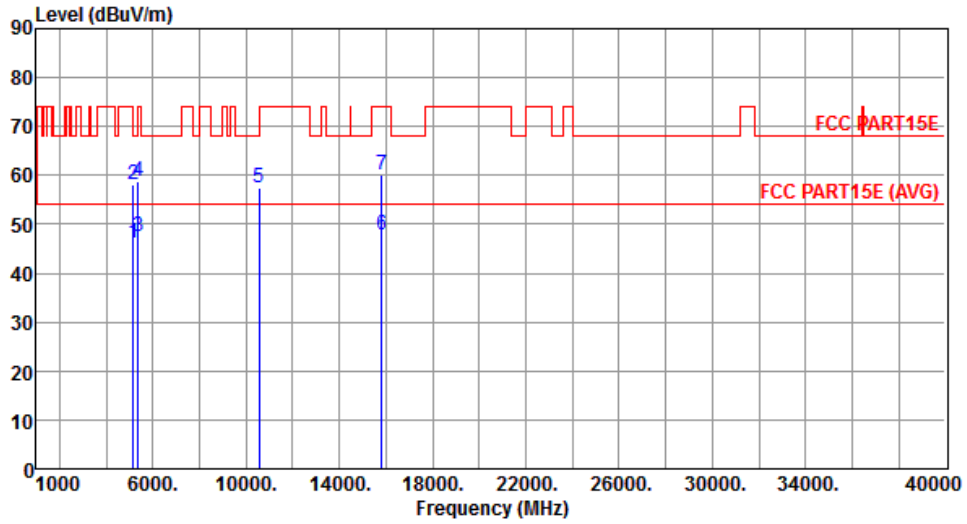

	Freq. MHz	Emission level dBuV/m	Limit dBuV/m	Margin dB	SA reading dBuV	Factor dB	Remark	ANT High cm	Turn Table deg
1	5150.00	46.21	54.00	-7.79	39.90	6.31	Average	147	25
2	5150.00	58.22	74.00	-15.78	51.91	6.31	Peak	147	25
3	5350.00	47.62	54.00	-6.38	41.00	6.62	Average	147	25
4	5350.00	58.89	74.00	-15.11	52.27	6.62	Peak	147	25
5	10540.00	57.60	68.20	-10.60	41.00	16.60	Peak	203	1
6	15810.00	47.92	54.00	-6.08	30.94	16.98	Average	215	24
7	15810.00	59.98	74.00	-14.02	43.00	16.98	Peak	215	24

Note 1: Emission Level (dBuV/m) = SA Reading (dBuV/m) + Factor\* (dB)

\*Factor includes antenna factor , cable loss and amplifier gain

Note 2: Margin (dB) = Emission level (dBuV/m) – Limit (dBuV/m).

<b>Modulation</b>	HT40	<b>Test Freq. (MHz)</b>	5270
<b>Polarization</b>	Vertical	<b>Test Configuration</b>	3

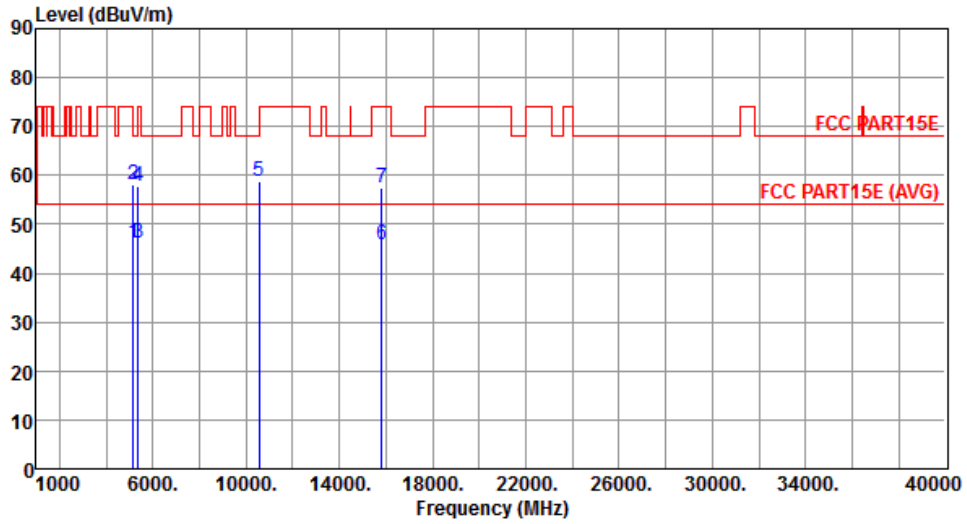

	Freq. MHz	Emission level dBuV/m	Limit dBuV/m	Margin dB	SA reading dBuV	Factor dB	Remark	ANT High cm	Turn Table deg
1	5150.00	46.11	54.00	-7.89	39.80	6.31	Average	175	230
2	5150.00	57.96	74.00	-16.04	51.65	6.31	Peak	175	230
3	5350.00	46.19	54.00	-7.81	39.57	6.62	Average	175	230
4	5350.00	57.91	74.00	-16.09	51.29	6.62	Peak	175	230
5	10540.00	58.69	68.20	-9.51	42.09	16.60	Peak	322	8
6	15810.00	45.86	54.00	-8.14	28.88	16.98	Average	377	301
7	15810.00	57.43	74.00	-16.57	40.45	16.98	Peak	377	301

Note 1: Emission Level (dBuV/m) = SA Reading (dBuV/m) + Factor\* (dB)

\*Factor includes antenna factor , cable loss and amplifier gain

Note 2: Margin (dB) = Emission level (dBuV/m) – Limit (dBuV/m).

<b>Modulation</b>	HT40	<b>Test Freq. (MHz)</b>	5310
<b>Polarization</b>	Horizontal	<b>Test Configuration</b>	3

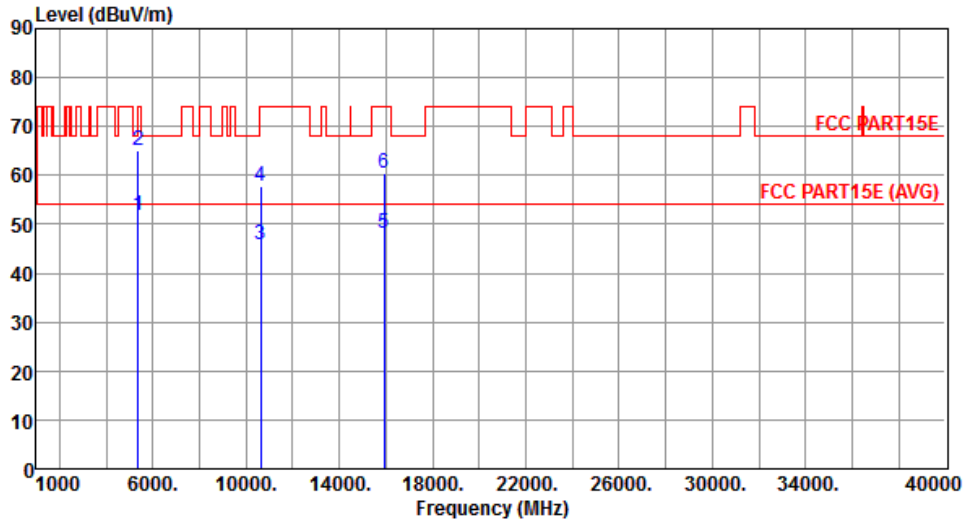

	Freq. MHz	Emission level dBuV/m	Limit dBuV/m	Margin dB	SA reading dBuV	Factor dB	Remark	ANT High cm	Turn Table deg
1	5350.00	51.67	54.00	-2.33	45.05	6.62	Average	104	221
2	5350.00	65.18	74.00	-8.82	58.56	6.62	Peak	104	221
3	10620.00	45.99	54.00	-8.01	29.37	16.62	Average	208	3
4	10620.00	57.87	74.00	-16.13	41.25	16.62	Peak	208	3
5	15930.00	48.15	54.00	-5.85	31.38	16.77	Average	204	21
6	15930.00	60.30	74.00	-13.70	43.53	16.77	Peak	204	21

Note 1: Emission Level (dBuV/m) = SA Reading (dBuV/m) + Factor\* (dB)

\*Factor includes antenna factor , cable loss and amplifier gain

Note 2: Margin (dB) = Emission level (dBuV/m) – Limit (dBuV/m).



<b>Modulation</b>	HT40	<b>Test Freq. (MHz)</b>	5310
<b>Polarization</b>	Vertical	<b>Test Configuration</b>	3

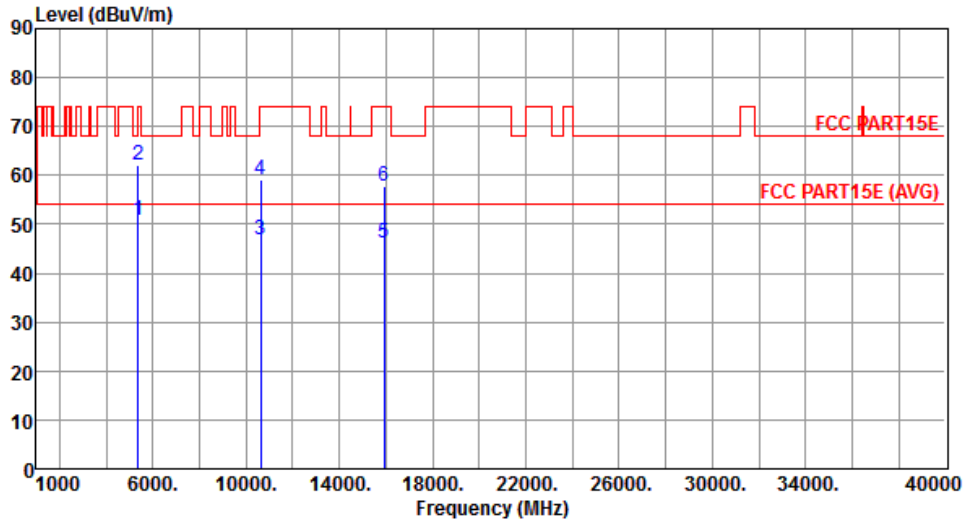

	Freq. MHz	Emission level dBuV/m	Limit dBuV/m	Margin dB	SA reading dBuV	Factor dB	Remark	ANT High cm	Turn Table deg
1	5350.00	50.78	54.00	-3.22	44.16	6.62	Average	226	228
2	5350.00	62.25	74.00	-11.75	55.63	6.62	Peak	226	228
3	10620.00	46.79	54.00	-7.21	30.17	16.62	Average	314	2
4	10620.00	58.95	74.00	-15.05	42.33	16.62	Peak	314	2
5	15930.00	46.11	54.00	-7.89	29.34	16.77	Average	362	307
6	15930.00	57.73	74.00	-16.27	40.96	16.77	Peak	362	307

Note 1: Emission Level (dBuV/m) = SA Reading (dBuV/m) + Factor\* (dB)

\*Factor includes antenna factor , cable loss and amplifier gain

Note 2: Margin (dB) = Emission level (dBuV/m) – Limit (dBuV/m).

<b>Modulation</b>	HT40	<b>Test Freq. (MHz)</b>	5510
<b>Polarization</b>	Horizontal	<b>Test Configuration</b>	3

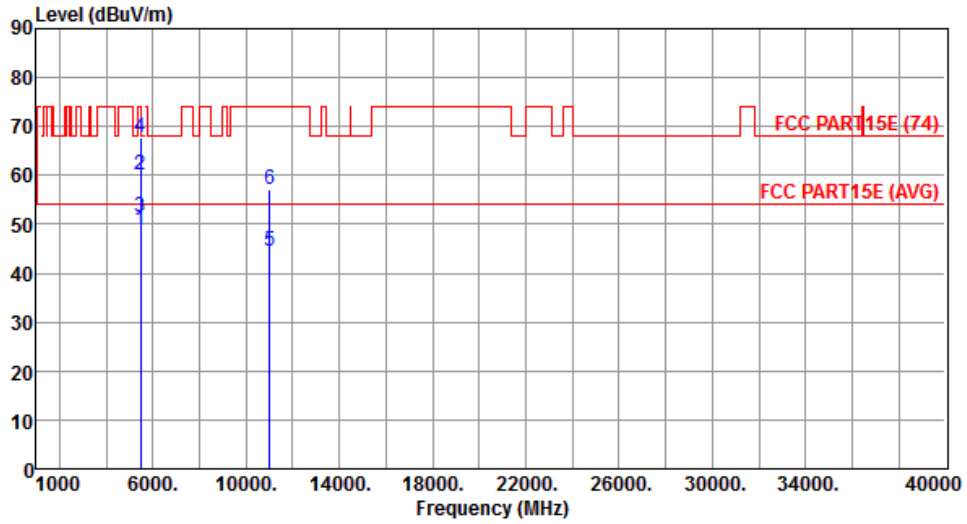

	Freq. MHz	Emission level dBuV/m	Limit dBuV/m	Margin dB	SA reading dBuV	Factor dB	Remark	ANT High cm	Turn Table deg
1	5460.00	48.77	54.00	-5.23	42.01	6.76	Average	140	28
2	5460.00	60.16	74.00	-13.84	53.40	6.76	Peak	140	28
3	5470.00	51.37	54.00	-2.63	44.60	6.77	Average	140	28
4	5470.00	67.59	74.00	-6.41	60.82	6.77	Peak	140	28
5	11020.00	44.35	54.00	-9.65	27.62	16.73	Average	308	303
6	11020.00	57.24	74.00	-16.76	40.51	16.73	Peak	308	303

Note 1: Emission Level (dBuV/m) = SA Reading (dBuV/m) + Factor\* (dB)

\*Factor includes antenna factor , cable loss and amplifier gain

Note 2: Margin (dB) = Emission level (dBuV/m) – Limit (dBuV/m).

<b>Modulation</b>	HT40	<b>Test Freq. (MHz)</b>	5510
<b>Polarization</b>	Vertical	<b>Test Configuration</b>	3

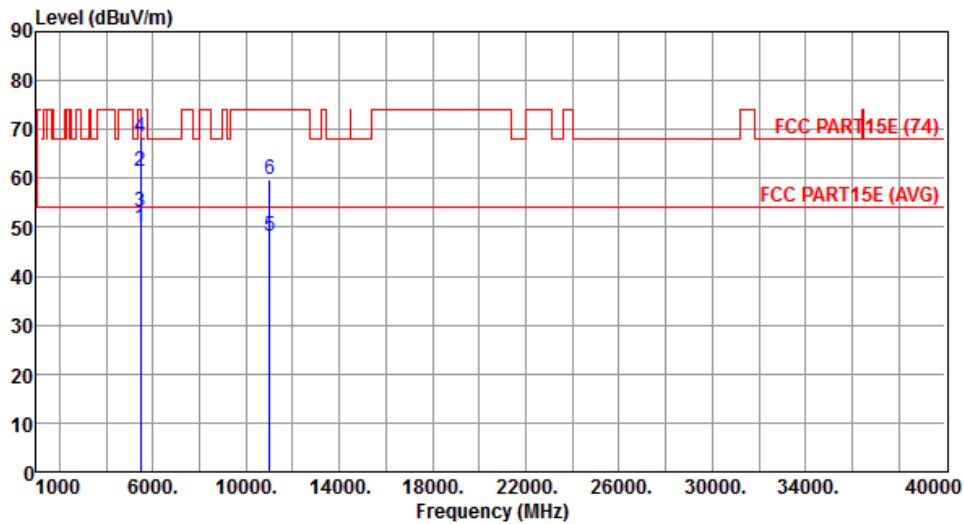

	Freq. MHz	Emission level dBuV/m	Limit dBuV/m	Margin dB	SA reading dBuV	Factor dB	Remark	ANT High cm	Turn Table deg
1	5460.00	49.78	54.00	-4.22	43.02	6.76	Average	219	3
2	5460.00	61.44	74.00	-12.56	54.68	6.76	Peak	219	3
3	5470.00	53.14	54.00	-0.86	46.37	6.77	Average	219	3
4	5470.00	68.44	74.00	-5.56	61.67	6.77	Peak	219	3
5	11020.00	48.10	54.00	-5.90	31.37	16.73	Average	219	3
6	11020.00	59.85	74.00	-14.15	43.12	16.73	Peak	219	3

Note 1: Emission Level (dBuV/m) = SA Reading (dBuV/m) + Factor\* (dB)

\*Factor includes antenna factor , cable loss and amplifier gain

Note 2: Margin (dB) = Emission level (dBuV/m) – Limit (dBuV/m).

<b>Modulation</b>	HT40	<b>Test Freq. (MHz)</b>	5590
<b>Polarization</b>	Horizontal	<b>Test Configuration</b>	3

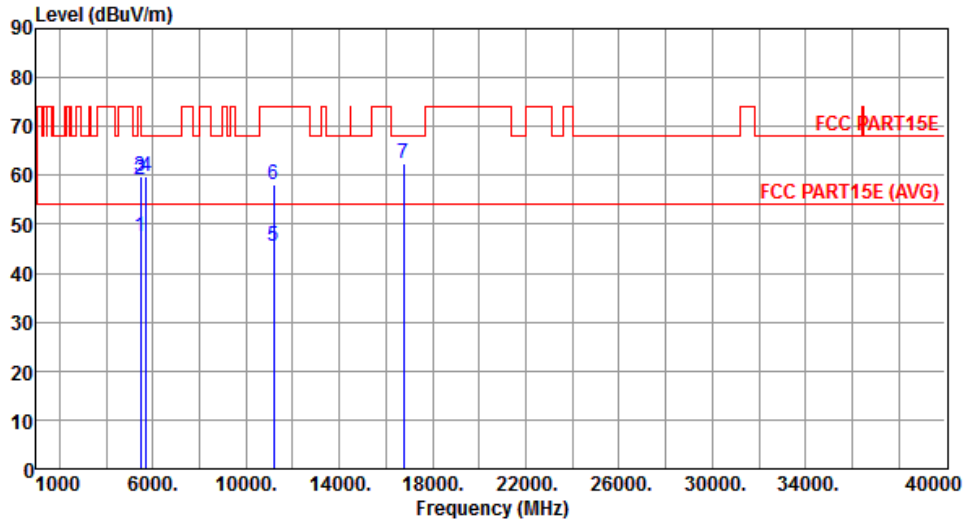

	Freq. MHz	Emission level dBuV/m	Limit dBuV/m	Margin dB	SA reading dBuV	Factor dB	Remark	ANT High cm	Turn Table deg
1	5460.00	47.60	54.00	-6.40	40.84	6.76	Average	131	28
2	5460.00	59.18	74.00	-14.82	52.42	6.76	Peak	131	28
3	5470.00	59.64	68.20	-8.56	52.87	6.77	Peak	131	28
4	5725.00	59.62	68.20	-8.58	52.38	7.24	Peak	131	28
5	11180.00	45.48	54.00	-8.52	28.69	16.79	Average	300	309
6	11180.00	58.25	74.00	-15.75	41.46	16.79	Peak	300	309
7	16770.00	62.53	68.20	-5.67	44.06	18.47	Peak	188	337

Note 1: Emission Level (dBuV/m) = SA Reading (dBuV/m) + Factor\* (dB)

\*Factor includes antenna factor , cable loss and amplifier gain

Note 2: Margin (dB) = Emission level (dBuV/m) – Limit (dBuV/m).

<b>Modulation</b>	HT40	<b>Test Freq. (MHz)</b>	5590
<b>Polarization</b>	Vertical	<b>Test Configuration</b>	3

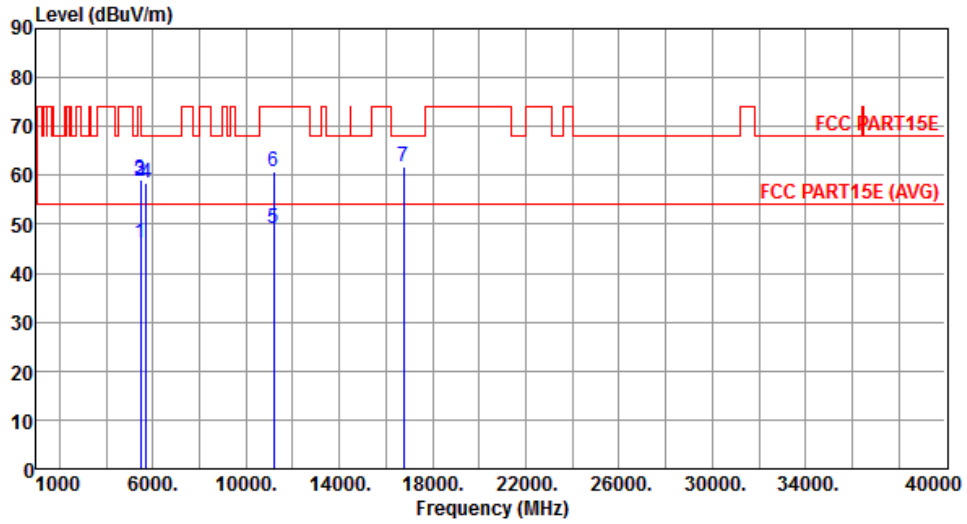

	Freq. MHz	Emission level dBuV/m	Limit dBuV/m	Margin dB	SA reading dBuV	Factor dB	Remark	ANT High cm	Turn Table deg
1	5460.00	46.30	54.00	-7.70	39.54	6.76	Average	116	350
2	5460.00	58.64	74.00	-15.36	51.88	6.76	Peak	116	350
3	5470.00	58.98	68.20	-9.22	52.21	6.77	Peak	116	350
4	5725.00	58.44	68.20	-9.76	51.20	7.24	Peak	116	350
5	11180.00	49.02	54.00	-4.98	32.23	16.79	Average	216	1
6	11180.00	60.78	74.00	-13.22	43.99	16.79	Peak	216	1
7	16770.00	61.66	68.20	-6.54	43.19	18.47	Peak	212	300

Note 1: Emission Level (dBuV/m) = SA Reading (dBuV/m) + Factor\* (dB)

\*Factor includes antenna factor , cable loss and amplifier gain

Note 2: Margin (dB) = Emission level (dBuV/m) – Limit (dBuV/m).

<b>Modulation</b>	HT40	<b>Test Freq. (MHz)</b>	5670
<b>Polarization</b>	Horizontal	<b>Test Configuration</b>	3

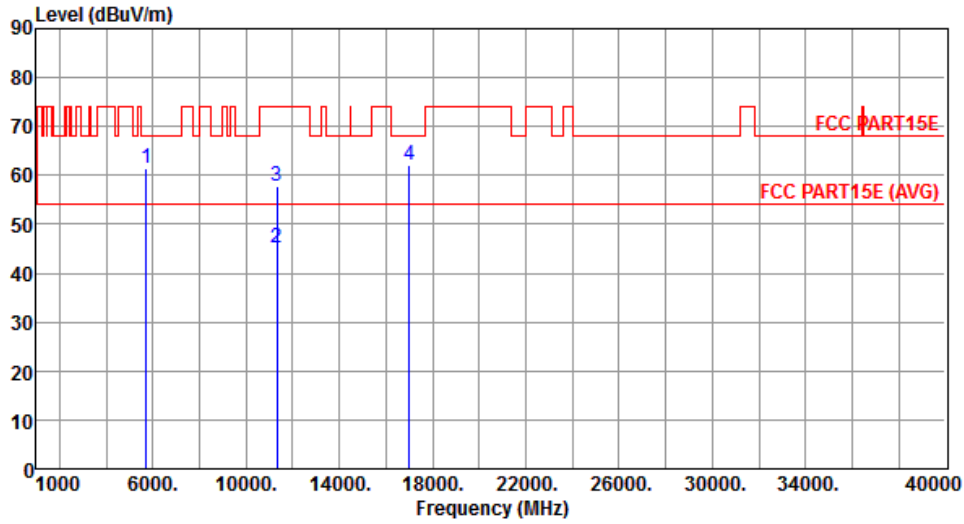

	Freq. MHz	Emission level dBuV/m	Limit dBuV/m	Margin dB	SA reading dBuV	Factor dB	Remark	ANT High cm	Turn Table deg
1	5725.00	61.34	68.20	-6.86	54.10	7.24	Peak	211	219
2	11340.00	45.06	54.00	-8.94	28.21	16.85	Average	295	300
3	11340.00	57.76	74.00	-16.24	40.91	16.85	Peak	295	300
4	17010.00	62.03	68.20	-6.17	43.04	18.99	Peak	182	326

Note 1: Emission Level (dBuV/m) = SA Reading (dBuV/m) + Factor\* (dB)

\*Factor includes antenna factor , cable loss and amplifier gain

Note 2: Margin (dB) = Emission level (dBuV/m) – Limit (dBuV/m).

<b>Modulation</b>	HT40	<b>Test Freq. (MHz)</b>	5670
<b>Polarization</b>	Vertical	<b>Test Configuration</b>	3

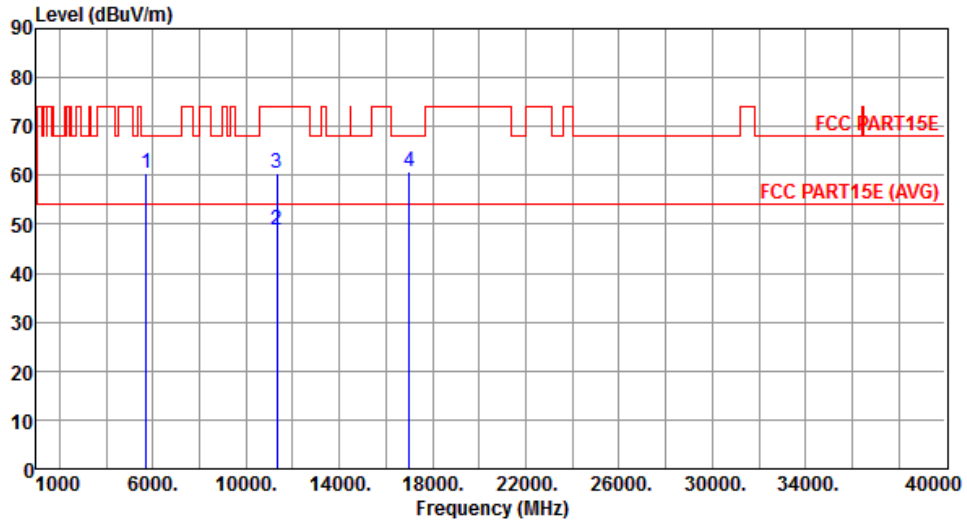

	Freq. MHz	Emission level dBuV/m	Limit dBuV/m	Margin dB	SA reading dBuV	Factor dB	Remark	ANT High cm	Turn Table deg
1	5725.00	60.58	68.20	-7.62	53.34	7.24	Peak	211	15
2	11340.00	48.71	54.00	-5.29	31.86	16.85	Average	211	15
3	11340.00	60.43	74.00	-13.57	43.58	16.85	Peak	211	15
4	17010.00	60.89	68.20	-7.31	41.90	18.99	Peak	218	294

Note 1: Emission Level (dBuV/m) = SA Reading (dBuV/m) + Factor\* (dB)

\*Factor includes antenna factor , cable loss and amplifier gain

Note 2: Margin (dB) = Emission level (dBuV/m) – Limit (dBuV/m).

<b>Modulation</b>	HT40	<b>Test Freq. (MHz)</b>	5755
<b>Polarization</b>	Horizontal	<b>Test Configuration</b>	3

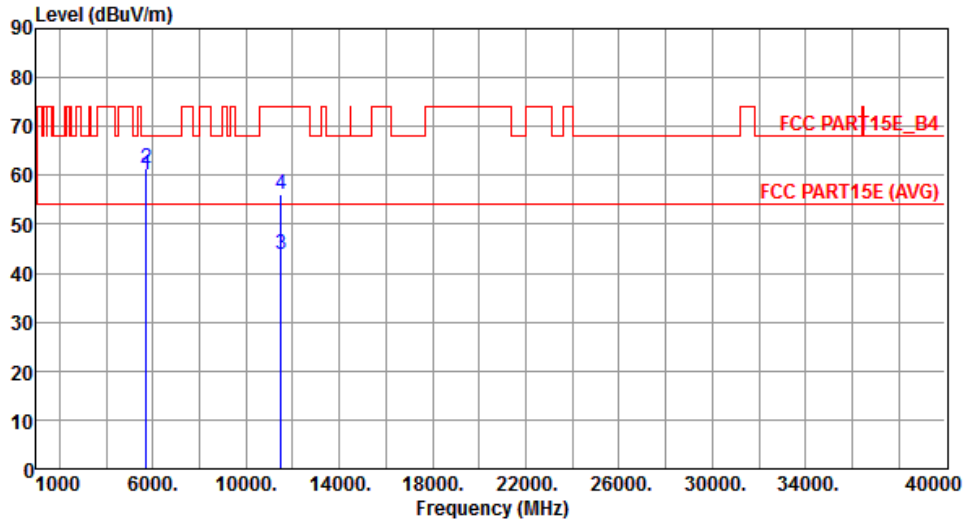

	Freq. MHz	Emission level dBuV/m	Limit dBuV/m	Margin dB	SA reading dBuV	Factor dB	Remark	ANT High cm	Turn Table deg
1	5715.00	60.24	68.20	-7.96	53.04	7.20	Peak	111	205
2	5725.00	61.32	78.20	-16.88	54.08	7.24	Peak	111	205
3	11510.00	43.87	54.00	-10.13	26.97	16.90	Average	188	341
4	11510.00	56.24	74.00	-17.76	39.34	16.90	Peak	188	341

Note 1: Emission Level (dBuV/m) = SA Reading (dBuV/m) + Factor\* (dB)

\*Factor includes antenna factor , cable loss and amplifier gain

Note 2: Margin (dB) = Emission level (dBuV/m) – Limit (dBuV/m).



<b>Modulation</b>	HT40	<b>Test Freq. (MHz)</b>	5755
<b>Polarization</b>	Vertical	<b>Test Configuration</b>	3

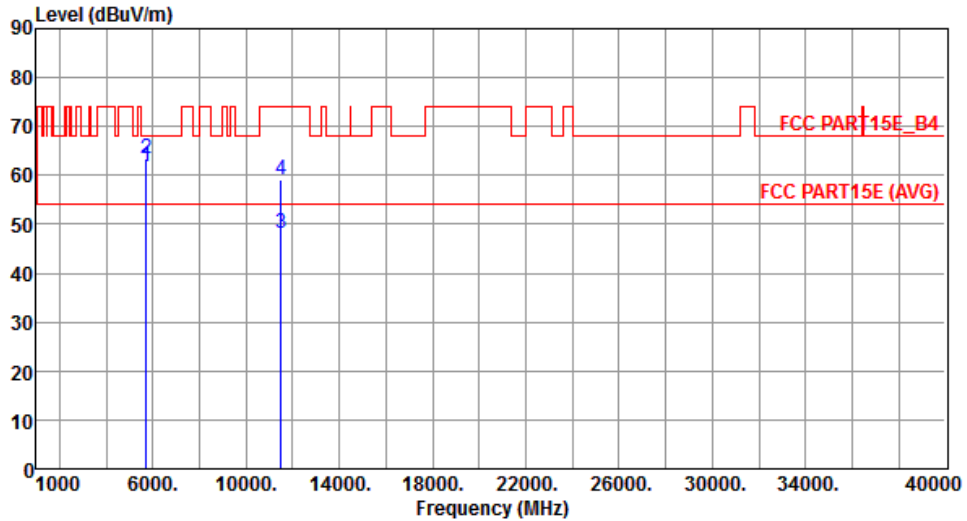

	Freq. MHz	Emission level dBuV/m	Limit dBuV/m	Margin dB	SA reading dBuV	Factor dB	Remark	ANT High cm	Turn Table deg
1	5715.00	61.69	68.20	-6.51	54.49	7.20	Peak	188	249
2	5725.00	63.49	78.20	-14.71	56.25	7.24	Peak	188	249
3	11510.00	48.12	54.00	-5.88	31.22	16.90	Average	240	12
4	11510.00	59.22	74.00	-14.78	42.32	16.90	Peak	240	12

Note 1: Emission Level (dBuV/m) = SA Reading (dBuV/m) + Factor\* (dB)

\*Factor includes antenna factor , cable loss and amplifier gain

Note 2: Margin (dB) = Emission level (dBuV/m) – Limit (dBuV/m).

<b>Modulation</b>	HT40	<b>Test Freq. (MHz)</b>	5795
<b>Polarization</b>	Horizontal	<b>Test Configuration</b>	3

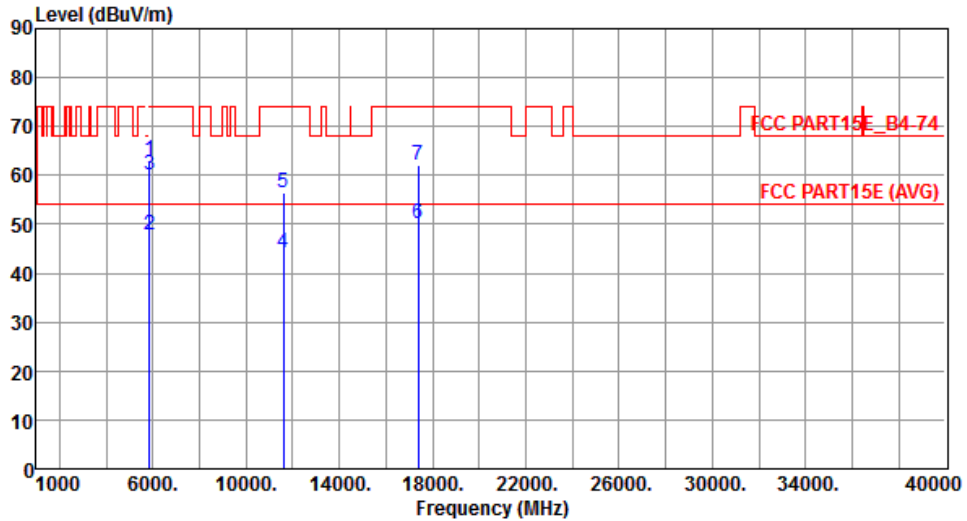

	Freq. MHz	Emission level dBuV/m	Limit dBuV/m	Margin dB	SA reading dBuV	Factor dB	Remark	ANT High cm	Turn Table deg
1	5850.00	62.96	78.20	-15.24	55.46	7.50	Peak	208	221
2	5860.00	47.68	54.00	-6.32	40.17	7.51	Average	208	221
3	5860.00	60.00	74.00	-14.00	52.49	7.51	Peak	208	221
4	11590.00	44.14	54.00	-9.86	27.38	16.76	Average	194	345
5	11590.00	56.59	74.00	-17.41	39.83	16.76	Peak	194	345
6	17385.00	50.28	54.00	-3.72	30.74	19.54	Average	327	299
7	17385.00	62.15	74.00	-11.85	42.61	19.54	Peak	327	299

Note 1: Emission Level (dBuV/m) = SA Reading (dBuV/m) + Factor\* (dB)

\*Factor includes antenna factor , cable loss and amplifier gain

Note 2: Margin (dB) = Emission level (dBuV/m) – Limit (dBuV/m).

<b>Modulation</b>	HT40	<b>Test Freq. (MHz)</b>	5795
<b>Polarization</b>	Vertical	<b>Test Configuration</b>	3

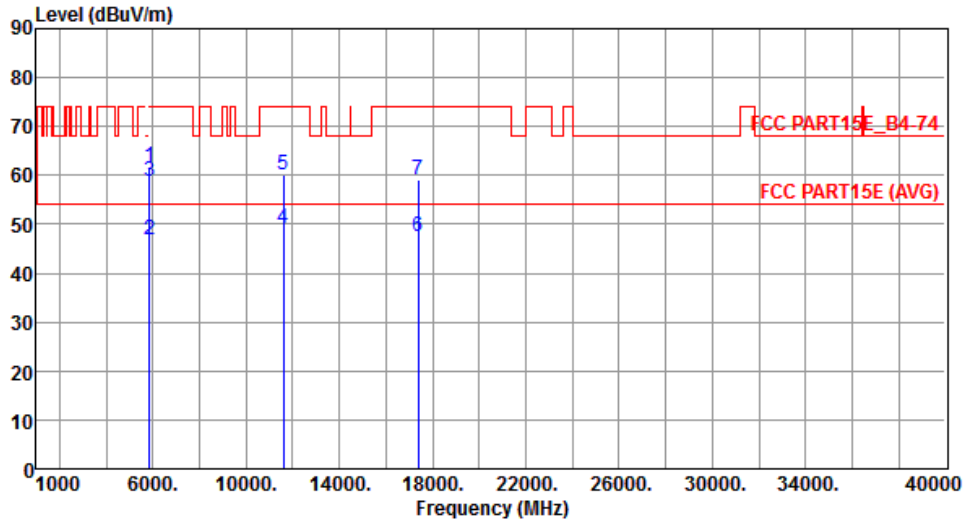

	Freq. MHz	Emission level dBuV/m	Limit dBuV/m	Margin dB	SA reading dBuV	Factor dB	Remark	ANT High cm	Turn Table deg
1	5850.00	61.87	78.20	-16.33	54.37	7.50	Peak	140	20
2	5860.00	46.83	54.00	-7.17	39.32	7.51	Average	140	20
3	5860.00	58.81	74.00	-15.19	51.30	7.51	Peak	140	20
4	11590.00	49.26	54.00	-4.74	32.50	16.76	Average	234	0
5	11590.00	60.26	74.00	-13.74	43.50	16.76	Peak	234	0
6	17385.00	47.60	54.00	-6.40	28.06	19.54	Average	275	28
7	17385.00	59.14	74.00	-14.86	39.60	19.54	Peak	275	28

Note 1: Emission Level (dBuV/m) = SA Reading (dBuV/m) + Factor\* (dB)

\*Factor includes antenna factor , cable loss and amplifier gain

Note 2: Margin (dB) = Emission level (dBuV/m) – Limit (dBuV/m).

## 3.6 Frequency Stability

### 3.6.1 Limit of Frequency Stability

Manufacturers of U-NII devices are responsible for ensuring frequency stability such that an emission is maintained within the band of operation under all conditions of normal operation as specified in the user's manual.

### 3.6.2 Test Procedures

1. The EUT is installed in an environment test chamber with external power source.
2. Set the chamber to operate at 50 centigrade and external power source to output at nominal voltage of EUT.
3. A sufficient stabilization period at each temperature is used prior to each frequency measurement.
4. When temperature is stabled, measure the frequency stability.
5. The test shall be performed under -40 to 85 centigrade and 85 to 115 percent of the nominal voltage. Change setting of chamber and external power source to complete all conditions.

### 3.6.3 Test Setup

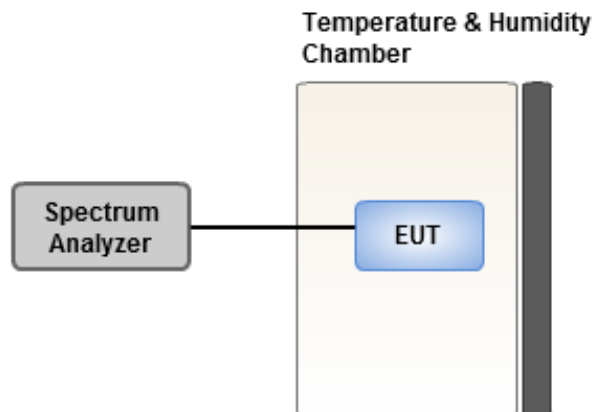

### 3.6.4 Test Result of Frequency Stability

Frequency: 5320 MHz	Frequency Drift (ppm)			
	0 minute	2 minutes	5 minutes	10 minutes
T20°CVmax	-0.12	0.45	-0.11	0.04
T20°CVmin	-0.29	-0.74	-0.20	-0.15
T85°CVnom	-0.07	-0.23	0.15	0.12
T80°CVnom	1.35	1.50	2.11	1.51
T70°CVnom	0.31	0.85	0.45	-0.20
T60°CVnom	0.84	1.16	0.81	0.87
T50°CVnom	1.09	1.66	1.27	1.27
T40°CVnom	0.28	0.86	-0.19	0.22
T30°CVnom	0.53	0.48	0.53	0.37
T20°CVnom	0.42	1.03	0.48	0.67
T10°CVnom	0.28	0.39	-0.27	0.66
T0°CVnom	-0.31	0.11	-0.04	0.52
T-10°CVnom	-0.27	-0.44	-0.71	-0.12
T-20°CVnom	0.00	0.47	0.04	0.19
T-30°CVnom	-0.39	-0.33	0.12	0.39
T-40°CVnom	0.84	1.32	1.01	0.61
Vnom [Vdc]: 3.30		Vmax [Vdc]: 3.46		Vmin [Vdc]: 3.20
Tnom [°C]: 20		Tmax [°C]: 85		Tmin [°C]: -40

<b>Frequency: 5785 MHz</b>	<b>Frequency Drift (ppm)</b>			
<b>Temperature (°C)</b>	<b>0 minute</b>	<b>2 minutes</b>	<b>5 minutes</b>	<b>10 minutes</b>
T20°CVmax	4.82	5.03	5.06	5.27
T20°CVmin	3.84	3.62	3.93	4.04
T85°CVnom	2.92	3.27	3.43	3.65
T80°CVnom	2.95	2.72	3.02	3.33
T70°CVnom	2.04	2.25	1.73	2.13
T60°CVnom	0.39	0.90	0.36	0.19
T50°CVnom	4.30	4.58	4.48	3.99
T40°CVnom	2.82	2.53	3.39	2.59
T30°CVnom	2.70	2.97	2.95	3.17
T20°CVnom	2.02	2.26	2.06	2.54
T10°CVnom	2.47	2.94	2.72	2.48
T0°CVnom	3.06	3.50	3.38	3.41
T-10°CVnom	1.79	1.98	2.21	1.37
T-20°CVnom	0.49	0.59	0.63	0.60
T-30°CVnom	1.25	1.34	1.33	1.47
T-40°CVnom	0.46	0.04	0.50	0.76
Vnom [Vdc]: 3.30		Vmax [Vdc]: 3.46		Vmin [Vdc]: 3.20
Tnom [°C]: 20		Tmax [°C]: 85		Tmin [°C]: -40

## 4 Test laboratory information

Established in 2012, ICC provides foremost EMC & RF Testing and advisory consultation services by our skilled engineers and technicians. Our services employ a wide variety of advanced edge test equipment and one of the widest certification extents in the business.

International Certification Corp, it is our definitive objective is to institute long term, trust-based associations with our clients. The expectation we set up with our clients is based on outstanding service, practical expertise and devotion to a certified value structure. Our passion is to grant our clients with best EMC / RF services by oriented knowledgeable and accommodating staff.

Our Test sites are located at Linkou District and Kwei Shan Hsiang. Location map can be found on our website <http://www.icertifi.com.tw>.

### **Linkou**

Tel: 886-2-2601-1640

No. 30-2, Ding Fwu Tsuen, Lin  
Kou District, New Taipei City,  
Taiwan, R.O.C.

### **Kwei Shan**

Tel: 886-3-271-8666

No. 3-1, Lane 6, Wen San 3rd St.,  
Kwei Shan Hsiang, Tao Yuan  
Hsien 333, Taiwan, R.O.C.

### **Kwei Shan Site II**

Tel: 886-3-271-8640

No. 14-1, Lane 19, Wen San 3rd  
St., Kwei Shan Hsiang, Tao Yuan  
Hsien 333, Taiwan, R.O.C.

If you have any suggestion, please feel free to contact us as below information

Tel: 886-3-271-8666

Fax: 886-3-318-0155

Email: ICC\_Service@icertifi.com.tw

==END==