

User Guide

MSD50NBT

Version 1.0

REVISION HISTORY

Version	Date	Notes	Approver
1.0	22 Feb 2016	Initial Release	Andrew Chen

CONTENTS

Scope	4
MSD50NBT Features Summary	4
Specifications.....	5
WLAN Functional Description.....	11
Overview.....	11
Bluetooth Functional Description.....	13
Electrical Characteristics.....	14
Bluetooth Radio Characteristics	19
SDIO Timing Requirements.....	21
Pin Definitions	22
MSD40NBT, MSD45N, and MSD50NBT Pin Comparison Table	24
Mechanical Specifications	27
Mounting	27
Reference Schematic of MSD50NBT	28
RF Layout Design Guidelines/Precautions.....	28
Regulatory	29
Certified Antennas.....	29
FCC and Industry Canada Regulatory	29
FCC.....	30
Industry Canada.....	31
European Union Regulatory	34
EU Declarations of Conformity.....	34
Ordering Information	35
General Comments.....	35
Labeling Requirements.....	36

Scope

This document describes key hardware aspects of the Laird MSD50NBT module. This document is intended to assist device manufacturers and related parties with the integration of this radio into their host devices. Data in this document is drawn from a number of sources and includes information found in the Qualcomm Atheros (QCA) QCA6004 and Cambridge Silicon Radio Ltd. (CSR) CSR8811 A08 data sheet issued in July 2011, along with other documents provided from QCA and CSR.



This Laird 50-series module is currently in development stage and this document is preliminary. The information in this document is subject to change. Please contact Laird to obtain the most recent version of this document.

MSD50NBT FEATURES SUMMARY

The Laird MSD50NBT device features are described in [Table 1](#).

Table 1: MSD50NBT features

Feature	Description
Radio Front End	Integrates the complete transmit/receive RF paths including baluns, coexistence band pass filter, diplexer, switches, power amplifier, low noise amplifier, and reference crystal oscillator.
Enhanced WLAN/BT Coexistence Algorithms	Enhanced important use cases including: <ul style="list-style-type: none">▪ PCM/I2S digital audio interface▪ BT stereo audio (A2DP)▪ BT data transfer profiles (such as OPP and FTP)▪ BT2.1+EDR▪ BT-LE Flexible radio architecture ensures simple customization for future use cases.
Power Management	Uses power-saving techniques including: <ul style="list-style-type: none">▪ Gating clocks to idle or inactive blocks▪ Fast start and settling circuits to reduce Tx power▪ Active duty cycles▪ CPU frequency scaling
Pre-Calibration	RF system tested and calibrated in production.
Internal Sleep Clock	Integrated on-chip low power sleep clock to regulate internal timing.
Multiple Interface Support	<ul style="list-style-type: none">▪ SDIO 2.0 (50 MHz, 4-bit and 1-bit)▪ HS-UART for Bluetooth HCI (compatible with any upper layer Bluetooth stack)
Advanced 802.11n	<ul style="list-style-type: none">▪ Half Guard Interval and Frame Aggregation for high throughput▪ Space Time Block Coding (STBC) Rx for improved downlink robustness over range▪ Low Density Parity Check (LDPC) for improved uplink and downlink robustness over range
Reference Frequency	<ul style="list-style-type: none">▪ Incorporates a 26 MHz reference frequency source in package▪ Sleep regulated and gated to enable the internal crystal to be powered down when the device is in sleep mode▪ BT shares the clock from the Wi-Fi chip.▪ Wi-Fi cannot be turned off or in reset statue when running BT.

Feature	Description
Advanced WLAN	<p>Includes the following advanced WLAN features:</p> <ul style="list-style-type: none"> IEEE 802.11e QoS, Wi-Fi Alliance WMM Power Save, and 802.11n power saving compliance AES, AES-CCMP, TKIP engines for faster data encryption Cisco CCXv4 ASD, WPS support Standard WEP/WPA/WPA2 for personal and enterprise environments support WWR, 802.11d, 802.11h support Wi-Fi Direct (Peer-to-Peer) RTT for indoor positioning Statistics and events for monitoring Self-managed power state handling Self-contained beacon processing Shared authentication Ad-hoc power save Multiple PMK ID support Simulated UAPSD T-Spec support Production flow diagnostics 3-wire scheme for Wi-Fi and BT coexistence.
Host Offloading (WLAN)	Integrates extensive hardware signal processing and an embedded on-chip CPU to offload complete 11n MAC/BB/PHY processing to minimize host processor loading and support application specific customization.
Advanced Bluetooth	<ul style="list-style-type: none"> High-speed UART port (up to 4 Mbps) HFP v1.6 wide-band speech supported on-chip On-chip encoding of SBC and aptX® codecs for A2DP music streaming PCM/I2S digital audio interface Support for IEEE 802.11 coexistence The flexible RAM/ROM based architecture enables custom or future profiles to be easily added.

SPECIFICATIONS

Table 2: Specifications



Feature	Description
Physical Interface	60-pin board to board connector (Molex 54722-0607)
Wi-Fi Interface	1-bit or 4-bit Secure Digital I/O
Bluetooth Interface	Host Controller Interface (HCI) using High Speed UART
Main Chip	Wi-Fi: Qualcomm Atheros QCA6004. BT: Cambridge Silicon Radio Ltd. (CSR) CSR8811 A08
Input Voltage Requirements	3.3 VDC (3.20V min to 3.46V max)
I/O Signalling Voltage	3.3 VDC ± 5% or 1.8 VDC ± 5%

Feature	Description
Average Current Consumption, VDDIO = 3.3 volts (At maximum transmit power setting) <i>Note: Standby refers to the radio operating in PM1 power saving mode.</i> <i>Note: MIMO measurements are generally higher than Single Stream.</i>	Single Stream 802.11a (with BT in standby) @ 18 dBm 6 Mbps Transmit: 600 mA Receive: 120 mA Standby: TBD mA 802.11b (with BT in standby) @ 18 dBm 1 Mbps Transmit: 460 mA Receive: 120 mA Standby: TBD mA 802.11g (with BT in standby) @ 18 dBm 6 Mbps Transmit: 450 mA Receive: 250 mA Standby: 130 mA 802.11n (2.4 GHz) (with BT in standby) @ 14 dBm MCS7 Transmit: 340 mA Receive: 120mA Standby: TBD mA 802.11n (5 GHz) (with BT in standby) @ 14 dBm MCS7 Transmit: 490 mA Receive: 120 mA Standby: TBD mA Bluetooth (with Wi-Fi in standby) Transmit: 85 mA Receive: 70 mA Standby: TBD mA
	MIMO 802.11a (with BT in standby) @ 18 dBm 6 Mbps Transmit: 900 mA Receive: 140 mA Standby: TBD mA 802.11b (with BT in standby) @ 18 dBm 1 Mbps Transmit: 680 mA Receive: 140 mA Standby: TBD mA 802.11g (with BT in standby) @ 18 dBm 6 Mbps Transmit: 710 mA Receive: 140 mA Standby: TBD mA 802.11n (2.4 GHz) (with BT in standby) @ 14 dBm MCS7 Transmit: 460 mA Receive: 140 mA Standby: TBD mA 802.11n (5 GHz) (with BT in standby) @ 14 dBm MCS7 Transmit: 720 mA Receive: 140 mA Standby: TBD mA Bluetooth (with Wi-Fi in standby) Transmit: TBD mA Receive: TBD mA Standby: TBD mA
Operating Temperature	-30° to 85°C (-22° to 185°F)
Operating Humidity	10 to 90% (non-condensing)
Storage Temperature	-40° to 85°C (-40° to 185°F)
Storage Humidity	10 to 90% (non-condensing)
Maximum Electrostatic Discharge	Conductive 4KV; Air coupled 8KV EN61000-4-2
Size	32 mm (length) x 22 mm (width) x 4.7 mm (thickness)
Weight	TBD
Mounting	Please see the mounting and handling guide.
Wi-Fi Media	Direct Sequence-Spread Spectrum (DSSS) Complementary Code Keying (CCK) Orthogonal Frequency Divisional Multiplexing (OFDM)
Bluetooth Media	Frequency Hopping Spread Spectrum (FHSS)
Wi-Fi Media Access Protocol	Carrier sense multiple access with collision avoidance (CSMA/CA)

Feature	Description
Network Architecture Types	Infrastructure and ad-hoc
Wi-Fi Standards	IEEE 802.11a, 802.11b, 802.11d, 802.11e, 802.11g, 802.11h, 802.11i, 802.11n, 802.11r
Bluetooth Standards	Bluetooth version 2.1 with Enhanced Data Rate Bluetooth 4.0 (Bluetooth Low Energy or BLE)
Wi-Fi Data Rates Supported	11a (OFDM) 6, 9, 12, 18, 24, 36, 48, 54 Mbps 802.11b (DSSS, CCK) 1, 2, 5.5, 11 Mbps 802.11g (OFDM) 6, 9, 12, 18, 24, 36, 48, 54 Mbps 802.11n (OFDM, MCS 0-15) Full Guard Interval: 6.5,13.0, 19.5, 26.0,39.0,52.0,58.5,65.0, 13.0,26.0,39.0, 52.0, 78.0,104.0,117.0 Mbps Short Guard Interval: 1.2,14.4,21.7,29.9,43.3,57.8,65.0,72.2, 14.4,28.9,43.3,57.8, 86.7,115.6,130.0,144.4 Mbps
Modulation	BPSK @ 1, 6,9, 6.5, 7.2,13 and 14.4 Mbps QPSK @ 2, 12, 18, 13, 14.4,19.5, 21.7, 26, 28.9, 39,43.3 Mbps CCK @ 5.5 and 11 Mbps 16-QAM @ 24, 36,26, 29.9,39,43.3,52,57.8,78,86.7 Mbps 64-QAM @ 48,54,52, 57.8, 58.5, 65,72.2,104.0,115.6,117.0,130.0,144.4 Mbps
802.11n Spatial Streams	2 (2x2 MIMO)
Bluetooth Data Rates Supported	1, 2, 3 Mbps
Bluetooth Modulation	GFSK@ 1 Mbps Pi/4-DQPSK@ 2 Mbps 8-DPSK@ 3 Mbps
Regulatory Domain Support	FCC (Americas, Parts of Asia, and Middle East) ETSI (Europe, Middle East, Africa, and Parts of Asia) IC (Industry Canada) MIC (Japan) (formerly TELEC) – Option KC (Korea) (formerly KCC) – Option
2.4 GHz Frequency Bands	ETSI: 2.4 GHz to 2.483 GHz FCC: 2.4 GHz to 2.473 GHz MIC: 2.4 GHz to 2.495 GHz KC: 2.4 GHz to 2.483 GHz
2.4 GHz Operating Channels (Wi-Fi)	ETSI: 13 (3 non-overlapping) FCC: 11 (3 non-overlapping) MIC: 14 (4 non-overlapping) KC: 13 (3 non-overlapping)

Feature	Description
5 GHz Frequency Bands	<p>ETSI</p> <p>5.15 GHz to 5.35 GHz (Ch 36/40/44/48/52/56/60/64)</p> <p>5.47 GHz to 5.725 GHz (Ch 100/104/108/112/116/120/124/128/132/136/140/144)</p> <p>FCC</p> <p>5.15 GHz to 5.35 GHz (Ch 36/40/44/48/52/56/60/64)</p> <p>5.47 GHz to 5.725 GHz (Ch 100/104/108/112/116/120/124/128/132/136/140/144)</p> <p>5.725 GHz to 5.825 GHz (Ch 149/153/157/161/165)</p> <p>MIC (Japan)</p> <p>5.15 GHz to 5.35 GHz (Ch 36/40/44/48/52/56/60/64)</p> <p>KC</p> <p>5.15 GHz to 5.35 GHz (Ch 36/40/44/48/52/56/60/64)</p> <p>5.725 GHz to 5.825 GHz (Ch 149/153/157/161/165)</p>
5 GHz Operating Channels (Wi-Fi)	<p>ETSI: 19 non-overlapping</p> <p>FCC: 25 non-overlapping</p> <p>MIC: (Japan): 8 non-overlapping</p> <p>KC: 12 non-overlapping</p>

Feature	Description
Transmit Power <i>Note: Transmit power on each channels varies according to individual country regulations. All values for lowest data rate is nominal, +/-2 dBm. Others are +/-2.5dBm.</i> Note: HT40 – 40 Mhz-wide channels HT20 – 20 MHz-wide channels	802.11a 6 Mbps 17 dBm 54 Mbps 14 dBm 802.11b 1 Mbps 17 dBm 11 Mbps 17 dBm 802.11g 6 Mbps 17 dBm 54 Mbps 14 dBm 802.11n (2.4 GHz) 6.5 Mbps (MCS0) 17 dBm 65 Mbps (MCS7) 13 dBm 802.11n (5 GHz) 6.5 Mbps (MCS0;HT20) 17 dBm 65 Mbps (MCS7;HT20) 13 dBm (MCS0;HT40) 14 dBm (MCS7; HT40) 11 dBm Bluetooth 1 Mbps 6 dBm 2 Mbps 6 dBm 3 Mbps 3 dBm
	Typical Receiver Sensitivity <i>Note: All values nominal, +/-3 dBm.</i> 802.11a: 6 Mbps -92 dBm 54 Mbps -74 dBm (PER <= 10%) 802.11b: 1 Mbps -94 dBm 11 Mbps -87 dBm (PER <= 10%) 802.11g: 6 Mbps -91 dBm 54 Mbps -74 dBm (PER <= 10%) 802.11n (2.4 GHz) MCS0 Mbps -91 dBm MCS7 Mbps -71 dBm 802.11n (5 GHz) MCS0 Mbps -92 dBm MCS7 Mbps -71 dBm Bluetooth: 1 Mbps -83 dBm (1DH1) 3 Mbps -75 dBm (3DH5) BLE -86 dBm
	Operating Systems Supported Windows Mobile 5.0, 6.0, 6.1, 6.5 Windows Embedded Compact (CE) 5.0, 6.0, 7.0, 2013 Windows 7, 8, 8.1 Linux 2.6.x, 3.x.x, 4.0.x kernel Android 4.1.2 (Jellybean) and forward

Feature	Description								
Security	<p>Standards</p> <ul style="list-style-type: none"> Wireless Equivalent Privacy (WEP) Wi-Fi Protected Access (WPA) IEEE 802.11i (WPA2) <p>Encryption</p> <ul style="list-style-type: none"> Wireless Equivalent Privacy (WEP, RC4 Algorithm) Temporal Key Integrity Protocol (TKIP, RC4 Algorithm) Advanced Encryption Standard (AES, Rijndael Algorithm) <p>Encryption Key Provisioning</p> <ul style="list-style-type: none"> Static (40-bit and 128-bit lengths) Pre-Shared (PSK) <p>Dynamic</p> <p>802.1X Extensible Authentication Protocol Types</p> <table border="0"> <tr> <td>EAP-FAST</td> <td>PEAP-MSCHAPv2</td> </tr> <tr> <td>EAP-TLS</td> <td>PEAP-TLS</td> </tr> <tr> <td>EAP-TTLS</td> <td>LEAP</td> </tr> <tr> <td>PEAP-GTC</td> <td></td> </tr> </table>	EAP-FAST	PEAP-MSCHAPv2	EAP-TLS	PEAP-TLS	EAP-TTLS	LEAP	PEAP-GTC	
EAP-FAST	PEAP-MSCHAPv2								
EAP-TLS	PEAP-TLS								
EAP-TTLS	LEAP								
PEAP-GTC									
Compliance	<p>ETSI Regulatory Domain</p> <ul style="list-style-type: none"> EN 300 328 (Wi-Fi®) EN 300 328 v1.8.1 (BT 2.1) EN 301 489-1 EN 301 489-17 EN 301 892 EN 60950-1 EU 2002/95/EC (RoHS) <p>FCC Regulatory Domain</p> <ul style="list-style-type: none"> FCC 15.247 DTS – 802.11b/g (Wi-Fi) – 2.4 GHz FCC 15.407 UNII – 802.11a (Wi-Fi) – 5 GHz FCC 15.247 DSS – BT 2.1 <p>Industry Canada</p> <ul style="list-style-type: none"> RSS-247 – 802.11a/b/g/n (Wi-Fi) – 2.4 GHz, 5.8 GHz, 5.2 GHz, and 5.4 GHz RSS-247 – BT 2.1 								
Certifications	<p>Wi-Fi Alliance</p> <ul style="list-style-type: none"> 802.11a, 802.11b, 802.11g , 802.11n WPA Enterprise WPA2 Enterprise <p>Cisco Compatible Extensions (Version 4)</p> <p>Bluetooth SIG Qualification</p> <div style="text-align: right;">    </div>								
Warranty	Five Year Limited Lifetime								

All specifications are subject to change without notice

WLAN FUNCTIONAL DESCRIPTION

Overview

The MSD50NBT WLAN block is based on the Qualcomm-Atheros AR6004 802.11a/b/g/n chipset. It is optimized for low power embedded applications and is configured to operate in dual-band, two-stream (2x2 MIMO) mode. Its functionality includes:

- Improved throughput on the link due to frame aggregation, RIFS (reduced inter-frame spacing), and half guard intervals.
- Support for STBC (space time block codes) and LDPC (Low Density Parity Check) codes.
- Improved 11n performance due to features such as 11n frame aggregation (A-MPDU and A-MSDU) and low-overhead host-assisted buffering (RX A-MSDU and RX A-MPDU). These techniques can improve performance and efficiency of applications involving large bulk data transfers such as file transfers or high-resolution video streaming.

Other functionality includes the following:

Feature	Description
Reset Control	<p>CHIP_PWD_L and BT_RST_L pins must be asserted low to reset Wi-Fi and Bluetooth. After these signals are de-asserted, the radio waits for host communication. Until then, all modules except the host interface are held in reset.</p> <p>Once the host has initiated communication, the radio turns on its crystal and then the PLL. After all clocks are stable and running, the block resets are automatically de-asserted.</p> <p>Note: Because BT chip derives clock from WLAN, the Bluetooth function should be powered down/reset whenever WLAN is reset.</p>
System Clocking (RTC Block)	<p>The MSD50NBT has an RTC block which controls the clocks and power going to other internal modules. Its inputs consist of sleep requests from these modules and its outputs consists of clock enable and power signals which are used to gate the clocks going to these modules. The RTC block also manages resets going to other modules with the device. The MSD50NBT's clocking is grouped into two types: high-speed and low-speed.</p> <p><i>High Speed Clocking</i></p> <p>The reference 26 MHz clock source inside the MSD50NBT drives the PLL and RF synthesizer of Wi-Fi and Bluetooth. To minimize power consumption, the reference clock source is powered off in SLEEP, HOST_OFF, and OFF states.</p> <p><i>Low Speed Clocking</i></p> <p>The MSD50NBT has an 32.768 KHz oscillator that provide slow clock for BT to get deep sleep mode.</p> <p><i>Interface Clock</i></p> <p>The host interface clock represents another clock domain for the MSD50NBT. This clock comes from the SDIO and is independent from the other internal clocks. It drives the host interface logic as well as certain registers which can be accessed by the host in HOST_OFF and SLEEP states.</p>

Feature	Description
MAC/BB/RF Block	<p>The MSD50NBT Wireless MAC consists of five major blocks:</p> <ul style="list-style-type: none">▪ Host interface unit (HIU) for bridging to the AHB for bulk data accesses and APB for register accesses▪ Ten queue control units (QCU) for transferring TX data▪ Ten DCF control units (DCU) for managing channel access▪ Protocol control unit (PCU) for interfacing to baseband▪ DMA receive unit (DRU) for transferring RX data
Baseband Block	<p>The MSD50NBT baseband module (BB) is the physical layer controller for the 802.11b/g/n air interface. It is responsible for modulating data packets in the transmit direction and detecting and demodulating data packets in the receive direction. It has a direct control interface to the radio to enable hardware to adjust analog gains and modes dynamically.</p>
Clock Sharing	<p>Clock sharing is implemented on the MSD50NBT. The Bluetooth chip (CSR8811) receives a reference clock from Wi-Fi chip (QCA6004). When Wi-Fi is in power off/reset state, no 26MHz reference clock is available; therefore, bluetooth is also off.</p>

BLUETOOTH FUNCTIONAL DESCRIPTION

The MSD50NBT Bluetooth (BT) block is based on CSR8811A08 and described in the table below:

Table 3: Bluetooth functions

Feature	Description
HCI-UART Interface	The UART Interface is a standard high-speed UART interface. It operates up to 4 Mbps, supporting Bluetooth HCI UART interface.
PCM or I2S Interface	<ul style="list-style-type: none"> ▪ Continuous PCM encoded audio data transmission and reception over Bluetooth. ▪ Processor overhead reduction through hardware support for continual transmission and reception of PCM data. ▪ A bidirectional digital audio interface that routes directly into the baseband layer of the firmware. It does not pass through the HCI protocol layer. ▪ Hardware on CSR8811 for sending data to and from a SCO connection. ▪ Up to three SCO connections on the PCM interface at any one time. ▪ PCM interface master, generating PCM_SYNC and PCM_CLK. ▪ PCM interface slave, accepting externally generated PCM_SYNC and PCM_CLK. ▪ Various clock formats including: <ul style="list-style-type: none"> *Long Frame Sync *Short Frame Sync ▪ GCI timing environments ▪ 13-bit or 16-bit linear, 8-bit μ-law or A-law companded sample formats. ▪ Receives and transmits on any selection of three of the first four slots following PCM_SYNC. ▪ The PCM configuration options are enabled by setting SKEY_PCM_CONFIG32.
CPU and Memory	<p>The CSR8811 uses a 16-bit RISC MCU for low power consumption and efficient use of memory. The MCU, interrupt controller, and event timer run the Bluetooth software stack and control the Bluetooth radio and host interfaces.</p> <p>56 KB of on-chip RAM is provided to support the RISC MCU and is shared between the ring buffers used to hold voice/data for each active connection and the general-purpose memory required by the Bluetooth stack.</p> <p>5 Mb of Internal ROM memory is available on the CSR8811. This memory is provided for system firmware, storing CSR8811 settings and program code.</p>
Build-in Standard WLAN Coexistence	The MSD50NBT supports internally the standard WLAN coexistence interface through the WLAN_ACTIVE, BT_PRIORITY, and BT_ACTIVE pins.
Reference Clock	<p>The BT block is configured for 26 MHz reference clock frequency. The clock source is provided to BT internally from the WLAN block on demand from BT_CLK_REQ.</p> <p>Note: <i>The WLAN block must be initialized prior before BT clock sharing is enabled.</i></p>
BT Low Energy	The MSD50NBT supports Low Energy specification which allows for connection to devices with single mode LE function (such as a watch, sensor, and HID). The implementation is optimized for coexistence with WLAN.
Reset	<p>The pin BT_RST_L resets and powers down the BT block.</p> <p>Holding the BT_RST_L pin at GND turns off the entire BT block; all state information is lost. To ensure a full reset, the reset signal should be asserted for a period greater than 5 ms.</p>

Feature	Description
Radio	The BT radio shares the single antenna port with the WLAN through an internal 3-way RF switch. The MSD50NBT implements WLAN/BT coexistence internally. VDDIO is to set the I/O voltage internally with either 1.8 V or 3.3 V to ensure same voltage level for the internal Wi-Fi and BT coexistence signal. Refer to the reference design specifications for details.
BT_WAKEUP_HOST	Pin-12 on MSD50NBT is reserved for BT to wake host from deep sleep mode. Current s/w may not support it. Contact Laird for more information.
VDDIO	Pin-21 on MSD50NBT is WLAN Host IO (SDIO) power supply input. Can be either 1.8V or 3.3V.

ELECTRICAL CHARACTERISTICS

Absolute Maximum Ratings

Table 4 summarizes the absolute maximum ratings and Table 5 lists the recommended operating conditions for the MSD50NBT. Absolute maximum ratings are those values beyond which damage to the device can occur. Functional operation under these conditions, or at any other condition beyond those indicated in the operational sections of this document, is not recommended.

Note: Maximum rating for signals follows the supply domain of the signals.

Table 4: Absolute Maximum Ratings

Symbol (Domain)	Parameter	Max Rating	Unit
VDDIO	WLAN host SDIO interface and BT I/O supply	-0.3 to 4.0	V
VCC3_3	External 3.3V power supply	-0.3 to 3.6	V
Storage	Storage Temperature	-40 to +85	°C
ANT1; ANT2	Maximum RF input (reference to 50-Ω input)	+10	dBm
ESD	Electrostatic discharge tolerance	2000	V

Recommended Operating Conditions

Table 5: Recommended Operating Conditions

Symbol (Domain)	Parameter	Min	Typ	Max	Unit
VDDIO	WLAN host interface and BT I/O supply	1.71/3.2	1.8/3.3	1.89/3.46	V
VCC3_3	External 3.3V power supply	3.2	3.30	3.46	V
T-ambient	Ambient temperature	-30	25	85	°C

DC Electrical Characteristics

Table 6 and Table 7 list the general DC electrical characteristics over recommended operating conditions (unless otherwise specified).

Table 6: General DC Electrical Characteristics (For 3.3V I/O Operation)

Symbol	Parameter	Conditions	Min	Typ	Max	Unit
VIH	High Level Input Voltage		0.7 x VDD			V
VIL	Low Level Input Voltage				0.3 x VDD	V
IIL	Input Leakage Current	Without Pull-up or Pull-down	0V < VIN < VDD 0V < VOUT < VDD	0	-3	nA
		With Pull-up	0V < VIN < VDD 0V < VOUT < VDD	16	48	μA
		With Pull-down	0V < VIN < VDD 0V < VOUT < VDD	-14	-47	μA
VOH	High Level Output Voltage	IOH = -4mA	0.9 x VDD			V
		IOH = -12mA	0.9 x VDD			V
VOL	Low Level Output Voltage	IOH = 4mA			0.1 x VDD	V
		IOH = 12mA			0.1 x VDD	V

Table 7: General DC Electrical Characteristics (For 1.8V I/O Operation)

Symbol	Parameter	Conditions	Min	Typ	Max	Unit
VIH	High Level Input Voltage		0.7 x VDD			V
VIL	Low Level Input Voltage				0.3 x VDD	V
IIL	Input Leakage Current	Without Pull-up or Pull-down	0V < VIN < VDD 0V < VOUT < VDD	0	-3	nA
		With Pull-up	0V < VIN < VDD 0V < VOUT < VDD	3.5	13	μA
		With Pull-down	0V < VIN < VDD 0V < VOUT < VDD	-6.2	-23	μA
VOH	High Level Output Voltage	IOH = -4mA	0.9 x VDD			V
		IOH = -12mA	0.9 x VDD			V
VOL	Low Level Output Voltage	IOH = 4mA			0.1 x VDD	V
		IOH = 12mA			0.1 x VDD	V

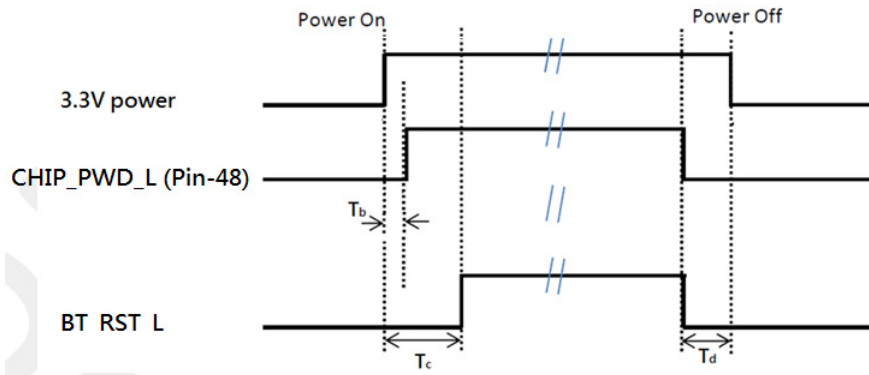

Figure 1: Power On/Off Timing

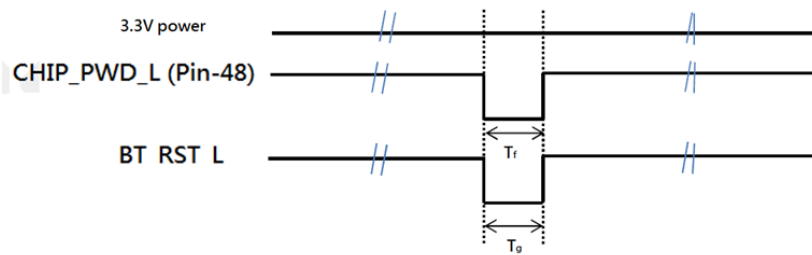

Figure 2: Power On/Off Timing

Table 8: Timing Diagram Definitions

Timing	Description	Min	Unit
Tb	Time between VDD33 (3.3V)supplies valid, to WiFi reset (pin-48;CHIP_PWD_L) negation.	5	µsec
Note: have suitable 10K ohm Pull-up on pin-48, already. No extra pull-up resistor is required.			
Tc	Time between VDD33 (3.3V) supplies valid and BT_RST_L (pin-32) negation	5	msec
Td	Time between WiFi reset (pin-48;CHIP_PWD_L) negation and VDD33 (3.3V) invalid, or time between BT_RST_L (pin-32) negation and VDD33(3.3V) invalid.	0	µsec
Tf	Time of WiFi reset (pin-48; CHIP_PWD_L) assertion during reset or power down period. 3.3V should keep ON.	5	µsec
Tg	Time of BT_RST_L (pin-32) assertion during reset or power down period. 3.3V should keep ON.	5	

We suggest that Tb and Tf timing is greater than 5µsec but no longer than 100 msec.

WLAN Radio Receiver Characteristics

Table 9 and Table 10 summarize the WLAN MSD50NBT receiver characteristics.

Table 9: WLAN Receiver Characteristics for 2.4 GHz Signal Chain Operation

Symbol	Parameter	Conditions	Min	Typ	Max	Unit
Fr _x	Receive input frequency range		2.412		2.484	GHz
S _r f	Sensitivity					
	CCK, 1 Mbps	See Note ³		-94		dBm
	CCK, 11 Mbps			-87		
	OFDM, 6 Mbps			-91		
	OFDM, 54 Mbps			-74		
	HT20, MCS0			-91		
HT20, MCS7			-71			
R _a dj	Adjacent channel rejection					
	OFDM, 6 Mbps	See Note ⁴		32		dB
	OFDM, 54 Mbps			16		
	HT20, MCS0			31		
	HT20, MCS7			14		

³Performance data are measured under signal chain operation.

⁴Performance data are measured under signal chain operation.

Table 10: WLAN Receiver Characteristics for 5 GHz Dual Chain Operation

Symbol	Parameter	Conditions	Min	Typ	Max	Unit
Fr _x	Receive input frequency range		5.15		5.825	GHz
S _r f	Sensitivity					
	OFDM, 6 Mbps	See Note ⁵		-92		dBm
	OFDM, 54 Mbps			-74		
	HT20, MCS0			-92		
	HT20, MCS7			-71		
	HT40, MCS0			-86		
	HT40, MCS7			-66		
R _a dj	Adjacent channel rejection					
	OFDM, 6 Mbps	See Note ⁶		22		dB
	OFDM, 54 Mbps			9		
	HT20, MCS0			20		
	HT20, MCS7			19		

⁵Performance data are measured under signal chain operation.

⁶Performance data are measured under signal chain operation.

WLAN Transmitter Characteristics

Table 11: WLAN Transmitter Characteristics for 2.4 GHz Per Chain Operation

Symbol	Parameter	Conditions	Min	Typ	Max	Unit
Ftx	Transmit output frequency range		2.412		2.484	GHz
Pout	Output power	See Note ⁷				dBm
	11b mask compliant	1Mbps		17		
	11g mask compliant	6Mbps		17		
	11g EVM compliant	54Mbps		14		
	11n HT20 mask compliant	MCS0		17		
	11n HT20 EVM compliant	MCS7		13		
	11n HT20 EVM compliant	MCS15		13		
ATx	Transmit power accuracy at 17 dBm	-	-	+ 2.0		dB

Freq.	Mode/Rate (Mbps)	Output Power Per Chain (dBm)	Typical Current Consumption Single Chain (mA) ⁸	Max. Current Consumption Single Chain (mA) ⁸
2412MHz	1 Mbps	18dBm	420	560
	54 Mbps	15dBm	350	450
	HT20 MCS7	14dBm	340	420
2442MHz	1 Mbps	18dBm	420	560
	54 Mbps	15dBm	350	450
	HT20 MCS7	14dBm	340	420
2472MHz	1 Mbps	18dBm	420	560
	54 Mbps	15dBm	350	450
	HT20 MCS7	14dBm	340	420

Table 12: WLAN Transmitter Characteristics for 5 GHz Per Chain Operation

Symbol	Parameter	Conditions	Min	Typ	Max	Unit
Ftx	Transmit output frequency range		5.15		5.925	GHz
Pout	Output power	See Note ³				dBm
	11a mask compliant	6Mbps		17		
	11a EVM compliant	54Mbps		14		
	11n HT20 mask compliant	MCS0		17		
	11n HT20 EVM compliant	MCS7		13		
	11n HT20 EVM compliant	MCS15		13		
	11n HT40 mask compliant	MCS0		14		
	11n HT40 EVM compliant	MCS7		11		
	11n HT40 EVM compliant	MCS15		11		
ATx	Transmit power accuracy at 17dBm	-	-	+ 2.0		dB

Freq.	Mode/Rate [Mbps]	Output Power Per Chain [dBm]	Typical Current Consumption Single Chain (mA) ⁸	Max. Current Consumption Single Chain (mA) ⁸
5180MHz	54 Mbps	15dBm	490	590
	HT20 MCS7	14dBm	450	560
	HT40 MCS7	12dBm	470	540
5500MHz	54 Mbps	15dBm	490	590
	HT20 MCS7	14dBm	450	560
	HT40 MCS7	12dBm	470	540
5825MHz	54 Mbps	15dBm	490	590
	HT20 MCS7	14dBm	450	560
	HT40 MCS7	12dBm	470	540

⁷Performance data are measured under single chain operation.

Note: Final TX power values on each channels are limited by the regulatory certification test limit.

Note: 2.4GHz does not support HT40 operation, only 5GHz support HT40 operation.

BLUETOOTH RADIO CHARACTERISTICS

Table 13 through Table 14 describe the basic rate transmitter performance, enhanced data transmitter performance, basic rate receiver performance, enhanced rate receiver performance, and current consumption conditions at 25°C.

Table 13: Basic Rate Transmitter Performance Temperature at 25°C (3.3V)

Test Parameter	Min	Typ	Max	BT Spec.	Unit
Maximum RF Output Power	2	6	—	-6 to +10	dBm
Frequency Range	2.4	—	2.4835	$2.4 \leq f \leq 2.4835$	GHz
20 dB Bandwidth	—	925	—	≤ 1000	KHz
Adjacent Channel TX Power F = F0 + 2 MHz	—	-36	—	≤ -20	dBm
Adjacent Channel TX Power F = F0 +3 MHz	—	-42	—	≤ -40	dBm
Δf_{1avg} Maximum Modulation	140	165	175	$140 < \Delta f_{1avg} < 175$	KHz
Δf_{2max} Minimum Modulation	—	135	—	≥ 115	KHz
$\Delta f_{2avg}/\Delta f_{1avg}$	—	0.9	—	≥ 0.80	—
Initial Carrier Frequency	—	5	—	$\leq \pm 75$	KHz
Drift Rate	—	5	—	≤ 20	KHz/50 μ s
Drift (DH1 packet)	—	6	—	≤ 25	KHz
Drift (DH5 packet)	—	7	—	≤ 40	KHz

Table 14: Enhanced Data Rate Transmitter Performance 25°C (3.3V)

Test Parameter		Min	Typ	Max	BT Spec.	Unit
Relative Transmit Power		-1	3	6	-4 to +1	dBm
Max Carrier Frequency Stability w ₀	π/4 DQPSK	—	1	—	≤ ±10	KHz
	8 DPSK	—	1	—		
Max Carrier Frequency Stability w _i	π/4 DQPSK	—	1	—	≤ ±75	KHz
	8 DPSK	—	1	—		
Max Carrier Frequency Stability w ₀ +w _i	π/4 DQPSK	—	2	—	≤ ±75	KHz
	8 DPSK	—	1.5	—		
RMS DEVM	π/4 DQPSK	—	6	—	≤ 20	%
	8 DPSK	—	6	—	≤ 13	%
Peak DEVM	π/4 DQPSK	—	16	—	≤ 35	%
	8 DPSK	—	15	—	≤ 25	%
99% DEVM	π/4 DQPSK	—	12	—	≤ 30	%
	8 DPSK	—	12	—	≤ 20	%
EDR Differential Phase Encoding		—	99	—	≥ 99	%
Adjacent Channel Power	F ≥ ± 3MHz	—	-60	—	< -40	dBm
	F = ± 2MHz	—	-28	—	≤ -20	dBm
	F = ±1MHz	—	-32	—	≤ -26	dB

Table 15: Basic Rate Receiver Performance at 3.3V

Test Parameter		Min	Typ	Max	BT Spec.	Unit
Sensitivity	BER ≤ 0.1%	—	-84	-78	≤ -70	dBm
Maximum Input	BER ≤ 0.1%	-20	-10	—	≥ -20	dBm
Carrier-to-Interferer Ratio (C/I)	Co-Channel	—	—	11	11	
	Adjacent Channel (± 1 MHz)	—	-4/-2	0	0	dB
	Second Adjacent Channel (± 2 MHz)	—	-35/-28	-30	-30	dB
	Third Adjacent Channel (± 3 MHz)	—	-42	-40	-40	dB
Maximum Level of Intermodulation Interferers		-39	-30	-	≥ -39	dBm

Table 16: Enhanced Data Rate Receiver Performance 3.3V

Test Parameter		Min	Typ	Max	Bluetooth Specification	Unit
Sensitivity (BER ≤0.01%)	8 DPSK	—	-76	-71	≤ -70	dBm
Maximum Input (BER ≤0.1%)	π/4 DQPSK	-20	—	—	≥ -20	dBm
	8 DPSK	-20	—	—	≥ -20	dBm
Co-Channel C/I (BER ≤0.1%)	π/4 DQPSK	—	10	13	≤ ±13	dB
	8 DPSK	—	18	20	≤ ±20	dB
Adjacent Channel C/I (BER ≤ 0.1%)	π/4 DQPSK	—	-9/-6	0	≤ 0	dB
	8 DPSK	—	-3/0	5	≤ 5	dB
Second Adjacent Channel C/I (BER ≤ 0.1%)	π/4 DQPSK	—	-42/-28	-30	≤ -30	dB
	8 DPSK	—	-28/-22	-25	≤ -25	dB
Third Adjacent Channel C/I (BER ≤ 0.1%)	π/4 DQPSK	—	-45	-40	≤ -40	dB
	8 DPSK	—	-39	-33	≤ -33	dB

SDIO TIMING REQUIREMENTS

The following figure (Figure 3) and table display SDIO default mode timing.

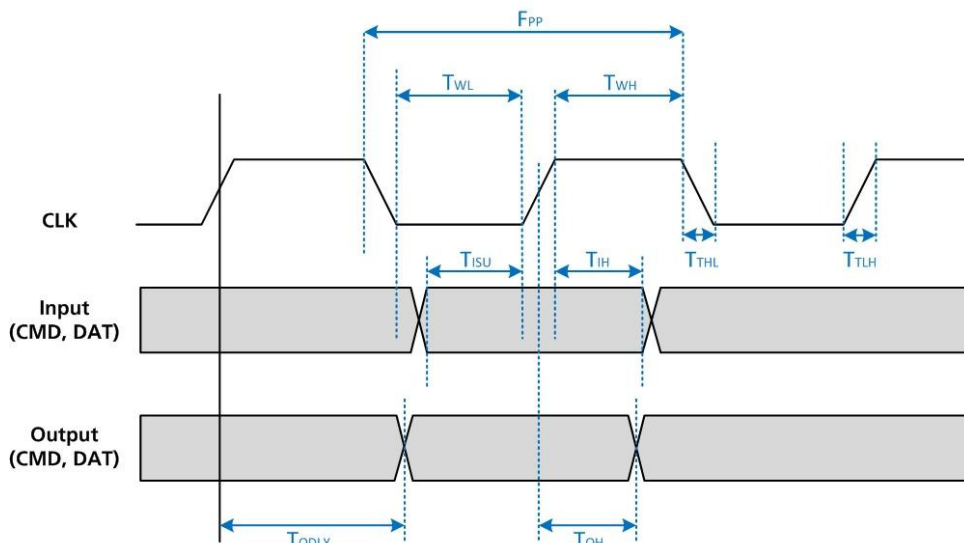

Figure 3: SDIO Default Mode Timing

Note: Timing is based on CL ≤ 40 pF load on CMD and Data.

Table 17: SDIO Timing Requirements

Symbol	Parameter	Min.	Typ.	Max.	Unit
f _{PP}	Frequency – Data Transfer mode	0	-	50	MHz
t _{WL}	Clock low time	7	-	-	ns
t _{WH}	Clock high time	7	-	-	ns

Symbol	Parameter	Min.	Typ.	Max.	Unit
tTLH	Clock rise time	-	-	10	ns
tTHL	Clock low time	-	-	10	ns
Inputs: CMD, DAT (referenced to CLK)					
tISU	Input setup time	6	-	-	ns
tIH	Input hold time	2	-	-	ns
Outputs: CMD, DAT (referenced to CLK)					
tODLY	Output delay time – Data Transfer mode	0	-	14	ns

PIN DEFINITIONS

Pin #	Name	Type	Voltage Reference	Description	If Not Used
1	GND	-	-	Ground	GND
2	BT_UART_TXD	O	VDD_IO	Bluetooth UART Serial output	N/C
3	No Connect	-	-	No Connect	N/C
4	No Connect	-	-	No Connect	N/C
5	BT_UART_RTS_N	O	VDD_IO	"Request-to-send signal for the Bluetooth UART interface, active low"	N/C
6	BT_UART_RXD	I	VDD_IO	Bluetooth UART Serial input	N/C
7	No Connect	-	-	No Connect	N/C
8	Wake On Wireless	O	VDD_IO	Reserved as Wake-ON-Wireless (WOW) LAN, WLAN output signal to wake up host, active Low and need external 10K pull up. Note: The current software does not support it.	N/C
9	No Connect	-	-	No Connect	N/C
10	BT_PCM_OUT	O	VDD_IO	BT PCM synchronous data output	N/C
11	BT_UART_CTS_N	I	VDD_IO	"Clear-to-send signal for the Bluetooth UART interface, active low"	N/C
12	BT_WAKEUP_HOST	O	VDD_IO	When BT wakes up from its deep sleep state, it sends an H pulse signal out to Host. Normally, it is Low state. Note: The current software does not support it.	N/C
13	VCC3_3	-	-	3.3V Power Supply for the Module. (3.2V Min; 3.46V Max)	3.3V
14	No Connect	-	-	No Connect	N/C
15	No Connect	-	-	No Connect	N/C
16	No Connect	-	-	No Connect	N/C
17	No Connect	-	-	No Connect	N/C

Pin #	Name	Type	Voltage Reference	Description	If Not Used
18	No Connect	-	-	No Connect	N/C
19	No Connect	-	-	No Connect	N/C
20	BT_PCM_SYNC	I/O	VDD_IO	BT PCM Synchronous data	N/C
21	VDD_IO	-	-	Bus and IO voltage level configuration. Either 3.3V or 1.8V	1.8V or 3.3V
22	BT_PCM_IN	I	VDD_IO	BT PCM synchronous data input	N/C
23	No Connect	-	-	No Connect	N/C
24	BT_PCM_CLK	I/O	VDD_IO	BT PCM clock	N/C
25	No Connect	-	-	No Connect	N/C
26	No Connect	-	-	No Connect	N/C
27	SDIO_DATA_2	I/O	VDD_IO	SDIO Data 2 – Internal pull-up. No external pull-up required	N/C
28	No Connect	-	-	No Connect	N/C
29	VCC3_3	-	-	3.3V Power Supply for the Module. (3.2V Min; 3.46V Max)	3.3V
30	GND	-	-	Ground	GND
31	GND	-	-	Ground	GND
32	BT_RST_L	I	VDD_IO	BT chip power-down control. Driving this pin active low powers down or resets the BT signal. Has internal weak pull-up. Should be active low for at least 5ms to reset the BT. Note:10K ohm internal pull-up.	N/C
33	No Connect	-	-	No Connect	N/C
34	No Connect	-	-	No Connect	N/C
35	No Connect	-	-	No Connect	N/C
36	No Connect	-	-	No Connect	N/C
37	No Connect	-	-	No Connect	N/C
38	No Connect	-	-	No Connect	N/C
39	No Connect	-	-	No Connect	N/C
40	No Connect	-	-	No Connect	N/C
41	No Connect	-	-	No Connect	N/C
42	No Connect	-	-	No Connect	N/C
43	No Connect	-	-	No Connect	N/C
44	No Connect	-	-	No Connect	N/C
45	No Connect	-	-	No Connect	N/C
46	No Connect	-	-	No Connect	N/C
47	No Connect	-	-	No Connect	N/C

Pin #	Name	Type	Voltage Reference	Description	If Not Used
48	CHIP_PWD_L	I	VDD_IO	"WLAN Power Down (0=power down, 1= WLAN awake) Note:10K ohm internal pull-up.	N/C
49	No Connect	-	-	No Connect	N/C
50	No Connect	-	-	No Connect	N/C
51	No Connect	-	-	No Connect	N/C
52	No Connect	-	-	No Connect	N/C
53	No Connect	-	-	No Connect	N/C
54	No Connect	-	-	No Connect	N/C
55	SDIO_CMD	I/O	VDD_IO	SDIO Command – Internal pull-up.	N/C
56	SDIO_CLK	I	VDD_IO	SDIO Clock (25MHz max)	N/C
57	SDIO_DATA_0	I/O	VDD_IO	SDIO Data 0 – Internal pull-up. No external pull-up required	N/C
58	SDIO_DATA_3	I/O	VDD_IO	SDIO Data 3 – Internal pull-up. No external pull-up required	N/C
59	SDIO_DATA_1	I/O	VDD_IO	SDIO Data 1 – Internal pull-up. No external pull-up required	N/C
60	GND	-	-	Ground	GND

MSD40NBT, MSD45N, and MSD50NBT Pin Comparison Table

Pin #	Pin Name – MSD40NBT	Pin Name – MSD45N	Pin Name – MSD50NBT
1	GND	GND	GND
2	BT_UART_TXD	No Connect	BT_UART_TXD
3	BT_PRIORITY	BT_PRIORITY	No Connect
4	BT_GPIO_6	No Connect	No Connect
5	BT_UART_RTS_N	No Connect	BT_UART_RTS_N
6	BT_UART_RXD	No Connect	BT_UART_RXD
7	BT_HOST_WAKE_B	No Connect	No Connect
8	RSVD	No Connect	Wake On Wireless
9	RSVD	No Connect	No Connect
10	BT_PCM_OUT	No Connect	BT_PCM_OUT
11	BT_UART_CTS_N	No Connect	BT_UART_CTS_N
12	BT_WAKE_B	No Connect	BT_WAKEUP_HOST
13	VCC3_3	VCC3_3	VCC3_3
14	No Connect	No Connect	No Connect
15	No Connect	No Connect	No Connect

Pin #	Pin Name – MSD40NB	Pin Name – MSD45N	Pin Name – MSD50NB
16	No Connect	No Connect	No Connect
17	No Connect	No Connect	No Connect
18	No Connect	No Connect	No Connect
19	No Connect	No Connect	No Connect
20	BT_PCM_SYNC	No Connect	BT_PCM_SYNC
21	No Connect	VDD_IO	VDD_IO
22	BT_PCM_IN	No Connect	BT_PCM_IN
23	No Connect	No Connect	No Connect
24	BT_PCM_CLK	No Connect	BT_PCM_CLK
25	No Connect	No Connect	No Connect
26	SYS_RST_L	No Connect	No Connect
27	SDIO_DATA_2	SDIO_D2	SDIO_DATA_2
28	RSVD	WL_ACTIVE	RSVD
29	VCC3_3	VCC3_3	VCC3_3
30	GND	GND	GND
31	GND	GND	GND
32	BT_RST_L	No Connect	BT_RST_L
33	No Connect	No Connect	No Connect
34	No Connect	No Connect	No Connect
35	No Connect	No Connect	No Connect
36	RSVD	BT_ACTIVE	No Connect
37	No Connect	No Connect	No Connect
38	No Connect	No Connect	No Connect
39	No Connect	No Connect	No Connect
40	No Connect	No Connect	No Connect
41	No Connect	No Connect	No Connect
42	RSVD	WL_LED_ACT/ANTE	No Connect
43	No Connect	No Connect	No Connect
44	No Connect	No Connect	No Connect
45	No Connect	No Connect	No Connect
46	No Connect	No Connect	No Connect
47	No Connect	No Connect	No Connect
48	CHIP_PWD_L	CHIP_PWD_L	CHIP_PWD_L
49	No Connect	No Connect	No Connect
50	RSVD	No Connect	No Connect
51	No Connect	No Connect	No Connect

Pin #	Pin Name – MSD40NBT	Pin Name – MSD45N	Pin Name – MSD50NBT
52	RSVD	No Connect	No Connect
53	RSVD	No Connect	No Connect
54	RSVD	No Connect	No Connect
55	SDIO_CMD	SDIO_CMD	SDIO_CMD
56	SDIO_CLK	SDIO_CLK	SDIO_CLK
57	SDIO_DATA_0	SDIO_D0	SDIO_DATA_0
58	SDIO_DATA_3	SDIO_D3	SDIO_DATA_3
59	SDIO_DATA_1	SDIO_D1	SDIO_DATA_1
60	GND	GND	GND

MECHANICAL SPECIFICATIONS

Module dimensions of MSD50NBT are 16x16x2.5mm. Detail drawings are shown in [Figure 4](#).

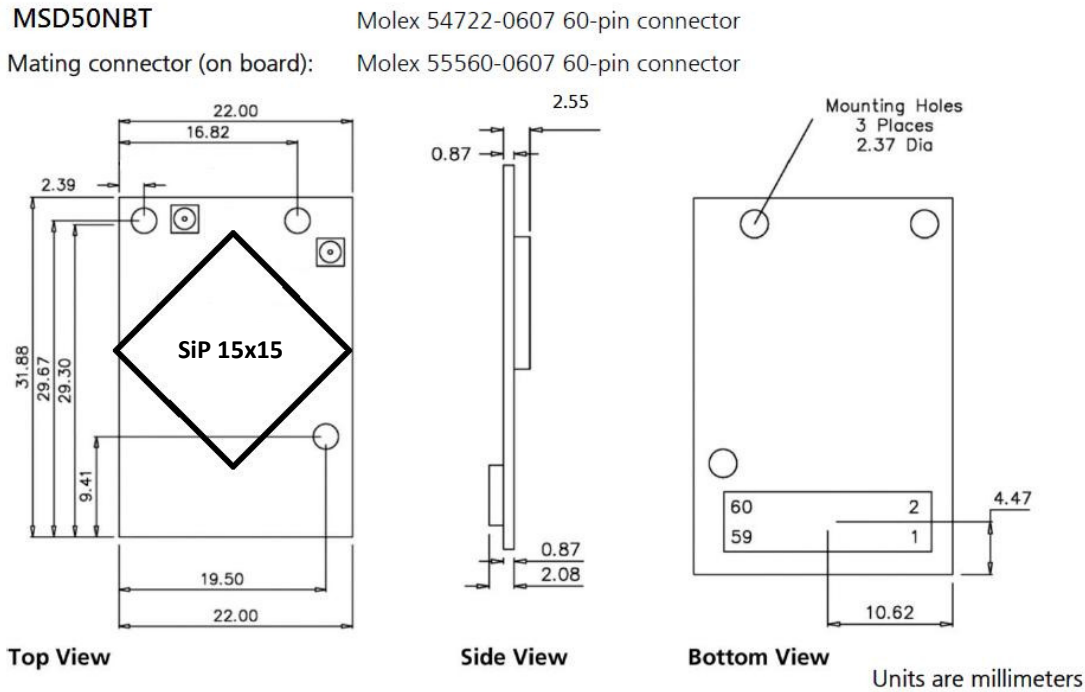

Figure 4: Module dimension of SSD50NBT

Note: The Wi-Fi MAC address is located on the product label. The BT MAC address is always be numerically subsequent to the Wi-Fi MAC address. Therefore, the BT MAC address is Wi-Fi MAC address plus one.

MOUNTING

The MSD50NBT connects to the host via a 60-pin connector. In addition, there are three mounting holes used to secure the device to the host using 2 mm mounting screws.

Laird recommends a 1.5 mm metal spacer (bushing) with a conductive mounting screw to connect the exposed ground pads of the radio circuit board to the host ground plane. A 1.5 mm conductive metal spacer with a maximum OD of 4 mm maximizes grounding of the radio and helps to reduce emissions from the radio circuit board. The spacer may also prevent the MSD board from slanting and breaking the connection to the host device when the board is attached to the host.

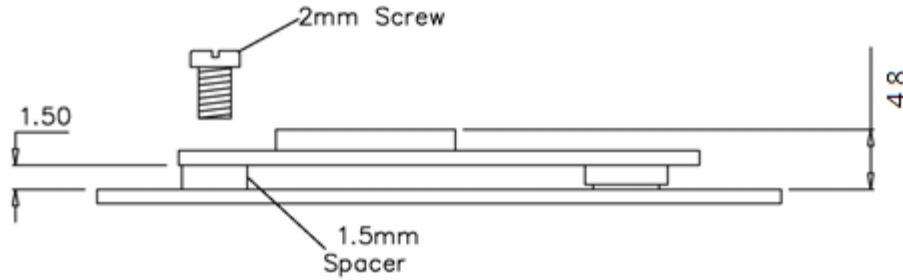
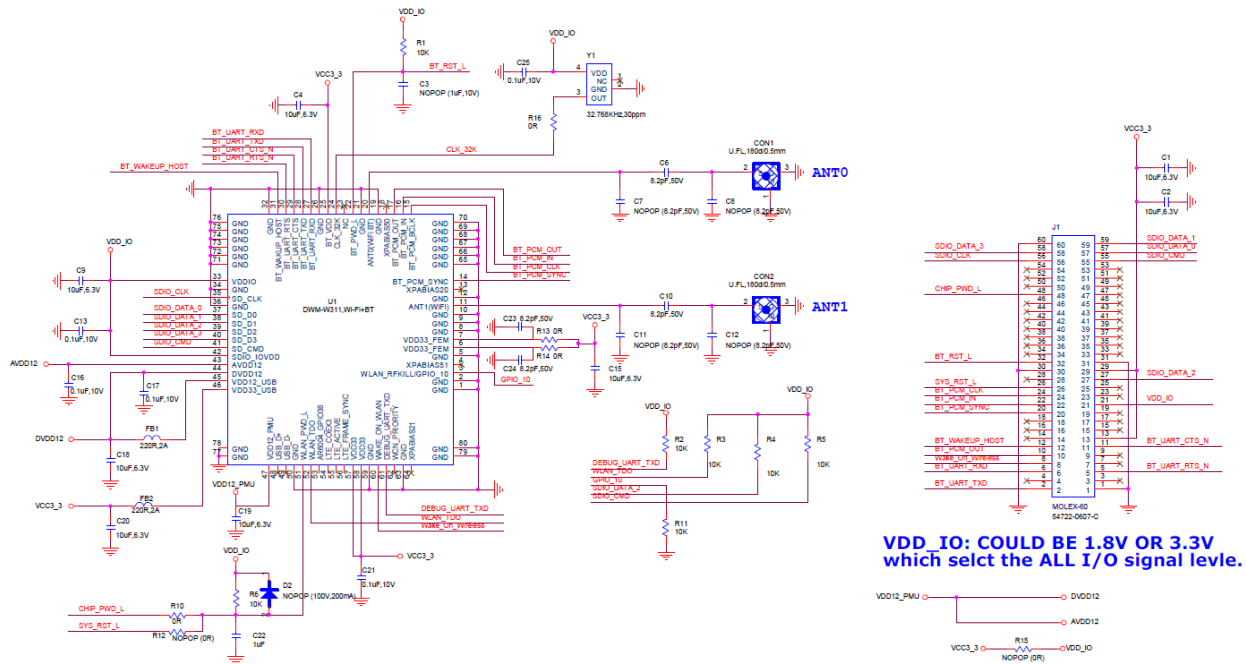

Figure 7: Mounting information for MSD50NB

REFERENCE SCHEMATIC OF MSD50NB



RF LAYOUT DESIGN GUIDELINES/PRECAUTIONS

The following is a list of RF layout design guidelines and recommendation when installing a Laird radio into your device.

- Do not run antenna cables directly above or directly below the radio.
- Do not place any parts or run any high speed digital lines below the radio.
- If there are other radios or transmitters located on the device (such as a Bluetooth radio), place the devices as far apart from each other as possible. Also, make sure there are at least 25dB isolation between Bluetooth antenna and Wi-Fi antenna.
- Laird recommends the use of a double shielded cable for the connection between the radio and the antenna elements.
- Be sure to put the capacitor on the power pin as close as possible to reduce the radiation issue.
- Use proper electro-static-discharge (ESD) procedures when installing the Laird radio module.

- In order to get maximum throughput when operate at MIMO 2x2, two antennas with at least 25dB isolation is recommended.
- To avoid negatively impacting TX power and receiver sensitivity, do not cover the antennas with metallic objects or components.
- Opening/handling/removing must be done on an anti-ESD treated workbench. All workers must also have undergone anti-ESD treatment.
- The devices should be mounted within one year of the date of delivery.

REGULATORY

Certified Antennas

Model	Type	Connector	2400~2483.5MHz		5150~5250MHz		5250~5350MHz		5470~5725MHz		5725~5850MHz	
Laird MAF94051	Dipole	RP-SMA	2.1 dBi (2.4-2.5 GHz),	2.4 dBi (4.9 GHz)	2.6 dBi (5.25 GHz),	3.4 dBi (5.875 GHz)						
Laird/NanoBlade-IP04	PCB Dipole	IPEX MHF	2 dBi (2.4-2.5 GHz),	3.9 dBi (5.15-5.35 GHz),	4 dBi (5.6 GHz)							
Laird/MAF95310 Mini Nano Blade Flex	PCB Dipole	IPEX MHF	2.79 dBi (2.4 GHz),	3.38 dBi (5 GHz)								
Laird/NanoBlue-IP04	PCB Dipole	IPEX MHF	2 dBi (2.4 GHz only)									
Ethertronics/WLAN_1000146	Isolated Magnetic Dipole	IPEX MHF	2.5 dBi (2.390-2.490 GHz),	3.5 dBi (4.900-5.100, 5.150-5.350, 5.70-5.900 GHz)								

FCC AND INDUSTRY CANADA REGULATORY

Model	US/FCC	CANADA/IC
MSD50NBT	SQG-MSD50NBT	3147A-MSD50NBT

The MSD50NBT has been designed to pass certification with the antenna listed below. The required antenna impedance is 50 ohms.

Model	Type	Connector	Peak gain (dBi)				
			2400~2483.5 MHz	5150~5250 MHz	5250~5350 MHz	5470~5725 MHz	5725~5850 MHz
Laird MAF94051	Dipole	RP-SMA	2.1 dBi	2.4 dBi	2.6 dBi	3.4 dBi	
Laird NanoBlade-IP04	PCB Dipole	IPEX MHF	2 dBi	3.9 dBi		4 dBi	
Laird MAF95310 Mini NanoBlade Flex	PCB Dipole	IPEX MHF	2.79 dBi	3.38 dBi			

Model	Type	Connector	Peak gain (dBi)				
			2400~2483.5 MHz	5150~5250 MHz	5250~5350 MHz	5470~5725 MHz	5725~5850 MHz
Laird NanoBlue-IP04	PCB Dipole	IPEX MHF	2dBi				–
Ethertronics WLAN_1000146	Isolated Magnetic Dipole	IPEX MHF	2.5dBi				3.5 dBi

FCC

Federal Communication Commission Interference Statement

This equipment has been tested and found to comply with the limits for a Class B digital device, pursuant to Part 15 of the FCC Rules. These limits are designed to provide reasonable protection against harmful interference in a residential installation. This equipment generates, uses and can radiate radio frequency energy and, if not installed and used in accordance with the instructions, may cause harmful interference to radio communications. However, there is no guarantee that interference will not occur in a particular installation. If this equipment does cause harmful interference to radio or television reception, which can be determined by turning the equipment off and on, the user is encouraged to try to correct the interference by one of the following measures:

- Reorient or relocate the receiving antenna.
- Increase the separation between the equipment and receiver.
- Connect the equipment into an outlet on a circuit different from that to which the receiver is connected.
- Consult the dealer or an experienced radio/TV technician for help.

FCC Caution:

Any changes or modifications not expressly approved by the party responsible for compliance could void the user's authority to operate this equipment.

This device complies with Part 15 of the FCC Rules. Operation is subject to the following two conditions: (1) This device may not cause harmful interference, and (2) this device must accept any interference received, including interference that may cause undesired operation.

Important Note:

Radiation Exposure Statement

This equipment complies with FCC radiation exposure limits set forth for an uncontrolled environment. This equipment should be installed and operated with minimum distance 20cm between the radiator and your body.

This transmitter must not be co-located or operating in conjunction with any other antenna or transmitter.

Country Code selection feature to be disabled for products marketed to the US/Canada.

This device is intended only for OEM integrators under the following conditions:

1. The antenna must be installed such that 20 cm is maintained between the antenna and users, and
2. The transmitter module may not be co-located with any other transmitter or antenna,

3. For all products market in US, OEM has to limit the operation channels in CH1 to CH11 for 2.4G band by supplied firmware programming tool. OEM shall not supply any tool or info to the end-user regarding to Regulatory Domain change.

As long as the three conditions above are met, further **transmitter** testing will not be required. However, the OEM integrator is still responsible for testing their end-product for any additional compliance requirements required with this module installed.

Important Note:

In the event that these conditions **cannot be met** (for example certain laptop configurations or co-location with another transmitter), then the FCC authorization is no longer considered valid and the FCC ID **cannot** be used on the final product. In these circumstances, the OEM integrator will be responsible for re-evaluating the end product (including the transmitter) and obtaining a separate FCC authorization.

End Product Labeling

This transmitter module is authorized only for use in device where the antenna may be installed such that 20 cm may be maintained between the antenna and users. The final end product must be labeled in a visible area with the following: Contains FCC ID: SQG-MSD50NBT.

Manual Information to the End User

The OEM integrator has to be aware not to provide information to the end user regarding how to install or remove this RF module in the user's manual of the end product which integrates this module.

The end user manual shall include all required regulatory information/warning as show in this manual.

Industry Canada

Industry Canada Statement

This device complies with Industry Canada's license-exempt RSSs. Operation is subject to the following two conditions:

- This device may not cause interference; and
- This device must accept any interference, including interference that may cause undesired operation of the device.

Le présent appareil est conforme aux CNR d'Industrie Canada applicables aux appareils radio exempts de licence. L'exploitation est autorisée aux deux conditions suivantes:

- l'appareil ne doit pas produire de brouillage;
- l'utilisateur de l'appareil doit accepter tout brouillage radioélectrique subi, même si le brouillage est susceptible d'en compromettre le fonctionnement.

This radio transmitter (*IC: 3147A-MSD50NBT*) has been approved by *Industry Canada* to operate with the antenna types listed below with the maximum permissible gain indicated. Antenna types not included in this list, having a gain greater than the maximum gain indicated for that type, are strictly prohibited for use with this device.

Le présent émetteur radio (*IC: 3147A-MSD50NBT*) a été approuvé par Industrie Canada pour fonctionner avec les types d'antenne énumérés ci-dessous et ayant un gain admissible maximal. Les types d'antenne non inclus

dans cette liste, et dont le gain est supérieur au gain maximal indiqué, sont strictement interdits pour l'exploitation de l'émetteur.

Antenna Information

Model	Type	Connector	Peak gain (dBi)				
			2400~2483.5 MHz	5150~5250 MHz	5250~5350 MHz	5470~5725 MHz	5725~5850 MHz
Laird MAF94051	Dipole	RP-SMA	2.1 dBi	2.4 dBi	2.6 dBi	3.4 dBi	
Laird NanoBlade-IP04	PCB Dipole	IPEX MHF	2 dBi	3.9 dBi		4 dBi	
Laird MAF95310 Mini NanoBlade Flex	PCB Dipole	IPEX MHF	2.79 dBi	3.38 dBi			
Laird NanoBlue-IP04	PCB Dipole	IPEX MHF	2dBi	-			
Ethertronics WLAN_1000146	Isolated Magnetic Dipole	IPEX MHF	2.5dBi	3.5 dBi			

Caution:

(i) The device for operation in the band 5150–5250 MHz is only for indoor use to reduce the potential for harmful interference to co-channel mobile satellite systems;

(ii) For devices with detachable antenna(s), the maximum antenna gain permitted for devices in the bands 5250-5350 MHz and 5470-5725 MHz shall be such that the equipment still complies with the EIRP limit;

(iii) For devices with detachable antenna(s), the maximum antenna gain permitted for devices in the band 5725-5850 MHz shall be such that the equipment still complies with the EIRP limits specified for point-to-point and non-point-to-point operation as appropriate; and

Operations in the 5.25-5.35GHz band are restricted to indoor usage only.

Avertissement:

(i) les dispositifs fonctionnant dans la bande de 5150 à 5250MHz sont réservés uniquement pour une utilisation à l'intérieur afin de réduire les risques de brouillage préjudiciable aux systèmes de satellites mobiles utilisant les mêmes canaux;

(ii) pour les dispositifs munis d'antennes amovibles, le gain maximal d'antenne permis pour les dispositifs utilisant les bandes de 5250 à 5350MHz et de 5470 à 5725 MHz doit être conforme à la limite de la p.i.r.e;

(iii) pour les dispositifs munis d'antennes amovibles, le gain maximal d'antenne permis (pour les dispositifs utilisant la bande de 5725 à 5850 MHz) doit être conforme à la limite de la p.i.r.e. spécifiée pour l'exploitation point à point et l'exploitation non point à point, selon le cas;

Les opérations dans la bande de 5.25-5.35GHz sont limités à un usage intérieur seulement.

Radiation Exposure Statement

This equipment complies with Canada radiation exposure limits set forth for an uncontrolled environment. This equipment should be installed and operated with minimum distance 20cm between the radiator & your body.

Déclaration d'exposition aux radiations

Cet équipement est conforme Canada limites d'exposition aux radiations dans un environnement non contrôlé. Cet équipement doit être installé et utilisé à distance minimum de 20cm entre le radiateur et votre corps.

This device is intended only for OEM integrators under the following condition:

- The transmitter module may not be co-located with any other transmitter or antenna.

As long as the condition above is met, further transmitter test will not be required. However, the OEM integrator is still responsible for testing their end-product for any additional compliance requirements required with this module installed.

Cet appareil est conçu uniquement pour les intégrateurs OEM dans les conditions suivantes:

- Le module émetteur peut ne pas être coïmplanté avec un autre émetteur ou antenne.

Tant que les 1 condition ci-dessus sont remplies, des essais supplémentaires sur l'émetteur ne seront pas nécessaires. Toutefois, l'intégrateur OEM est toujours responsable des essais sur son produit final pour toutes exigences de conformité supplémentaires requis pour ce module installé.

Important Note:

In the event that these conditions cannot be met (for example certain laptop configurations or co-location with another transmitter), then the Canada authorization is no longer considered valid and the IC ID cannot be used on the final product. In these circumstances, the OEM integrator will be responsible for re-evaluating the end product (including the transmitter) and obtaining a separate Canada authorization.

Note Importante:

Dans le cas où ces conditions ne peuvent être satisfaites (par exemple pour certaines configurations d'ordinateur portable ou de certaines co-localisation avec un autre émetteur), l'autorisation du Canada n'est plus considéré comme valide et l'ID IC ne peut pas être utilisé sur le produit final. Dans ces circonstances, l'intégrateur OEM sera chargé de réévaluer le produit final (y compris l'émetteur) et l'obtention d'une autorisation distincte au Canada.

End Product Labeling

The final end product must be labeled in a visible area with the following: **Contains IC: 3147A-MSD50NBT.**

Plaque signalétique du produit final

Le produit final doit être étiqueté dans un endroit visible avec l'inscription suivante: **Contient des IC: 3147A-MSD50NBT.**

Manual Information to the End User

The OEM integrator has to be aware not to provide information to the end user regarding how to install or remove this RF module in the user's manual of the end product which integrates this module.

The end user manual shall include all required regulatory information/warning as show in this manual.

Manuel d'information à l'utilisateur final

L'intégrateur OEM doit être conscient de ne pas fournir des informations à l'utilisateur final quant à la façon d'installer ou de supprimer ce module RF dans le manuel de l'utilisateur du produit final qui intègre ce module.

Le manuel de l'utilisateur final doit inclure toutes les informations réglementaires requises et avertissements comme indiqué dans ce manuel.

EUROPEAN UNION REGULATORY

The MSD50NBT has been tested for compliance with relevant standards for the EU market. MSD50NBT module was tested with antennas listed below.

Model	Type	Connector	2400~2483.5MHz
			5150~5250MHz 5250~5350MHz 5470~5725MHz 5725~5850MHz
Laird MAF94051	Dipole	RP-SMA	2.1 dBi (2.4-2.5 GHz), 2.4 dBi (4.9 GHz) 2.6 dBi (5.25 GHz), 3.4 dBi (5.875 GHz)
Laird/NanoBlade-IP04	PCB Dipole	IPEX MHF	2 dBi (2.4-2.5 GHz), 3.9 dBi (5.15-5.35 GHz), 4 dBi (5.6 GHz)
Laird/MAF95310 Mini Nano Blade Flex	PCB Dipole	IPEX MHF	2.79 dBi (2.4 GHz), 3.38 dBi (5 GHz)
Laird/NanoBlue-IP04	PCB Dipole	IPEX MHF	2 dBi (2.4 GHz only)
Ethertronics/WLAN_1000146	Isolated Magnetic Dipole	IPEX MHF	2.5 dBi (2.390-2.490 GHz), 3.5 dBi (4.900-5.100, 5.150-5.350, 5.70-5.900 GHz)

The OEM should consult with a qualified test house before entering their device into an EU member country to make sure all regulatory requirements have been met for their complete device.

Reference the Declaration of Conformities listed below for a full list of the standards that the modules were tested to. Test reports are available upon request.

EU DECLARATIONS OF CONFORMITY

MSD50NBT

Manufacturer:	Laird
Product:	MSD50NBT
EU Directive:	RTTE 1995/5/EC
Conformity Assessment:	Annex IV

Reference standards used for presumption of conformity:

Article No.	Requirement	Reference standard(s)
3.1a	Health and Safety	EN60950-1:2006+A11:2009+A1:2010+A12:2011+A2:2013











Article No.	Requirement	Reference standard(s)
3.1b	Protection requirements with respect to electromagnetic compatibility	EN 301 489-1 V1.9.2 (2011-09) EN 301 489-17 V2.2.1 (2012-09) Emissions: EN55022:2010/AC:2011 (Class B) Immunity: EN61000-4-2:2009 EN61000-4-3:2006/A1:2008/A2:2010
3.2	Means of the efficient use of the radio frequency spectrum	EN 300 328 V1.8.1 (2012-06) EN 301 893 v1.8.1

ORDERING INFORMATION

Part Number	Description
MSD50NBT	2X2 802.11 a/b/g/n with BT4.0 dual mode module.

General Comments

This is a preliminary datasheet. Please check with Laird for the latest information before commencing a design. If in doubt, ask.

 Česky [Czech]	<i>[Jméno výrobce]</i> tímto prohlašuje, že tento <i>[typ zařízení]</i> je ve shodě se základními požadavky a dalšími příslušnými ustanoveními směrnice 1999/5/ES.
 Dansk [Danish]	Undertegnede <i>[fabrikantens navn]</i> erklærer herved, at følgende udstyr <i>[udstyrets typebetegnelse]</i> overholder de væsentlige krav og øvrige relevante krav i direktiv 1999/5/EF.
 Deutsch [German]	Hiermit erkläre <i>[Name des Herstellers]</i> , dass sich das Gerät <i>[Gerätetyp]</i> in Übereinstimmung mit den grundlegenden Anforderungen und den übrigen einschlägigen Bestimmungen der Richtlinie 1999/5/EG befindet.
 Eesti [Estonian]	Käesolevaga kinnitab <i>[tootja nimi = name of manufacturer]</i> seadme <i>[seadme tüüp = type of equipment]</i> vastavust direktiivi 1999/5/EÜ põhinõuetele ja nimetatud direktiivist tulenevatele teistele asjakohastele sätetele.
 English	Hereby, <i>[name of manufacturer]</i> , declares that this <i>[type of equipment]</i> is in compliance with the essential requirements and other relevant provisions of Directive 1999/5/EC.
 Español [Spanish]	Por medio de la presente <i>[nombre del fabricante]</i> declara que el <i>[clase de equipo]</i> cumple con los requisitos esenciales y cualesquiera otras disposiciones aplicables o exigibles de la Directiva 1999/5/CE.
 Ελληνική [Greek]	ΜΕ ΤΗΝ ΠΑΡΟΥΣΑ <i>[name of manufacturer]</i> ΔΗΛΩΝΕΙ ΟΤΙ <i>[type of equipment]</i> ΣΥΜΜΟΡΦΩΝΕΤΑΙ ΠΡΟΣ ΤΙΣ ΟΥΣΙΩΔΕΙΣ ΑΠΑΙΤΗΣΕΙΣ ΚΑΙ ΤΙΣ ΛΟΙΠΕΣ ΣΧΕΤΙΚΕΣ ΔΙΑΤΑΞΕΙΣ ΤΗΣ ΟΔΗΓΙΑΣ 1999/5/EK.
 Français [French]	Par la présente <i>[nom du fabricant]</i> déclare que l'appareil <i>[type d'appareil]</i> est conforme aux exigences essentielles et aux autres dispositions pertinentes de la directive 1999/5/CE.
 Italiano [Italian]	Con la presente <i>[nome del costruttore]</i> dichiara che questo <i>[tipo di apparecchio]</i> è conforme ai requisiti essenziali ed alle altre disposizioni pertinenti stabilite dalla direttiva 1999/5/CE.
 Latviski [Latvian]	Aršo <i>[name of manufacturer / izgatavotājanosaukums]</i> deklarē, ka <i>[type of equipment / iekārtas tips]</i> atbilst Direktīvas 1999/5/EK būtiskajām prasībām un citiemar to saistītajiem noteikumiem.

Lietuvių [Lithuanian]	Šiuo [<i>manufacturer name</i>] deklaruoja, kad šis [<i>equipment type</i>] atitinka esminius reikalavimus ir kitas 1999/5/EB Direktyvos nuostatas.
Nederlands [Dutch]	Hierbij verklaart [<i>naam van de fabrikant</i>] dat het toestel [<i>type van toestel</i>] in overeenstemming is met de essentiële eisen en de andere relevante bepalingen van richtlijn 1999/5/EG.
Malti [Maltese]	Hawnhekk, [<i>isem tal-manifattur</i>], jiddikjara li dan [<i>il-mudel tal-prodott</i>] jikkonforma mal-htigijiet essenzjali u ma provvedimenti oħrajn relevanti li hemm fid-Dirrettiva 1999/5/EC.
Magyar [Hungarian]	Alulírott, [<i>gyártó neve</i>] nyilatkozom, hogy a [<i>... típus</i>]megfelel a vonatkozó alapvető követelményeknek és az 1999/5/EC irányelv egyéb előírásainak.
Polski [Polish]	Niniejszym [<i>nazwa producenta</i>] oświadczam, że [<i>nazwa wyrobu</i>] jest zgodny z zasadniczymi wymogami oraz pozostałymi stosownymi postanowieniami Dyrektywy 1999/5/EC.
Português [Portuguese]	[<i>Nome do fabricante</i>] declara que este [<i>tipo de equipamento</i>] está conforme com os requisitos essenciais e outras disposições da Directiva 1999/5/CE.
Slovensko [Slovenian]	[<i>Ime proizvajalca</i>] izjavlja, da je ta [<i>tip opreme</i>] v skladu z bistvenimi zahtevami in ostalimi relevantnimi določili direktive 1999/5/ES.
Slovensky [Slovak]	[<i>Menovýrobcu</i>]týmto vyhlasuje, že [<i>typ zariadenia</i>]spĺňa základné požiadavky a všetky príslušné ustanovenia Smernice 1999/5/ES.
Suomi [Finnish]	[<i>Valmistaja = manufacturer</i>] vakuuttaa täten että [<i>type of equipment = laitteen tyyppimerkintä</i>] tyyppinen laite on direktiivin 1999/5/EY oleellisten vaatimusten ja sitä koskevien direktiivin muiden ehtojen mukainen.
Svenska [Swedish]	Härmed intygar [<i>företag</i>] att denna [<i>utrustningstyp</i>] står i överensstämmelse med de väsentliga egenskapskrav och övriga relevanta bestämmelser som framgår av direktiv 1999/5/EG.

Labeling Requirements

The final end product must be labeled in a visible area with the following notice:



© Copyright 2015 Laird. All Rights Reserved. Any information furnished by Laird and its agents is believed to be accurate and reliable. All specifications are subject to change without notice. Responsibility for the use and application of Laird materials or products rests with the end user since Laird and its agents cannot be aware of all potential uses. Laird makes no warranties as to non-infringement nor as to the fitness, merchantability, or sustainability of any Laird materials or products for any specific or general uses. Laird, Laird Technologies, Inc., or any of its affiliates or agents shall not be liable for incidental or consequential damages of any kind. All Laird products are sold pursuant to the Laird Terms and Conditions of Sale in effect from time to time, a copy of which will be furnished upon request. When used as a tradename herein, *Laird* means Laird PLC or one or more subsidiaries of Laird PLC. Laird™, Laird Technologies™, corresponding logos, and other marks are trademarks or registered trademarks of Laird. Other marks may be the property of third parties. Nothing herein provides a license under any Laird or any third party intellectual property right.