

# FCC Test Report

**FCC ID** : SQG-MSD50NBT  
**Equipment** : 802.11abgn Molex 60-pin board-to-board module w/SDIO interface  
**Model No.** : MSD50NBT  
**Brand Name** : Laird Technologies  
**Applicant** : Laird Technologies  
**Address** : 11160 Thompson Ave., Lenexa, Kansas 66219, USA  
**Standard** : 47 CFR FCC Part 15.247  
**Received Date** : Sep. 11, 2015  
**Tested Date** : Dec. 03, 2015 ~ Jan. 26, 2016

We, International Certification Corp., would like to declare that the tested sample has been evaluated and in compliance with the requirement of the above standards. The test results contained in this report refer exclusively to the product. It may be duplicated completely for legal use with the approval of the applicant. It shall not be reproduced except in full without the written approval of our laboratory.

Approved & Reviewed by:

  
\_\_\_\_\_  
Gary Chang / Manager



---

## Table of Contents

<b>1</b>	<b>GENERAL DESCRIPTION .....</b>	<b>5</b>
1.1	Information.....	5
1.2	Local Support Equipment List .....	7
1.3	Test Setup Chart .....	7
1.4	The Equipment List .....	8
1.5	Test Standards .....	9
1.6	Measurement Uncertainty .....	9
<b>2</b>	<b>TEST CONFIGURATION .....</b>	<b>10</b>
2.1	Testing Condition .....	10
2.2	The Worst Test Modes and Channel Details .....	10
<b>3</b>	<b>TRANSMITTER TEST RESULTS.....</b>	<b>11</b>
3.1	Conducted Emissions.....	11
3.2	6dB and Occupied Bandwidth .....	14
3.3	RF Output Power .....	17
3.4	Power Spectral Density .....	19
3.5	Unwanted Emissions into Restricted Frequency Bands .....	21
3.6	Emissions in Non-Restricted Frequency Bands .....	83
<b>4</b>	<b>TEST LABORATORY INFORMATION .....</b>	<b>93</b>

---

## Release Record

Report No.	Version	Description	Issued Date
FR591103AC	Rev. 01	Initial issue	Feb. 22, 2016

## Summary of Test Results

FCC Rules	Test Items	Measured	Result
15.207	Conducted Emissions	[dBuV]: 19.122MHz 18.90 (Margin -31.10dB) - AV	Pass
15.247(d) 15.209	Radiated Emissions	[dBuV/m at 3m]: 2483.50MHz 53.89 (Margin -0.11dB) - AV	Pass
15.247(b)(3)	Maximum Output Power	Max Power [dBm]: 26.89	Pass
15.247(a)(2)	6dB Bandwidth	Meet the requirement of limit	Pass
15.247(e)	Power Spectral Density	Meet the requirement of limit	Pass
15.203	Antenna Requirement	Meet the requirement of limit	Pass

# 1 General Description

## 1.1 Information

### 1.1.1 Specification of the Equipment under Test (EUT)

RF General Information					
Frequency Range (MHz)	IEEE Std. 802.11	Ch. Freq. (MHz)	Channel Number	Transmit Chains (N <sub>TX</sub> )	Data Rate / MCS
2400-2483.5	b	2412-2462	1-11 [11]	1 2	1-11 Mbps
2400-2483.5	g	2412-2462	1-11 [11]	1 2	6-54 Mbps
2400-2483.5	n (HT20)	2412-2462	1-11 [11]	1 2 2	MCS 0-7 MCS 0-7 MCS 8-15

Note 1: RF output power specifies that Maximum Peak Conducted Output Power.  
 Note 2: 802.11b uses a combination of DSSS-DBPSK, DQPSK, CCK modulation.  
 Note 3: 802.11g/n uses a combination of OFDM-BPSK, QPSK, 16QAM, 64QAM modulation.  
 Note 4: The device supports TX antenna diversity function. The conducted power of single chain is same for 1TX and 2TX operating mode. Therefore, Ant1+Ant2 configuration is chosen for final testing.

### 1.1.2 Antenna Details

Ant. No.	Model	Type	Connector	Operating Frequencies (MHz) / Antenna Gain (dBi)				
				2400~2483.5	5150~5250	5250~5350	5470~5725	5725~5850
1	Laird MAF94051	Dipole	RP-SMA	2.1	2.4	2.6	3.4	3.4
2	Laird NanoBlade-IP04	PCB Dipole	IPEX MHF	2	3.9	3.9	4	4
3	Laird MAF95310 Mini NanoBlade Flex	PCB Dipole	IPEX MHF	2.79	3.38	3.38	3.38	3.38
4	Laird NanoBlue-IP04	PCB Dipole	IPEX MHF	2	---	---	---	---
5	Ethertronics WLAN_1000146	Isolated Magnetic Dipole	IPEX MHF	2.5	3.5	3.5	3.5	3.5

**Note:** Ant. No. 1, 3 & 5 were for 2.4G final test.

Ant. No. 1, 2 & 5 were for 5G final test.

### 1.1.3 Power Supply Type of Equipment under Test (EUT)

<b>Power Supply Type</b>	3.3Vdc from host
--------------------------	------------------

### 1.1.4 Accessories

N/A

### 1.1.5 Channel List

Channel	Frequency(MHz)
1	2412
2	2417
3	2422
4	2427
5	2432
6	2437
7	2442
8	2447
9	2452
10	2457
11	2462

### 1.1.6 Test Tool and Duty Cycle

Test Tool	ART2 GUI, V2.3		
Duty Cycle and Duty Factor	Mode	Duty cycle (%)	Duty factor (dB)
	11b	100.00%	0.00
	11g	98.26%	0.08
	HT20	98.03%	0.09

### 1.1.7 Power Setting

Modulation Mode	Test Frequency (MHz)	Power Set
11b	2412	17.5
11b	2437	17.5
11b	2462	18
11g	2412	17
11g	2437	20
11g	2462	16.5
HT20	2412	16.5
HT20	2437	20
HT20	2462	16

## 1.2 Local Support Equipment List

Support Equipment List						
No.	Equipment	Brand	Model	S/N	FCC ID	Signal cable / Length (m)
1	DC Power Supply	GW INSTEK	GPC-3060D	EM884797	---	---
2	Notebook	DELL	Latitude E6430	9ZFB4X1	DoC	---
3	Fixture	---	---	---	---	---

Note: Fixture is provided by applicant.

## 1.3 Test Setup Chart

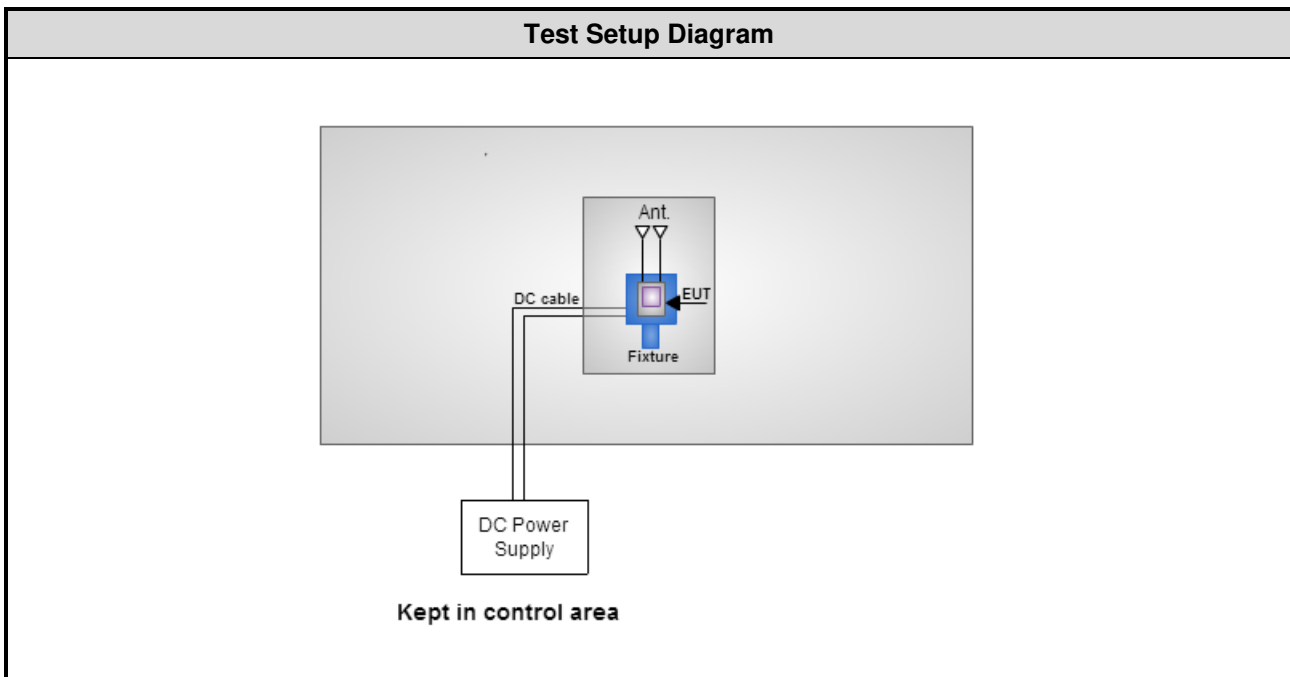

Note: The support notebook was disconnected from EUT and removed from test table when EUT is set to transmit continuously.

## 1.4 The Equipment List

<b>Test Item</b>	Conducted Emission				
<b>Test Site</b>	Conduction room 1 / (CO01-WS)				
<b>Tested Date</b>	Jan. 08, 2016				
<b>Instrument</b>	<b>Manufacturer</b>	<b>Model No.</b>	<b>Serial No.</b>	<b>Calibration Date</b>	<b>Calibration Until</b>
EMC Receiver	R&S	ESCS 30	100169	Oct. 21, 2015	Oct. 20, 2016
LISN	SCHWARZBECK	Schwarzbeck 8127	8127-667	Nov. 13, 2015	Nov. 12, 2016
RF Cable-CON	EMC	EMCCFD300-BM-BM-6000	50821	Dec. 21, 2015	Dec. 20, 2016
Measurement Software	AUDIX	e3	6.120210k	NA	NA
Note: Calibration Interval of instruments listed above is one year.					

<b>Test Item</b>	Radiated Emission				
<b>Test Site</b>	966 chamber 3 / (03CH03-WS)				
<b>Tested Date</b>	Dec. 03 ~ Dec. 26, 2015				
<b>Instrument</b>	<b>Manufacturer</b>	<b>Model No.</b>	<b>Serial No.</b>	<b>Calibration Date</b>	<b>Calibration Until</b>
Spectrum Analyzer	Agilent	N9010A	MY53400091	Sep. 14, 2015	Sep. 13, 2016
Receiver	Agilent	N9038A	MY53290044	Oct. 14, 2015	Oct. 13, 2016
Bilog Antenna	SCHWARZBECK	VULB9168	VULB9168-522	Aug. 20, 2015	Aug. 19, 2016
Horn Antenna 1G-18G	SCHWARZBECK	BBHA 9120 D	BBHA 9120 D 1206	Feb. 03, 2015	Feb. 02, 2016
Horn Antenna 18G-40G	SCHWARZBECK	BBHA 9170	BBHA 9170517	Nov. 04, 2015	Nov. 03, 2016
Preamplifier	EMC	EMC02325	980187	Sep. 21, 2015	Sep. 20, 2016
Preamplifier	Agilent	83017A	MY53270014	Sep. 07, 2015	Sep. 06, 2016
Preamplifier	EMC	EMC184045B	980192	Sep. 01, 2015	Aug. 31, 2016
RF cable-3M	HUBER+SUHNER	SUCOFLEX104	MY22620/4	Feb. 09, 2015	Feb. 08, 2016
RF cable-8M	HUBER+SUHNER	SUCOFLEX104	MY22600/4	Feb. 09, 2015	Feb. 08, 2016
RF cable-1M	HUBER+SUHNER	SUCOFLEX104	MY22624/4	Feb. 09, 2015	Feb. 08, 2016
LF cable-0.8M	EMC	EMC8D-NM-NM-800	EMC8D-NM-NM-800-001	Feb. 09, 2015	Feb. 08, 2016
LF cable-3M	EMC	EMC8D-NM-NM-3000	131103	Feb. 09, 2015	Feb. 08, 2016
LF cable-13M	EMC	EMC8D-NM-NM-13000	131104	Feb. 09, 2015	Feb. 08, 2016
Measurement Software	AUDIX	e3	6.120210g	NA	NA
Note: Calibration Interval of instruments listed above is one year.					



<b>Test Item</b>	RF Conducted				
<b>Test Site</b>	(TH01-WS)				
<b>Tested Date</b>	Jan. 22 ~ Jan. 26, 2016				
<b>Instrument</b>	<b>Manufacturer</b>	<b>Model No.</b>	<b>Serial No.</b>	<b>Calibration Date</b>	<b>Calibration Until</b>
Spectrum Analyzer	R&S	FSV40	101063	Feb. 03, 2015	Feb. 02, 2016
Power Meter	Anritsu	ML2495A	1241002	Sep. 21, 2015	Sep. 20, 2016
Power Sensor	Anritsu	MA2411B	1207366	Sep. 21, 2015	Sep. 20, 2016
DC POWER SOURCE	GW INSTEK	GPC-3060D	EM884797	Oct. 20, 2015	Oct. 19, 2016
Measurement Software	Sporton	Sporton_1	1.3.30	NA	NA
Note: Calibration Interval of instruments listed above is one year.					

## 1.5 Test Standards

According to the specification of EUT, the EUT must comply with following standards and KDB documents.

47 CFR FCC Part 15.247

ANSI C63.10-2013

FCC KDB 558074 D01 DTS Meas Guidance v03r04

FCC KDB 662911 D01 Multiple Transmitter Output v02r01

## 1.6 Measurement Uncertainty

ISO/IEC 17025 requires that an estimate of the measurement uncertainties associated with the emissions test results be included in the report. The measurement uncertainties given below are based on a 95% confidence level (based on a coverage factor ( $k=2$ ))

Measurement Uncertainty	
Parameters	Uncertainty
Bandwidth	$\pm 34.134$ Hz
Conducted power	$\pm 0.808$ dB
Power density	$\pm 0.463$ dB
Conducted emission	$\pm 2.670$ dB
AC conducted emission	$\pm 2.90$ dB
Radiated emission $\leq 1$ GHz	$\pm 3.66$ dB
Radiated emission $> 1$ GHz	$\pm 5.37$ dB

## 2 Test Configuration

### 2.1 Testing Condition

Test Item	Test Site	Ambient Condition	Tested By
AC Conduction	CO01-WS	20°C / 60%	Peter Lin
Radiated Emissions	03CH03-WS	20-23°C / 61-67%	Morgan Lee Warren Lee Aska Huang Anderson Hong Felix Sung
RF Conducted	TH01-WS	21°C / 64%	Alex Huang

➤ FCC site registration No.: 390588

➤ IC site registration No.: 10807C-1

### 2.2 The Worst Test Modes and Channel Details

Test item	Modulation Mode	Test Frequency (MHz)	Data Rate	Test Configuration
Conducted Emissions	11g	2437	MCS 0	2
Radiated Emissions ≤1GHz	11g	2437	MCS 0	1, 2, 3
Radiated Emissions >1GHz	11b 11g HT20	2412 / 2437 / 2462 2412 / 2437 / 2462 2412 / 2437 / 2462	1 Mbps 6 Mbps MCS 0	1, 2, 3
Maximum Output Power 6dB bandwidth Power spectral density	11b 11g HT20	2412 / 2437 / 2462 2412 / 2437 / 2462 2412 / 2437 / 2462	1 Mbps 6 Mbps MCS 0	2

**NOTE:**

- The EUT was pretested with 3 orientations placed on the table for the radiated emission measurement – X, Y, and Z-plane. The **Y-plane** results were found as the worst case and were shown in this report.
- The following antennas are used for final testing for this module: (See item 1.1.2 for more details.)
  - Configuration 1 : Dipole antenna
  - Configuration 2 : PCB Dipole antenna
  - Configuration 3 : Isolated Magnetic Dipole antenna

## 3 Transmitter Test Results

### 3.1 Conducted Emissions

#### 3.1.1 Limit of Conducted Emissions

Conducted Emissions Limit		
Frequency Emission (MHz)	Quasi-Peak	Average
0.15-0.5	66 - 56 *	56 - 46 *
0.5-5	56	46
5-30	60	50

Note 1: \* Decreases with the logarithm of the frequency.

#### 3.1.2 Test Procedures

1. The device is placed on a test table, raised 80 cm above the reference ground plane. The vertical conducting plane is located 40 cm to the rear of the device.
2. The device is connected to line impedance stabilization network (LISN) and other accessories are connected to other LISN. Measured levels of AC power line conducted emission are across the 50  $\Omega$  LISN port.
3. AC conducted emission measurements is made over frequency range from 150 kHz to 30 MHz.
4. This measurement was performed with AC 120V / 60Hz.

#### 3.1.3 Test Setup



- Note: 1. Support units were connected to second LISN.  
 2. Both of LISNs (AMN) are 80 cm from EUT and at least 80 cm from other units and other metal planes

### 3.1.4 Test Result of Conducted Emissions

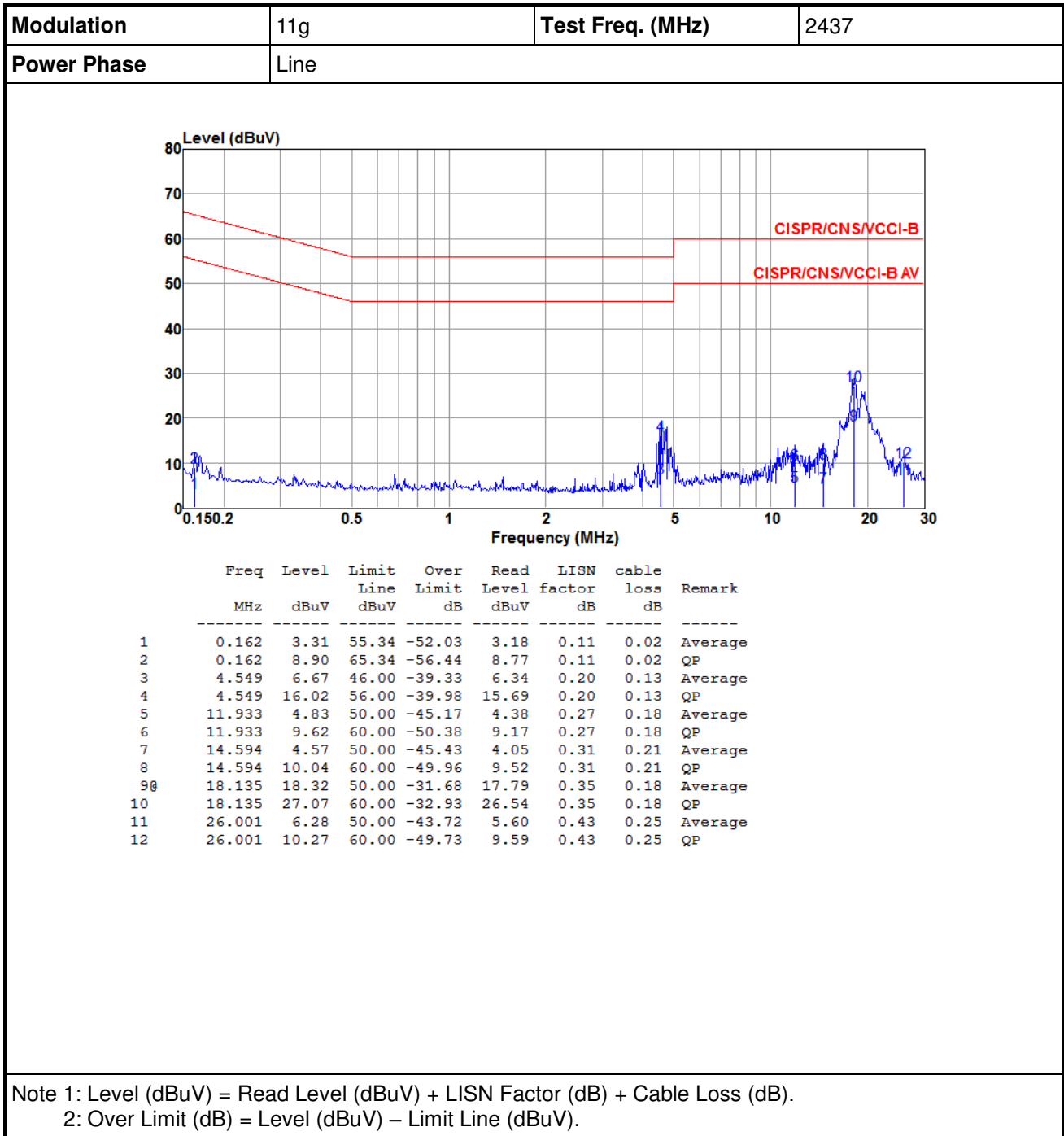

<b>Modulation</b>	11g	<b>Test Freq. (MHz)</b>	2437
<b>Power Phase</b>	Neutral		

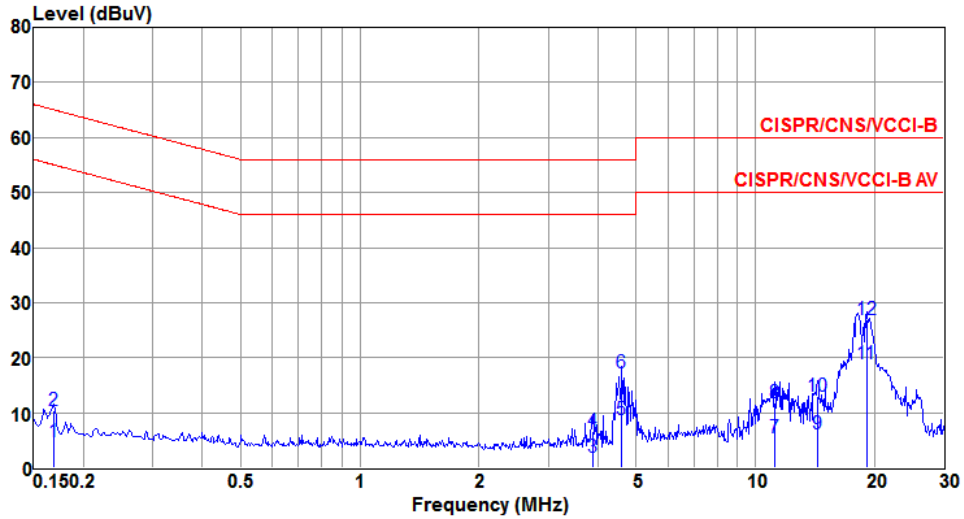

	Freq MHz	Level dBuV	Limit Line dBuV	Over Limit dB	Read Level dBuV	LISN factor dB	cable loss dB	Remark
1	0.169	4.62	55.03	-50.41	4.48	0.12	0.02	Average
2	0.169	10.32	65.03	-54.71	10.18	0.12	0.02	QP
3	3.881	1.92	46.00	-44.08	1.63	0.17	0.12	Average
4	3.881	6.51	56.00	-49.49	6.22	0.17	0.12	QP
5	4.598	8.63	46.00	-37.37	8.31	0.19	0.13	Average
6	4.598	17.12	56.00	-38.88	16.80	0.19	0.13	QP
7	11.198	5.44	50.00	-44.56	4.98	0.29	0.17	Average
8	11.198	11.80	60.00	-48.20	11.34	0.29	0.17	QP
9	14.364	6.24	50.00	-43.76	5.70	0.34	0.20	Average
10	14.364	13.03	60.00	-46.97	12.49	0.34	0.20	QP
11@	19.122	18.90	50.00	-31.10	18.33	0.39	0.18	Average
12	19.122	26.99	60.00	-33.01	26.42	0.39	0.18	QP

Note 1: Level (dBuV) = Read Level (dBuV) + LISN Factor (dB) + Cable Loss (dB).  
 2: Over Limit (dB) = Level (dBuV) – Limit Line (dBuV).

## 3.2 6dB and Occupied Bandwidth

### 3.2.1 Limit of 6dB Bandwidth

The minimum 6dB bandwidth shall be at least 500 kHz.

### 3.2.2 Test Procedures

#### 6dB Bandwidth

1. Set resolution bandwidth (RBW) = 100 kHz, Video bandwidth = 300 kHz.
2. Detector = Peak, Trace mode = max hold.
3. Sweep = auto couple, Allow the trace to stabilize.
4. Measure the maximum width of the emission that is constrained by the frequencies associated with the two outermost amplitude points (upper and lower) that are attenuated by 6dB relative to the maximum level measured in the fundamental emission.

#### Occupied Bandwidth

1. Set resolution bandwidth (RBW) = 300 kHz, Video bandwidth = 1 MHz.
2. Detector = Sample, Trace mode = max hold.
3. Sweep = auto couple, Allow the trace to stabilize.
4. Use the OBW measurement function of spectrum analyzer to measure the occupied bandwidth.

### 3.2.3 Test Setup

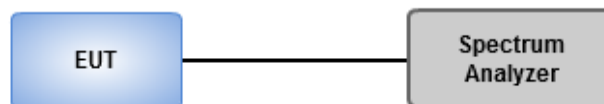

### 3.2.4 Test Result of 6dB and Occupied Bandwidth

Modulation Mode	N <sub>TX</sub>	Freq. (MHz)	6dB Bandwidth (MHz)				Limit (kHz)
			Chain 0	Chain 1	Chain 2	Chain 3	
11b	2	2412	6.61	7.54	---	---	500
11b	2	2437	7.07	6.61	---	---	500
11b	2	2462	7.07	7.07	---	---	500
11g	2	2412	16.06	16.35	---	---	500
11g	2	2437	16.29	16.35	---	---	500
11g	2	2462	16.35	16.35	---	---	500
HT20	2	2412	17.22	16.93	---	---	500
HT20	2	2437	17.22	17.16	---	---	500
HT20	2	2462	17.57	17.28	---	---	500

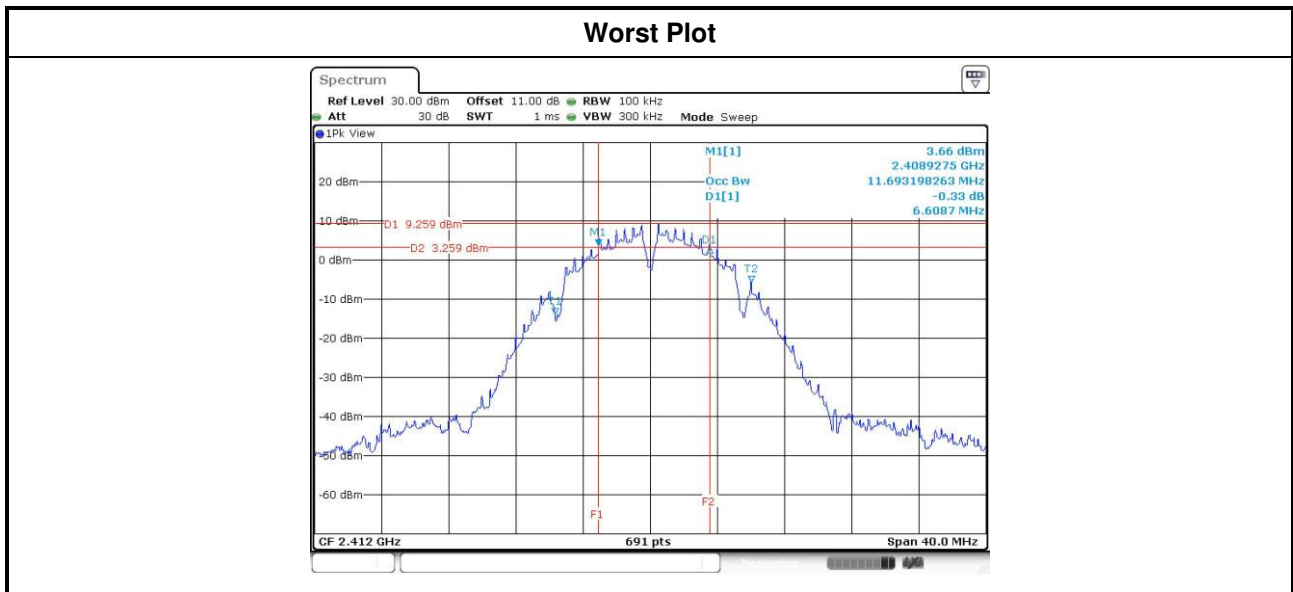

Modulation Mode	N <sub>TX</sub>	Freq. (MHz)	99% Occupied Bandwidth (MHz)			
			Chain 0	Chain 1	Chain 2	Chain 3
11b	2	2412	11.65	11.52	---	---
11b	2	2437	11.81	11.56	---	---
11b	2	2462	11.61	11.49	---	---
11g	2	2412	16.66	16.55	---	---
11g	2	2437	17.11	17.33	---	---
11g	2	2462	16.62	16.55	---	---
HT20	2	2412	17.76	17.73	---	---
HT20	2	2437	18.07	18.20	---	---
HT20	2	2462	17.74	17.71	---	---

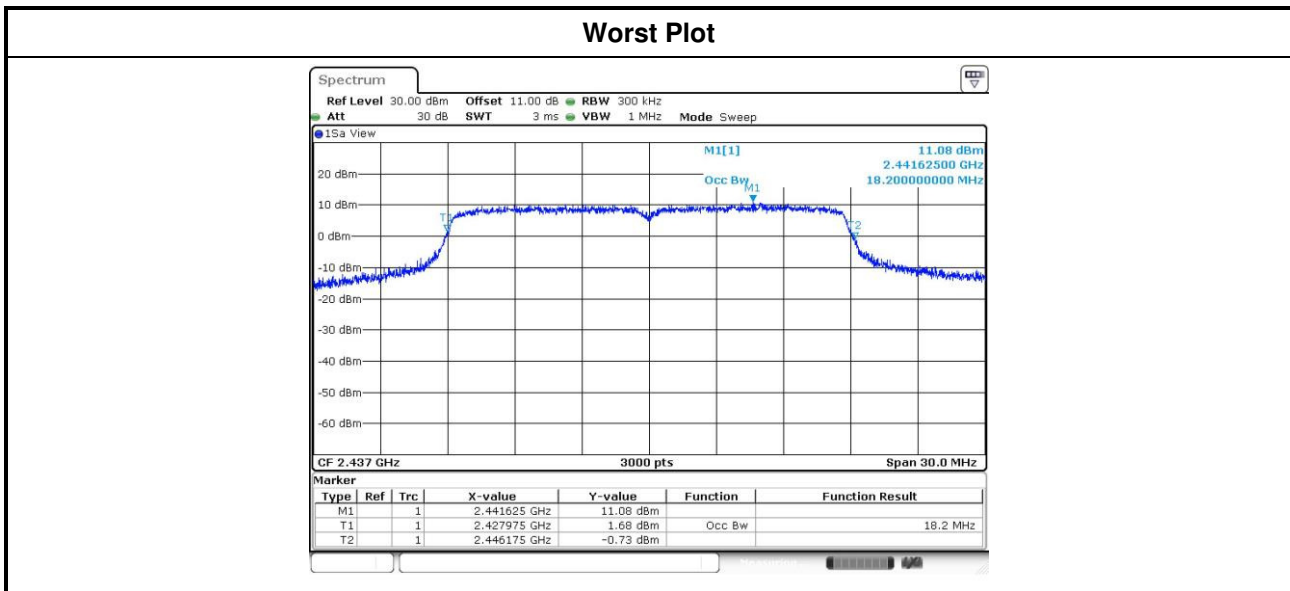



## 3.3 RF Output Power

### 3.3.1 Limit of RF Output Power

Conducted power shall not exceed 1Watt.

- Antenna gain  $\leq$  6dBi, no any corresponding reduction is in output power limit.
- Antenna gain  $>$  6dBi
  - Non Fixed, point to point operations.  
The conducted output power from the intentional radiator shall be reduced by the amount in dB that the directional gain of the antenna exceeds 6 dB
  - Fixed, point to point operations  
Systems operating in the 2400–2483.5 MHz band that are used exclusively for fixed, point-to-point Operations, maximum peak output power of the intentional radiator is reduced by 1 dB for every 3 dB that the directional gain of the antenna exceeds 6 dBi.

Systems operating in the 5725–5850 MHz band that are used exclusively for fixed, point-to-point operations ,no any corresponding reduction is in transmitter peak output power

### 3.3.2 Test Procedures

- Maximum Peak Conducted Output Power
  - Spectrum analyzer**
    1. Set RBW = 1MHz, VBW = 3MHz, Detector = Peak.
    2. Sweep time = auto, Trace mode = max hold, Allow trace to fully stabilize.
    3. Use the spectrum analyzer channel power measurement function with the band limits set equal to the DTS bandwidth edges.
  - Power meter**
    1. A broadband Peak RF power meter is used for output power measurement. The video bandwidth of power meter is greater than DTS bandwidth of EUT. If duty cycle of test signal is not 100 %, trigger and gating function of power meter will be enabled to capture transmission burst for measuring output power.
- Maximum Conducted Output Power ( For reference only )
  - Power meter**
    1. A broadband Average RF power meter is used for output power measurement. The video bandwidth of power meter is greater than DTS bandwidth of EUT. If duty cycle of test signal is not 100 %, trigger and gating function of power meter will be enabled to capture transmission burst for measuring output power.

### 3.3.3 Test Setup

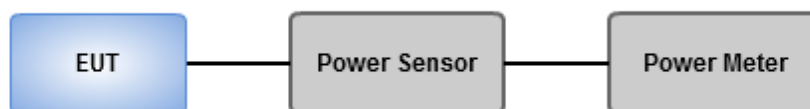

### 3.3.4 Test Result of Maximum Output Power

Modulation Mode	N <sub>TX</sub>	Freq. (MHz)	Peak conducted Output Power (dBm)							Ant. Gain (dBi)	EIRP (dBm)	EIRP Limit (dBm)
			Chain 0	Chain 1	Chain 2	Chain 3	Total Power (mW)	Total Power (dBm)	Limit (dBm)			
11b	2	2412	20.48	20.6	---	---	226.502	23.55	30.00	2.79	26.34	36.00
11b	2	2437	20.96	20.78	---	---	244.412	23.88	30.00	2.79	26.67	36.00
11b	2	2462	20.85	21.17	---	---	252.537	24.02	30.00	2.79	26.81	36.00
11g	2	2412	22.21	22.41	---	---	340.522	25.32	30.00	2.79	28.11	36.00
11g	2	2437	24.11	23.63	---	---	488.307	<b>26.89</b>	30.00	2.79	29.68	36.00
11g	2	2462	22.23	22.12	---	---	330.039	25.19	30.00	2.79	27.98	36.00
HT20	2	2412	21.94	22.04	---	---	316.271	25.00	30.00	2.79	27.79	36.00
HT20	2	2437	24.04	23.6	---	---	482.600	26.84	30.00	2.79	29.63	36.00
HT20	2	2462	21.69	21.61	---	---	292.448	24.66	30.00	2.79	27.45	36.00

Modulation Mode	N <sub>TX</sub>	Freq. (MHz)	Conducted (Average) Output Power (dBm)				Total Power (mW)	Total Power (dBm)	Limit (dBm)
			Chain 0	Chain 1	Chain 2	Chain 3			
11b	2	2412	17.02	17.05	---	---	101.049	20.05	---
11b	2	2437	17.8	17.3	---	---	113.959	20.57	---
11b	2	2462	17.12	17.54	---	---	108.277	20.35	---
11g	2	2412	16.7	16.74	---	---	93.980	19.73	---
11g	2	2437	19.72	19.36	---	---	180.054	<b>22.55</b>	---
11g	2	2462	16.02	16.06	---	---	80.359	19.05	---
HT20	2	2412	16.01	16.03	---	---	79.989	19.03	---
HT20	2	2437	19.55	19.34	---	---	176.058	22.46	---
HT20	2	2462	15.52	15.54	---	---	71.455	18.54	---

Note: Conducted average output power is for reference only.

## 3.4 Power Spectral Density

### 3.4.1 Limit of Power Spectral Density

Power spectral density shall not be greater than 8 dBm in any 3 kHz band.

### 3.4.2 Test Procedures

- Maximum peak conducted output power was used to demonstrate compliance to the fundamental output power limit.
  1. Set the RBW = 3kHz, VBW = 10kHz.
  2. Detector = Peak, Sweep time = auto couple.
  3. Trace mode = max hold, allow trace to fully stabilize.
  4. Use the peak marker function to determine the maximum amplitude level.
- Maximum (average) conducted output power was used to demonstrate compliance to the fundamental output power limit.
  1. Set the RBW = 100kHz, VBW = 300 kHz.
  2. Detector = RMS, Sweep time = auto couple.
  3. Set the sweep time to:  $\geq 10 \times$  (number of measurement points in sweep)  $\times$  (maximum data rate per stream).
  4. Perform the measurement over a single sweep.
  5. Use the peak marker function to determine the maximum amplitude level.

### 3.4.3 Test Setup

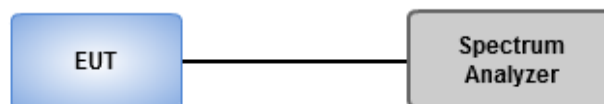

### 3.4.4 Test Result of Power Spectral Density

Modulation Mode	N <sub>TX</sub>	Freq. (MHz)	Total Power Spectral Density (dBm/3kHz)	Limit (dBm/3kHz)
11b	2	2412	-3.18	8.00
11b	2	2437	-2.27	8.00
11b	2	2462	-1.58	8.00
11g	2	2412	-6.30	8.00
11g	2	2437	-3.50	8.00
11g	2	2462	-4.29	8.00
HT20	2	2412	-6.57	8.00
HT20	2	2437	-2.94	8.00
HT20	2	2462	-5.26	8.00

Note: Test result is bin-by-bin summing measured value of each TX port.

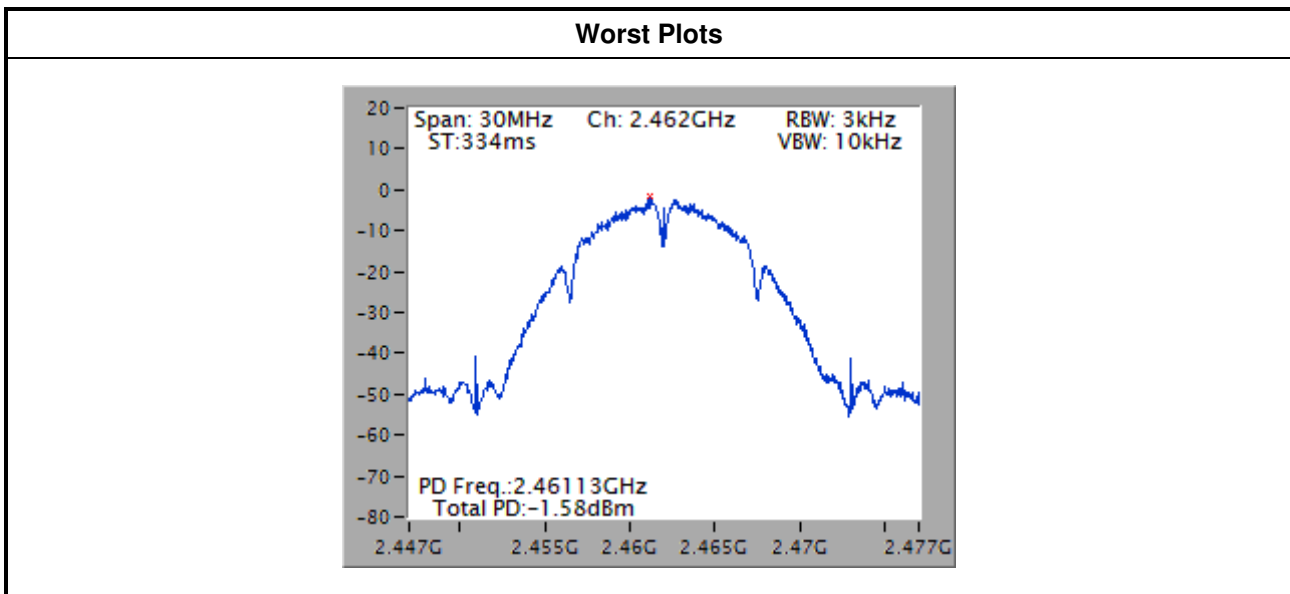

## 3.5 Unwanted Emissions into Restricted Frequency Bands

### 3.5.1 Limit of Unwanted Emissions into Restricted Frequency Bands

Restricted Band Emissions Limit			
Frequency Range (MHz)	Field Strength (uV/m)	Field Strength (dBuV/m)	Measure Distance (m)
0.009~0.490	2400/F(kHz)	48.5 - 13.8	300
0.490~1.705	24000/F(kHz)	33.8 - 23	30
1.705~30.0	30	29	30
30~88	100	40	3
88~216	150	43.5	3
216~960	200	46	3
Above 960	500	54	3

**Note 1:**  
Quasi-Peak value is measured for frequency below 1GHz except for 9–90 kHz, 110–490 kHz frequency band. Peak and average value are measured for frequency above 1GHz. The limit on average radio frequency emission is as above table. The limit on peak radio frequency emissions is 20 dB above the maximum permitted average emission limit

**Note 2:**  
Measurements may be performed at a distance other than what is specified provided. When performing measurements at a distance other than that specified, the results shall be extrapolated to the specified distance using an extrapolation factor as below, Frequency at or above 30 MHz: 20 dB/decade Frequency below 30 MHz: 40 dB/decade.

### 3.5.2 Test Procedures

1. Measurement is made at a semi-anechoic chamber that incorporates a turntable allowing a EUT rotation of 360°. A continuously-rotating, remotely-controlled turntable is installed at the test site to support the EUT and facilitate determination of the direction of maximum radiation for each EUT emission frequency. The EUT is placed at test table. For emissions testing at or below 1 GHz, the table height is 80 cm above the reference ground plane. For emission measurements above 1 GHz, the table height is 1.5 m
2. Measurement is made with the antenna positioned in both the horizontal and vertical planes of polarization. The measurement antenna is varied in height (1m ~ 4m) above the reference ground plane to obtain the maximum signal strength. Distance between EUT and antenna is 3 m.
3. This investigation is performed with the EUT rotated 360°, the antenna height scanned between 1 m and 4 m, and the antenna rotated to repeat the measurements for both the horizontal and vertical antenna polarizations.

Note:

1. 120kHz measurement bandwidth of test receiver and Quasi-peak detector is for radiated emission below 1GHz.
2. RBW=1MHz, VBW=3MHz and Peak detector is for peak measured value of radiated emission above 1GHz.
3. RBW=1MHz, VBW=1/T and Peak detector is for average measured value of radiated emission above 1GHz.

### 3.5.3 Test Setup

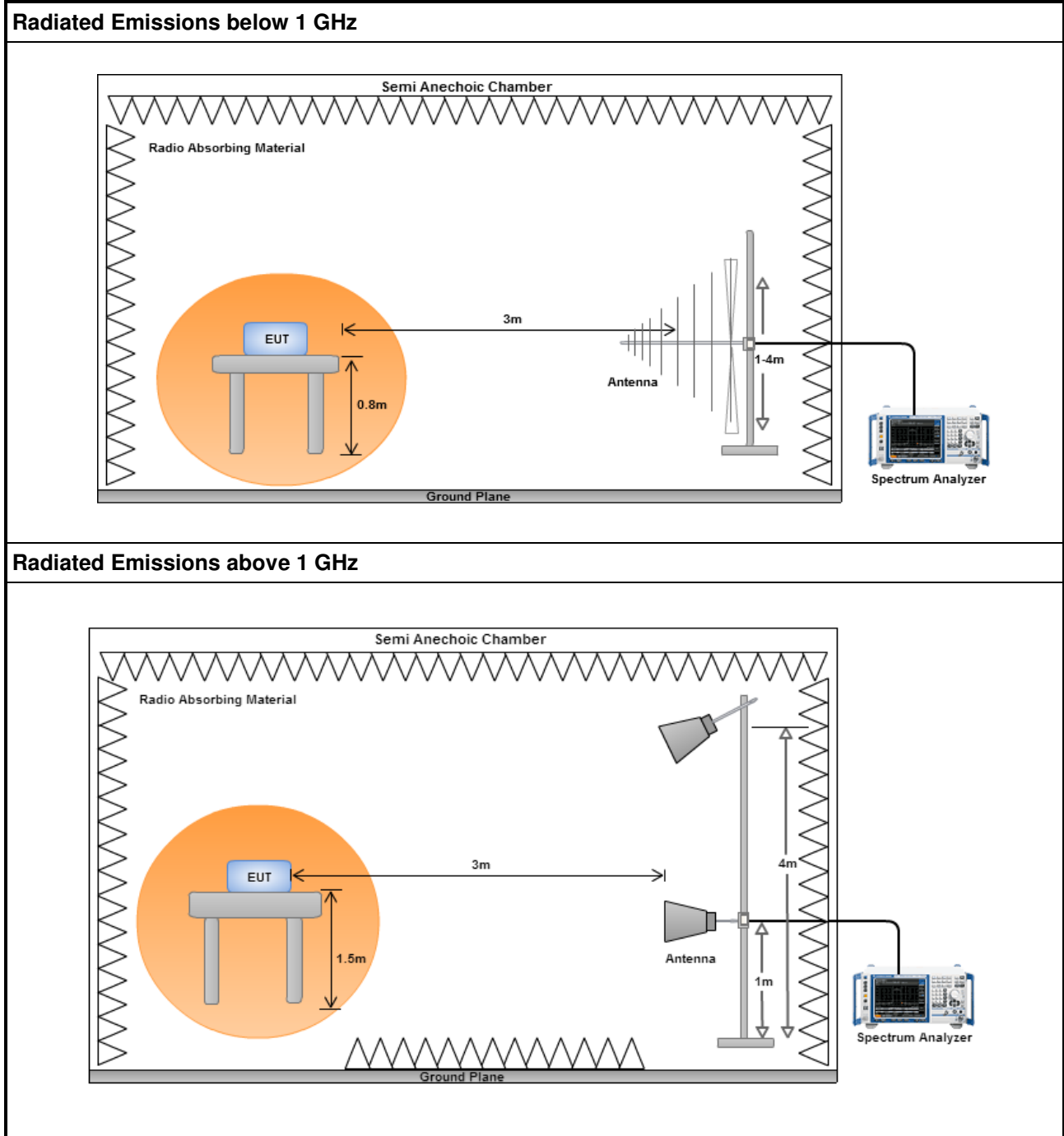

### Test Configuration 1: Dipole antenna

#### 3.5.4 Transmitter Radiated Unwanted Emissions (Below 1GHz)

<b>Modulation</b>	11g	<b>Test Freq. (MHz)</b>	2437
<b>Polarization</b>	Horizontal	<b>Test Configuration</b>	1

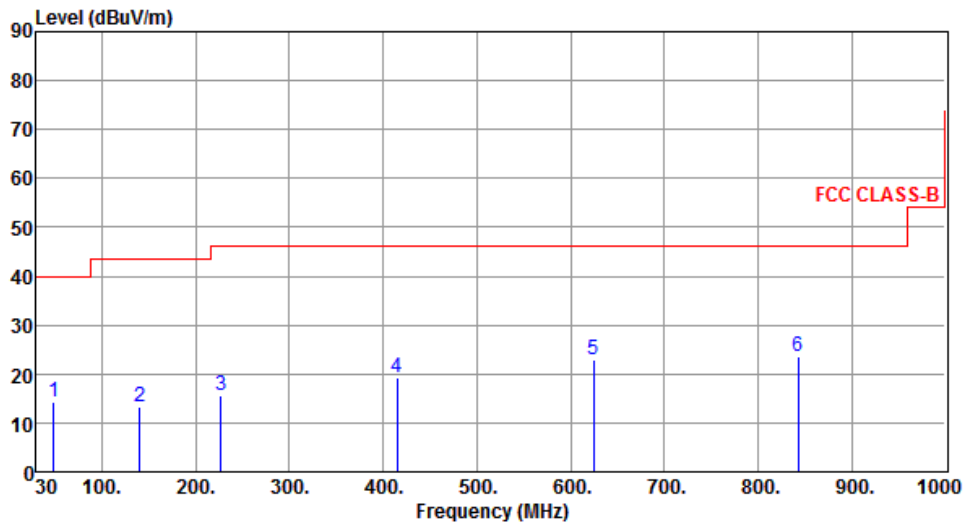

	Freq. MHz	Emission level dBuV/m	Limit dBuV/m	Margin dB	SA reading dBuV	Factor dB	Remark	ANT High cm	Turn Table deg
1	48.43	14.12	40.00	-25.88	27.03	-12.91	Peak	---	---
2	140.58	13.27	43.50	-30.23	27.00	-13.73	Peak	---	---
3	226.91	15.52	46.00	-30.48	31.08	-15.56	Peak	---	---
4	415.09	19.12	46.00	-26.88	28.78	-9.66	Peak	---	---
5	624.61	22.76	46.00	-23.24	28.20	-5.44	Peak	---	---
6	842.86	23.67	46.00	-22.33	25.59	-1.92	Peak	---	---

Note 1: Emission Level (dBuV/m) = SA Reading (dBuV/m) + Factor\* (dB)

\*Factor includes antenna factor , cable loss and amplifier gain

Note 2: Margin (dB) = Emission level (dBuV/m) – Limit (dBuV/m).

Note 3: All spurious emissions below 30MHz are more than 20 dB below the limit.

<b>Modulation</b>	11g	<b>Test Freq. (MHz)</b>	2437
<b>Polarization</b>	Vertical	<b>Test Configuration</b>	1

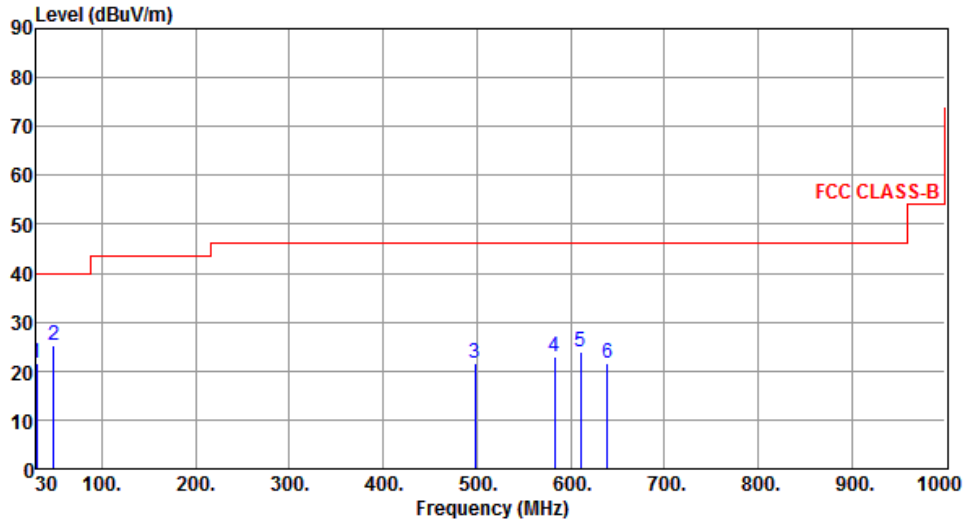

	Freq. MHz	Emission level dBuV/m	Limit dBuV/m	Margin dB	SA reading dBuV	Factor dB	Remark	ANT High cm	Turn Table deg
1	30.00	21.48	40.00	-18.52	34.99	-13.51	Peak	---	---
2	48.43	25.17	40.00	-14.83	38.08	-12.91	Peak	---	---
3	498.51	21.56	46.00	-24.44	29.25	-7.69	Peak	---	---
4	582.90	23.01	46.00	-22.99	29.26	-6.25	Peak	---	---
5	611.03	24.01	46.00	-21.99	29.64	-5.63	Peak	---	---
6	639.16	21.74	46.00	-24.26	26.97	-5.23	Peak	---	---

Note 1: Emission Level (dBuV/m) = SA Reading (dBuV/m) + Factor\* (dB)

\*Factor includes antenna factor , cable loss and amplifier gain

Note 2: Margin (dB) = Emission level (dBuV/m) – Limit (dBuV/m).

Note 3: All spurious emissions below 30MHz are more than 20 dB below the limit.



### 3.5.5 Transmitter Radiated Unwanted Emissions (Above 1GHz) for 11b

<b>Modulation</b>	11b	<b>Test Freq. (MHz)</b>	2412
<b>Polarization</b>	Horizontal	<b>Test Configuration</b>	1

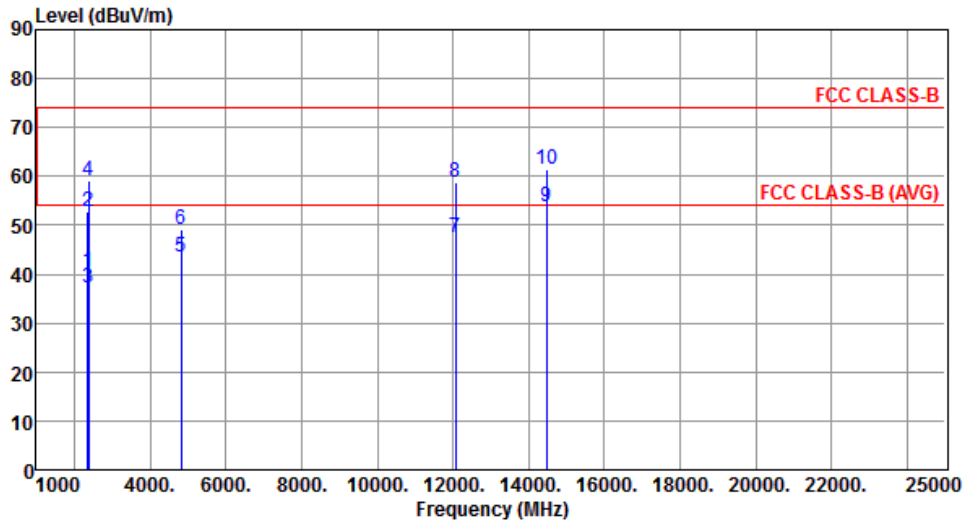

	Freq. MHz	Emission level dBUV/m	Limit dBUV/m	Margin dB	SA reading dBUV	Factor dB	Remark	ANT High cm	Turn Table deg
1	2360.00	40.53	54.00	-13.47	42.03	-1.50	Average	193	30
2	2360.00	52.77	74.00	-21.23	54.27	-1.50	Peak	193	30
3	2390.00	37.26	54.00	-16.74	38.62	-1.36	Average	193	30
4	2390.00	58.95	74.00	-15.05	60.31	-1.36	Peak	193	30
5	4824.00	43.48	54.00	-10.52	37.54	5.94	Average	228	20
6	4824.00	49.16	74.00	-24.84	43.22	5.94	Peak	228	20
7	12060.00	47.53	54.00	-6.47	31.56	15.97	Average	135	20
8	12060.00	58.62	74.00	-15.38	42.65	15.97	Peak	135	20
9	14472.00	53.67	54.00	-0.33	34.26	19.41	Average	208	345
10	14472.00	61.47	74.00	-12.53	42.06	19.41	Peak	208	345

Note 1: Emission Level (dBUV/m) = SA Reading (dBUV/m) + Factor\* (dB)

\*Factor includes antenna factor , cable loss and amplifier gain

Note 2: Margin (dB) = Emission level (dBUV/m) – Limit (dBUV/m).

<b>Modulation</b>	11b	<b>Test Freq. (MHz)</b>	2412
<b>Polarization</b>	Vertical	<b>Test Configuration</b>	1

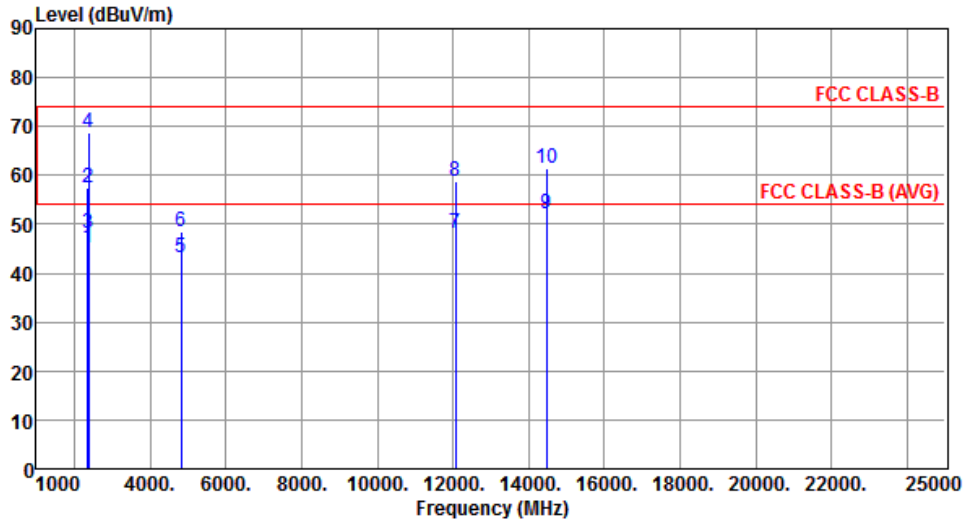

	Freq. MHz	Emission level dBuV/m	Limit dBuV/m	Margin dB	SA reading dBuV	Factor dB	Remark	ANT High cm	Turn Table deg
1	2360.00	45.25	54.00	-8.75	46.75	-1.50	Average	137	324
2	2360.00	57.58	74.00	-16.42	59.08	-1.50	Peak	137	324
3	2390.00	48.25	54.00	-5.75	49.61	-1.36	Average	137	324
4	2390.00	68.60	74.00	-5.40	69.96	-1.36	Peak	137	324
5	4824.00	43.03	54.00	-10.97	37.09	5.94	Average	208	336
6	4824.00	48.47	74.00	-25.53	42.53	5.94	Peak	208	336
7	12060.00	48.30	54.00	-5.70	32.33	15.97	Average	145	18
8	12060.00	58.80	74.00	-15.20	42.83	15.97	Peak	145	18
9	14472.00	52.25	54.00	-1.75	32.84	19.41	Average	165	352
10	14472.00	61.59	74.00	-12.41	42.18	19.41	Peak	165	352

Note 1: Emission Level (dBuV/m) = SA Reading (dBuV/m) + Factor\* (dB)

\*Factor includes antenna factor , cable loss and amplifier gain

Note 2: Margin (dB) = Emission level (dBuV/m) – Limit (dBuV/m).

<b>Modulation</b>	11b	<b>Test Freq. (MHz)</b>	2437
<b>Polarization</b>	Horizontal	<b>Test Configuration</b>	1

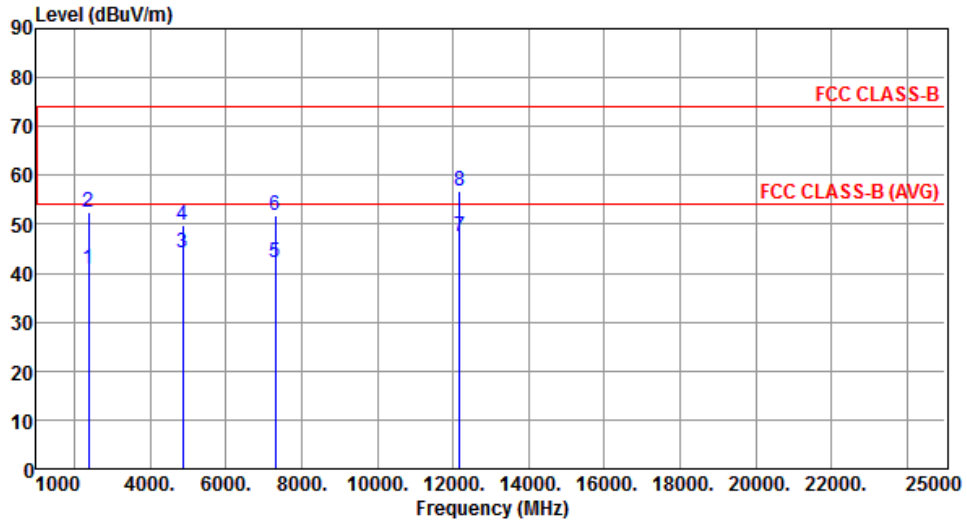

	Freq. MHz	Emission level dBuV/m	Limit dBuV/m	Margin dB	SA reading dBuV	Factor dB	Remark	ANT High cm	Turn Table deg
1	2386.00	40.83	54.00	-13.17	42.21	-1.38	Average	198	350
2	2386.00	52.49	74.00	-21.51	53.87	-1.38	Peak	198	350
3	4874.00	44.02	54.00	-9.98	38.05	5.97	Average	257	2
4	4874.00	49.79	74.00	-24.21	43.82	5.97	Peak	257	2
5	7311.00	42.25	54.00	-11.75	31.50	10.75	Average	210	16
6	7311.00	51.87	74.00	-22.13	41.12	10.75	Peak	210	16
7	12185.00	47.50	54.00	-6.50	31.66	15.84	Average	172	18
8	12185.00	56.76	74.00	-17.24	40.92	15.84	Peak	172	18

Note 1: Emission Level (dBuV/m) = SA Reading (dBuV/m) + Factor\* (dB)

\*Factor includes antenna factor , cable loss and amplifier gain

Note 2: Margin (dB) = Emission level (dBuV/m) – Limit (dBuV/m).

<b>Modulation</b>	11b	<b>Test Freq. (MHz)</b>	2437
<b>Polarization</b>	Vertical	<b>Test Configuration</b>	1

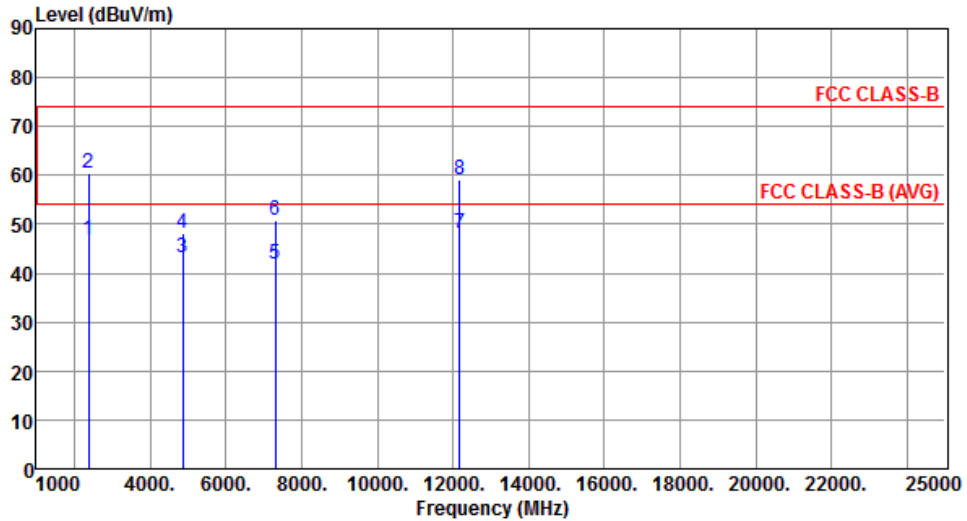

	Freq. MHz	Emission level dBuV/m	Limit dBuV/m	Margin dB	SA reading dBuV	Factor dB	Remark	ANT High cm	Turn Table deg
1	2386.00	46.90	54.00	-7.10	48.28	-1.38	Average	140	309
2	2386.00	60.40	74.00	-13.60	61.78	-1.38	Peak	140	309
3	4874.00	43.11	54.00	-10.89	37.14	5.97	Average	226	309
4	4874.00	48.26	74.00	-25.74	42.29	5.97	Peak	226	309
5	7311.00	41.88	54.00	-12.12	31.13	10.75	Average	169	349
6	7311.00	50.89	74.00	-23.11	40.14	10.75	Peak	169	349
7	12185.00	48.28	54.00	-5.72	32.44	15.84	Average	158	345
8	12185.00	58.98	74.00	-15.02	43.14	15.84	Peak	158	345

Note 1: Emission Level (dBuV/m) = SA Reading (dBuV/m) + Factor\* (dB)

\*Factor includes antenna factor , cable loss and amplifier gain

Note 2: Margin (dB) = Emission level (dBuV/m) – Limit (dBuV/m).

<b>Modulation</b>	11b	<b>Test Freq. (MHz)</b>	2462
<b>Polarization</b>	Horizontal	<b>Test Configuration</b>	1

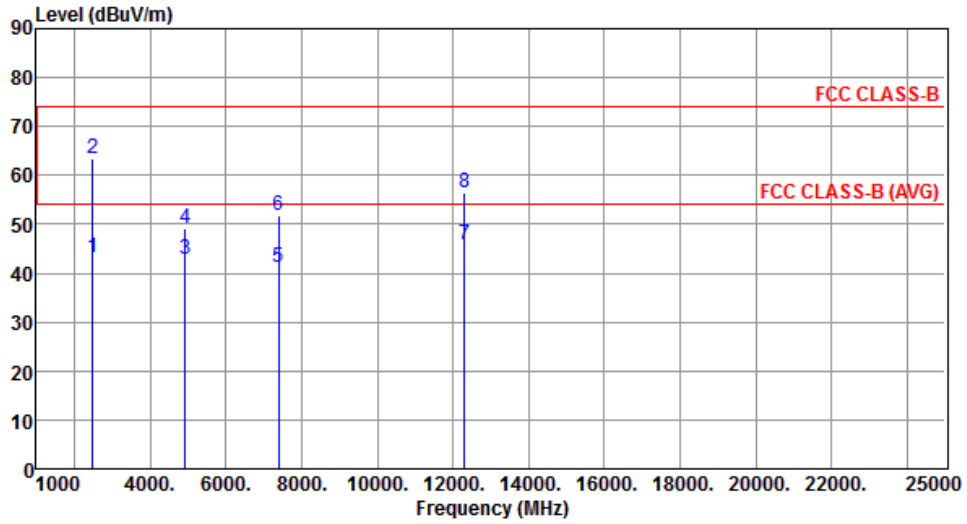

	Freq. MHz	Emission level dBuV/m	Limit dBuV/m	Margin dB	SA reading dBuV	Factor dB	Remark	ANT High cm	Turn Table deg
1	2483.50	43.22	54.00	-10.78	44.24	-1.02	Average	189	355
2	2483.50	63.52	74.00	-10.48	64.54	-1.02	Peak	189	355
3	4924.00	42.71	54.00	-11.29	36.70	6.01	Average	237	13
4	4924.00	48.99	74.00	-25.01	42.98	6.01	Peak	237	13
5	7386.00	41.15	54.00	-12.85	30.25	10.90	Average	225	43
6	7386.00	51.72	74.00	-22.28	40.82	10.90	Peak	225	43
7	12310.00	45.82	54.00	-8.18	30.12	15.70	Average	181	357
8	12310.00	56.59	74.00	-17.41	40.89	15.70	Peak	181	357

Note 1: Emission Level (dBuV/m) = SA Reading (dBuV/m) + Factor\* (dB)

\*Factor includes antenna factor , cable loss and amplifier gain

Note 2: Margin (dB) = Emission level (dBuV/m) – Limit (dBuV/m).

<b>Modulation</b>	11b	<b>Test Freq. (MHz)</b>	2462
<b>Polarization</b>	Vertical	<b>Test Configuration</b>	1

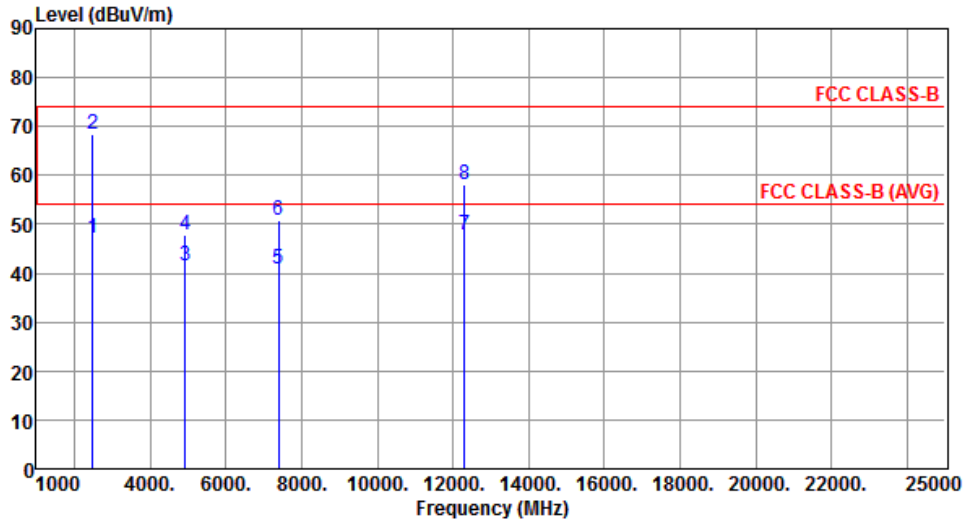

	Freq. MHz	Emission level dBuV/m	Limit dBuV/m	Margin dB	SA reading dBuV	Factor dB	Remark	ANT High cm	Turn Table deg
1	2483.50	47.22	54.00	-6.78	48.24	-1.02	Average	271	38
2	2483.50	68.49	74.00	-5.51	69.51	-1.02	Peak	271	38
3	4924.00	41.67	54.00	-12.33	35.66	6.01	Average	279	303
4	4924.00	47.89	74.00	-26.11	41.88	6.01	Peak	279	303
5	7386.00	40.88	54.00	-13.12	29.98	10.90	Average	257	269
6	7386.00	50.93	74.00	-23.07	40.03	10.90	Peak	257	269
7	12310.00	47.91	54.00	-6.09	32.21	15.70	Average	185	320
8	12310.00	58.17	74.00	-15.83	42.47	15.70	Peak	185	320

Note 1: Emission Level (dBuV/m) = SA Reading (dBuV/m) + Factor\* (dB)

\*Factor includes antenna factor , cable loss and amplifier gain

Note 2: Margin (dB) = Emission level (dBuV/m) – Limit (dBuV/m).

### 3.5.6 Transmitter Radiated Unwanted Emissions (Above 1GHz) for 11g

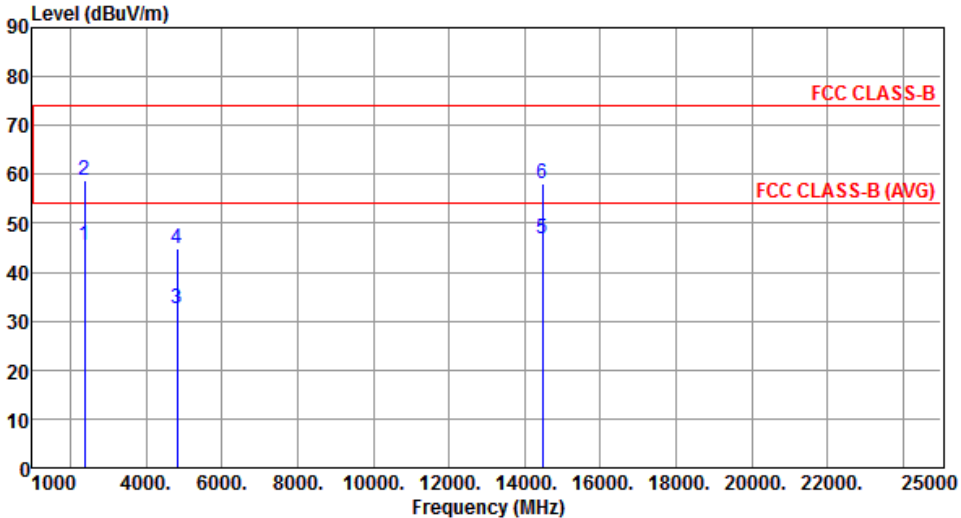
Modulation	11g	Test Freq. (MHz)	2412						
Polarization	Horizontal	Test Configuration	1						
									
	Freq.	Emission level	Limit	Margin	SA reading	Factor	Remark	ANT High	Turn Table
	MHz	dBuV/m	dBuV/m	dB	dBuV	dB		cm	deg
1	2390.00	45.51	54.00	-8.49	46.87	-1.36	Average	204	275
2	2390.00	58.90	74.00	-15.10	60.26	-1.36	Peak	204	275
3	4824.00	32.66	54.00	-21.34	26.72	5.94	Average	257	149
4	4824.00	44.69	74.00	-29.31	38.75	5.94	Peak	257	149
5	14472.00	46.70	54.00	-7.30	27.29	19.41	Average	615	268
6	14472.00	58.06	74.00	-15.94	38.65	19.41	Peak	615	268
<p>Note 1: Emission Level (dBuV/m) = SA Reading (dBuV/m) + Factor* (dB)            *Factor includes antenna factor , cable loss and amplifier gain            Note 2: Margin (dB) = Emission level (dBuV/m) – Limit (dBuV/m).</p>									

<b>Modulation</b>	11g	<b>Test Freq. (MHz)</b>	2412
<b>Polarization</b>	Vertical	<b>Test Configuration</b>	1

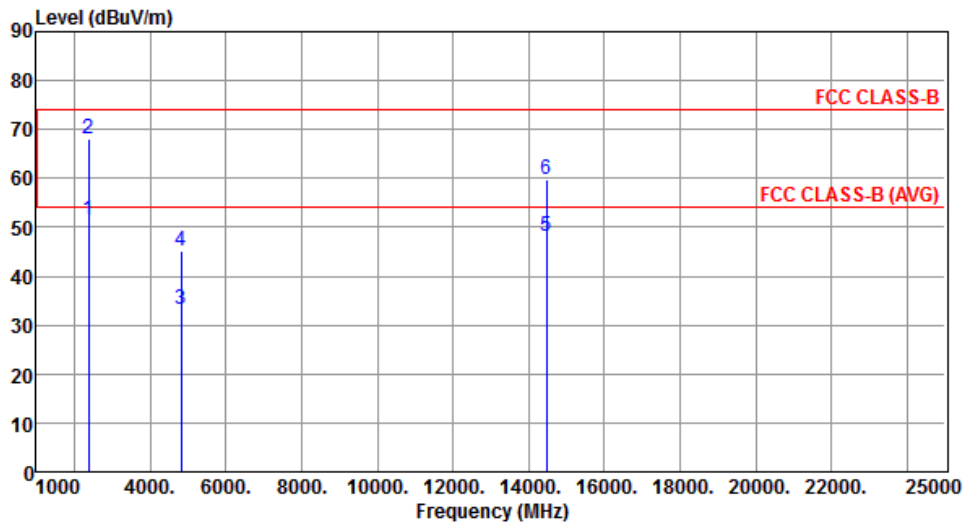

	Freq. MHz	Emission level dBuV/m	Limit dBuV/m	Margin dB	SA reading dBuV	Factor dB	Remark	ANT High cm	Turn Table deg
1	2390.00	51.60	54.00	-2.40	52.96	-1.36	Average	198	320
2	2390.00	68.21	74.00	-5.79	69.57	-1.36	Peak	198	320
3	4824.00	33.33	54.00	-20.67	27.39	5.94	Average	209	173
4	4824.00	45.20	74.00	-28.80	39.26	5.94	Peak	209	173
5	14472.00	48.01	54.00	-5.99	28.60	19.41	Average	13	568
6	14472.00	59.67	74.00	-14.33	40.26	19.41	Peak	13	568

Note 1: Emission Level (dBuV/m) = SA Reading (dBuV/m) + Factor\* (dB)

\*Factor includes antenna factor , cable loss and amplifier gain

Note 2: Margin (dB) = Emission level (dBuV/m) – Limit (dBuV/m).



<b>Modulation</b>	11g	<b>Test Freq. (MHz)</b>	2437
<b>Polarization</b>	Horizontal	<b>Test Configuration</b>	1

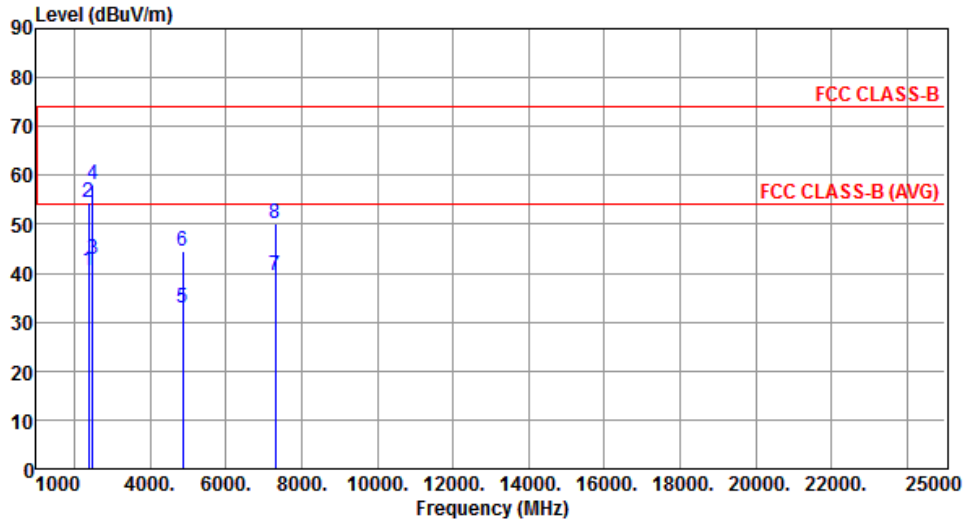

	Freq. MHz	Emission level dBuV/m	Limit dBuV/m	Margin dB	SA reading dBuV	Factor dB	Remark	ANT High cm	Turn Table deg
1	2390.00	40.45	54.00	-13.55	41.81	-1.36	Average	194	337
2	2390.00	54.61	74.00	-19.39	55.97	-1.36	Peak	194	337
3	2483.50	42.75	54.00	-11.25	43.77	-1.02	Average	194	337
4	2483.50	58.06	74.00	-15.94	59.08	-1.02	Peak	194	337
5	4874.00	32.77	54.00	-21.23	26.80	5.97	Average	194	337
6	4874.00	44.50	74.00	-29.50	38.53	5.97	Peak	194	337
7	7311.00	39.45	54.00	-14.55	28.70	10.75	Average	193	16
8	7311.00	50.05	74.00	-23.95	39.30	10.75	Peak	193	16

Note 1: Emission Level (dBuV/m) = SA Reading (dBuV/m) + Factor\* (dB)

\*Factor includes antenna factor , cable loss and amplifier gain

Note 2: Margin (dB) = Emission level (dBuV/m) – Limit (dBuV/m).

<b>Modulation</b>	11g	<b>Test Freq. (MHz)</b>	2437
<b>Polarization</b>	Vertical	<b>Test Configuration</b>	1

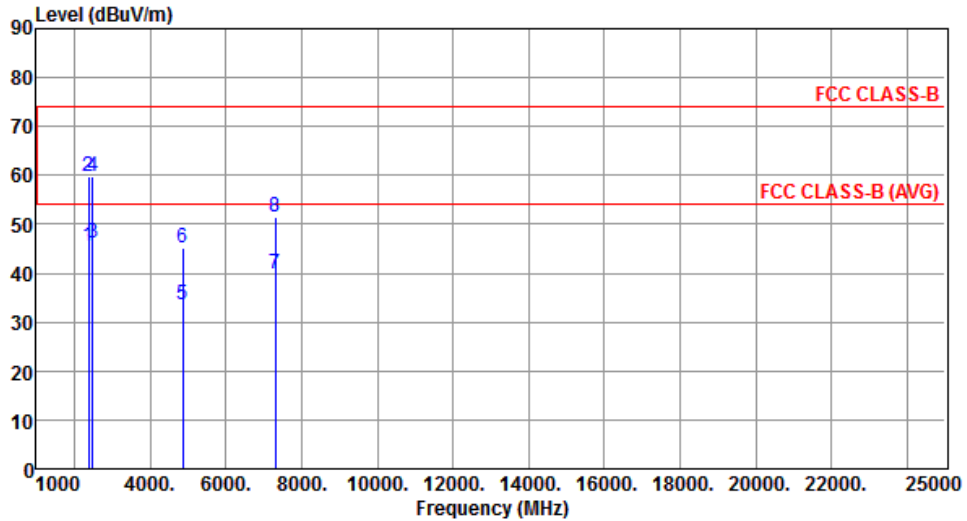

	Freq. MHz	Emission level dBuV/m	Limit dBuV/m	Margin dB	SA reading dBuV	Factor dB	Remark	ANT High cm	Turn Table deg
1	2390.00	45.58	54.00	-8.42	46.94	-1.36	Average	161	359
2	2390.00	59.83	74.00	-14.17	61.19	-1.36	Peak	161	359
3	2483.50	46.26	54.00	-7.74	47.28	-1.02	Average	161	359
4	2483.50	59.76	74.00	-14.24	60.78	-1.02	Peak	161	359
5	4874.00	33.57	54.00	-20.43	27.60	5.97	Average	309	257
6	4874.00	45.23	74.00	-28.77	39.26	5.97	Peak	309	257
7	7311.00	40.01	54.00	-13.99	29.26	10.75	Average	309	257
8	7311.00	51.62	74.00	-22.38	40.87	10.75	Peak	309	257

Note 1: Emission Level (dBuV/m) = SA Reading (dBuV/m) + Factor\* (dB)

\*Factor includes antenna factor , cable loss and amplifier gain

Note 2: Margin (dB) = Emission level (dBuV/m) – Limit (dBuV/m).

<b>Modulation</b>	11g	<b>Test Freq. (MHz)</b>	2462
<b>Polarization</b>	Horizontal	<b>Test Configuration</b>	1

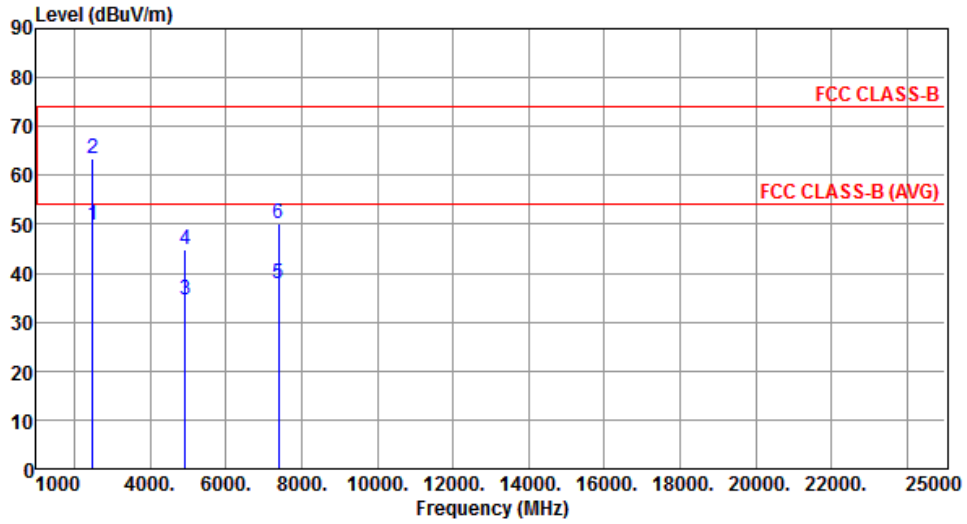

	Freq. MHz	Emission level dBuV/m	Limit dBuV/m	Margin dB	SA reading dBuV	Factor dB	Remark	ANT High cm	Turn Table deg
1	2483.50	49.70	54.00	-4.30	50.72	-1.02	Average	201	250
2	2483.50	63.52	74.00	-10.48	64.54	-1.02	Peak	201	250
3	4924.00	34.51	54.00	-19.49	28.50	6.01	Average	301	271
4	4924.00	44.82	74.00	-29.18	38.81	6.01	Peak	301	271
5	7386.00	37.98	54.00	-16.02	27.08	10.90	Average	303	266
6	7386.00	50.10	74.00	-23.90	39.20	10.90	Peak	303	266

Note 1: Emission Level (dBuV/m) = SA Reading (dBuV/m) + Factor\* (dB)

\*Factor includes antenna factor , cable loss and amplifier gain

Note 2: Margin (dB) = Emission level (dBuV/m) – Limit (dBuV/m).

<b>Modulation</b>	11g	<b>Test Freq. (MHz)</b>	2462
<b>Polarization</b>	Vertical	<b>Test Configuration</b>	1

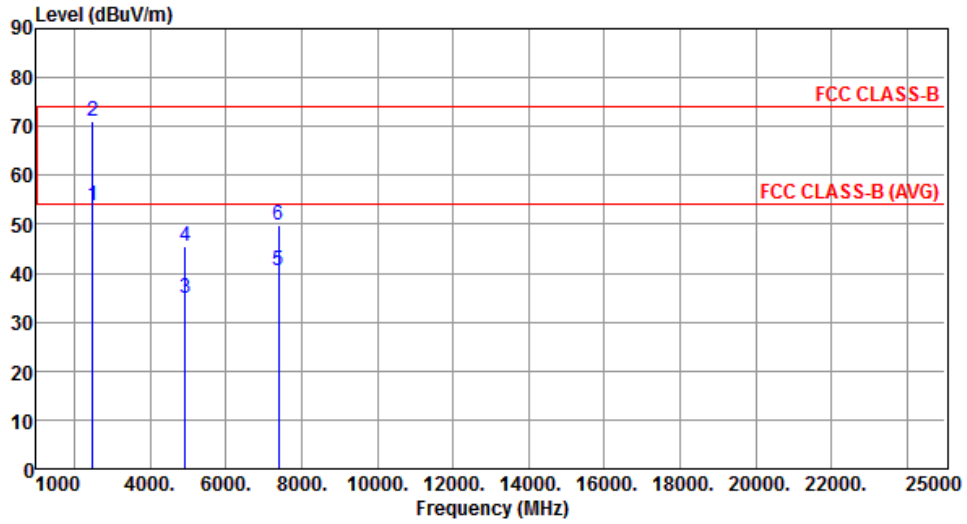

	Freq. MHz	Emission level dBuV/m	Limit dBuV/m	Margin dB	SA reading dBuV	Factor dB	Remark	ANT High cm	Turn Table deg
1	2483.50	53.73	54.00	-0.27	54.75	-1.02	Average	214	311
2	2483.50	71.20	74.00	-2.80	72.22	-1.02	Peak	214	311
3	4924.00	34.95	54.00	-19.05	28.94	6.01	Average	265	277
4	4924.00	45.65	74.00	-28.35	39.64	6.01	Peak	265	277
5	7386.00	40.54	54.00	-13.46	29.64	10.90	Average	341	101
6	7386.00	49.82	74.00	-24.18	38.92	10.90	Peak	341	101

Note 1: Emission Level (dBuV/m) = SA Reading (dBuV/m) + Factor\* (dB)

\*Factor includes antenna factor , cable loss and amplifier gain

Note 2: Margin (dB) = Emission level (dBuV/m) – Limit (dBuV/m).

### 3.5.7 Transmitter Radiated Unwanted Emissions (Above 1GHz) for HT20

Modulation	HT20	Test Freq. (MHz)	2412
Polarization	Horizontal	Test Configuration	1

  

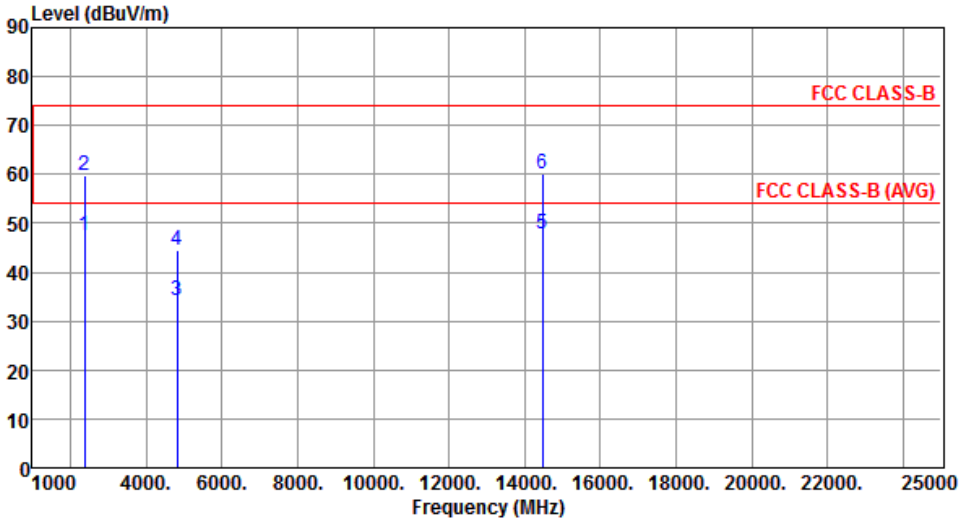

	Freq. MHz	Emission level dBuV/m	Limit dBuV/m	Margin dB	SA reading dBuV	Factor dB	Remark	ANT High cm	Turn Table deg
1	2390.00	47.43	54.00	-6.57	48.79	-1.36	Average	216	251
2	2390.00	59.93	74.00	-14.07	61.29	-1.36	Peak	216	251
3	4824.00	34.20	54.00	-19.80	28.26	5.94	Average	309	217
4	4824.00	44.60	74.00	-29.40	38.66	5.94	Peak	309	217
5	14472.00	47.67	54.00	-6.33	28.26	19.41	Average	279	210
6	14472.00	60.10	74.00	-13.90	40.69	19.41	Peak	279	210

Note 1: Emission Level (dBuV/m) = SA Reading (dBuV/m) + Factor\* (dB)  
\*Factor includes antenna factor , cable loss and amplifier gain  
Note 2: Margin (dB) = Emission level (dBuV/m) – Limit (dBuV/m).

<b>Modulation</b>	HT20	<b>Test Freq. (MHz)</b>	2412
<b>Polarization</b>	Vertical	<b>Test Configuration</b>	1

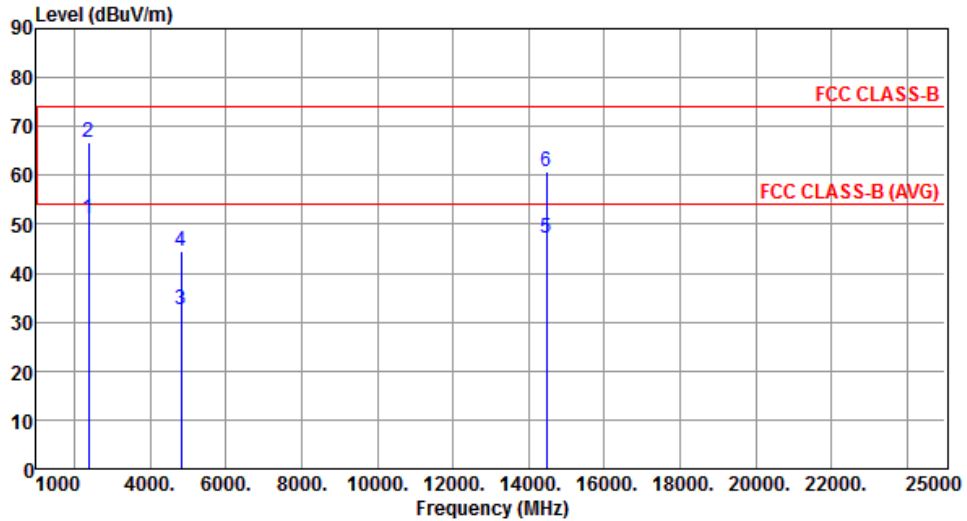

	Freq. MHz	Emission level dBuV/m	Limit dBuV/m	Margin dB	SA reading dBuV	Factor dB	Remark	ANT High cm	Turn Table deg
1	2390.00	51.19	54.00	-2.81	52.55	-1.36	Average	208	312
2	2390.00	66.89	74.00	-7.11	68.25	-1.36	Peak	208	312
3	4824.00	32.58	54.00	-21.42	26.64	5.94	Average	290	261
4	4824.00	44.44	74.00	-29.56	38.50	5.94	Peak	290	261
5	14472.00	47.10	54.00	-6.90	27.69	19.41	Average	197	67
6	14472.00	60.77	74.00	-13.23	41.36	19.41	Peak	197	67

Note 1: Emission Level (dBuV/m) = SA Reading (dBuV/m) + Factor\* (dB)

\*Factor includes antenna factor , cable loss and amplifier gain

Note 2: Margin (dB) = Emission level (dBuV/m) – Limit (dBuV/m).

<b>Modulation</b>	HT20	<b>Test Freq. (MHz)</b>	2437
<b>Polarization</b>	Horizontal	<b>Test Configuration</b>	1

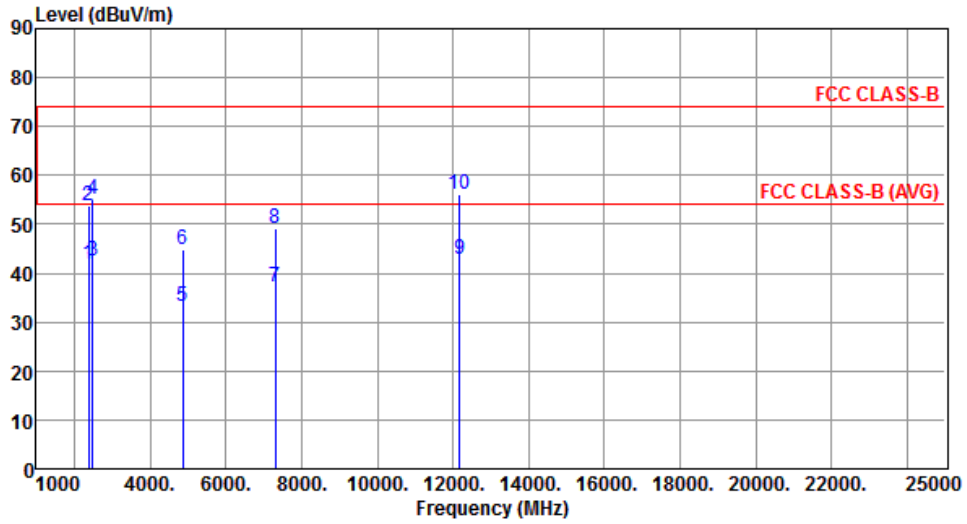

	Freq. MHz	Emission level dBuV/m	Limit dBuV/m	Margin dB	SA reading dBuV	Factor dB	Remark	ANT High cm	Turn Table deg
1	2390.00	41.89	54.00	-12.11	43.25	-1.36	Average	213	252
2	2390.00	53.89	74.00	-20.11	55.25	-1.36	Peak	213	252
3	2483.50	42.50	54.00	-11.50	43.52	-1.02	Average	213	252
4	2483.50	55.23	74.00	-18.77	56.25	-1.02	Peak	213	252
5	4874.00	33.27	54.00	-20.73	27.30	5.97	Average	325	118
6	4874.00	44.95	74.00	-29.05	38.98	5.97	Peak	325	118
7	7311.00	37.34	54.00	-16.66	26.59	10.75	Average	325	118
8	7311.00	49.04	74.00	-24.96	38.29	10.75	Peak	325	118
9	12185.00	42.71	54.00	-11.29	26.87	15.84	Average	305	297
10	12185.00	56.12	74.00	-17.88	40.28	15.84	Peak	305	297

Note 1: Emission Level (dBuV/m) = SA Reading (dBuV/m) + Factor\* (dB)

\*Factor includes antenna factor , cable loss and amplifier gain

Note 2: Margin (dB) = Emission level (dBuV/m) – Limit (dBuV/m).

<b>Modulation</b>	HT20	<b>Test Freq. (MHz)</b>	2437
<b>Polarization</b>	Vertical	<b>Test Configuration</b>	1

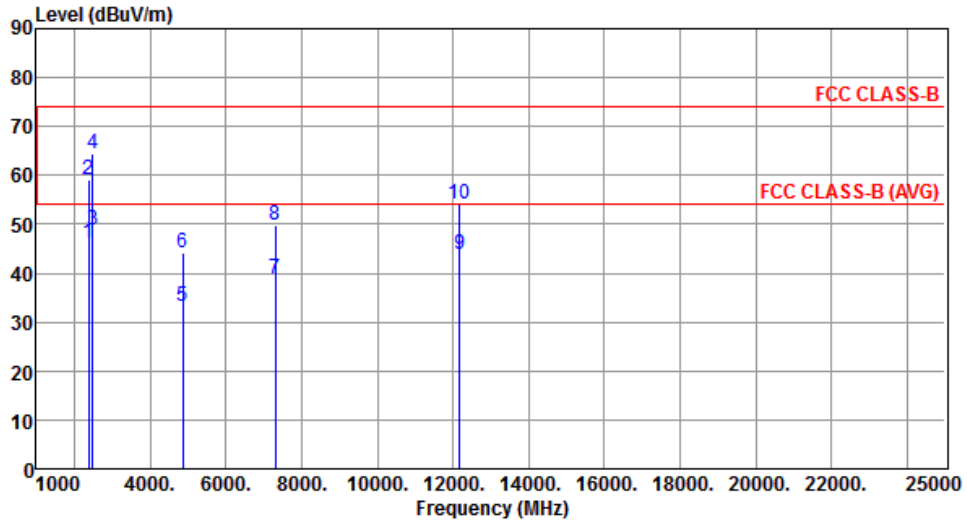

	Freq. MHz	Emission level dBuV/m	Limit dBuV/m	Margin dB	SA reading dBuV	Factor dB	Remark	ANT High cm	Turn Table deg
1	2390.00	46.13	54.00	-7.87	47.49	-1.36	Average	212	312
2	2390.00	59.08	74.00	-14.92	60.44	-1.36	Peak	212	312
3	2483.50	48.74	54.00	-5.26	49.76	-1.02	Average	212	312
4	2483.50	64.35	74.00	-9.65	65.37	-1.02	Peak	212	312
5	4874.00	33.23	54.00	-20.77	27.26	5.97	Average	169	257
6	4874.00	44.26	74.00	-29.74	38.29	5.97	Peak	169	257
7	7311.00	38.73	54.00	-15.27	27.98	10.75	Average	257	48
8	7311.00	49.66	74.00	-24.34	38.91	10.75	Peak	257	48
9	12185.00	43.92	54.00	-10.08	28.08	15.84	Average	195	200
10	12185.00	53.97	74.00	-20.03	38.13	15.84	Peak	195	200

Note 1: Emission Level (dBuV/m) = SA Reading (dBuV/m) + Factor\* (dB)

\*Factor includes antenna factor , cable loss and amplifier gain

Note 2: Margin (dB) = Emission level (dBuV/m) – Limit (dBuV/m).



<b>Modulation</b>	HT20	<b>Test Freq. (MHz)</b>	2462
<b>Polarization</b>	Horizontal	<b>Test Configuration</b>	1

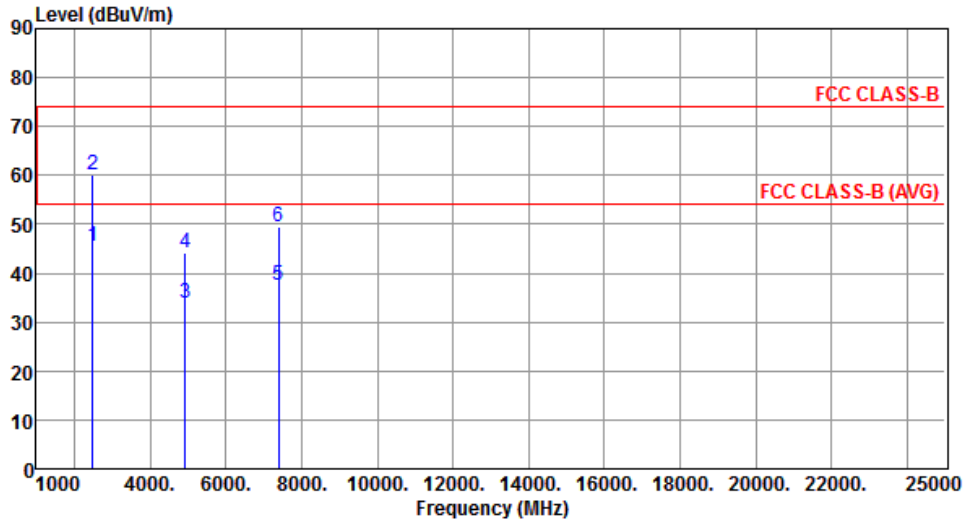

	Freq. MHz	Emission level dBuV/m	Limit dBuV/m	Margin dB	SA reading dBuV	Factor dB	Remark	ANT High cm	Turn Table deg
1	2483.50	45.50	54.00	-8.50	46.52	-1.02	Average	212	250
2	2483.50	59.96	74.00	-14.04	60.98	-1.02	Peak	212	250
3	4924.00	34.00	54.00	-20.00	27.99	6.01	Average	301	274
4	4924.00	44.27	74.00	-29.73	38.26	6.01	Peak	301	274
5	7386.00	37.62	54.00	-16.38	26.72	10.90	Average	301	274
6	7386.00	49.62	74.00	-24.38	38.72	10.90	Peak	301	274

Note 1: Emission Level (dBuV/m) = SA Reading (dBuV/m) + Factor\* (dB)

\*Factor includes antenna factor , cable loss and amplifier gain

Note 2: Margin (dB) = Emission level (dBuV/m) – Limit (dBuV/m).

<b>Modulation</b>	HT20	<b>Test Freq. (MHz)</b>	2462
<b>Polarization</b>	Vertical	<b>Test Configuration</b>	1

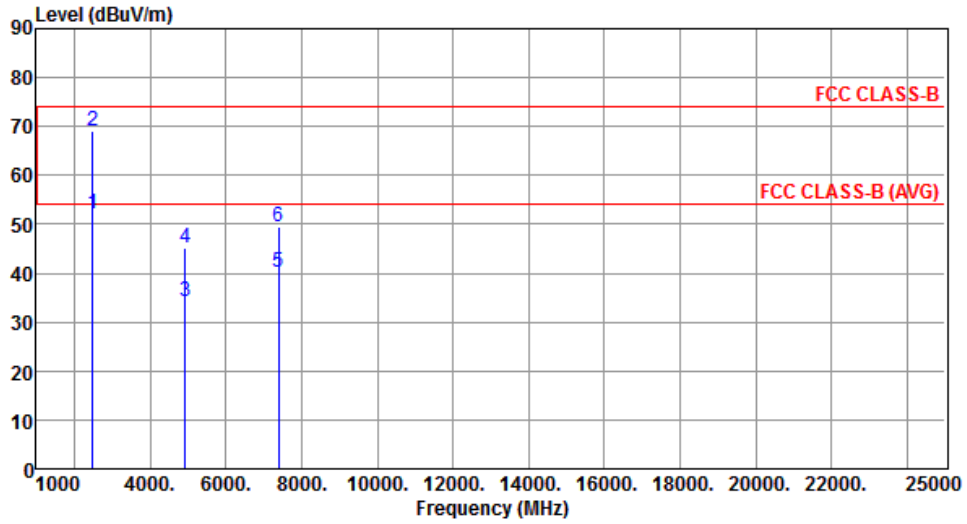

	Freq. MHz	Emission level dBuV/m	Limit dBuV/m	Margin dB	SA reading dBuV	Factor dB	Remark	ANT High cm	Turn Table deg
1	2483.50	52.30	54.00	-1.70	53.32	-1.02	Average	211	304
2	2483.50	69.10	74.00	-4.90	70.12	-1.02	Peak	211	304
3	4924.00	34.30	54.00	-19.70	28.29	6.01	Average	261	271
4	4924.00	45.21	74.00	-28.79	39.20	6.01	Peak	261	271
5	7386.00	40.19	54.00	-13.81	29.29	10.90	Average	344	105
6	7386.00	49.60	74.00	-24.40	38.70	10.90	Peak	344	105

Note 1: Emission Level (dBuV/m) = SA Reading (dBuV/m) + Factor\* (dB)

\*Factor includes antenna factor , cable loss and amplifier gain

Note 2: Margin (dB) = Emission level (dBuV/m) – Limit (dBuV/m).

## Test Configuration 2: PCB Dipole antenna

### 3.5.8 Transmitter Radiated Unwanted Emissions (Below 1GHz)

<b>Modulation</b>	11g	<b>Test Freq. (MHz)</b>	2437
<b>Polarization</b>	Horizontal	<b>Test Configuration</b>	2

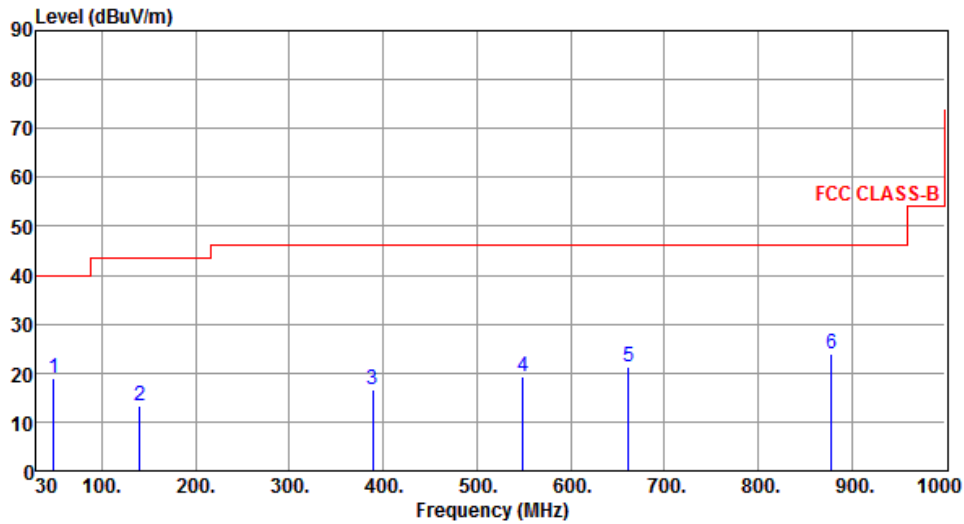

	Freq. MHz	Emission level dBuV/m	Limit dBuV/m	Margin dB	SA reading dBuV	Factor dB	Remark	ANT High cm	Turn Table deg
1	48.43	18.91	40.00	-21.09	31.82	-12.91	Peak	---	---
2	140.58	13.34	43.50	-30.16	27.07	-13.73	Peak	---	---
3	388.90	16.44	46.00	-29.56	26.79	-10.35	Peak	---	---
4	548.95	19.14	46.00	-26.86	26.26	-7.12	Peak	---	---
5	661.47	21.22	46.00	-24.78	26.13	-4.91	Peak	---	---
6	878.75	23.80	46.00	-22.20	24.98	-1.18	Peak	---	---

Note 1: Emission Level (dBuV/m) = SA Reading (dBuV/m) + Factor\* (dB)

\*Factor includes antenna factor , cable loss and amplifier gain

Note 2: Margin (dB) = Emission level (dBuV/m) – Limit (dBuV/m).

Note 3: All spurious emissions below 30MHz are more than 20 dB below the limit.

<b>Modulation</b>	11g	<b>Test Freq. (MHz)</b>	2437
<b>Polarization</b>	Vertical	<b>Test Configuration</b>	2

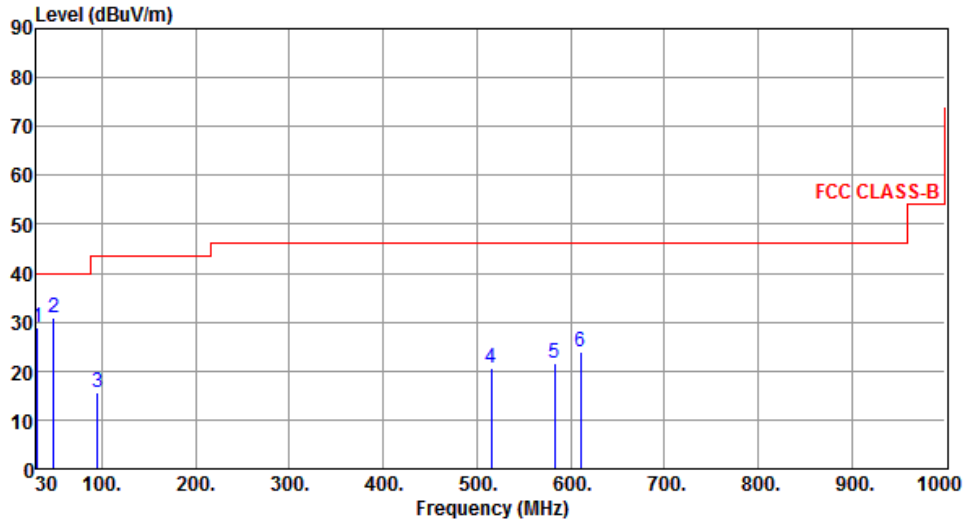

	Freq. MHz	Emission level dBuV/m	Limit dBuV/m	Margin dB	SA reading dBuV	Factor dB	Remark	ANT High cm	Turn Table deg
1	30.97	28.76	40.00	-11.24	42.27	-13.51	Peak	---	---
2	48.43	30.76	40.00	-9.24	43.67	-12.91	Peak	---	---
3	94.99	15.58	43.50	-27.92	34.58	-19.00	Peak	---	---
4	515.00	20.53	46.00	-25.47	28.01	-7.48	Peak	---	---
5	582.90	21.72	46.00	-24.28	27.97	-6.25	Peak	---	---
6	611.03	23.80	46.00	-22.20	29.43	-5.63	Peak	---	---

Note 1: Emission Level (dBuV/m) = SA Reading (dBuV/m) + Factor\* (dB)

\*Factor includes antenna factor , cable loss and amplifier gain

Note 2: Margin (dB) = Emission level (dBuV/m) – Limit (dBuV/m).

Note 3: All spurious emissions below 30MHz are more than 20 dB below the limit.

### 3.5.9 Transmitter Radiated Unwanted Emissions (Above 1GHz) for 11b

Modulation	11b	Test Freq. (MHz)	2412
Polarization	Horizontal	Test Configuration	2

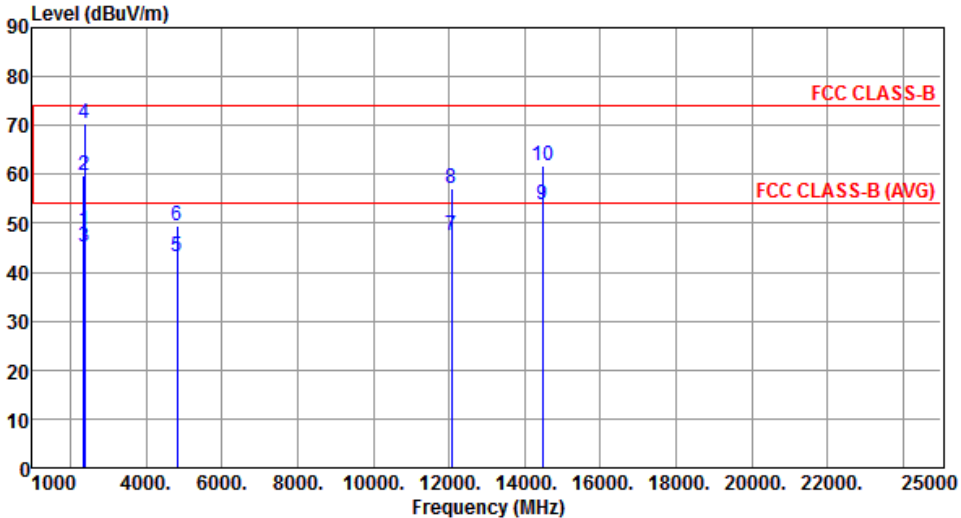

The graph plots Level (dBUV/m) on the y-axis (0 to 90) against Frequency (MHz) on the x-axis (1000 to 25000). Two horizontal red lines represent FCC CLASS-B (at ~75 dBUV/m) and FCC CLASS-B (AVG) (at ~55 dBUV/m). Ten vertical blue lines represent individual test points, each labeled with a number from 1 to 10. The peak levels for points 2, 4, 6, 8, and 10 exceed the FCC CLASS-B limit, while points 1, 3, 5, 7, and 9 are below it.

	Freq.	Emission level	Limit	Margin	SA reading	Factor	Remark	ANT High	Turn Table
	MHz	dBUV/m	dBUV/m	dB	dBuV	dB		cm	deg
1	2360.00	48.55	54.00	-5.45	50.05	-1.50	Average	268	43
2	2360.00	59.94	74.00	-14.06	61.44	-1.50	Peak	268	43
3	2390.00	45.08	54.00	-8.92	46.44	-1.36	Average	268	43
4	2390.00	70.53	74.00	-3.47	71.89	-1.36	Peak	268	43
5	4824.00	43.20	54.00	-10.80	37.26	5.94	Average	106	106
6	4824.00	49.59	74.00	-24.41	43.65	5.94	Peak	106	106
7	12060.00	47.59	54.00	-6.41	31.62	15.97	Average	378	72
8	12060.00	56.99	74.00	-17.01	41.02	15.97	Peak	378	72
9	14472.00	53.85	54.00	-0.15	34.44	19.41	Average	163	61
10	14472.00	61.94	74.00	-12.06	42.53	19.41	Peak	163	61

Note 1: Emission Level (dBUV/m) = SA Reading (dBUV/m) + Factor\* (dB)  
 \*Factor includes antenna factor , cable loss and amplifier gain  
 Note 2: Margin (dB) = Emission level (dBUV/m) – Limit (dBUV/m).

<b>Modulation</b>	11b	<b>Test Freq. (MHz)</b>	2412
<b>Polarization</b>	Vertical	<b>Test Configuration</b>	2

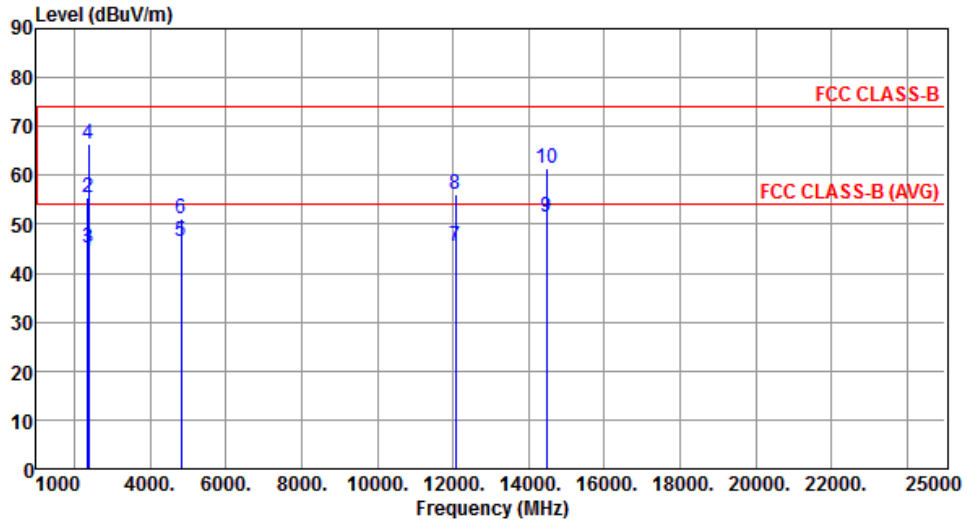

	Freq. MHz	Emission level dBuV/m	Limit dBuV/m	Margin dB	SA reading dBuV	Factor dB	Remark	ANT High cm	Turn Table deg
1	2360.00	44.67	54.00	-9.33	46.17	-1.50	Average	267	290
2	2360.00	55.58	74.00	-18.42	57.08	-1.50	Peak	267	290
3	2390.00	45.31	54.00	-8.69	46.67	-1.36	Average	267	290
4	2390.00	66.59	74.00	-7.41	67.95	-1.36	Peak	267	290
5	4824.00	46.59	54.00	-7.41	40.65	5.94	Average	125	92
6	4824.00	51.04	74.00	-22.96	45.10	5.94	Peak	125	92
7	12060.00	45.42	54.00	-8.58	29.45	15.97	Average	100	126
8	12060.00	56.22	74.00	-17.78	40.25	15.97	Peak	100	126
9	14472.00	51.60	54.00	-2.40	32.19	19.41	Average	386	80
10	14472.00	61.36	74.00	-12.64	41.95	19.41	Peak	386	80

Note 1: Emission Level (dBuV/m) = SA Reading (dBuV/m) + Factor\* (dB)

\*Factor includes antenna factor , cable loss and amplifier gain

Note 2: Margin (dB) = Emission level (dBuV/m) – Limit (dBuV/m).

<b>Modulation</b>	11b	<b>Test Freq. (MHz)</b>	2437
<b>Polarization</b>	Horizontal	<b>Test Configuration</b>	2

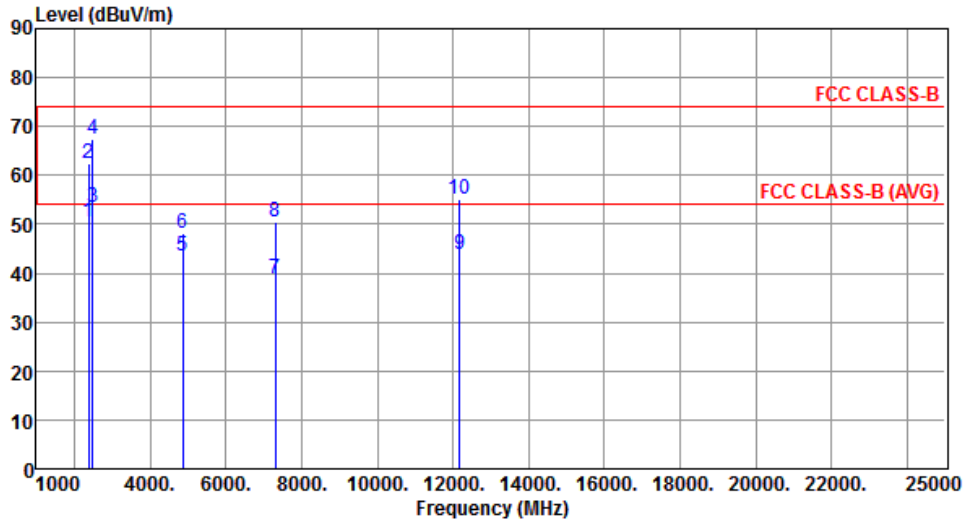

	Freq. MHz	Emission level dBuV/m	Limit dBuV/m	Margin dB	SA reading dBuV	Factor dB	Remark	ANT High cm	Turn Table deg
1	2385.00	50.34	54.00	-3.66	51.73	-1.39	Average	237	126
2	2385.00	62.51	74.00	-11.49	63.90	-1.39	Peak	237	126
3	2489.00	53.55	54.00	-0.45	54.56	-1.01	Average	236	123
4	2489.00	67.55	74.00	-6.45	68.56	-1.01	Peak	236	123
5	4874.00	43.39	54.00	-10.61	37.42	5.97	Average	158	187
6	4874.00	48.02	74.00	-25.98	42.05	5.97	Peak	158	187
7	7311.00	38.85	54.00	-15.15	28.10	10.75	Average	160	196
8	7311.00	50.37	74.00	-23.63	39.62	10.75	Peak	160	196
9	12185.00	43.77	54.00	-10.23	27.93	15.84	Average	164	204
10	12185.00	55.20	74.00	-18.80	39.36	15.84	Peak	164	204

Note 1: Emission Level (dBuV/m) = SA Reading (dBuV/m) + Factor\* (dB)

\*Factor includes antenna factor , cable loss and amplifier gain

Note 2: Margin (dB) = Emission level (dBuV/m) – Limit (dBuV/m).

<b>Modulation</b>	11b	<b>Test Freq. (MHz)</b>	2437
<b>Polarization</b>	Vertical	<b>Test Configuration</b>	2

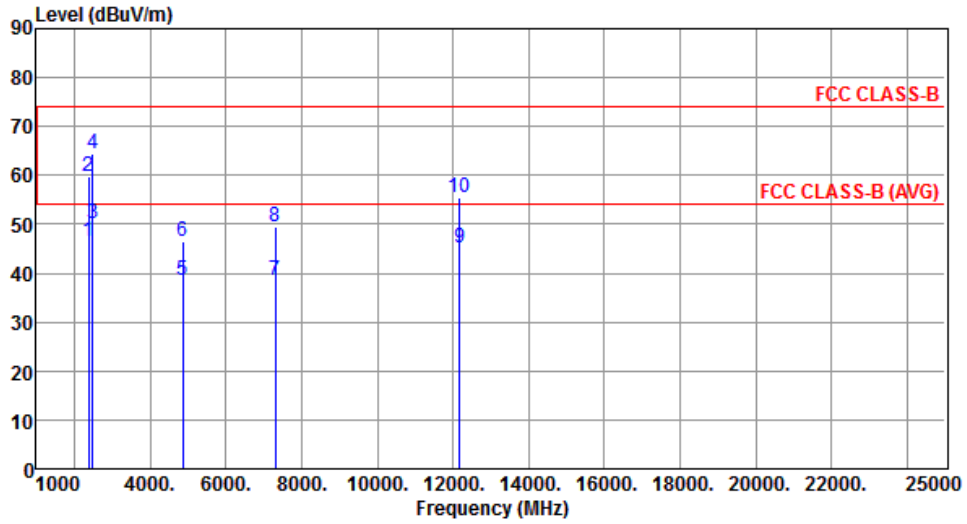

	Freq. MHz	Emission level dBuV/m	Limit dBuV/m	Margin dB	SA reading dBuV	Factor dB	Remark	ANT High cm	Turn Table deg
1	2385.00	46.45	54.00	-7.55	47.84	-1.39	Average	296	295
2	2385.00	59.64	74.00	-14.36	61.03	-1.39	Peak	296	295
3	2489.00	50.29	54.00	-3.71	51.30	-1.01	Average	332	288
4	2489.00	64.45	74.00	-9.55	65.46	-1.01	Peak	332	288
5	4874.00	38.43	54.00	-15.57	32.46	5.97	Average	234	265
6	4874.00	46.35	74.00	-27.65	40.38	5.97	Peak	234	265
7	7311.00	38.37	54.00	-15.63	27.62	10.75	Average	277	234
8	7311.00	49.62	74.00	-24.38	38.87	10.75	Peak	277	234
9	12185.00	45.01	54.00	-8.99	29.17	15.84	Average	175	208
10	12185.00	55.57	74.00	-18.43	39.73	15.84	Peak	175	208

Note 1: Emission Level (dBuV/m) = SA Reading (dBuV/m) + Factor\* (dB)

\*Factor includes antenna factor , cable loss and amplifier gain

Note 2: Margin (dB) = Emission level (dBuV/m) – Limit (dBuV/m).



<b>Modulation</b>	11b	<b>Test Freq. (MHz)</b>	2462
<b>Polarization</b>	Horizontal	<b>Test Configuration</b>	2

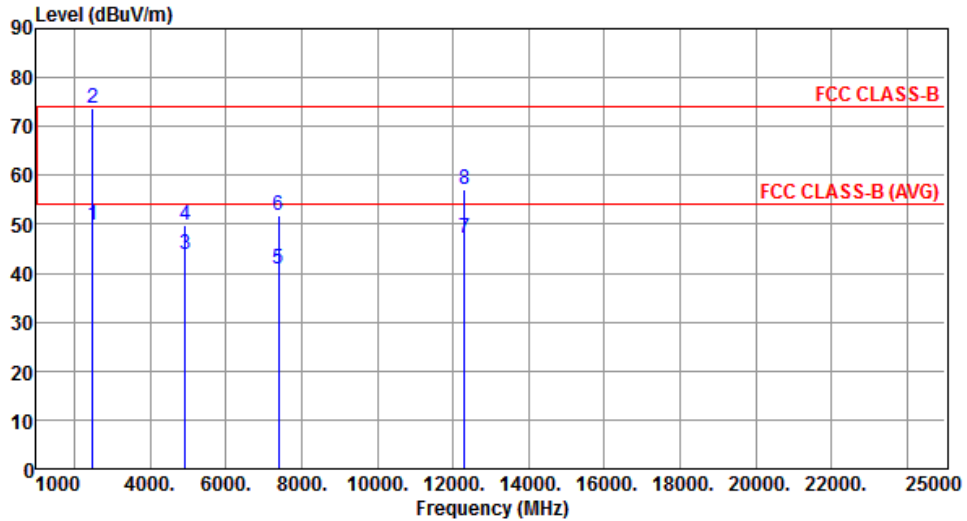

	Freq. MHz	Emission level dBuV/m	Limit dBuV/m	Margin dB	SA reading dBuV	Factor dB	Remark	ANT High cm	Turn Table deg
1	2483.50	49.80	54.00	-4.20	50.82	-1.02	Average	182	35
2	2483.50	73.85	74.00	-0.15	74.87	-1.02	Peak	182	35
3	4924.00	43.74	54.00	-10.26	37.73	6.01	Average	283	79
4	4924.00	49.67	74.00	-24.33	43.66	6.01	Peak	283	79
5	7386.00	40.77	54.00	-13.23	29.87	10.90	Average	350	81
6	7386.00	51.76	74.00	-22.24	40.86	10.90	Peak	350	81
7	12310.00	47.23	54.00	-6.77	31.53	15.70	Average	305	82
8	12310.00	57.13	74.00	-16.87	41.43	15.70	Peak	305	82

Note 1: Emission Level (dBuV/m) = SA Reading (dBuV/m) + Factor\* (dB)

\*Factor includes antenna factor , cable loss and amplifier gain

Note 2: Margin (dB) = Emission level (dBuV/m) – Limit (dBuV/m).

<b>Modulation</b>	11b	<b>Test Freq. (MHz)</b>	2462
<b>Polarization</b>	Vertical	<b>Test Configuration</b>	2

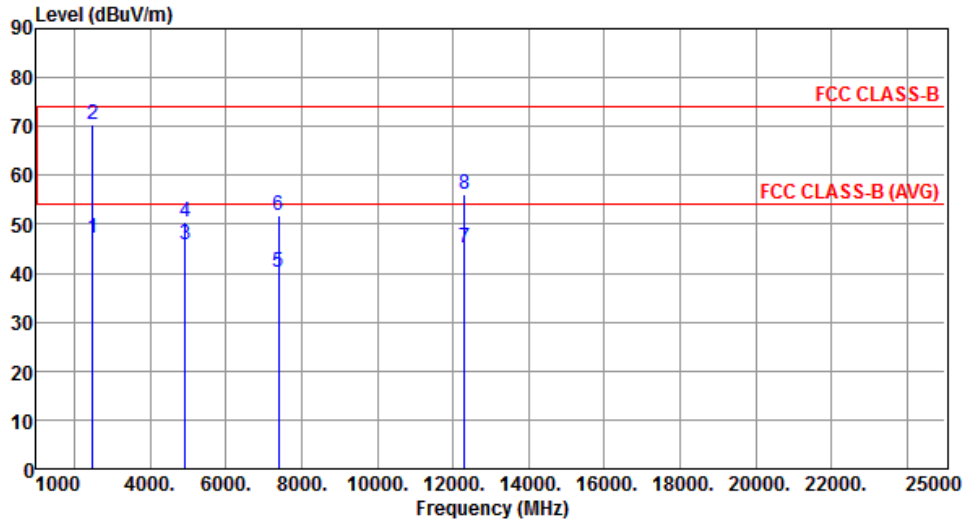

	Freq. MHz	Emission level dBuV/m	Limit dBuV/m	Margin dB	SA reading dBuV	Factor dB	Remark	ANT High cm	Turn Table deg
1	2483.50	47.14	54.00	-6.86	48.16	-1.02	Average	288	271
2	2483.50	70.31	74.00	-3.69	71.33	-1.02	Peak	288	271
3	4924.00	45.77	54.00	-8.23	39.76	6.01	Average	215	118
4	4924.00	50.63	74.00	-23.37	44.62	6.01	Peak	215	118
5	7386.00	40.32	54.00	-13.68	29.42	10.90	Average	261	116
6	7386.00	51.93	74.00	-22.07	41.03	10.90	Peak	261	116
7	12310.00	45.15	54.00	-8.85	29.45	15.70	Average	106	119
8	12310.00	56.02	74.00	-17.98	40.32	15.70	Peak	106	119

Note 1: Emission Level (dBuV/m) = SA Reading (dBuV/m) + Factor\* (dB)

\*Factor includes antenna factor , cable loss and amplifier gain

Note 2: Margin (dB) = Emission level (dBuV/m) – Limit (dBuV/m).

### 3.5.10 Transmitter Radiated Unwanted Emissions (Above 1GHz) for 11g

Modulation	11g	Test Freq. (MHz)	2412																																																																																											
Polarization	Horizontal	Test Configuration	2																																																																																											
	<table border="1"> <thead> <tr> <th></th> <th>Freq.</th> <th>Emission</th> <th>Limit</th> <th>Margin</th> <th>SA</th> <th>Factor</th> <th>Remark</th> <th>ANT</th> <th>Turn</th> </tr> <tr> <th></th> <th>MHz</th> <th>level</th> <th>dBuV/m</th> <th>dB</th> <th>reading</th> <th>dB</th> <th></th> <th>High</th> <th>Table</th> </tr> <tr> <th></th> <th></th> <th>dBuV/m</th> <th></th> <th></th> <th>dBuV</th> <th></th> <th></th> <th>cm</th> <th>deg</th> </tr> </thead> <tbody> <tr> <td>1</td> <td>2390.00</td> <td>52.77</td> <td>54.00</td> <td>-1.23</td> <td>54.13</td> <td>-1.36</td> <td>Average</td> <td>400</td> <td>188</td> </tr> <tr> <td>2</td> <td>2390.00</td> <td>68.60</td> <td>74.00</td> <td>-5.40</td> <td>69.96</td> <td>-1.36</td> <td>Peak</td> <td>400</td> <td>188</td> </tr> <tr> <td>3</td> <td>4824.00</td> <td>32.87</td> <td>54.00</td> <td>-21.13</td> <td>26.93</td> <td>5.94</td> <td>Average</td> <td>320</td> <td>209</td> </tr> <tr> <td>4</td> <td>4824.00</td> <td>44.34</td> <td>74.00</td> <td>-29.66</td> <td>38.40</td> <td>5.94</td> <td>Peak</td> <td>320</td> <td>209</td> </tr> <tr> <td>5</td> <td>14472.00</td> <td>48.83</td> <td>54.00</td> <td>-5.17</td> <td>29.42</td> <td>19.41</td> <td>Average</td> <td>325</td> <td>154</td> </tr> <tr> <td>6</td> <td>14472.00</td> <td>60.08</td> <td>74.00</td> <td>-13.92</td> <td>40.67</td> <td>19.41</td> <td>Peak</td> <td>325</td> <td>154</td> </tr> </tbody> </table>		Freq.	Emission	Limit	Margin	SA	Factor	Remark	ANT	Turn		MHz	level	dBuV/m	dB	reading	dB		High	Table			dBuV/m			dBuV			cm	deg	1	2390.00	52.77	54.00	-1.23	54.13	-1.36	Average	400	188	2	2390.00	68.60	74.00	-5.40	69.96	-1.36	Peak	400	188	3	4824.00	32.87	54.00	-21.13	26.93	5.94	Average	320	209	4	4824.00	44.34	74.00	-29.66	38.40	5.94	Peak	320	209	5	14472.00	48.83	54.00	-5.17	29.42	19.41	Average	325	154	6	14472.00	60.08	74.00	-13.92	40.67	19.41	Peak	325	154			
	Freq.	Emission	Limit	Margin	SA	Factor	Remark	ANT	Turn																																																																																					
	MHz	level	dBuV/m	dB	reading	dB		High	Table																																																																																					
		dBuV/m			dBuV			cm	deg																																																																																					
1	2390.00	52.77	54.00	-1.23	54.13	-1.36	Average	400	188																																																																																					
2	2390.00	68.60	74.00	-5.40	69.96	-1.36	Peak	400	188																																																																																					
3	4824.00	32.87	54.00	-21.13	26.93	5.94	Average	320	209																																																																																					
4	4824.00	44.34	74.00	-29.66	38.40	5.94	Peak	320	209																																																																																					
5	14472.00	48.83	54.00	-5.17	29.42	19.41	Average	325	154																																																																																					
6	14472.00	60.08	74.00	-13.92	40.67	19.41	Peak	325	154																																																																																					
<p>Note 1: Emission Level (dBuV/m) = SA Reading (dBuV/m) + Factor* (dB)            *Factor includes antenna factor , cable loss and amplifier gain            Note 2: Margin (dB) = Emission level (dBuV/m) – Limit (dBuV/m).</p>																																																																																														

<b>Modulation</b>	11g	<b>Test Freq. (MHz)</b>	2412
<b>Polarization</b>	Vertical	<b>Test Configuration</b>	2

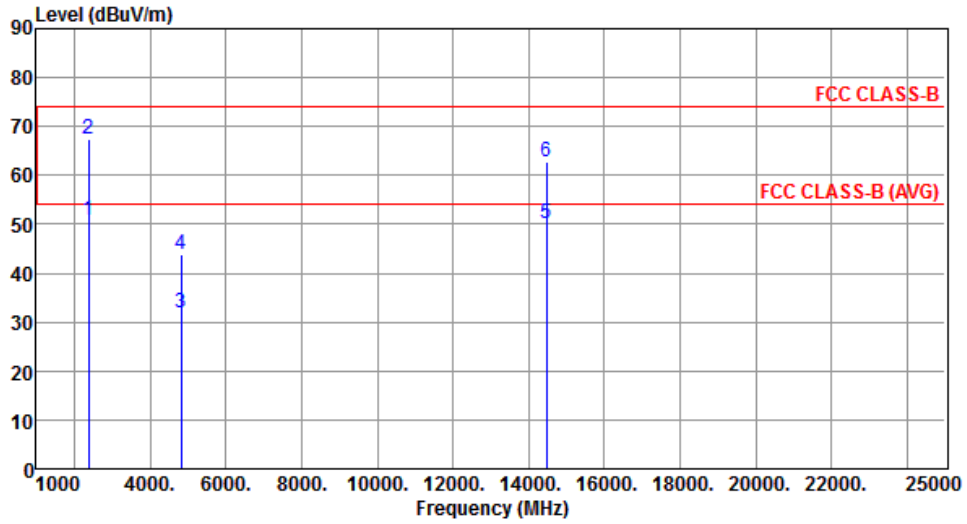

	Freq. MHz	Emission level dBuV/m	Limit dBuV/m	Margin dB	SA reading dBuV	Factor dB	Remark	ANT High cm	Turn Table deg
1	2390.00	50.88	54.00	-3.12	52.24	-1.36	Average	397	268
2	2390.00	67.44	74.00	-6.56	68.80	-1.36	Peak	397	268
3	4824.00	31.82	54.00	-22.18	25.88	5.94	Average	222	79
4	4824.00	43.96	74.00	-30.04	38.02	5.94	Peak	222	79
5	14472.00	50.03	54.00	-3.97	30.62	19.41	Average	158	132
6	14472.00	62.84	74.00	-11.16	43.43	19.41	Peak	158	132

Note 1: Emission Level (dBuV/m) = SA Reading (dBuV/m) + Factor\* (dB)

\*Factor includes antenna factor , cable loss and amplifier gain

Note 2: Margin (dB) = Emission level (dBuV/m) – Limit (dBuV/m).

<b>Modulation</b>	11g	<b>Test Freq. (MHz)</b>	2437
<b>Polarization</b>	Horizontal	<b>Test Configuration</b>	2

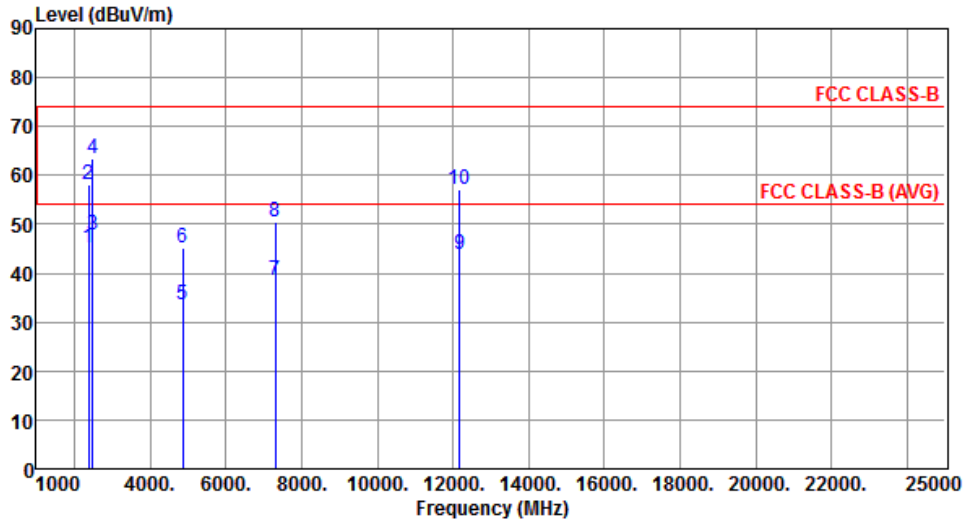

	Freq. MHz	Emission level dBuV/m	Limit dBuV/m	Margin dB	SA reading dBuV	Factor dB	Remark	ANT High cm	Turn Table deg
1	2390.00	45.24	54.00	-8.76	46.60	-1.36	Average	199	184
2	2390.00	58.26	74.00	-15.74	59.62	-1.36	Peak	199	184
3	2483.50	47.83	54.00	-6.17	48.85	-1.02	Average	199	184
4	2483.50	63.57	74.00	-10.43	64.59	-1.02	Peak	199	184
5	4874.00	33.52	54.00	-20.48	27.55	5.97	Average	327	206
6	4874.00	45.29	74.00	-28.71	39.32	5.97	Peak	327	206
7	7311.00	38.52	54.00	-15.48	27.77	10.75	Average	155	113
8	7311.00	50.63	74.00	-23.37	39.88	10.75	Peak	155	113
9	12185.00	43.70	54.00	-10.30	27.86	15.84	Average	268	39
10	12185.00	57.25	74.00	-16.75	41.41	15.84	Peak	268	39

Note 1: Emission Level (dBuV/m) = SA Reading (dBuV/m) + Factor\* (dB)

\*Factor includes antenna factor , cable loss and amplifier gain

Note 2: Margin (dB) = Emission level (dBuV/m) – Limit (dBuV/m).

<b>Modulation</b>	11g	<b>Test Freq. (MHz)</b>	2437
<b>Polarization</b>	Vertical	<b>Test Configuration</b>	2

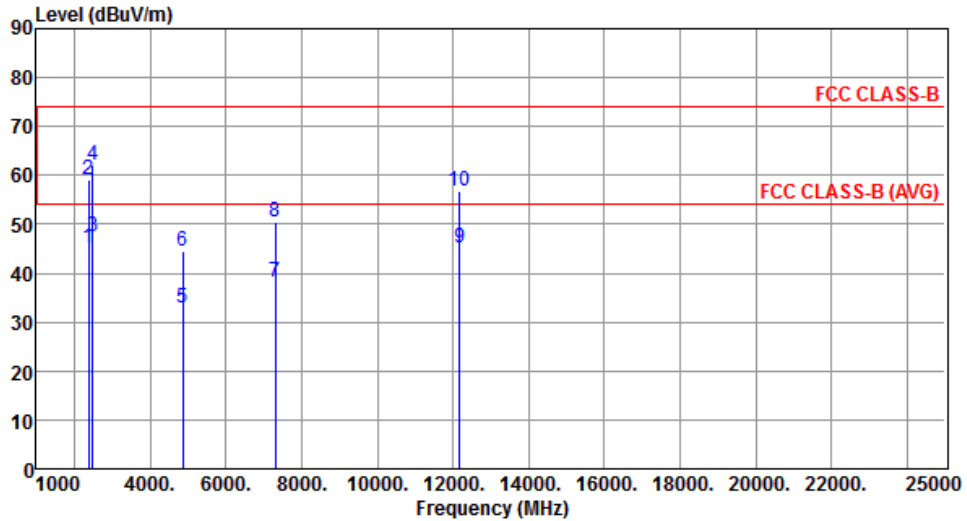

	Freq. MHz	Emission level dBuV/m	Limit dBuV/m	Margin dB	SA reading dBuV	Factor dB	Remark	ANT High cm	Turn Table deg
1	2390.00	45.23	54.00	-8.77	46.59	-1.36	Average	374	268
2	2390.00	59.03	74.00	-14.97	60.39	-1.36	Peak	374	268
3	2483.50	47.37	54.00	-6.63	48.39	-1.02	Average	374	268
4	2483.50	62.24	74.00	-11.76	63.26	-1.02	Peak	374	268
5	4874.00	32.84	54.00	-21.16	26.87	5.97	Average	229	74
6	4874.00	44.51	74.00	-29.49	38.54	5.97	Peak	229	74
7	7311.00	38.16	54.00	-15.84	27.41	10.75	Average	321	254
8	7311.00	50.52	74.00	-23.48	39.77	10.75	Peak	321	254
9	12185.00	45.23	54.00	-8.77	29.39	15.84	Average	284	143
10	12185.00	56.86	74.00	-17.14	41.02	15.84	Peak	284	143

Note 1: Emission Level (dBuV/m) = SA Reading (dBuV/m) + Factor\* (dB)

\*Factor includes antenna factor , cable loss and amplifier gain

Note 2: Margin (dB) = Emission level (dBuV/m) – Limit (dBuV/m).

<b>Modulation</b>	11g	<b>Test Freq. (MHz)</b>	2462
<b>Polarization</b>	Horizontal	<b>Test Configuration</b>	2

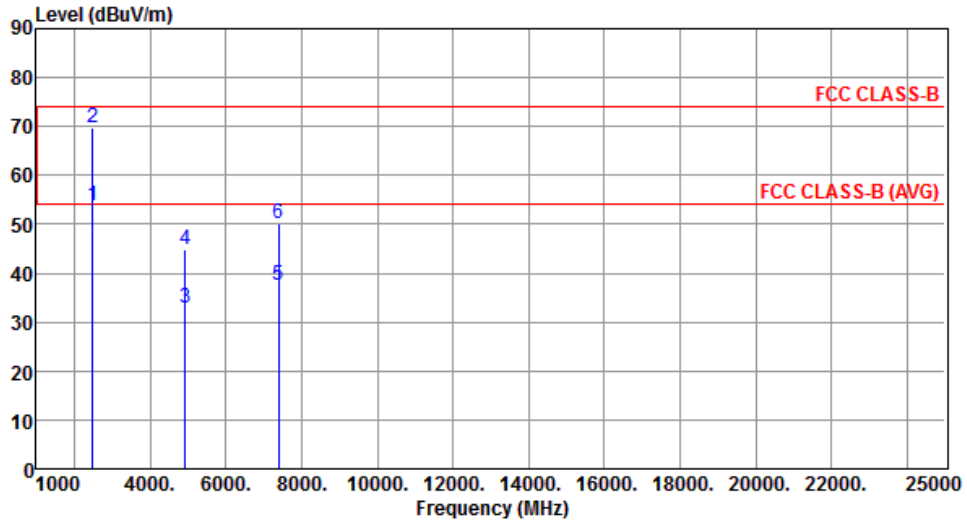

	Freq. MHz	Emission level dBuV/m	Limit dBuV/m	Margin dB	SA reading dBuV	Factor dB	Remark	ANT High cm	Turn Table deg
1	2483.50	53.84	54.00	-0.16	54.86	-1.02	Average	260	350
2	2483.50	69.85	74.00	-4.15	70.87	-1.02	Peak	260	350
3	4924.00	32.89	54.00	-21.11	26.88	6.01	Average	321	202
4	4924.00	44.78	74.00	-29.22	38.77	6.01	Peak	321	202
5	7386.00	37.63	54.00	-16.37	26.73	10.90	Average	152	110
6	7386.00	50.18	74.00	-23.82	39.28	10.90	Peak	152	110

Note 1: Emission Level (dBuV/m) = SA Reading (dBuV/m) + Factor\* (dB)

\*Factor includes antenna factor , cable loss and amplifier gain

Note 2: Margin (dB) = Emission level (dBuV/m) – Limit (dBuV/m).

<b>Modulation</b>	11g	<b>Test Freq. (MHz)</b>	2462
<b>Polarization</b>	Vertical	<b>Test Configuration</b>	2

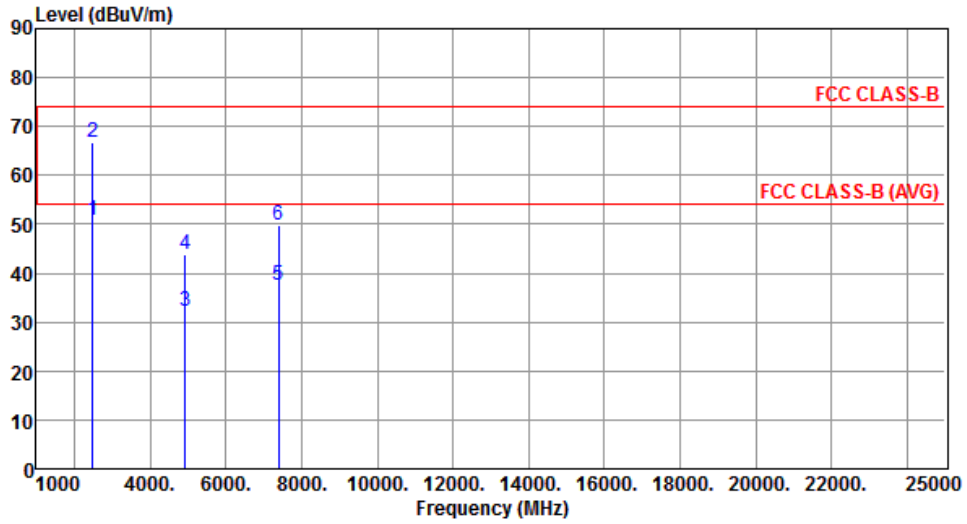

	Freq. MHz	Emission level dBuV/m	Limit dBuV/m	Margin dB	SA reading dBuV	Factor dB	Remark	ANT High cm	Turn Table deg
1	2483.50	50.92	54.00	-3.08	51.94	-1.02	Average	249	260
2	2483.50	66.63	74.00	-7.37	67.65	-1.02	Peak	249	260
3	4924.00	32.06	54.00	-21.94	26.05	6.01	Average	229	71
4	4924.00	43.82	74.00	-30.18	37.81	6.01	Peak	229	71
5	7386.00	37.54	54.00	-16.46	26.64	10.90	Average	322	254
6	7386.00	49.93	74.00	-24.07	39.03	10.90	Peak	322	254

Note 1: Emission Level (dBuV/m) = SA Reading (dBuV/m) + Factor\* (dB)

\*Factor includes antenna factor , cable loss and amplifier gain

Note 2: Margin (dB) = Emission level (dBuV/m) – Limit (dBuV/m).



### 3.5.11 Transmitter Radiated Unwanted Emissions (Above 1GHz) for HT20

Modulation	HT20	Test Freq. (MHz)	2412
Polarization	Horizontal	Test Configuration	2

  

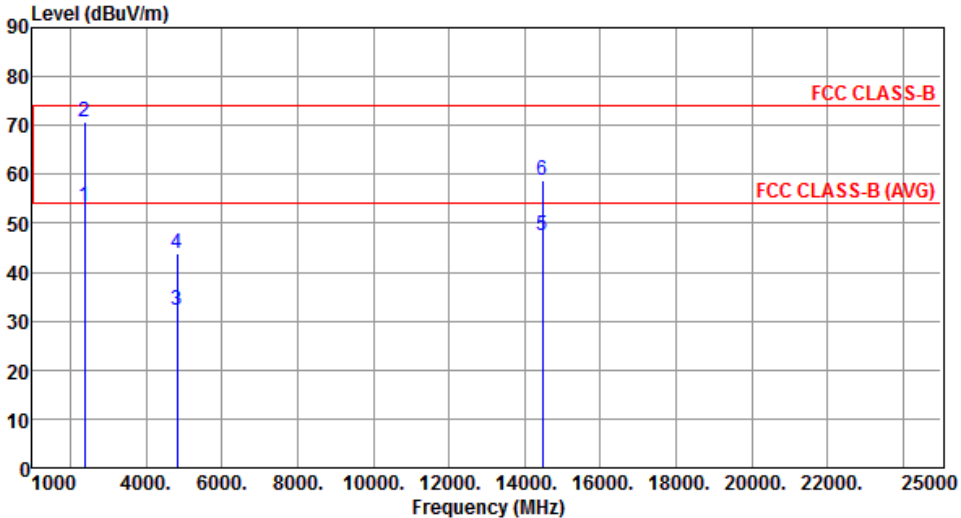

	Freq. MHz	Emission level dBuV/m	Limit dBuV/m	Margin dB	SA reading dBuV	Factor dB	Remark	ANT High cm	Turn Table deg
1	2390.00	53.33	54.00	-0.67	54.69	-1.36	Average	333	8
2	2390.00	70.73	74.00	-3.27	72.09	-1.36	Peak	333	8
3	4824.00	32.12	54.00	-21.88	26.18	5.94	Average	312	204
4	4824.00	43.93	74.00	-30.07	37.99	5.94	Peak	312	204
5	14472.00	47.58	54.00	-6.42	28.17	19.41	Average	327	162
6	14472.00	58.87	74.00	-15.13	39.46	19.41	Peak	327	162

Note 1: Emission Level (dBuV/m) = SA Reading (dBuV/m) + Factor\* (dB)  
\*Factor includes antenna factor , cable loss and amplifier gain  
Note 2: Margin (dB) = Emission level (dBuV/m) – Limit (dBuV/m).

<b>Modulation</b>	HT20	<b>Test Freq. (MHz)</b>	2412
<b>Polarization</b>	Vertical	<b>Test Configuration</b>	2

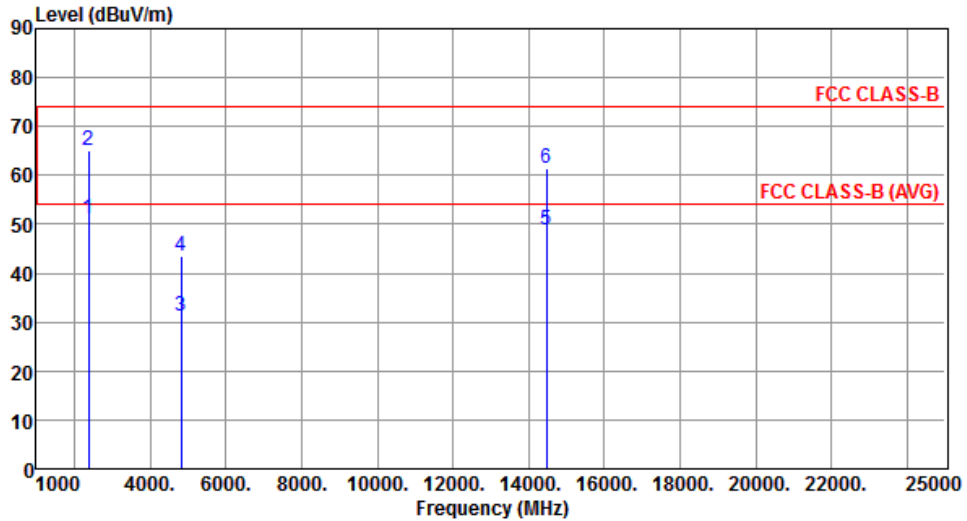

	Freq. MHz	Emission level dBuV/m	Limit dBuV/m	Margin dB	SA reading dBuV	Factor dB	Remark	ANT High cm	Turn Table deg
1	2390.00	51.18	54.00	-2.82	52.54	-1.36	Average	333	277
2	2390.00	65.09	74.00	-8.91	66.45	-1.36	Peak	333	277
3	4824.00	31.36	54.00	-22.64	25.42	5.94	Average	226	74
4	4824.00	43.34	74.00	-30.66	37.40	5.94	Peak	226	74
5	14472.00	48.92	54.00	-5.08	29.51	19.41	Average	150	137
6	14472.00	61.50	74.00	-12.50	42.09	19.41	Peak	150	137

Note 1: Emission Level (dBuV/m) = SA Reading (dBuV/m) + Factor\* (dB)

\*Factor includes antenna factor , cable loss and amplifier gain

Note 2: Margin (dB) = Emission level (dBuV/m) – Limit (dBuV/m).

<b>Modulation</b>	HT20	<b>Test Freq. (MHz)</b>	2437
<b>Polarization</b>	Horizontal	<b>Test Configuration</b>	2

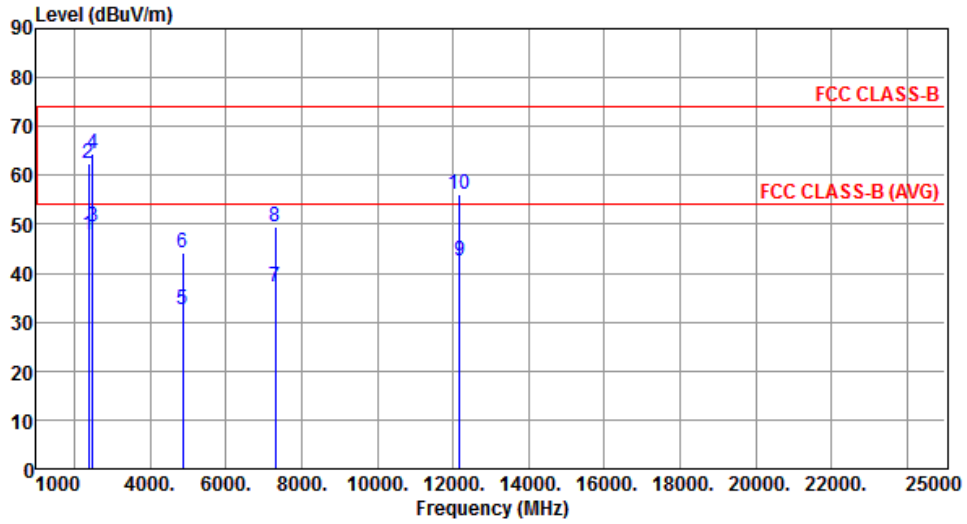

	Freq. MHz	Emission level dBuV/m	Limit dBuV/m	Margin dB	SA reading dBuV	Factor dB	Remark	ANT High cm	Turn Table deg
1	2390.00	47.97	54.00	-6.03	49.33	-1.36	Average	150	9
2	2390.00	62.42	74.00	-11.58	63.78	-1.36	Peak	150	9
3	2483.50	49.61	54.00	-4.39	50.63	-1.02	Average	150	9
4	2483.50	64.51	74.00	-9.49	65.53	-1.02	Peak	150	9
5	4874.00	32.47	54.00	-21.53	26.50	5.97	Average	323	201
6	4874.00	44.14	74.00	-29.86	38.17	5.97	Peak	323	201
7	7311.00	37.27	54.00	-16.73	26.52	10.75	Average	152	110
8	7311.00	49.42	74.00	-24.58	38.67	10.75	Peak	152	110
9	12185.00	42.57	54.00	-11.43	26.73	15.84	Average	262	31
10	12185.00	56.13	74.00	-17.87	40.29	15.84	Peak	262	31

Note 1: Emission Level (dBuV/m) = SA Reading (dBuV/m) + Factor\* (dB)

\*Factor includes antenna factor , cable loss and amplifier gain

Note 2: Margin (dB) = Emission level (dBuV/m) – Limit (dBuV/m).

<b>Modulation</b>	HT20	<b>Test Freq. (MHz)</b>	2437
<b>Polarization</b>	Vertical	<b>Test Configuration</b>	2

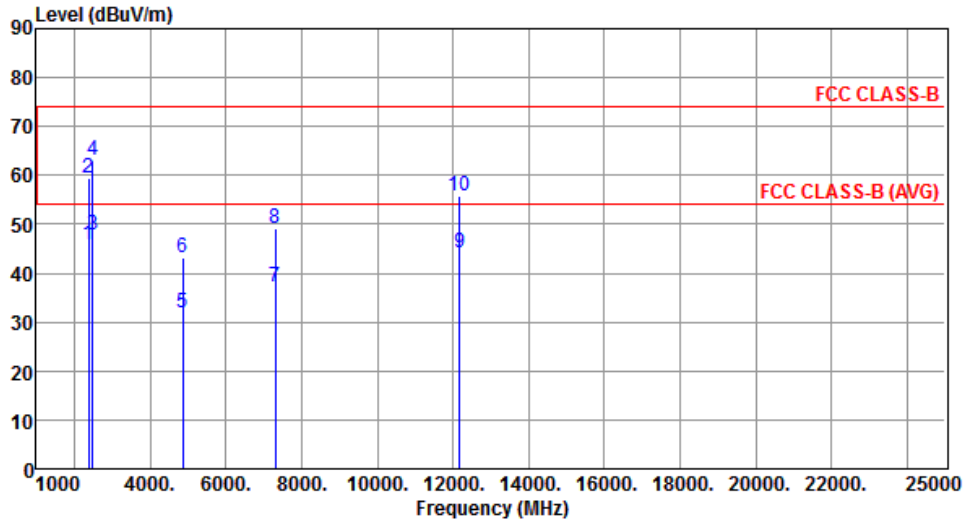

	Freq. MHz	Emission level dBuV/m	Limit dBuV/m	Margin dB	SA reading dBuV	Factor dB	Remark	ANT High cm	Turn Table deg
1	2390.00	45.68	54.00	-8.32	47.04	-1.36	Average	389	277
2	2390.00	59.55	74.00	-14.45	60.91	-1.36	Peak	389	277
3	2483.50	47.72	54.00	-6.28	48.74	-1.02	Average	389	277
4	2483.50	63.08	74.00	-10.92	64.10	-1.02	Peak	389	277
5	4874.00	31.73	54.00	-22.27	25.76	5.97	Average	221	71
6	4874.00	43.22	74.00	-30.78	37.25	5.97	Peak	221	71
7	7311.00	37.04	54.00	-16.96	26.29	10.75	Average	320	260
8	7311.00	49.20	74.00	-24.80	38.45	10.75	Peak	320	260
9	12185.00	44.05	54.00	-9.95	28.21	15.84	Average	287	151
10	12185.00	55.79	74.00	-18.21	39.95	15.84	Peak	287	151

Note 1: Emission Level (dBuV/m) = SA Reading (dBuV/m) + Factor\* (dB)

\*Factor includes antenna factor , cable loss and amplifier gain

Note 2: Margin (dB) = Emission level (dBuV/m) – Limit (dBuV/m).

<b>Modulation</b>	HT20	<b>Test Freq. (MHz)</b>	2462
<b>Polarization</b>	Horizontal	<b>Test Configuration</b>	2

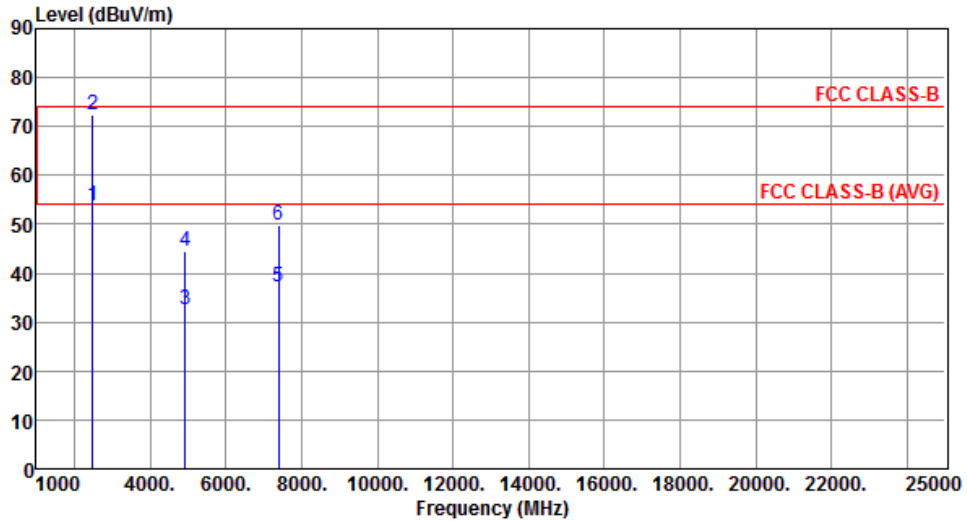

	Freq. MHz	Emission level dBuV/m	Limit dBuV/m	Margin dB	SA reading dBuV	Factor dB	Remark	ANT High cm	Turn Table deg
1	2483.50	53.89	54.00	-0.11	54.91	-1.02	Average	281	330
2	2483.50	72.25	74.00	-1.75	73.27	-1.02	Peak	281	330
3	4924.00	32.56	54.00	-21.44	26.55	6.01	Average	326	207
4	4924.00	44.43	74.00	-29.57	38.42	6.01	Peak	326	207
5	7386.00	37.35	54.00	-16.65	26.45	10.90	Average	155	113
6	7386.00	49.70	74.00	-24.30	38.80	10.90	Peak	155	113

Note 1: Emission Level (dBuV/m) = SA Reading (dBuV/m) + Factor\* (dB)

\*Factor includes antenna factor , cable loss and amplifier gain

Note 2: Margin (dB) = Emission level (dBuV/m) – Limit (dBuV/m).

<b>Modulation</b>	HT20	<b>Test Freq. (MHz)</b>	2462
<b>Polarization</b>	Vertical	<b>Test Configuration</b>	2

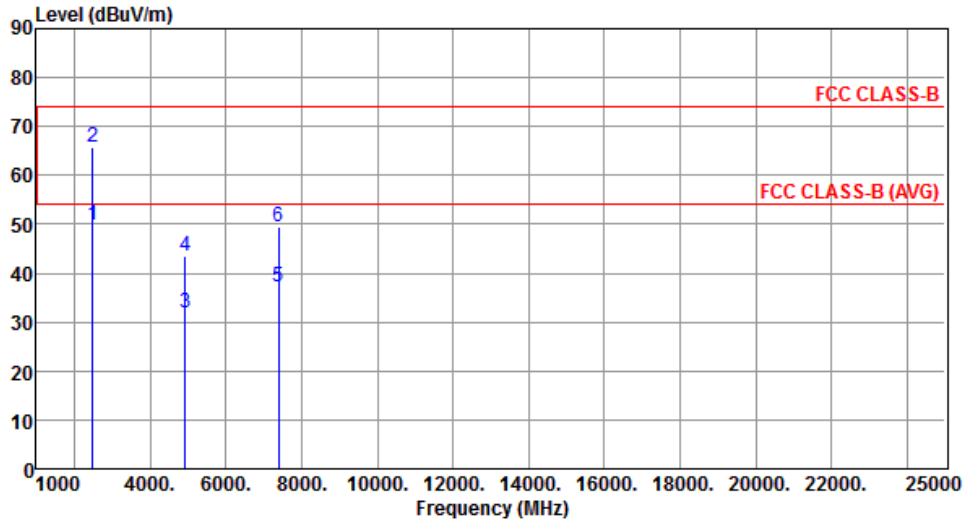

	Freq. MHz	Emission level dBuV/m	Limit dBuV/m	Margin dB	SA reading dBuV	Factor dB	Remark	ANT High cm	Turn Table deg
1	2483.50	49.81	54.00	-4.19	50.83	-1.02	Average	318	271
2	2483.50	65.67	74.00	-8.33	66.69	-1.02	Peak	318	271
3	4924.00	31.88	54.00	-22.12	25.87	6.01	Average	224	78
4	4924.00	43.51	74.00	-30.49	37.50	6.01	Peak	224	78
5	7386.00	37.15	54.00	-16.85	26.25	10.90	Average	326	263
6	7386.00	49.50	74.00	-24.50	38.60	10.90	Peak	326	263

Note 1: Emission Level (dBuV/m) = SA Reading (dBuV/m) + Factor\* (dB)

\*Factor includes antenna factor , cable loss and amplifier gain

Note 2: Margin (dB) = Emission level (dBuV/m) – Limit (dBuV/m).

### Test Configuration 3: Isolated Magnetic Dipole antenna

#### 3.5.12 Transmitter Radiated Unwanted Emissions (Below 1GHz)

<b>Modulation</b>	11g	<b>Test Freq. (MHz)</b>	2437
<b>Polarization</b>	Horizontal	<b>Test Configuration</b>	3

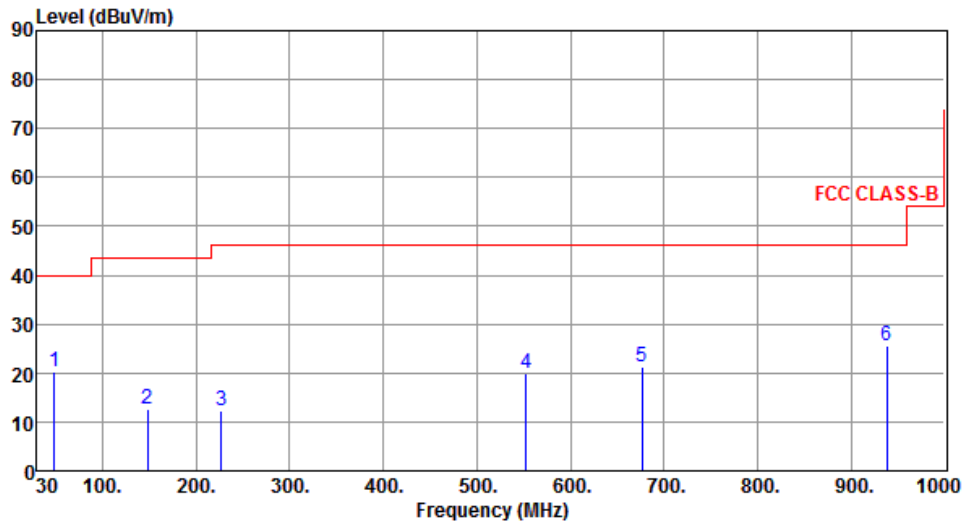

	Freq. MHz	Emission level dBuV/m	Limit dBuV/m	Margin dB	SA reading dBuV	Factor dB	Remark	ANT High cm	Turn Table deg
1	48.43	20.41	40.00	-19.59	33.32	-12.91	Peak	---	---
2	148.34	12.75	43.50	-30.75	26.23	-13.48	Peak	---	---
3	226.91	12.37	46.00	-33.63	27.93	-15.56	Peak	---	---
4	552.83	19.89	46.00	-26.11	26.92	-7.03	Peak	---	---
5	676.99	21.33	46.00	-24.67	26.04	-4.71	Peak	---	---
6	937.92	25.63	46.00	-20.37	25.67	-0.04	Peak	---	---

Note 1: Emission Level (dBuV/m) = SA Reading (dBuV/m) + Factor\* (dB)

\*Factor includes antenna factor, cable loss and amplifier gain

Note 2: Margin (dB) = Emission level (dBuV/m) – Limit (dBuV/m).

Note 3: All spurious emissions below 30MHz are more than 20 dB below the limit.

<b>Modulation</b>	11g	<b>Test Freq. (MHz)</b>	2437
<b>Polarization</b>	Vertical	<b>Test Configuration</b>	3

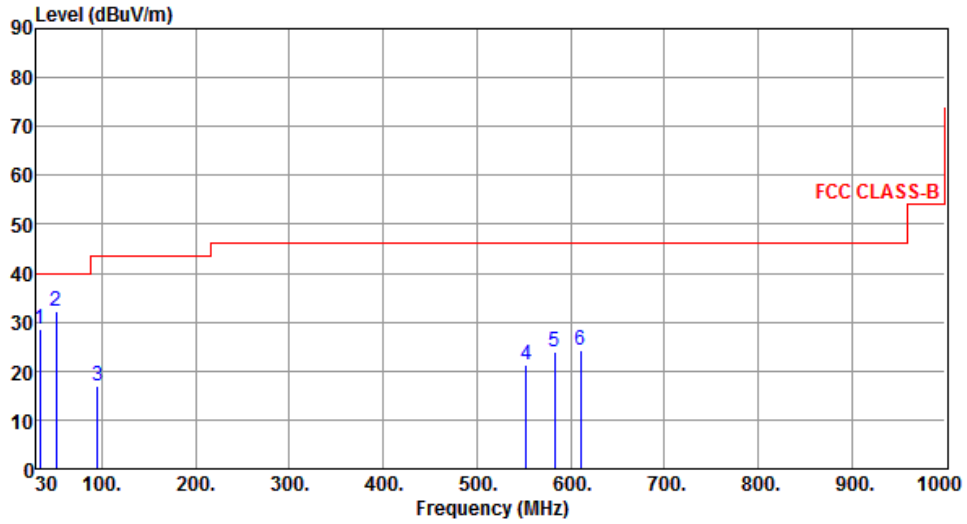

	Freq. MHz	Emission level dBuV/m	Limit dBuV/m	Margin dB	SA reading dBuV	Factor dB	Remark	ANT High cm	Turn Table deg
1	33.88	28.63	40.00	-11.37	42.12	-13.49	Peak	---	---
2	51.34	32.23	40.00	-7.77	45.36	-13.13	Peak	---	---
3	94.99	16.98	43.50	-26.52	35.98	-19.00	Peak	---	---
4	552.83	21.26	46.00	-24.74	28.29	-7.03	Peak	---	---
5	582.90	23.79	46.00	-22.21	30.04	-6.25	Peak	---	---
6	611.03	24.08	46.00	-21.92	29.71	-5.63	Peak	---	---

Note 1: Emission Level (dBuV/m) = SA Reading (dBuV/m) + Factor\* (dB)

\*Factor includes antenna factor , cable loss and amplifier gain

Note 2: Margin (dB) = Emission level (dBuV/m) – Limit (dBuV/m).

Note 3: All spurious emissions below 30MHz are more than 20 dB below the limit.



### 3.5.13 Transmitter Radiated Unwanted Emissions (Above 1GHz) for 11b

<b>Modulation</b>	11b	<b>Test Freq. (MHz)</b>	2412
<b>Polarization</b>	Horizontal	<b>Test Configuration</b>	3

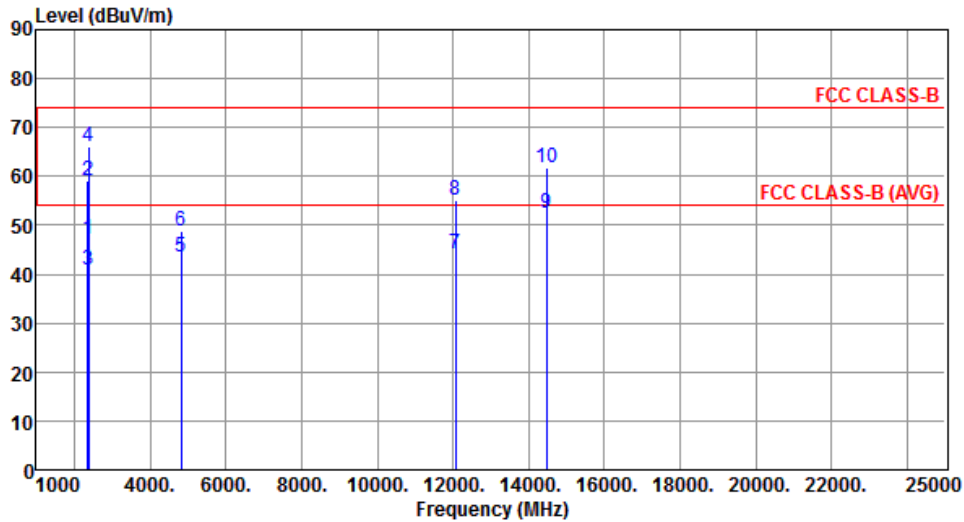

	Freq. MHz	Emission level dBUV/m	Limit dBUV/m	Margin dB	SA reading dBUV	Factor dB	Remark	ANT High cm	Turn Table deg
1	2360.00	47.16	54.00	-6.84	48.66	-1.50	Average	194	154
2	2360.00	59.11	74.00	-14.89	60.61	-1.50	Peak	194	154
3	2390.00	40.93	54.00	-13.07	42.29	-1.36	Average	295	180
4	2390.00	66.13	74.00	-7.87	67.49	-1.36	Peak	150	182
5	4824.00	43.34	54.00	-10.66	37.40	5.94	Average	150	198
6	4824.00	48.71	74.00	-25.29	42.77	5.94	Peak	150	198
7	12060.00	44.20	54.00	-9.80	28.23	15.97	Average	150	169
8	12060.00	55.26	74.00	-18.74	39.29	15.97	Peak	150	169
9	14472.00	52.60	54.00	-1.40	33.19	19.41	Average	150	187
10	14472.00	61.71	74.00	-12.29	42.30	19.41	Peak	150	187

Note 1: Emission Level (dBUV/m) = SA Reading (dBUV/m) + Factor\* (dB)

\*Factor includes antenna factor , cable loss and amplifier gain

Note 2: Margin (dB) = Emission level (dBUV/m) – Limit (dBUV/m).

<b>Modulation</b>	11b	<b>Test Freq. (MHz)</b>	2412
<b>Polarization</b>	Vertical	<b>Test Configuration</b>	3

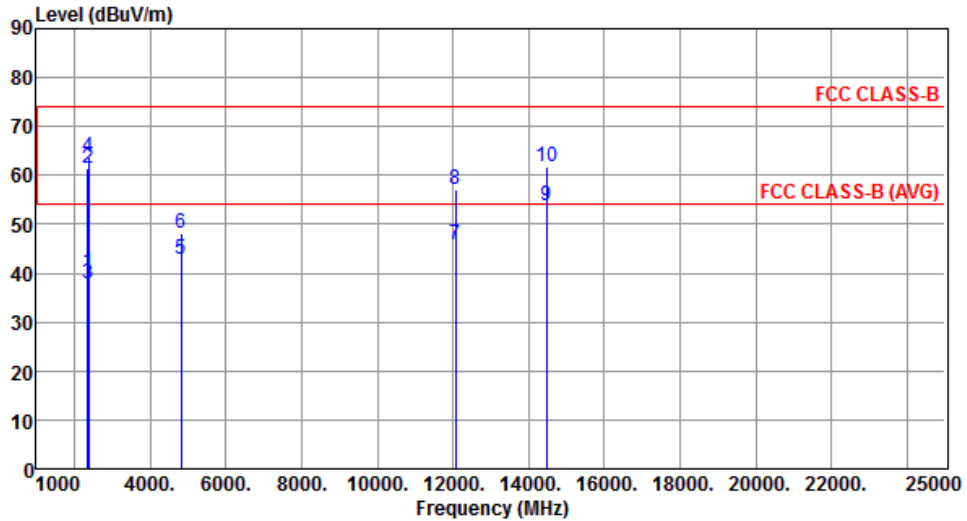

	Freq. MHz	Emission level dBuV/m	Limit dBuV/m	Margin dB	SA reading dBuV	Factor dB	Remark	ANT High cm	Turn Table deg
1	2360.00	40.33	54.00	-13.67	41.83	-1.50	Average	150	139
2	2360.00	61.36	74.00	-12.64	62.86	-1.50	Peak	150	139
3	2390.00	37.89	54.00	-16.11	39.25	-1.36	Average	150	139
4	2390.00	63.93	74.00	-10.07	65.29	-1.36	Peak	150	139
5	4824.00	42.79	54.00	-11.21	36.85	5.94	Average	238	150
6	4824.00	48.10	74.00	-25.90	42.16	5.94	Peak	238	150
7	12060.00	45.87	54.00	-8.13	29.90	15.97	Average	193	210
8	12060.00	57.17	74.00	-16.83	41.20	15.97	Peak	193	210
9	14472.00	53.86	54.00	-0.14	34.45	19.41	Average	372	337
10	14472.00	61.64	74.00	-12.36	42.23	19.41	Peak	150	154

Note 1: Emission Level (dBuV/m) = SA Reading (dBuV/m) + Factor\* (dB)

\*Factor includes antenna factor , cable loss and amplifier gain

Note 2: Margin (dB) = Emission level (dBuV/m) – Limit (dBuV/m).

<b>Modulation</b>	11b	<b>Test Freq. (MHz)</b>	2437
<b>Polarization</b>	Horizontal	<b>Test Configuration</b>	3

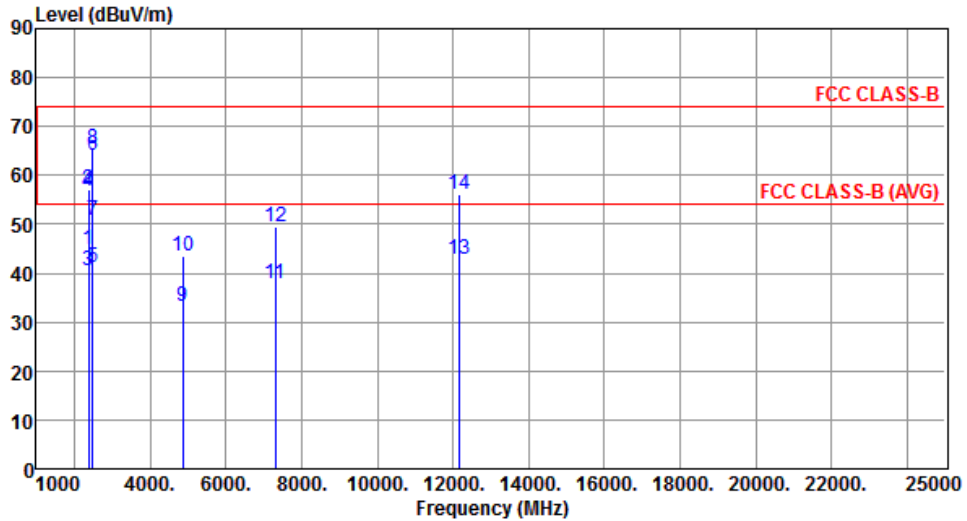

	Freq. MHz	Emission level dBuV/m	Limit dBuV/m	Margin dB	SA reading dBuV	Factor dB	Remark	ANT High cm	Turn Table deg
1	2385.00	44.87	54.00	-9.13	46.26	-1.39	Average	150	140
2	2385.00	56.97	74.00	-17.03	58.36	-1.39	Peak	150	140
3	2390.00	40.36	54.00	-13.64	41.72	-1.36	Average	150	140
4	2390.00	56.68	74.00	-17.32	58.04	-1.36	Peak	150	140
5	2483.50	41.27	54.00	-12.73	42.29	-1.02	Average	150	145
6	2483.50	64.02	74.00	-9.98	65.04	-1.02	Peak	150	145
7	2489.00	50.71	54.00	-3.29	51.72	-1.01	Average	150	145
8	2489.00	65.43	74.00	-8.57	66.44	-1.01	Peak	150	145
9	4874.00	33.13	54.00	-20.87	27.16	5.97	Average	328	20
10	4874.00	43.53	74.00	-30.47	37.56	5.97	Peak	328	20
11	7311.00	38.01	54.00	-15.99	27.26	10.75	Average	300	230
12	7311.00	49.41	74.00	-24.59	38.66	10.75	Peak	300	230
13	12185.00	42.72	54.00	-11.28	26.88	15.84	Average	286	156
14	12185.00	56.18	74.00	-17.82	40.34	15.84	Peak	286	156

Note 1: Emission Level (dBuV/m) = SA Reading (dBuV/m) + Factor\* (dB)

\*Factor includes antenna factor , cable loss and amplifier gain

Note 2: Margin (dB) = Emission level (dBuV/m) – Limit (dBuV/m).

<b>Modulation</b>	11b	<b>Test Freq. (MHz)</b>	2437
<b>Polarization</b>	Vertical	<b>Test Configuration</b>	3

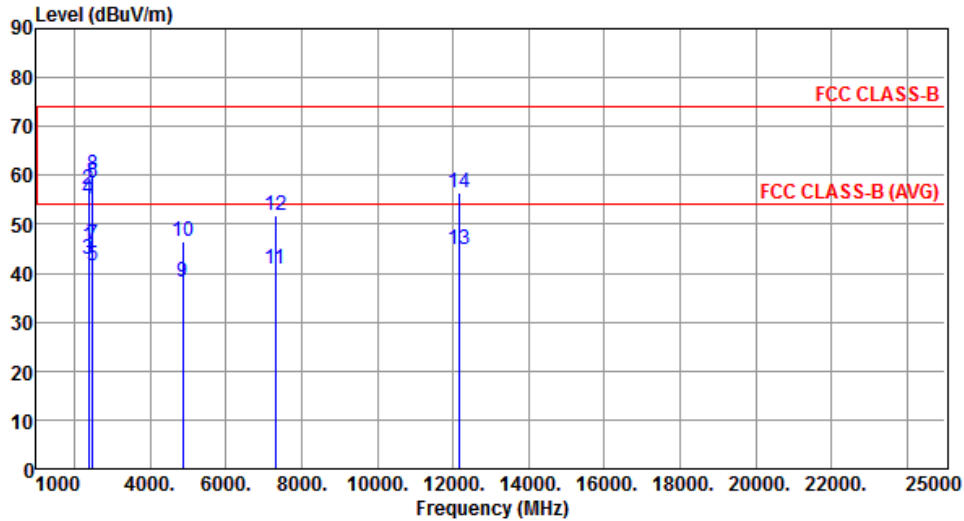

	Freq. MHz	Emission level dBuV/m	Limit dBuV/m	Margin dB	SA reading dBuV	Factor dB	Remark	ANT High cm	Turn Table deg
1	2385.00	45.63	54.00	-8.37	47.02	-1.39	Average	299	105
2	2385.00	57.26	74.00	-16.74	58.65	-1.39	Peak	299	105
3	2390.00	42.89	54.00	-11.11	44.25	-1.36	Average	299	105
4	2390.00	55.03	74.00	-18.97	56.39	-1.36	Peak	299	105
5	2483.50	41.57	54.00	-12.43	42.59	-1.02	Average	299	99
6	2483.50	58.57	74.00	-15.43	59.59	-1.02	Peak	299	99
7	2489.00	45.69	54.00	-8.31	46.70	-1.01	Average	299	99
8	2489.00	60.18	74.00	-13.82	61.19	-1.01	Peak	299	99
9	4874.00	38.24	54.00	-15.76	32.27	5.97	Average	350	264
10	4874.00	46.36	74.00	-27.64	40.39	5.97	Peak	350	264
11	7311.00	41.01	54.00	-12.99	30.26	10.75	Average	248	141
12	7311.00	51.73	74.00	-22.27	40.98	10.75	Peak	248	141
13	12185.00	44.74	54.00	-9.26	28.90	15.84	Average	174	309
14	12185.00	56.53	74.00	-17.47	40.69	15.84	Peak	174	309

Note 1: Emission Level (dBuV/m) = SA Reading (dBuV/m) + Factor\* (dB)

\*Factor includes antenna factor , cable loss and amplifier gain

Note 2: Margin (dB) = Emission level (dBuV/m) – Limit (dBuV/m).

<b>Modulation</b>	11b	<b>Test Freq. (MHz)</b>	2462
<b>Polarization</b>	Horizontal	<b>Test Configuration</b>	3

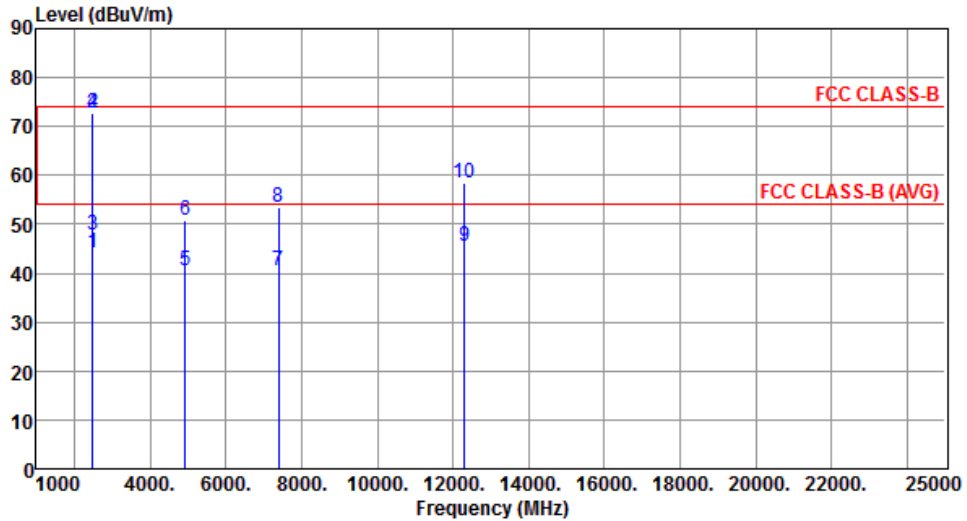

	Freq. MHz	Emission level dBuV/m	Limit dBuV/m	Margin dB	SA reading dBuV	Factor dB	Remark	ANT High cm	Turn Table deg
1	2483.50	44.09	54.00	-9.91	45.11	-1.02	Average	162	142
2	2483.50	72.79	74.00	-1.21	73.81	-1.02	Peak	162	142
3	2489.00	47.70	54.00	-6.30	48.71	-1.01	Average	158	138
4	2489.00	72.79	74.00	-1.21	73.80	-1.01	Peak	158	138
5	4924.00	40.61	54.00	-13.39	34.60	6.01	Average	178	28
6	4924.00	50.67	74.00	-23.33	44.66	6.01	Peak	178	28
7	7386.00	40.53	54.00	-13.47	29.63	10.90	Average	202	135
8	7386.00	53.50	74.00	-20.50	42.60	10.90	Peak	202	135
9	12310.00	45.39	54.00	-8.61	29.69	15.70	Average	168	260
10	12310.00	58.36	74.00	-15.64	42.66	15.70	Peak	168	260

Note 1: Emission Level (dBuV/m) = SA Reading (dBuV/m) + Factor\* (dB)

\*Factor includes antenna factor , cable loss and amplifier gain

Note 2: Margin (dB) = Emission level (dBuV/m) – Limit (dBuV/m).

<b>Modulation</b>	11b	<b>Test Freq. (MHz)</b>	2462
<b>Polarization</b>	Vertical	<b>Test Configuration</b>	3

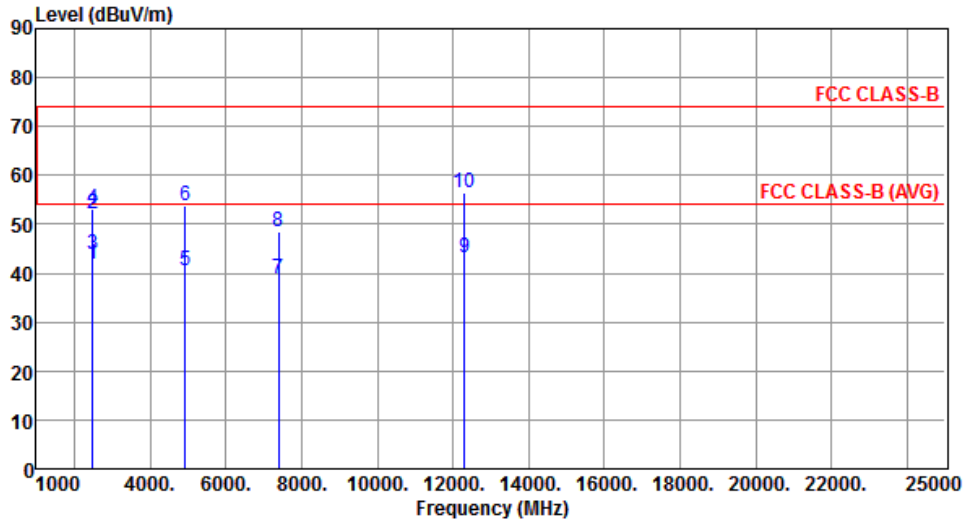

	Freq. MHz	Emission level dBuV/m	Limit dBuV/m	Margin dB	SA reading dBuV	Factor dB	Remark	ANT High cm	Turn Table deg
1	2483.50	41.87	54.00	-12.13	42.89	-1.02	Average	178	114
2	2483.50	52.09	74.00	-21.91	53.11	-1.02	Peak	178	114
3	2489.00	43.68	54.00	-10.32	44.69	-1.01	Average	160	113
4	2489.00	53.25	74.00	-20.75	54.26	-1.01	Peak	160	113
5	4924.00	40.57	54.00	-13.43	34.56	6.01	Average	150	177
6	4924.00	53.64	74.00	-20.36	47.63	6.01	Peak	150	177
7	7386.00	38.76	54.00	-15.24	27.86	10.90	Average	250	354
8	7386.00	48.50	74.00	-25.50	37.60	10.90	Peak	250	354
9	12310.00	43.30	54.00	-10.70	27.60	15.70	Average	169	267
10	12310.00	56.30	74.00	-17.70	40.60	15.70	Peak	169	267

Note 1: Emission Level (dBuV/m) = SA Reading (dBuV/m) + Factor\* (dB)

\*Factor includes antenna factor , cable loss and amplifier gain

Note 2: Margin (dB) = Emission level (dBuV/m) – Limit (dBuV/m).

### 3.5.14 Transmitter Radiated Unwanted Emissions (Above 1GHz) for 11g

<b>Modulation</b>	11g	<b>Test Freq. (MHz)</b>	2412
<b>Polarization</b>	Horizontal	<b>Test Configuration</b>	3

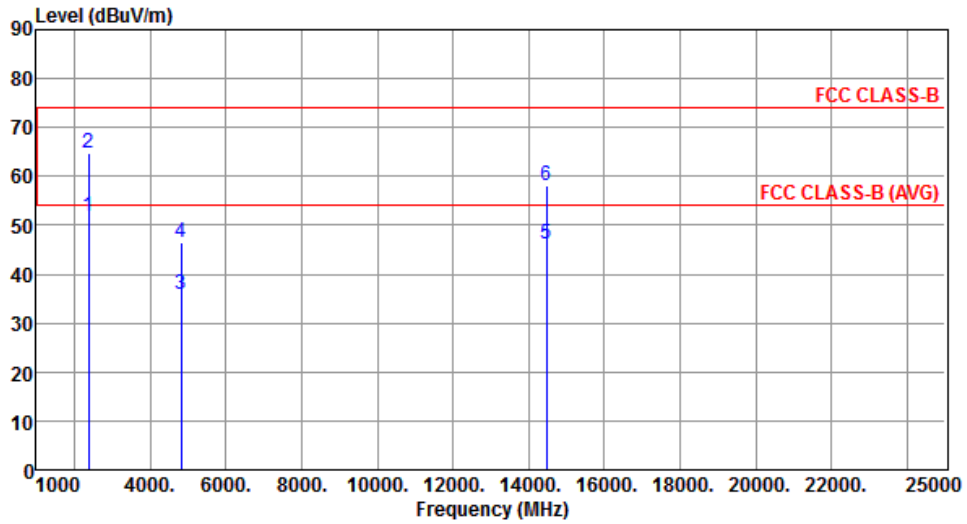

	Freq. MHz	Emission level dBuV/m	Limit dBuV/m	Margin dB	SA reading dBuV	Factor dB	Remark	ANT High cm	Turn Table deg
1	2390.00	51.76	54.00	-2.24	53.12	-1.36	Average	226	94
2	2390.00	64.76	74.00	-9.24	66.12	-1.36	Peak	226	94
3	4824.00	36.03	54.00	-17.97	30.09	5.94	Average	267	185
4	4824.00	46.59	74.00	-27.41	40.65	5.94	Peak	267	185
5	14472.00	46.32	54.00	-7.68	26.91	19.41	Average	276	155
6	14472.00	58.00	74.00	-16.00	38.59	19.41	Peak	276	155

Note 1: Emission Level (dBuV/m) = SA Reading (dBuV/m) + Factor\* (dB)

\*Factor includes antenna factor , cable loss and amplifier gain

Note 2: Margin (dB) = Emission level (dBuV/m) – Limit (dBuV/m).

<b>Modulation</b>	11g	<b>Test Freq. (MHz)</b>	2412
<b>Polarization</b>	Vertical	<b>Test Configuration</b>	3

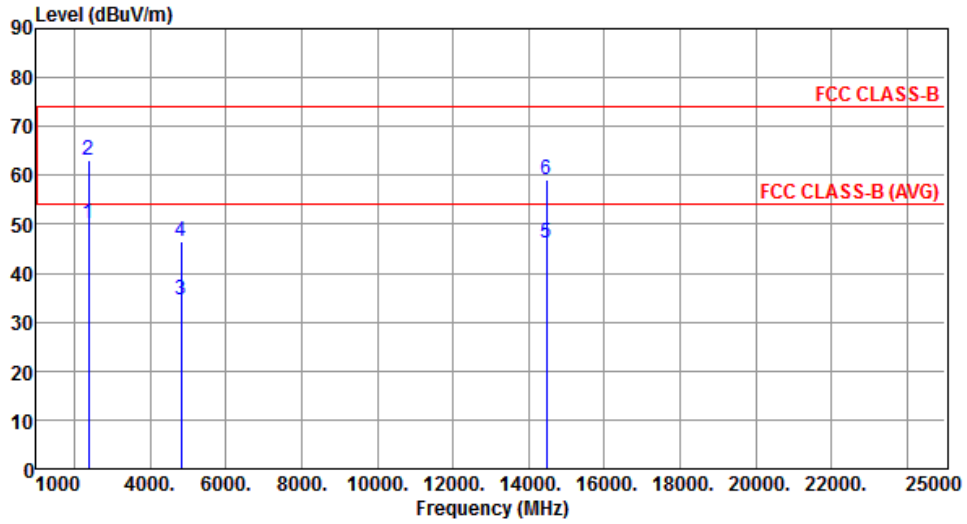

	Freq. MHz	Emission level dBuV/m	Limit dBuV/m	Margin dB	SA reading dBuV	Factor dB	Remark	ANT High cm	Turn Table deg
1	2390.00	50.26	54.00	-3.74	51.62	-1.36	Average	168	183
2	2390.00	63.08	74.00	-10.92	64.44	-1.36	Peak	168	183
3	4824.00	34.50	54.00	-19.50	28.56	5.94	Average	241	69
4	4824.00	46.40	74.00	-27.60	40.46	5.94	Peak	241	69
5	14472.00	46.08	54.00	-7.92	26.67	19.41	Average	315	146
6	14472.00	59.15	74.00	-14.85	39.74	19.41	Peak	315	146

Note 1: Emission Level (dBuV/m) = SA Reading (dBuV/m) + Factor\* (dB)

\*Factor includes antenna factor , cable loss and amplifier gain

Note 2: Margin (dB) = Emission level (dBuV/m) – Limit (dBuV/m).



<b>Modulation</b>	11g	<b>Test Freq. (MHz)</b>	2437
<b>Polarization</b>	Horizontal	<b>Test Configuration</b>	3

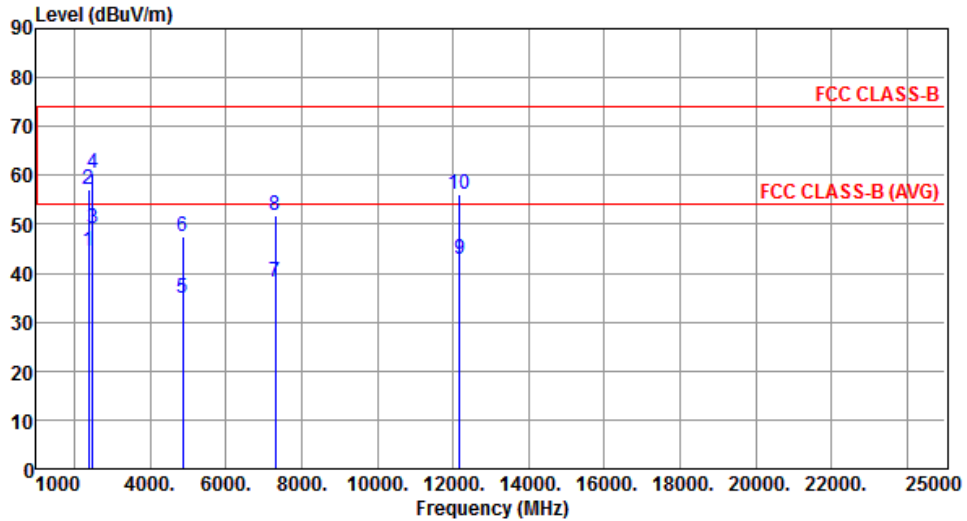

	Freq. MHz	Emission level dBuV/m	Limit dBuV/m	Margin dB	SA reading dBuV	Factor dB	Remark	ANT High cm	Turn Table deg
1	2390.00	44.36	54.00	-9.64	45.72	-1.36	Average	181	133
2	2390.00	57.23	74.00	-16.77	58.59	-1.36	Peak	181	133
3	2483.50	49.06	54.00	-4.94	50.08	-1.02	Average	181	133
4	2483.50	60.50	74.00	-13.50	61.52	-1.02	Peak	181	133
5	4874.00	34.91	54.00	-19.09	28.94	5.97	Average	320	157
6	4874.00	47.53	74.00	-26.47	41.56	5.97	Peak	320	157
7	7311.00	38.09	54.00	-15.91	27.34	10.75	Average	218	267
8	7311.00	51.65	74.00	-22.35	40.90	10.75	Peak	218	267
9	12185.00	42.81	54.00	-11.19	26.97	15.84	Average	280	194
10	12185.00	56.00	74.00	-18.00	40.16	15.84	Peak	280	194

Note 1: Emission Level (dBuV/m) = SA Reading (dBuV/m) + Factor\* (dB)

\*Factor includes antenna factor , cable loss and amplifier gain

Note 2: Margin (dB) = Emission level (dBuV/m) – Limit (dBuV/m).

<b>Modulation</b>	11g	<b>Test Freq. (MHz)</b>	2437
<b>Polarization</b>	Vertical	<b>Test Configuration</b>	3

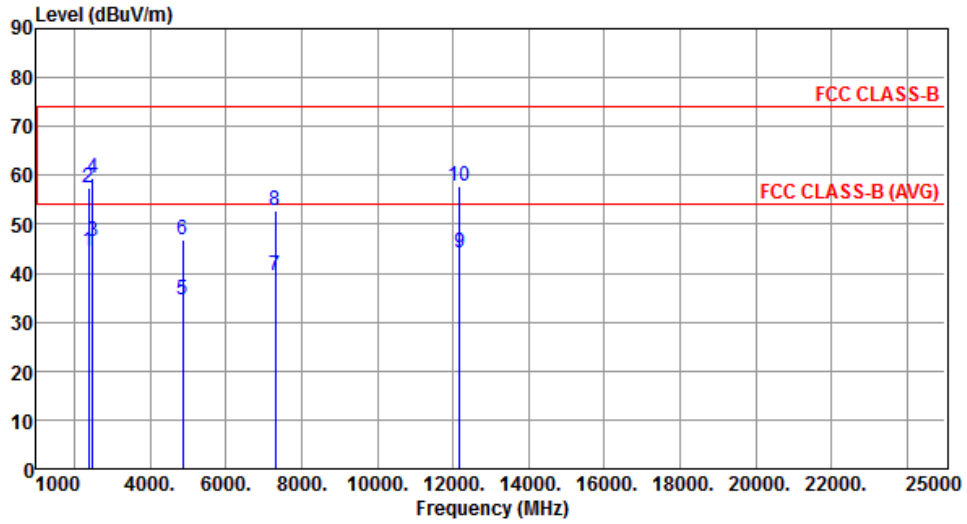

	Freq. MHz	Emission level dBuV/m	Limit dBuV/m	Margin dB	SA reading dBuV	Factor dB	Remark	ANT High cm	Turn Table deg
1	2390.00	44.66	54.00	-9.34	46.02	-1.36	Average	150	337
2	2390.00	57.61	74.00	-16.39	58.97	-1.36	Peak	150	337
3	2483.50	46.46	54.00	-7.54	47.48	-1.02	Average	150	337
4	2483.50	59.46	74.00	-14.54	60.48	-1.02	Peak	150	337
5	4874.00	34.53	54.00	-19.47	28.56	5.97	Average	200	62
6	4874.00	46.83	74.00	-27.17	40.86	5.97	Peak	200	62
7	7311.00	39.65	54.00	-14.35	28.90	10.75	Average	219	113
8	7311.00	52.65	74.00	-21.35	41.90	10.75	Peak	219	113
9	12185.00	44.10	54.00	-9.90	28.26	15.84	Average	352	179
10	12185.00	57.67	74.00	-16.33	41.83	15.84	Peak	352	179

Note 1: Emission Level (dBuV/m) = SA Reading (dBuV/m) + Factor\* (dB)

\*Factor includes antenna factor , cable loss and amplifier gain

Note 2: Margin (dB) = Emission level (dBuV/m) – Limit (dBuV/m).

<b>Modulation</b>	11g	<b>Test Freq. (MHz)</b>	2462
<b>Polarization</b>	Horizontal	<b>Test Configuration</b>	3

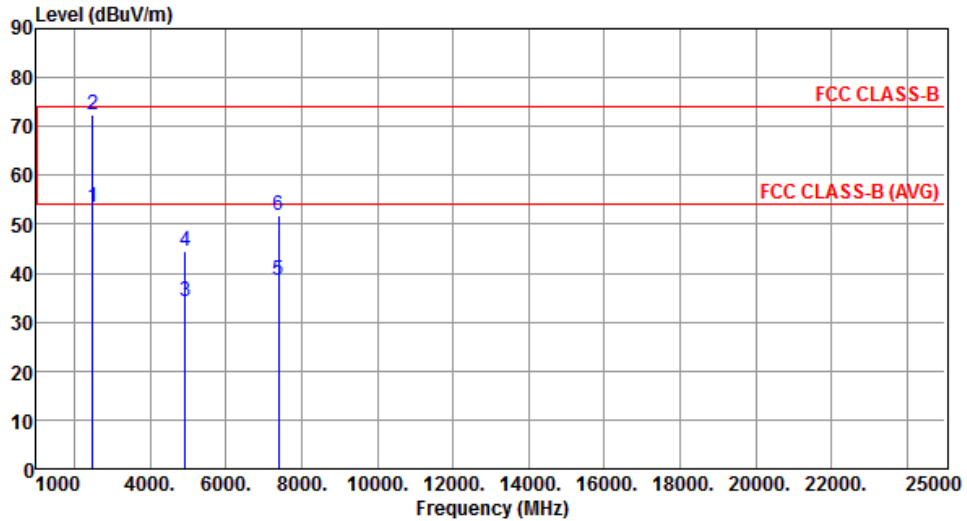

	Freq. MHz	Emission level dBuV/m	Limit dBuV/m	Margin dB	SA reading dBuV	Factor dB	Remark	ANT High cm	Turn Table deg
1	2483.50	53.52	54.00	-0.48	54.54	-1.02	Average	239	104
2	2483.50	72.23	74.00	-1.77	73.25	-1.02	Peak	239	104
3	4924.00	34.32	54.00	-19.68	28.31	6.01	Average	318	154
4	4924.00	44.62	74.00	-29.38	38.61	6.01	Peak	318	154
5	7386.00	38.54	54.00	-15.46	27.64	10.90	Average	391	162
6	7386.00	51.84	74.00	-22.16	40.94	10.90	Peak	391	162

Note 1: Emission Level (dBuV/m) = SA Reading (dBuV/m) + Factor\* (dB)

\*Factor includes antenna factor , cable loss and amplifier gain

Note 2: Margin (dB) = Emission level (dBuV/m) – Limit (dBuV/m).

<b>Modulation</b>	11g	<b>Test Freq. (MHz)</b>	2462
<b>Polarization</b>	Vertical	<b>Test Configuration</b>	3

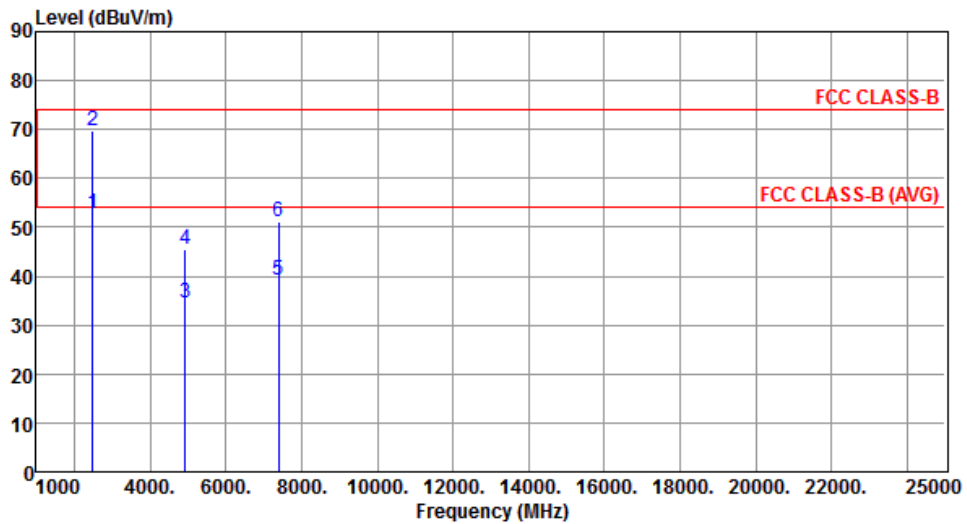

	Freq. MHz	Emission level dBuV/m	Limit dBuV/m	Margin dB	SA reading dBuV	Factor dB	Remark	ANT High cm	Turn Table deg
1	2483.50	52.83	54.00	-1.17	53.85	-1.02	Average	244	156
2	2483.50	69.83	74.00	-4.17	70.85	-1.02	Peak	244	156
3	4924.00	34.61	54.00	-19.39	28.60	6.01	Average	250	147
4	4924.00	45.49	74.00	-28.51	39.48	6.01	Peak	250	147
5	7386.00	39.16	54.00	-14.84	28.26	10.90	Average	302	132
6	7386.00	51.12	74.00	-22.88	40.22	10.90	Peak	302	132

Note 1: Emission Level (dBuV/m) = SA Reading (dBuV/m) + Factor\* (dB)

\*Factor includes antenna factor , cable loss and amplifier gain

Note 2: Margin (dB) = Emission level (dBuV/m) – Limit (dBuV/m).

### 3.5.15 Transmitter Radiated Unwanted Emissions (Above 1GHz) for HT20

Modulation	HT20	Test Freq. (MHz)	2412
Polarization	Horizontal	Test Configuration	3

  

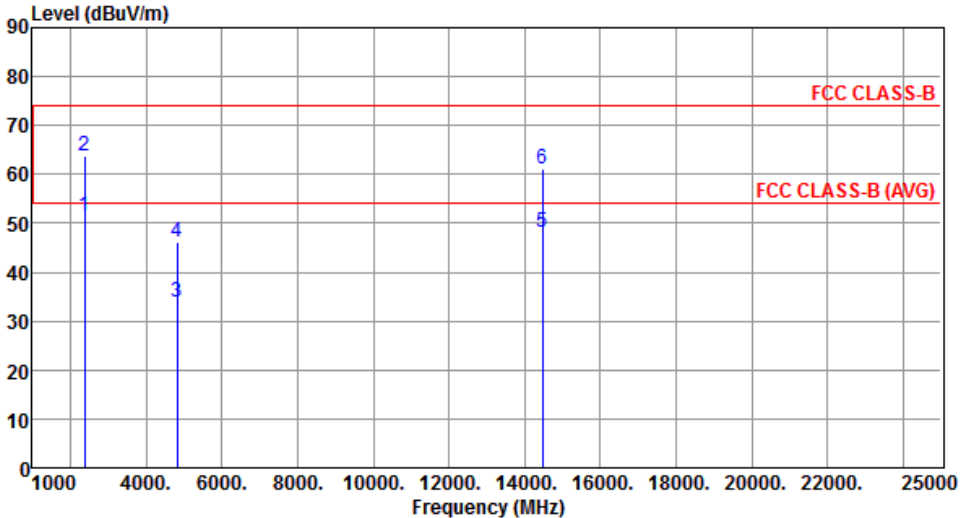

	Freq. MHz	Emission level dBuV/m	Limit dBuV/m	Margin dB	SA reading dBuV	Factor dB	Remark	ANT High cm	Turn Table deg
1	2390.00	51.56	54.00	-2.44	52.92	-1.36	Average	226	94
2	2390.00	63.76	74.00	-10.24	65.12	-1.36	Peak	226	94
3	4824.00	33.81	54.00	-20.19	27.87	5.94	Average	269	242
4	4824.00	46.04	74.00	-27.96	40.10	5.94	Peak	269	242
5	14472.00	48.15	54.00	-5.85	28.74	19.41	Average	176	39
6	14472.00	61.24	74.00	-12.76	41.83	19.41	Peak	176	39

Note 1: Emission Level (dBuV/m) = SA Reading (dBuV/m) + Factor\* (dB)  
\*Factor includes antenna factor , cable loss and amplifier gain  
Note 2: Margin (dB) = Emission level (dBuV/m) – Limit (dBuV/m).

<b>Modulation</b>	HT20	<b>Test Freq. (MHz)</b>	2412
<b>Polarization</b>	Vertical	<b>Test Configuration</b>	3

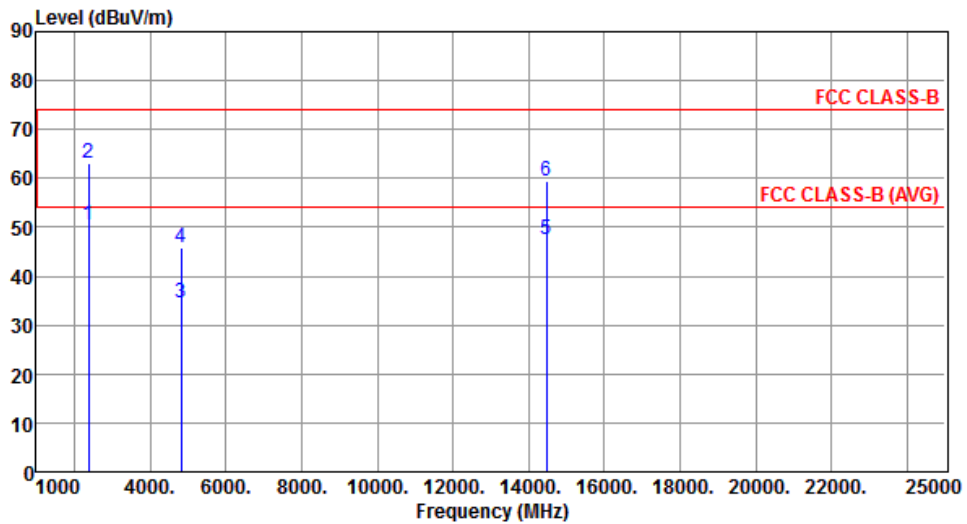

	Freq. MHz	Emission level dBuV/m	Limit dBuV/m	Margin dB	SA reading dBuV	Factor dB	Remark	ANT High cm	Turn Table deg
1	2390.00	50.46	54.00	-3.54	51.82	-1.36	Average	168	177
2	2390.00	63.12	74.00	-10.88	64.48	-1.36	Peak	168	177
3	4824.00	34.47	54.00	-19.53	28.53	5.94	Average	169	137
4	4824.00	45.74	74.00	-28.26	39.80	5.94	Peak	169	137
5	14472.00	47.49	54.00	-6.51	28.08	19.41	Average	361	159
6	14472.00	59.52	74.00	-14.48	40.11	19.41	Peak	361	159

Note 1: Emission Level (dBuV/m) = SA Reading (dBuV/m) + Factor\* (dB)

\*Factor includes antenna factor , cable loss and amplifier gain

Note 2: Margin (dB) = Emission level (dBuV/m) – Limit (dBuV/m).

<b>Modulation</b>	HT20	<b>Test Freq. (MHz)</b>	2437
<b>Polarization</b>	Horizontal	<b>Test Configuration</b>	3

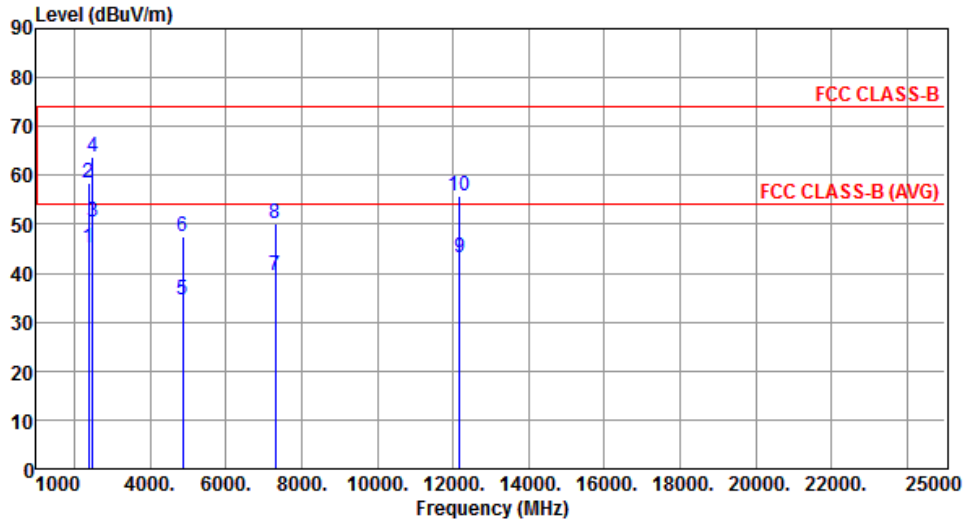

	Freq. MHz	Emission level dBuV/m	Limit dBuV/m	Margin dB	SA reading dBuV	Factor dB	Remark	ANT High cm	Turn Table deg
1	2390.00	45.26	54.00	-8.74	46.62	-1.36	Average	181	133
2	2390.00	58.46	74.00	-15.54	59.82	-1.36	Peak	181	133
3	2483.50	50.56	54.00	-3.44	51.58	-1.02	Average	181	133
4	2483.50	63.70	74.00	-10.30	64.72	-1.02	Peak	181	133
5	4874.00	34.53	54.00	-19.47	28.56	5.97	Average	192	3
6	4874.00	47.53	74.00	-26.47	41.56	5.97	Peak	192	3
7	7311.00	39.65	54.00	-14.35	28.90	10.75	Average	243	191
8	7311.00	50.31	74.00	-23.69	39.56	10.75	Peak	243	191
9	12185.00	43.06	54.00	-10.94	27.22	15.84	Average	309	258
10	12185.00	55.67	74.00	-18.33	39.83	15.84	Peak	309	258

Note 1: Emission Level (dBuV/m) = SA Reading (dBuV/m) + Factor\* (dB)

\*Factor includes antenna factor , cable loss and amplifier gain

Note 2: Margin (dB) = Emission level (dBuV/m) – Limit (dBuV/m).

<b>Modulation</b>	HT20	<b>Test Freq. (MHz)</b>	2437
<b>Polarization</b>	Vertical	<b>Test Configuration</b>	3

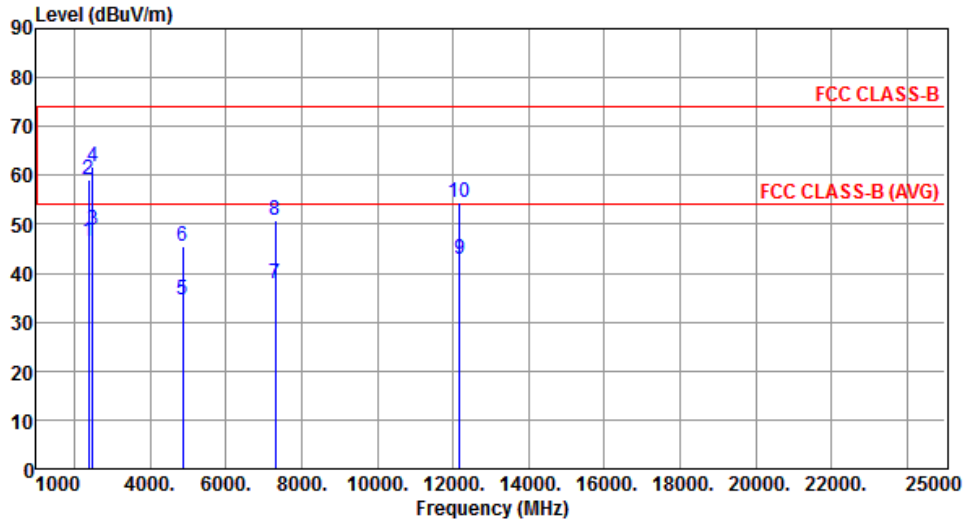

	Freq. MHz	Emission level dBuV/m	Limit dBuV/m	Margin dB	SA reading dBuV	Factor dB	Remark	ANT High cm	Turn Table deg
1	2390.00	46.49	54.00	-7.51	47.85	-1.36	Average	150	337
2	2390.00	59.16	74.00	-14.84	60.52	-1.36	Peak	150	337
3	2483.50	48.70	54.00	-5.30	49.72	-1.02	Average	150	337
4	2483.50	61.70	74.00	-12.30	62.72	-1.02	Peak	150	337
5	4874.00	34.57	54.00	-19.43	28.60	5.97	Average	331	164
6	4874.00	45.53	74.00	-28.47	39.56	5.97	Peak	331	164
7	7311.00	37.83	54.00	-16.17	27.08	10.75	Average	305	209
8	7311.00	50.66	74.00	-23.34	39.91	10.75	Peak	305	209
9	12185.00	42.95	54.00	-11.05	27.11	15.84	Average	174	56
10	12185.00	54.56	74.00	-19.44	38.72	15.84	Peak	174	56

Note 1: Emission Level (dBuV/m) = SA Reading (dBuV/m) + Factor\* (dB)

\*Factor includes antenna factor , cable loss and amplifier gain

Note 2: Margin (dB) = Emission level (dBuV/m) – Limit (dBuV/m).



<b>Modulation</b>	HT20	<b>Test Freq. (MHz)</b>	2462
<b>Polarization</b>	Horizontal	<b>Test Configuration</b>	3

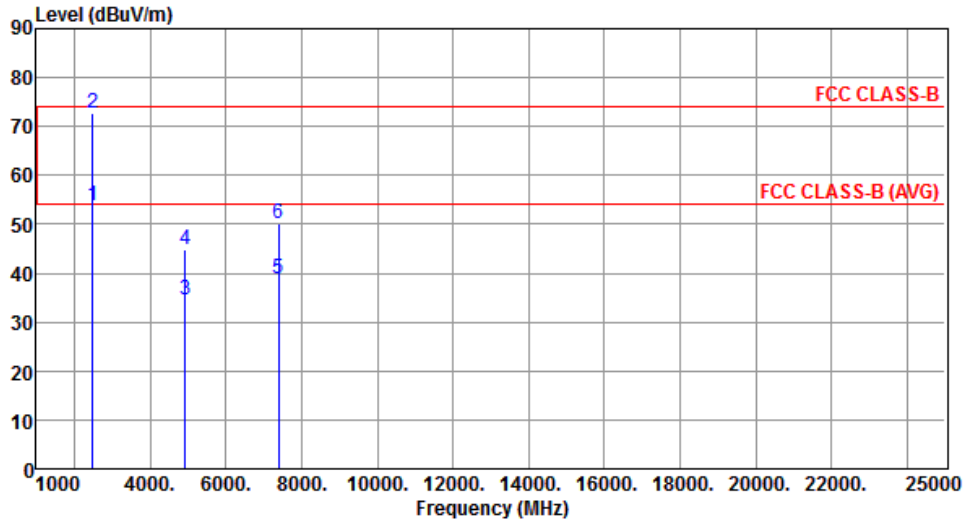

	Freq. MHz	Emission level dBuV/m	Limit dBuV/m	Margin dB	SA reading dBuV	Factor dB	Remark	ANT High cm	Turn Table deg
1	2483.50	53.76	54.00	-0.24	54.78	-1.02	Average	239	104
2	2483.50	72.86	74.00	-1.14	73.88	-1.02	Peak	239	104
3	4924.00	34.60	54.00	-19.40	28.59	6.01	Average	274	159
4	4924.00	44.98	74.00	-29.02	38.97	6.01	Peak	274	159
5	7386.00	38.83	54.00	-15.17	27.93	10.90	Average	231	278
6	7386.00	50.20	74.00	-23.80	39.30	10.90	Peak	231	278

Note 1: Emission Level (dBuV/m) = SA Reading (dBuV/m) + Factor\* (dB)

\*Factor includes antenna factor , cable loss and amplifier gain

Note 2: Margin (dB) = Emission level (dBuV/m) – Limit (dBuV/m).

<b>Modulation</b>	HT20	<b>Test Freq. (MHz)</b>	2462
<b>Polarization</b>	Vertical	<b>Test Configuration</b>	3

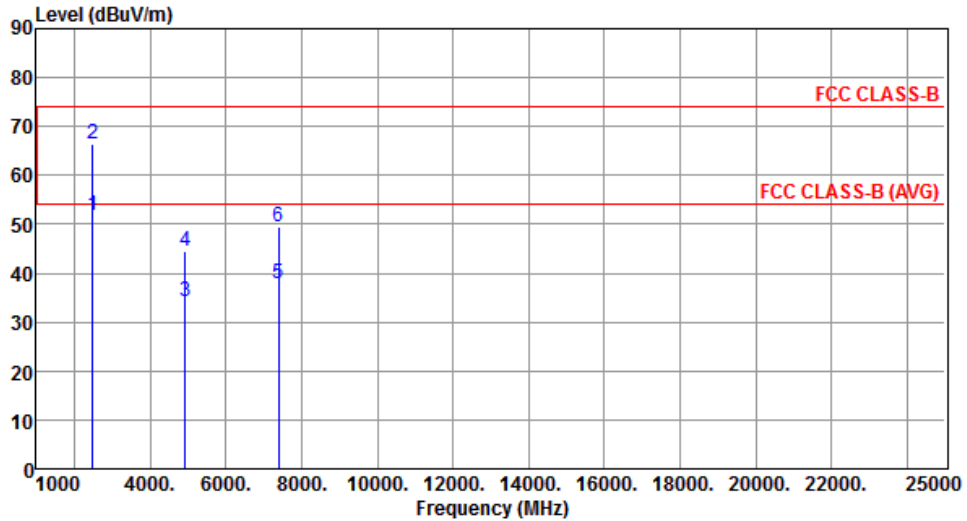

	Freq. MHz	Emission level dBuV/m	Limit dBuV/m	Margin dB	SA reading dBuV	Factor dB	Remark	ANT High cm	Turn Table deg
1	2483.50	51.80	54.00	-2.20	52.82	-1.02	Average	244	156
2	2483.50	66.56	74.00	-7.44	67.58	-1.02	Peak	244	156
3	4924.00	34.32	54.00	-19.68	28.31	6.01	Average	123	167
4	4924.00	44.62	74.00	-29.38	38.61	6.01	Peak	123	167
5	7386.00	37.78	54.00	-16.22	26.88	10.90	Average	152	205
6	7386.00	49.47	74.00	-24.53	38.57	10.90	Peak	152	205

Note 1: Emission Level (dBuV/m) = SA Reading (dBuV/m) + Factor\* (dB)

\*Factor includes antenna factor , cable loss and amplifier gain

Note 2: Margin (dB) = Emission level (dBuV/m) – Limit (dBuV/m).

## 3.6 Emissions in Non-Restricted Frequency Bands

### 3.6.1 Emissions in Non-Restricted Frequency Bands Limit

Peak power in any 100 kHz bandwidth outside of the authorized frequency band shall be attenuated by at least 20 dB relative to the maximum in-band peak PSD level in 100 kHz

### 3.6.2 Measuring Instruments

Refer a test equipment and calibration data table in this test report.

### 3.6.3 Test Procedures

#### Reference level measurement

1. Set RBW=100kHz, VBW = 300kHz , Detector = Peak, Sweep time = Auto
2. Trace = max hold , Allow Trace to fully stabilize
3. Use the peak marker function to determine the maximum PSD level

#### Emission level measurement

1. Set RBW=100kHz, VBW = 300kHz , Detector = Peak, Sweep time = Auto
2. Trace = max hold , Allow Trace to fully stabilize
3. Scan Frequency range is up to 25GHz
4. Use the peak marker function to determine the maximum amplitude level

### 3.6.4 Test Setup

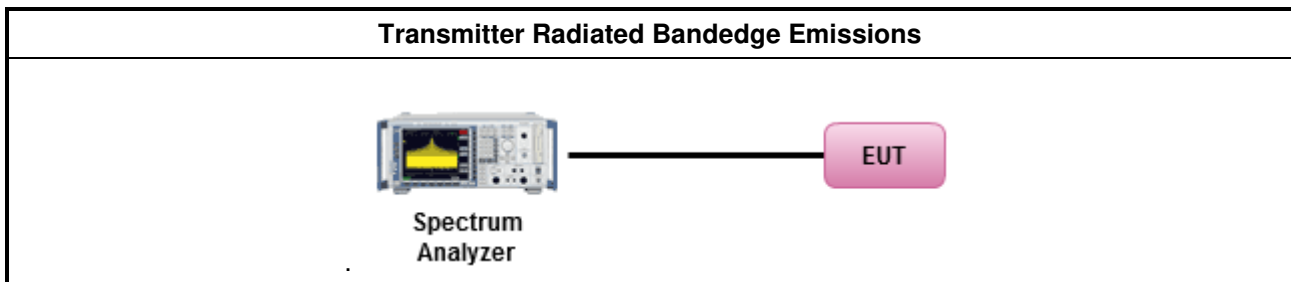

### 3.6.5 Test Result of Emissions in non-restricted frequency bands

This test item is performed on each TX output individually without summing or adding  $10 \log(N_{ANT})$  since measurements are made relative to the in-band emissions on the individual outputs. Only worst test result of each operating mode is presented.

### 3.6.6 Unwanted Emissions into Non-Restricted Frequency Bands

802.11b

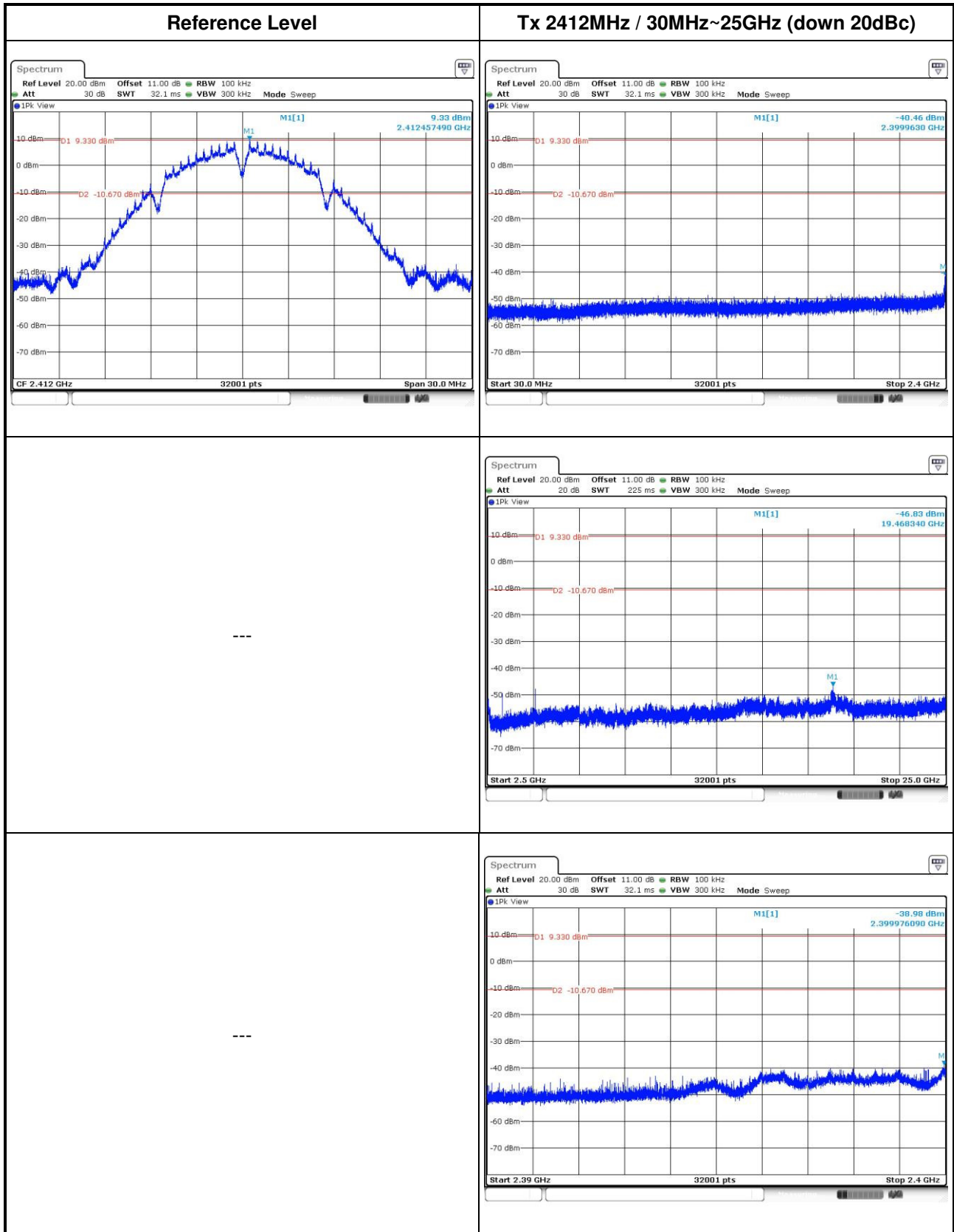

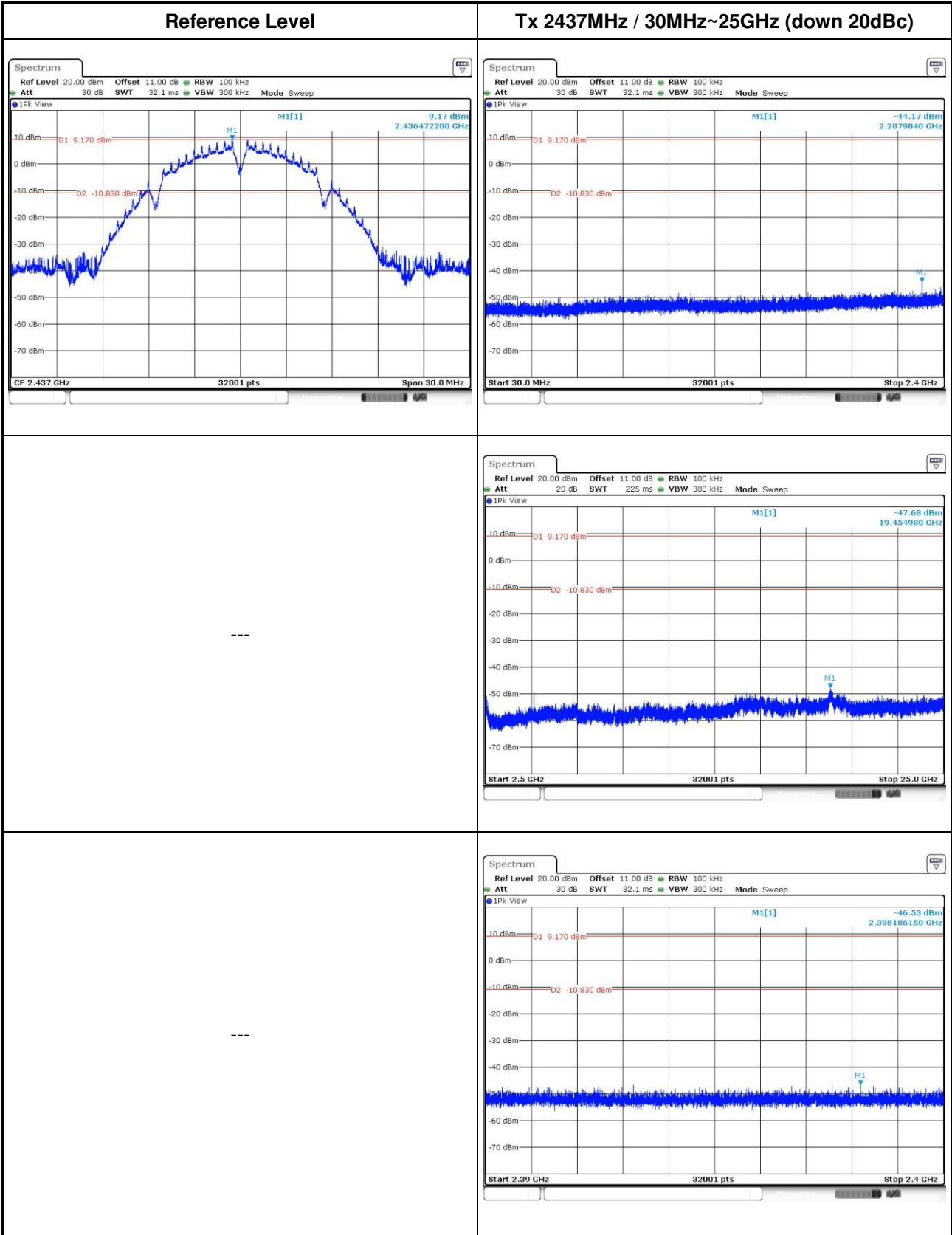

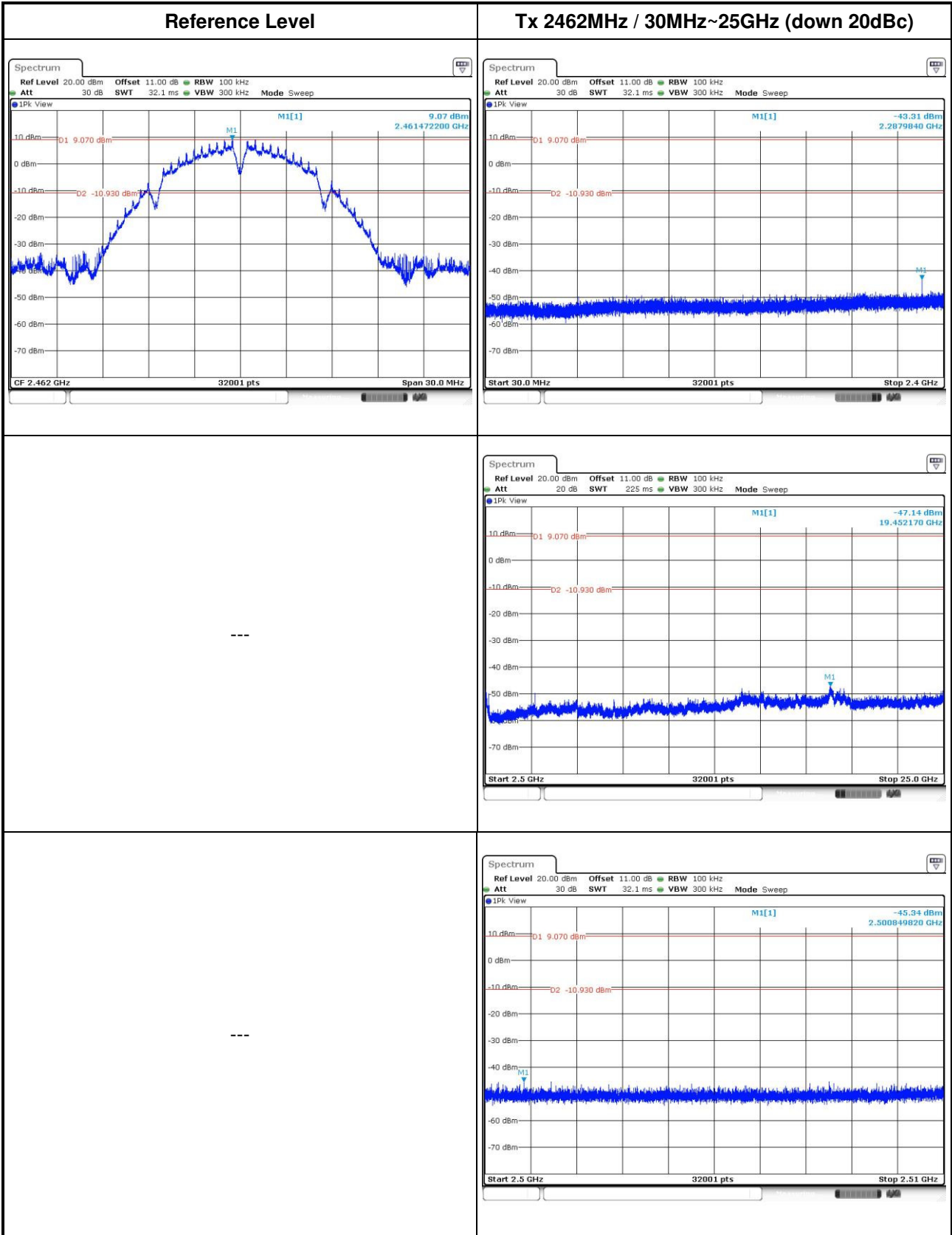

802.11g

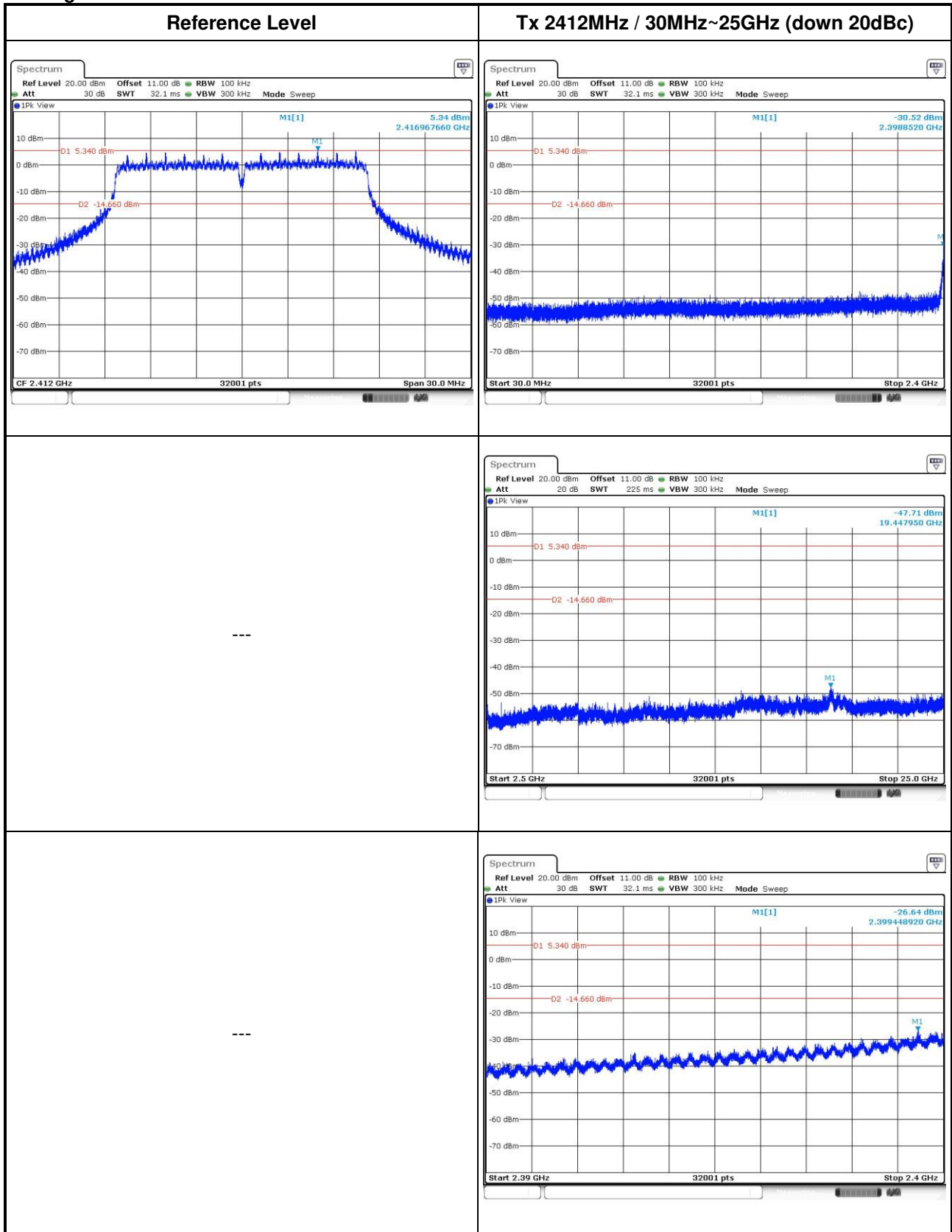

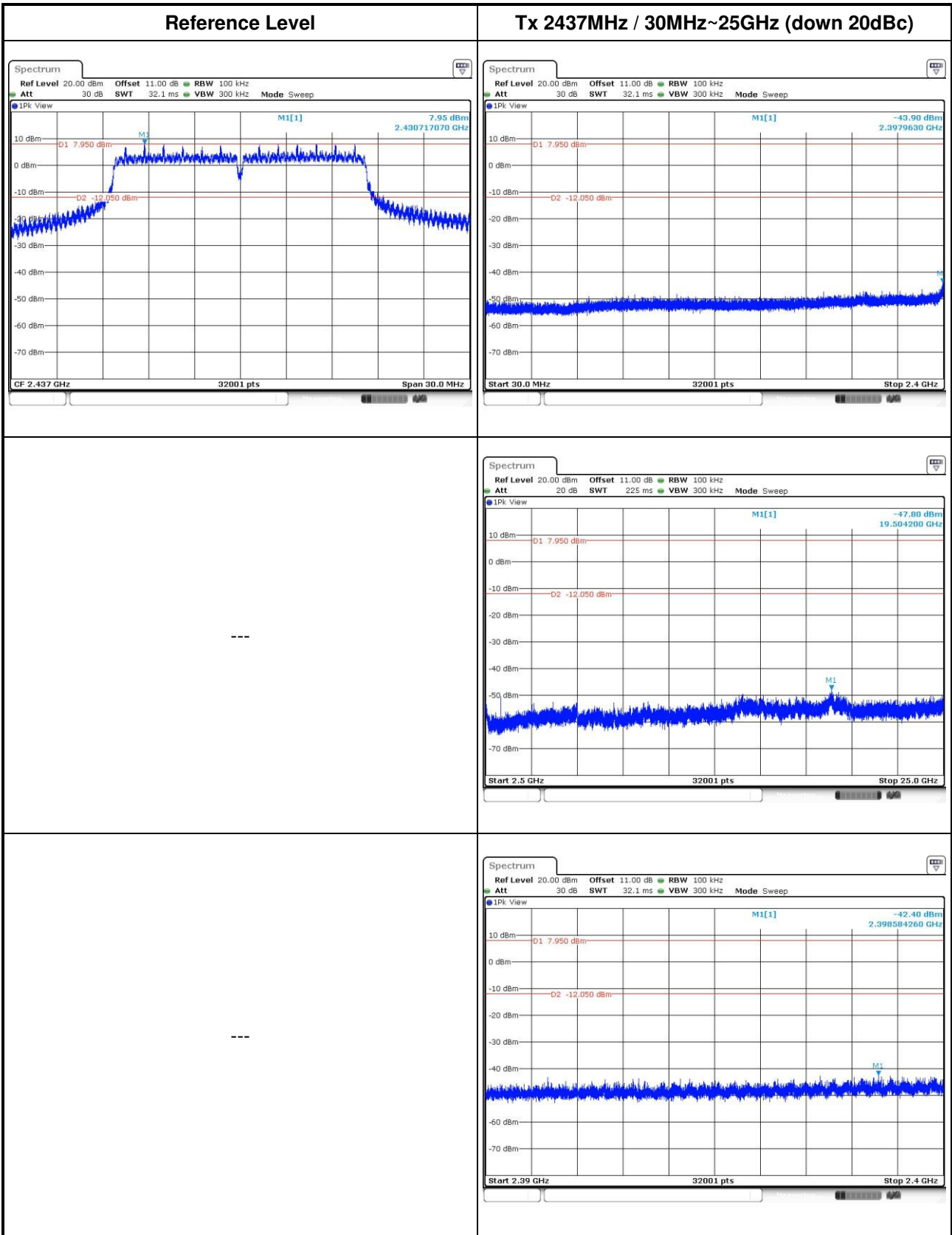



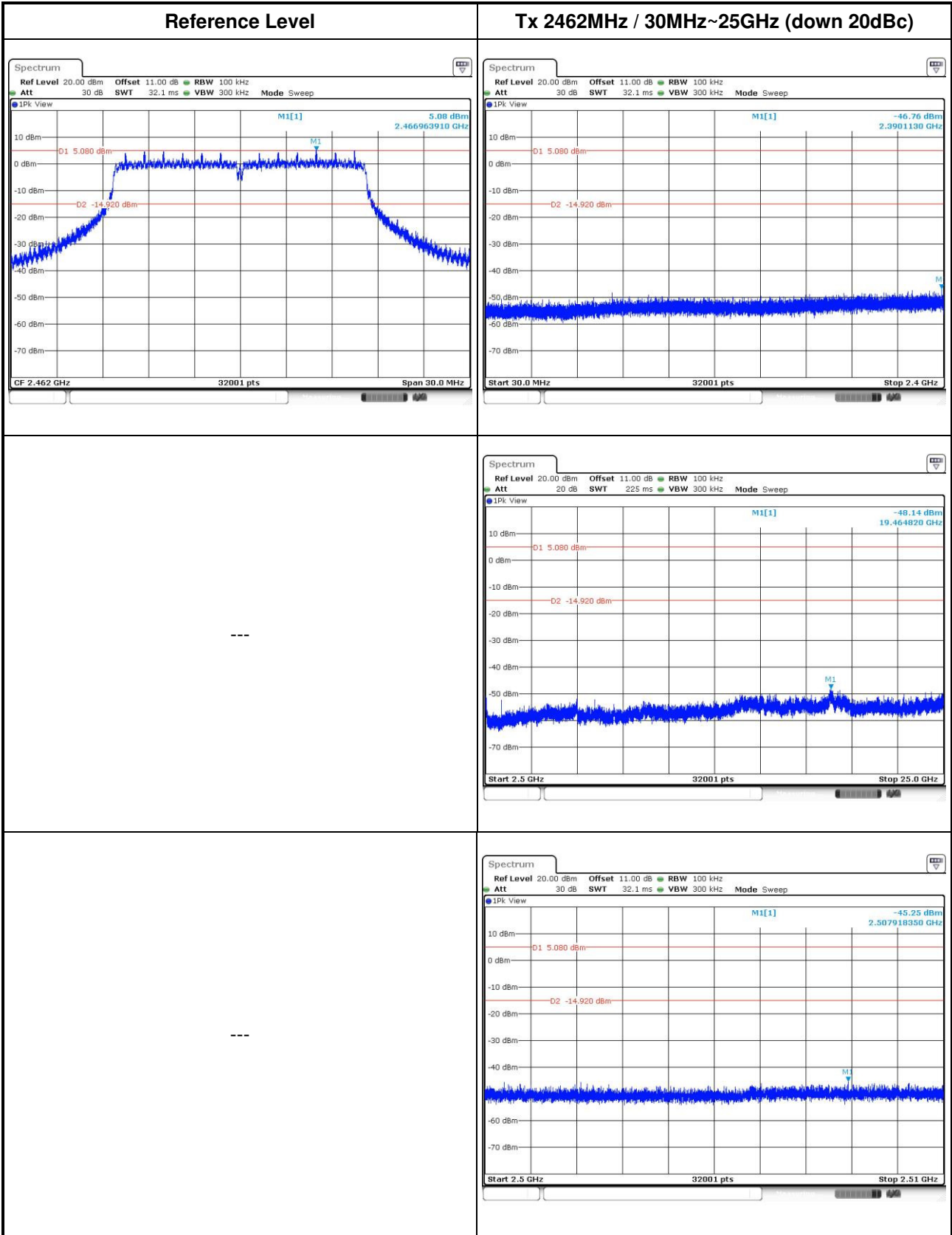

802.11n HT20

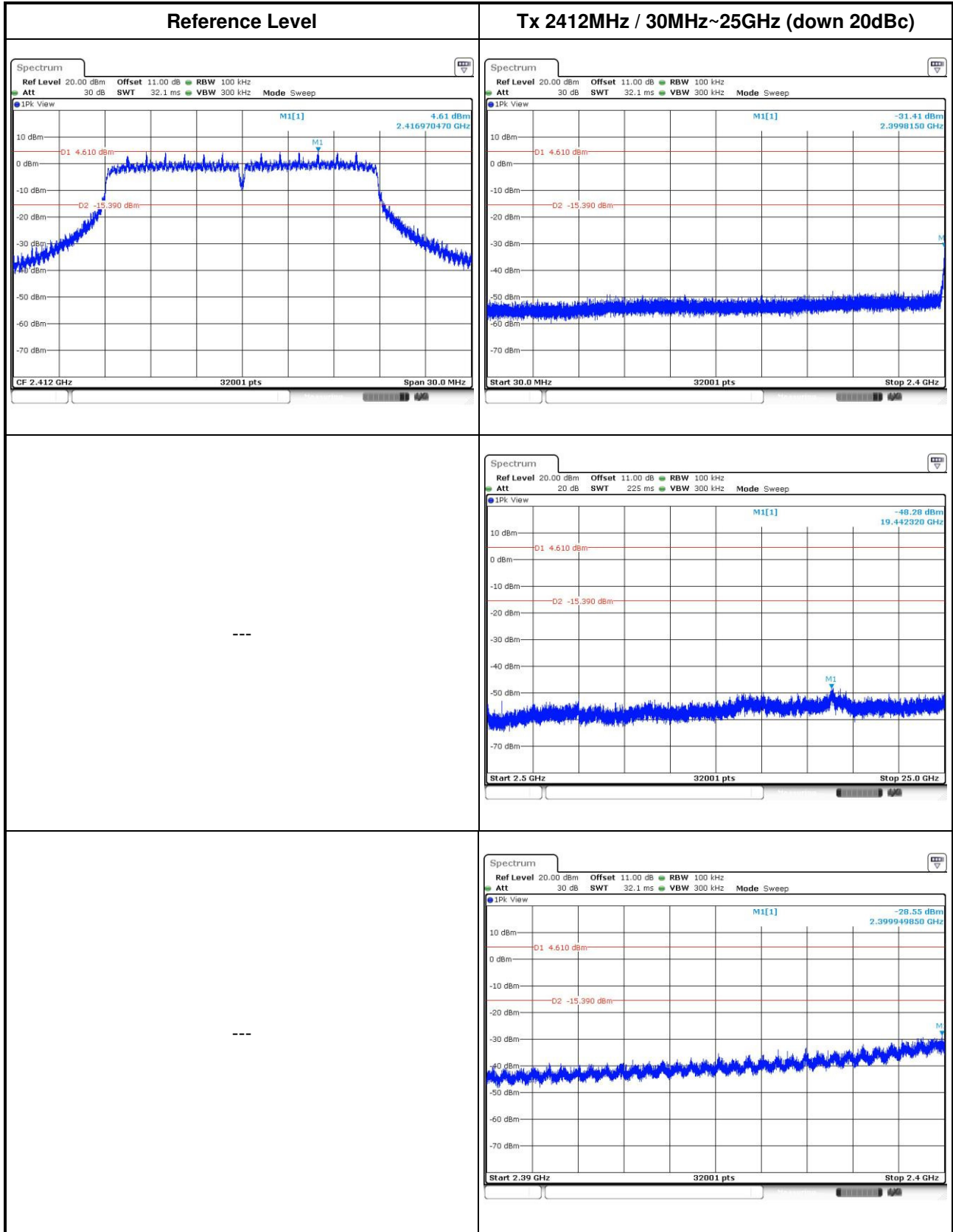

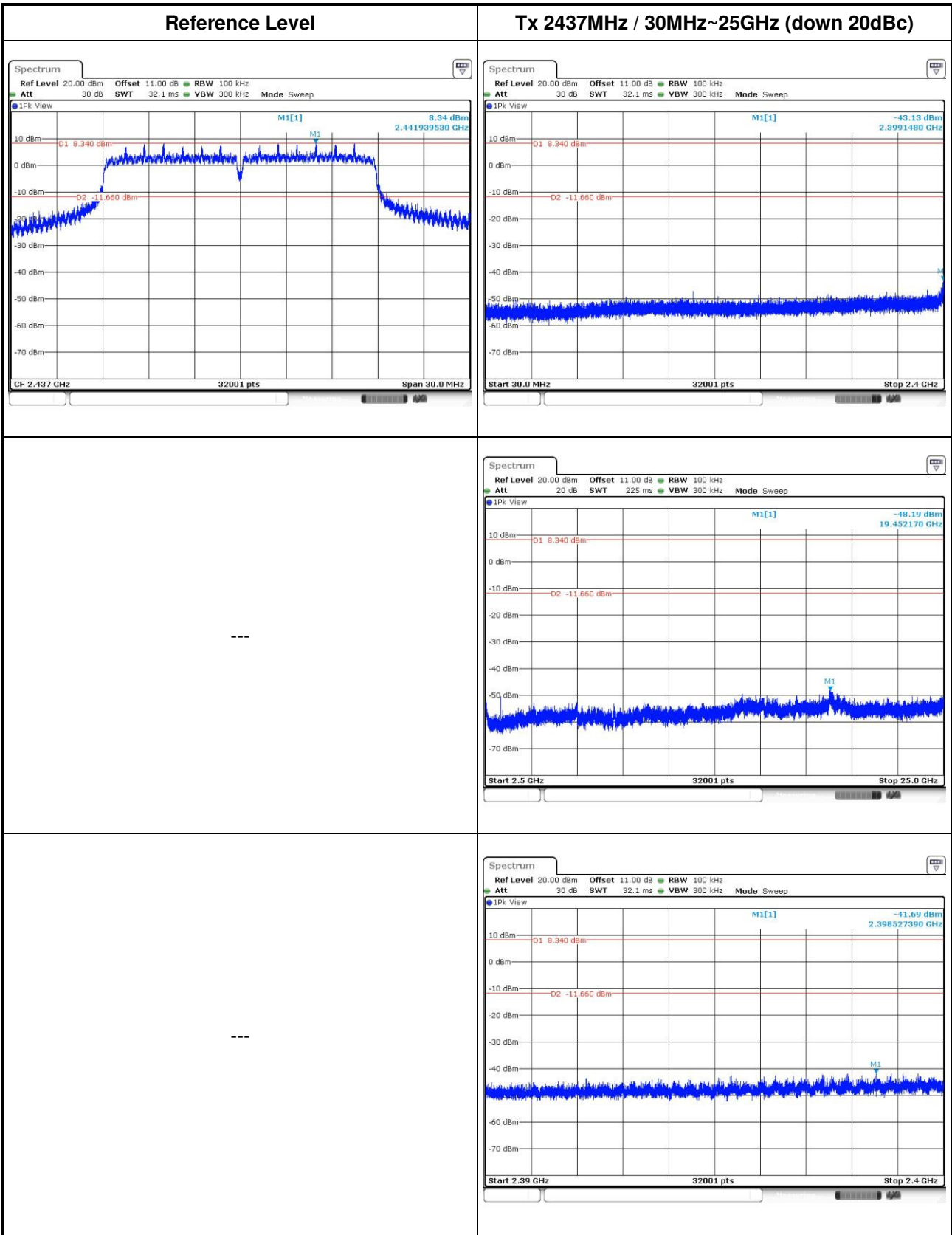

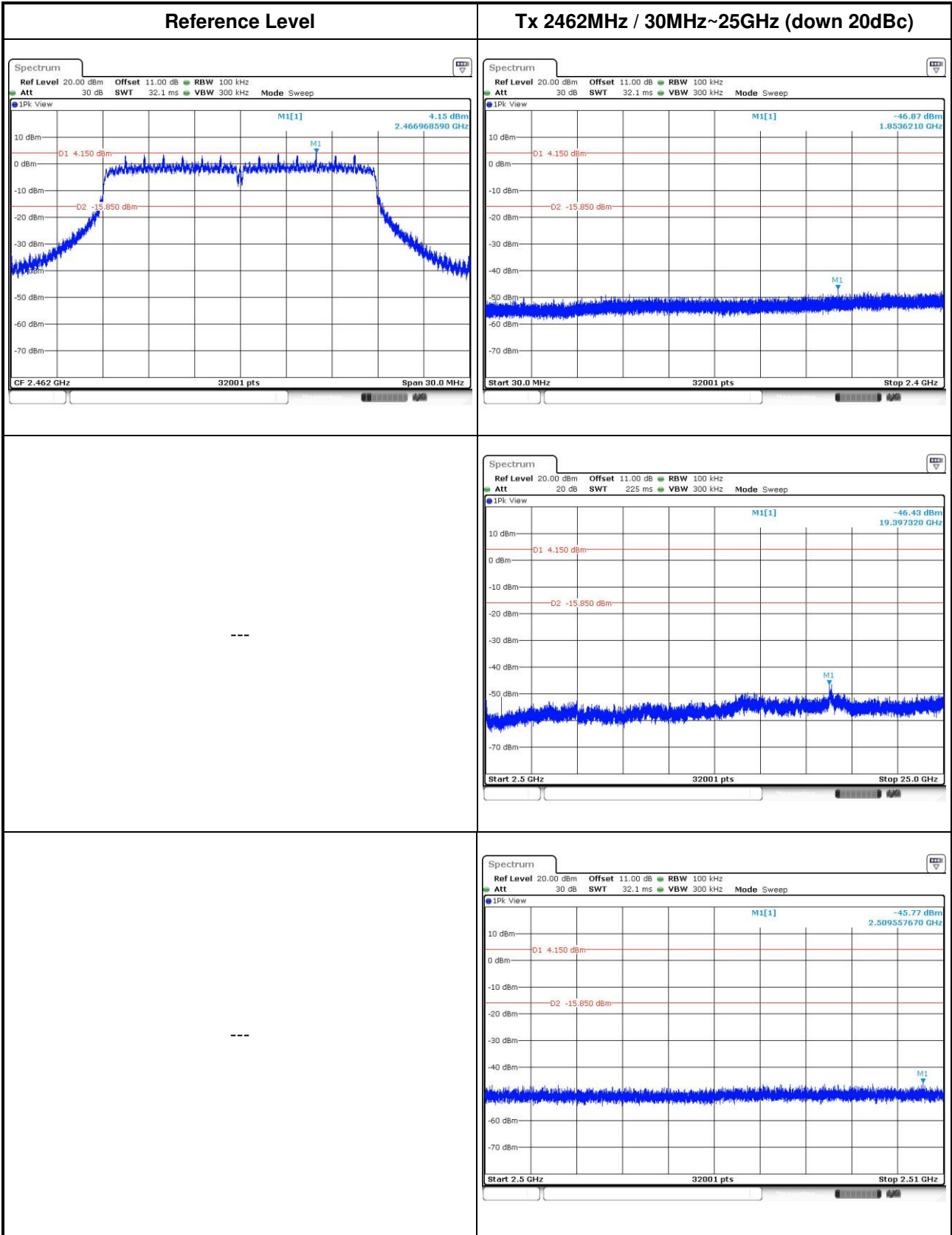

## 4 Test laboratory information

Established in 2012, ICC provides foremost EMC & RF Testing and advisory consultation services by our skilled engineers and technicians. Our services employ a wide variety of advanced edge test equipment and one of the widest certification extents in the business.

International Certification Corp, it is our definitive objective is to institute long term, trust-based associations with our clients. The expectation we set up with our clients is based on outstanding service, practical expertise and devotion to a certified value structure. Our passion is to grant our clients with best EMC / RF services by oriented knowledgeable and accommodating staff.

Our Test sites are located at Linkou District and Kwei Shan Hsiang. Location map can be found on our website <http://www.icertifi.com.tw>.

### **Linkou**

Tel: 886-2-2601-1640

No. 30-2, Ding Fwu Tsuen, Lin Kou  
District, New Taipei City, Taiwan,  
R.O.C.

### **Kwei Shan**

Tel: 886-3-271-8666

No. 3-1, Lane 6, Wen San 3rd  
St., Kwei Shan Hsiang, Tao Yuan  
Hsien 333, Taiwan, R.O.C.

### **Kwei Shan Site II**

Tel: 886-3-271-8640

No. 14-1, Lane 19, Wen San 3rd  
St., Kwei Shan Hsiang, Tao Yuan  
Hsien 333, Taiwan, R.O.C.

If you have any suggestion, please feel free to contact us as below information

Tel: 886-3-271-8666

Fax: 886-3-318-0155

Email: [ICC\\_Service@icertifi.com.tw](mailto:ICC_Service@icertifi.com.tw)

==END==