

FCC C2PC Test Report

FCC ID : SQG-MSD45N
Equipment : 45 Series Pluggable module
Model No. : MSD45N
Brand Name : Laird Connectivity
Applicant : Laird Connectivity LLC
Address : W66N220 Commerce Court, Cedarburg, WI
53012 United States Of America
Standard : 47 CFR FCC Part 15.247
Received Date : Mar. 07, 2022
Tested Date : Mar. 18 ~ Mar. 30, 2022

We, International Certification Corporation, would like to declare that the tested sample has been evaluated and in compliance with the requirement of the above standards. The test results contained in this report refer exclusively to the product. It shall not be reproduced except in full without the written approval of our laboratory.

Reviewed by:

Approved by:

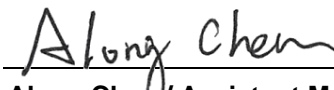

Along Chen / Assistant Manager



Gary Chang / Manager

Table of Contents

1	GENERAL DESCRIPTION	5
1.1	Information.....	5
1.2	Local Support Equipment List	8
1.3	Test Setup Chart	8
1.4	The Equipment List	9
1.5	Test Standards	10
1.6	Reference Guidance	10
1.7	Deviation from Test Standard and Measurement Procedure.....	10
1.8	Measurement Uncertainty	10
2	TEST CONFIGURATION.....	11
2.1	Testing Facility	11
2.2	The Worst Test Modes and Channel Details	11
3	TRANSMITTER TEST RESULTS	12
3.1	Conducted Output Power	12
3.2	Unwanted Emissions into Restricted Frequency Bands	13
3.3	AC Power Line Conducted Emissions	15
4	TEST LABORATORY INFORMATION	16
APPENDIX A. CONDUCTED OUTPUT POWER		
APPENDIX B. UNWANTED EMISSIONS INTO RESTRICTED FREQUENCY BANDS		
APPENDIX C. AC POWER LINE CONDUCTED EMISSIONS		

Release Record

Report No.	Version	Description	Issued Date
FR371704-12AC	Rev. 01	Initial issue	Apr. 20, 2022

Summary of Test Results

FCC Rules	Test Items	Measured	Result
15.207	AC Power Line Conducted Emissions	[dBuV]: 19.326MHz 40.94 (Margin -9.06dB) - AV	Pass
15.247(d) 15.209	Radiated Emissions	[dBuV/m at 3m]: 12060.00MHz 50.71 (Margin -3.29dB) - AV	Pass
15.247(b)(3)	Conducted Output Power	Max Power [dBm]: 22.49	Pass

Declaration of Conformity:

The test results with all measurement uncertainty excluded are presented in accordance with the regulation limits or requirements declared by manufacturers.

Comments and Explanations:

The declared of product specification for EUT presented in the report are provided by the manufacturer, and the manufacturer takes all the responsibilities for the accuracy of product specification.

1 General Description

1.1 Information

This report is prepared for FCC class II permissive change.

This report is issued as a supplementary report to original ICC report no. FR371704-09AC. The modification is concerned with following:

- ✧ New applicant name & address.
- ✧ Adding 2nd source of Power Amplifier, Diplexer
- ✧ RF Shielding Can changed.

Therefore, related test items had been performed and presented in the following sections.

1.1.1 Specification of the Equipment under Test (EUT)

RF General Information					
Frequency Range (MHz)	IEEE Std. 802.11	Ch. Freq. (MHz)	Channel Number	Transmit Chains (N _{TX})	Data Rate / MCS
2400-2483.5	b	2412-2462	1-11 [11]	1	1-11 Mbps
2400-2483.5	g	2412-2462	1-11 [11]	1	6-54 Mbps
2400-2483.5	n (HT20)	2412-2462	1-11 [11]	1	MCS 0-7

Note 1: RF output power specifies that Maximum Peak Conducted Output Power.
 Note 2: 802.11b uses a combination of DSSS-DBPSK, DQPSK, CCK modulation.
 Note 3: 802.11g/n uses a combination of OFDM-BPSK, QPSK, 16QAM, 64QAM modulation.

1.1.2 Antenna Details

Ant. No.	Brand / Model	Type	Connector	Operating Frequencies (MHz) / Antenna Gain (dBi)				
				2400~2483.5	5150~5250	5250~5350	5470~5725	5725~5850
1	MAG.LAYERS/EDA-15 13-25GR2-B2-CY	Dipole	SMA Jack Reverse	2	2	2	2	2
2	MAG.LAYERS/PCA-46 06-2G4C1-A13-CY	PCB Dipole	UFL	2.21	---	---	---	---
3	Laird/NanoBlade-IP04	PCB Dipole	UFL	2	3.9	3.9	4	4
4	Laird/MAF95310 Mini NanoBlade Flex	PCB Dipole	UFL	2.79	3.38	3.38	3.38	3.38
5	Laird/NanoBlue-IP04	PCB Dipole	UFL	2	---	---	---	---
6	Ethertronics/WLAN_10 00146	PIFA	UFL	2.5	3.5	3.5	3.5	3.5
7	SAA / MG7018-41-000-R	Dipole	UFL	1.87	0.85	0.6	0.94	0.92
8	SAA / MG7324-41-000-R	Dipole	UFL	1.32	1.04	1.6	2.75	2.24
9	EMF2449A1-33UFL	PCB Dipole	UFL	0.8	3.3	3.3	3.3	3.3

Note: The antennas with highest gain of each type were selected for final testing in this test report

1.1.3 Power Supply Type of Equipment under Test (EUT)

Power Supply Type	3.3Vdc from power supply
--------------------------	--------------------------

1.1.4 Accessories

N/A

1.1.5 Channel List

Channel	Frequency(MHz)
1	2412
2	2417
3	2422
4	2427
5	2432
6	2437
7	2442
8	2447
9	2452
10	2457
11	2462

1.1.6 Test Tool and Duty Cycle

Test Tool	Terminal, Version: 2.32.1		
Duty Cycle and Duty Factor	Mode	Duty Cycle (%)	Duty Factor (dB)
	11b	100.00	0.00
	11g	98.95	0.05
	HT20	99.25	0.03

1.1.7 Power Index of Test Tool

Modulation Mode	Test Frequency (MHz)	Power Index
11b	2412	16
11b	2437	17
11b	2462	14
11g	2412	14
11g	2437	18.5
11g	2462	12.5
HT20	2412	13.5
HT20	2437	18.5
HT20	2462	13

1.2 Local Support Equipment List

Support Equipment List					
No.	Equipment	Brand	Model	FCC ID	Remarks
1	DC Power Supply	GWINSTEK	GPC-3060D	---	---
2	Notebook	Lenovo	X61	---	Provided by applicant.
3	Fixture	---	---	---	Provided by applicant.

1.3 Test Setup Chart

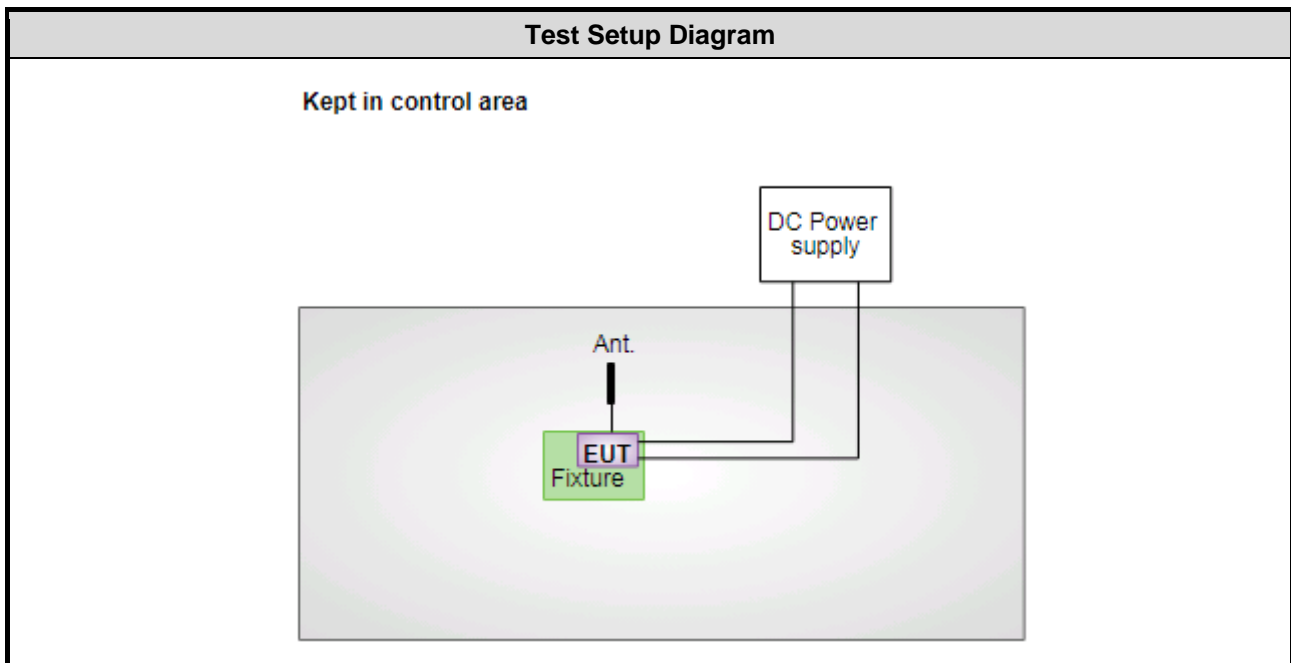

Note: The notebook is disconnected from EUT and removed from test table when EUT is set to transmit continuously.

1.4 The Equipment List

Test Item	Conducted Emission				
Test Site	Conduction room 1 / (CO01-WS)				
Tested Date	Mar. 30, 2022				
Instrument	Brand	Model No.	Serial No.	Calibration Date	Calibration Until
Receiver	R&S	ESR3	101658	Feb. 16, 2022	Feb. 15, 2023
LISN	R&S	ENV216	101295	Jan. 12, 2022	Jan. 11, 2023
LISN (Support Unit)	SCHWARZBECK	NSLK 8127	8127667	Jan. 07, 2022	Jan. 06, 2023
RF Cable-CON	Woken	CFD200-NL	CFD200-NL-001	Oct. 19, 2021	Oct. 18, 2022
50 ohm terminal (Support Unit)	NA	50	04	May 25, 2021	May 24, 2022
Measurement Software	AUDIX	e3	6.120210k	NA	NA

Note: Calibration Interval of instruments listed above is one year.

Test Item	Radiated Emission				
Test Site	966 chamber3 / (03CH03-WS)				
Tested Date	Mar. 18 ~ Mar. 21, 2022				
Instrument	Brand	Model No.	Serial No.	Calibration Date	Calibration Until
Receiver	R&S	ESR3	101657	Mar. 15, 2022	Mar. 14, 2023
Spectrum Analyzer	R&S	FSV40	101499	Mar. 08, 2022	Mar. 07, 2023
Loop Antenna	R&S	HFH2-Z2	100330	Nov. 08, 2021	Nov. 07, 2022
Bilog Antenna	SCHWARZBECK	VULB9168	VULB9168-685	May 06, 2021	May 05, 2022
Horn Antenna 1G-18G	SCHWARZBECK	BBHA 9120 D	BBHA 9120 D 1206	Dec. 20, 2021	Dec. 19, 2022
Horn Antenna 18G-40G	SCHWARZBECK	BBHA 9170	BBHA 9170508	Jan. 11, 2022	Jan. 10, 2023
Preamplifier	EMC	EMC02325	980187	Jul. 26, 2021	Jul. 25, 2022
Preamplifier	Agilent	83017A	MY39501309	Sep. 06, 2021	Sep. 05, 2022
Preamplifier	EMC	EMC184045B	980192	Jul. 14, 2021	Jul. 13, 2022
Loop Antenna Cable	KOAX KABEL	101354-BW	101354-BW	Oct. 05, 2021	Oct. 04, 2022
LF cable-0.8M	EMC	EMC8D-NM-NM-800	EMC8D-NM-NM-800-001	Sep. 24, 2021	Sep. 23, 2022
LF cable-3M	EMC	EMC8D-NM-NM-3000	131103	Sep. 24, 2021	Sep. 23, 2022
LF cable-13M	EMC	EMC8D-NM-NM-13000	131104	Sep. 24, 2021	Sep. 23, 2022
RF cable-3M	HUBER+SUHNER	SUCOFLEX104	MY22620/4	Sep. 24, 2021	Sep. 23, 2022
RF cable-8M	EMC	EMC104-SM-SM-8000	181107	Sep. 24, 2021	Sep. 23, 2022

Note: Calibration Interval of instruments listed above is one year.

Test Item	RF Conducted				
Test Site	(TH01-WS)				
Tested Date	Mar. 23, 2022				
Instrument	Brand	Model No.	Serial No.	Calibration Date	Calibration Until
Spectrum Analyzer	R&S	FSV40	101498	Nov. 29, 2021	Nov. 28, 2022
Power Meter	Anritsu	ML2495A	1241002	Nov. 07, 2021	Nov. 06, 2022
Power Sensor	Anritsu	MA2411B	1207366	Nov. 07, 2021	Nov. 06, 2022
Measurement Software	Sporton	SENSE-15247_DTS	V5.10	NA	NA
Note: Calibration Interval of instruments listed above is one year.					

1.5 Test Standards

47 CFR FCC Part 15.247
ANSI C63.10-2013

1.6 Reference Guidance

FCC KDB 558074 D01 15.247 Meas Guidance v05r02

1.7 Deviation from Test Standard and Measurement Procedure

None

1.8 Measurement Uncertainty

The measurement uncertainties given below are based on a 95% confidence level (based on a coverage factor ($k=2$)).

Measurement Uncertainty	
Parameters	Uncertainty
Bandwidth	± 34.130 Hz
Conducted power	± 0.808 dB
Power density	± 0.583 dB
Conducted emission	± 2.715 dB
AC conducted emission	± 2.92 dB
Radiated emission ≤ 1 GHz	± 3.96 dB
Radiated emission > 1 GHz	± 4.51 dB

2 Test Configuration

2.1 Testing Facility

Test Laboratory	International Certification Corporation
Test Site	CO01-WS, TH01-WS
Address of Test Site	No.3-1, Lane 6, Wen San 3rd St., Kwei Shan Dist., Tao Yuan City 33381, Taiwan (R.O.C.)
Test Site	03CH03-WS
Address of Test Site	No.14-1, Lane 19, Wen San 3rd St., Kwei Shan Dist., Tao Yuan City 333, Taiwan (R.O.C.)

- FCC Designation No.: TW0009
- FCC site registration No.: 207696
- ISED#: 10807C
- CAB identifier: TW2732

2.2 The Worst Test Modes and Channel Details

Test item	Modulation Mode	Test Frequency (MHz)	Data Rate	Test Configuration
AC Power Line Conducted Emissions	HT20	2437	MCS 0	2
Radiated Emissions ≤1GHz	HT20	2437	MCS 0	1, 2, 3
Conducted Output Power	11b 11g HT20	2412 / 2437 / 2462 2412 / 2437 / 2462 2412 / 2437 / 2462	1 Mbps 6 Mbps MCS 0	2
Radiated Emissions >1GHz	11b	2412	1 Mbps	1, 2
	HT20	2412	MCS 0	3

NOTE:

1. 3 types antenna are used for this device, highest gain antenna of each type is selected to perform radiated emission test as below test configuration
 - 1) Configuration 1 : Dipole antenna (Antenna No.1) , Y-plane
 - 2) Configuration 2 : PCB Dipole antenna (Antenna No.4) , Y-plane
 - 3) Configuration 3 : PIFA antenna (Antenna No.6), Y-plane

3 Transmitter Test Results

3.1 Conducted Output Power

3.1.1 Limit of Conducted Output Power

Conducted power shall not exceed 1Watt.

Antenna gain \leq 6dBi, no any corresponding reduction is in output power limit.

Antenna gain $>$ 6dBi

Non Fixed, point to point operations.

The conducted output power from the intentional radiator shall be reduced by the amount in dB that the directional gain of the antenna exceeds 6 dB

Fixed, point to point operations

Systems operating in the 2400–2483.5 MHz band that are used exclusively for fixed, point-to-point Operations, maximum peak output power of the intentional radiator is reduced by 1 dB for every 3 dB that the directional gain of the antenna exceeds 6 dBi.

3.1.2 Test Procedures

A broadband RF power meter is used for output power measurement. The video bandwidth of power meter is greater than DTS bandwidth of EUT. If duty cycle of test signal is not 100 %, trigger and gating function of power meter will be enabled to capture transmission burst for measuring output power.

3.1.3 Test Setup

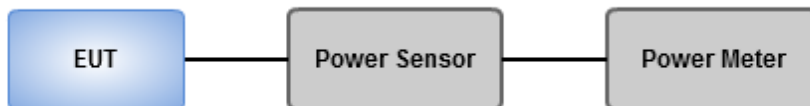

3.1.4 Test Result of Maximum Output Power

Ambient Condition	22 °C / 66 %	Tested By	Brad Wu
--------------------------	--------------	------------------	---------

Refer to Appendix A

3.2 Unwanted Emissions into Restricted Frequency Bands

3.2.1 Limit of Unwanted Emissions into Restricted Frequency Bands

Restricted Band Emissions Limit			
Frequency Range (MHz)	Field Strength (uV/m)	Field Strength (dBuV/m)	Measure Distance (m)
0.009~0.490	2400/F(kHz)	48.5 - 13.8	300
0.490~1.705	24000/F(kHz)	33.8 - 23	30
1.705~30.0	30	29	30
30~88	100	40	3
88~216	150	43.5	3
216~960	200	46	3
Above 960	500	54	3

Note 1:
Qusai-Peak value is measured for frequency below 1GHz except for 9–90 kHz, 110–490 kHz frequency band. Peak and average value are measured for frequency above 1GHz. The limit on average radio frequency emission is as above table. The limit on peak radio frequency emissions is 20 dB above the maximum permitted average emission limit

Note 2:
Measurements may be performed at a distance other than what is specified provided. When performing measurements at a distance other than that specified, the results shall be extrapolated to the specified distance using an extrapolation factor as below, Frequency at or above 30 MHz: 20 dB/decade Frequency below 30 MHz: 40 dB/decade.

3.2.2 Test Procedures

1. Measurement is made at a semi-anechoic chamber that incorporates a turntable allowing a EUT rotation of 360°. A continuously-rotating, remotely-controlled turntable is installed at the test site to support the EUT and facilitate determination of the direction of maximum radiation for each EUT emission frequency. The EUT is placed at test table. For emissions testing at or below 1 GHz, the table height is 80 cm above the reference ground plane. For emission measurements above 1 GHz, the table height is 1.5 m
2. Measurement is made with the antenna positioned in both the horizontal and vertical planes of polarization. The measurement antenna is varied in height (1m ~ 4m) above the reference ground plane to obtain the maximum signal strength. Distance between EUT and antenna is 3 m.
3. This investigation is performed with the EUT rotated 360°, the antenna height scanned between 1 m and 4 m, and the antenna rotated to repeat the measurements for both the horizontal and vertical antenna polarizations.

Note:

1. 120kHz measurement bandwidth of test receiver and Quasi-peak detector is for radiated emission below 1GHz.
2. RBW=1MHz, VBW=3MHz and Peak detector is for peak measured value of radiated emission above 1GHz.
3. RBW=1MHz, VBW=1/T and Peak detector is for average measured value of radiated emission above 1GHz.

3.2.3 Test Setup

Radiated Emissions below 1 GHz

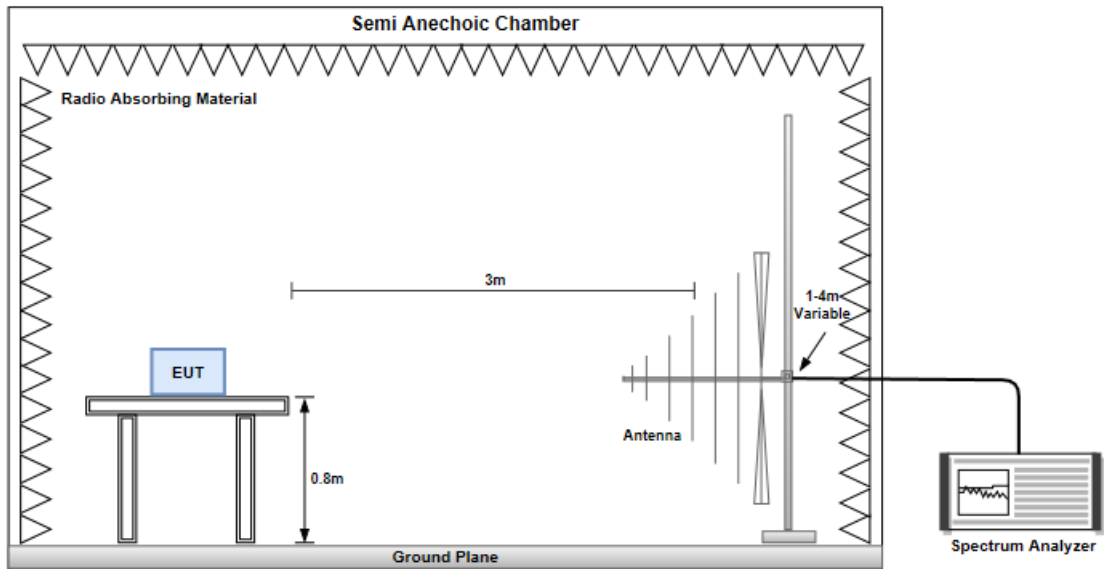

Radiated Emissions above 1 GHz

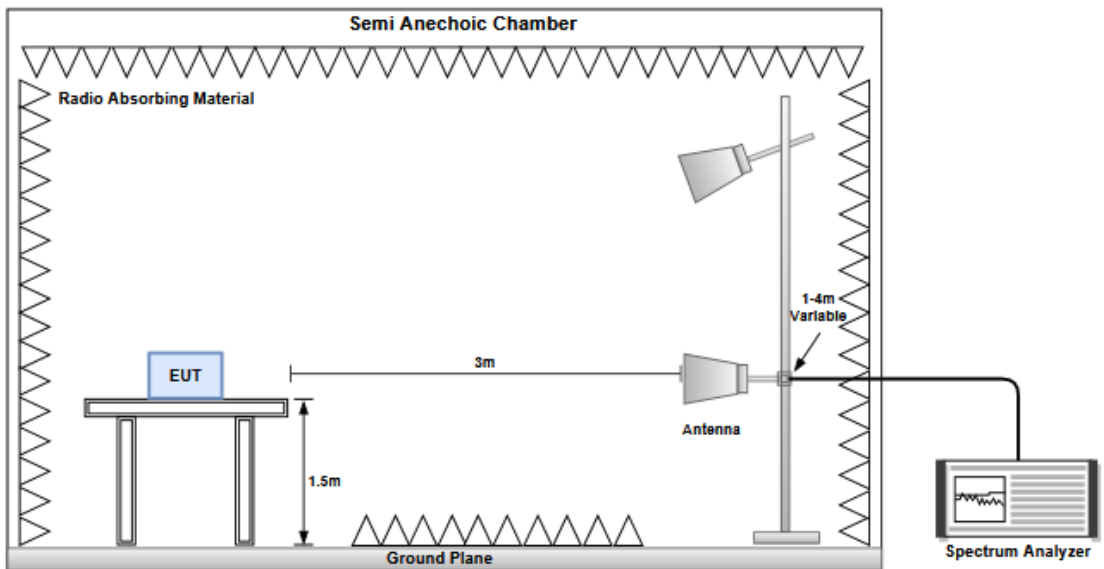

3.2.4 Test Results

Refer to Appendix B.

3.3 AC Power Line Conducted Emissions

3.3.1 Limit of AC Power Line Conducted Emissions

Conducted Emissions Limit		
Frequency Emission (MHz)	Quasi-Peak	Average
0.15-0.5	66 - 56 *	56 - 46 *
0.5-5	56	46
5-30	60	50

Note 1: * Decreases with the logarithm of the frequency.

3.3.2 Test Procedures

1. The device is placed on a test table, raised 80 cm above the reference ground plane. The vertical conducting plane is located 40 cm to the rear of the device.
2. The device is connected to line impedance stabilization network (LISN) and other accessories are connected to other LISN. Measured levels of AC power line conducted emission are across the 50 Ω LISN port.
3. AC conducted emission measurements is made over frequency range from 150 kHz to 30 MHz.
4. This measurement was performed with AC 120V / 60Hz.

3.3.3 Test Setup

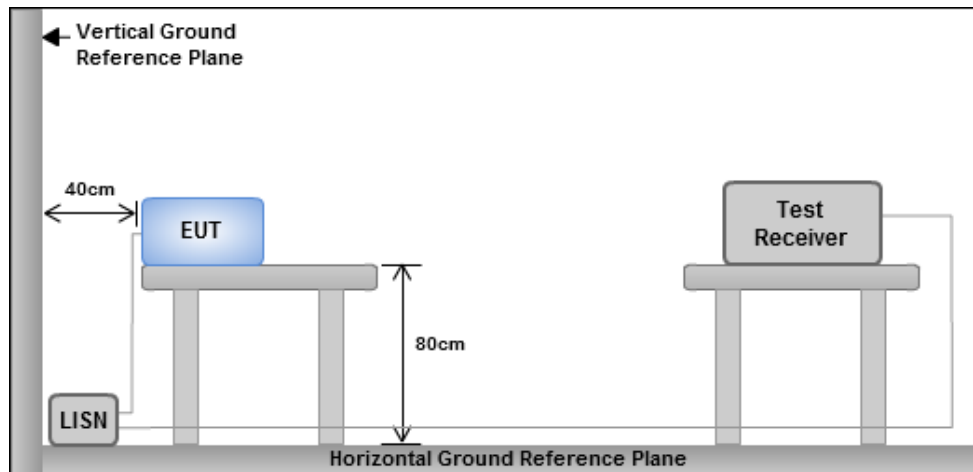

- Note: 1. Support units were connected to second LISN.
2. Both of LISNs (AMN) are 80 cm from EUT and at least 80 cm from other units and other metal planes

3.3.4 Test Results

Refer to Appendix C.

4 Test laboratory information

Established in 2012, ICC provides foremost EMC & RF Testing and advisory consultation services by our skilled engineers and technicians. Our services employ a wide variety of advanced edge test equipment and one of the widest certification extents in the business.

International Certification Corporation (EMC and Wireless Communication Laboratory), it is our definitive objective is to institute long term, trust-based associations with our clients. The expectation we set up with our clients is based on outstanding service, practical expertise and devotion to a certified value structure. Our passion is to grant our clients with best EMC / RF services by oriented knowledgeable and accommodating staff.

Our Test sites are located at Linkou District and Kwei Shan District. Location map can be found on our website <http://www.icertifi.com.tw>.

Linkou

Tel: 886-2-2601-1640

No.30-2, Ding Fwu Tsuen, Lin Kou
District, New Taipei City, Taiwan
(R.O.C.)

Kwei Shan

Tel: 886-3-271-8666

No.3-1, Lane 6, Wen San 3rd
St., Kwei Shan Dist., Tao Yuan
City 33381, Taiwan (R.O.C.)
No.2-1, Lane 6, Wen San 3rd
St., Kwei Shan Dist., Tao Yuan
City 33381, Taiwan (R.O.C.)

Kwei Shan Site II

Tel: 886-3-271-8640

No.14-1, Lane 19, Wen San 3rd
St., Kwei Shan Dist., Tao Yuan
City 333, Taiwan (R.O.C.)

If you have any suggestion, please feel free to contact us as below information.

Tel: 886-3-271-8666

Fax: 886-3-318-0345

Email: ICC_Service@icertifi.com.tw

==END==



Conducted Output Power (AVERAGE)

Appendix A

Summary

Mode	Total Power (dBm)	Total Power (W)
2.4-2.4835GHz	-	-
802.11b_Nss1,(1Mbps)_1TX	16.49	0.04457
802.11g_Nss1,(6Mbps)_1TX	17.93	0.06209
802.11n HT20_Nss1,(MCS0)_1TX	18.15	0.06531

Result

Mode	Result	DG (dBi)	Port 1 (dBm)	Total Power (dBm)	Power Limit (dBm)	EIRP (dBm)	EIRP Limit (dBm)
802.11b_Nss1,(1Mbps)_1TX	-	-	-	-	-	-	-
2412MHz	Pass	2.79	15.76	15.76	-	18.55	-
2437MHz	Pass	2.79	16.49	16.49	-	19.28	-
2462MHz	Pass	2.79	13.42	13.42	-	16.21	-
802.11g_Nss1,(6Mbps)_1TX	-	-	-	-	-	-	-
2412MHz	Pass	2.79	13.51	13.51	-	16.30	-
2437MHz	Pass	2.79	17.93	17.93	-	20.72	-
2462MHz	Pass	2.79	11.79	11.79	-	14.58	-
802.11n HT20_Nss1,(MCS0)_1TX	-	-	-	-	-	-	-
2412MHz	Pass	2.79	12.82	12.82	-	15.61	-
2437MHz	Pass	2.79	18.15	18.15	-	20.94	-
2462MHz	Pass	2.79	12.18	12.18	-	14.97	-

DG = Directional Gain; Port X = Port X output power

Note : Conducted average output power is for reference only



CONDUCTED OUTPUT POWER (PEAK)

Appendix A

Summary

Mode	Total Power (dBm)	Total Power (W)
2.4-2.4835GHz	-	-
802.11b_Nss1,(1Mbps)_1TX	18.75	0.07499
802.11g_Nss1,(6Mbps)_1TX	21.86	0.15346
802.11n HT20_Nss1,(MCS0)_1TX	22.49	0.17742

Result

Mode	Result	DG (dBi)	Port 1 (dBm)	Total Power (dBm)	Power Limit (dBm)	EIRP (dBm)	EIRP Limit (dBm)
802.11b_Nss1,(1Mbps)_1TX	-	-	-	-	-	-	-
2412MHz	Pass	2.79	17.81	17.81	30.00	20.60	36.00
2437MHz	Pass	2.79	18.75	18.75	30.00	21.54	36.00
2462MHz	Pass	2.79	15.51	15.51	30.00	18.30	36.00
802.11g_Nss1,(6Mbps)_1TX	-	-	-	-	-	-	-
2412MHz	Pass	2.79	20.85	20.85	30.00	23.64	36.00
2437MHz	Pass	2.79	21.86	21.86	30.00	24.65	36.00
2462MHz	Pass	2.79	18.65	18.65	30.00	21.44	36.00
802.11n HT20_Nss1,(MCS0)_1TX	-	-	-	-	-	-	-
2412MHz	Pass	2.79	20.28	20.28	30.00	23.07	36.00
2437MHz	Pass	2.79	22.49	22.49	30.00	25.28	36.00
2462MHz	Pass	2.79	18.82	18.82	30.00	21.61	36.00

DG = Directional Gain; **Port X** = Port X output power



Configuration 1 : Dipole antenna (Antenna No.1) , Y-plane

Transmitter Radiated Unwanted Emissions (Below 1GHz)

Modulation	HT20	Test Freq. (MHz)	2437						
Polarization	Horizontal								
Test By :Brad Wu Temperature(°C):23 Humidity(%):64									
	Freq. MHz	Emission level dBuV/m	Limit dBuV/m	Margin dB	SA reading dBuV	Factor dB/m	Remark	ANT High cm	Turn Table deg
1	38.73	22.15	40.00	-17.85	31.48	-9.33	Peak	---	---
2	66.86	20.97	40.00	-19.03	31.42	-10.45	Peak	---	---
3	163.86	21.39	43.50	-22.11	29.97	-8.58	Peak	---	---
4	268.62	21.83	46.00	-24.17	30.96	-9.13	Peak	---	---
5	446.13	25.36	46.00	-20.64	29.21	-3.85	Peak	---	---
6	468.44	29.51	46.00	-16.49	32.81	-3.30	Peak	---	---

Note 1: Emission Level (dBuV/m) = SA Reading (dBuV) + Factor* (dB/m)
 *Factor includes antenna factor , cable loss and amplifier gain
 Note 2: Margin (dB) = Emission level (dBuV/m) – Limit (dBuV/m).
 Note 3: All spurious emissions below 30MHz are more than 20 dB below the limit.



Modulation	HT20	Test Freq. (MHz)	2437
Polarization	Vertical		

Test By :Brad Wu Temperature(°C):23 Humidity(%):64

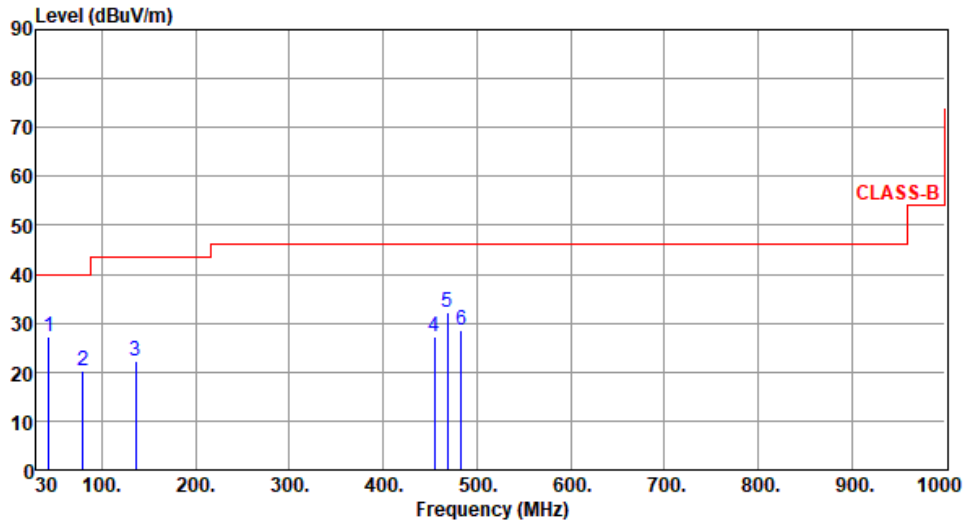

	Freq. MHz	Emission level dBuV/m	Limit dBuV/m	Margin dB	SA reading dBuV	Factor dB/m	Remark	ANT High cm	Turn Table deg
1	43.58	27.18	40.00	-12.82	36.17	-8.99	Peak	---	---
2	79.47	20.12	40.00	-19.88	33.33	-13.21	Peak	---	---
3	135.73	22.20	43.50	-21.30	31.51	-9.31	Peak	---	---
4	454.86	27.37	46.00	-18.63	30.97	-3.60	Peak	---	---
5	468.44	32.14	46.00	-13.86	35.44	-3.30	Peak	---	---
6	482.99	28.72	46.00	-17.28	31.80	-3.08	Peak	---	---

Note 1: Emission Level (dBuV/m) = SA Reading (dBuV) + Factor* (dB/m)
 *Factor includes antenna factor , cable loss and amplifier gain
 Note 2: Margin (dB) = Emission level (dBuV/m) – Limit (dBuV/m).
 Note 3: All spurious emissions below 30MHz are more than 20 dB below the limit.



Transmitter Radiated Unwanted Emissions (Above 1GHz)

Modulation	11b	Test Freq. (MHz)	2412						
Polarization	Horizontal								
Test By : Roger Lu Temperature(°C):22 Humidity(%):66									
	Freq. MHz	Emission level dBuV/m	Limit dBuV/m	Margin dB	SA reading dBuV	Factor dB/m	Remark	ANT High cm	Turn Table deg
1	2390.00	37.40	54.00	-16.60	38.89	-1.49	Average	251	178
2	2390.00	51.04	74.00	-22.96	52.53	-1.49	Peak	251	178
3	4824.00	39.15	54.00	-14.85	33.88	5.27	Average	296	164
4	4824.00	46.80	74.00	-27.20	41.53	5.27	Peak	296	164
5	12060.00	47.68	54.00	-6.32	32.72	14.96	Average	282	73
6	12060.00	59.70	74.00	-14.30	44.74	14.96	Peak	282	73
Note 1: Emission Level (dBuV/m) = SA Reading (dBuV) + Factor* (dB/m) *Factor includes antenna factor , cable loss and amplifier gain Note 2: Margin (dB) = Emission level (dBuV/m) – Limit (dBuV/m).									



Modulation	11b	Test Freq. (MHz)	2412
Polarization	Vertical		

Test By : Roger Lu Temperature(°C):22 Humidity(%):66

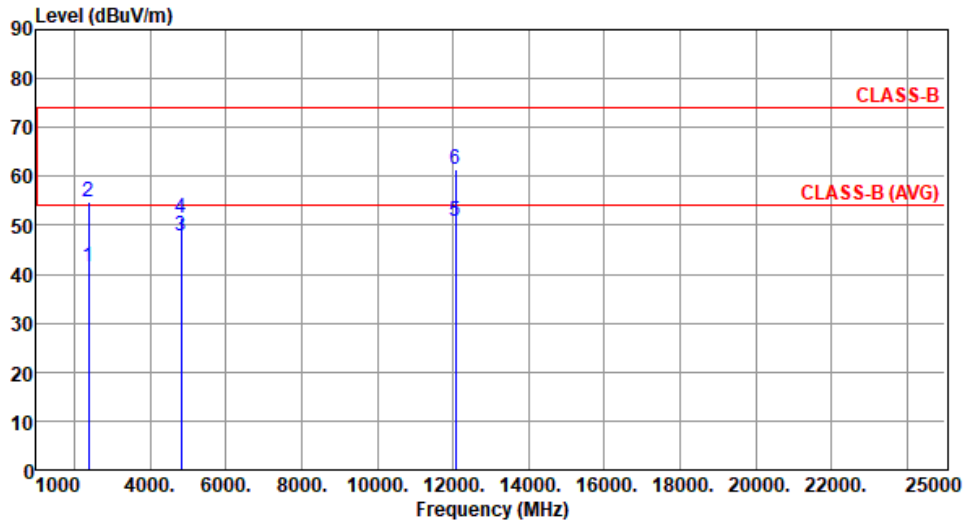

	Freq. MHz	Emission level dBuV/m	Limit dBuV/m	Margin dB	SA reading dBuV	Factor dB/m	Remark	ANT High cm	Turn Table deg
1	2390.00	41.40	54.00	-12.60	42.89	-1.49	Average	233	272
2	2390.00	54.69	74.00	-19.31	56.18	-1.49	Peak	233	272
3	4824.00	47.71	54.00	-6.29	42.44	5.27	Average	259	274
4	4824.00	51.34	74.00	-22.66	46.07	5.27	Peak	259	274
5	12060.00	50.71	54.00	-3.29	35.75	14.96	Average	236	9
6	12060.00	61.34	74.00	-12.66	46.38	14.96	Peak	236	9

Note 1: Emission Level (dBuV/m) = SA Reading (dBuV) + Factor* (dB/m)

*Factor includes antenna factor , cable loss and amplifier gain

Note 2: Margin (dB) = Emission level (dBuV/m) – Limit (dBuV/m).



Configuration 2 : PCB Dipole antenna (Antenna No.4) , Y-plane

Transmitter Radiated Unwanted Emissions (Below 1GHz)

Modulation	HT20	Test Freq. (MHz)	2437						
Polarization	Horizontal								
Test By :Brad Wu Temperature(°C):23 Humidity(%):64									
	Freq. MHz	Emission level dBuV/m	Limit dBuV/m	Margin dB	SA reading dBuV	Factor dB/m	Remark	ANT High cm	Turn Table deg
1	38.73	20.88	40.00	-19.12	30.21	-9.33	Peak	---	---
2	143.49	21.06	43.50	-22.44	29.86	-8.80	Peak	---	---
3	279.29	21.96	46.00	-24.04	30.58	-8.62	Peak	---	---
4	377.26	23.62	46.00	-22.38	29.76	-6.14	Peak	---	---
5	468.44	29.06	46.00	-16.94	32.36	-3.30	Peak	---	---
6	482.99	27.40	46.00	-18.60	30.48	-3.08	Peak	---	---

Note 1: Emission Level (dBuV/m) = SA Reading (dBuV) + Factor* (dB/m)
 *Factor includes antenna factor , cable loss and amplifier gain
 Note 2: Margin (dB) = Emission level (dBuV/m) – Limit (dBuV/m).
 Note 3: All spurious emissions below 30MHz are more than 20 dB below the limit.



Modulation	HT20	Test Freq. (MHz)	2437
Polarization	Vertical		

Test By :Brad Wu Temperature(°C):23 Humidity(%):64

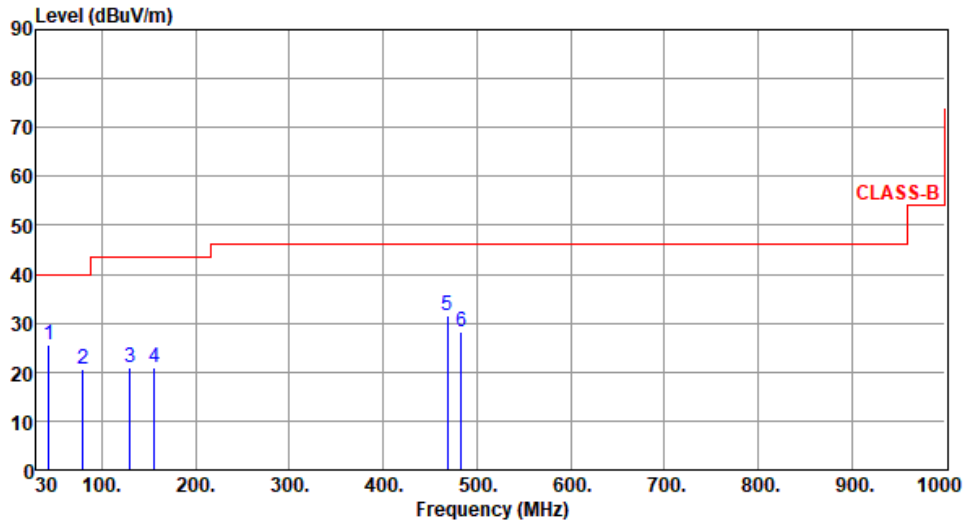

	Freq. MHz	Emission level dBuV/m	Limit dBuV/m	Margin dB	SA reading dBuV	Factor dB/m	Remark	ANT High cm	Turn Table deg
1	43.58	25.68	40.00	-14.32	34.67	-8.99	Peak	---	---
2	79.47	20.71	40.00	-19.29	33.92	-13.21	Peak	---	---
3	129.91	20.87	43.50	-22.63	30.70	-9.83	Peak	---	---
4	156.10	21.07	43.50	-22.43	29.57	-8.50	Peak	---	---
5	468.44	31.52	46.00	-14.48	34.82	-3.30	Peak	---	---
6	482.99	28.19	46.00	-17.81	31.27	-3.08	Peak	---	---

Note 1: Emission Level (dBuV/m) = SA Reading (dBuV) + Factor* (dB/m)
 *Factor includes antenna factor , cable loss and amplifier gain
 Note 2: Margin (dB) = Emission level (dBuV/m) – Limit (dBuV/m).
 Note 3: All spurious emissions below 30MHz are more than 20 dB below the limit.



Transmitter Radiated Unwanted Emissions (Above 1GHz)

Modulation	11b	Test Freq. (MHz)	2437						
Polarization	Horizontal								
Test By : Roger Lu Temperature(°C):22 Humidity(%):66									
	Freq. MHz	Emission level dBuV/m	Limit dBuV/m	Margin dB	SA reading dBuV	Factor dB/m	Remark	ANT High cm	Turn Table deg
1	2390.00	38.15	54.00	-15.85	39.64	-1.49	Average	102	3
2	2390.00	50.73	74.00	-23.27	52.22	-1.49	Peak	102	3
3	4824.00	42.59	54.00	-11.41	37.32	5.27	Average	120	114
4	4824.00	49.61	74.00	-24.39	44.34	5.27	Peak	120	114
5	12060.00	43.03	54.00	-10.97	28.07	14.96	Average	100	60
6	12060.00	55.38	74.00	-18.62	40.42	14.96	Peak	100	60

Note 1: Emission Level (dBuV/m) = SA Reading (dBuV) + Factor* (dB/m)

*Factor includes antenna factor , cable loss and amplifier gain

Note 2: Margin (dB) = Emission level (dBuV/m) – Limit (dBuV/m).



Modulation	11b	Test Freq. (MHz)	2437
Polarization	Vertical		

Test By : Roger Lu Temperature(°C):22 Humidity(%):66

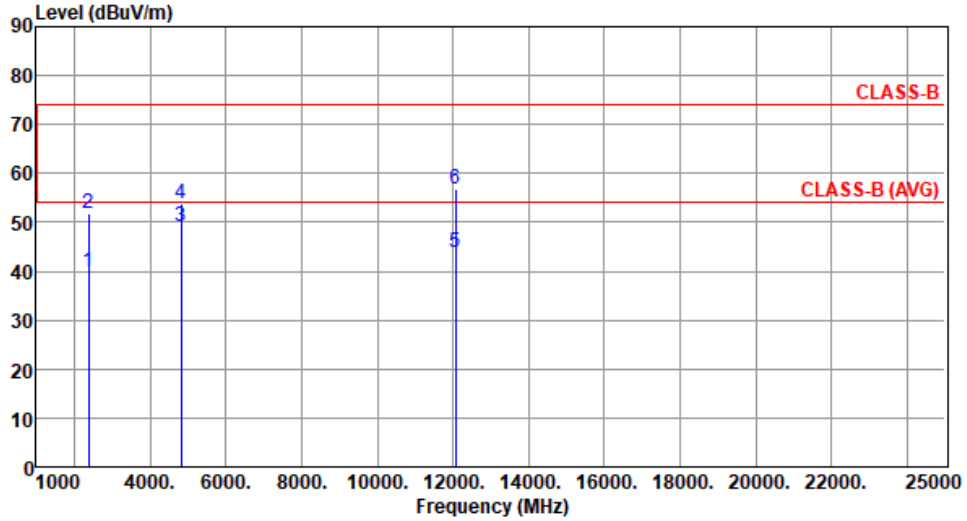

	Freq. MHz	Emission level dBuV/m	Limit dBuV/m	Margin dB	SA reading dBuV	Factor dB/m	Remark	ANT High cm	Turn Table deg
1	2390.00	39.95	54.00	-14.05	41.44	-1.49	Average	149	270
2	2390.00	51.81	74.00	-22.19	53.30	-1.49	Peak	149	270
3	4824.00	49.26	54.00	-4.74	43.99	5.27	Average	213	161
4	4824.00	53.96	74.00	-20.04	48.69	5.27	Peak	213	161
5	12060.00	43.91	54.00	-10.09	28.95	14.96	Average	282	41
6	12060.00	56.78	74.00	-17.22	41.82	14.96	Peak	282	41

Note 1: Emission Level (dBuV/m) = SA Reading (dBuV) + Factor* (dB/m)

*Factor includes antenna factor , cable loss and amplifier gain

Note 2: Margin (dB) = Emission level (dBuV/m) – Limit (dBuV/m).



Configuration 3 : PIFA antenna (Antenna No.6), Y-plane

Transmitter Radiated Unwanted Emissions (Below 1GHz)

Modulation	HT20	Test Freq. (MHz)	2437
Polarization	Horizontal		

Test By :Brad Wu Temperature(°C):23 Humidity(%):64

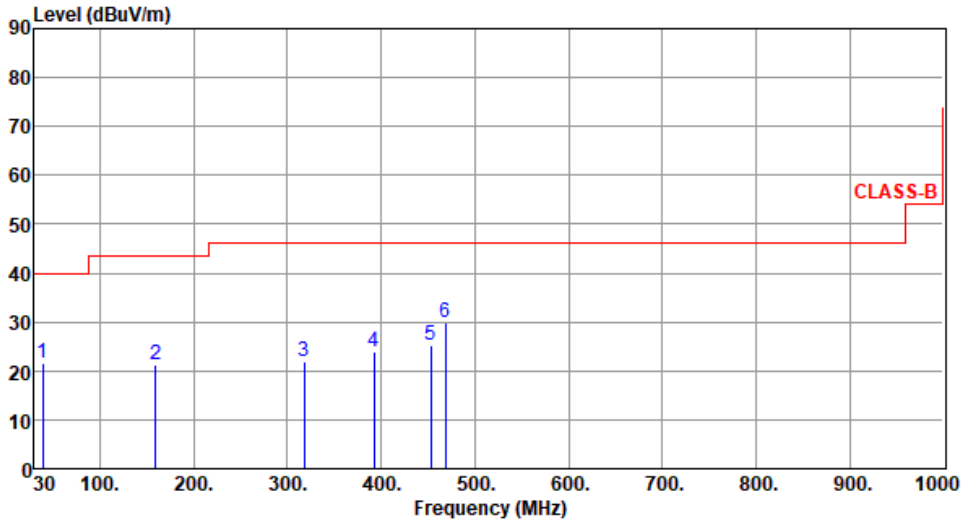

	Freq. MHz	Emission level dBuV/m	Limit dBuV/m	Margin dB	SA reading dBuV	Factor dB/m	Remark	ANT High cm	Turn Table deg
1	38.73	21.63	40.00	-18.37	30.96	-9.33	Peak	---	---
2	159.01	21.15	43.50	-22.35	29.54	-8.39	Peak	---	---
3	318.09	21.97	46.00	-24.03	29.56	-7.59	Peak	---	---
4	392.78	23.78	46.00	-22.22	29.44	-5.66	Peak	---	---
5	452.92	25.09	46.00	-20.91	28.75	-3.66	Peak	---	---
6	468.44	29.86	46.00	-16.14	33.16	-3.30	Peak	---	---

Note 1: Emission Level (dBuV/m) = SA Reading (dBuV) + Factor* (dB/m)

*Factor includes antenna factor , cable loss and amplifier gain

Note 2: Margin (dB) = Emission level (dBuV/m) – Limit (dBuV/m).

Note 3: All spurious emissions below 30MHz are more than 20 dB below the limit.



Modulation	HT20	Test Freq. (MHz)	2437
Polarization	Vertical		

Test By :Brad Wu Temperature(°C):23 Humidity(%):64

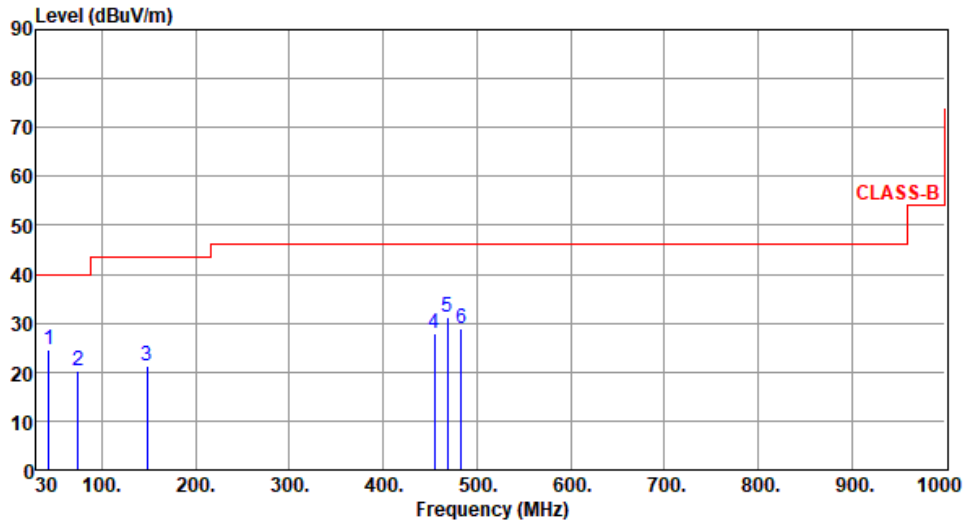

	Freq. MHz	Emission level dBuV/m	Limit dBuV/m	Margin dB	SA reading dBuV	Factor dB/m	Remark	ANT High cm	Turn Table deg
1	43.58	24.47	40.00	-15.53	33.46	-8.99	Peak	---	---
2	74.62	20.18	40.00	-19.82	32.13	-11.95	Peak	---	---
3	148.34	21.36	43.50	-22.14	30.03	-8.67	Peak	---	---
4	454.86	27.90	46.00	-18.10	31.50	-3.60	Peak	---	---
5	468.44	31.34	46.00	-14.66	34.64	-3.30	Peak	---	---
6	482.99	28.98	46.00	-17.02	32.06	-3.08	Peak	---	---

Note 1: Emission Level (dBuV/m) = SA Reading (dBuV) + Factor* (dB/m)
 *Factor includes antenna factor , cable loss and amplifier gain
 Note 2: Margin (dB) = Emission level (dBuV/m) – Limit (dBuV/m).
 Note 3: All spurious emissions below 30MHz are more than 20 dB below the limit.



Transmitter Radiated Unwanted Emissions (Above 1GHz)

Modulation	HT20	Test Freq. (MHz)	2412						
Polarization	Horizontal								
Test By : Roger Lu Temperature(°C):22 Humidity(%):66									
	Freq. MHz	Emission level dBuV/m	Limit dBuV/m	Margin dB	SA reading dBuV	Factor dB/m	Remark	ANT High cm	Turn Table deg
1	2390.00	48.64	54.00	-5.36	50.13	-1.49	Average	111	48
2	2390.00	65.01	74.00	-8.99	66.50	-1.49	Peak	111	48
3	4824.00	32.40	54.00	-21.60	27.13	5.27	Average	100	60
4	4824.00	44.73	74.00	-29.27	39.46	5.27	Peak	100	60
5	12060.00	42.54	54.00	-11.46	27.58	14.96	Average	100	40
6	12060.00	55.96	74.00	-18.04	41.00	14.96	Peak	100	40

Note 1: Emission Level (dBuV/m) = SA Reading (dBuV) + Factor* (dB/m)
 *Factor includes antenna factor , cable loss and amplifier gain
 Note 2: Margin (dB) = Emission level (dBuV/m) – Limit (dBuV/m).



Modulation	HT20	Test Freq. (MHz)	2412
Polarization	Vertical		

Test By : Roger Lu Temperature(°C):22 Humidity(%):66

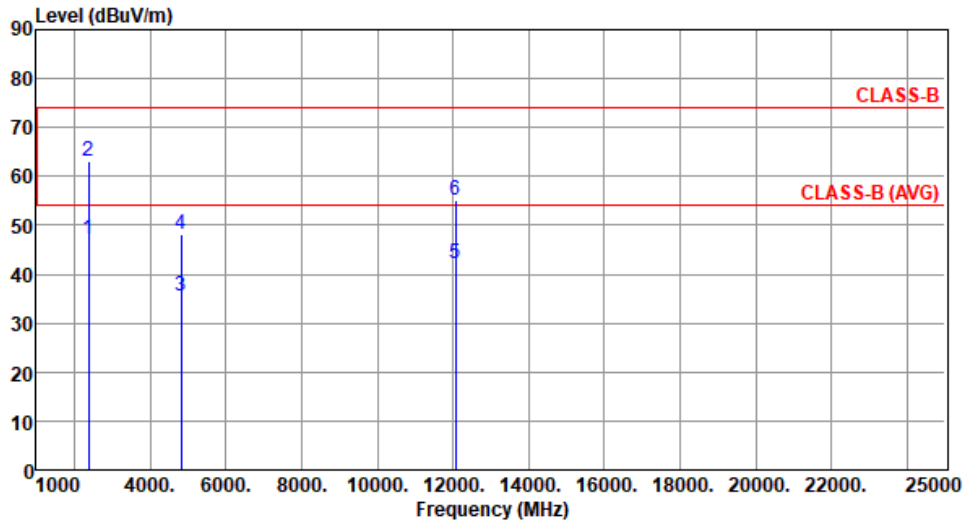

	Freq. MHz	Emission level dBuV/m	Limit dBuV/m	Margin dB	SA reading dBuV	Factor dB/m	Remark	ANT High cm	Turn Table deg
1	2390.00	47.14	54.00	-6.86	48.63	-1.49	Average	100	213
2	2390.00	63.12	74.00	-10.88	64.61	-1.49	Peak	100	213
3	4824.00	35.45	54.00	-18.55	30.18	5.27	Average	164	113
4	4824.00	48.07	74.00	-25.93	42.80	5.27	Peak	164	113
5	12060.00	42.27	54.00	-11.73	27.31	14.96	Average	100	50
6	12060.00	55.18	74.00	-18.82	40.22	14.96	Peak	100	50

Note 1: Emission Level (dBuV/m) = SA Reading (dBuV) + Factor* (dB/m)

*Factor includes antenna factor , cable loss and amplifier gain

Note 2: Margin (dB) = Emission level (dBuV/m) – Limit (dBuV/m).



Test Result of AC POWER LINE CONDUCTED EMISSIONS

Modulation Mod	HT20	Test Freq. (MHz)	2437
Power Phase	Line		

Test by : Joe Liao Temperature: 16°C Humidity: 60%

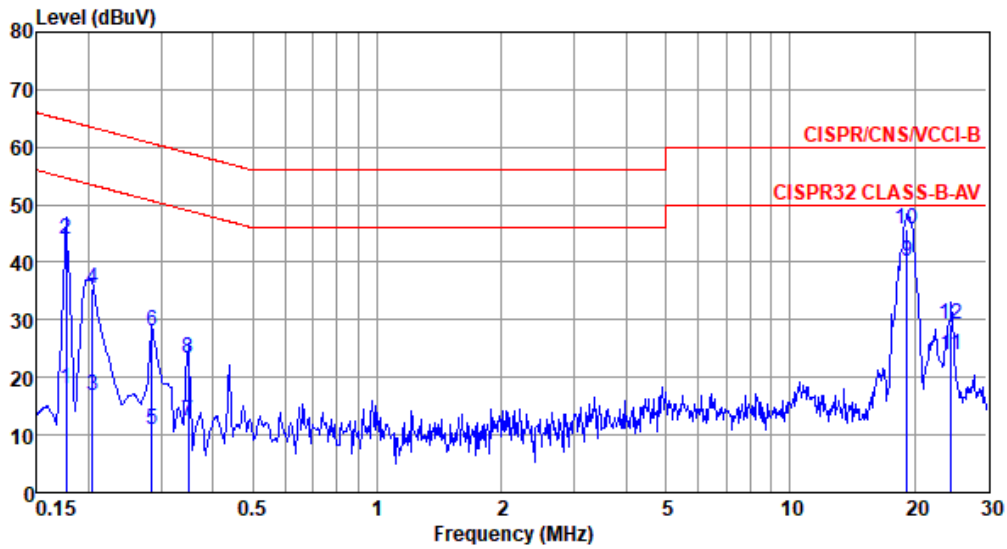

	Freq MHz	Level dBUV	Limit Line dBUV	Over Limit dB	Read Level dBUV	Factor dB	Cable loss dB	Aux dB	Remark
1	0.177	17.86	54.64	-36.78	8.17	9.61	0.08	0.00	Average
2	0.177	43.96	64.64	-20.68	34.27	9.61	0.08	0.00	QP
3	0.204	16.87	53.45	-36.58	7.18	9.61	0.08	0.00	Average
4	0.204	35.36	63.45	-28.09	25.67	9.61	0.08	0.00	QP
5	0.285	11.03	50.68	-39.65	1.35	9.60	0.08	0.00	Average
6	0.285	28.13	60.68	-32.55	18.45	9.60	0.08	0.00	QP
7	0.348	12.38	49.00	-36.62	2.70	9.60	0.08	0.00	Average
8	0.348	23.38	59.00	-35.62	13.70	9.60	0.08	0.00	QP
9*	19.224	40.06	50.00	-9.94	29.82	9.59	0.65	0.00	Average
10	19.224	45.64	60.00	-14.36	35.40	9.59	0.65	0.00	QP
11	24.529	23.95	50.00	-26.05	13.74	9.52	0.69	0.00	Average
12	24.529	29.22	60.00	-30.78	19.01	9.52	0.69	0.00	QP

Note 1: Level (dBUV) = Read Level (dBUV) + LISN Factor (dB) + Cable Loss (dB) + Aux (dB).

Note 2: Over Limit (dB) = Level (dBUV) – Limit Line (dBUV).



AC POWER LINE CONDUCTED EMISSIONS

Appendix C

Modulation Mod	HT20	Test Freq. (MHz)	2437
----------------	------	------------------	------

Power Phase	Neutral
-------------	---------

Test by : Joe Liao Temperature: 16°C Humidity: 60%

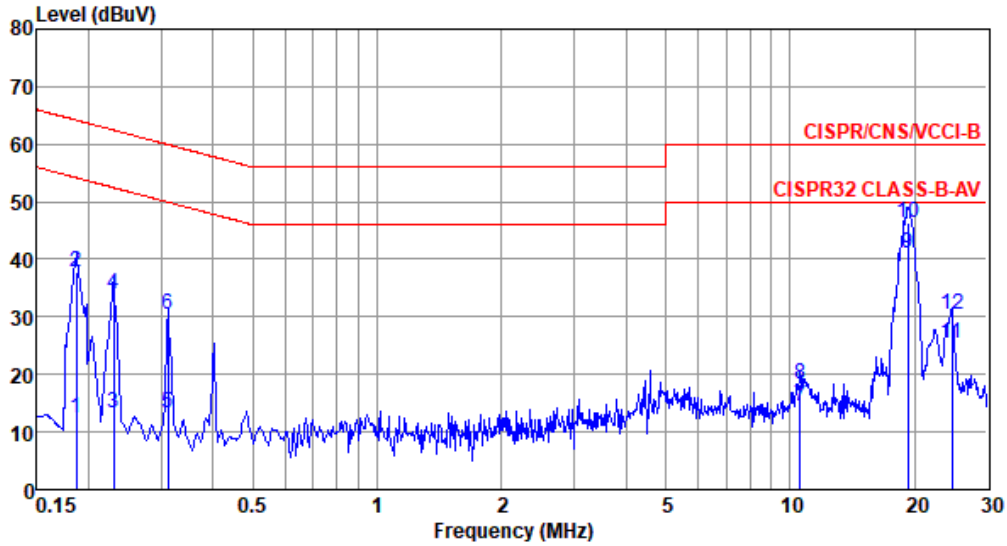

	Freq MHz	Level dBuV	Limit Line dBuV	Over Limit dB	Read Level dBuV	Factor dB	Cable loss dB	Aux dB	Remark
1	0.186	12.34	54.20	-41.86	2.67	9.59	0.08	0.00	Average
2	0.186	37.78	64.20	-26.42	28.11	9.59	0.08	0.00	QP
3	0.230	13.34	52.44	-39.10	3.67	9.59	0.08	0.00	Average
4	0.230	34.04	62.44	-28.40	24.37	9.59	0.08	0.00	QP
5	0.312	13.35	49.93	-36.58	3.69	9.58	0.08	0.00	Average
6	0.312	30.44	59.93	-29.49	20.78	9.58	0.08	0.00	QP
7	10.564	14.36	50.00	-35.64	4.25	9.65	0.46	0.00	Average
8	10.564	18.35	60.00	-41.65	8.24	9.65	0.46	0.00	QP
9*	19.326	40.94	50.00	-9.06	30.61	9.68	0.65	0.00	Average
10	19.326	46.40	60.00	-13.60	36.07	9.68	0.65	0.00	QP
11	24.659	25.53	50.00	-24.47	15.18	9.66	0.69	0.00	Average
12	24.659	30.35	60.00	-29.65	20.00	9.66	0.69	0.00	QP

Note 1: Level (dBuV) = Read Level (dBuV) + LISN Factor (dB) + Cable Loss (dB) + Aux (dB).
 Note 2: Over Limit (dB) = Level (dBuV) – Limit Line (dBuV).