

# FCC Test Report

**FCC ID** : SQG-M2SD50NBT  
**Equipment** : 802.11abgn M.2 module w/SDIO interface  
**Model No.** : M2SD50NBT  
**Brand Name** : Laird Technologies  
**Applicant** : Laird Technologies  
**Address** : 11160 Thompson Ave., Lenexa, Kansas 66219,  
USA  
**Standard** : 47 CFR FCC Part 15.407  
**Received Date** : Sep. 11, 2015  
**Tested Date** : Nov. 30, 2015 ~ Jan. 11, 2016

We, International Certification Corp., would like to declare that the tested sample has been evaluated and in compliance with the requirement of the above standards. The test results contained in this report refer exclusively to the product. It may be duplicated completely for legal use with the approval of the applicant. It shall not be reproduced except in full without the written approval of our laboratory.

Approved & Reviewed by:

  
\_\_\_\_\_  
Gary Chang / Manager



---

## Table of Contents

<b>1</b>	<b>GENERAL DESCRIPTION .....</b>	<b>5</b>
1.1	Information.....	5
1.2	Local Support Equipment List.....	9
1.3	Test Setup Chart.....	9
1.4	The Equipment List .....	10
1.5	Testing Applied Standards .....	11
1.6	Measurement Uncertainty .....	11
<b>2</b>	<b>TEST CONFIGURATION.....</b>	<b>12</b>
2.1	Testing Condition .....	12
2.2	The Worst Test Modes and Channel Details.....	12
<b>3</b>	<b>TRANSMITTER TEST RESULTS .....</b>	<b>14</b>
3.1	Conducted Emissions .....	14
3.2	Emission Bandwidth.....	19
3.3	RF Output Power .....	23
3.4	Peak Power Spectral Density .....	26
3.5	Transmitter Radiated and Band Edge Emissions .....	31
3.6	Frequency Stability.....	244
<b>4</b>	<b>TEST LABORATORY INFORMATION .....</b>	<b>247</b>

---

## Release Record

Report No.	Version	Description	Issued Date
FR591102AN	Rev. 01	Initial issue	Feb. 16, 2016

## Summary of Test Results

FCC Rules	Test Items	Measured	Result
15.207	Conducted Emissions	[dBuV]: 21.147MHz 20.42 (Margin -29.58dB) - AV	Pass
15.407(b) 15.209	Radiated Emissions	[dBuV/m at 3m]: 15720.00MHz 53.87 (Margin -0.13dB) - AV	Pass
15.407(a)	Emission Bandwidth	Meet the requirement of limit	Pass
15.407(e)	6dB bandwidth	Meet the requirement of limit	Pass
15.407(a)	RF Output Power	Max Power [dBm]: 5150~5250MHz: 21.36 5250~5350MHz: 21.50 5470~5725MHz: 21.86 5725~5850MHz: 20.80	Pass
15.407(a)	Peak Power Spectral Density	Meet the requirement of limit	Pass
15.407(g)	Frequency Stability	Meet the requirement of limit	Pass
15.203	Antenna Requirement	Meet the requirement of limit	Pass

# 1 General Description

## 1.1 Information

### 1.1.1 Specification of the Equipment under Test (EUT)

RF General Information					
Frequency Range (MHz)	IEEE Std. 802.11	Ch. Freq. (MHz)	Channel Number	Transmit Chains (N <sub>TX</sub> )	Data Rate / MCS
5150-5250 5250-5350 5470-5725 5725-5850	a	5180-5240 5260-5320 5500-5700 5745-5825	36-48 [4] 52-64 [4] 100-140 [11] 149-165 [5]	1 2	6-54 Mbps
5150-5250 5250-5350 5470-5725 5725-5850	n (HT20)	5180-5240 5260-5320 5500-5700 5745-5825	36-48 [4] 52-64 [4] 100-140 [11] 149-165 [5]	1 2 2	MCS 0-7 MCS 0-7 MCS 8-15
5150-5250 5250-5350 5470-5725 5725-5850	n (HT40)	5190-5230 5270-5310 5510-5670 5755-5795	38-46 [2] 54-62 [2] 102-134 [5] 151-159 [2]	1 2 2	MCS 0-7 MCS 0-7 MCS 8-15

Note 1: RF output power specifies that Maximum Conducted Output Power.  
 Note 2: 802.11a/n uses a combination of OFDM-BPSK, QPSK, 16QAM, 64QAM modulation.  
 Note 3: The device supports TX antenna diversity function. The conducted power of single chain is same for 1TX and 2TX operating mode. Therefore, Ant1+Ant2 configuration is chosen for final testing.

### 1.1.2 Antenna Details

Ant. No.	Model	Type	Connector	Operating Frequencies (MHz) / Antenna Gain (dBi)				
				2400~2483.5	5150~5250	5250~5350	5470~5725	5725~5850
1	Laird MAF94051	Dipole	RP-SMA	2.1	2.4	2.6	3.4	3.4
2	Laird NanoBlade-IP04	PCB Dipole	IPEX MHF	2	3.9	3.9	4	4
3	Laird MAF95310 Mini NanoBlade Flex	PCB Dipole	IPEX MHF	2.79	3.38	3.38	3.38	3.38
4	Laird NanoBlue-IP04	PCB Dipole	IPEX MHF	2	---	---	---	---
5	Ethertronics WLAN_1000146	Isolated Magnetic Dipole	IPEX MHF	2.5	3.5	3.5	3.5	3.5

**Note:** Ant. No. 1, 3 & 5 were for 2.4G final test.

Ant. No. 1, 2 & 5 were for 5G final test.

### 1.1.3 Power Supply Type of Equipment under Test (EUT)

<b>Power Supply Type</b>	3.3Vdc from host
--------------------------	------------------

### 1.1.4 Accessories

N/A

### 1.1.5 Channel List

802.11 a / HT20		HT40	
Channel	Frequency(MHz)	Channel	Frequency(MHz)
36	5180	38	5190
40	5200	46	5230
44	5220	54	5270
48	5240	62	5310
52	5260	102	5510
56	5280	110	5550
60	5300	118	5590
64	5320	126	5630
100	5500	134	5670
104	5520	151	5755
108	5540	159	5795
112	5560	---	---
116	5580	---	---
120	5600	---	---
124	5620	---	---
128	5640	---	---
132	5660	---	---
136	5680	---	---
140	5700	---	---
149	5745	---	---
153	5765	---	---
157	5785	---	---
161	5805	---	---
165	5825	---	---

### 1.1.6 Test Tool and Duty Cycle

<b>Test Tool</b>	ART2 GUI, V2.3		
<b>Duty Cycle and Duty Factor</b>	<b>Mode</b>	<b>Duty cycle (%)</b>	<b>Duty factor (dB)</b>
	11a	99.16%	0.04
	HT20	99.10%	0.04
	HT40	98.05%	0.09

### 1.1.7 Power Setting

For Frequency band 5150-5250 MHz		
Modulation Mode	Test Frequency (MHz)	Power Set
11a	5180	19.5
11a	5200	19.5
11a	5240	19.5
HT20	5180	19.5
HT20	5200	19.5
HT20	5240	19.5
HT40	5190	16.5
HT40	5230	20.5

For Frequency band 5250~5350 MHz		
Modulation Mode	Test Frequency (MHz)	Power Set
11a	5260	19.5
11a	5300	19.5
11a	5320	19.5
HT20	5260	19.5
HT20	5300	19.5
HT20	5320	19.5
HT40	5270	20.5
HT40	5310	18

For Frequency band 5470~5725 MHz		
Modulation Mode	Test Frequency (MHz)	Power Set
11a	5500	18
11a	5580	19
11a	5700	17
HT20	5500	17.5
HT20	5580	19
HT20	5700	17
HT40	5510	16.5
HT40	5590	21
HT40	5670	19

For Frequency band 5725~5850 MHz		
Modulation Mode	Test Frequency (MHz)	Power Set
11a	5745	19
11a	5785	21
11a	5825	22
HT20	5745	18.5
HT20	5785	21
HT20	5825	22
HT40	5755	17
HT40	5795	20.5



## 1.2 Local Support Equipment List

Support Equipment List						
No.	Equipment	Brand	Model	S/N	FCC ID	Signal cable / Length (m)
1	DC Power Supply	GW INSTEK	GPC-3060D	EM884797	---	---
2	Notebook	DELL	Latitude E6430	9ZFB4X1	DoC	---
3	Fixture	---	---	---	---	---

Note: The fixture is provided by applicant.

## 1.3 Test Setup Chart

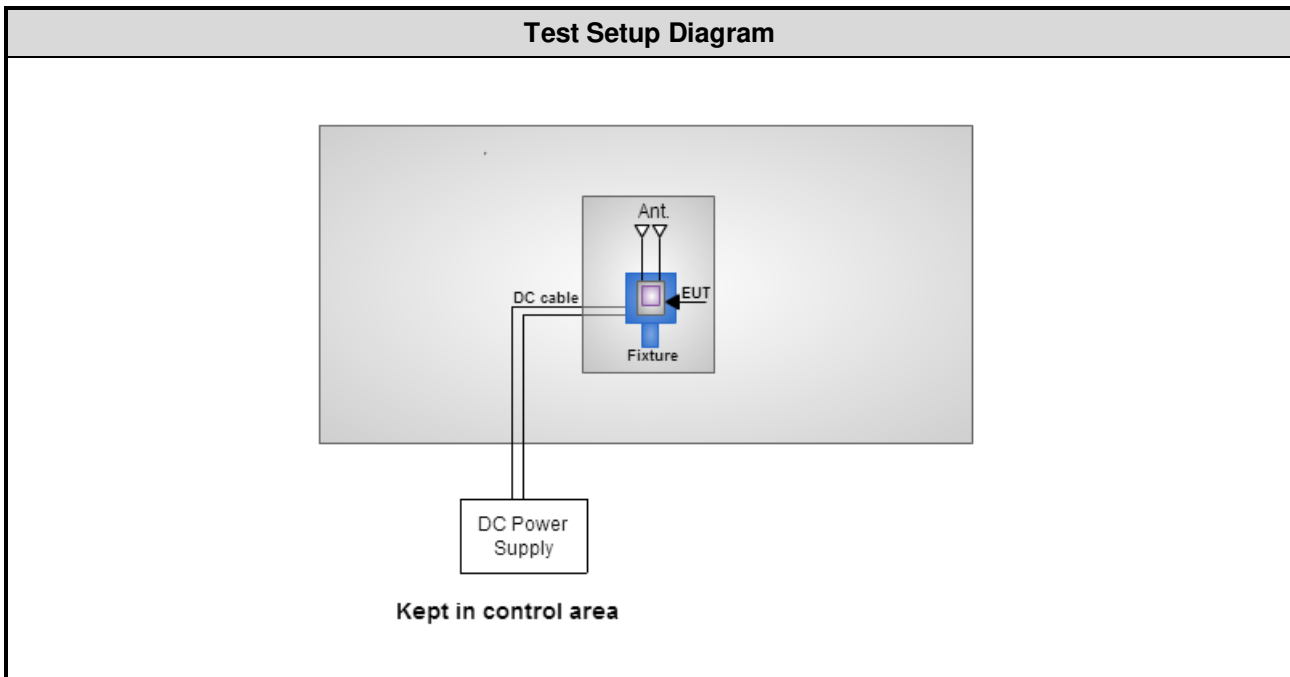

Note: The support notebook was disconnected from EUT and removed from test table when EUT is set to transmit continuously.

## 1.4 The Equipment List

<b>Test Item</b>	Conducted Emission				
<b>Test Site</b>	Conduction room 1 / (CO01-WS)				
<b>Tested Date</b>	Jan. 07, 2016				
<b>Instrument</b>	<b>Manufacturer</b>	<b>Model No.</b>	<b>Serial No.</b>	<b>Calibration Date</b>	<b>Calibration Until</b>
EMC Receiver	R&S	ESCS 30	100169	Oct. 21, 2015	Oct. 20, 2016
LISN	SCHWARZBECK	Schwarzbeck 8127	8127-667	Nov. 13, 2015	Nov. 12, 2016
RF Cable-CON	EMC	EMCCFD300-BM-BM-6000	50821	Dec. 21, 2015	Dec. 20, 2016
Measurement Software	AUDIX	e3	6.120210k	NA	NA
Note: Calibration Interval of instruments listed above is one year.					

<b>Test Item</b>	Radiated Emission				
<b>Test Site</b>	966 chamber 3 / (03CH03-WS)				
<b>Tested Date</b>	Nov. 30 ~ Dec. 22, 2015				
<b>Instrument</b>	<b>Manufacturer</b>	<b>Model No.</b>	<b>Serial No.</b>	<b>Calibration Date</b>	<b>Calibration Until</b>
Spectrum Analyzer	Agilent	N9010A	MY53400091	Sep. 14, 2015	Sep. 13, 2016
Receiver	Agilent	N9038A	MY53290044	Oct. 14, 2015	Oct. 13, 2016
Bilog Antenna	SCHWARZBECK	VULB9168	VULB9168-563	Dec. 30, 2014	Dec. 29, 2015
Horn Antenna 1G-18G	SCHWARZBECK	BBHA 9120 D	BBHA 9120 D 1206	Feb. 03, 2015	Feb. 02, 2016
Horn Antenna 18G-40G	SCHWARZBECK	BBHA 9170	BBHA 9170517	Nov. 04, 2015	Nov. 03, 2016
Preamplifier	EMC	EMC02325	980187	Sep. 21, 2015	Sep. 20, 2016
Preamplifier	Agilent	83017A	MY53270014	Sep. 07, 2015	Sep. 06, 2016
Preamplifier	EMC	EMC184045B	980192	Sep. 01, 2015	Aug. 31, 2016
RF cable-3M	HUBER+SUHNER	SUCOFLEX104	MY22620/4	Feb. 09, 2015	Feb. 08, 2016
RF cable-8M	HUBER+SUHNER	SUCOFLEX104	MY22600/4	Feb. 09, 2015	Feb. 08, 2016
RF cable-1M	HUBER+SUHNER	SUCOFLEX104	MY22624/4	Feb. 09, 2015	Feb. 08, 2016
LF cable-0.8M	EMC	EMC8D-NM-NM-800	EMC8D-NM-NM-800-001	Feb. 09, 2015	Feb. 08, 2016
LF cable-3M	EMC	EMC8D-NM-NM-3000	131103	Feb. 09, 2015	Feb. 08, 2016
LF cable-13M	EMC	EMC8D-NM-NM-13000	131104	Feb. 09, 2015	Feb. 08, 2016
Measurement Software	AUDIX	e3	6.120210g	NA	NA
Note: Calibration Interval of instruments listed above is one year.					

<b>Test Item</b>	RF Conducted				
<b>Test Site</b>	(TH01-WS)				
<b>Tested Date</b>	Jan. 09 ~ Jan. 11, 2016				
<b>Instrument</b>	<b>Manufacturer</b>	<b>Model No.</b>	<b>Serial No.</b>	<b>Calibration Date</b>	<b>Calibration Until</b>
Spectrum Analyzer	R&S	FSV40	101063	Feb. 03, 2015	Feb. 02, 2016
TEMP&HUMIDITY CHAMBER	GIANT FORCE	GCT-225-40-SP-SD	MAF1212-002	Nov. 27, 2015	Nov. 26, 2016
Power Meter	Anritsu	ML2495A	1241002	Sep. 21, 2015	Sep. 20, 2016
Power Sensor	Anritsu	MA2411B	1207366	Sep. 21, 2015	Sep. 20, 2016
DC POWER SOURCE	GW INSTEK	GPC-3060D	EM884797	Oct. 20, 2015	Oct. 19, 2016
Measurement Software	Sporton	Sporton_1	1.3.30	NA	NA
Note: Calibration Interval of instruments listed above is one year.					

## 1.5 Testing Applied Standards

According to the specification of EUT, the EUT must comply with following standards and KDB documents.

47 CFR FCC Part 15.407

ANSI C63.10-2013

FCC KDB 789033 D02 General UNII Test Procedures New Rules v01r01

FCC KDB 644545 D03 Guidance for IEEE 802 11ac New Rules v01

FCC KDB 662911 D01 Multiple Transmitter Output v02r01

FCC KDB 412172 D01 Determining ERP and EIRP v01r01

## 1.6 Measurement Uncertainty

ISO/IEC 17025 requires that an estimate of the measurement uncertainties associated with the emissions test results be included in the report. The measurement uncertainties given below are based on a 95% confidence level (based on a coverage factor ( $k=2$ ))

Measurement Uncertainty	
Parameters	Uncertainty
Bandwidth	±34.134 Hz
Conducted power	±0.808 dB
Frequency error	±34.134 Hz
Power density	±0.463 dB
Conducted emission	±2.670 dB
AC conducted emission	±2.92 dB
Radiated emission ≤ 1GHz	±3.66 dB
Radiated emission > 1GHz	±5.37 dB
Time	±0.1%
Temperature	±0.6 °C

## 2 Test Configuration

### 2.1 Testing Condition

Test Item	Test Site	Ambient Condition	Tested By
AC Conduction	CO01-WS	20°C / 60%	Peter Lin
Radiated Emissions	03CH03-WS	22-23°C / 61-64%	Anderson Hong Felix Sung Vincent Yeh
RF Conducted	TH01-WS	21°C / 64%	Alex Huang

➤ FCC site registration No.: 390588

➤ IC site registration No.: 10807C-1

### 2.2 The Worst Test Modes and Channel Details

Frequency band 5150~5350 MHz / 5470~5725 MHz				
Test item	Modulation Mode	Test Frequency (MHz)	Data Rate	Test Configuration
Conducted Emissions	HT40	5590	MCS 0	2
Radiated Emissions ≤1GHz	HT40	5590	MCS 0	1, 2, 3
Radiated Emissions >1GHz	11a	5180 / 5200 / 5240 / 5260 / 5300 5320 / 5500 / 5580 / 5700	6 Mbps	1, 2, 3
	HT20	5180 / 5200 / 5240 / 5260 / 5300 5320 / 5500 / 5580 / 5700	MCS 0	
	HT40	5190 / 5230 / 5270 / 5310 / 5510 5590 / 5670	MCS 0	
RF Output Power Emission Bandwidth Peak Power Spectral Density	11a	5180 / 5200 / 5240 / 5260 / 5300 5320 / 5500 / 5580 / 5700	6 Mbps	2
	HT20	5180 / 5200 / 5240 / 5260 / 5300 5320 / 5500 / 5580 / 5700	MCS 0	
	HT40	5190 / 5230 / 5270 / 5310 / 5510 5590 / 5670	MCS 0	
Frequency Stability	Un-modulation	5320	---	---

**NOTE:**

- The EUT was pretested with 3 orientations placed on the table for the radiated emission measurement – X, Y, and Z-plane. The **Y-plane** results were found as the worst case and were shown in this report.
- The following antennas are used for final testing for this module: (See item 1.1.2 for more details.)
  - Configuration 1 : Dipole antenna
  - Configuration 2 : PCB Dipole antenna
  - Configuration 3 : Isolated Magnetic Dipole antenna

Frequency band 5725-5850 MHz				
Test item	Modulation Mode	Test Frequency (MHz)	Data Rate	Test Configuration
Conducted Emissions	11a	5785	6 Mbps	2
Radiated Emissions ≤1GHz	11a	5785	6 Mbps	1, 2, 3
Radiated Emissions >1GHz	11a	5745 / 5785 / 5825	6 Mbps	1, 2, 3
	HT20	5745 / 5785 / 5825	MCS 0	
	HT40	5755 / 5795	MCS 0	
RF Output Power	11a	5745 / 5785 / 5825	6 Mbps	2
Emission Bandwidth	HT20	5745 / 5785 / 5825	MCS 0	
6dB bandwidth	HT40	5755 / 5795	MCS 0	
Peak Power Spectral Density	HT40	5755 / 5795	MCS 0	
Frequency Stability	Un-modulation	5785	---	---

**NOTE:**

- The EUT was pretested with 3 orientations placed on the table for the radiated emission measurement – X, Y, and Z-plane. The **Y-plane** results were found as the worst case and were shown in this report.
- The following antennas are used for final testing for this module: (See item 1.1.2 for more details.)
  - Configuration 1 : Dipole antenna
  - Configuration 2 : PCB Dipole antenna
  - Configuration 3 : Isolated Magnetic Dipole antenna

## 3 Transmitter Test Results

### 3.1 Conducted Emissions

#### 3.1.1 Limit of Conducted Emissions

Conducted Emissions Limit		
Frequency Emission (MHz)	Quasi-Peak	Average
0.15-0.5	66 - 56 *	56 - 46 *
0.5-5	56	46
5-30	60	50

Note 1: \* Decreases with the logarithm of the frequency.

#### 3.1.2 Test Procedures

1. The device is placed on a test table, raised 80 cm above the reference ground plane. The vertical conducting plane is located 40 cm to the rear of the device.
2. The device is connected to line impedance stabilization network (LISN) and other accessories are connected to other LISN. Measured levels of AC power line conducted emission are across the 50  $\Omega$  LISN port.
3. AC conducted emission measurements is made over frequency range from 150 kHz to 30 MHz.
4. This measurement was performed with AC 120V/60Hz

#### 3.1.3 Test Setup

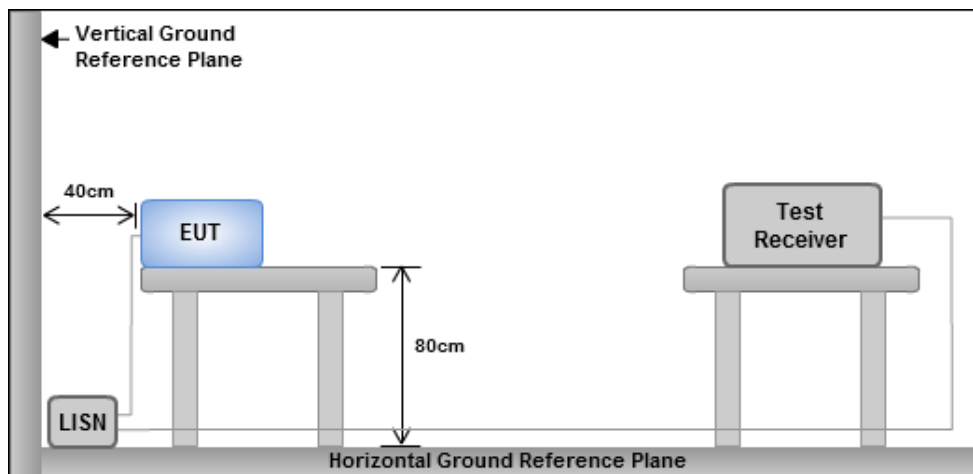

Note: 1. Support units were connected to second LISN.

2. Both of LISNs (AMN) are 80 cm from EUT and at least 80 cm from other units and other metal planes

### 3.1.4 Test Result of Conducted Emissions

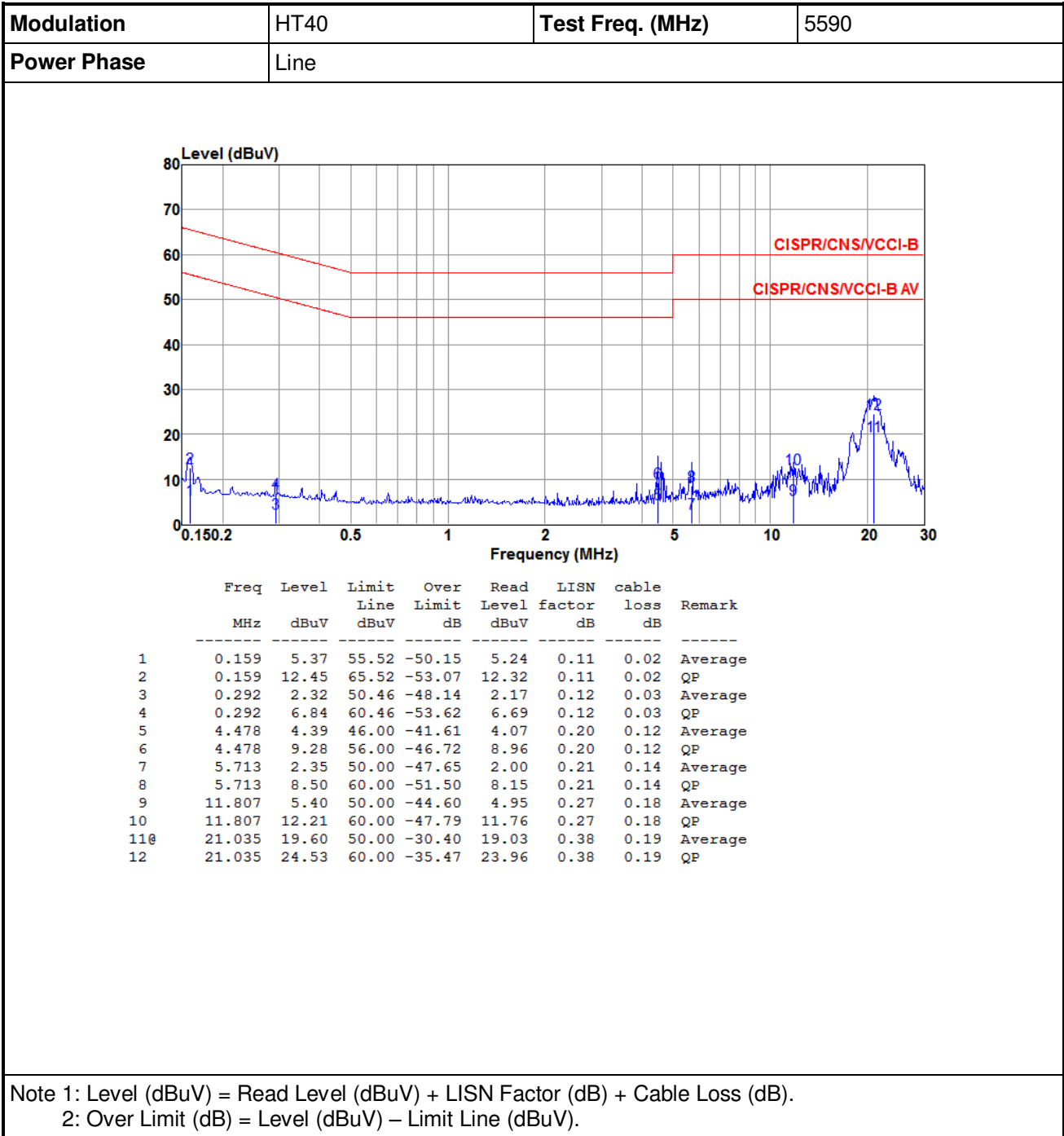

<b>Modulation</b>	HT40	<b>Test Freq. (MHz)</b>	5590
<b>Power Phase</b>	Neutral		

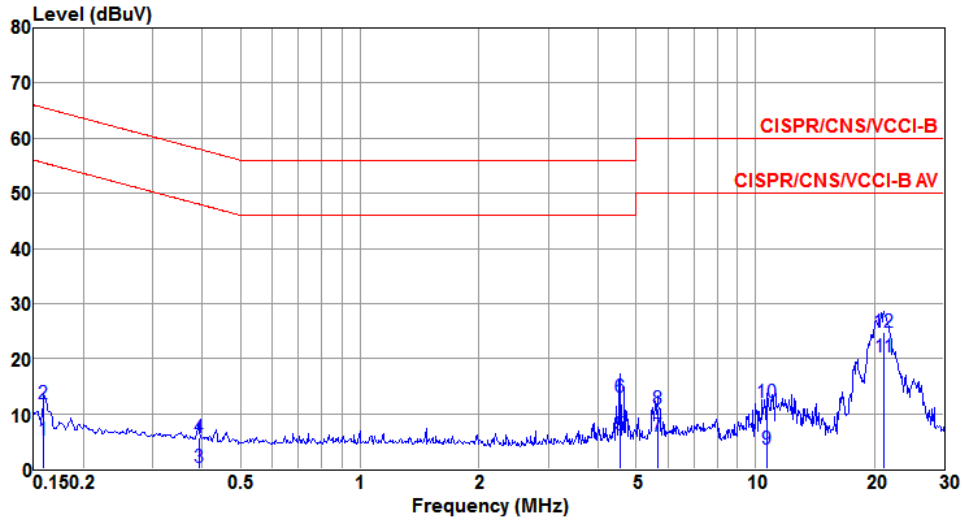

	Freq	Level	Limit	Over	Read	LISN	cable	Remark
	MHz	dBuV	dBuV	dB	dBuV	dB	dB	
1	0.159	5.20	55.52	-50.32	5.06	0.12	0.02	Average
2	0.159	11.90	65.52	-53.62	11.76	0.12	0.02	QP
3	0.391	0.23	48.03	-47.80	0.06	0.14	0.03	Average
4	0.391	5.79	58.03	-52.24	5.62	0.14	0.03	QP
5	4.549	6.11	46.00	-39.89	5.80	0.18	0.13	Average
6	4.549	13.07	56.00	-42.93	12.76	0.18	0.13	QP
7	5.653	5.94	50.00	-44.06	5.60	0.21	0.13	Average
8	5.653	10.78	60.00	-49.22	10.44	0.21	0.13	QP
9	10.733	3.61	50.00	-46.39	3.16	0.28	0.17	Average
10	10.733	12.04	60.00	-47.96	11.59	0.28	0.17	QP
11	21.147	20.42	50.00	-29.58	19.82	0.41	0.19	Average
12	21.147	24.68	60.00	-35.32	24.08	0.41	0.19	QP

Note 1: Level (dBuV) = Read Level (dBuV) + LISN Factor (dB) + Cable Loss (dB).  
 2: Over Limit (dB) = Level (dBuV) – Limit Line (dBuV).



<b>Modulation</b>	11a	<b>Test Freq. (MHz)</b>	5785
<b>Power Phase</b>	Line		

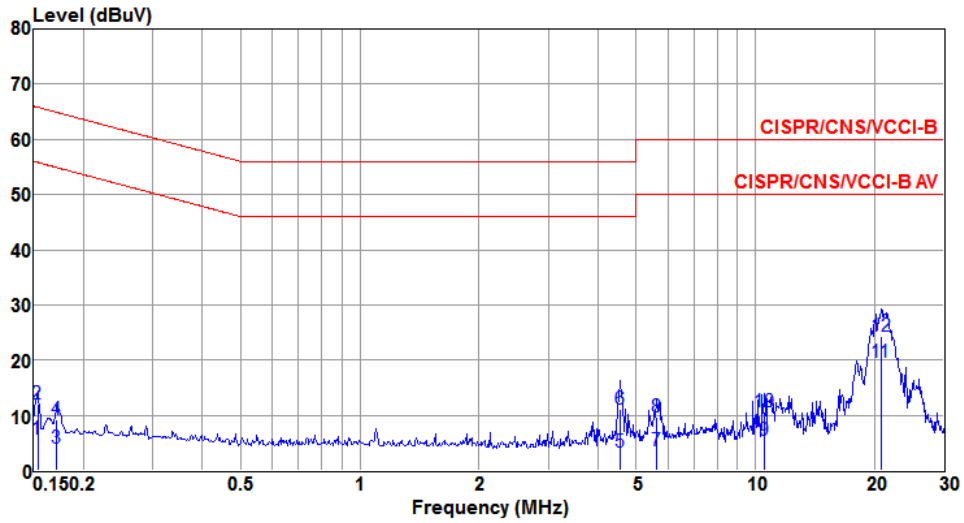

	Freq MHz	Level dBuV	Limit Line dBuV	Over Limit dB	Read Level dBuV	LISN factor dB	cable loss dB	Remark
1	0.153	5.72	55.82	-50.10	5.59	0.11	0.02	Average
2	0.153	11.95	65.82	-53.87	11.82	0.11	0.02	QP
3	0.171	3.91	54.90	-50.99	3.78	0.11	0.02	Average
4	0.171	9.20	64.90	-55.70	9.07	0.11	0.02	QP
5	4.549	3.29	46.00	-42.71	2.96	0.20	0.13	Average
6	4.549	11.16	56.00	-44.84	10.83	0.20	0.13	QP
7	5.623	3.56	50.00	-46.44	3.22	0.21	0.13	Average
8	5.623	9.67	60.00	-50.33	9.33	0.21	0.13	QP
9	10.508	5.53	50.00	-44.47	5.11	0.25	0.17	Average
10	10.508	10.67	60.00	-49.33	10.25	0.25	0.17	QP
11@	20.814	19.58	50.00	-30.42	19.02	0.38	0.18	Average
12	20.814	24.39	60.00	-35.61	23.83	0.38	0.18	QP

Note 1: Level (dBuV) = Read Level (dBuV) + LISN Factor (dB) + Cable Loss (dB).  
 2: Over Limit (dB) = Level (dBuV) – Limit Line (dBuV).

<b>Modulation</b>	11a	<b>Test Freq. (MHz)</b>	5785
<b>Power Phase</b>	Neutral		

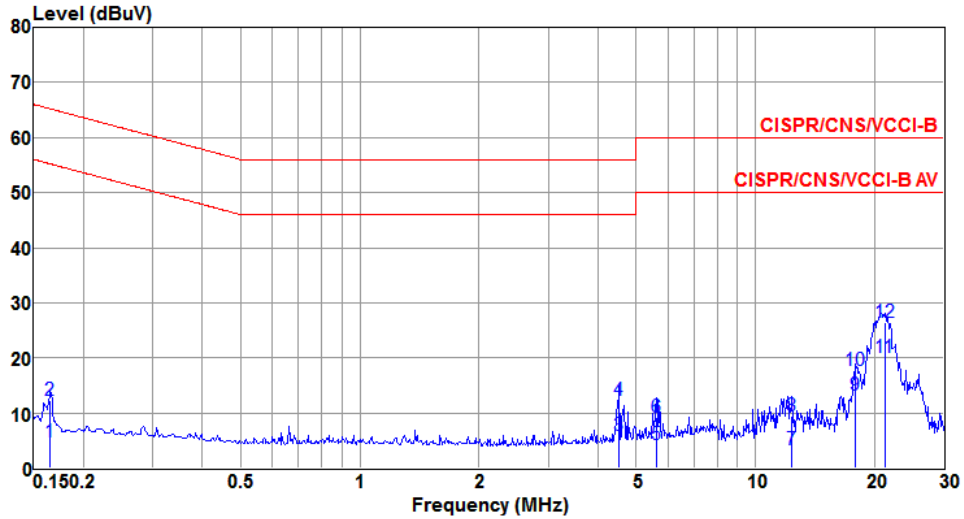

	Freq	Level	Limit	Over	Read	LISN	cable	
	MHz	dBuV	Line	Limit	Level	factor	loss	Remark
			dBuV	dB	dBuV	dB	dB	
1	0.165	4.76	55.21	-50.45	4.62	0.12	0.02	Average
2	0.165	12.31	65.21	-52.90	12.17	0.12	0.02	QP
3	4.525	5.82	46.00	-40.18	5.51	0.18	0.13	Average
4	4.525	12.31	56.00	-43.69	12.00	0.18	0.13	QP
5	5.623	4.22	50.00	-45.78	3.88	0.21	0.13	Average
6	5.623	9.27	60.00	-50.73	8.93	0.21	0.13	QP
7	12.384	3.35	50.00	-46.65	2.85	0.31	0.19	Average
8	12.384	9.44	60.00	-50.56	8.94	0.31	0.19	QP
9	17.944	13.32	50.00	-36.68	12.76	0.38	0.18	Average
10	17.944	17.62	60.00	-42.38	17.06	0.38	0.18	QP
11@	21.260	20.03	50.00	-29.97	19.43	0.41	0.19	Average
12	21.260	26.48	60.00	-33.52	25.88	0.41	0.19	QP

Note 1: Level (dBUV) = Read Level (dBUV) + LISN Factor (dB) + Cable Loss (dB).  
 Note 2: Over Limit (dB) = Level (dBUV) - Limit Line (dBUV).

## 3.2 Emission Bandwidth

### 3.2.1 Limit of Emission Bandwidth

Within the 5.725-5.85 GHz band, the minimum 6 dB bandwidth of U-NII devices shall be at least 500 kHz.

### 3.2.2 Test Procedures

#### 26dB Bandwidth

1. Set RBW = approximately 1% of the emission bandwidth.
2. Set the VBW > RBW, Detector = Peak.
3. Trace mode = max hold.
4. Measure the maximum width of the emission that is 26 dB down from the peak of the emission.

#### Occupied Bandwidth

1. Set RBW = 1 % to 5 % of the OBW
2. Set VBW  $\geq$  3 RBW
3. Sample detection and single sweep mode shall be used
4. Use the 99 % power bandwidth function of the instrument

#### 6dB Bandwidth

1. Set RBW = 100kHz, VBW = 300kHz
2. Detector = Peak, Trace mode = max hold.
3. Allow the trace to stabilize.
4. Measure the maximum width of the emission that is constrained by the frequencies associated with the two outermost amplitude points (upper and lower frequencies) that are attenuated by 6 dB relative to the maximum level measured in the fundamental emission

### 3.2.3 Test Setup

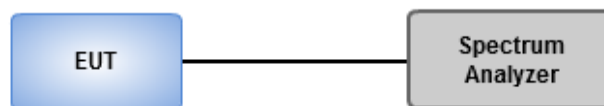

### 3.2.4 Test Result of Emission Bandwidth

For Frequency band 5150~5250 MHz										
Mode	N <sub>TX</sub>	Freq. (MHz)	26dB Bandwidth (MHz)				99% Bandwidth (MHz)			
			Chain 0	Chain 1	Chain 2	Chain 3	Chain 0	Chain 1	Chain 2	Chain 3
11a	2	5180	21.68	21.04	---	---	16.58	16.50	---	---
11a	2	5200	21.45	20.87	---	---	16.58	16.50	---	---
11a	2	5240	21.62	21.10	---	---	16.57	16.50	---	---
HT20	2	5180	22.26	21.62	---	---	17.67	17.65	---	---
HT20	2	5200	22.32	21.62	---	---	17.66	17.64	---	---
HT20	2	5240	22.43	22.67	---	---	17.69	17.64	---	---
HT40	2	5190	43.13	42.67	---	---	35.76	35.80	---	---
HT40	2	5230	43.59	43.36	---	---	35.82	35.86	---	---

For Frequency band 5250~5350 MHz											
Mode	N <sub>TX</sub>	Freq. (MHz)	26dB Bandwidth (MHz)				99% Bandwidth (MHz)				Power Limit (dBm)
			Chain 0	Chain 1	Chain 2	Chain 3	Chain 0	Chain 1	Chain 2	Chain 3	
11a	2	5260	21.97	22.03	---	---	16.49	16.57	---	---	24.00
11a	2	5300	22.43	21.04	---	---	16.56	16.51	---	---	24.00
11a	2	5320	21.22	22.32	---	---	16.55	16.52	---	---	24.00
HT20	2	5260	21.80	22.32	---	---	17.68	17.64	---	---	24.00
HT20	2	5300	21.74	22.61	---	---	17.67	17.64	---	---	24.00
HT20	2	5320	21.57	21.91	---	---	17.65	17.68	---	---	24.00
HT40	2	5270	42.78	43.83	---	---	35.82	35.88	---	---	24.00
HT40	2	5310	43.01	42.55	---	---	35.78	35.82	---	---	24.00

For Frequency band 5470~5725 MHz

Mode	N <sub>TX</sub>	Freq. (MHz)	26dB Bandwidth (MHz)				99% Bandwidth (MHz)				Power Limit (dBm)
			Chain 0	Chain 1	Chain 2	Chain 3	Chain 0	Chain 1	Chain 2	Chain 3	
11a	2	5500	21.10	21.68	---	---	16.55	16.49	---	---	24.00
11a	2	5580	25.04	26.03	---	---	16.63	16.77	---	---	24.00
11a	2	5700	21.04	22.03	---	---	16.55	16.53	---	---	24.00
HT20	2	5500	21.33	21.57	---	---	17.64	17.66	---	---	24.00
HT20	2	5580	22.55	27.88	---	---	17.69	17.77	---	---	24.00
HT20	2	5700	21.10	21.39	---	---	17.64	17.65	---	---	24.00
HT40	2	5510	43.36	42.78	---	---	35.82	35.86	---	---	24.00
HT40	2	5590	47.30	71.54	---	---	36.00	36.28	---	---	24.00
HT40	2	5670	44.29	51.01	---	---	35.84	36.06	---	---	24.00

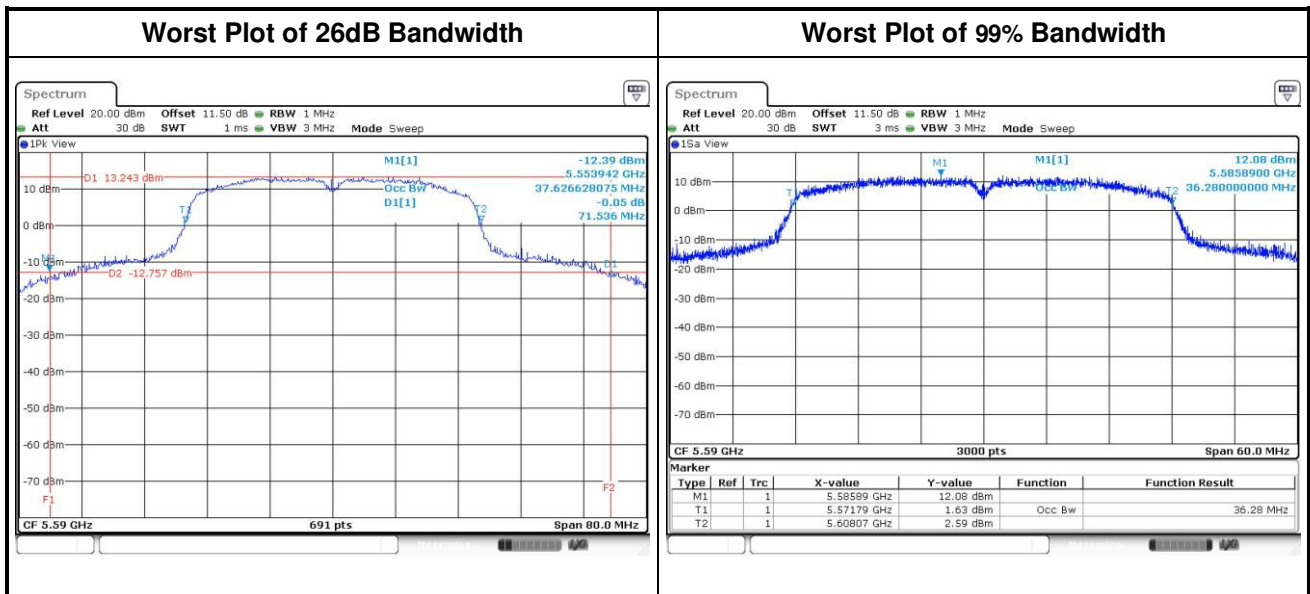

For Frequency band 5725-5850 MHz

Mode	N <sub>TX</sub>	Freq. (MHz)	OBW Bandwidth (MHz)				6dB Bandwidth (MHz)				6dB BW Limit (MHz)
			Chain 0	Chain 1	Chain 2	Chain 3	Chain 0	Chain 1	Chain 2	Chain 3	
11a	2	5745	16.58	16.57	---	---	16.35	16.06	---	---	0.5
11a	2	5785	16.82	16.67	---	---	15.88	15.42	---	---	0.5
11a	2	5825	16.64	16.74	---	---	16.35	16.29	---	---	0.5
HT20	2	5745	17.67	17.65	---	---	16.93	16.00	---	---	0.5
HT20	2	5785	17.95	17.85	---	---	16.52	16.58	---	---	0.5
HT20	2	5825	17.72	17.87	---	---	16.52	15.94	---	---	0.5
HT40	2	5755	35.82	35.80	---	---	35.13	35.01	---	---	0.5
HT40	2	5795	36.02	35.96	---	---	33.86	32.58	---	---	0.5

Worst Plot of 99% Bandwidth

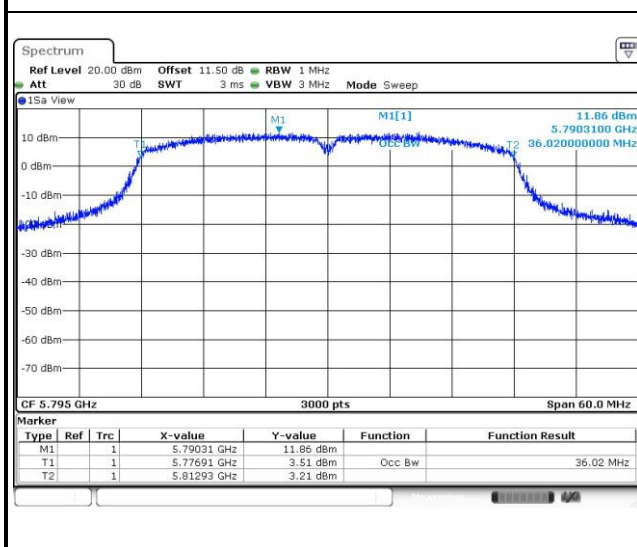

Worst Plot of 6dB Bandwidth

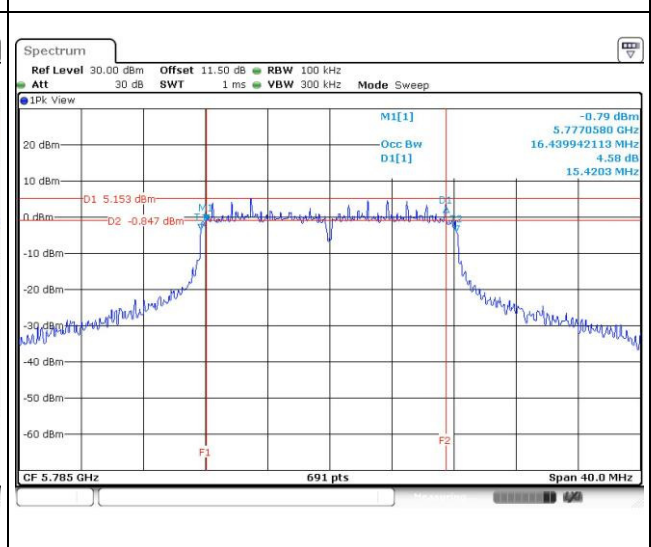

### 3.3 RF Output Power

#### 3.3.1 Limit of RF Output Power

Frequency band 5150-5250 MHz	
Operating Mode	Limit
<input type="checkbox"/> Outdoor access point	Conducted Power: 1 W The maximum e.i.r.p. at any elevation angle above 30 degrees as measured from the horizon must not exceed 125 mW (21 dBm)
<input type="checkbox"/> Indoor access point	Conducted Power: 1 W
<input type="checkbox"/> Fixed point-to-point access points	Conducted Power: 1 W
<input checked="" type="checkbox"/> Mobile and portable client devices	Conducted Power: 250 mW

Frequency Band (MHz)	Limit
<input checked="" type="checkbox"/> 5250 ~ 5350	250mW or 11dBm+10 log B
<input checked="" type="checkbox"/> 5470 ~ 5725	250mW or 11dBm+10 log B
<input checked="" type="checkbox"/> 5725 ~ 5850	1 W

Note: "B" is the 26dB emission bandwidth in MHz.

#### 3.3.2 Test Procedures

- Power meter
  - Measurements is performed using a wideband gated RF power meter provided that the gate parameters are adjusted such that the power is measured only when the EUT is transmitting at its maximum power control level. Since the measurement is made only during the ON time of the transmitter, no duty cycle correction factor is required

#### 3.3.3 Test Setup

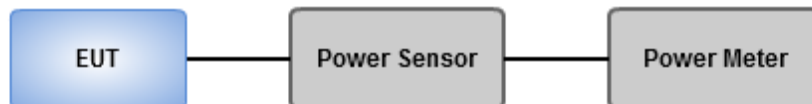

### 3.3.4 Test Result of Maximum Conducted Output Power

For Frequency band 5150~5250 MHz									
Mode	N <sub>TX</sub>	Freq. (MHz)	Conducted Power (dBm)				Total Power (mW)	Total Power (dBm)	Limit (dBm)
			Chain 0	Chain 1	Chain 2	Chain 3			
11a	2	5180	18.01	18.12	---	---	128.105	21.08	24.00
11a	2	5200	18.22	18.04	---	---	130.054	21.14	24.00
11a	2	5240	18.06	18.11	---	---	128.688	21.10	24.00
HT20	2	5180	18.06	18.02	---	---	127.360	21.05	24.00
HT20	2	5200	18.15	18.06	---	---	129.287	21.12	24.00
HT20	2	5240	18.01	18.11	---	---	127.955	21.07	24.00
HT40	2	5190	14.32	14.01	---	---	52.216	17.18	24.00
HT40	2	5230	18.25	18.44	---	---	136.658	<b>21.36</b>	24.00

For Frequency band 5250~5350 MHz									
Mode	N <sub>TX</sub>	Freq. (MHz)	Conducted Power (dBm)				Total Power (mW)	Total Power (dBm)	Limit (dBm)
			Chain 0	Chain 1	Chain 2	Chain 3			
11a	2	5260	18.04	18.13	---	---	128.693	21.10	24.00
11a	2	5300	18.02	18.04	---	---	127.067	21.04	24.00
11a	2	5320	18.12	18.19	---	---	130.781	21.17	24.00
HT20	2	5260	18.03	18.09	---	---	127.950	21.07	24.00
HT20	2	5300	18.03	18.03	---	---	127.066	21.04	24.00
HT20	2	5320	18.02	18.13	---	---	128.400	21.09	24.00
HT40	2	5270	18.34	18.64	---	---	141.348	<b>21.50</b>	24.00
HT40	2	5310	16.32	17.56	---	---	99.871	19.99	24.00

For Frequency band 5470~5725 MHz									
Mode	N <sub>TX</sub>	Freq. (MHz)	Conducted Power (dBm)				Total Power (mW)	Total Power (dBm)	Limit (dBm)
			Chain 0	Chain 1	Chain 2	Chain 3			
11a	2	5500	16.23	17.12	---	---	93.499	19.71	24.00
11a	2	5580	18.01	17.82	---	---	123.775	20.93	24.00
11a	2	5700	15.21	15.68	---	---	70.172	18.46	24.00
HT20	2	5500	16.54	16.31	---	---	87.838	19.44	24.00
HT20	2	5580	17.56	17.62	---	---	114.826	20.60	24.00
HT20	2	5700	14.32	14.43	---	---	54.773	17.39	24.00
HT40	2	5510	15.71	16.02	---	---	77.234	18.88	24.00
HT40	2	5590	18.98	18.72	---	---	153.541	<b>21.86</b>	24.00
HT40	2	5670	17.45	17.02	---	---	105.940	20.25	24.00



For Frequency band 5725-5850 MHz									
Mode	N <sub>TX</sub>	Freq. (MHz)	Conducted Power (dBm)				Total Power (mW)	Total Power (dBm)	Limit (dBm)
			Chain 0	Chain 1	Chain 2	Chain 3			
11a	2	5745	16.22	15.61	---	---	78.271	18.94	30.00
11a	2	5785	18.03	17.54	---	---	120.288	<b>20.80</b>	30.00
11a	2	5825	17.48	17.4	---	---	110.930	20.45	30.00
HT20	2	5745	15.58	15.23	---	---	69.484	18.42	30.00
HT20	2	5785	17.62	17.51	---	---	114.173	20.58	30.00
HT20	2	5825	17.71	17.02	---	---	109.370	20.39	30.00
HT40	2	5755	14.85	14.48	---	---	58.604	17.68	30.00
HT40	2	5795	17.45	16.32	---	---	98.445	19.93	30.00

## 3.4 Peak Power Spectral Density

### 3.4.1 Limit of Peak Power Spectral Density

Frequency band 5150-5250 MHz	
Operating Mode	Limit
<input type="checkbox"/> Outdoor access point	17 dBm / MHz
<input type="checkbox"/> Indoor access point	17 dBm / MHz
<input type="checkbox"/> Fixed point-to-point access points	17 dBm / MHz
<input checked="" type="checkbox"/> Mobile and portable client devices	11 dBm / MHz

Frequency Band (MHz)	Limit
<input checked="" type="checkbox"/> 5250 ~ 5350	11 dBm / MHz
<input checked="" type="checkbox"/> 5470 ~ 5725	11 dBm / MHz
<input checked="" type="checkbox"/> 5725 ~ 5850	30 dBm / 500 kHz

### 3.4.2 Test Procedures

#### For 5150~5250 MHz, 5250~5350 MHz, 5470~5725 MHz

Method SA-1

1. Set RBW = 1 MHz, VBW = 3 MHz, Sweep time = auto, Detector = RMS.
2. Trace average 100 traces.
3. Use the peak marker function to determine the maximum amplitude level.

Method SA-2 Alternative

1. Set RBW = 1 MHz, VBW = 3 MHz, Detector = RMS.
2. Set sweep time  $\geq 10 \times (\text{number of points in sweep}) \times (\text{total on/off period of the transmitted signal})$ .
3. Perform a single sweep.
4. Use the peak marker function to determine the maximum amplitude level.
5. Add  $10 \log(1/x)$ , where x is the duty cycle.

#### For 5725~5850 MHz

Method SA-1

1. Set RBW = 500 kHz, VBW = 2 MHz, Sweep time = auto, Detector = RMS.
2. Trace average 100 traces.
3. Use the peak marker function to determine the maximum amplitude level.

Method SA-2 Alternative

1. Set RBW = 500 kHz, VBW = 2 MHz, Detector = RMS.
2. Set sweep time  $\geq 10 \times (\text{number of points in sweep}) \times (\text{total on/off period of the transmitted signal})$ .
3. Perform a single sweep.
4. Use the peak marker function to determine the maximum amplitude level.
5. Add  $10 \log(1/x)$ , where x is the duty cycle.

### 3.4.3 Test Setup

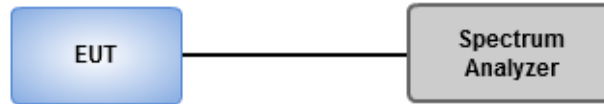

### 3.4.4 Test Result of Peak Power Spectral Density

Frequency band			5150~5250 MHz / 5250~5350 MHz			
Condition			Peak Power Spectral Density (dBm/MHz)			
Mode	N <sub>TX</sub>	Freq. (MHz)	PPSD w/o D.F (dBm/MHz)	Duty Factor (dB)	PPSD with D.F (dBm/MHz)	PPSD Limit (dBm/MHz)
11a	2	5180	7.33	0.00	7.33	10.09
11a	2	5200	7.37	0.00	7.37	10.09
11a	2	5240	7.64	0.00	7.64	10.09
HT20	2	5180	7.29	0.00	7.29	10.09
HT20	2	5200	7.29	0.00	7.29	10.09
HT20	2	5240	7.72	0.00	<b>7.72</b>	10.09
HT40	2	5190	1.35	0.00	1.35	10.09
HT40	2	5230	4.53	0.00	4.53	10.09
11a	2	5260	7.00	0.00	7.00	10.09
11a	2	5300	7.42	0.00	7.42	10.09
11a	2	5320	7.57	0.00	7.57	10.09
HT20	2	5260	7.60	0.00	7.60	10.09
HT20	2	5300	7.32	0.00	7.32	10.09
HT20	2	5320	7.37	0.00	7.37	10.09
HT40	2	5270	4.89	0.00	4.89	10.09
HT40	2	5310	3.53	0.00	3.53	10.09

Note:

1. D.F is duty factor.
2. Test result is bin-by-bin summing measured value of each TX port.
3. Directional gain =  $3.9 + 10 * \log(2/1) = 6.91 \text{ dBi} > 6 \text{ dBi}$ .  
For 5150~5350MHz:  
Limit shall be reduced to  $11 \text{ dBm} - (6.91 \text{ dBi} - 6 \text{ dBi}) = 10.09 \text{ dBm}$ .

Frequency band			5470~5725 MHz			
Condition			Peak Power Spectral Density (dBm/MHz)			
Mode	N <sub>TX</sub>	Freq. (MHz)	PPSD w/o D.F (dBm/MHz)	Duty Factor (dB)	PPSD with D.F (dBm/MHz)	PPSD Limit (dBm/MHz)
11a	2	5500	6.13	0.00	6.13	9.99
11a	2	5580	7.23	0.00	7.23	9.99
11a	2	5700	4.76	0.00	4.76	9.99
HT20	2	5500	5.51	0.00	5.51	9.99
HT20	2	5580	6.53	0.00	6.53	9.99
HT20	2	5700	3.26	0.00	3.26	9.99
HT40	2	5510	3.16	0.00	3.16	9.99
HT40	2	5590	5.29	0.00	5.29	9.99
HT40	2	5670	3.47	0.00	3.47	9.99

Note:

1. D.F is duty factor.
2. Test result is bin-by-bin summing measured value of each TX port.
3. Directional gain =  $4 + 10 * \log(2/1) = 7.01 \text{ dBi} > 6 \text{ dBi}$ .  
For 5500~5700MHz:  
Limit shall be reduced to  $11 \text{ dBm} - (7.01 \text{ dBi} - 6 \text{ dBi}) = 9.99 \text{ dBm}$ .

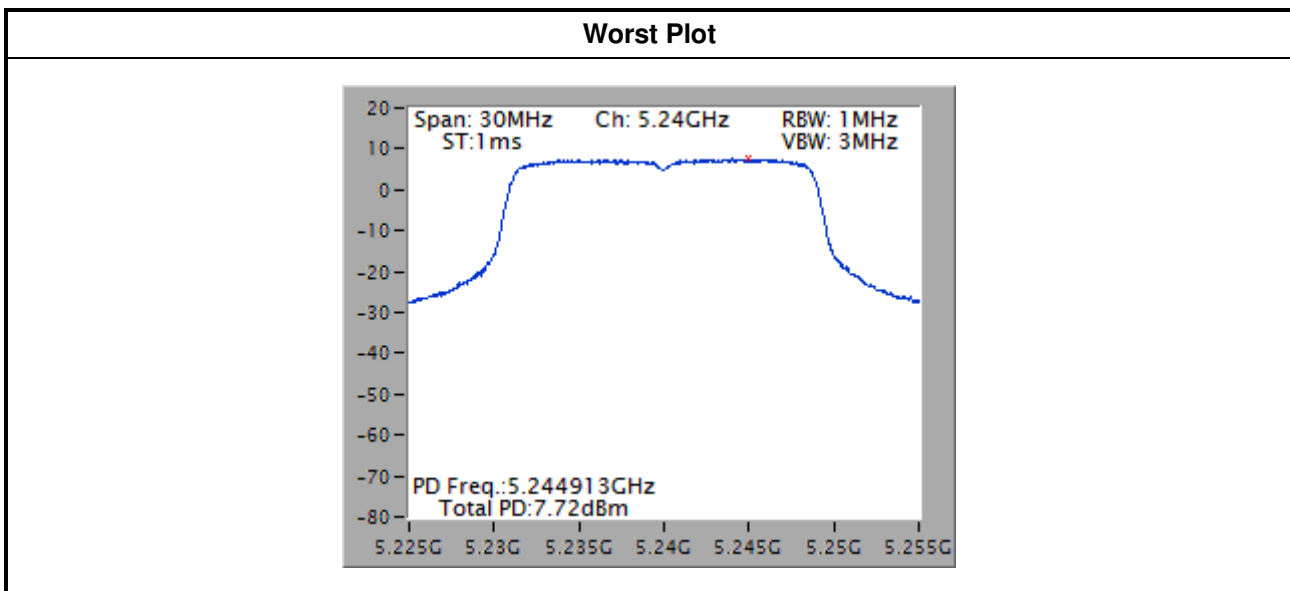

Frequency band			5725-5850 MHz			
Condition			Peak Power Spectral Density (dBm/500kHz)			
Mode	N <sub>TX</sub>	Freq. (MHz)	PPSD w/o D.F (dBm/500kHz)	Duty Factor (dB)	PPSD with D.F (dBm/500kHz)	PPSD Limit (dBm/500kHz)
11a	2	5745	3.94	0.00	3.94	28.99
11a	2	5785	5.35	0.00	<b>5.35</b>	28.99
11a	2	5825	5.18	0.00	5.18	28.99
HT20	2	5745	3.43	0.00	3.43	28.99
HT20	2	5785	5.31	0.00	5.31	28.99
HT20	2	5825	4.94	0.00	4.94	28.99
HT40	2	5755	0.05	0.00	0.05	28.99
HT40	2	5795	2.42	0.00	2.42	28.99

Note:

1. D.F is duty factor.
2. Test result is bin-by-bin summing measured value of each TX port.
3. Directional gain =  $4 + 10 * \log(2/1) = 7.01 \text{ dBi} > 6 \text{ dBi}$ .  
For 5745~5825MHz:  
Limit shall be reduced to  $30 \text{ dBm} - (7.01 \text{ dBi} - 6 \text{ dBi}) = 28.99 \text{ dBm}$ .

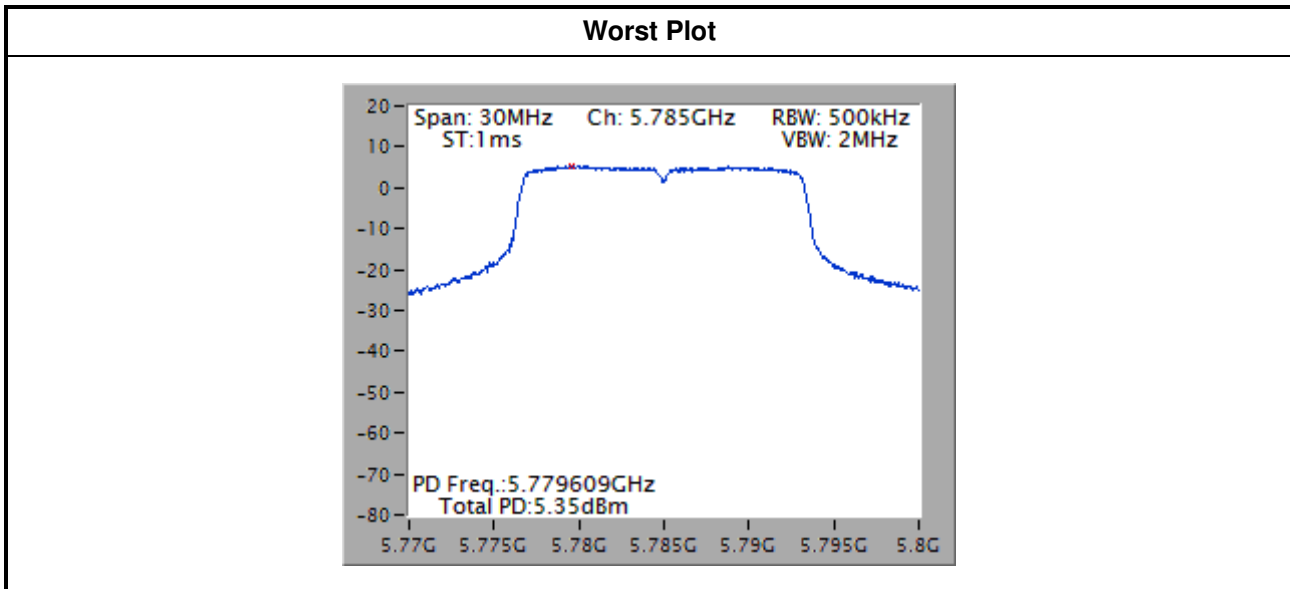

### 3.5 Transmitter Radiated and Band Edge Emissions

#### 3.5.1 Limit of Transmitter Radiated and Band Edge Emissions

Restricted Band Emissions Limit			
Frequency Range (MHz)	Field Strength (uV/m)	Field Strength (dBuV/m)	Measure Distance (m)
0.009~0.490	2400/F(kHz)	48.5 - 13.8	300
0.490~1.705	24000/F(kHz)	33.8 - 23	30
1.705~30.0	30	29	30
30~88	100	40	3
88~216	150	43.5	3
216~960	200	46	3
Above 960	500	54	3

**Note 1:**  
Qusai-Peak value is measured for frequency below 1GHz except for 9–90 kHz, 110–490 kHz frequency band. Peak and average value are measured for frequency above 1GHz. The limit on average radio frequency emission is as above table. The limit on peak radio frequency emissions is 20 dB above the maximum permitted average emission limit

**Note 2:**  
Measurements may be performed at a distance other than what is specified provided. When performing measurements at a distance other than that specified, the results shall be extrapolated to the specified distance using an extrapolation factor as below, Frequency at or above 30 MHz: 20 dB/decade Frequency below 30 MHz: 40 dB/decade.

Un-restricted band emissions above 1GHz Limit	
Operating Band	Limit
5.15 - 5.25 GHz	e.i.r.p. -27 dBm [68.2 dBuV/m@3m]
5.25 - 5.35 GHz	e.i.r.p. -27 dBm [68.2 dBuV/m@3m]
5.47 - 5.725 GHz	e.i.r.p. -27 dBm [68.2 dBuV/m@3m]
5.725 - 5.850 GHz	5.715 5.725 GHz: e.i.r.p. -17 dBm [78.2 dBuV/m@3m] 5.825 5.835 GHz: e.i.r.p. -17 dBm [78.2 dBuV/m@3m] Other un-restricted band: e.i.r.p. -27 dBm [68.2 dBuV/m@3m]

**Note 1:** Measurements may be performed at a distance other than the limit distance provided they are not performed in the near field and the emissions to be measured can be detected by the measurement equipment. When performing measurements at a distance other than that specified, the results shall be extrapolated to the specified distance using an extrapolation factor of 20 dB/decade (inverse of linear distance for field-strength measurements, inverse of linear distance-squared for power-density measurements).

### 3.5.2 Test Procedures

1. Measurement is made at a semi-anechoic chamber that incorporates a turntable allowing a EUT rotation of 360°. A continuously-rotating, remotely-controlled turntable is installed at the test site to support the EUT and facilitate determination of the direction of maximum radiation for each EUT emission frequency. The EUT is placed at test table. For emissions testing at or below 1 GHz, the table height is 80 cm above the reference ground plane. For emission measurements above 1 GHz, the table height is 1.5 m
2. Measurement is made with the antenna positioned in both the horizontal and vertical planes of polarization. The measurement antenna is varied in height (1m ~ 4m) above the reference ground plane to obtain the maximum signal strength. Distance between EUT and antenna is 3 m.
3. This investigation is performed with the EUT rotated 360°, the antenna height scanned between 1 m and 4 m, and the antenna rotated to repeat the measurements for both the horizontal and vertical antenna polarizations.

Note:

1. 120kHz measurement bandwidth of test receiver and Quasi-peak detector is for radiated emission below 1GHz.
2. RBW=1MHz, VBW=3MHz and Peak detector is for peak measured value of radiated emission above 1GHz.
3. RBW=1MHz, VBW=1/T and Peak detector is for average measured value of radiated emission above 1GHz.



### 3.5.3 Test Setup

#### Radiated Emissions below 1 GHz

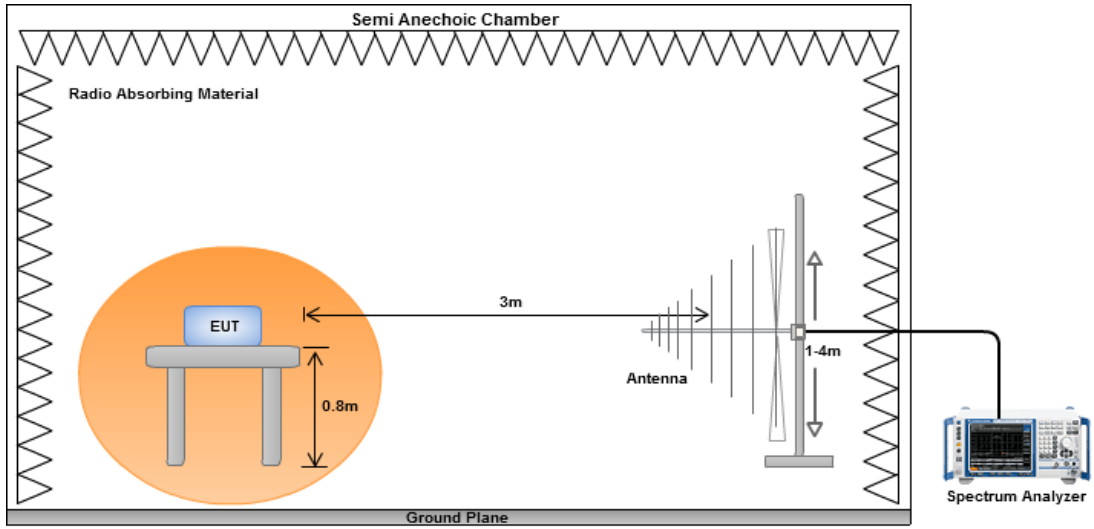

#### Radiated Emissions above 1 GHz

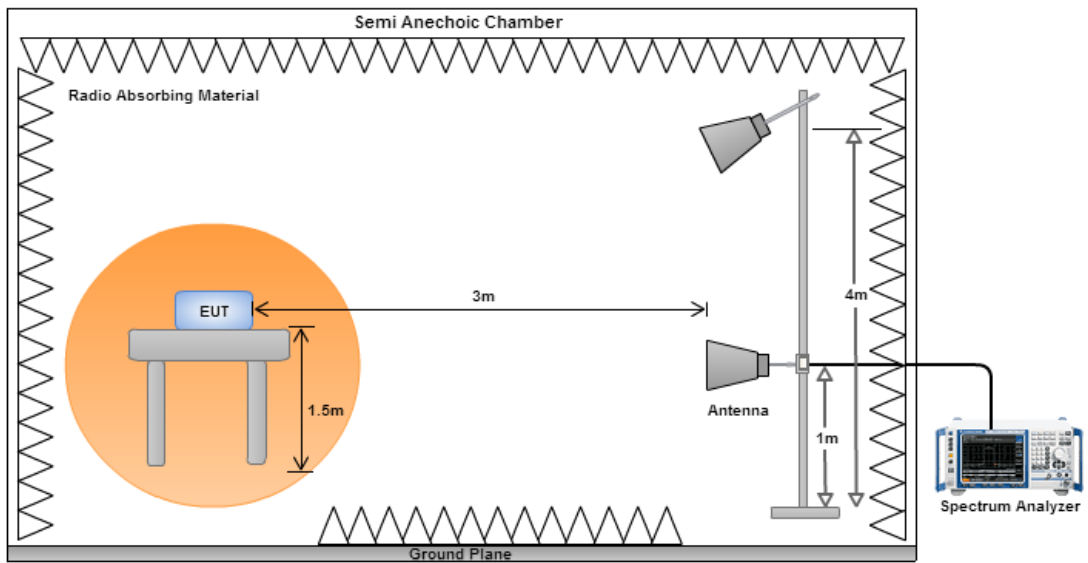

### Test Configuration 1: Dipole antenna

#### 3.5.4 Transmitter Radiated Unwanted Emissions (Below 1GHz)

<b>Modulation</b>	HT40	<b>Test Freq. (MHz)</b>	5590
<b>Polarization</b>	Horizontal	<b>Test Configuration</b>	1

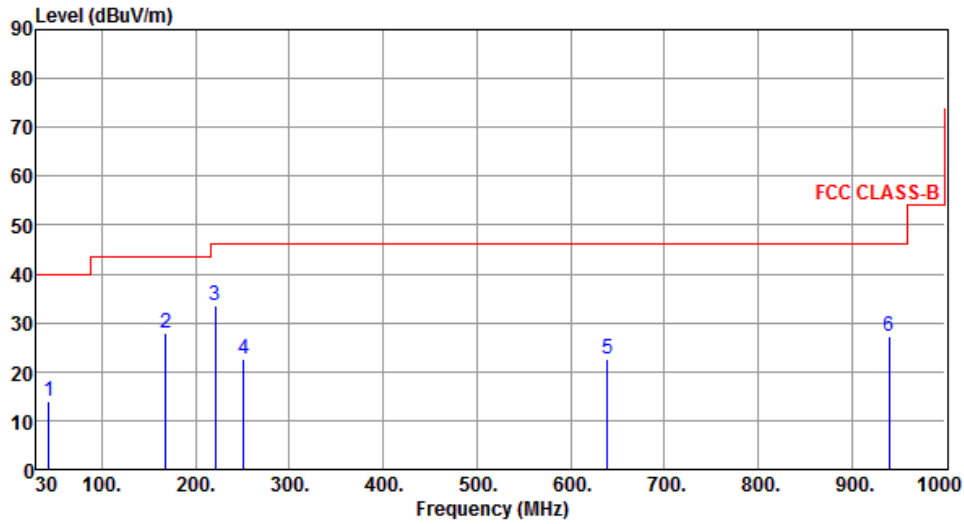

	Freq. MHz	Emission level dBuV/m	Limit dBuV/m	Margin dB	SA reading dBuV	Factor dB	Remark	ANT High cm	Turn Table deg
1	43.58	14.06	40.00	-25.94	26.98	-12.92	Peak	---	---
2	167.74	27.85	43.50	-15.65	41.84	-13.99	Peak	---	---
3	221.09	33.41	46.00	-12.59	49.30	-15.89	Peak	---	---
4	251.16	22.54	46.00	-23.46	37.25	-14.71	Peak	---	---
5	639.16	22.71	46.00	-23.29	27.94	-5.23	Peak	---	---
6	939.86	27.23	46.00	-18.77	27.24	-0.01	Peak	---	---

Note 1: Emission Level (dBuV/m) = SA Reading (dBuV/m) + Factor\* (dB)

\*Factor includes antenna factor, cable loss and amplifier gain

Note 2: Margin (dB) = Emission level (dBuV/m) – Limit (dBuV/m).

Note 3: All spurious emissions below 30MHz are more than 20 dB below the limit.

<b>Modulation</b>	HT40	<b>Test Freq. (MHz)</b>	5590
<b>Polarization</b>	Vertical	<b>Test Configuration</b>	1

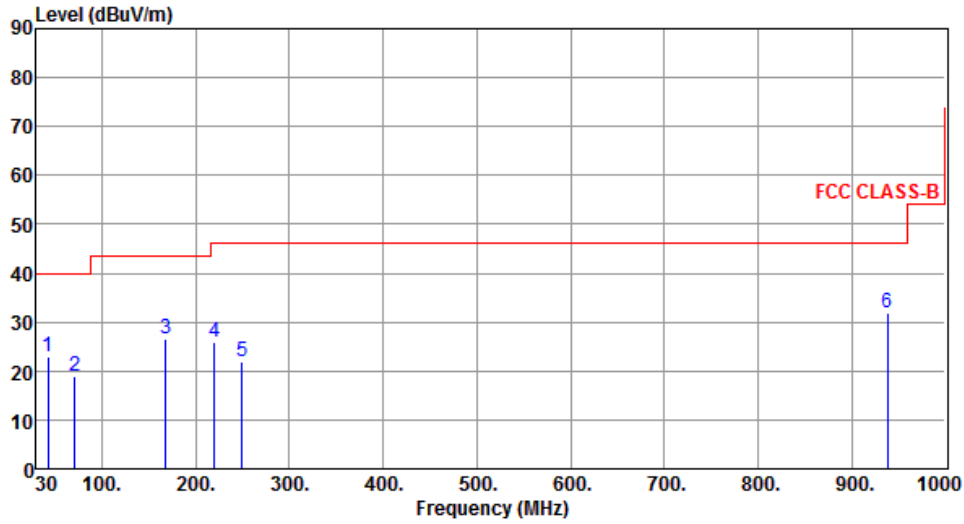

	Freq. MHz	Emission level dBuV/m	Limit dBuV/m	Margin dB	SA reading dBuV	Factor dB	Remark	ANT High cm	Turn Table deg
1	42.61	22.88	40.00	-17.12	35.86	-12.98	Peak	---	---
2	70.74	19.02	40.00	-20.98	34.94	-15.92	Peak	---	---
3	167.74	26.49	43.50	-17.01	40.48	-13.99	Peak	---	---
4	220.12	25.81	46.00	-20.19	41.77	-15.96	Peak	---	---
5	249.22	21.79	46.00	-24.21	36.53	-14.74	Peak	---	---
6	937.92	32.04	46.00	-13.96	32.08	-0.04	Peak	---	---

Note 1: Emission Level (dBuV/m) = SA Reading (dBuV/m) + Factor\* (dB)

\*Factor includes antenna factor , cable loss and amplifier gain

Note 2: Margin (dB) = Emission level (dBuV/m) – Limit (dBuV/m).

Note 3: All spurious emissions below 30MHz are more than 20 dB below the limit.

<b>Modulation</b>	11a	<b>Test Freq. (MHz)</b>	5785
<b>Polarization</b>	Horizontal	<b>Test Configuration</b>	1

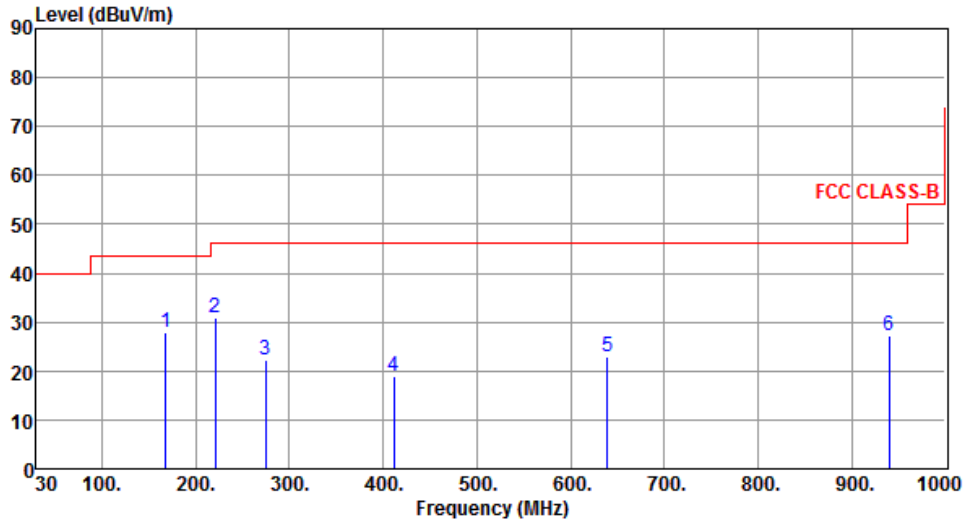

	Freq. MHz	Emission level dBuV/m	Limit dBuV/m	Margin dB	SA reading dBuV	Factor dB	Remark	ANT High cm	Turn Table deg
1	167.74	27.84	43.50	-15.66	41.83	-13.99	Peak	---	---
2	221.09	30.88	46.00	-15.12	46.77	-15.89	Peak	---	---
3	274.44	22.21	46.00	-23.79	35.89	-13.68	Peak	---	---
4	411.21	18.92	46.00	-27.08	28.67	-9.75	Peak	---	---
5	639.16	22.99	46.00	-23.01	28.22	-5.23	Peak	---	---
6	939.86	27.34	46.00	-18.66	27.35	-0.01	Peak	---	---

Note 1: Emission Level (dBuV/m) = SA Reading (dBuV/m) + Factor\* (dB)

\*Factor includes antenna factor , cable loss and amplifier gain

Note 2: Margin (dB) = Emission level (dBuV/m) – Limit (dBuV/m).

Note 3: All spurious emissions below 30MHz are more than 20 dB below the limit.

<b>Modulation</b>	11a	<b>Test Freq. (MHz)</b>	5785
<b>Polarization</b>	Vertical	<b>Test Configuration</b>	1

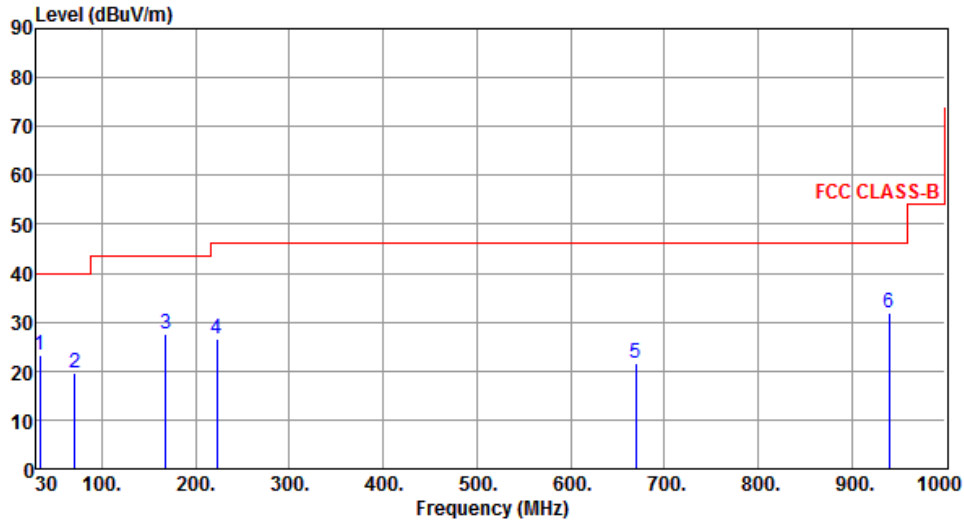

	Freq. MHz	Emission level dBuV/m	Limit dBuV/m	Margin dB	SA reading dBuV	Factor dB	Remark	ANT High cm	Turn Table deg
1	33.88	23.34	40.00	-16.66	36.83	-13.49	Peak	---	---
2	70.74	19.50	40.00	-20.50	35.42	-15.92	Peak	---	---
3	167.74	27.69	43.50	-15.81	41.68	-13.99	Peak	---	---
4	223.03	26.49	46.00	-19.51	42.27	-15.78	Peak	---	---
5	669.23	21.58	46.00	-24.42	26.39	-4.81	Peak	---	---
6	939.86	31.78	46.00	-14.22	31.79	-0.01	Peak	---	---

Note 1: Emission Level (dBuV/m) = SA Reading (dBuV/m) + Factor\* (dB)

\*Factor includes antenna factor , cable loss and amplifier gain

Note 2: Margin (dB) = Emission level (dBuV/m) – Limit (dBuV/m).

Note 3: All spurious emissions below 30MHz are more than 20 dB below the limit.

### 3.5.5 Transmitter Radiated Unwanted Emissions (Above 1GHz) for 11a

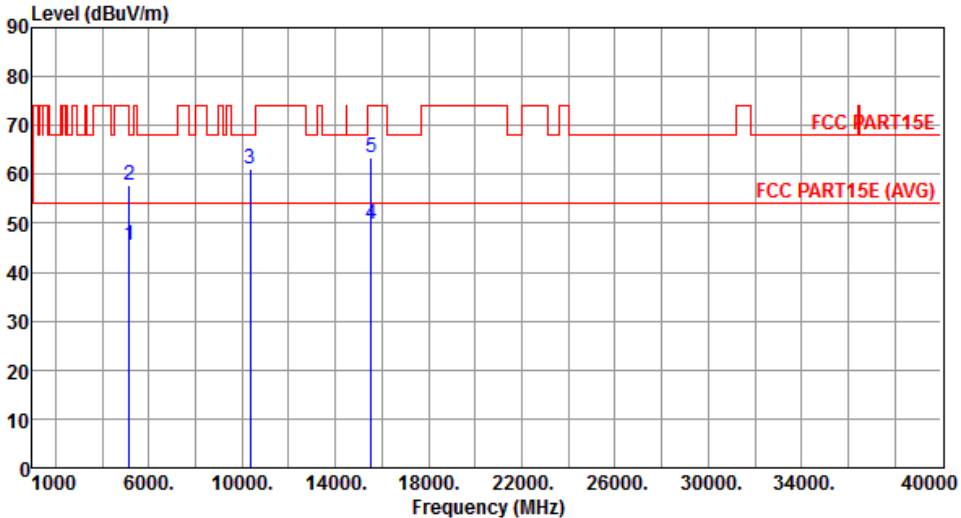
Modulation	11a	Test Freq. (MHz)	5180																																																																					
Polarization	Horizontal	Test Configuration	1																																																																					
																																																																								
	<table border="1"> <thead> <tr> <th>Freq.</th> <th>Emission level</th> <th>Limit</th> <th>Margin</th> <th>SA reading</th> <th>Factor</th> <th>Remark</th> <th>ANT High</th> <th>Turn Table</th> </tr> <tr> <th>MHz</th> <th>dBuV/m</th> <th>dBuV/m</th> <th>dB</th> <th>dBuV</th> <th>dB</th> <th></th> <th>cm</th> <th>deg</th> </tr> </thead> <tbody> <tr> <td>1</td> <td>5150.00</td> <td>45.40</td> <td>54.00</td> <td>-8.60</td> <td>39.09</td> <td>6.31</td> <td>Average</td> <td>355</td> <td>326</td> </tr> <tr> <td>2</td> <td>5150.00</td> <td>57.89</td> <td>74.00</td> <td>-16.11</td> <td>51.58</td> <td>6.31</td> <td>Peak</td> <td>355</td> <td>326</td> </tr> <tr> <td>3</td> <td>10360.00</td> <td>61.03</td> <td>68.20</td> <td>-7.17</td> <td>44.69</td> <td>16.34</td> <td>Peak</td> <td>150</td> <td>153</td> </tr> <tr> <td>4</td> <td>15540.00</td> <td>49.68</td> <td>54.00</td> <td>-4.32</td> <td>32.18</td> <td>17.50</td> <td>Average</td> <td>150</td> <td>245</td> </tr> <tr> <td>5</td> <td>15540.00</td> <td>63.29</td> <td>74.00</td> <td>-10.71</td> <td>45.79</td> <td>17.50</td> <td>Peak</td> <td>150</td> <td>245</td> </tr> </tbody> </table>	Freq.	Emission level	Limit	Margin	SA reading	Factor	Remark	ANT High	Turn Table	MHz	dBuV/m	dBuV/m	dB	dBuV	dB		cm	deg	1	5150.00	45.40	54.00	-8.60	39.09	6.31	Average	355	326	2	5150.00	57.89	74.00	-16.11	51.58	6.31	Peak	355	326	3	10360.00	61.03	68.20	-7.17	44.69	16.34	Peak	150	153	4	15540.00	49.68	54.00	-4.32	32.18	17.50	Average	150	245	5	15540.00	63.29	74.00	-10.71	45.79	17.50	Peak	150	245			
Freq.	Emission level	Limit	Margin	SA reading	Factor	Remark	ANT High	Turn Table																																																																
MHz	dBuV/m	dBuV/m	dB	dBuV	dB		cm	deg																																																																
1	5150.00	45.40	54.00	-8.60	39.09	6.31	Average	355	326																																																															
2	5150.00	57.89	74.00	-16.11	51.58	6.31	Peak	355	326																																																															
3	10360.00	61.03	68.20	-7.17	44.69	16.34	Peak	150	153																																																															
4	15540.00	49.68	54.00	-4.32	32.18	17.50	Average	150	245																																																															
5	15540.00	63.29	74.00	-10.71	45.79	17.50	Peak	150	245																																																															
<p>Note 1: Emission Level (dBuV/m) = SA Reading (dBuV/m) + Factor* (dB)            *Factor includes antenna factor , cable loss and amplifier gain            Note 2: Margin (dB) = Emission level (dBuV/m) – Limit (dBuV/m).</p>																																																																								

<b>Modulation</b>	11a	<b>Test Freq. (MHz)</b>	5180
<b>Polarization</b>	Vertical	<b>Test Configuration</b>	1

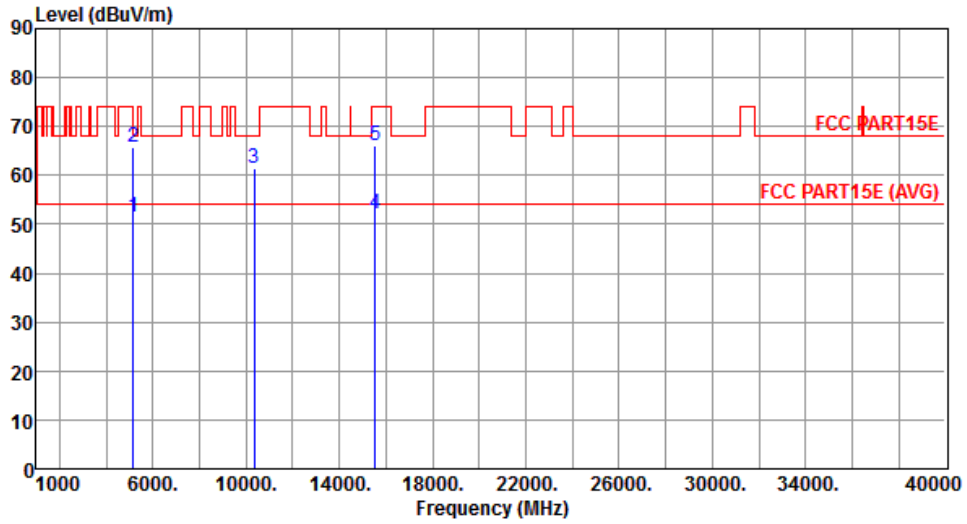

	Freq. MHz	Emission level dBuV/m	Limit dBuV/m	Margin dB	SA reading dBuV	Factor dB	Remark	ANT High cm	Turn Table deg
1	5150.00	51.48	54.00	-2.52	45.17	6.31	Average	150	148
2	5150.00	65.66	74.00	-8.34	59.35	6.31	Peak	150	148
3	10360.00	61.56	68.20	-6.64	45.22	16.34	Peak	150	185
4	15540.00	52.16	54.00	-1.84	34.66	17.50	Average	175	184
5	15540.00	66.09	74.00	-7.91	48.59	17.50	Peak	175	184

Note 1: Emission Level (dBuV/m) = SA Reading (dBuV/m) + Factor\* (dB)

\*Factor includes antenna factor , cable loss and amplifier gain

Note 2: Margin (dB) = Emission level (dBuV/m) – Limit (dBuV/m).

<b>Modulation</b>	11a	<b>Test Freq. (MHz)</b>	5200
<b>Polarization</b>	Horizontal	<b>Test Configuration</b>	1

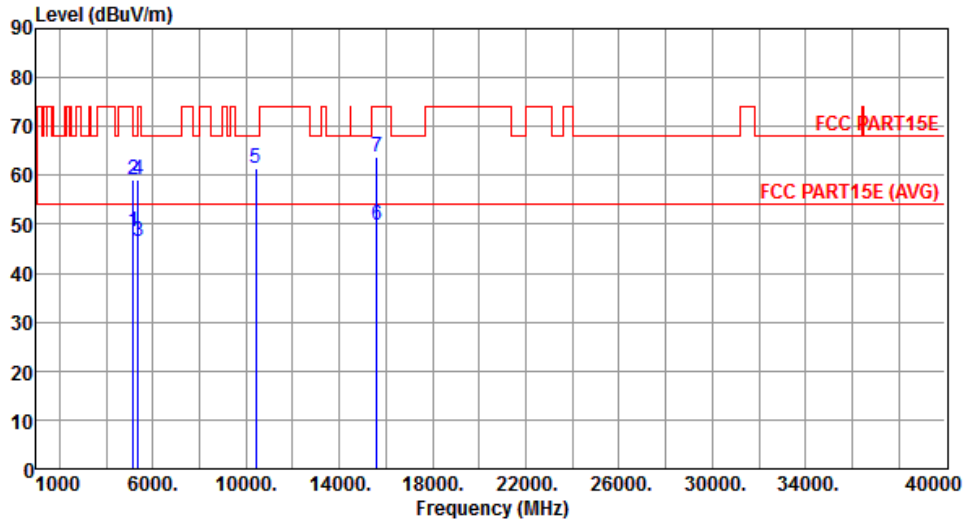

	Freq. MHz	Emission level dBuV/m	Limit dBuV/m	Margin dB	SA reading dBuV	Factor dB	Remark	ANT High cm	Turn Table deg
1	5150.00	48.33	54.00	-5.67	42.02	6.31	Average	351	322
2	5150.00	58.95	74.00	-15.05	52.64	6.31	Peak	351	322
3	5350.00	46.62	54.00	-7.38	40.00	6.62	Average	351	322
4	5350.00	59.08	74.00	-14.92	52.46	6.62	Peak	351	322
5	10400.00	61.48	68.20	-6.72	45.06	16.42	Peak	154	158
6	15600.00	49.93	54.00	-4.07	32.55	17.38	Average	151	242
7	15600.00	63.69	74.00	-10.31	46.31	17.38	Peak	151	242

Note 1: Emission Level (dBuV/m) = SA Reading (dBuV/m) + Factor\* (dB)

\*Factor includes antenna factor , cable loss and amplifier gain

Note 2: Margin (dB) = Emission level (dBuV/m) – Limit (dBuV/m).



<b>Modulation</b>	11a	<b>Test Freq. (MHz)</b>	5200
<b>Polarization</b>	Vertical	<b>Test Configuration</b>	1

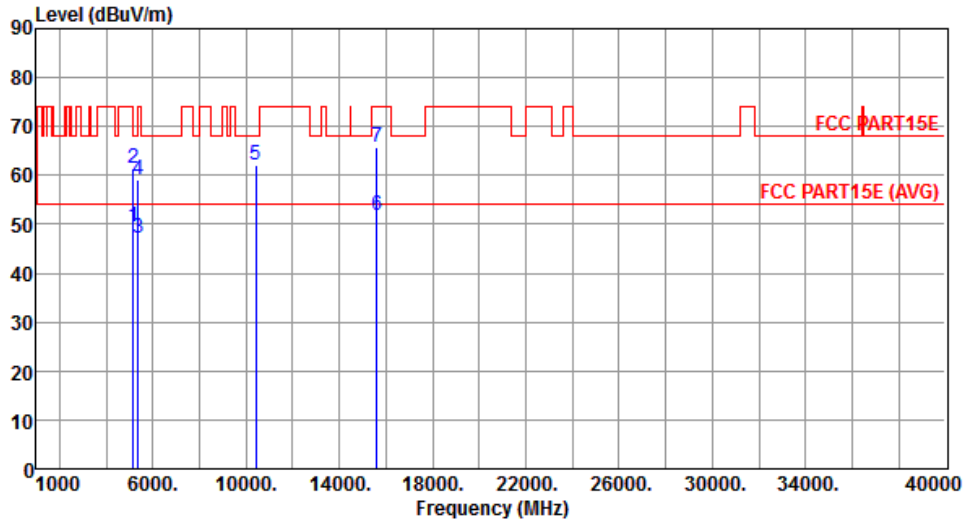

	Freq. MHz	Emission level dBuV/m	Limit dBuV/m	Margin dB	SA reading dBuV	Factor dB	Remark	ANT High cm	Turn Table deg
1	5150.00	49.44	54.00	-4.56	43.13	6.31	Average	165	202
2	5150.00	61.42	74.00	-12.58	55.11	6.31	Peak	165	202
3	5350.00	46.99	54.00	-7.01	40.37	6.62	Average	165	202
4	5350.00	59.23	74.00	-14.77	52.61	6.62	Peak	165	202
5	10400.00	61.94	68.20	-6.26	45.52	16.42	Peak	158	173
6	15600.00	51.91	54.00	-2.09	34.53	17.38	Average	152	191
7	15600.00	65.68	74.00	-8.32	48.30	17.38	Peak	152	191

Note 1: Emission Level (dBuV/m) = SA Reading (dBuV/m) + Factor\* (dB)

\*Factor includes antenna factor , cable loss and amplifier gain

Note 2: Margin (dB) = Emission level (dBuV/m) – Limit (dBuV/m).

<b>Modulation</b>	11a	<b>Test Freq. (MHz)</b>	5240
<b>Polarization</b>	Horizontal	<b>Test Configuration</b>	1

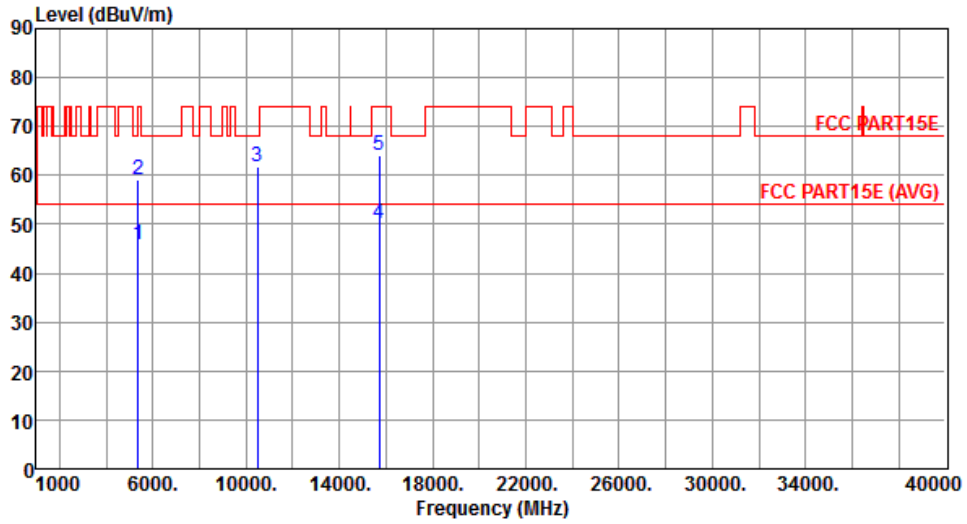

	Freq. MHz	Emission level dBuV/m	Limit dBuV/m	Margin dB	SA reading dBuV	Factor dB	Remark	ANT High cm	Turn Table deg
1	5350.00	45.76	54.00	-8.24	39.14	6.62	Average	342	316
2	5350.00	59.15	74.00	-14.85	52.53	6.62	Peak	342	316
3	10480.00	61.85	68.20	-6.35	45.29	16.56	Peak	151	153
4	15720.00	50.10	54.00	-3.90	32.95	17.15	Average	155	246
5	15720.00	63.96	74.00	-10.04	46.81	17.15	Peak	155	246

Note 1: Emission Level (dBuV/m) = SA Reading (dBuV/m) + Factor\* (dB)

\*Factor includes antenna factor , cable loss and amplifier gain

Note 2: Margin (dB) = Emission level (dBuV/m) – Limit (dBuV/m).

<b>Modulation</b>	11a	<b>Test Freq. (MHz)</b>	5240
<b>Polarization</b>	Vertical	<b>Test Configuration</b>	1

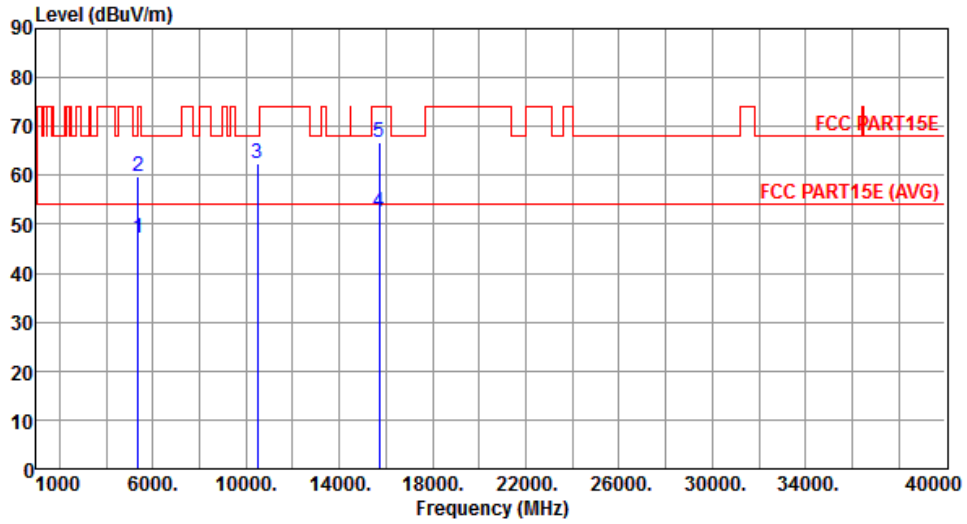

	Freq. MHz	Emission level dBuV/m	Limit dBuV/m	Margin dB	SA reading dBuV	Factor dB	Remark	ANT High cm	Turn Table deg
1	5350.00	47.15	54.00	-6.85	40.53	6.62	Average	159	162
2	5350.00	59.77	74.00	-14.23	53.15	6.62	Peak	159	162
3	10480.00	62.27	68.20	-5.93	45.71	16.56	Peak	153	178
4	15720.00	52.56	54.00	-1.44	35.41	17.15	Average	150	192
5	15720.00	66.92	74.00	-7.08	49.77	17.15	Peak	152	191

Note 1: Emission Level (dBuV/m) = SA Reading (dBuV/m) + Factor\* (dB)

\*Factor includes antenna factor , cable loss and amplifier gain

Note 2: Margin (dB) = Emission level (dBuV/m) – Limit (dBuV/m).

<b>Modulation</b>	11a	<b>Test Freq. (MHz)</b>	5260
<b>Polarization</b>	Horizontal	<b>Test Configuration</b>	1

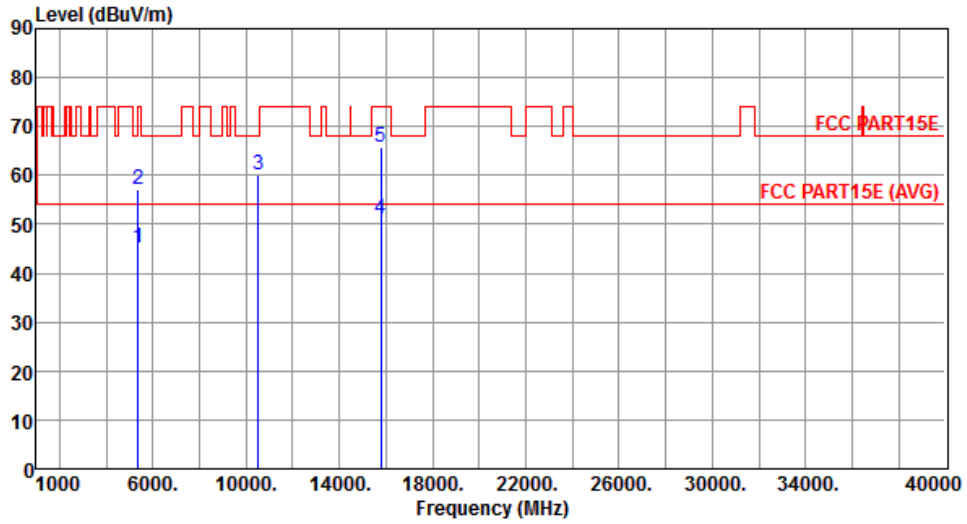

	Freq. MHz	Emission level dBuV/m	Limit dBuV/m	Margin dB	SA reading dBuV	Factor dB	Remark	ANT High cm	Turn Table deg
1	5350.00	45.13	54.00	-8.87	38.51	6.62	Average	150	229
2	5350.00	57.19	74.00	-16.81	50.57	6.62	Peak	150	229
3	10520.00	60.07	68.20	-8.13	43.47	16.60	Peak	150	156
4	15780.00	51.23	54.00	-2.77	34.18	17.05	Average	235	128
5	15780.00	65.61	74.00	-8.39	48.56	17.05	Peak	235	128

Note 1: Emission Level (dBuV/m) = SA Reading (dBuV/m) + Factor\* (dB)

\*Factor includes antenna factor , cable loss and amplifier gain

Note 2: Margin (dB) = Emission level (dBuV/m) – Limit (dBuV/m).

<b>Modulation</b>	11a	<b>Test Freq. (MHz)</b>	5260
<b>Polarization</b>	Vertical	<b>Test Configuration</b>	1

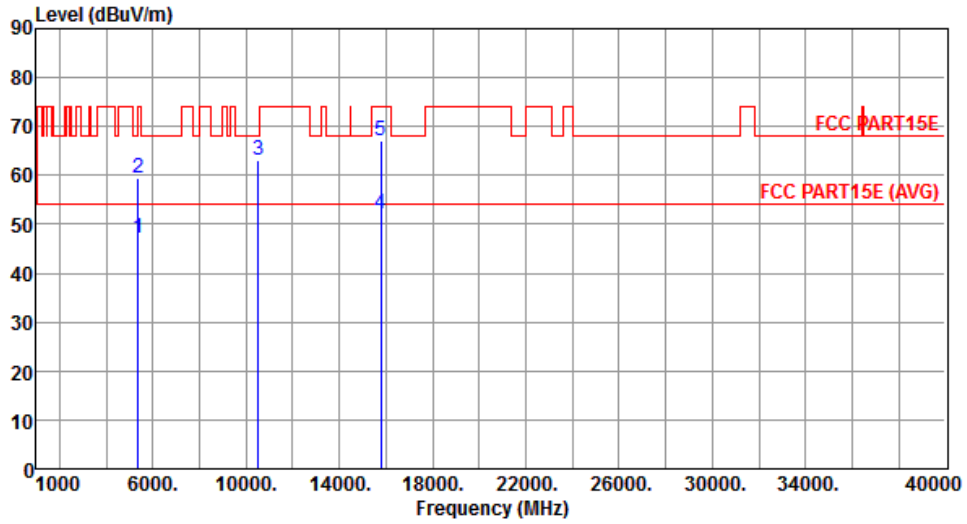

	Freq. MHz	Emission level dBuV/m	Limit dBuV/m	Margin dB	SA reading dBuV	Factor dB	Remark	ANT High cm	Turn Table deg
1	5350.00	47.28	54.00	-6.72	40.66	6.62	Average	150	90
2	5350.00	59.33	74.00	-14.67	52.71	6.62	Peak	150	90
3	10520.00	63.07	68.20	-5.13	46.47	16.60	Peak	150	185
4	15780.00	51.98	54.00	-2.02	34.93	17.05	Average	150	189
5	15780.00	67.11	74.00	-6.89	50.06	17.05	Peak	150	189

Note 1: Emission Level (dBuV/m) = SA Reading (dBuV/m) + Factor\* (dB)

\*Factor includes antenna factor , cable loss and amplifier gain

Note 2: Margin (dB) = Emission level (dBuV/m) – Limit (dBuV/m).

<b>Modulation</b>	11a	<b>Test Freq. (MHz)</b>	5300
<b>Polarization</b>	Horizontal	<b>Test Configuration</b>	1

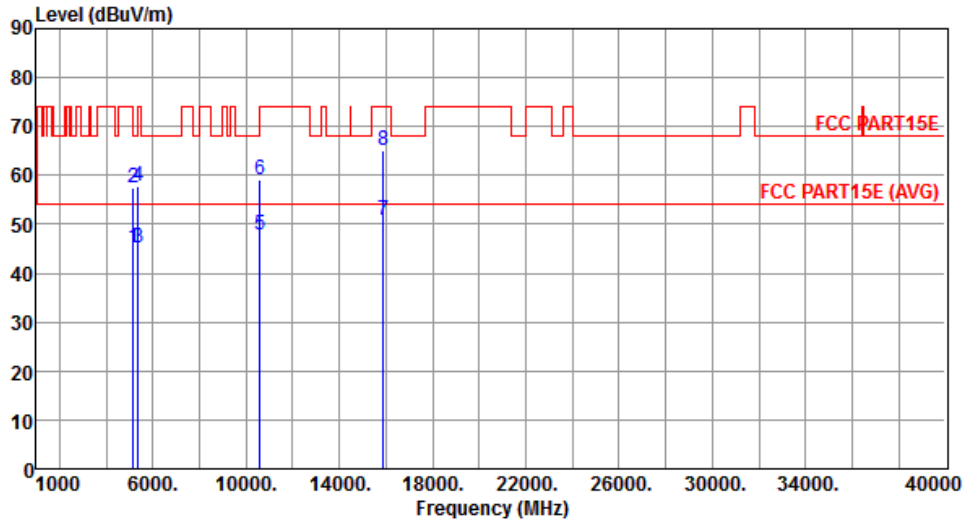

	Freq. MHz	Emission level dBuV/m	Limit dBuV/m	Margin dB	SA reading dBuV	Factor dB	Remark	ANT High cm	Turn Table deg
1	5150.00	45.22	54.00	-8.78	38.91	6.31	Average	150	174
2	5150.00	57.57	74.00	-16.43	51.26	6.31	Peak	150	174
3	5350.00	45.21	54.00	-8.79	38.59	6.62	Average	150	174
4	5350.00	57.70	74.00	-16.30	51.08	6.62	Peak	150	174
5	10600.00	47.87	54.00	-6.13	31.25	16.62	Average	150	155
6	10600.00	59.17	74.00	-14.83	42.55	16.62	Peak	150	155
7	15900.00	50.84	54.00	-3.16	34.02	16.82	Average	237	120
8	15900.00	65.00	74.00	-9.00	48.18	16.82	Peak	237	120

Note 1: Emission Level (dBuV/m) = SA Reading (dBuV/m) + Factor\* (dB)

\*Factor includes antenna factor , cable loss and amplifier gain

Note 2: Margin (dB) = Emission level (dBuV/m) – Limit (dBuV/m).

<b>Modulation</b>	11a	<b>Test Freq. (MHz)</b>	5300
<b>Polarization</b>	Vertical	<b>Test Configuration</b>	1

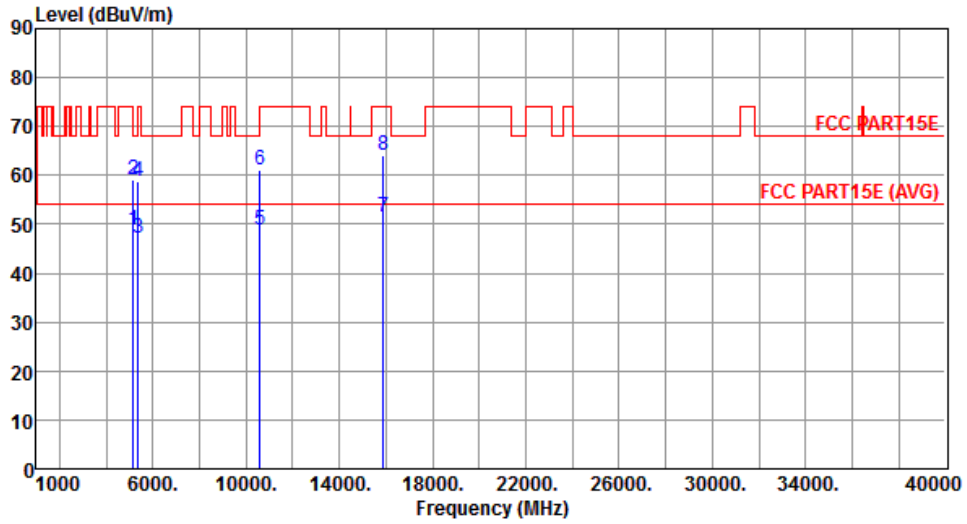

	Freq. MHz	Emission level dBuV/m	Limit dBuV/m	Margin dB	SA reading dBuV	Factor dB	Remark	ANT High cm	Turn Table deg
1	5150.00	48.67	54.00	-5.33	42.36	6.31	Average	150	204
2	5150.00	59.05	74.00	-14.95	52.74	6.31	Peak	150	204
3	5350.00	47.22	54.00	-6.78	40.60	6.62	Average	150	204
4	5350.00	58.88	74.00	-15.12	52.26	6.62	Peak	150	204
5	10600.00	48.96	54.00	-5.04	32.34	16.62	Average	150	174
6	10600.00	61.02	74.00	-12.98	44.40	16.62	Peak	150	174
7	15900.00	51.58	54.00	-2.42	34.76	16.82	Average	150	181
8	15900.00	64.17	74.00	-9.83	47.35	16.82	Peak	150	181

Note 1: Emission Level (dBuV/m) = SA Reading (dBuV/m) + Factor\* (dB)

\*Factor includes antenna factor , cable loss and amplifier gain

Note 2: Margin (dB) = Emission level (dBuV/m) – Limit (dBuV/m).

<b>Modulation</b>	11a	<b>Test Freq. (MHz)</b>	5320
<b>Polarization</b>	Horizontal	<b>Test Configuration</b>	1

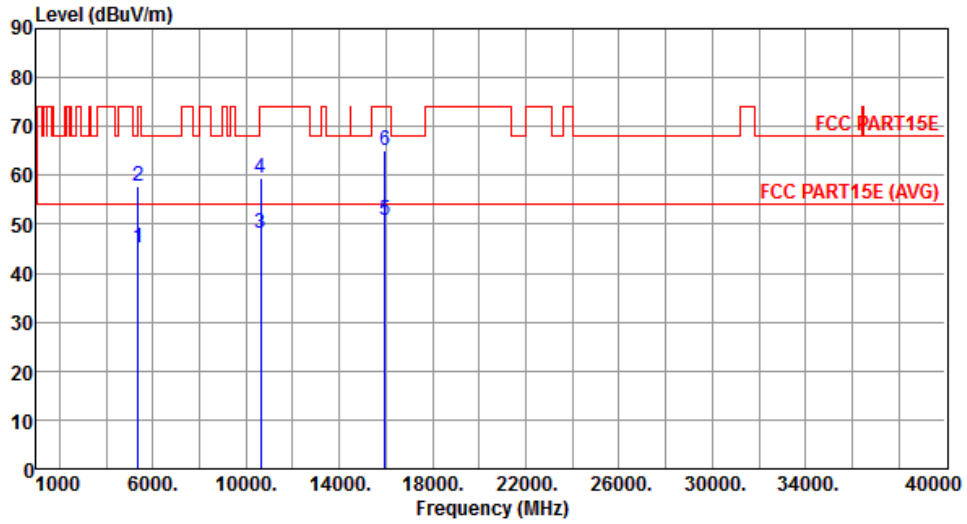

	Freq. MHz	Emission level dBuV/m	Limit dBuV/m	Margin dB	SA reading dBuV	Factor dB	Remark	ANT High cm	Turn Table deg
1	5350.00	45.25	54.00	-8.75	38.63	6.62	Average	150	84
2	5350.00	57.72	74.00	-16.28	51.10	6.62	Peak	150	84
3	10640.00	48.12	54.00	-5.88	31.49	16.63	Average	155	159
4	10640.00	59.54	74.00	-14.46	42.91	16.63	Peak	155	159
5	15960.00	50.67	54.00	-3.33	33.97	16.70	Average	269	125
6	15960.00	65.17	74.00	-8.83	48.47	16.70	Peak	269	125

Note 1: Emission Level (dBuV/m) = SA Reading (dBuV/m) + Factor\* (dB)

\*Factor includes antenna factor , cable loss and amplifier gain

Note 2: Margin (dB) = Emission level (dBuV/m) – Limit (dBuV/m).



<b>Modulation</b>	11a	<b>Test Freq. (MHz)</b>	5320
<b>Polarization</b>	Vertical	<b>Test Configuration</b>	1

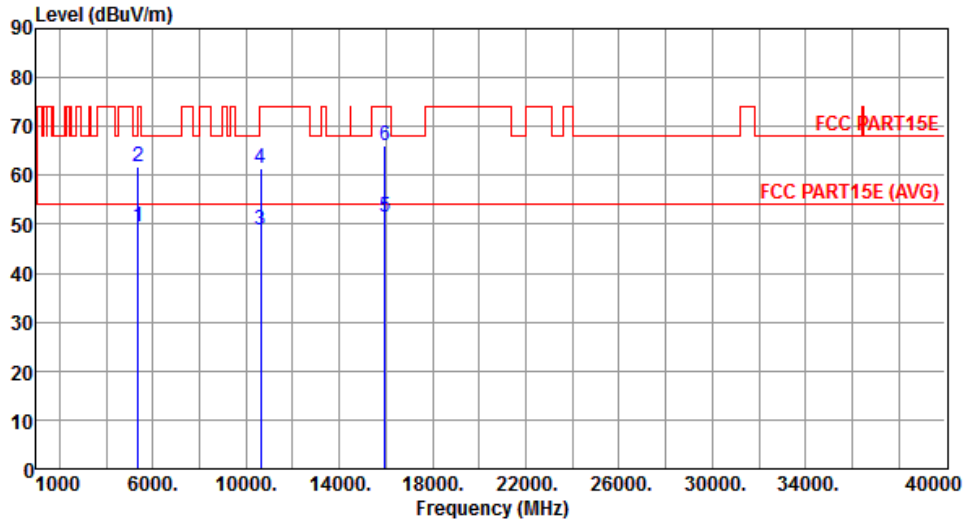

	Freq. MHz	Emission level dBuV/m	Limit dBuV/m	Margin dB	SA reading dBuV	Factor dB	Remark	ANT High cm	Turn Table deg
1	5350.00	49.55	54.00	-4.45	42.93	6.62	Average	150	211
2	5350.00	61.76	74.00	-12.24	55.14	6.62	Peak	150	211
3	10640.00	48.68	54.00	-5.32	32.05	16.63	Average	153	171
4	10640.00	61.30	74.00	-12.70	44.67	16.63	Peak	153	171
5	15960.00	51.53	54.00	-2.47	34.83	16.70	Average	150	188
6	15960.00	65.97	74.00	-8.03	49.27	16.70	Peak	150	188

Note 1: Emission Level (dBuV/m) = SA Reading (dBuV/m) + Factor\* (dB)

\*Factor includes antenna factor , cable loss and amplifier gain

Note 2: Margin (dB) = Emission level (dBuV/m) – Limit (dBuV/m).

<b>Modulation</b>	11a	<b>Test Freq. (MHz)</b>	5500
<b>Polarization</b>	Horizontal	<b>Test Configuration</b>	1

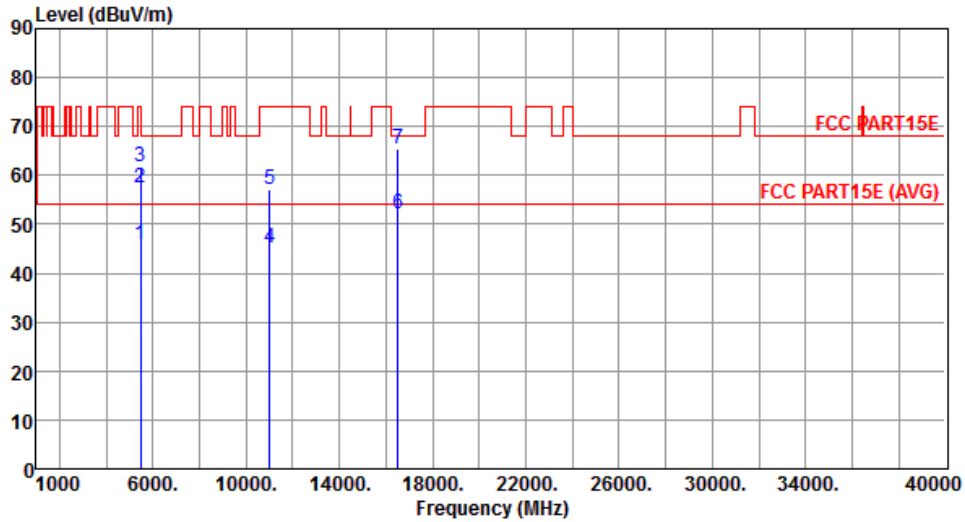

	Freq. MHz	Emission level dBuV/m	Limit dBuV/m	Margin dB	SA reading dBuV	Factor dB	Remark	ANT High cm	Turn Table deg
1	5460.00	45.95	54.00	-8.05	39.19	6.76	Average	307	121
2	5460.00	57.55	74.00	-16.45	50.79	6.76	Peak	307	121
3	5470.00	61.84	68.20	-6.36	55.07	6.77	Peak	307	121
4	11000.00	45.22	54.00	-8.78	28.50	16.72	Average	260	122
5	11000.00	56.98	74.00	-17.02	40.26	16.72	Peak	260	122
6	16500.00	52.15	54.00	-1.85	34.28	17.87	Average	262	132
7	16500.00	65.52	68.20	-2.68	47.65	17.87	Peak	262	132

Note 1: Emission Level (dBuV/m) = SA Reading (dBuV/m) + Factor\* (dB)

\*Factor includes antenna factor , cable loss and amplifier gain

Note 2: Margin (dB) = Emission level (dBuV/m) – Limit (dBuV/m).

<b>Modulation</b>	11a	<b>Test Freq. (MHz)</b>	5500
<b>Polarization</b>	Vertical	<b>Test Configuration</b>	1

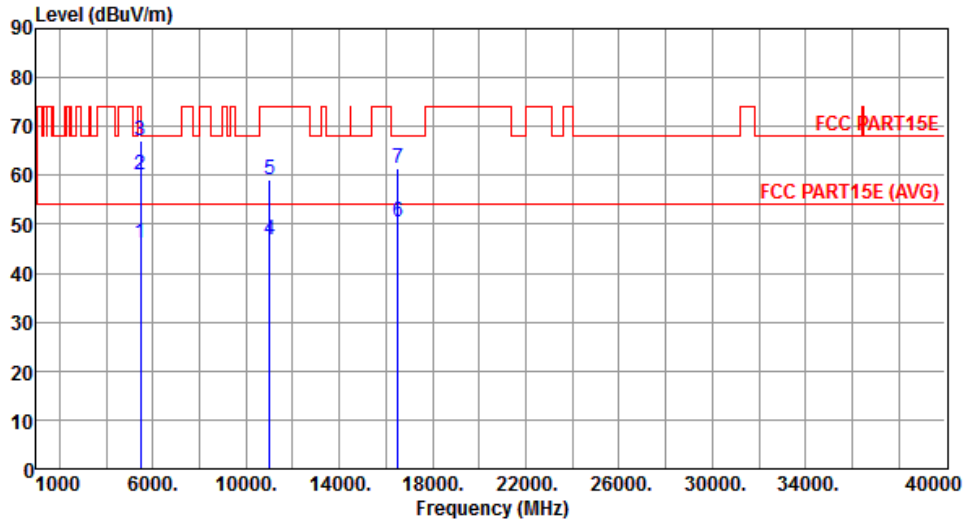

	Freq. MHz	Emission level dBuV/m	Limit dBuV/m	Margin dB	SA reading dBuV	Factor dB	Remark	ANT High cm	Turn Table deg
1	5460.00	46.25	54.00	-7.75	39.49	6.76	Average	166	115
2	5460.00	60.19	74.00	-13.81	53.43	6.76	Peak	166	115
3	5470.00	66.99	68.20	-1.21	60.22	6.77	Peak	166	115
4	11000.00	46.98	54.00	-7.02	30.26	16.72	Average	269	181
5	11000.00	58.98	74.00	-15.02	42.26	16.72	Peak	269	181
6	16500.00	50.43	54.00	-3.57	32.56	17.87	Average	331	139
7	16500.00	61.42	68.20	-6.78	43.55	17.87	Peak	331	139

Note 1: Emission Level (dBuV/m) = SA Reading (dBuV/m) + Factor\* (dB)

\*Factor includes antenna factor , cable loss and amplifier gain

Note 2: Margin (dB) = Emission level (dBuV/m) – Limit (dBuV/m).

<b>Modulation</b>	11a	<b>Test Freq. (MHz)</b>	5580
<b>Polarization</b>	Horizontal	<b>Test Configuration</b>	1

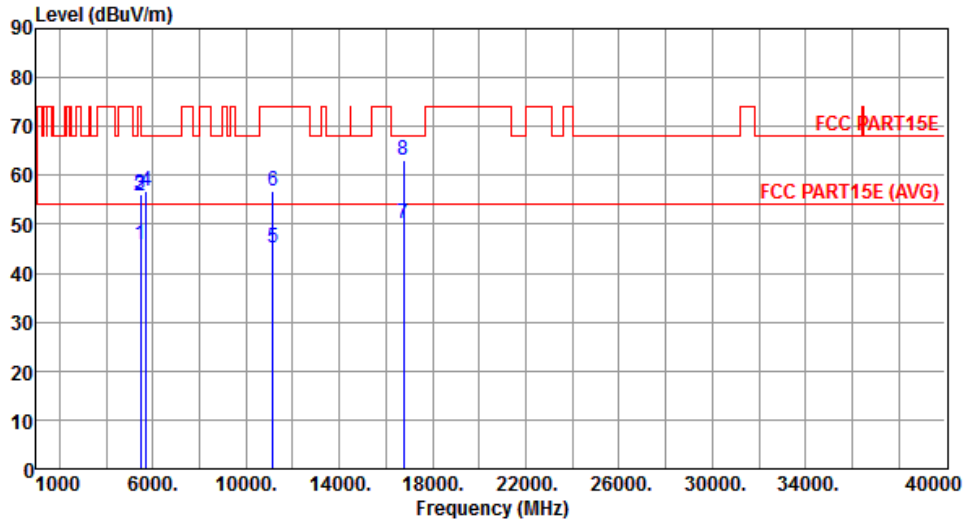

	Freq. MHz	Emission level dBuV/m	Limit dBuV/m	Margin dB	SA reading dBuV	Factor dB	Remark	ANT High cm	Turn Table deg
1	5460.00	45.78	54.00	-8.22	39.02	6.76	Average	150	308
2	5460.00	55.84	74.00	-18.16	49.08	6.76	Peak	150	308
3	5470.00	56.08	68.20	-12.12	49.31	6.77	Peak	150	308
4	5725.00	56.69	68.20	-11.51	49.45	7.24	Peak	150	308
5	11160.00	45.32	54.00	-8.68	28.53	16.79	Average	271	62
6	11160.00	56.72	74.00	-17.28	39.93	16.79	Peak	271	62
7	16740.00	50.24	54.00	-3.76	31.84	18.40	Average	348	132
8	16740.00	62.99	68.20	-5.21	44.59	18.40	Peak	348	132

Note 1: Emission Level (dBuV/m) = SA Reading (dBuV/m) + Factor\* (dB)

\*Factor includes antenna factor , cable loss and amplifier gain

Note 2: Margin (dB) = Emission level (dBuV/m) – Limit (dBuV/m).

<b>Modulation</b>	11a	<b>Test Freq. (MHz)</b>	5580
<b>Polarization</b>	Vertical	<b>Test Configuration</b>	1

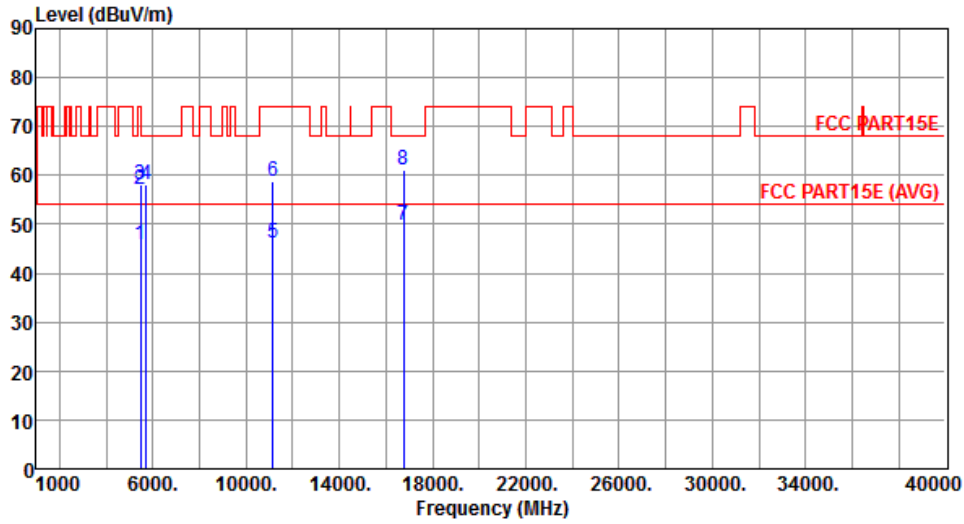

	Freq. MHz	Emission level dBuV/m	Limit dBuV/m	Margin dB	SA reading dBuV	Factor dB	Remark	ANT High cm	Turn Table deg
1	5460.00	45.84	54.00	-8.16	39.08	6.76	Average	150	138
2	5470.00	57.01	68.20	-11.19	50.24	6.77	Peak	150	138
3	5470.00	58.02	68.20	-10.18	51.25	6.77	Peak	150	138
4	5725.00	58.07	68.20	-10.13	50.83	7.24	Peak	150	138
5	11160.00	46.26	54.00	-7.74	29.47	16.79	Average	315	309
6	11160.00	58.70	74.00	-15.30	41.91	16.79	Peak	315	309
7	16740.00	49.66	54.00	-4.34	31.26	18.40	Average	150	183
8	16740.00	61.16	68.20	-7.04	42.76	18.40	Peak	150	183

Note 1: Emission Level (dBuV/m) = SA Reading (dBuV/m) + Factor\* (dB)

\*Factor includes antenna factor , cable loss and amplifier gain

Note 2: Margin (dB) = Emission level (dBuV/m) – Limit (dBuV/m).

<b>Modulation</b>	11a	<b>Test Freq. (MHz)</b>	5700
<b>Polarization</b>	Horizontal	<b>Test Configuration</b>	1

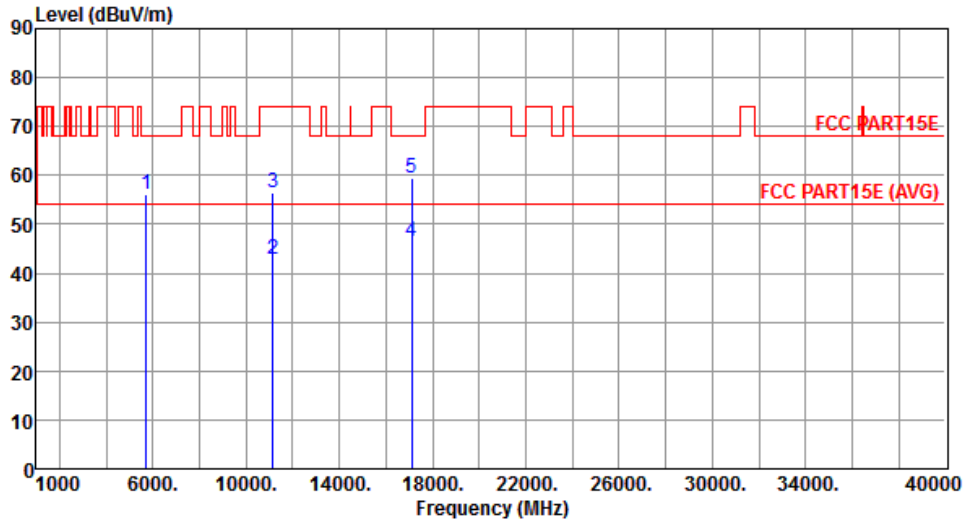

	Freq. MHz	Emission level dBuV/m	Limit dBuV/m	Margin dB	SA reading dBuV	Factor dB	Remark	ANT High cm	Turn Table deg
1	5725.00	56.06	68.20	-12.14	48.82	7.24	Peak	150	305
2	11140.00	42.99	54.00	-11.01	26.22	16.77	Average	381	267
3	11140.00	56.34	74.00	-17.66	39.57	16.77	Peak	381	267
4	17100.00	46.56	54.00	-7.44	27.44	19.12	Average	150	154
5	17100.00	59.42	68.20	-8.78	40.30	19.12	Peak	150	154

Note 1: Emission Level (dBuV/m) = SA Reading (dBuV/m) + Factor\* (dB)

\*Factor includes antenna factor , cable loss and amplifier gain

Note 2: Margin (dB) = Emission level (dBuV/m) – Limit (dBuV/m).

<b>Modulation</b>	11a	<b>Test Freq. (MHz)</b>	5700
<b>Polarization</b>	Vertical	<b>Test Configuration</b>	1

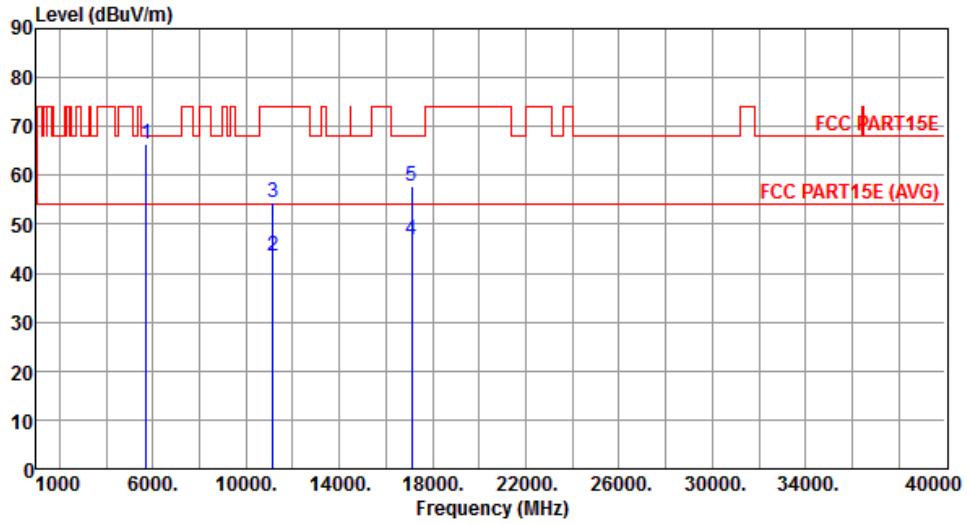

	Freq. MHz	Emission level dBuV/m	Limit dBuV/m	Margin dB	SA reading dBuV	Factor dB	Remark	ANT High cm	Turn Table deg
1	5725.00	66.58	68.20	-1.62	59.34	7.24	Peak	159	134
2	11140.00	43.44	54.00	-10.56	26.67	16.77	Average	180	279
3	11140.00	54.52	74.00	-19.48	37.75	16.77	Peak	180	279
4	17100.00	46.77	54.00	-7.23	27.65	19.12	Average	150	265
5	17100.00	57.72	68.20	-10.48	38.60	19.12	Peak	150	265

Note 1: Emission Level (dBuV/m) = SA Reading (dBuV/m) + Factor\* (dB)

\*Factor includes antenna factor , cable loss and amplifier gain

Note 2: Margin (dB) = Emission level (dBuV/m) – Limit (dBuV/m).

<b>Modulation</b>	11a	<b>Test Freq. (MHz)</b>	5745
<b>Polarization</b>	Horizontal	<b>Test Configuration</b>	1

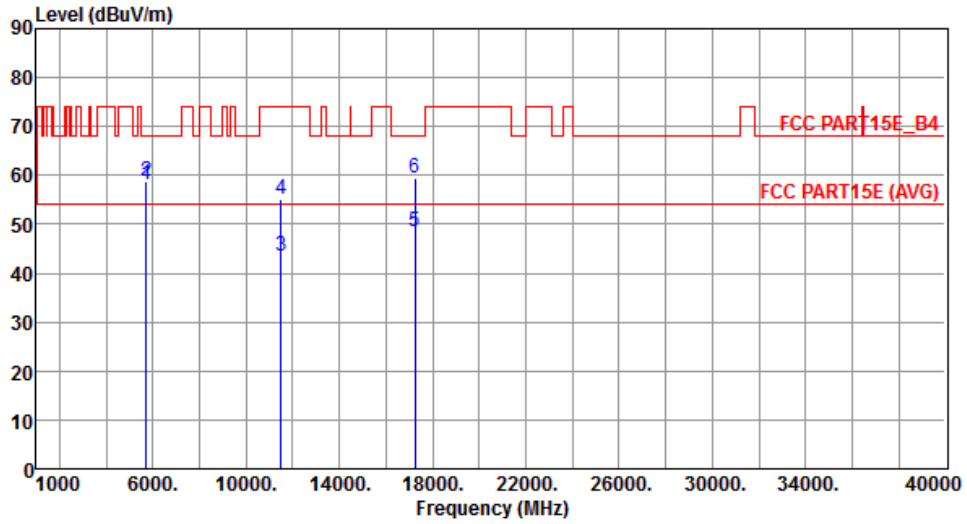

	Freq. MHz	Emission level dBuV/m	Limit dBuV/m	Margin dB	SA reading dBuV	Factor dB	Remark	ANT High cm	Turn Table deg
1	5715.00	58.10	68.20	-10.10	50.90	7.20	Peak	150	311
2	5725.00	58.80	78.20	-19.40	51.56	7.24	Peak	150	311
3	11490.00	43.42	54.00	-10.58	26.51	16.91	Average	306	281
4	11490.00	55.28	74.00	-18.72	38.37	16.91	Peak	306	281
5	17235.00	48.58	54.00	-5.42	29.26	19.32	Average	347	126
6	17235.00	59.58	68.20	-8.62	40.26	19.32	Peak	347	126

Note 1: Emission Level (dBuV/m) = SA Reading (dBuV/m) + Factor\* (dB)

\*Factor includes antenna factor , cable loss and amplifier gain

Note 2: Margin (dB) = Emission level (dBuV/m) – Limit (dBuV/m).



<b>Modulation</b>	11a	<b>Test Freq. (MHz)</b>	5745
<b>Polarization</b>	Vertical	<b>Test Configuration</b>	1

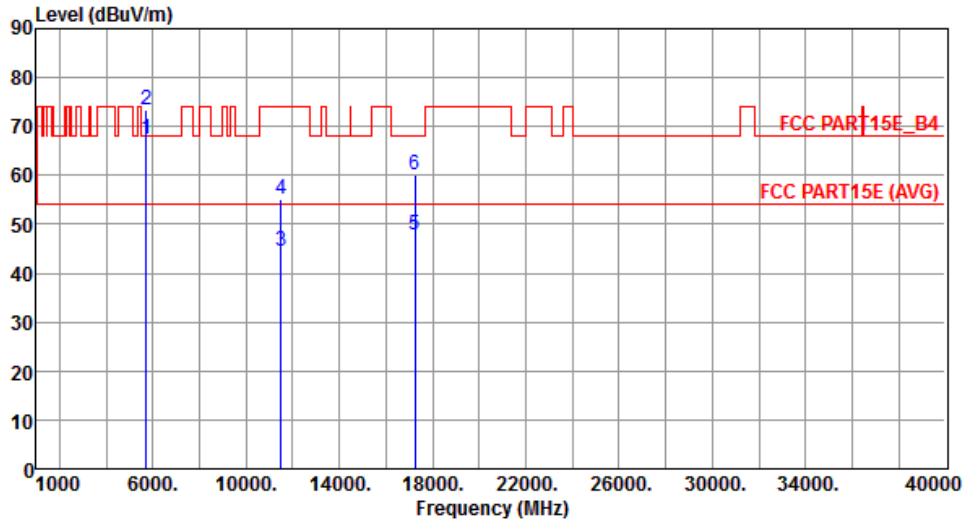

	Freq. MHz	Emission level dBuV/m	Limit dBuV/m	Margin dB	SA reading dBuV	Factor dB	Remark	ANT High cm	Turn Table deg
1	5715.00	67.28	68.20	-0.92	60.08	7.20	Peak	150	147
2	5725.00	73.31	78.20	-4.89	66.07	7.24	Peak	150	147
3	11490.00	44.37	54.00	-9.63	27.46	16.91	Average	296	244
4	11490.00	55.18	74.00	-18.82	38.27	16.91	Peak	296	244
5	17235.00	47.67	54.00	-6.33	28.35	19.32	Average	326	155
6	17235.00	59.98	68.20	-8.22	40.66	19.32	Peak	326	155

Note 1: Emission Level (dBuV/m) = SA Reading (dBuV/m) + Factor\* (dB)

\*Factor includes antenna factor , cable loss and amplifier gain

Note 2: Margin (dB) = Emission level (dBuV/m) – Limit (dBuV/m).

<b>Modulation</b>	11a	<b>Test Freq. (MHz)</b>	5785
<b>Polarization</b>	Horizontal	<b>Test Configuration</b>	1

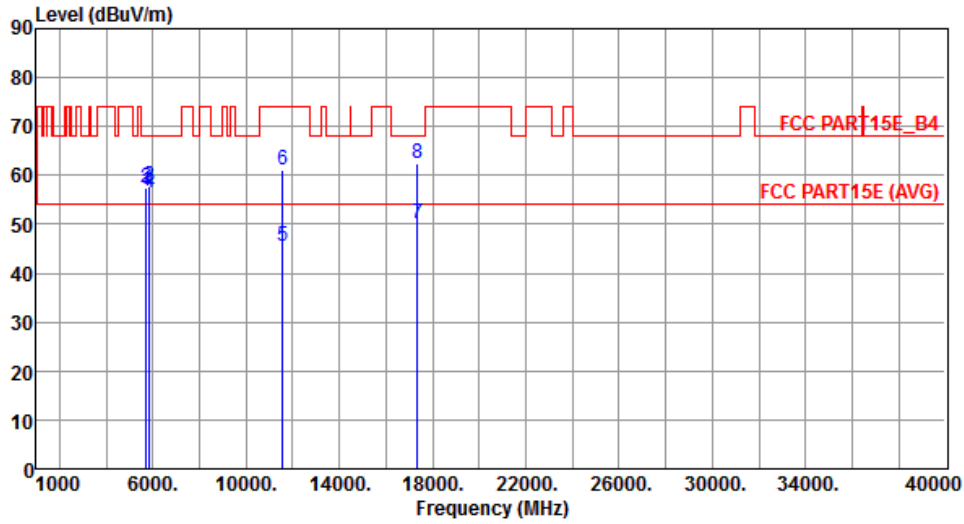

	Freq. MHz	Emission level dBuV/m	Limit dBuV/m	Margin dB	SA reading dBuV	Factor dB	Remark	ANT High cm	Turn Table deg
1	5715.00	56.77	68.20	-11.43	49.57	7.20	Peak	386	125
2	5725.00	57.50	78.20	-20.70	50.26	7.24	Peak	386	125
3	5850.00	57.77	78.20	-20.43	50.27	7.50	Peak	386	125
4	5860.00	56.60	68.20	-11.60	49.09	7.51	Peak	386	125
5	11570.00	45.49	54.00	-8.51	28.69	16.80	Average	220	179
6	11570.00	61.15	74.00	-12.85	44.35	16.80	Peak	220	179
7	17355.00	50.08	54.00	-3.92	30.59	19.49	Average	234	133
8	17355.00	62.39	68.20	-5.81	42.90	19.49	Peak	234	133

Note 1: Emission Level (dBuV/m) = SA Reading (dBuV/m) + Factor\* (dB)

\*Factor includes antenna factor , cable loss and amplifier gain

Note 2: Margin (dB) = Emission level (dBuV/m) – Limit (dBuV/m).

<b>Modulation</b>	11a	<b>Test Freq. (MHz)</b>	5785
<b>Polarization</b>	Vertical	<b>Test Configuration</b>	1

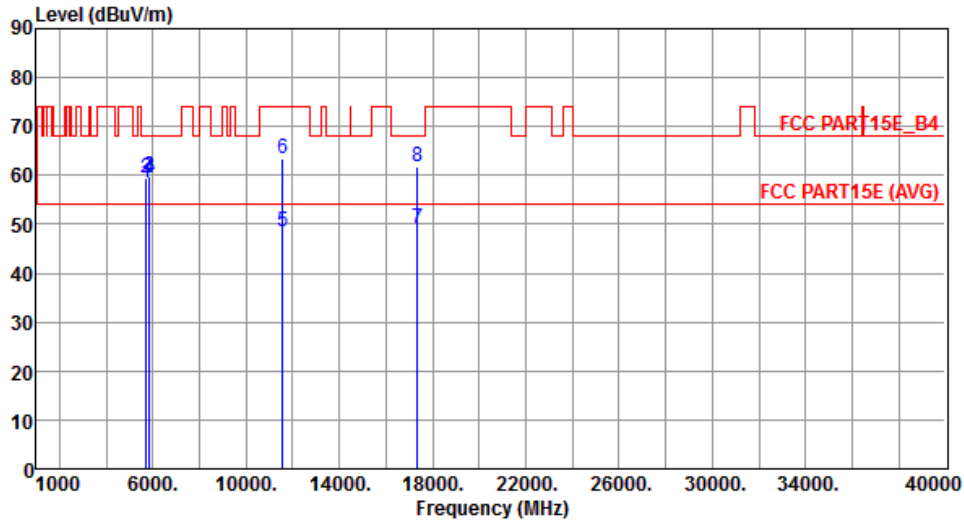

	Freq. MHz	Emission level dBuV/m	Limit dBuV/m	Margin dB	SA reading dBuV	Factor dB	Remark	ANT High cm	Turn Table deg
1	5715.00	58.31	68.20	-9.89	51.11	7.20	Peak	150	135
2	5725.00	59.49	78.20	-18.71	52.25	7.24	Peak	150	135
3	5850.00	59.86	78.20	-18.34	52.36	7.50	Peak	150	135
4	5860.00	59.50	68.20	-8.70	51.99	7.51	Peak	150	135
5	11570.00	48.60	54.00	-5.40	31.80	16.80	Average	150	175
6	11570.00	63.60	74.00	-10.40	46.80	16.80	Peak	150	175
7	17355.00	49.08	54.00	-4.92	29.59	19.49	Average	328	150
8	17355.00	61.75	68.20	-6.45	42.26	19.49	Peak	328	150

Note 1: Emission Level (dBuV/m) = SA Reading (dBuV/m) + Factor\* (dB)

\*Factor includes antenna factor , cable loss and amplifier gain

Note 2: Margin (dB) = Emission level (dBuV/m) – Limit (dBuV/m).

<b>Modulation</b>	11a	<b>Test Freq. (MHz)</b>	5825
<b>Polarization</b>	Horizontal	<b>Test Configuration</b>	1

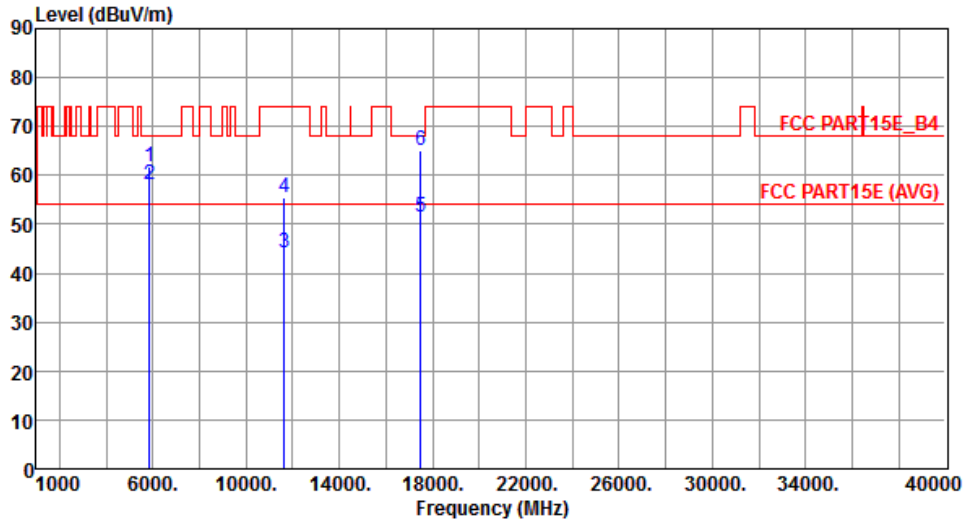

	Freq. MHz	Emission level dBuV/m	Limit dBuV/m	Margin dB	SA reading dBuV	Factor dB	Remark	ANT High cm	Turn Table deg
1	5850.00	61.82	78.20	-16.38	54.32	7.50	Peak	232	127
2	5860.00	58.11	68.20	-10.09	50.60	7.51	Peak	232	127
3	11650.00	44.21	54.00	-9.79	27.56	16.65	Average	307	129
4	11650.00	55.62	74.00	-18.38	38.97	16.65	Peak	307	129
5	17475.00	51.50	54.00	-2.50	31.84	19.66	Average	150	138
6	17475.00	65.04	68.20	-3.16	45.38	19.66	Peak	150	138

Note 1: Emission Level (dBuV/m) = SA Reading (dBuV/m) + Factor\* (dB)

\*Factor includes antenna factor , cable loss and amplifier gain

Note 2: Margin (dB) = Emission level (dBuV/m) – Limit (dBuV/m).

<b>Modulation</b>	11a	<b>Test Freq. (MHz)</b>	5825
<b>Polarization</b>	Vertical	<b>Test Configuration</b>	1

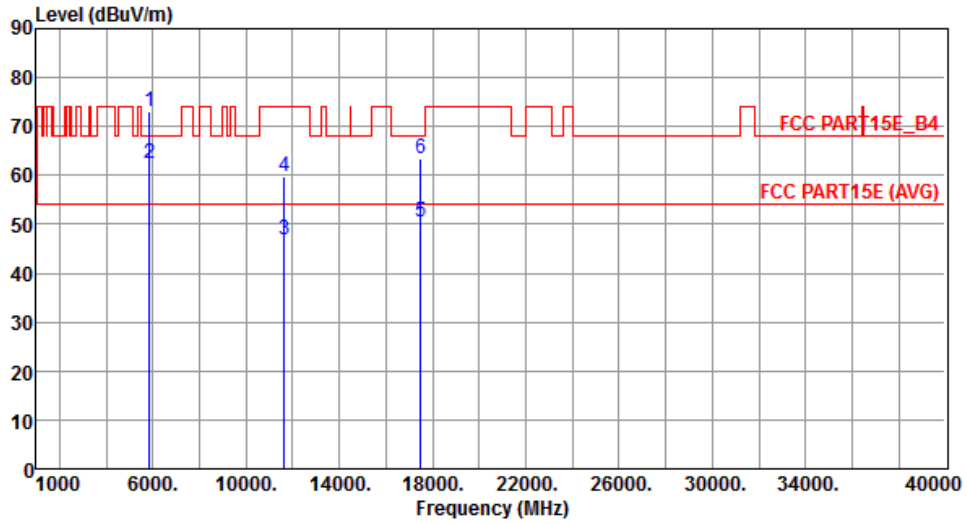

	Freq. MHz	Emission level dBuV/m	Limit dBuV/m	Margin dB	SA reading dBuV	Factor dB	Remark	ANT High cm	Turn Table deg
1	5850.00	73.13	78.20	-5.07	65.63	7.50	Peak	150	137
2	5860.00	62.43	68.20	-5.77	54.92	7.51	Peak	150	137
3	11650.00	46.91	54.00	-7.09	30.26	16.65	Average	173	142
4	11650.00	59.90	74.00	-14.10	43.25	16.65	Peak	173	142
5	17475.00	50.37	54.00	-3.63	30.71	19.66	Average	150	320
6	17475.00	63.27	68.20	-4.93	43.61	19.66	Peak	150	320

Note 1: Emission Level (dBuV/m) = SA Reading (dBuV/m) + Factor\* (dB)

\*Factor includes antenna factor , cable loss and amplifier gain

Note 2: Margin (dB) = Emission level (dBuV/m) – Limit (dBuV/m).

### 3.5.6 Transmitter Radiated Unwanted Emissions (Above 1GHz) for HT20

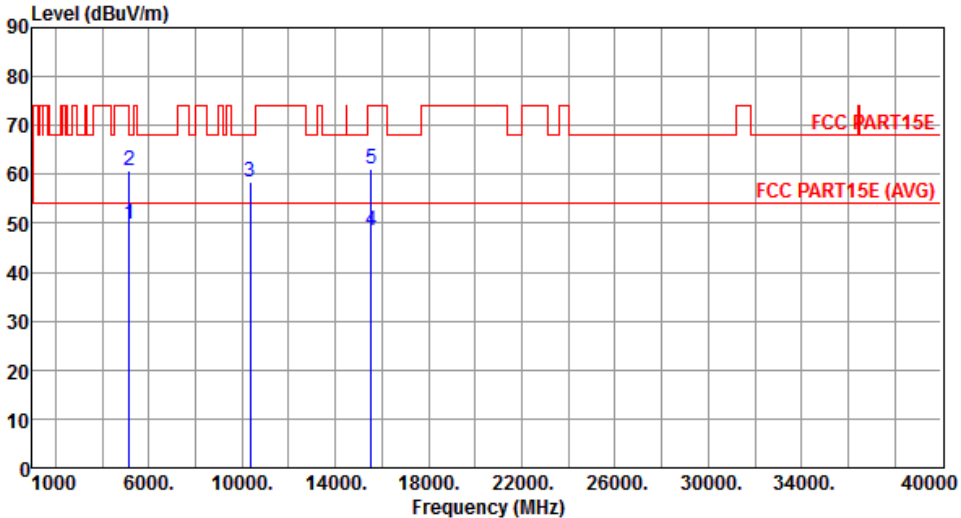
Modulation	HT20	Test Freq. (MHz)	5180																																																																					
Polarization	Horizontal	Test Configuration	1																																																																					
																																																																								
	<table border="1"> <thead> <tr> <th>Freq.</th> <th>Emission level</th> <th>Limit</th> <th>Margin</th> <th>SA reading</th> <th>Factor</th> <th>Remark</th> <th>ANT High</th> <th>Turn Table</th> </tr> <tr> <th>MHz</th> <th>dBuV/m</th> <th>dBuV/m</th> <th>dB</th> <th>dBuV</th> <th>dB</th> <th></th> <th>cm</th> <th>deg</th> </tr> </thead> <tbody> <tr> <td>1</td> <td>5150.00</td> <td>49.70</td> <td>54.00</td> <td>-4.30</td> <td>43.39</td> <td>6.31</td> <td>Average</td> <td>186</td> <td>130</td> </tr> <tr> <td>2</td> <td>5150.00</td> <td>60.76</td> <td>74.00</td> <td>-13.24</td> <td>54.45</td> <td>6.31</td> <td>Peak</td> <td>186</td> <td>130</td> </tr> <tr> <td>3</td> <td>10360.00</td> <td>58.56</td> <td>68.20</td> <td>-9.64</td> <td>42.22</td> <td>16.34</td> <td>Peak</td> <td>179</td> <td>246</td> </tr> <tr> <td>4</td> <td>15540.00</td> <td>48.36</td> <td>54.00</td> <td>-5.64</td> <td>30.86</td> <td>17.50</td> <td>Average</td> <td>150</td> <td>320</td> </tr> <tr> <td>5</td> <td>15540.00</td> <td>61.04</td> <td>74.00</td> <td>-12.96</td> <td>43.54</td> <td>17.50</td> <td>Peak</td> <td>150</td> <td>320</td> </tr> </tbody> </table>	Freq.	Emission level	Limit	Margin	SA reading	Factor	Remark	ANT High	Turn Table	MHz	dBuV/m	dBuV/m	dB	dBuV	dB		cm	deg	1	5150.00	49.70	54.00	-4.30	43.39	6.31	Average	186	130	2	5150.00	60.76	74.00	-13.24	54.45	6.31	Peak	186	130	3	10360.00	58.56	68.20	-9.64	42.22	16.34	Peak	179	246	4	15540.00	48.36	54.00	-5.64	30.86	17.50	Average	150	320	5	15540.00	61.04	74.00	-12.96	43.54	17.50	Peak	150	320			
Freq.	Emission level	Limit	Margin	SA reading	Factor	Remark	ANT High	Turn Table																																																																
MHz	dBuV/m	dBuV/m	dB	dBuV	dB		cm	deg																																																																
1	5150.00	49.70	54.00	-4.30	43.39	6.31	Average	186	130																																																															
2	5150.00	60.76	74.00	-13.24	54.45	6.31	Peak	186	130																																																															
3	10360.00	58.56	68.20	-9.64	42.22	16.34	Peak	179	246																																																															
4	15540.00	48.36	54.00	-5.64	30.86	17.50	Average	150	320																																																															
5	15540.00	61.04	74.00	-12.96	43.54	17.50	Peak	150	320																																																															
<p>Note 1: Emission Level (dBuV/m) = SA Reading (dBuV/m) + Factor* (dB)            *Factor includes antenna factor , cable loss and amplifier gain            Note 2: Margin (dB) = Emission level (dBuV/m) – Limit (dBuV/m).</p>																																																																								

<b>Modulation</b>	HT20	<b>Test Freq. (MHz)</b>	5180
<b>Polarization</b>	Vertical	<b>Test Configuration</b>	1

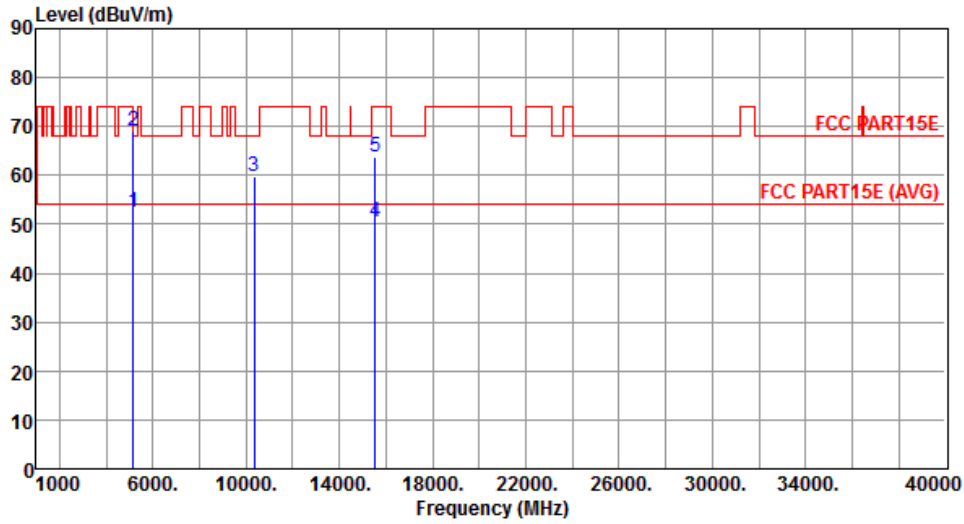

	Freq. MHz	Emission level dBuV/m	Limit dBuV/m	Margin dB	SA reading dBuV	Factor dB	Remark	ANT High cm	Turn Table deg
1	5150.00	52.36	54.00	-1.64	46.05	6.31	Average	150	87
2	5150.00	69.05	74.00	-4.95	62.74	6.31	Peak	150	87
3	10360.00	59.90	68.20	-8.30	43.56	16.34	Peak	157	269
4	15540.00	50.34	54.00	-3.66	32.84	17.50	Average	150	184
5	15540.00	63.88	74.00	-10.12	46.38	17.50	Peak	150	184

Note 1: Emission Level (dBuV/m) = SA Reading (dBuV/m) + Factor\* (dB)

\*Factor includes antenna factor , cable loss and amplifier gain

Note 2: Margin (dB) = Emission level (dBuV/m) – Limit (dBuV/m).

<b>Modulation</b>	HT20	<b>Test Freq. (MHz)</b>	5200
<b>Polarization</b>	Horizontal	<b>Test Configuration</b>	1

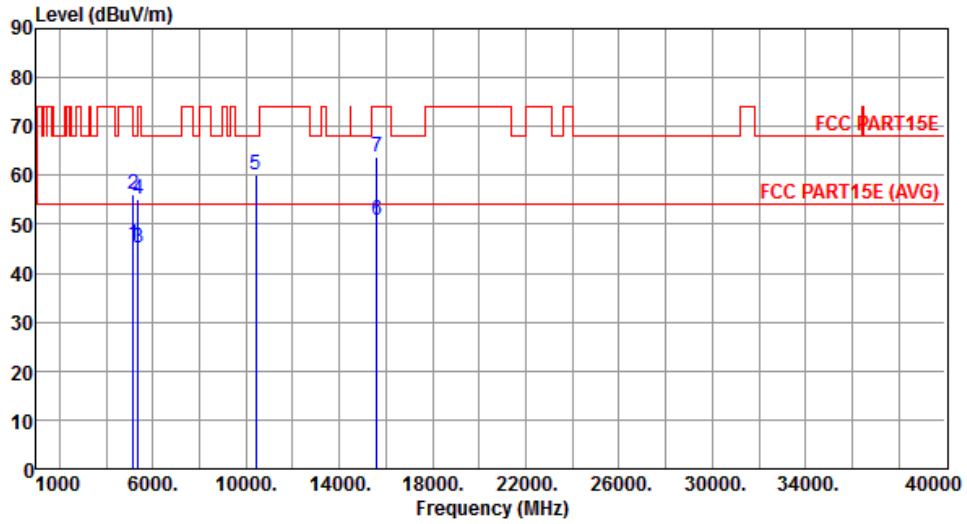

	Freq. MHz	Emission level dBuV/m	Limit dBuV/m	Margin dB	SA reading dBuV	Factor dB	Remark	ANT High cm	Turn Table deg
1	5150.00	45.73	54.00	-8.27	39.42	6.31	Average	215	130
2	5150.00	56.17	74.00	-17.83	49.86	6.31	Peak	215	130
3	5350.00	45.29	54.00	-8.71	38.67	6.62	Average	215	130
4	5350.00	54.98	74.00	-19.02	48.36	6.62	Peak	215	130
5	10400.00	59.97	68.20	-8.23	43.55	16.42	Peak	175	260
6	15600.00	50.72	54.00	-3.28	33.34	17.38	Average	178	134
7	15600.00	63.67	74.00	-10.33	46.29	17.38	Peak	178	134

Note 1: Emission Level (dBuV/m) = SA Reading (dBuV/m) + Factor\* (dB)

\*Factor includes antenna factor , cable loss and amplifier gain

Note 2: Margin (dB) = Emission level (dBuV/m) – Limit (dBuV/m).



<b>Modulation</b>	HT20	<b>Test Freq. (MHz)</b>	5200
<b>Polarization</b>	Vertical	<b>Test Configuration</b>	1

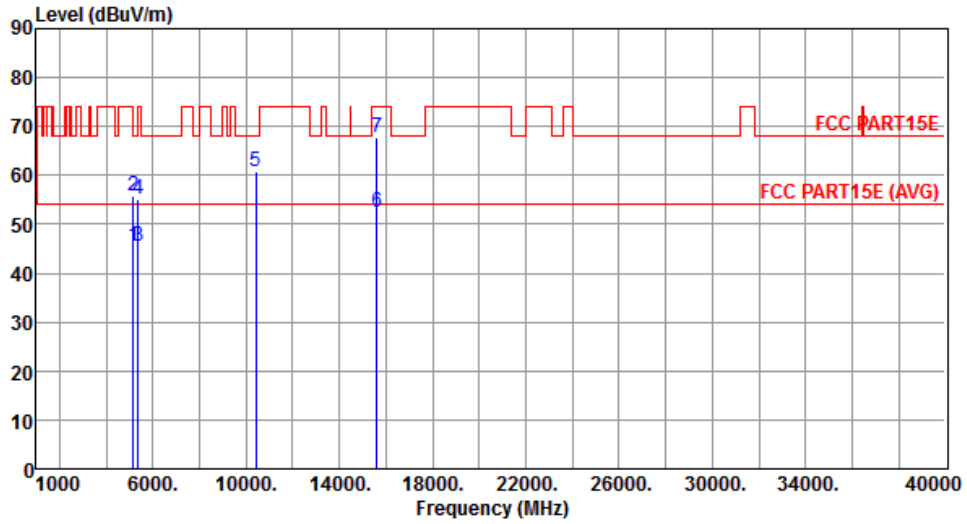

	Freq. MHz	Emission level dBuV/m	Limit dBuV/m	Margin dB	SA reading dBuV	Factor dB	Remark	ANT High cm	Turn Table deg
1	5150.00	45.40	54.00	-8.60	39.09	6.31	Average	150	168
2	5150.00	55.86	74.00	-18.14	49.55	6.31	Peak	150	168
3	5350.00	45.49	54.00	-8.51	38.87	6.62	Average	150	168
4	5350.00	54.99	74.00	-19.01	48.37	6.62	Peak	150	168
5	10400.00	60.67	68.20	-7.53	44.25	16.42	Peak	220	132
6	15600.00	52.32	54.00	-1.68	34.94	17.38	Average	150	184
7	15600.00	67.61	74.00	-6.39	50.23	17.38	Peak	150	184

Note 1: Emission Level (dBuV/m) = SA Reading (dBuV/m) + Factor\* (dB)

\*Factor includes antenna factor , cable loss and amplifier gain

Note 2: Margin (dB) = Emission level (dBuV/m) – Limit (dBuV/m).

<b>Modulation</b>	HT20	<b>Test Freq. (MHz)</b>	5240
<b>Polarization</b>	Horizontal	<b>Test Configuration</b>	1

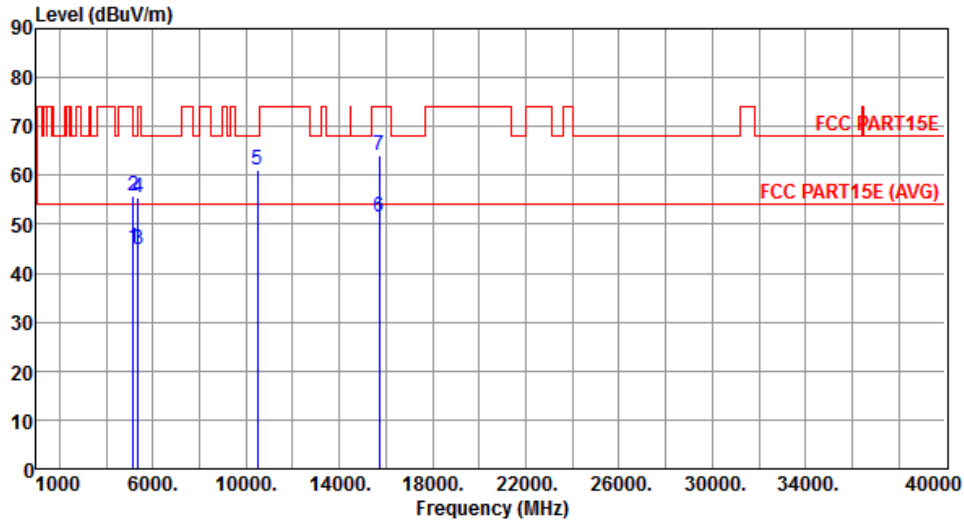

	Freq. MHz	Emission level dBuV/m	Limit dBuV/m	Margin dB	SA reading dBuV	Factor dB	Remark	ANT High cm	Turn Table deg
1	5150.00	45.18	54.00	-8.82	38.87	6.31	Average	217	129
2	5150.00	55.86	74.00	-18.14	49.55	6.31	Peak	217	129
3	5350.00	44.79	54.00	-9.21	38.17	6.62	Average	217	129
4	5350.00	55.61	74.00	-18.39	48.99	6.62	Peak	217	129
5	10480.00	61.05	68.20	-7.15	44.49	16.56	Peak	270	244
6	15720.00	51.53	54.00	-2.47	34.38	17.15	Average	187	134
7	15720.00	63.94	74.00	-10.06	46.79	17.15	Peak	187	134

Note 1: Emission Level (dBuV/m) = SA Reading (dBuV/m) + Factor\* (dB)

\*Factor includes antenna factor , cable loss and amplifier gain

Note 2: Margin (dB) = Emission level (dBuV/m) – Limit (dBuV/m).

<b>Modulation</b>	HT20	<b>Test Freq. (MHz)</b>	5240
<b>Polarization</b>	Vertical	<b>Test Configuration</b>	1

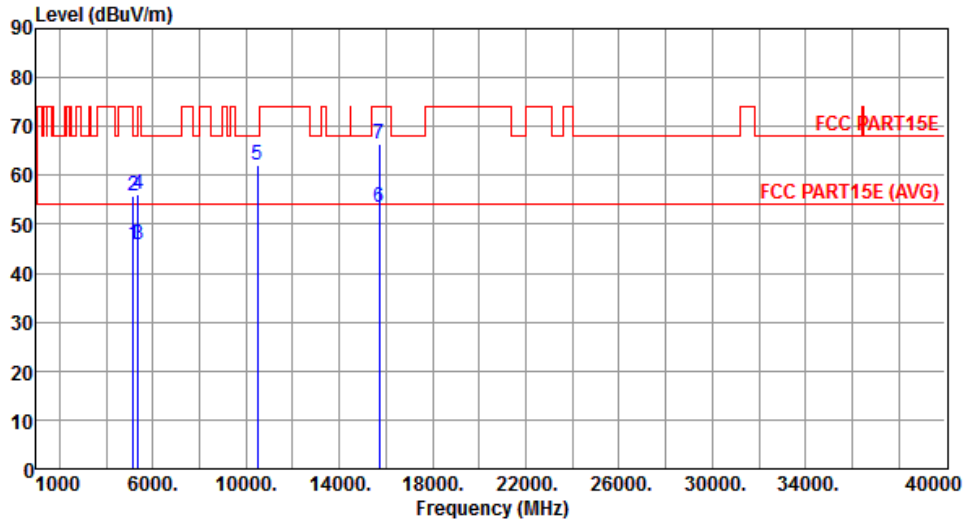

	Freq. MHz	Emission level dBuV/m	Limit dBuV/m	Margin dB	SA reading dBuV	Factor dB	Remark	ANT High cm	Turn Table deg
1	5150.00	45.71	54.00	-8.29	39.40	6.31	Average	150	121
2	5150.00	55.80	74.00	-18.20	49.49	6.31	Peak	150	121
3	5350.00	45.70	54.00	-8.30	39.08	6.62	Average	150	121
4	5350.00	56.28	74.00	-17.72	49.66	6.62	Peak	150	121
5	10480.00	62.26	68.20	-5.94	45.70	16.56	Peak	400	210
6	15720.00	53.61	54.00	-0.39	36.46	17.15	Average	150	183
7	15720.00	66.33	74.00	-7.67	49.18	17.15	Peak	150	183

Note 1: Emission Level (dBuV/m) = SA Reading (dBuV/m) + Factor\* (dB)

\*Factor includes antenna factor , cable loss and amplifier gain

Note 2: Margin (dB) = Emission level (dBuV/m) – Limit (dBuV/m).

<b>Modulation</b>	HT20	<b>Test Freq. (MHz)</b>	5260
<b>Polarization</b>	Horizontal	<b>Test Configuration</b>	1

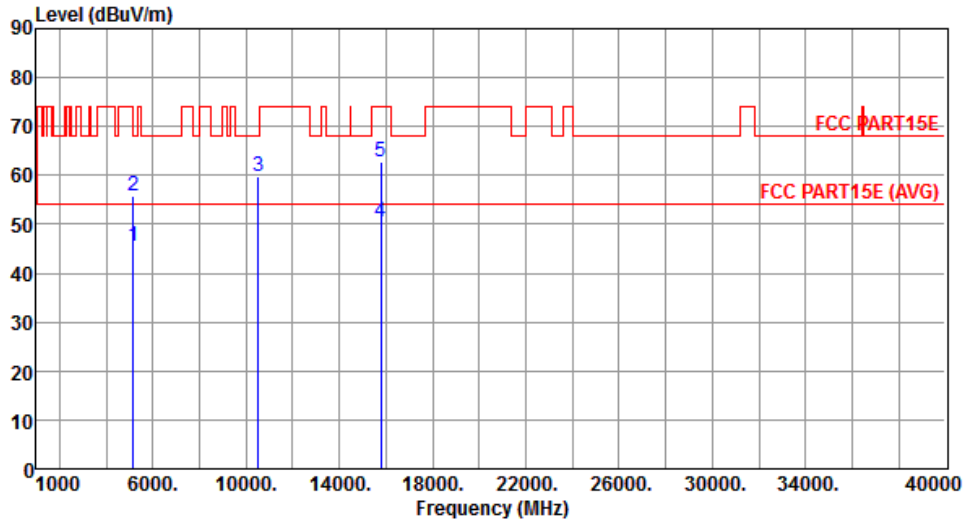

	Freq. MHz	Emission level dBuV/m	Limit dBuV/m	Margin dB	SA reading dBuV	Factor dB	Remark	ANT High cm	Turn Table deg
1	5150.00	45.60	54.00	-8.40	39.29	6.31	Average	150	91
2	5150.00	55.86	74.00	-18.14	49.55	6.31	Peak	150	91
3	10520.00	59.87	68.20	-8.33	43.27	16.60	Peak	214	187
4	15780.00	50.59	54.00	-3.41	33.54	17.05	Average	190	128
5	15780.00	62.84	74.00	-11.16	45.79	17.05	Peak	190	128

Note 1: Emission Level (dBuV/m) = SA Reading (dBuV/m) + Factor\* (dB)

\*Factor includes antenna factor , cable loss and amplifier gain

Note 2: Margin (dB) = Emission level (dBuV/m) – Limit (dBuV/m).

<b>Modulation</b>	HT20	<b>Test Freq. (MHz)</b>	5260
<b>Polarization</b>	Vertical	<b>Test Configuration</b>	1

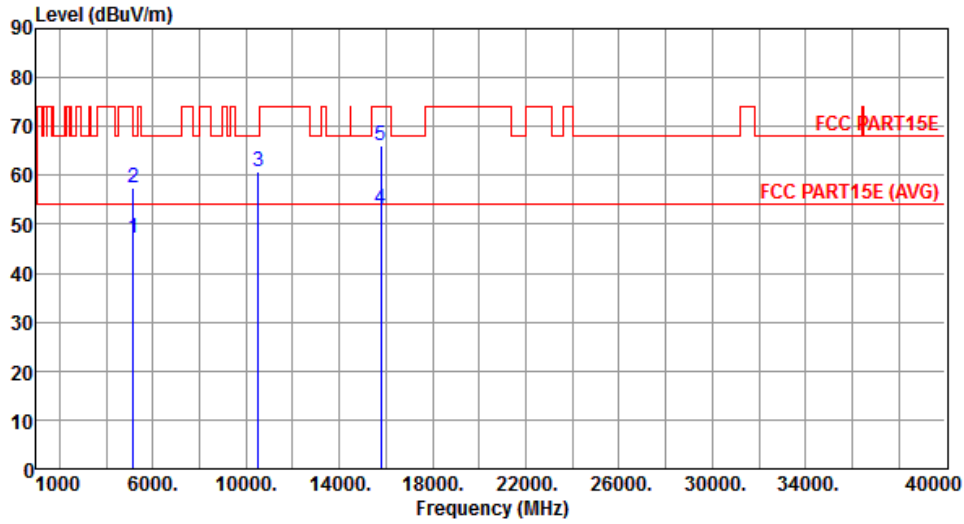

	Freq. MHz	Emission level dBuV/m	Limit dBuV/m	Margin dB	SA reading dBuV	Factor dB	Remark	ANT High cm	Turn Table deg
1	5150.00	47.24	54.00	-6.76	40.93	6.31	Average	150	196
2	5150.00	57.50	74.00	-16.50	51.19	6.31	Peak	150	196
3	10520.00	60.74	68.20	-7.46	44.14	16.60	Peak	376	199
4	15780.00	53.25	54.00	-0.75	36.20	17.05	Average	154	186
5	15780.00	66.16	74.00	-7.84	49.11	17.05	Peak	154	186

Note 1: Emission Level (dBuV/m) = SA Reading (dBuV/m) + Factor\* (dB)

\*Factor includes antenna factor , cable loss and amplifier gain

Note 2: Margin (dB) = Emission level (dBuV/m) – Limit (dBuV/m).

<b>Modulation</b>	HT20	<b>Test Freq. (MHz)</b>	5300
<b>Polarization</b>	Horizontal	<b>Test Configuration</b>	1

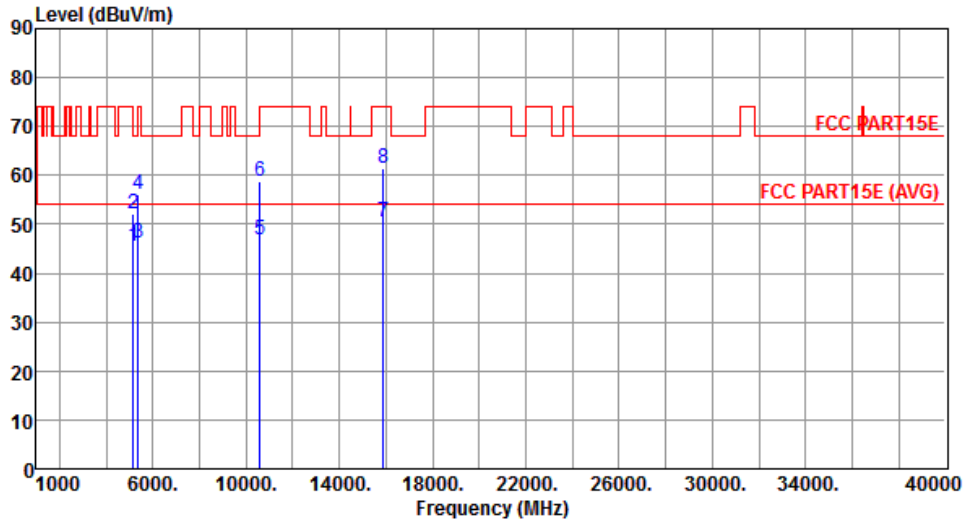

	Freq. MHz	Emission level dBuV/m	Limit dBuV/m	Margin dB	SA reading dBuV	Factor dB	Remark	ANT High cm	Turn Table deg
1	5150.00	45.36	54.00	-8.64	39.05	6.31	Average	153	94
2	5150.00	52.19	74.00	-21.81	45.88	6.31	Peak	153	94
3	5350.00	46.19	54.00	-7.81	39.57	6.62	Average	153	94
4	5350.00	56.24	74.00	-17.76	49.62	6.62	Peak	153	94
5	10600.00	46.75	54.00	-7.25	30.13	16.62	Average	200	225
6	10600.00	58.73	74.00	-15.27	42.11	16.62	Peak	200	225
7	15900.00	50.41	54.00	-3.59	33.59	16.82	Average	150	133
8	15900.00	61.52	74.00	-12.48	44.70	16.82	Peak	150	133

Note 1: Emission Level (dBuV/m) = SA Reading (dBuV/m) + Factor\* (dB)

\*Factor includes antenna factor , cable loss and amplifier gain

Note 2: Margin (dB) = Emission level (dBuV/m) – Limit (dBuV/m).

<b>Modulation</b>	HT20	<b>Test Freq. (MHz)</b>	5300
<b>Polarization</b>	Vertical	<b>Test Configuration</b>	1

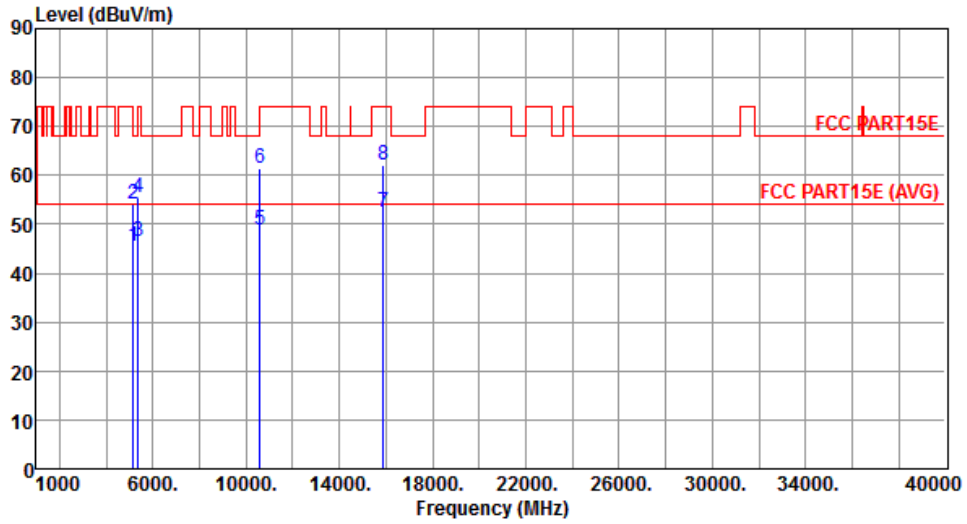

	Freq. MHz	Emission level dBuV/m	Limit dBuV/m	Margin dB	SA reading dBuV	Factor dB	Remark	ANT High cm	Turn Table deg
1	5150.00	45.38	54.00	-8.62	39.07	6.31	Average	150	200
2	5150.00	54.09	74.00	-19.91	47.78	6.31	Peak	150	200
3	5350.00	46.58	54.00	-7.42	39.96	6.62	Average	150	200
4	5350.00	55.40	74.00	-18.60	48.78	6.62	Peak	150	200
5	10600.00	48.92	54.00	-5.08	32.30	16.62	Average	361	189
6	10600.00	61.29	74.00	-12.71	44.67	16.62	Peak	361	189
7	15900.00	52.60	54.00	-1.40	35.78	16.82	Average	163	185
8	15900.00	62.11	74.00	-11.89	45.29	16.82	Peak	163	185

Note 1: Emission Level (dBuV/m) = SA Reading (dBuV/m) + Factor\* (dB)

\*Factor includes antenna factor , cable loss and amplifier gain

Note 2: Margin (dB) = Emission level (dBuV/m) – Limit (dBuV/m).

<b>Modulation</b>	HT20	<b>Test Freq. (MHz)</b>	5320
<b>Polarization</b>	Horizontal	<b>Test Configuration</b>	1

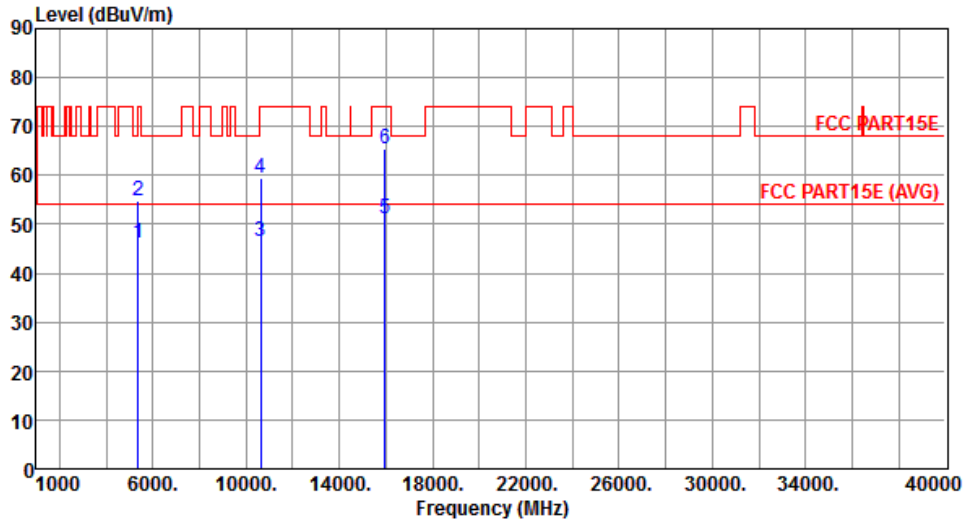

	Freq. MHz	Emission level dBuV/m	Limit dBuV/m	Margin dB	SA reading dBuV	Factor dB	Remark	ANT High cm	Turn Table deg
1	5350.00	46.24	54.00	-7.76	39.62	6.62	Average	150	94
2	5350.00	54.95	74.00	-19.05	48.33	6.62	Peak	150	94
3	10640.00	46.50	54.00	-7.50	29.87	16.63	Average	198	174
4	10640.00	59.42	74.00	-14.58	42.79	16.63	Peak	198	174
5	15960.00	51.04	54.00	-2.96	34.34	16.70	Average	255	174
6	15960.00	65.35	74.00	-8.65	48.65	16.70	Peak	255	174

Note 1: Emission Level (dBuV/m) = SA Reading (dBuV/m) + Factor\* (dB)

\*Factor includes antenna factor , cable loss and amplifier gain

Note 2: Margin (dB) = Emission level (dBuV/m) – Limit (dBuV/m).



<b>Modulation</b>	HT20	<b>Test Freq. (MHz)</b>	5320
<b>Polarization</b>	Vertical	<b>Test Configuration</b>	1

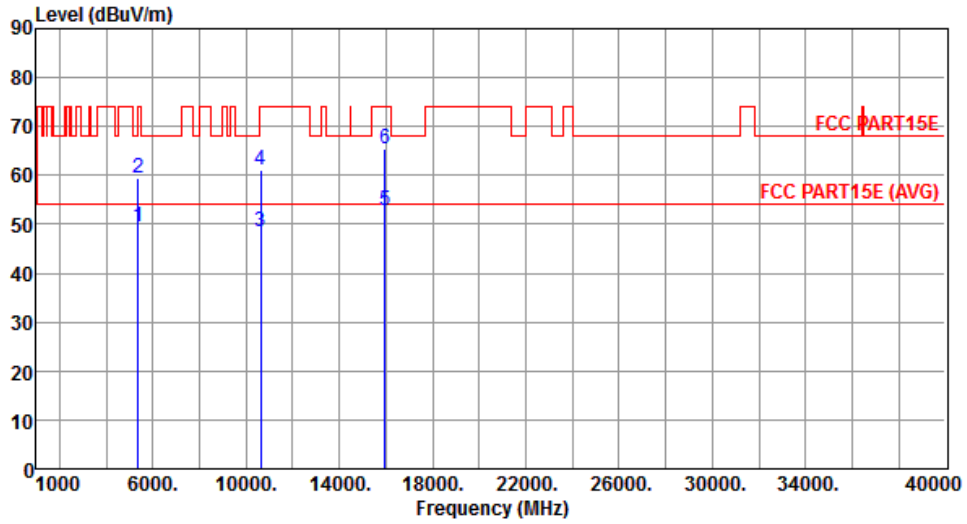

	Freq. MHz	Emission level dBuV/m	Limit dBuV/m	Margin dB	SA reading dBuV	Factor dB	Remark	ANT High cm	Turn Table deg
1	5350.00	49.62	54.00	-4.38	43.00	6.62	Average	150	147
2	5350.00	59.29	74.00	-14.71	52.67	6.62	Peak	150	147
3	10640.00	48.43	54.00	-5.57	31.80	16.63	Average	357	172
4	10640.00	61.23	74.00	-12.77	44.60	16.63	Peak	357	172
5	15960.00	52.81	54.00	-1.19	36.11	16.70	Average	152	185
6	15960.00	65.56	74.00	-8.44	48.86	16.70	Peak	152	185

Note 1: Emission Level (dBuV/m) = SA Reading (dBuV/m) + Factor\* (dB)

\*Factor includes antenna factor , cable loss and amplifier gain

Note 2: Margin (dB) = Emission level (dBuV/m) – Limit (dBuV/m).

<b>Modulation</b>	HT20	<b>Test Freq. (MHz)</b>	5500
<b>Polarization</b>	Horizontal	<b>Test Configuration</b>	1

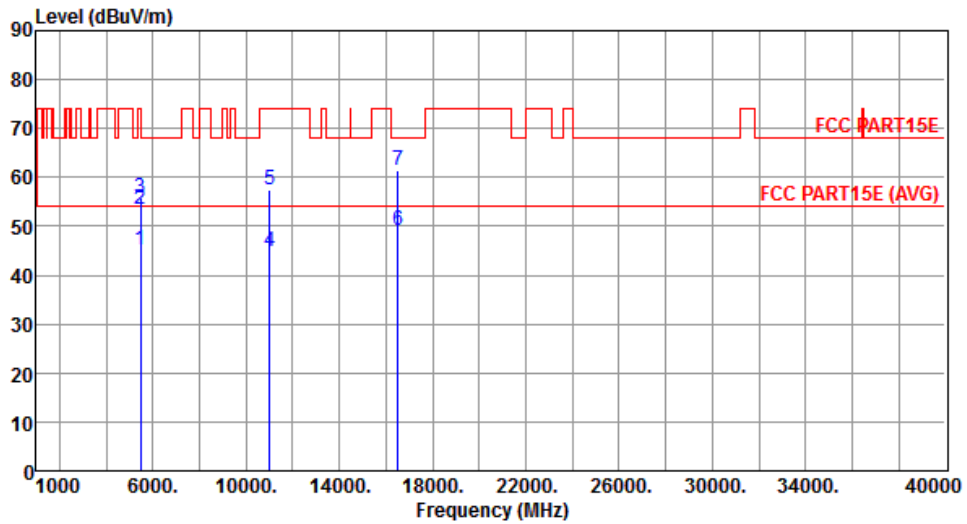

	Freq. MHz	Emission level dBuV/m	Limit dBuV/m	Margin dB	SA reading dBuV	Factor dB	Remark	ANT High cm	Turn Table deg
1	5460.00	45.01	54.00	-8.99	38.25	6.76	Average	237	287
2	5460.00	53.43	74.00	-20.57	46.67	6.76	Peak	237	287
3	5470.00	55.71	68.20	-12.49	48.94	6.77	Peak	237	287
4	11000.00	44.76	54.00	-9.24	28.04	16.72	Average	230	198
5	11000.00	57.32	74.00	-16.68	40.60	16.72	Peak	230	198
6	16500.00	49.13	54.00	-4.87	31.26	17.87	Average	150	130
7	16500.00	61.57	68.20	-6.63	43.70	17.87	Peak	150	130

Note 1: Emission Level (dBuV/m) = SA Reading (dBuV/m) + Factor\* (dB)

\*Factor includes antenna factor , cable loss and amplifier gain

Note 2: Margin (dB) = Emission level (dBuV/m) – Limit (dBuV/m).

<b>Modulation</b>	HT20	<b>Test Freq. (MHz)</b>	5500
<b>Polarization</b>	Vertical	<b>Test Configuration</b>	1

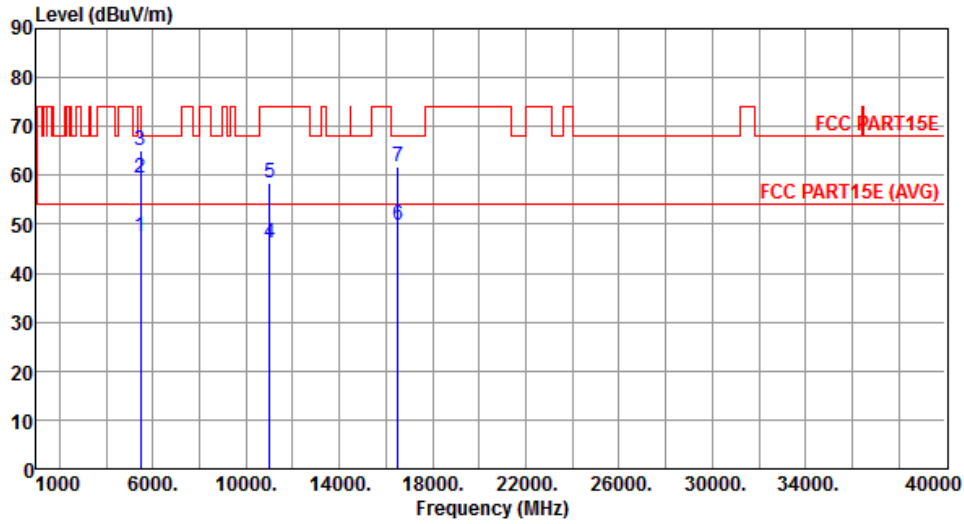

	Freq. MHz	Emission level dBuV/m	Limit dBuV/m	Margin dB	SA reading dBuV	Factor dB	Remark	ANT High cm	Turn Table deg
1	5460.00	47.35	54.00	-6.65	40.59	6.76	Average	150	200
2	5460.00	59.34	74.00	-14.66	52.58	6.76	Peak	150	200
3	5470.00	65.06	68.20	-3.14	58.29	6.77	Peak	150	200
4	11000.00	46.01	54.00	-7.99	29.29	16.72	Average	361	192
5	11000.00	58.49	74.00	-15.51	41.77	16.72	Peak	361	192
6	16500.00	49.77	54.00	-4.23	31.90	17.87	Average	154	185
7	16500.00	61.87	68.20	-6.33	44.00	17.87	Peak	154	185

Note 1: Emission Level (dBuV/m) = SA Reading (dBuV/m) + Factor\* (dB)

\*Factor includes antenna factor , cable loss and amplifier gain

Note 2: Margin (dB) = Emission level (dBuV/m) – Limit (dBuV/m).

<b>Modulation</b>	HT20	<b>Test Freq. (MHz)</b>	5580
<b>Polarization</b>	Horizontal	<b>Test Configuration</b>	1

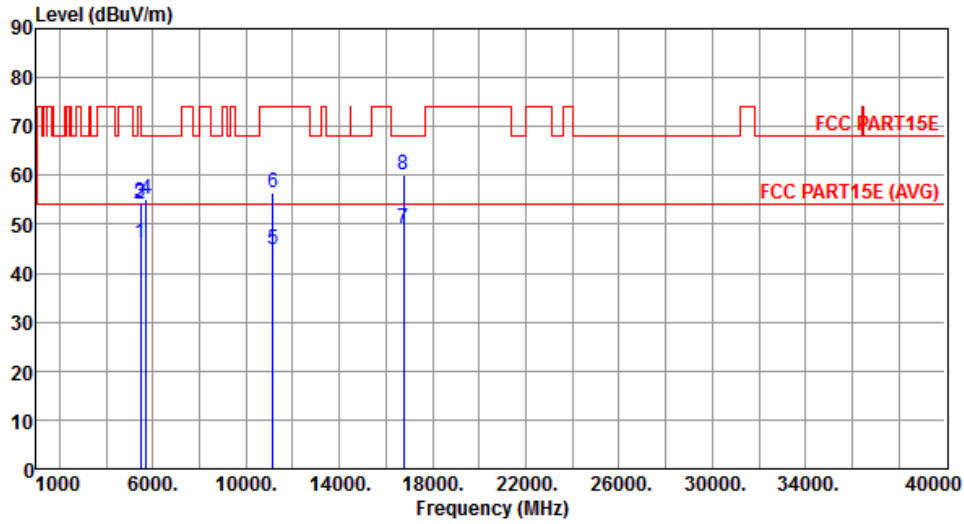

	Freq. MHz	Emission level dBuV/m	Limit dBuV/m	Margin dB	SA reading dBuV	Factor dB	Remark	ANT High cm	Turn Table deg
1	5460.00	46.01	54.00	-7.99	39.25	6.76	Average	216	175
2	5460.00	54.01	74.00	-19.99	47.25	6.76	Peak	216	175
3	5470.00	54.51	68.20	-13.69	47.74	6.77	Peak	216	175
4	5725.00	55.02	68.20	-13.18	47.78	7.24	Peak	216	175
5	11160.00	44.81	54.00	-9.19	28.02	16.79	Average	214	128
6	11160.00	56.55	74.00	-17.45	39.76	16.79	Peak	214	128
7	16740.00	49.16	54.00	-4.84	30.76	18.40	Average	220	130
8	16740.00	60.22	68.20	-7.98	41.82	18.40	Peak	220	130

Note 1: Emission Level (dBuV/m) = SA Reading (dBuV/m) + Factor\* (dB)

\*Factor includes antenna factor , cable loss and amplifier gain

Note 2: Margin (dB) = Emission level (dBuV/m) – Limit (dBuV/m).

<b>Modulation</b>	HT20	<b>Test Freq. (MHz)</b>	5580
<b>Polarization</b>	Vertical	<b>Test Configuration</b>	1

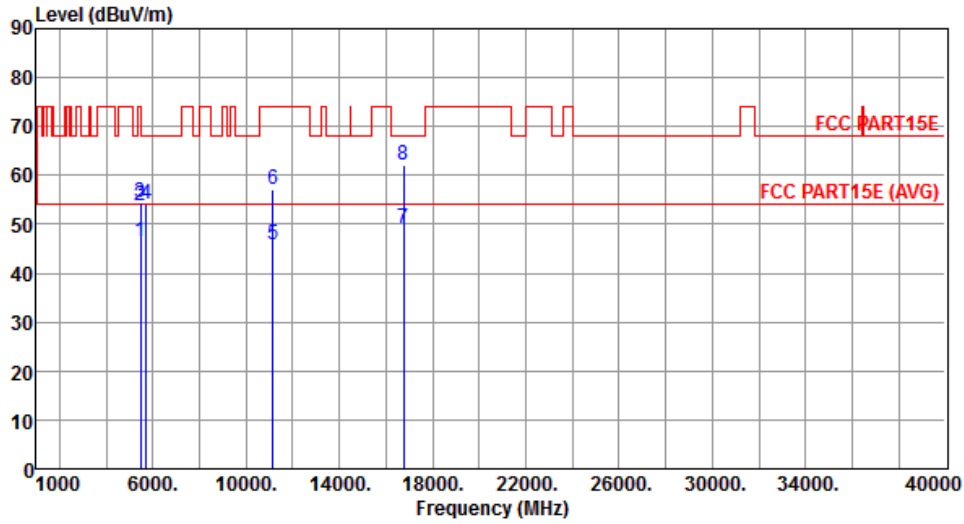

	Freq. MHz	Emission level dBuV/m	Limit dBuV/m	Margin dB	SA reading dBuV	Factor dB	Remark	ANT High cm	Turn Table deg
1	5460.00	46.40	54.00	-7.60	39.64	6.76	Average	150	202
2	5460.00	53.73	74.00	-20.27	46.97	6.76	Peak	150	202
3	5470.00	54.38	68.20	-13.82	47.61	6.77	Peak	150	202
4	5725.00	54.02	68.20	-14.18	46.78	7.24	Peak	150	202
5	11160.00	45.69	54.00	-8.31	28.90	16.79	Average	395	339
6	11160.00	57.04	74.00	-16.96	40.25	16.79	Peak	395	339
7	16740.00	49.10	54.00	-4.90	30.70	18.40	Average	150	196
8	16740.00	62.05	68.20	-6.15	43.65	18.40	Peak	150	196

Note 1: Emission Level (dBuV/m) = SA Reading (dBuV/m) + Factor\* (dB)

\*Factor includes antenna factor , cable loss and amplifier gain

Note 2: Margin (dB) = Emission level (dBuV/m) – Limit (dBuV/m).

<b>Modulation</b>	HT20	<b>Test Freq. (MHz)</b>	5700
<b>Polarization</b>	Horizontal	<b>Test Configuration</b>	1

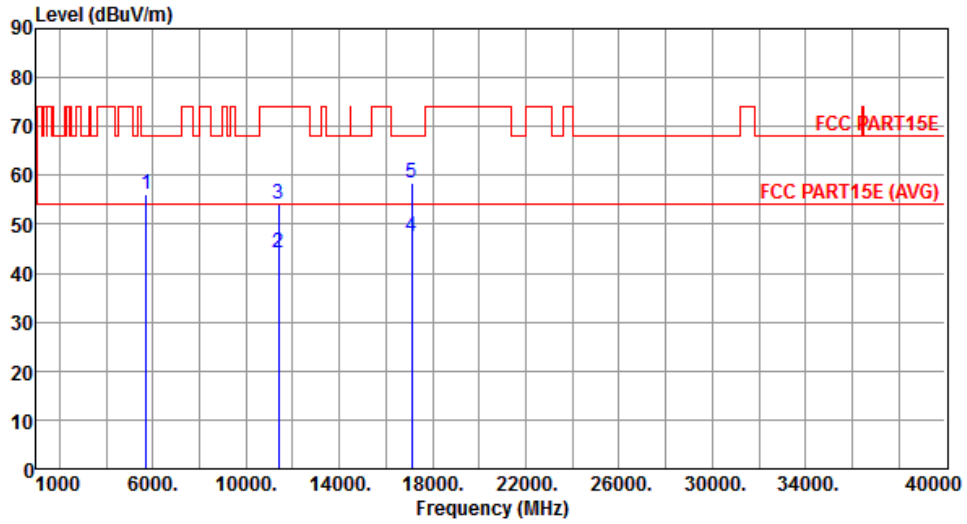

	Freq. MHz	Emission level dBuV/m	Limit dBuV/m	Margin dB	SA reading dBuV	Factor dB	Remark	ANT High cm	Turn Table deg
1	5725.00	56.14	68.20	-12.06	48.90	7.24	Peak	207	96
2	11400.00	44.09	54.00	-9.91	27.21	16.88	Average	235	157
3	11400.00	54.06	74.00	-19.94	37.18	16.88	Peak	235	157
4	17100.00	47.52	54.00	-6.48	28.40	19.12	Average	198	150
5	17100.00	58.42	68.20	-9.78	39.30	19.12	Peak	198	150

Note 1: Emission Level (dBuV/m) = SA Reading (dBuV/m) + Factor\* (dB)

\*Factor includes antenna factor , cable loss and amplifier gain

Note 2: Margin (dB) = Emission level (dBuV/m) – Limit (dBuV/m).

<b>Modulation</b>	HT20	<b>Test Freq. (MHz)</b>	5700
<b>Polarization</b>	Vertical	<b>Test Configuration</b>	1

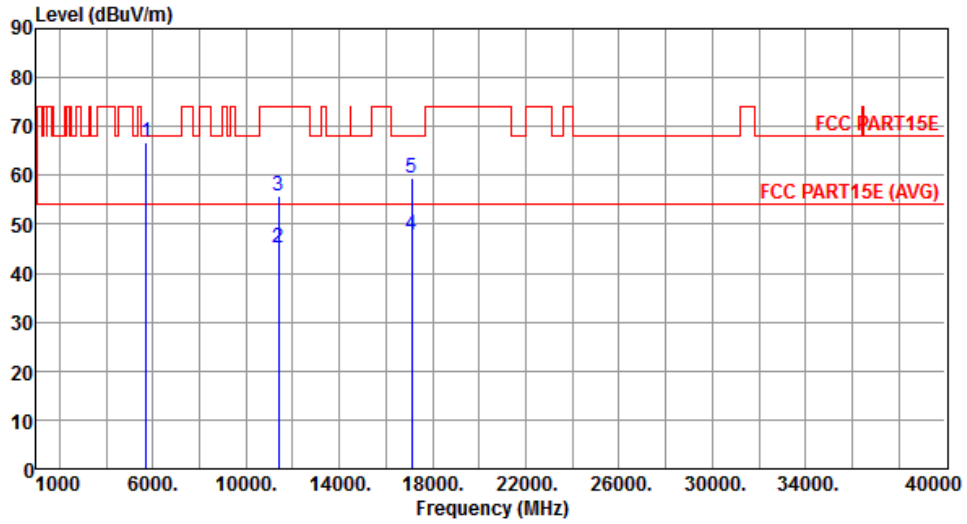

	Freq. MHz	Emission level dBuV/m	Limit dBuV/m	Margin dB	SA reading dBuV	Factor dB	Remark	ANT High cm	Turn Table deg
1	5725.00	66.78	68.20	-1.42	59.54	7.24	Peak	150	216
2	11400.00	45.17	54.00	-8.83	28.29	16.88	Average	350	269
3	11400.00	55.64	74.00	-18.36	38.76	16.88	Peak	350	269
4	17100.00	47.67	54.00	-6.33	28.55	19.12	Average	150	190
5	17100.00	59.36	68.20	-8.84	40.24	19.12	Peak	150	190

Note 1: Emission Level (dBuV/m) = SA Reading (dBuV/m) + Factor\* (dB)

\*Factor includes antenna factor , cable loss and amplifier gain

Note 2: Margin (dB) = Emission level (dBuV/m) – Limit (dBuV/m).

<b>Modulation</b>	HT20	<b>Test Freq. (MHz)</b>	5745
<b>Polarization</b>	Horizontal	<b>Test Configuration</b>	1

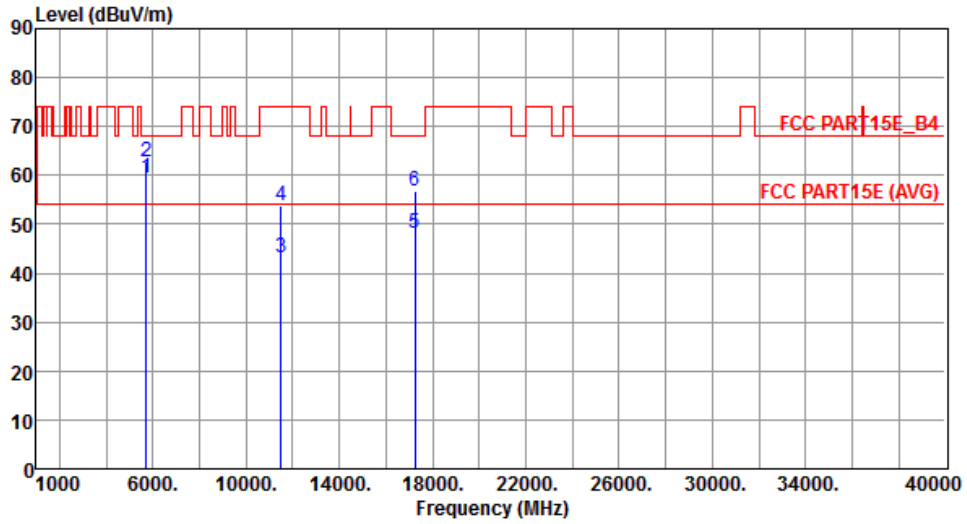

	Freq. MHz	Emission level dBuV/m	Limit dBuV/m	Margin dB	SA reading dBuV	Factor dB	Remark	ANT High cm	Turn Table deg
1	5715.00	59.51	68.20	-8.69	52.31	7.20	Peak	167	308
2	5725.00	62.84	78.20	-15.36	55.60	7.24	Peak	167	308
3	11490.00	43.28	54.00	-10.72	26.37	16.91	Average	177	150
4	11490.00	53.95	74.00	-20.05	37.04	16.91	Peak	177	150
5	17235.00	48.01	54.00	-5.99	28.69	19.32	Average	150	90
6	17235.00	56.91	68.20	-11.29	37.59	19.32	Peak	150	90

Note 1: Emission Level (dBuV/m) = SA Reading (dBuV/m) + Factor\* (dB)

\*Factor includes antenna factor , cable loss and amplifier gain

Note 2: Margin (dB) = Emission level (dBuV/m) – Limit (dBuV/m).



<b>Modulation</b>	HT20	<b>Test Freq. (MHz)</b>	5745
<b>Polarization</b>	Vertical	<b>Test Configuration</b>	1

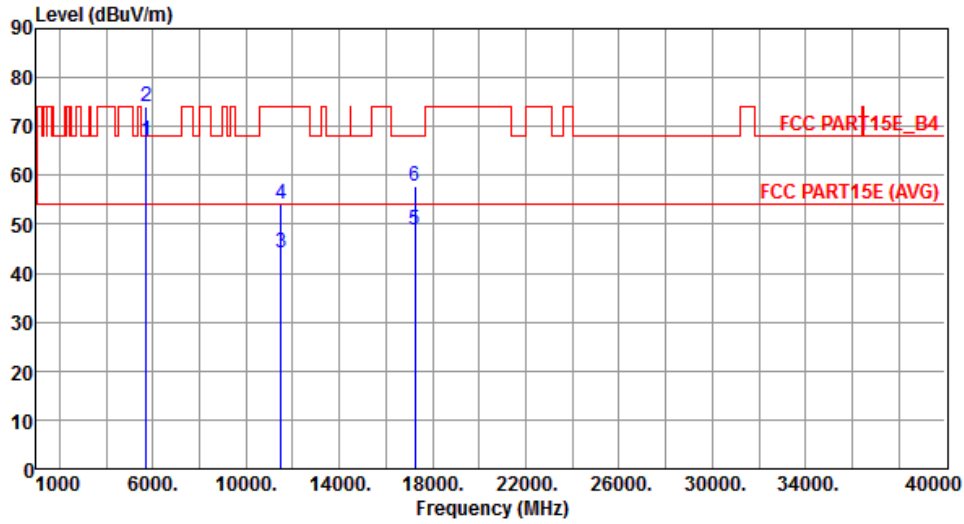

	Freq. MHz	Emission level dBuV/m	Limit dBuV/m	Margin dB	SA reading dBuV	Factor dB	Remark	ANT High cm	Turn Table deg
1	5715.00	67.16	68.20	-1.04	59.96	7.20	Peak	150	201
2	5725.00	73.93	78.20	-4.27	66.69	7.24	Peak	150	201
3	11490.00	44.24	54.00	-9.76	27.33	16.91	Average	298	165
4	11490.00	54.14	74.00	-19.86	37.23	16.91	Peak	298	165
5	17235.00	48.82	54.00	-5.18	29.50	19.32	Average	150	142
6	17235.00	57.81	68.20	-10.39	38.49	19.32	Peak	150	142

Note 1: Emission Level (dBuV/m) = SA Reading (dBuV/m) + Factor\* (dB)

\*Factor includes antenna factor , cable loss and amplifier gain

Note 2: Margin (dB) = Emission level (dBuV/m) – Limit (dBuV/m).

<b>Modulation</b>	HT20	<b>Test Freq. (MHz)</b>	5785
<b>Polarization</b>	Horizontal	<b>Test Configuration</b>	1

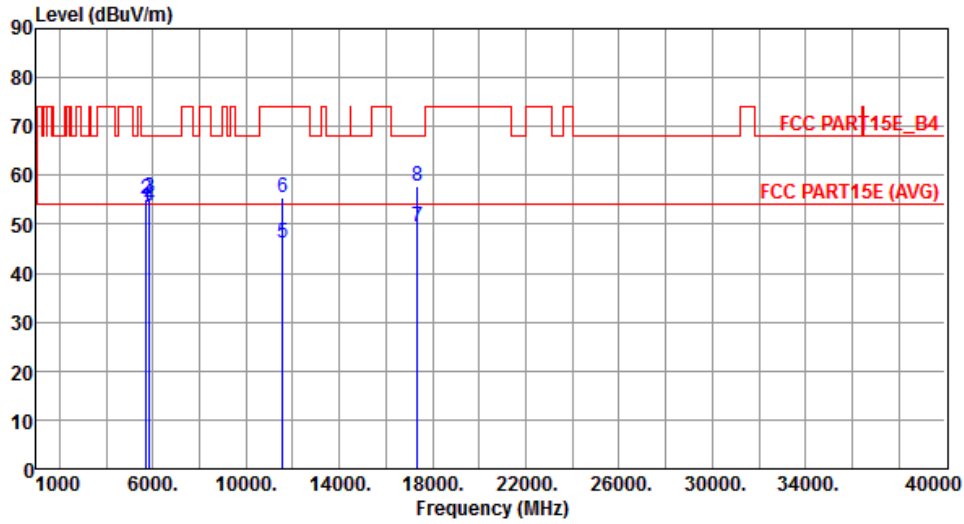

	Freq. MHz	Emission level dBuV/m	Limit dBuV/m	Margin dB	SA reading dBuV	Factor dB	Remark	ANT High cm	Turn Table deg
1	5715.00	53.41	68.20	-14.79	46.21	7.20	Peak	150	235
2	5725.00	55.12	78.20	-23.08	47.88	7.24	Peak	150	235
3	5850.00	55.39	78.20	-22.81	47.89	7.50	Peak	150	235
4	5860.00	53.78	68.20	-14.42	46.27	7.51	Peak	150	235
5	11570.00	46.06	54.00	-7.94	29.26	16.80	Average	213	198
6	11570.00	55.42	74.00	-18.58	38.62	16.80	Peak	213	198
7	17355.00	49.44	54.00	-4.56	29.95	19.49	Average	150	90
8	17355.00	57.94	68.20	-10.26	38.45	19.49	Peak	150	90

Note 1: Emission Level (dBuV/m) = SA Reading (dBuV/m) + Factor\* (dB)

\*Factor includes antenna factor , cable loss and amplifier gain

Note 2: Margin (dB) = Emission level (dBuV/m) – Limit (dBuV/m).

<b>Modulation</b>	HT20	<b>Test Freq. (MHz)</b>	5785
<b>Polarization</b>	Vertical	<b>Test Configuration</b>	1

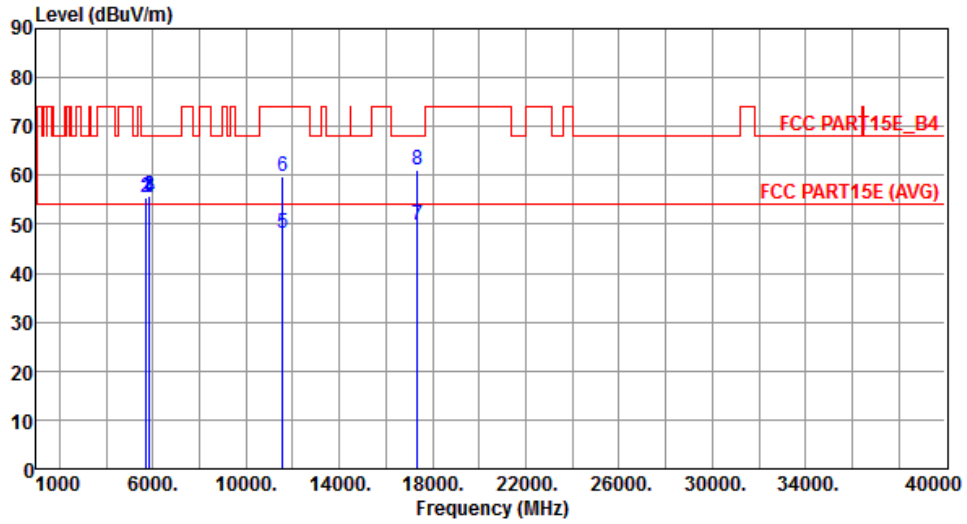

	Freq. MHz	Emission level dBuV/m	Limit dBuV/m	Margin dB	SA reading dBuV	Factor dB	Remark	ANT High cm	Turn Table deg
1	5715.00	55.51	68.20	-12.69	48.31	7.20	Peak	150	208
2	5725.00	55.59	78.20	-22.61	48.35	7.24	Peak	150	208
3	5850.00	55.76	78.20	-22.44	48.26	7.50	Peak	150	208
4	5860.00	55.39	68.20	-12.81	47.88	7.51	Peak	150	208
5	11570.00	48.06	54.00	-5.94	31.26	16.80	Average	388	169
6	11570.00	59.83	74.00	-14.17	43.03	16.80	Peak	388	169
7	17355.00	49.77	54.00	-4.23	30.28	19.49	Average	150	142
8	17355.00	61.12	68.20	-7.08	41.63	19.49	Peak	150	142

Note 1: Emission Level (dBuV/m) = SA Reading (dBuV/m) + Factor\* (dB)

\*Factor includes antenna factor , cable loss and amplifier gain

Note 2: Margin (dB) = Emission level (dBuV/m) – Limit (dBuV/m).

<b>Modulation</b>	HT20	<b>Test Freq. (MHz)</b>	5825
<b>Polarization</b>	Horizontal	<b>Test Configuration</b>	1

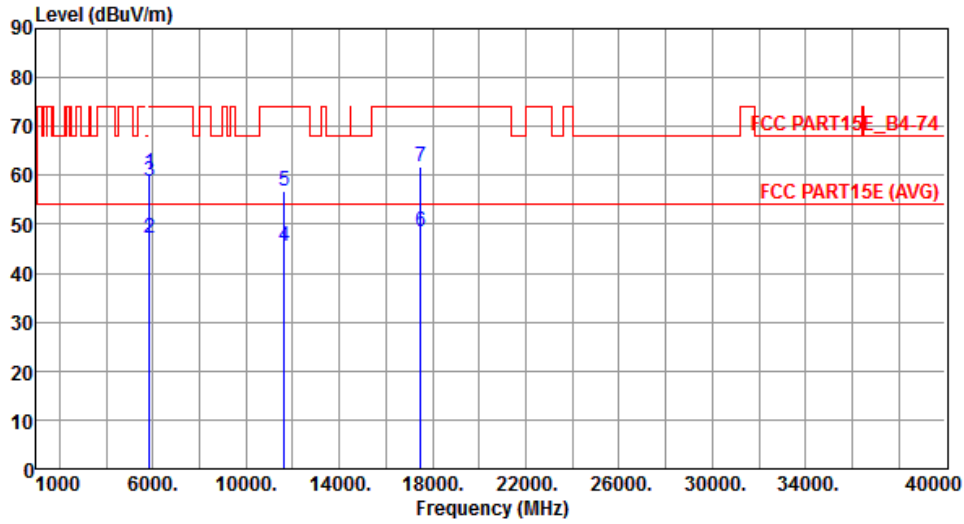

	Freq. MHz	Emission level dBuV/m	Limit dBuV/m	Margin dB	SA reading dBuV	Factor dB	Remark	ANT High cm	Turn Table deg
1	5850.00	60.28	78.20	-17.92	52.78	7.50	Peak	180	306
2	5860.00	47.17	54.00	-6.83	39.66	7.51	Average	180	306
3	5860.00	58.77	74.00	-15.23	51.26	7.51	Peak	180	306
4	11650.00	45.35	54.00	-8.65	28.70	16.65	Average	189	135
5	11650.00	56.78	74.00	-17.22	40.13	16.65	Peak	189	135
6	17475.00	48.36	54.00	-5.64	28.70	19.66	Average	150	90
7	17475.00	61.70	74.00	-12.30	42.04	19.66	Peak	150	90

Note 1: Emission Level (dBuV/m) = SA Reading (dBuV/m) + Factor\* (dB)

\*Factor includes antenna factor , cable loss and amplifier gain

Note 2: Margin (dB) = Emission level (dBuV/m) – Limit (dBuV/m).

<b>Modulation</b>	HT20	<b>Test Freq. (MHz)</b>	5825
<b>Polarization</b>	Vertical	<b>Test Configuration</b>	1

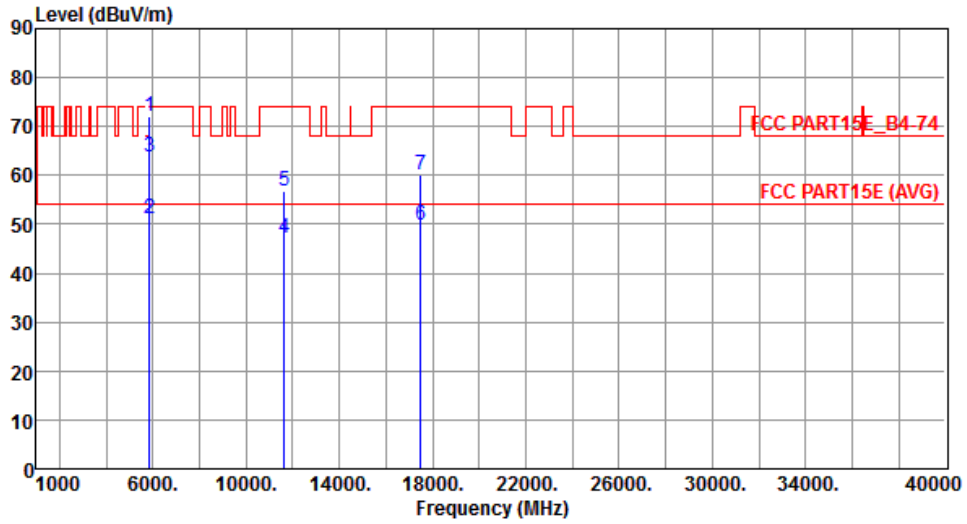

	Freq. MHz	Emission level dBuV/m	Limit dBuV/m	Margin dB	SA reading dBuV	Factor dB	Remark	ANT High cm	Turn Table deg
1	5850.00	72.05	78.20	-6.15	64.55	7.50	Peak	150	210
2	5860.00	51.27	54.00	-2.73	43.76	7.51	Average	150	210
3	5860.00	63.70	74.00	-10.30	56.19	7.51	Peak	150	210
4	11650.00	47.19	54.00	-6.81	30.54	16.65	Average	297	265
5	11650.00	56.88	74.00	-17.12	40.23	16.65	Peak	297	265
6	17475.00	49.85	54.00	-4.15	30.19	19.66	Average	150	145
7	17475.00	60.19	74.00	-13.81	40.53	19.66	Peak	150	145

Note 1: Emission Level (dBuV/m) = SA Reading (dBuV/m) + Factor\* (dB)

\*Factor includes antenna factor , cable loss and amplifier gain

Note 2: Margin (dB) = Emission level (dBuV/m) – Limit (dBuV/m).

### 3.5.7 Transmitter Radiated Unwanted Emissions (Above 1GHz) for HT40

<b>Modulation</b>	HT40	<b>Test Freq. (MHz)</b>	5190
<b>Polarization</b>	Horizontal	<b>Test Configuration</b>	1

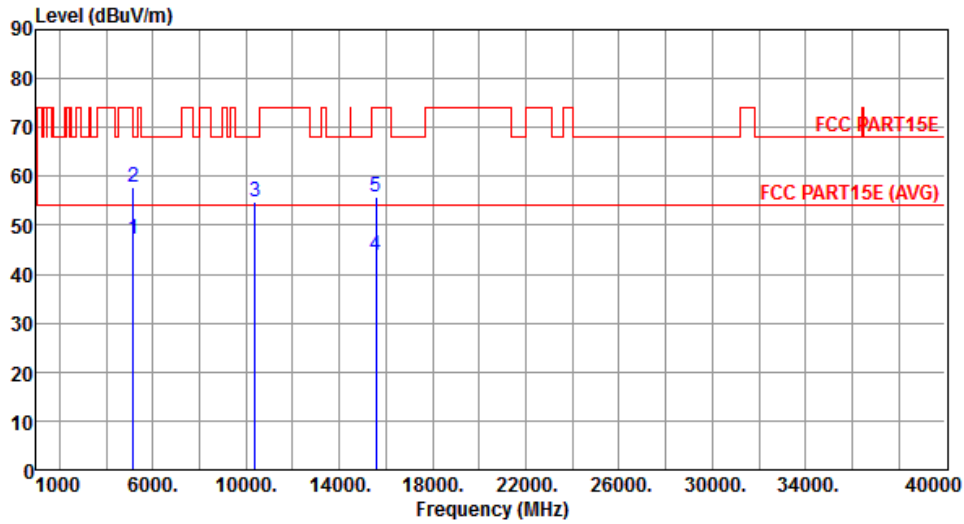

	Freq. MHz	Emission level dBuV/m	Limit dBuV/m	Margin dB	SA reading dBuV	Factor dB	Remark	ANT High cm	Turn Table deg
1	5150.00	47.12	54.00	-6.88	40.81	6.31	Average	159	95
2	5150.00	57.66	74.00	-16.34	51.35	6.31	Peak	159	95
3	10380.00	54.63	68.20	-13.57	38.26	16.37	Peak	150	100
4	15570.00	43.91	54.00	-10.09	26.48	17.43	Average	200	189
5	15570.00	55.93	74.00	-18.07	38.50	17.43	Peak	200	189

Note 1: Emission Level (dBuV/m) = SA Reading (dBuV/m) + Factor\* (dB)

\*Factor includes antenna factor , cable loss and amplifier gain

Note 2: Margin (dB) = Emission level (dBuV/m) – Limit (dBuV/m).

<b>Modulation</b>	HT40	<b>Test Freq. (MHz)</b>	5190
<b>Polarization</b>	Vertical	<b>Test Configuration</b>	1

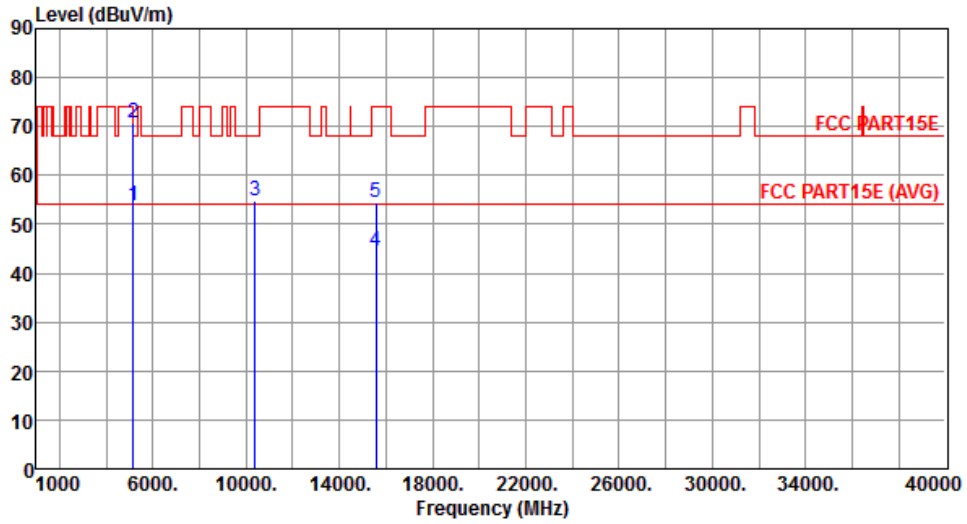

	Freq. MHz	Emission level dBuV/m	Limit dBuV/m	Margin dB	SA reading dBuV	Factor dB	Remark	ANT High cm	Turn Table deg
1	5150.00	53.77	54.00	-0.23	47.46	6.31	Average	150	157
2	5150.00	70.78	74.00	-3.22	64.47	6.31	Peak	150	157
3	10380.00	54.63	68.20	-13.57	38.26	16.37	Peak	150	196
4	15570.00	44.50	54.00	-9.50	27.07	17.43	Average	150	196
5	15570.00	54.56	74.00	-19.44	37.13	17.43	Peak	150	196

Note 1: Emission Level (dBuV/m) = SA Reading (dBuV/m) + Factor\* (dB)

\*Factor includes antenna factor , cable loss and amplifier gain

Note 2: Margin (dB) = Emission level (dBuV/m) – Limit (dBuV/m).

<b>Modulation</b>	HT40	<b>Test Freq. (MHz)</b>	5230
<b>Polarization</b>	Horizontal	<b>Test Configuration</b>	1

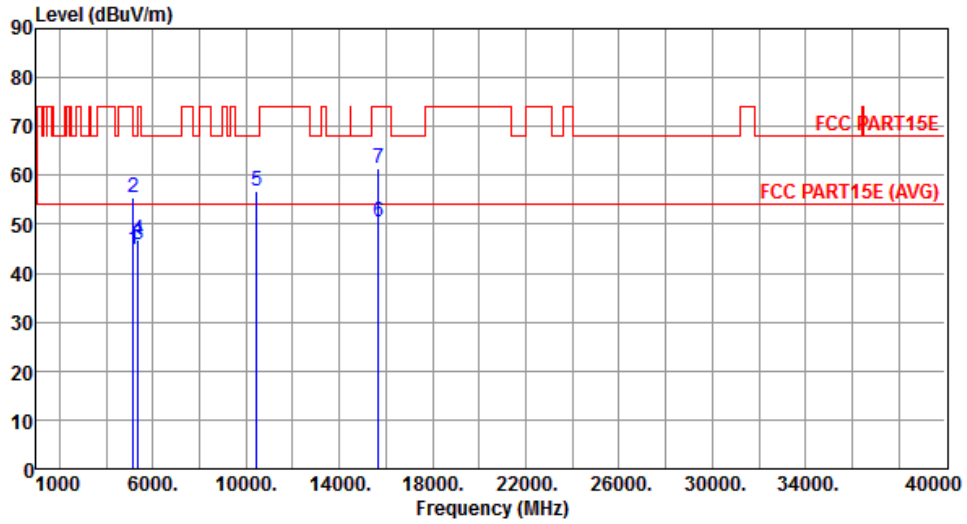

	Freq. MHz	Emission level dBuV/m	Limit dBuV/m	Margin dB	SA reading dBuV	Factor dB	Remark	ANT High cm	Turn Table deg
1	5150.00	44.89	54.00	-9.11	38.58	6.31	Average	150	91
2	5150.00	55.49	74.00	-18.51	49.18	6.31	Peak	150	91
3	5350.00	45.88	54.00	-8.12	39.26	6.62	Average	150	91
4	5350.00	46.88	74.00	-27.12	40.26	6.62	Peak	150	91
5	10460.00	56.78	68.20	-11.42	40.25	16.53	Peak	261	147
6	15690.00	50.60	54.00	-3.40	33.38	17.22	Average	150	134
7	15690.00	61.47	74.00	-12.53	44.25	17.22	Peak	150	134

Note 1: Emission Level (dBuV/m) = SA Reading (dBuV/m) + Factor\* (dB)

\*Factor includes antenna factor , cable loss and amplifier gain

Note 2: Margin (dB) = Emission level (dBuV/m) – Limit (dBuV/m).



<b>Modulation</b>	HT40	<b>Test Freq. (MHz)</b>	5230
<b>Polarization</b>	Vertical	<b>Test Configuration</b>	1

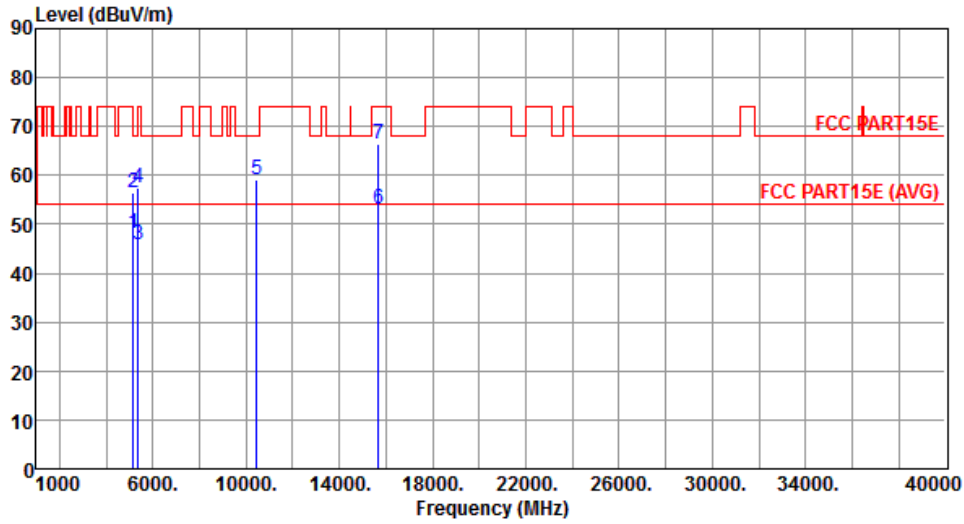

	Freq. MHz	Emission level dBuV/m	Limit dBuV/m	Margin dB	SA reading dBuV	Factor dB	Remark	ANT High cm	Turn Table deg
1	5150.00	48.16	54.00	-5.84	41.85	6.31	Average	150	154
2	5150.00	56.60	74.00	-17.40	50.29	6.31	Peak	150	154
3	5350.00	45.75	54.00	-8.25	39.13	6.62	Average	150	154
4	5350.00	57.51	74.00	-16.49	50.89	6.62	Peak	150	154
5	10460.00	59.18	68.20	-9.02	42.65	16.53	Peak	300	175
6	15690.00	53.27	54.00	-0.73	36.05	17.22	Average	153	186
7	15690.00	66.40	74.00	-7.60	49.18	17.22	Peak	153	186

Note 1: Emission Level (dBuV/m) = SA Reading (dBuV/m) + Factor\* (dB)

\*Factor includes antenna factor , cable loss and amplifier gain

Note 2: Margin (dB) = Emission level (dBuV/m) – Limit (dBuV/m).

<b>Modulation</b>	HT40	<b>Test Freq. (MHz)</b>	5270
<b>Polarization</b>	Horizontal	<b>Test Configuration</b>	1

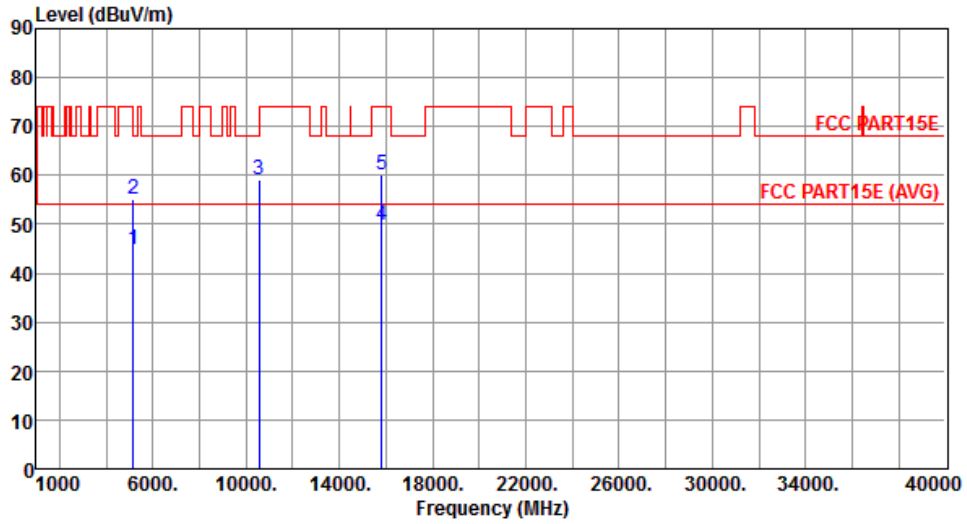

	Freq. MHz	Emission level dBuV/m	Limit dBuV/m	Margin dB	SA reading dBuV	Factor dB	Remark	ANT High cm	Turn Table deg
1	5150.00	44.99	54.00	-9.01	38.68	6.31	Average	150	106
2	5150.00	55.19	74.00	-18.81	48.88	6.31	Peak	150	106
3	10540.00	59.28	68.20	-8.92	42.68	16.60	Peak	231	169
4	15810.00	49.96	54.00	-4.04	32.98	16.98	Average	150	126
5	15810.00	60.19	74.00	-13.81	43.21	16.98	Peak	150	126

Note 1: Emission Level (dBuV/m) = SA Reading (dBuV/m) + Factor\* (dB)

\*Factor includes antenna factor , cable loss and amplifier gain

Note 2: Margin (dB) = Emission level (dBuV/m) – Limit (dBuV/m).

<b>Modulation</b>	HT40	<b>Test Freq. (MHz)</b>	5270
<b>Polarization</b>	Vertical	<b>Test Configuration</b>	1

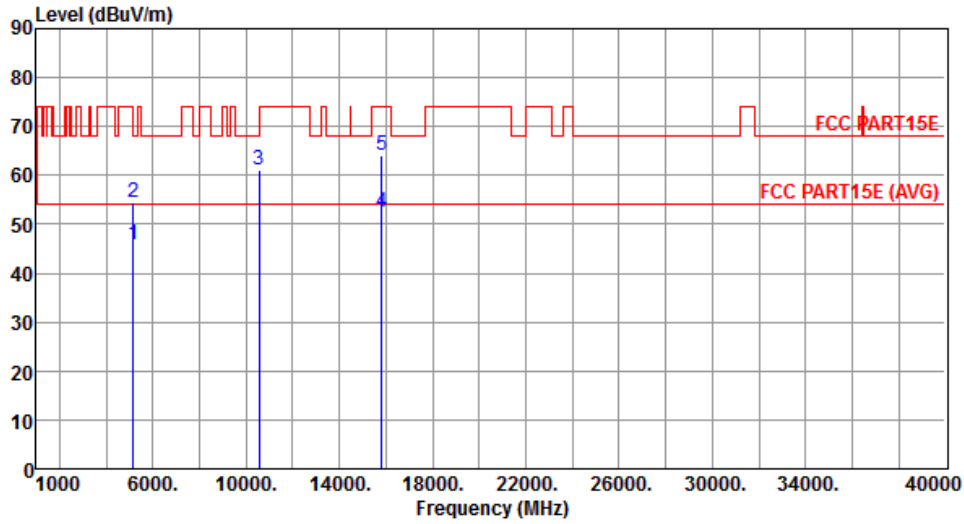

	Freq. MHz	Emission level dBuV/m	Limit dBuV/m	Margin dB	SA reading dBuV	Factor dB	Remark	ANT High cm	Turn Table deg
1	5150.00	45.84	54.00	-8.16	39.53	6.31	Average	151	156
2	5150.00	54.60	74.00	-19.40	48.29	6.31	Peak	151	156
3	10540.00	61.00	68.20	-7.20	44.40	16.60	Peak	305	269
4	15810.00	52.54	54.00	-1.46	35.56	16.98	Average	150	188
5	15810.00	64.17	74.00	-9.83	47.19	16.98	Peak	150	188

Note 1: Emission Level (dBuV/m) = SA Reading (dBuV/m) + Factor\* (dB)

\*Factor includes antenna factor , cable loss and amplifier gain

Note 2: Margin (dB) = Emission level (dBuV/m) – Limit (dBuV/m).

<b>Modulation</b>	HT40	<b>Test Freq. (MHz)</b>	5310
<b>Polarization</b>	Horizontal	<b>Test Configuration</b>	1

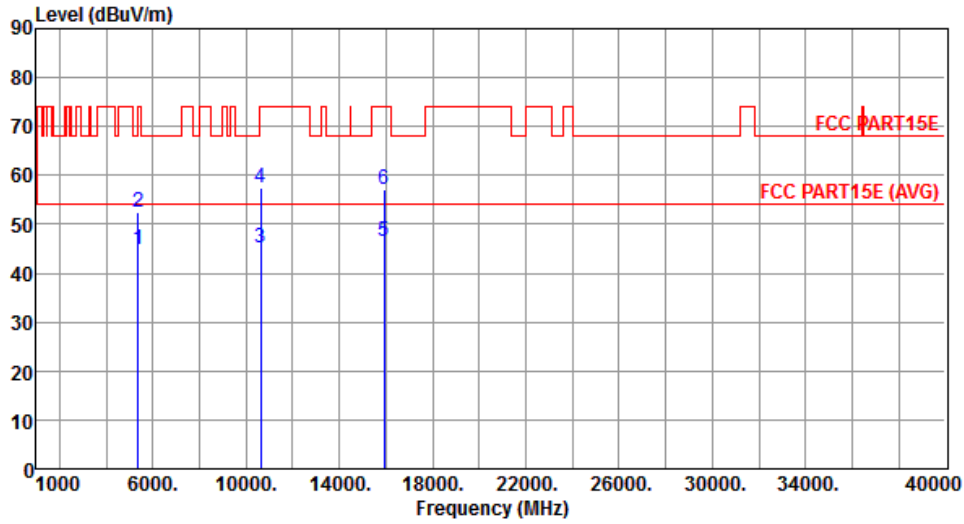

	Freq. MHz	Emission level dBuV/m	Limit dBuV/m	Margin dB	SA reading dBuV	Factor dB	Remark	ANT High cm	Turn Table deg
1	5350.00	44.88	54.00	-9.12	38.26	6.62	Average	151	125
2	5350.00	52.60	74.00	-21.40	45.98	6.62	Peak	151	125
3	10620.00	45.26	54.00	-8.74	28.64	16.62	Average	217	199
4	10620.00	57.33	74.00	-16.67	40.71	16.62	Peak	217	199
5	15930.00	46.37	54.00	-7.63	29.60	16.77	Average	150	126
6	15930.00	57.07	74.00	-16.93	40.30	16.77	Peak	150	126

Note 1: Emission Level (dBuV/m) = SA Reading (dBuV/m) + Factor\* (dB)

\*Factor includes antenna factor , cable loss and amplifier gain

Note 2: Margin (dB) = Emission level (dBuV/m) – Limit (dBuV/m).

<b>Modulation</b>	HT40	<b>Test Freq. (MHz)</b>	5310
<b>Polarization</b>	Vertical	<b>Test Configuration</b>	1

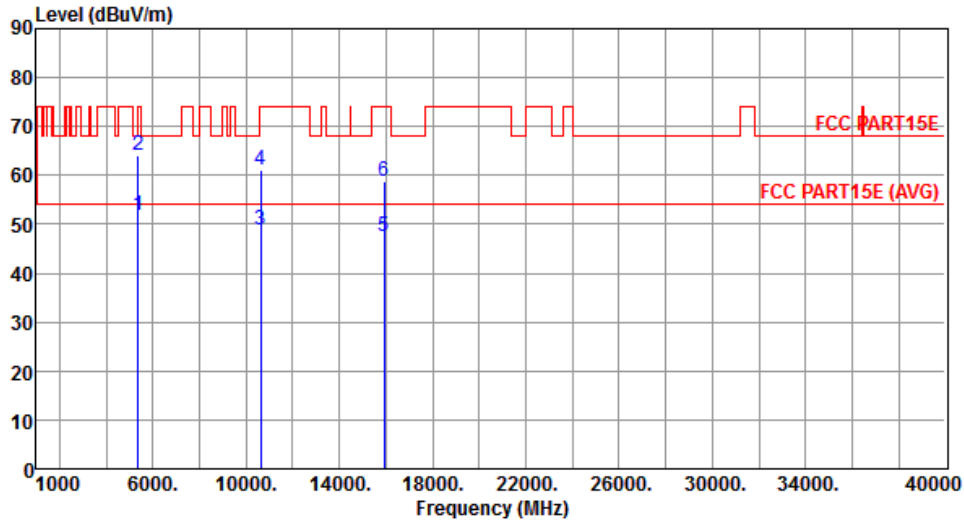

	Freq. MHz	Emission level dBuV/m	Limit dBuV/m	Margin dB	SA reading dBuV	Factor dB	Remark	ANT High cm	Turn Table deg
1	5350.00	51.85	54.00	-2.15	45.23	6.62	Average	150	147
2	5350.00	64.13	74.00	-9.87	57.51	6.62	Peak	150	147
3	10620.00	48.89	54.00	-5.11	32.27	16.62	Average	340	209
4	10620.00	60.99	74.00	-13.01	44.37	16.62	Peak	340	209
5	15930.00	47.57	54.00	-6.43	30.80	16.77	Average	150	187
6	15930.00	58.72	74.00	-15.28	41.95	16.77	Peak	150	187

Note 1: Emission Level (dBuV/m) = SA Reading (dBuV/m) + Factor\* (dB)

\*Factor includes antenna factor , cable loss and amplifier gain

Note 2: Margin (dB) = Emission level (dBuV/m) – Limit (dBuV/m).

<b>Modulation</b>	HT40	<b>Test Freq. (MHz)</b>	5510
<b>Polarization</b>	Horizontal	<b>Test Configuration</b>	1

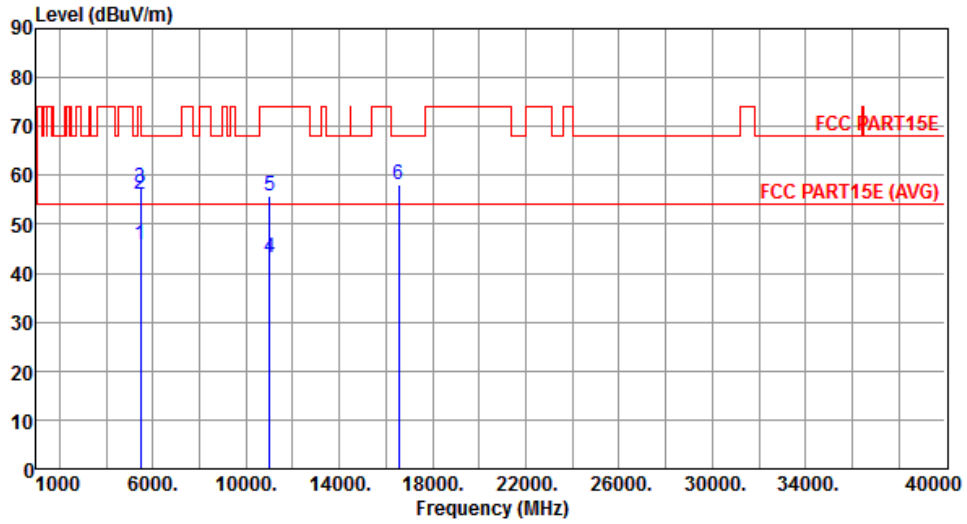

	Freq. MHz	Emission level dBuV/m	Limit dBuV/m	Margin dB	SA reading dBuV	Factor dB	Remark	ANT High cm	Turn Table deg
1	5460.00	45.70	54.00	-8.30	38.94	6.76	Average	204	68
2	5460.00	56.11	74.00	-17.89	49.35	6.76	Peak	204	68
3	5470.00	57.45	68.20	-10.75	50.68	6.77	Peak	204	68
4	11020.00	43.23	54.00	-10.77	26.50	16.73	Average	218	197
5	11020.00	55.63	74.00	-18.37	38.90	16.73	Peak	218	197
6	16530.00	57.97	68.20	-10.23	40.03	17.94	Peak	160	90

Note 1: Emission Level (dBuV/m) = SA Reading (dBuV/m) + Factor\* (dB)

\*Factor includes antenna factor , cable loss and amplifier gain

Note 2: Margin (dB) = Emission level (dBuV/m) – Limit (dBuV/m).

<b>Modulation</b>	HT40	<b>Test Freq. (MHz)</b>	5510
<b>Polarization</b>	Vertical	<b>Test Configuration</b>	1

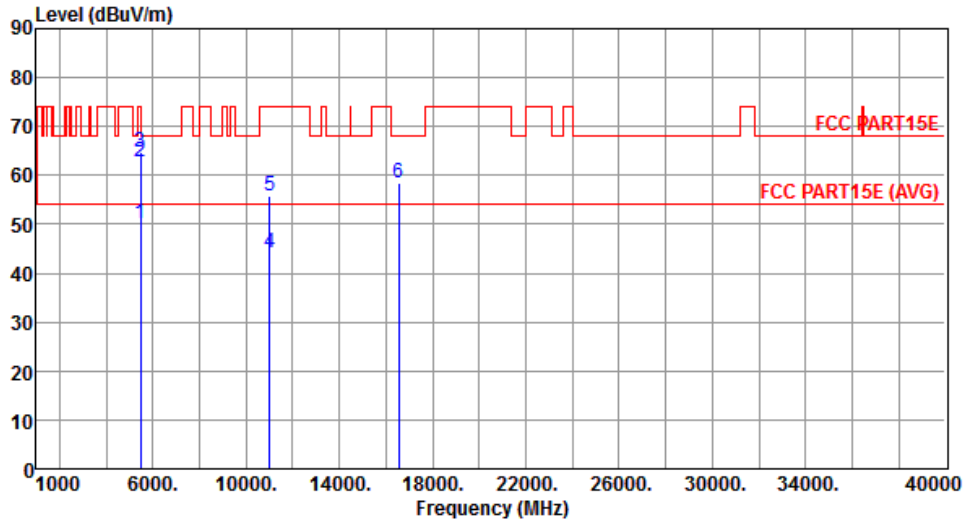

	Freq. MHz	Emission level dBuV/m	Limit dBuV/m	Margin dB	SA reading dBuV	Factor dB	Remark	ANT High cm	Turn Table deg
1	5460.00	50.08	54.00	-3.92	43.32	6.76	Average	150	204
2	5460.00	62.87	74.00	-11.13	56.11	6.76	Peak	150	204
3	5470.00	64.65	68.20	-3.55	57.88	6.77	Peak	150	204
4	11020.00	44.09	54.00	-9.91	27.36	16.73	Average	320	134
5	11020.00	55.72	74.00	-18.28	38.99	16.73	Peak	320	134
6	16530.00	58.30	68.20	-9.90	40.36	17.94	Peak	150	192

Note 1: Emission Level (dBuV/m) = SA Reading (dBuV/m) + Factor\* (dB)

\*Factor includes antenna factor , cable loss and amplifier gain

Note 2: Margin (dB) = Emission level (dBuV/m) – Limit (dBuV/m).

<b>Modulation</b>	HT40	<b>Test Freq. (MHz)</b>	5590
<b>Polarization</b>	Horizontal	<b>Test Configuration</b>	1

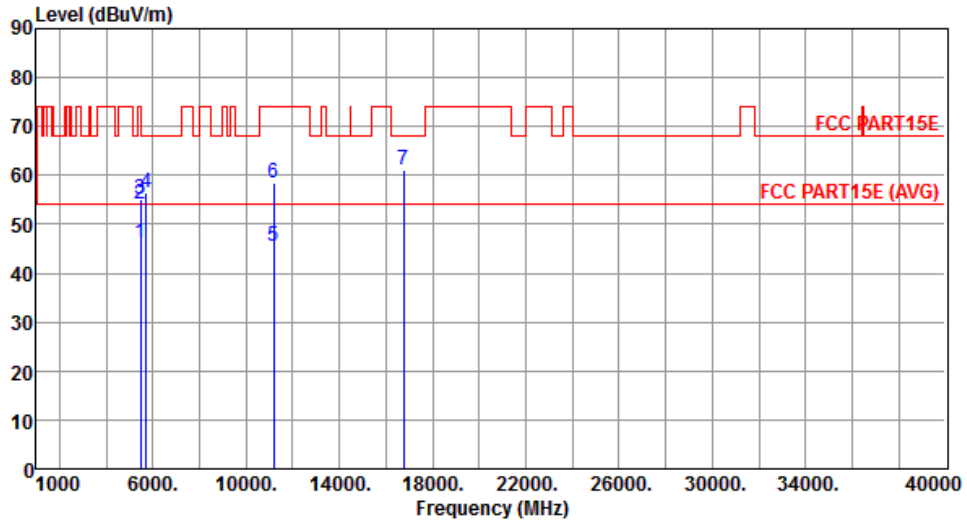

	Freq. MHz	Emission level dBuV/m	Limit dBuV/m	Margin dB	SA reading dBuV	Factor dB	Remark	ANT High cm	Turn Table deg
1	5460.00	46.05	54.00	-7.95	39.29	6.76	Average	239	354
2	5460.00	54.13	74.00	-19.87	47.37	6.76	Peak	239	354
3	5470.00	55.20	68.20	-13.00	48.43	6.77	Peak	239	354
4	5725.00	56.59	68.20	-11.61	49.35	7.24	Peak	239	354
5	11180.00	45.58	54.00	-8.42	28.79	16.79	Average	151	98
6	11180.00	58.43	74.00	-15.57	41.64	16.79	Peak	151	98
7	16770.00	61.07	68.20	-7.13	42.60	18.47	Peak	150	210

Note 1: Emission Level (dBuV/m) = SA Reading (dBuV/m) + Factor\* (dB)

\*Factor includes antenna factor , cable loss and amplifier gain

Note 2: Margin (dB) = Emission level (dBuV/m) – Limit (dBuV/m).



<b>Modulation</b>	HT40	<b>Test Freq. (MHz)</b>	5590
<b>Polarization</b>	Vertical	<b>Test Configuration</b>	1

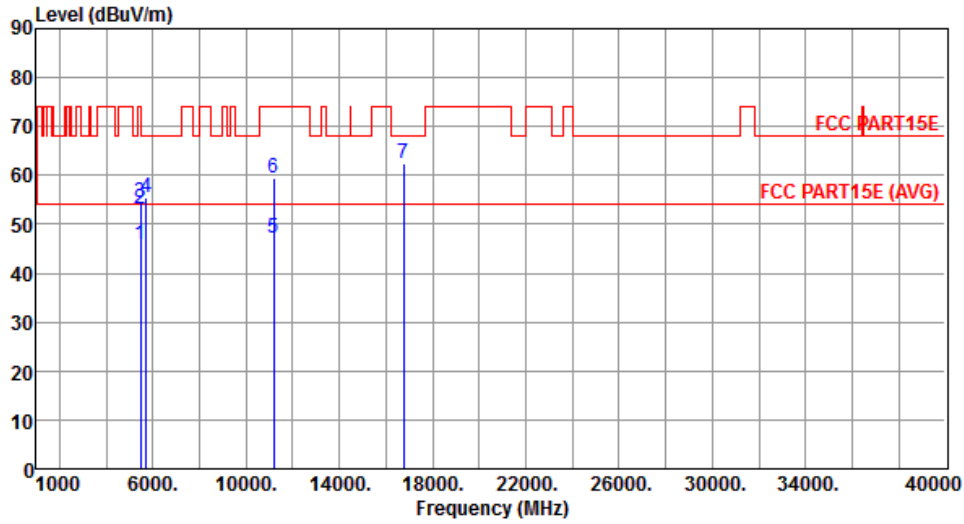

	Freq. MHz	Emission level dBuV/m	Limit dBuV/m	Margin dB	SA reading dBuV	Factor dB	Remark	ANT High cm	Turn Table deg
1	5460.00	45.87	54.00	-8.13	39.11	6.76	Average	160	211
2	5460.00	53.11	74.00	-20.89	46.35	6.76	Peak	160	211
3	5470.00	54.36	68.20	-13.84	47.59	6.77	Peak	160	211
4	5725.00	55.53	68.20	-12.67	48.29	7.24	Peak	160	211
5	11180.00	47.09	54.00	-6.91	30.30	16.79	Average	340	156
6	11180.00	59.61	74.00	-14.39	42.82	16.79	Peak	340	156
7	16770.00	62.31	68.20	-5.89	43.84	18.47	Peak	150	198

Note 1: Emission Level (dBuV/m) = SA Reading (dBuV/m) + Factor\* (dB)

\*Factor includes antenna factor , cable loss and amplifier gain

Note 2: Margin (dB) = Emission level (dBuV/m) – Limit (dBuV/m).

<b>Modulation</b>	HT40	<b>Test Freq. (MHz)</b>	5670
<b>Polarization</b>	Horizontal	<b>Test Configuration</b>	1

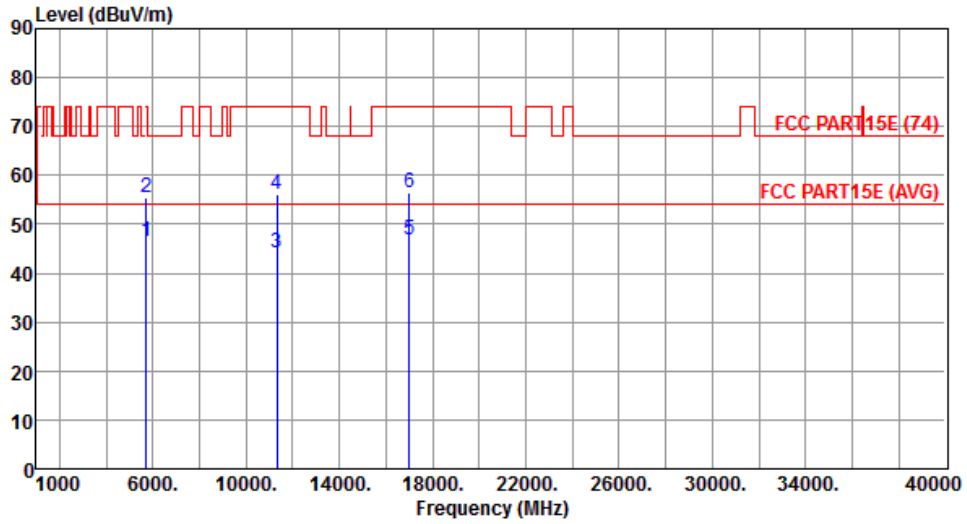

	Freq. MHz	Emission level dBuV/m	Limit dBuV/m	Margin dB	SA reading dBuV	Factor dB	Remark	ANT High cm	Turn Table deg
1	5725.00	46.44	54.00	-7.56	39.20	7.24	Average	150	114
2	5725.00	55.50	74.00	-18.50	48.26	7.24	Peak	150	114
3	11340.00	44.22	54.00	-9.78	27.37	16.85	Average	217	191
4	11340.00	56.12	74.00	-17.88	39.27	16.85	Peak	217	191
5	17010.00	46.88	54.00	-7.12	27.89	18.99	Average	154	100
6	17010.00	56.58	74.00	-17.42	37.59	18.99	Peak	154	100

Note 1: Emission Level (dBuV/m) = SA Reading (dBuV/m) + Factor\* (dB)

\*Factor includes antenna factor , cable loss and amplifier gain

Note 2: Margin (dB) = Emission level (dBuV/m) – Limit (dBuV/m).

<b>Modulation</b>	HT40	<b>Test Freq. (MHz)</b>	5670
<b>Polarization</b>	Vertical	<b>Test Configuration</b>	1

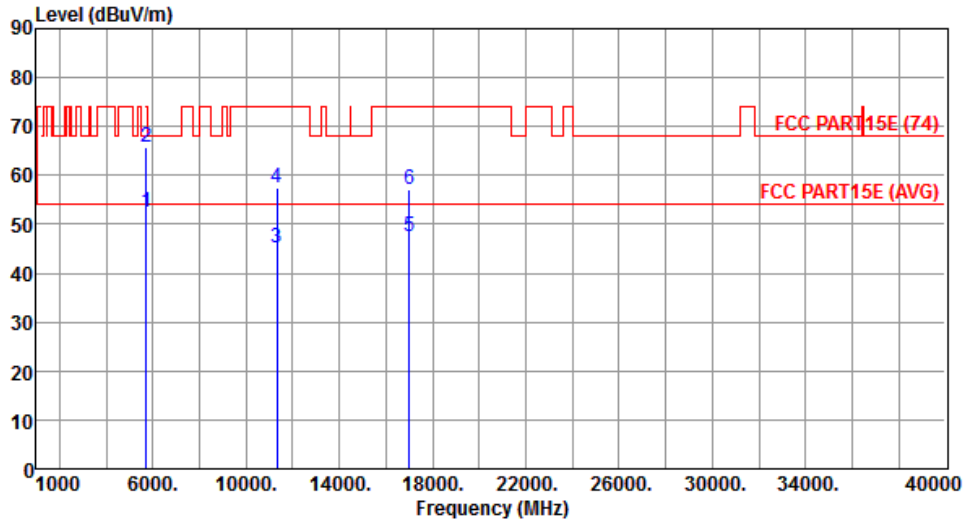

	Freq. MHz	Emission level dBuV/m	Limit dBuV/m	Margin dB	SA reading dBuV	Factor dB	Remark	ANT High cm	Turn Table deg
1	5725.00	52.53	54.00	-1.47	45.29	7.24	Average	150	206
2	5725.00	65.89	74.00	-8.11	58.65	7.24	Peak	150	206
3	11340.00	45.08	54.00	-8.92	28.23	16.85	Average	317	196
4	11340.00	57.49	74.00	-16.51	40.64	16.85	Peak	317	196
5	17010.00	47.49	54.00	-6.51	28.50	18.99	Average	150	190
6	17010.00	57.15	74.00	-16.85	38.16	18.99	Peak	150	190

Note 1: Emission Level (dBuV/m) = SA Reading (dBuV/m) + Factor\* (dB)

\*Factor includes antenna factor , cable loss and amplifier gain

Note 2: Margin (dB) = Emission level (dBuV/m) – Limit (dBuV/m).

<b>Modulation</b>	HT40	<b>Test Freq. (MHz)</b>	5755
<b>Polarization</b>	Horizontal	<b>Test Configuration</b>	1

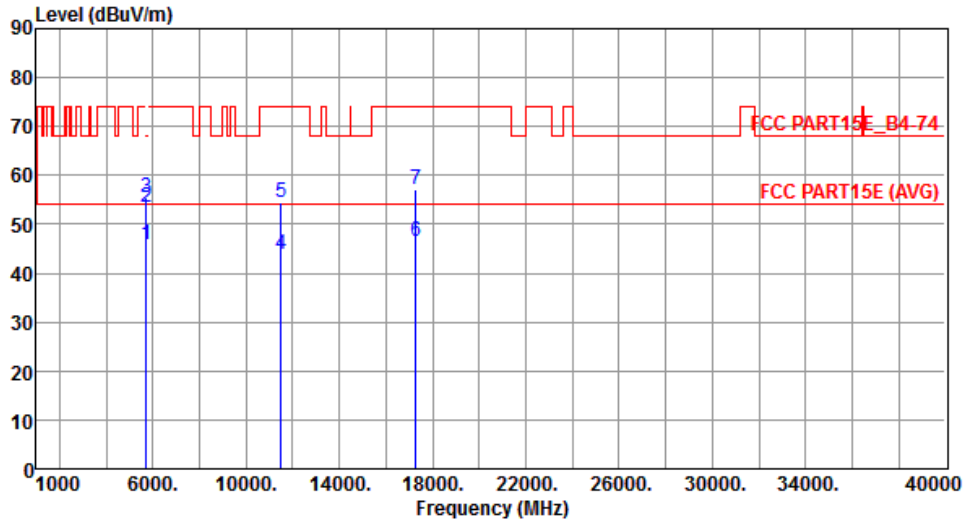

	Freq. MHz	Emission level dBuV/m	Limit dBuV/m	Margin dB	SA reading dBuV	Factor dB	Remark	ANT High cm	Turn Table deg
1	5715.00	45.91	54.00	-8.09	38.71	7.20	Average	156	116
2	5715.00	53.57	74.00	-20.43	46.37	7.20	Peak	156	116
3	5725.00	55.39	78.20	-22.81	48.15	7.24	Peak	156	116
4	11510.00	43.88	54.00	-10.12	26.98	16.90	Average	244	161
5	11510.00	54.39	74.00	-19.61	37.49	16.90	Peak	244	161
6	17265.00	46.36	54.00	-7.64	27.00	19.36	Average	244	161
7	17265.00	57.26	74.00	-16.74	37.90	19.36	Peak	244	161

Note 1: Emission Level (dBuV/m) = SA Reading (dBuV/m) + Factor\* (dB)

\*Factor includes antenna factor , cable loss and amplifier gain

Note 2: Margin (dB) = Emission level (dBuV/m) – Limit (dBuV/m).

<b>Modulation</b>	HT40	<b>Test Freq. (MHz)</b>	5755
<b>Polarization</b>	Vertical	<b>Test Configuration</b>	1

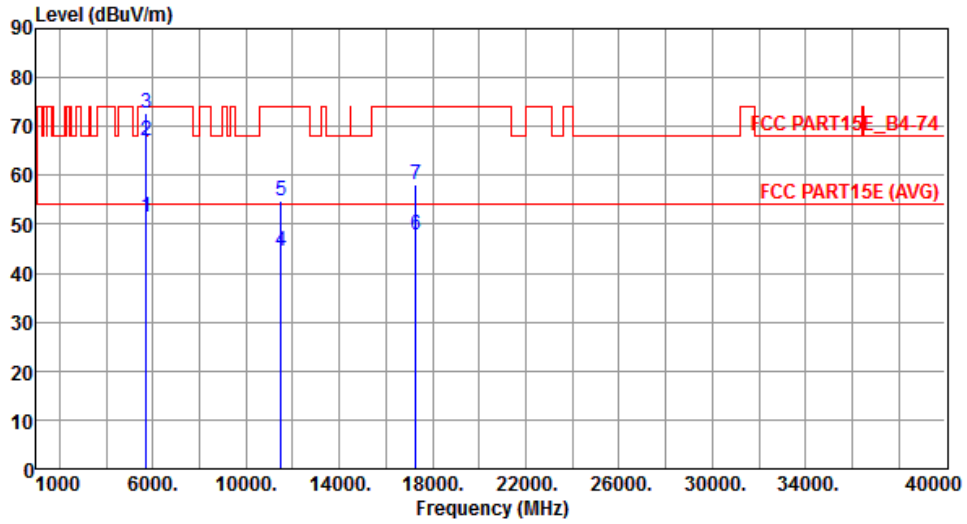

	Freq. MHz	Emission level dBuV/m	Limit dBuV/m	Margin dB	SA reading dBuV	Factor dB	Remark	ANT High cm	Turn Table deg
1	5715.00	51.45	54.00	-2.55	44.25	7.20	Average	150	208
2	5715.00	67.01	74.00	-6.99	59.81	7.20	Peak	150	208
3	5725.00	72.72	78.20	-5.48	65.48	7.24	Peak	150	208
4	11510.00	44.50	54.00	-9.50	27.60	16.90	Average	297	190
5	11510.00	54.90	74.00	-19.10	38.00	16.90	Peak	297	190
6	17265.00	47.66	54.00	-6.34	28.30	19.36	Average	160	200
7	17265.00	57.96	74.00	-16.04	38.60	19.36	Peak	160	200

Note 1: Emission Level (dBuV/m) = SA Reading (dBuV/m) + Factor\* (dB)

\*Factor includes antenna factor , cable loss and amplifier gain

Note 2: Margin (dB) = Emission level (dBuV/m) – Limit (dBuV/m).

<b>Modulation</b>	HT40	<b>Test Freq. (MHz)</b>	5795
<b>Polarization</b>	Horizontal	<b>Test Configuration</b>	1

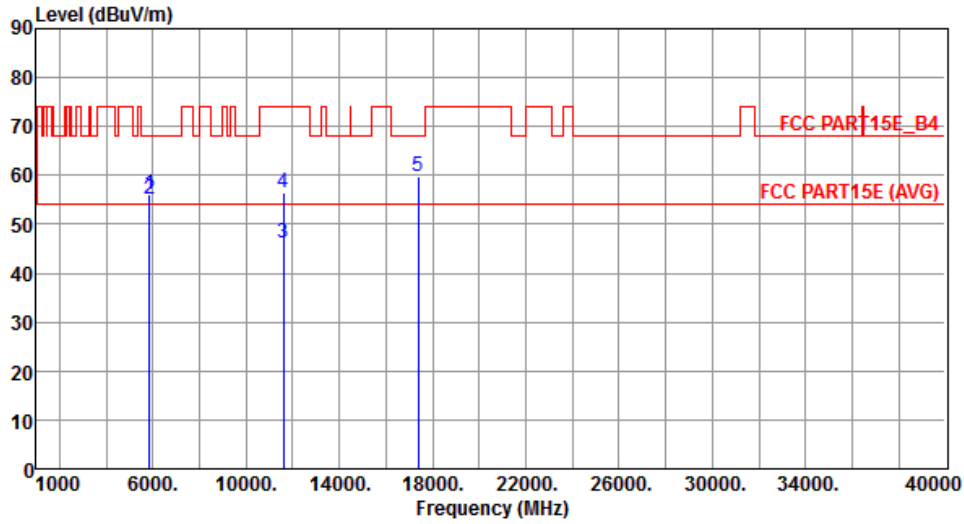

	Freq. MHz	Emission level dBuV/m	Limit dBuV/m	Margin dB	SA reading dBuV	Factor dB	Remark	ANT High cm	Turn Table deg
1	5850.00	56.14	78.20	-22.06	48.64	7.50	Peak	221	119
2	5860.00	55.11	68.20	-13.09	47.60	7.51	Peak	221	119
3	11590.00	46.12	54.00	-7.88	29.36	16.76	Average	199	267
4	11590.00	56.36	74.00	-17.64	39.60	16.76	Peak	199	267
5	17385.00	59.83	68.20	-8.37	40.29	19.54	Peak	233	129

Note 1: Emission Level (dBuV/m) = SA Reading (dBuV/m) + Factor\* (dB)

\*Factor includes antenna factor , cable loss and amplifier gain

Note 2: Margin (dB) = Emission level (dBuV/m) – Limit (dBuV/m).

<b>Modulation</b>	HT40	<b>Test Freq. (MHz)</b>	5795
<b>Polarization</b>	Vertical	<b>Test Configuration</b>	1

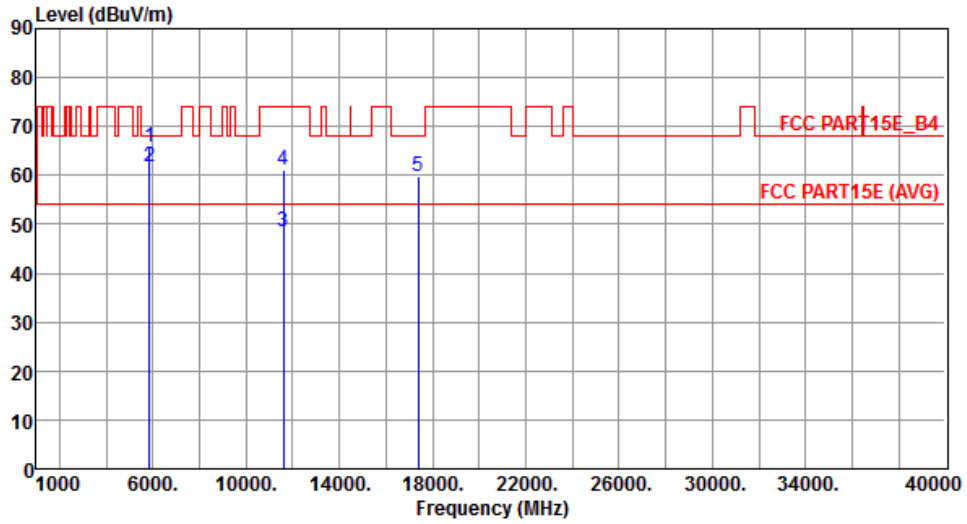

	Freq. MHz	Emission level dBuV/m	Limit dBuV/m	Margin dB	SA reading dBuV	Factor dB	Remark	ANT High cm	Turn Table deg
1	5850.00	65.82	78.20	-12.38	58.32	7.50	Peak	150	203
2	5860.00	61.65	68.20	-6.55	54.14	7.51	Peak	150	203
3	11590.00	48.36	54.00	-5.64	31.60	16.76	Average	296	175
4	11590.00	61.12	74.00	-12.88	44.36	16.76	Peak	296	175
5	17385.00	59.89	68.20	-8.31	40.35	19.54	Peak	150	198

Note 1: Emission Level (dBuV/m) = SA Reading (dBuV/m) + Factor\* (dB)

\*Factor includes antenna factor , cable loss and amplifier gain

Note 2: Margin (dB) = Emission level (dBuV/m) – Limit (dBuV/m).

## Test Configuration 2: PCB Dipole antenna

### 3.5.8 Transmitter Radiated Unwanted Emissions (Below 1GHz)

<b>Modulation</b>	HT40	<b>Test Freq. (MHz)</b>	5590
<b>Polarization</b>	Horizontal	<b>Test Configuration</b>	2

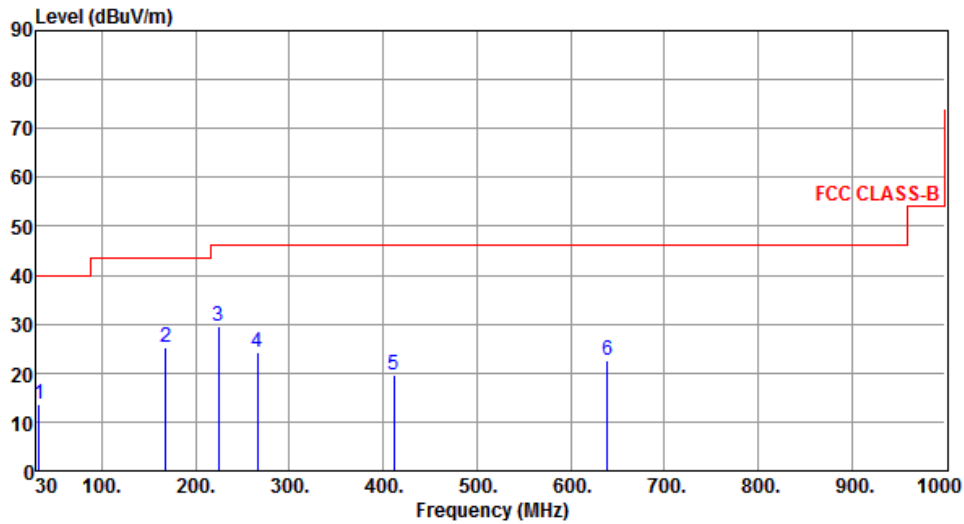

	Freq. MHz	Emission level dBuV/m	Limit dBuV/m	Margin dB	SA reading dBuV	Factor dB	Remark	ANT High cm	Turn Table deg
1	32.91	13.76	40.00	-26.24	27.26	-13.50	Peak	---	---
2	167.74	25.20	43.50	-18.30	39.19	-13.99	Peak	---	---
3	224.00	29.45	46.00	-16.55	45.17	-15.72	Peak	---	---
4	265.71	24.20	46.00	-21.80	38.30	-14.10	Peak	---	---
5	411.21	19.59	46.00	-26.41	29.34	-9.75	Peak	---	---
6	639.16	22.50	46.00	-23.50	27.73	-5.23	Peak	---	---

Note 1: Emission Level (dBuV/m) = SA Reading (dBuV/m) + Factor\* (dB)

\*Factor includes antenna factor, cable loss and amplifier gain

Note 2: Margin (dB) = Emission level (dBuV/m) – Limit (dBuV/m).

Note 3: All spurious emissions below 30MHz are more than 20 dB below the limit.



<b>Modulation</b>	HT40	<b>Test Freq. (MHz)</b>	5590
<b>Polarization</b>	Vertical	<b>Test Configuration</b>	2

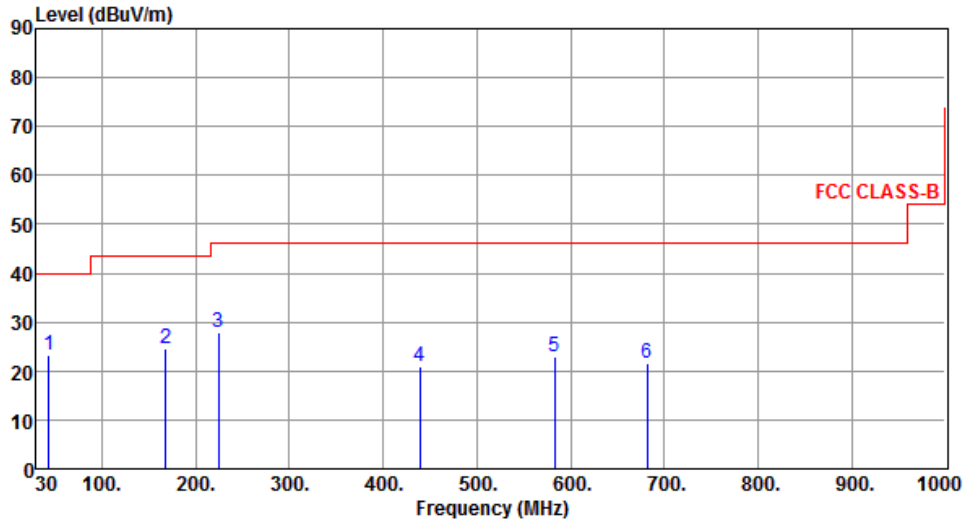

	Freq. MHz	Emission level dBuV/m	Limit dBuV/m	Margin dB	SA reading dBuV	Factor dB	Remark	ANT High cm	Turn Table deg
1	43.58	23.15	40.00	-16.85	36.07	-12.92	Peak	---	---
2	167.74	24.71	43.50	-18.79	38.70	-13.99	Peak	---	---
3	224.00	28.02	46.00	-17.98	43.74	-15.72	Peak	---	---
4	439.34	20.87	46.00	-25.13	29.92	-9.05	Peak	---	---
5	582.90	22.82	46.00	-23.18	29.07	-6.25	Peak	---	---
6	681.84	21.69	46.00	-24.31	26.35	-4.66	Peak	---	---

Note 1: Emission Level (dBuV/m) = SA Reading (dBuV/m) + Factor\* (dB)

\*Factor includes antenna factor , cable loss and amplifier gain

Note 2: Margin (dB) = Emission level (dBuV/m) – Limit (dBuV/m).

Note 3: All spurious emissions below 30MHz are more than 20 dB below the limit.

<b>Modulation</b>	11a	<b>Test Freq. (MHz)</b>	5785
<b>Polarization</b>	Horizontal	<b>Test Configuration</b>	2

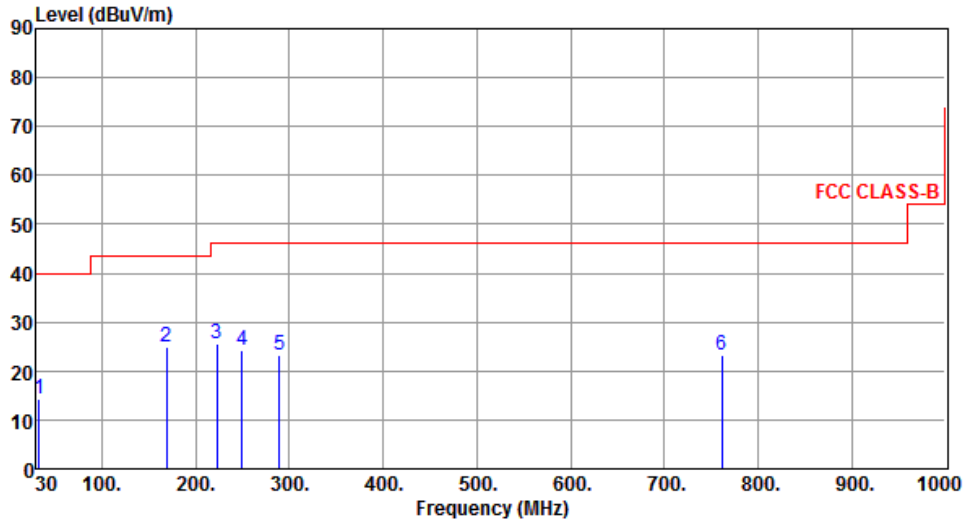

	Freq. MHz	Emission level dBuV/m	Limit dBuV/m	Margin dB	SA reading dBuV	Factor dB	Remark	ANT High cm	Turn Table deg
1	32.91	14.18	40.00	-25.82	27.68	-13.50	Peak	---	---
2	168.71	24.96	43.50	-18.54	38.99	-14.03	Peak	---	---
3	223.03	25.47	46.00	-20.53	41.25	-15.78	Peak	---	---
4	249.22	24.39	46.00	-21.61	39.13	-14.74	Peak	---	---
5	288.99	23.24	46.00	-22.76	36.40	-13.16	Peak	---	---
6	761.38	23.10	46.00	-22.90	26.24	-3.14	Peak	---	---

Note 1: Emission Level (dBuV/m) = SA Reading (dBuV/m) + Factor\* (dB)

\*Factor includes antenna factor , cable loss and amplifier gain

Note 2: Margin (dB) = Emission level (dBuV/m) – Limit (dBuV/m).

Note 3: All spurious emissions below 30MHz are more than 20 dB below the limit.

<b>Modulation</b>	11a	<b>Test Freq. (MHz)</b>	5785
<b>Polarization</b>	Vertical	<b>Test Configuration</b>	2

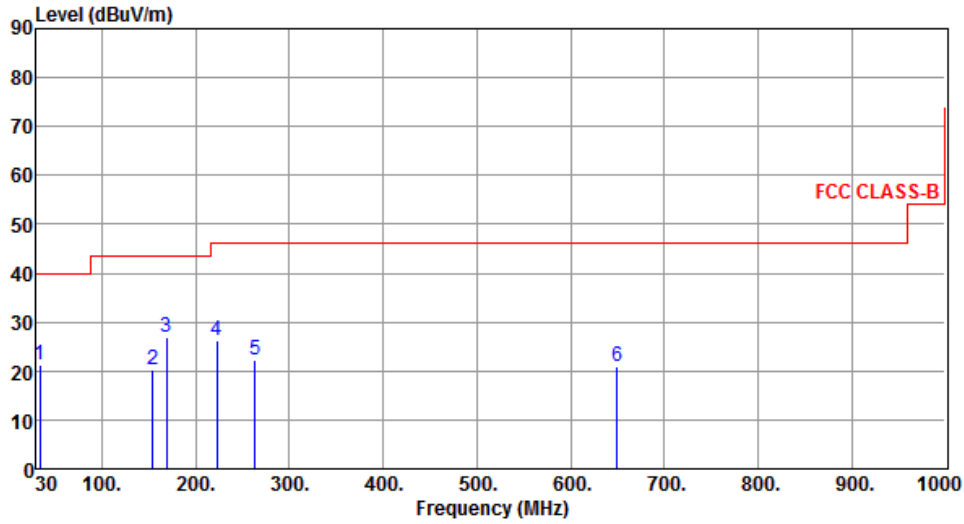

	Freq. MHz	Emission level dBuV/m	Limit dBuV/m	Margin dB	SA reading dBuV	Factor dB	Remark	ANT High cm	Turn Table deg
1	33.88	21.36	40.00	-18.64	34.85	-13.49	Peak	---	---
2	154.16	20.38	43.50	-23.12	33.89	-13.51	Peak	---	---
3	168.71	27.01	43.50	-16.49	41.04	-14.03	Peak	---	---
4	223.03	26.27	46.00	-19.73	42.05	-15.78	Peak	---	---
5	263.77	22.39	46.00	-23.61	36.60	-14.21	Peak	---	---
6	649.83	21.07	46.00	-24.93	26.13	-5.06	Peak	---	---

Note 1: Emission Level (dBuV/m) = SA Reading (dBuV/m) + Factor\* (dB)

\*Factor includes antenna factor , cable loss and amplifier gain

Note 2: Margin (dB) = Emission level (dBuV/m) – Limit (dBuV/m).

Note 3: All spurious emissions below 30MHz are more than 20 dB below the limit.

### 3.5.9 Transmitter Radiated Unwanted Emissions (Above 1GHz) for 11a

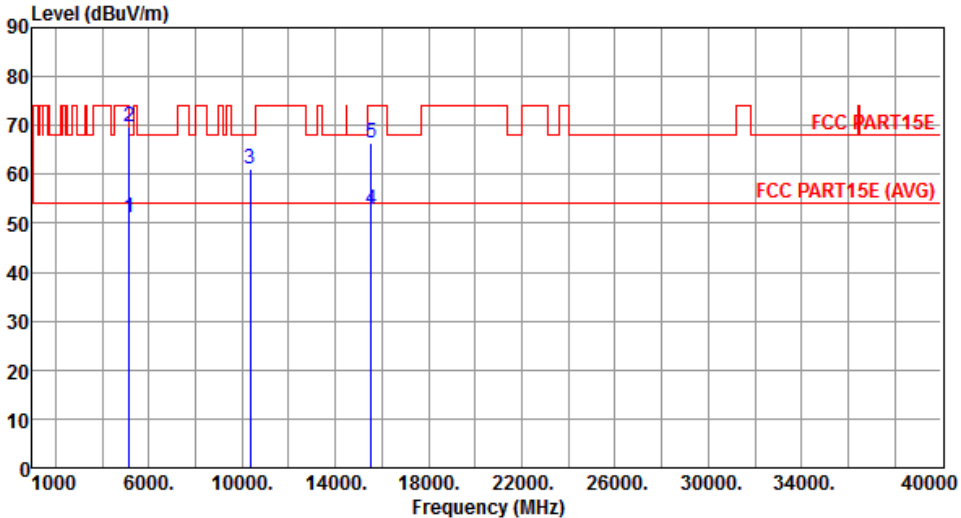
Modulation	11a	Test Freq. (MHz)	5180																																																																					
Polarization	Horizontal	Test Configuration	2																																																																					
																																																																								
	<table border="1"> <thead> <tr> <th>Freq.</th> <th>Emission level</th> <th>Limit</th> <th>Margin</th> <th>SA reading</th> <th>Factor</th> <th>Remark</th> <th>ANT High</th> <th>Turn Table</th> </tr> <tr> <th>MHz</th> <th>dBuV/m</th> <th>dBuV/m</th> <th>dB</th> <th>dBuV</th> <th>dB</th> <th></th> <th>cm</th> <th>deg</th> </tr> </thead> <tbody> <tr> <td>1</td> <td>5150.00</td> <td>51.26</td> <td>54.00</td> <td>-2.74</td> <td>44.95</td> <td>6.31</td> <td>Average</td> <td>162</td> <td>358</td> </tr> <tr> <td>2</td> <td>5150.00</td> <td>69.61</td> <td>74.00</td> <td>-4.39</td> <td>63.30</td> <td>6.31</td> <td>Peak</td> <td>162</td> <td>358</td> </tr> <tr> <td>3</td> <td>10360.00</td> <td>61.19</td> <td>68.20</td> <td>-7.01</td> <td>44.85</td> <td>16.34</td> <td>Peak</td> <td>251</td> <td>242</td> </tr> <tr> <td>4</td> <td>15540.00</td> <td>52.75</td> <td>54.00</td> <td>-1.25</td> <td>35.25</td> <td>17.50</td> <td>Average</td> <td>227</td> <td>123</td> </tr> <tr> <td>5</td> <td>15540.00</td> <td>66.36</td> <td>74.00</td> <td>-7.64</td> <td>48.86</td> <td>17.50</td> <td>Peak</td> <td>227</td> <td>123</td> </tr> </tbody> </table>	Freq.	Emission level	Limit	Margin	SA reading	Factor	Remark	ANT High	Turn Table	MHz	dBuV/m	dBuV/m	dB	dBuV	dB		cm	deg	1	5150.00	51.26	54.00	-2.74	44.95	6.31	Average	162	358	2	5150.00	69.61	74.00	-4.39	63.30	6.31	Peak	162	358	3	10360.00	61.19	68.20	-7.01	44.85	16.34	Peak	251	242	4	15540.00	52.75	54.00	-1.25	35.25	17.50	Average	227	123	5	15540.00	66.36	74.00	-7.64	48.86	17.50	Peak	227	123			
Freq.	Emission level	Limit	Margin	SA reading	Factor	Remark	ANT High	Turn Table																																																																
MHz	dBuV/m	dBuV/m	dB	dBuV	dB		cm	deg																																																																
1	5150.00	51.26	54.00	-2.74	44.95	6.31	Average	162	358																																																															
2	5150.00	69.61	74.00	-4.39	63.30	6.31	Peak	162	358																																																															
3	10360.00	61.19	68.20	-7.01	44.85	16.34	Peak	251	242																																																															
4	15540.00	52.75	54.00	-1.25	35.25	17.50	Average	227	123																																																															
5	15540.00	66.36	74.00	-7.64	48.86	17.50	Peak	227	123																																																															
<p>Note 1: Emission Level (dBuV/m) = SA Reading (dBuV/m) + Factor* (dB)            *Factor includes antenna factor , cable loss and amplifier gain            Note 2: Margin (dB) = Emission level (dBuV/m) – Limit (dBuV/m).</p>																																																																								

<b>Modulation</b>	11a	<b>Test Freq. (MHz)</b>	5180
<b>Polarization</b>	Vertical	<b>Test Configuration</b>	2

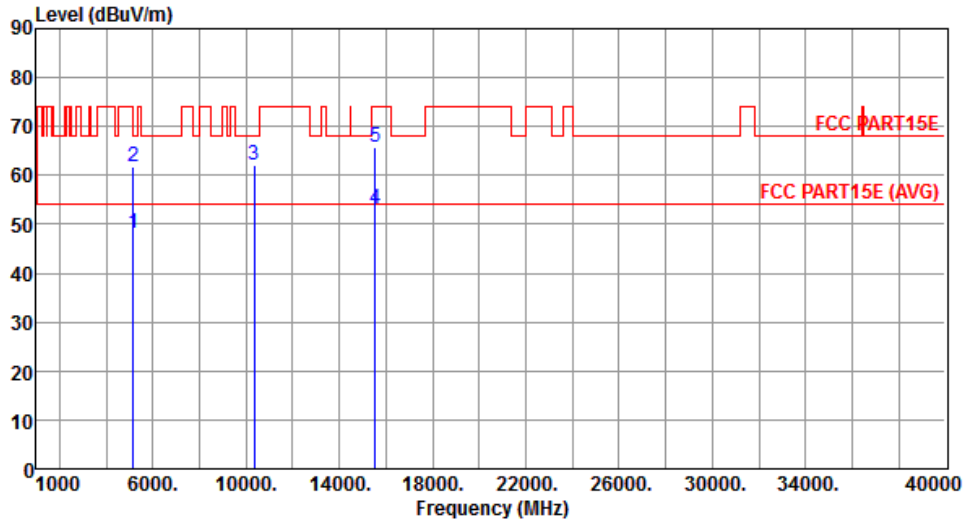

	Freq. MHz	Emission level dBuV/m	Limit dBuV/m	Margin dB	SA reading dBuV	Factor dB	Remark	ANT High cm	Turn Table deg
1	5150.00	48.00	54.00	-6.00	41.69	6.31	Average	162	338
2	5150.00	61.69	74.00	-12.31	55.38	6.31	Peak	162	338
3	10360.00	62.22	68.20	-5.98	45.88	16.34	Peak	360	181
4	15540.00	53.02	54.00	-0.98	35.52	17.50	Average	374	288
5	15540.00	65.73	74.00	-8.27	48.23	17.50	Peak	374	288

Note 1: Emission Level (dBuV/m) = SA Reading (dBuV/m) + Factor\* (dB)

\*Factor includes antenna factor , cable loss and amplifier gain

Note 2: Margin (dB) = Emission level (dBuV/m) – Limit (dBuV/m).

<b>Modulation</b>	11a	<b>Test Freq. (MHz)</b>	5200
<b>Polarization</b>	Horizontal	<b>Test Configuration</b>	2

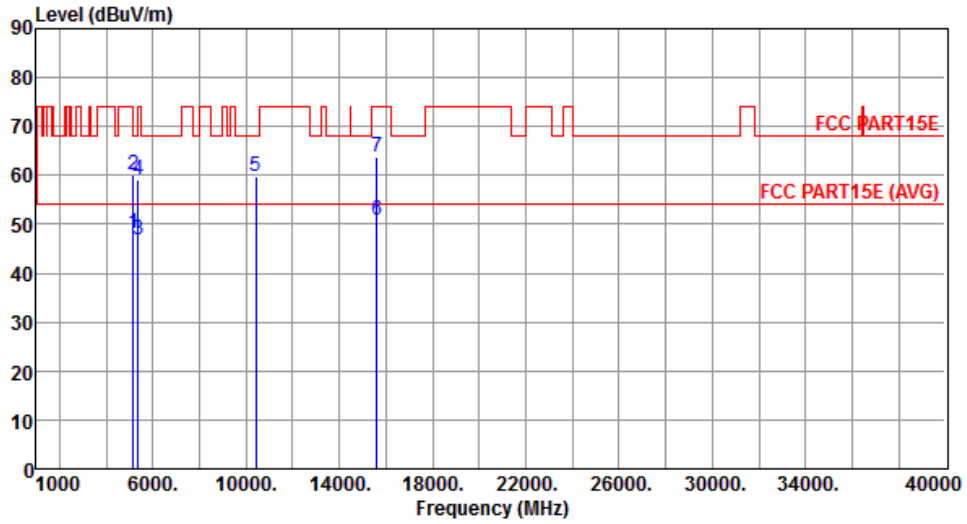

	Freq. MHz	Emission level dBuV/m	Limit dBuV/m	Margin dB	SA reading dBuV	Factor dB	Remark	ANT High cm	Turn Table deg
1	5150.00	48.04	54.00	-5.96	41.73	6.31	Average	151	5
2	5150.00	60.01	74.00	-13.99	53.70	6.31	Peak	151	5
3	5350.00	46.95	54.00	-7.05	40.33	6.62	Average	151	5
4	5350.00	59.26	74.00	-14.74	52.64	6.62	Peak	151	5
5	10400.00	59.79	68.20	-8.41	43.37	16.42	Peak	150	340
6	15600.00	50.90	54.00	-3.10	33.52	17.38	Average	197	304
7	15600.00	63.78	74.00	-10.22	46.40	17.38	Peak	197	304

Note 1: Emission Level (dBuV/m) = SA Reading (dBuV/m) + Factor\* (dB)

\*Factor includes antenna factor , cable loss and amplifier gain

Note 2: Margin (dB) = Emission level (dBuV/m) – Limit (dBuV/m).

<b>Modulation</b>	11a	<b>Test Freq. (MHz)</b>	5200
<b>Polarization</b>	Vertical	<b>Test Configuration</b>	2

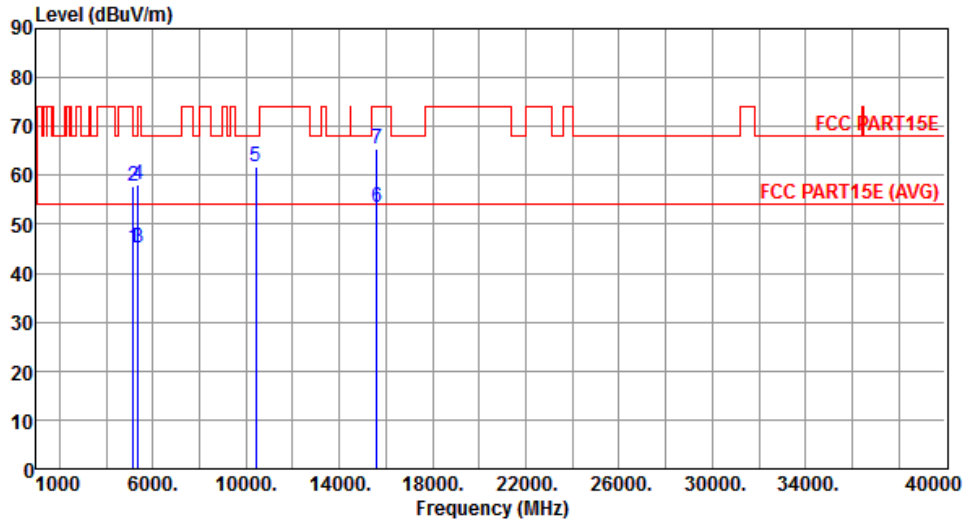

	Freq. MHz	Emission level dBuV/m	Limit dBuV/m	Margin dB	SA reading dBuV	Factor dB	Remark	ANT High cm	Turn Table deg
1	5150.00	45.00	54.00	-9.00	38.69	6.31	Average	165	331
2	5150.00	57.69	74.00	-16.31	51.38	6.31	Peak	165	331
3	5350.00	45.14	54.00	-8.86	38.52	6.62	Average	165	331
4	5350.00	58.26	74.00	-15.74	51.64	6.62	Peak	165	331
5	10400.00	61.65	68.20	-6.55	45.23	16.42	Peak	150	6
6	15600.00	53.48	54.00	-0.52	36.10	17.38	Average	150	24
7	15600.00	65.58	74.00	-8.42	48.20	17.38	Peak	150	24

Note 1: Emission Level (dBuV/m) = SA Reading (dBuV/m) + Factor\* (dB)

\*Factor includes antenna factor , cable loss and amplifier gain

Note 2: Margin (dB) = Emission level (dBuV/m) – Limit (dBuV/m).

<b>Modulation</b>	11a	<b>Test Freq. (MHz)</b>	5240
<b>Polarization</b>	Horizontal	<b>Test Configuration</b>	2

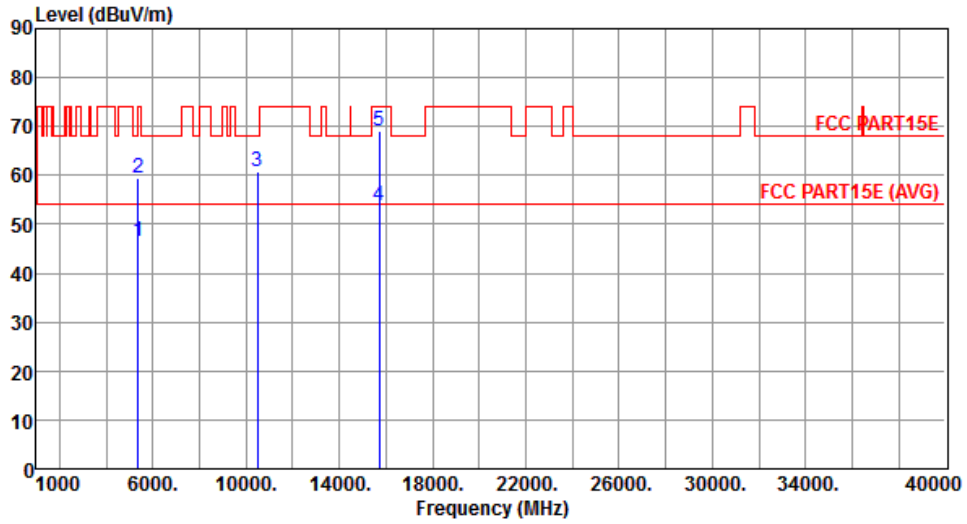

	Freq. MHz	Emission level dBuV/m	Limit dBuV/m	Margin dB	SA reading dBuV	Factor dB	Remark	ANT High cm	Turn Table deg
1	5350.00	46.48	54.00	-7.52	39.86	6.62	Average	154	3
2	5350.00	59.58	74.00	-14.42	52.96	6.62	Peak	154	3
3	10480.00	60.74	68.20	-7.46	44.18	16.56	Peak	156	156
4	15720.00	53.71	54.00	-0.29	36.56	17.15	Average	150	198
5	15720.00	68.98	74.00	-5.02	51.83	17.15	Peak	150	198

Note 1: Emission Level (dBuV/m) = SA Reading (dBuV/m) + Factor\* (dB)

\*Factor includes antenna factor , cable loss and amplifier gain

Note 2: Margin (dB) = Emission level (dBuV/m) – Limit (dBuV/m).



<b>Modulation</b>	11a	<b>Test Freq. (MHz)</b>	5240
<b>Polarization</b>	Vertical	<b>Test Configuration</b>	2

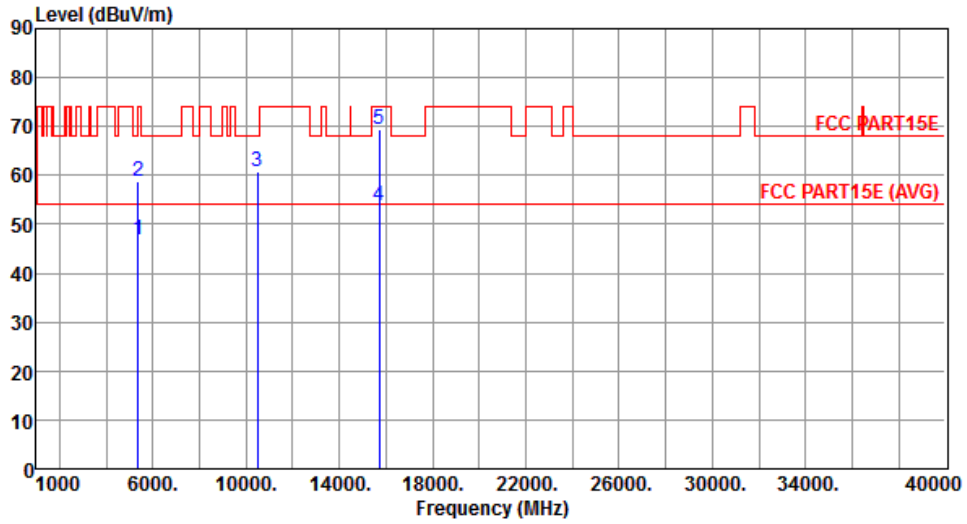

	Freq. MHz	Emission level dBuV/m	Limit dBuV/m	Margin dB	SA reading dBuV	Factor dB	Remark	ANT High cm	Turn Table deg
1	5350.00	46.84	54.00	-7.16	40.22	6.62	Average	169	334
2	5350.00	58.83	74.00	-15.17	52.21	6.62	Peak	169	334
3	10480.00	60.64	68.20	-7.56	44.08	16.56	Peak	150	181
4	15720.00	53.78	54.00	-0.22	36.63	17.15	Average	151	190
5	15720.00	69.27	74.00	-4.73	52.12	17.15	Peak	151	190

Note 1: Emission Level (dBuV/m) = SA Reading (dBuV/m) + Factor\* (dB)

\*Factor includes antenna factor , cable loss and amplifier gain

Note 2: Margin (dB) = Emission level (dBuV/m) – Limit (dBuV/m).

<b>Modulation</b>	11a	<b>Test Freq. (MHz)</b>	5260
<b>Polarization</b>	Horizontal	<b>Test Configuration</b>	2

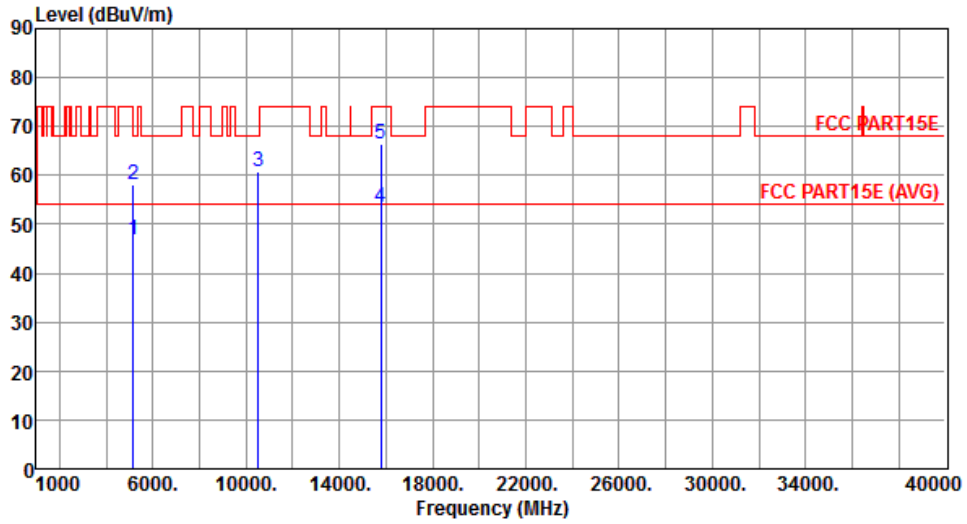

	Freq. MHz	Emission level dBuV/m	Limit dBuV/m	Margin dB	SA reading dBuV	Factor dB	Remark	ANT High cm	Turn Table deg
1	5150.00	46.94	54.00	-7.06	40.63	6.31	Average	150	4
2	5150.00	58.02	74.00	-15.98	51.71	6.31	Peak	150	4
3	10520.00	60.72	68.20	-7.48	44.12	16.60	Peak	269	245
4	15780.00	53.47	54.00	-0.53	36.42	17.05	Average	201	141
5	15780.00	66.39	74.00	-7.61	49.34	17.05	Peak	201	141

Note 1: Emission Level (dBuV/m) = SA Reading (dBuV/m) + Factor\* (dB)

\*Factor includes antenna factor , cable loss and amplifier gain

Note 2: Margin (dB) = Emission level (dBuV/m) – Limit (dBuV/m).

<b>Modulation</b>	11a	<b>Test Freq. (MHz)</b>	5260
<b>Polarization</b>	Vertical	<b>Test Configuration</b>	2

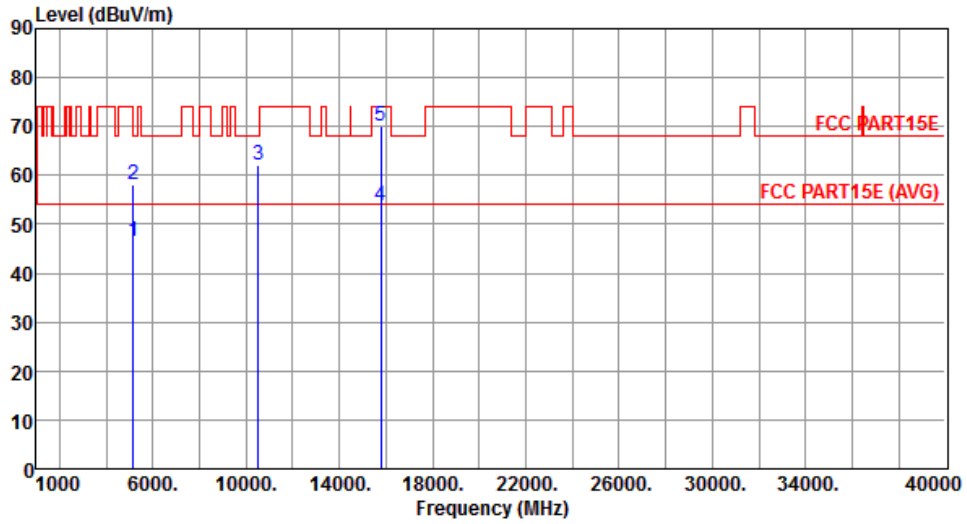

	Freq. MHz	Emission level dBuV/m	Limit dBuV/m	Margin dB	SA reading dBuV	Factor dB	Remark	ANT High cm	Turn Table deg
1	5150.00	46.54	54.00	-7.46	40.23	6.31	Average	154	324
2	5150.00	57.98	74.00	-16.02	51.67	6.31	Peak	154	324
3	10520.00	62.04	68.20	-6.16	45.44	16.60	Peak	272	188
4	15780.00	53.72	54.00	-0.28	36.67	17.05	Average	150	188
5	15780.00	70.11	74.00	-3.89	53.06	17.05	Peak	150	188

Note 1: Emission Level (dBuV/m) = SA Reading (dBuV/m) + Factor\* (dB)

\*Factor includes antenna factor , cable loss and amplifier gain

Note 2: Margin (dB) = Emission level (dBuV/m) – Limit (dBuV/m).

<b>Modulation</b>	11a	<b>Test Freq. (MHz)</b>	5300
<b>Polarization</b>	Horizontal	<b>Test Configuration</b>	2

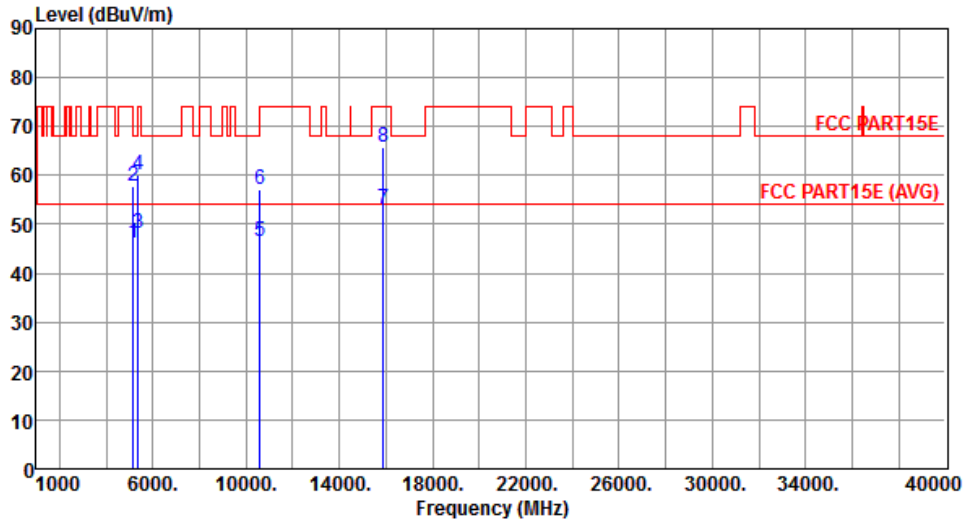

	Freq. MHz	Emission level dBuV/m	Limit dBuV/m	Margin dB	SA reading dBuV	Factor dB	Remark	ANT High cm	Turn Table deg
1	5150.00	46.11	54.00	-7.89	39.80	6.31	Average	150	2
2	5150.00	57.76	74.00	-16.24	51.45	6.31	Peak	150	2
3	5350.00	48.19	54.00	-5.81	41.57	6.62	Average	150	2
4	5350.00	59.97	74.00	-14.03	53.35	6.62	Peak	150	2
5	10600.00	46.39	54.00	-7.61	29.77	16.62	Average	150	340
6	10600.00	57.26	74.00	-16.74	40.64	16.62	Peak	150	340
7	15900.00	53.08	54.00	-0.92	36.26	16.82	Average	150	20
8	15900.00	65.59	74.00	-8.41	48.77	16.82	Peak	150	20

Note 1: Emission Level (dBuV/m) = SA Reading (dBuV/m) + Factor\* (dB)

\*Factor includes antenna factor , cable loss and amplifier gain

Note 2: Margin (dB) = Emission level (dBuV/m) – Limit (dBuV/m).

<b>Modulation</b>	11a	<b>Test Freq. (MHz)</b>	5300
<b>Polarization</b>	Vertical	<b>Test Configuration</b>	2

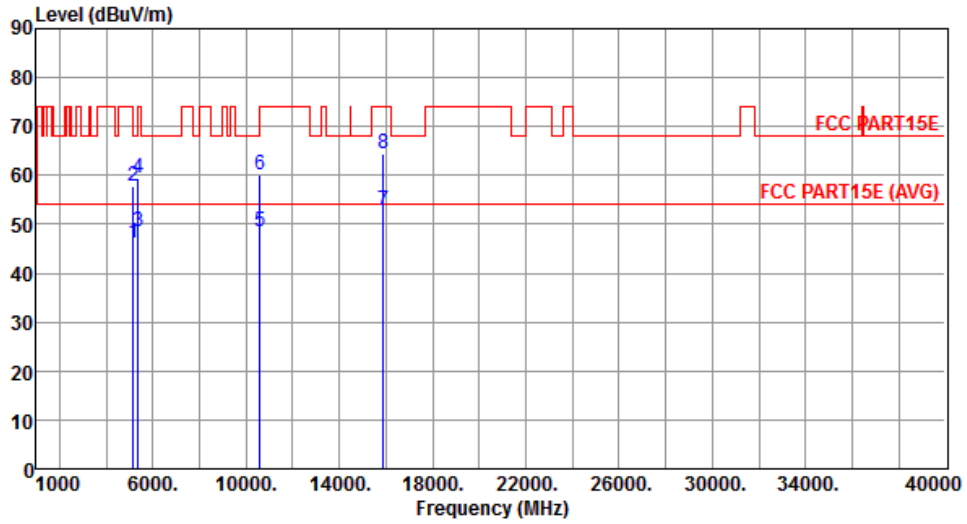

	Freq. MHz	Emission level dBuV/m	Limit dBuV/m	Margin dB	SA reading dBuV	Factor dB	Remark	ANT High cm	Turn Table deg
1	5150.00	46.15	54.00	-7.85	39.84	6.31	Average	152	331
2	5150.00	57.81	74.00	-16.19	51.50	6.31	Peak	152	331
3	5350.00	48.60	54.00	-5.40	41.98	6.62	Average	152	331
4	5350.00	59.31	74.00	-14.69	52.69	6.62	Peak	152	331
5	10600.00	48.60	54.00	-5.40	31.98	16.62	Average	150	6
6	10600.00	60.01	74.00	-13.99	43.39	16.62	Peak	150	6
7	15900.00	52.65	54.00	-1.35	35.83	16.82	Average	326	57
8	15900.00	64.31	74.00	-9.69	47.49	16.82	Peak	326	57

Note 1: Emission Level (dBuV/m) = SA Reading (dBuV/m) + Factor\* (dB)

\*Factor includes antenna factor , cable loss and amplifier gain

Note 2: Margin (dB) = Emission level (dBuV/m) – Limit (dBuV/m).

<b>Modulation</b>	11a	<b>Test Freq. (MHz)</b>	5320
<b>Polarization</b>	Horizontal	<b>Test Configuration</b>	2

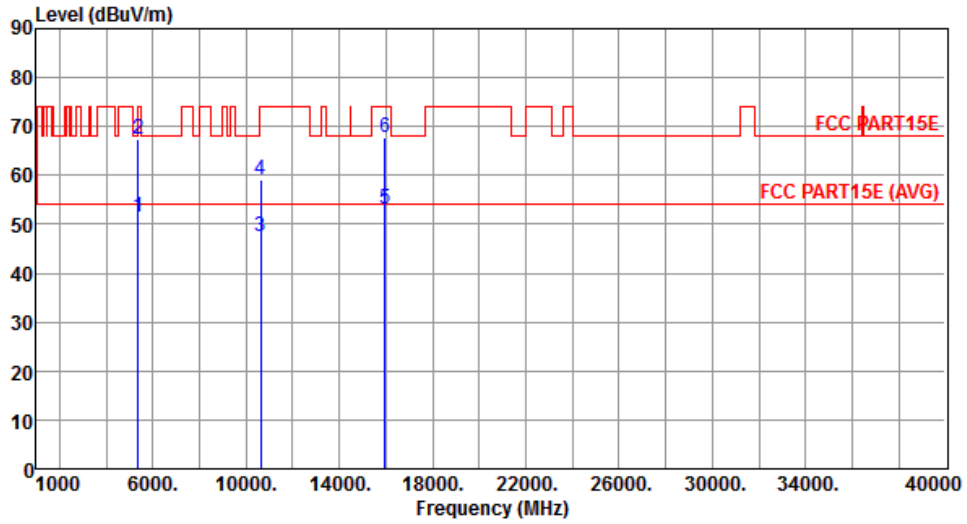

	Freq. MHz	Emission level dBuV/m	Limit dBuV/m	Margin dB	SA reading dBuV	Factor dB	Remark	ANT High cm	Turn Table deg
1	5350.00	51.39	54.00	-2.61	44.77	6.62	Average	150	8
2	5350.00	67.48	74.00	-6.52	60.86	6.62	Peak	150	8
3	10640.00	47.36	54.00	-6.64	30.73	16.63	Average	150	190
4	10640.00	59.21	74.00	-14.79	42.58	16.63	Peak	150	190
5	15960.00	53.23	54.00	-0.77	36.53	16.70	Average	150	143
6	15960.00	67.79	74.00	-6.21	51.09	16.70	Peak	150	143

Note 1: Emission Level (dBuV/m) = SA Reading (dBuV/m) + Factor\* (dB)

\*Factor includes antenna factor , cable loss and amplifier gain

Note 2: Margin (dB) = Emission level (dBuV/m) – Limit (dBuV/m).

<b>Modulation</b>	11a	<b>Test Freq. (MHz)</b>	5320
<b>Polarization</b>	Vertical	<b>Test Configuration</b>	2

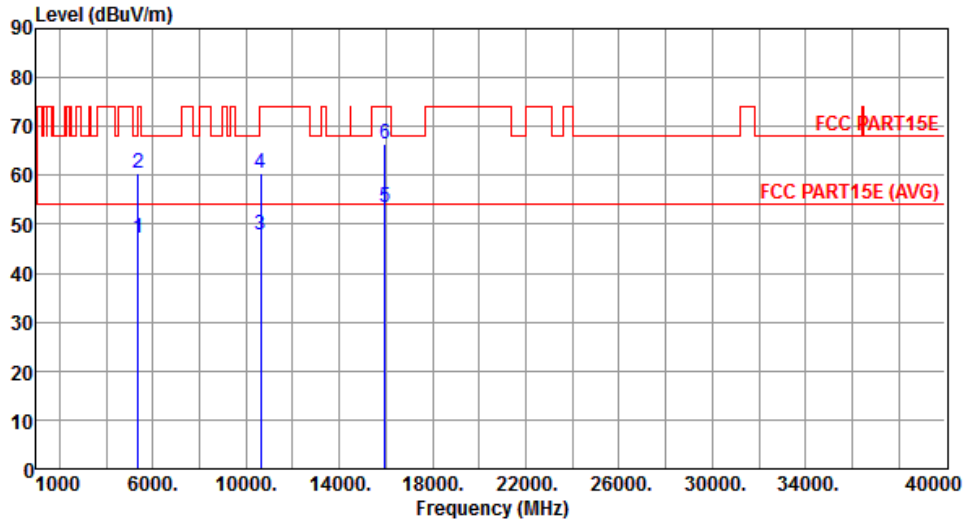

	Freq. MHz	Emission level dBuV/m	Limit dBuV/m	Margin dB	SA reading dBuV	Factor dB	Remark	ANT High cm	Turn Table deg
1	5350.00	47.16	54.00	-6.84	40.54	6.62	Average	150	337
2	5350.00	60.32	74.00	-13.68	53.70	6.62	Peak	150	337
3	10640.00	47.75	54.00	-6.25	31.12	16.63	Average	150	179
4	10640.00	60.36	74.00	-13.64	43.73	16.63	Peak	150	179
5	15960.00	53.62	54.00	-0.38	36.92	16.70	Average	150	185
6	15960.00	66.48	74.00	-7.52	49.78	16.70	Peak	150	185

Note 1: Emission Level (dBuV/m) = SA Reading (dBuV/m) + Factor\* (dB)

\*Factor includes antenna factor , cable loss and amplifier gain

Note 2: Margin (dB) = Emission level (dBuV/m) – Limit (dBuV/m).

<b>Modulation</b>	11a	<b>Test Freq. (MHz)</b>	5500
<b>Polarization</b>	Horizontal	<b>Test Configuration</b>	2

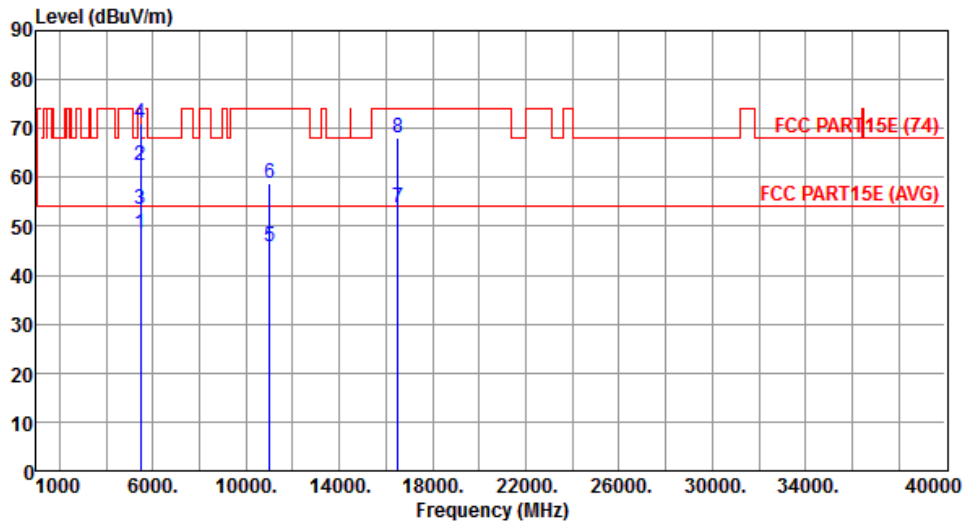

	Freq. MHz	Emission level dBuV/m	Limit dBuV/m	Margin dB	SA reading dBuV	Factor dB	Remark	ANT High cm	Turn Table deg
1	5460.00	48.55	54.00	-5.45	41.79	6.76	Average	150	1
2	5460.00	62.31	74.00	-11.69	55.55	6.76	Peak	150	1
3	5470.00	53.36	54.00	-0.64	46.59	6.77	Average	150	1
4	5470.00	71.14	74.00	-2.86	64.37	6.77	Peak	150	1
5	11000.00	45.82	54.00	-8.18	29.10	16.72	Average	150	206
6	11000.00	58.69	74.00	-15.31	41.97	16.72	Peak	150	206
7	16500.00	53.75	54.00	-0.25	35.88	17.87	Average	150	136
8	16500.00	68.06	74.00	-5.94	50.19	17.87	Peak	150	136

Note 1: Emission Level (dBuV/m) = SA Reading (dBuV/m) + Factor\* (dB)

\*Factor includes antenna factor , cable loss and amplifier gain

Note 2: Margin (dB) = Emission level (dBuV/m) – Limit (dBuV/m).



<b>Modulation</b>	11a	<b>Test Freq. (MHz)</b>	5500
<b>Polarization</b>	Vertical	<b>Test Configuration</b>	2

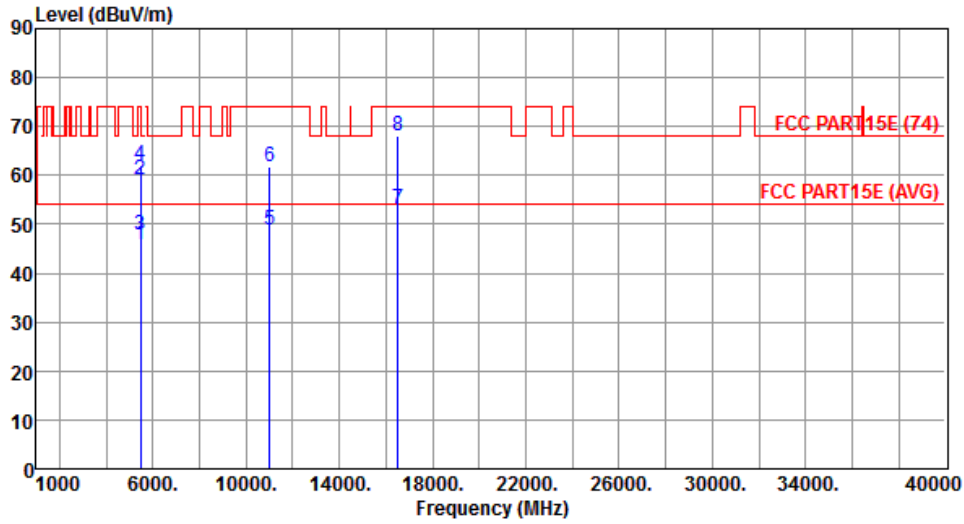

	Freq. MHz	Emission level dBuV/m	Limit dBuV/m	Margin dB	SA reading dBuV	Factor dB	Remark	ANT High cm	Turn Table deg
1	5460.00	45.68	54.00	-8.32	38.92	6.76	Average	150	343
2	5460.00	58.97	74.00	-15.03	52.21	6.76	Peak	150	343
3	5470.00	47.75	54.00	-6.25	40.98	6.77	Average	150	343
4	5470.00	61.94	74.00	-12.06	55.17	6.77	Peak	150	343
5	11000.00	48.80	54.00	-5.20	32.08	16.72	Average	150	183
6	11000.00	61.71	74.00	-12.29	44.99	16.72	Peak	150	183
7	16500.00	53.20	54.00	-0.80	35.33	17.87	Average	150	183
8	16500.00	68.20	74.00	-5.80	50.33	17.87	Peak	150	183

Note 1: Emission Level (dBuV/m) = SA Reading (dBuV/m) + Factor\* (dB)

\*Factor includes antenna factor , cable loss and amplifier gain

Note 2: Margin (dB) = Emission level (dBuV/m) – Limit (dBuV/m).

<b>Modulation</b>	11a	<b>Test Freq. (MHz)</b>	5580
<b>Polarization</b>	Horizontal	<b>Test Configuration</b>	2

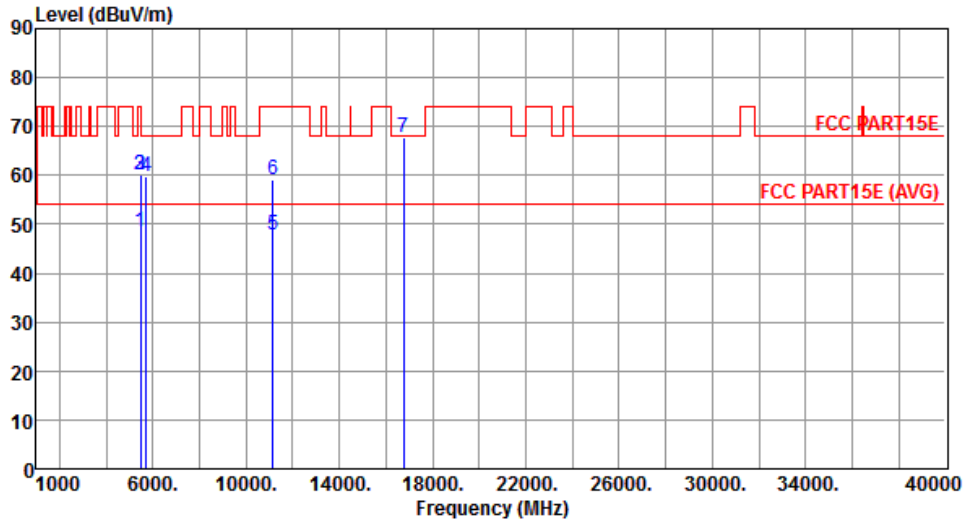

	Freq. MHz	Emission level dBuV/m	Limit dBuV/m	Margin dB	SA reading dBuV	Factor dB	Remark	ANT High cm	Turn Table deg
1	5460.00	48.33	54.00	-5.67	41.57	6.76	Average	150	1
2	5460.00	60.10	74.00	-13.90	53.34	6.76	Peak	150	1
3	5470.00	60.12	68.20	-8.08	53.35	6.77	Peak	150	1
4	5725.00	59.74	68.20	-8.46	52.50	7.24	Peak	150	1
5	11160.00	47.71	54.00	-6.29	30.92	16.79	Average	219	20
6	11160.00	59.12	74.00	-14.88	42.33	16.79	Peak	219	20
7	16740.00	67.87	68.20	-0.33	49.47	18.40	Peak	245	330

Note 1: Emission Level (dBuV/m) = SA Reading (dBuV/m) + Factor\* (dB)

\*Factor includes antenna factor , cable loss and amplifier gain

Note 2: Margin (dB) = Emission level (dBuV/m) – Limit (dBuV/m).

<b>Modulation</b>	11a	<b>Test Freq. (MHz)</b>	5580
<b>Polarization</b>	Vertical	<b>Test Configuration</b>	2

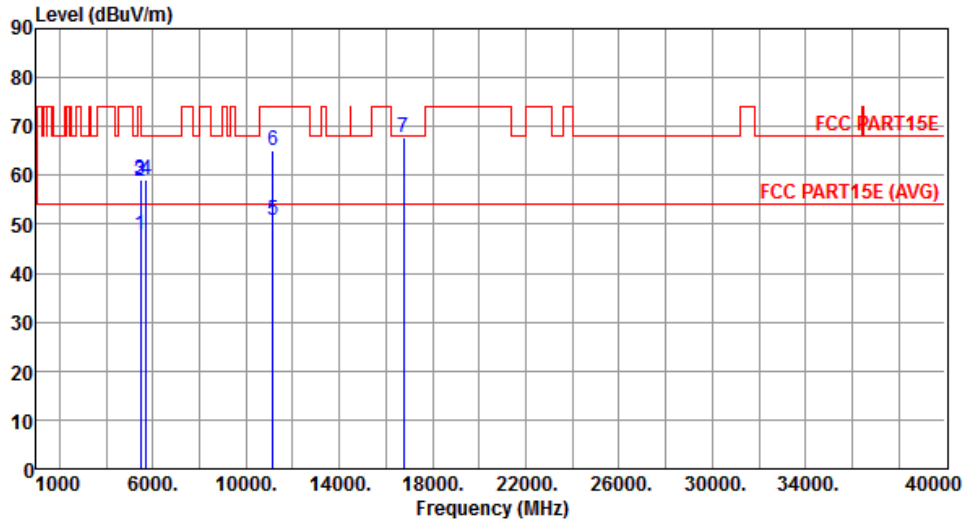

	Freq. MHz	Emission level dBuV/m	Limit dBuV/m	Margin dB	SA reading dBuV	Factor dB	Remark	ANT High cm	Turn Table deg
1	5460.00	47.86	54.00	-6.14	41.10	6.76	Average	153	348
2	5460.00	58.73	74.00	-15.27	51.97	6.76	Peak	153	348
3	5470.00	59.19	68.20	-9.01	52.42	6.77	Peak	153	348
4	5725.00	59.15	68.20	-9.05	51.91	7.24	Peak	153	348
5	11160.00	50.83	54.00	-3.17	34.04	16.79	Average	168	22
6	11160.00	65.04	74.00	-8.96	48.25	16.79	Peak	168	22
7	16740.00	67.65	68.20	-0.55	49.25	18.40	Peak	252	326

Note 1: Emission Level (dBuV/m) = SA Reading (dBuV/m) + Factor\* (dB)

\*Factor includes antenna factor , cable loss and amplifier gain

Note 2: Margin (dB) = Emission level (dBuV/m) – Limit (dBuV/m).

<b>Modulation</b>	11a	<b>Test Freq. (MHz)</b>	5700
<b>Polarization</b>	Horizontal	<b>Test Configuration</b>	2

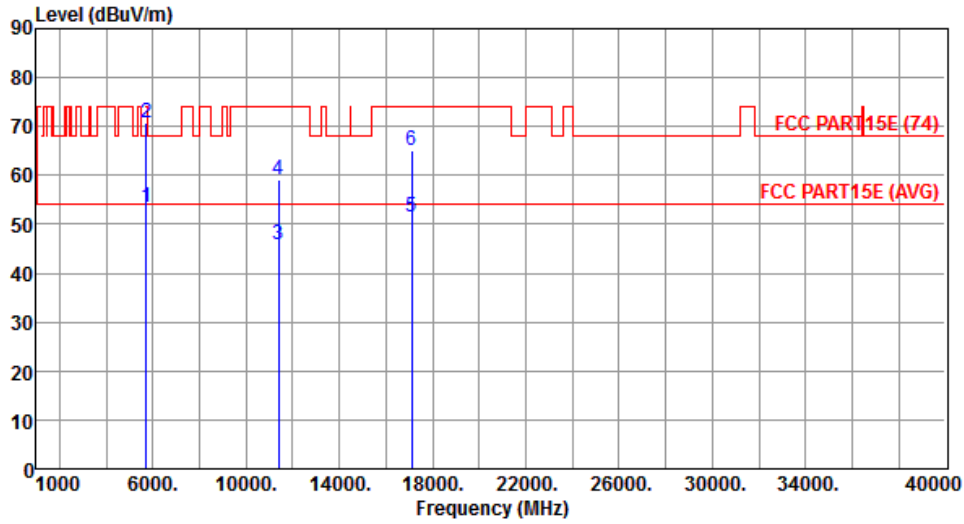

	Freq. MHz	Emission level dBuV/m	Limit dBuV/m	Margin dB	SA reading dBuV	Factor dB	Remark	ANT High cm	Turn Table deg
1	5725.00	53.49	54.00	-0.51	46.25	7.24	Average	152	1
2	5725.00	70.81	74.00	-3.19	63.57	7.24	Peak	152	1
3	11400.00	45.93	54.00	-8.07	29.05	16.88	Average	151	202
4	11400.00	59.18	74.00	-14.82	42.30	16.88	Peak	151	202
5	17100.00	51.57	54.00	-2.43	32.45	19.12	Average	151	132
6	17100.00	65.25	74.00	-8.75	46.13	19.12	Peak	151	132

Note 1: Emission Level (dBuV/m) = SA Reading (dBuV/m) + Factor\* (dB)

\*Factor includes antenna factor , cable loss and amplifier gain

Note 2: Margin (dB) = Emission level (dBuV/m) – Limit (dBuV/m).

<b>Modulation</b>	11a	<b>Test Freq. (MHz)</b>	5700
<b>Polarization</b>	Vertical	<b>Test Configuration</b>	2

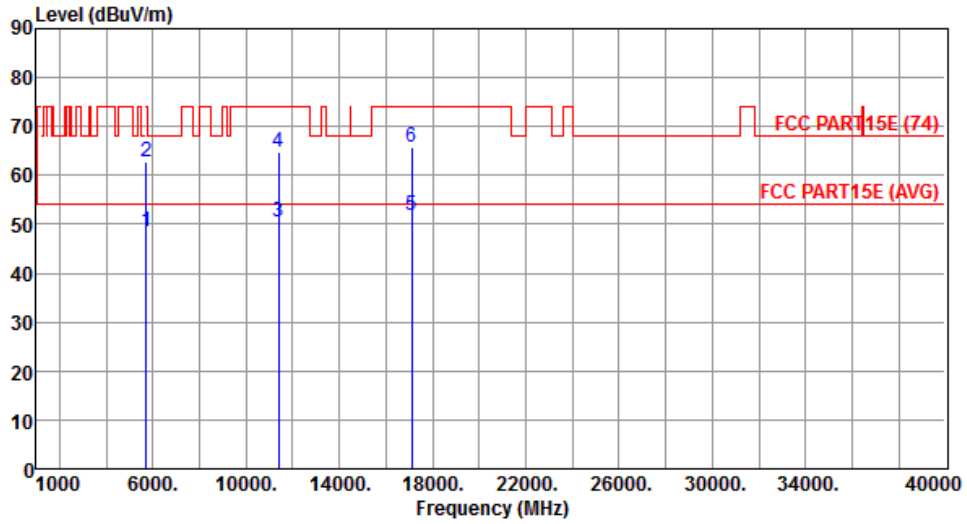

	Freq. MHz	Emission level dBuV/m	Limit dBuV/m	Margin dB	SA reading dBuV	Factor dB	Remark	ANT High cm	Turn Table deg
1	5725.00	48.62	54.00	-5.38	41.38	7.24	Average	153	18
2	5725.00	62.72	74.00	-11.28	55.48	7.24	Peak	153	18
3	11400.00	50.53	54.00	-3.47	33.65	16.88	Average	150	202
4	11400.00	64.85	74.00	-9.15	47.97	16.88	Peak	150	202
5	17100.00	51.96	54.00	-2.04	32.84	19.12	Average	150	202
6	17100.00	65.81	74.00	-8.19	46.69	19.12	Peak	150	202

Note 1: Emission Level (dBuV/m) = SA Reading (dBuV/m) + Factor\* (dB)

\*Factor includes antenna factor , cable loss and amplifier gain

Note 2: Margin (dB) = Emission level (dBuV/m) – Limit (dBuV/m).

<b>Modulation</b>	11a	<b>Test Freq. (MHz)</b>	5745
<b>Polarization</b>	Horizontal	<b>Test Configuration</b>	2

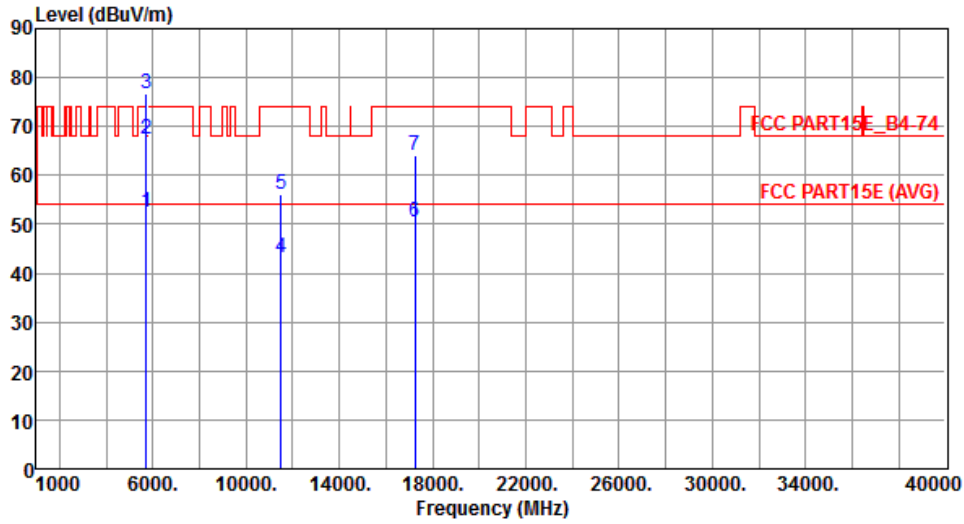

	Freq. MHz	Emission level dBuV/m	Limit dBuV/m	Margin dB	SA reading dBuV	Factor dB	Remark	ANT High cm	Turn Table deg
1	5715.00	52.34	54.00	-1.66	45.14	7.20	Average	203	358
2	5715.00	67.56	74.00	-6.44	60.36	7.20	Peak	203	358
3	5725.00	76.61	78.20	-1.59	69.37	7.24	Peak	203	359
4	11490.00	43.08	54.00	-10.92	26.17	16.91	Average	170	214
5	11490.00	56.18	74.00	-17.82	39.27	16.91	Peak	170	214
6	17235.00	50.57	54.00	-3.43	31.25	19.32	Average	198	137
7	17235.00	64.21	74.00	-9.79	44.89	19.32	Peak	198	137

Note 1: Emission Level (dBuV/m) = SA Reading (dBuV/m) + Factor\* (dB)

\*Factor includes antenna factor , cable loss and amplifier gain

Note 2: Margin (dB) = Emission level (dBuV/m) – Limit (dBuV/m).

<b>Modulation</b>	11a	<b>Test Freq. (MHz)</b>	5745
<b>Polarization</b>	Vertical	<b>Test Configuration</b>	2

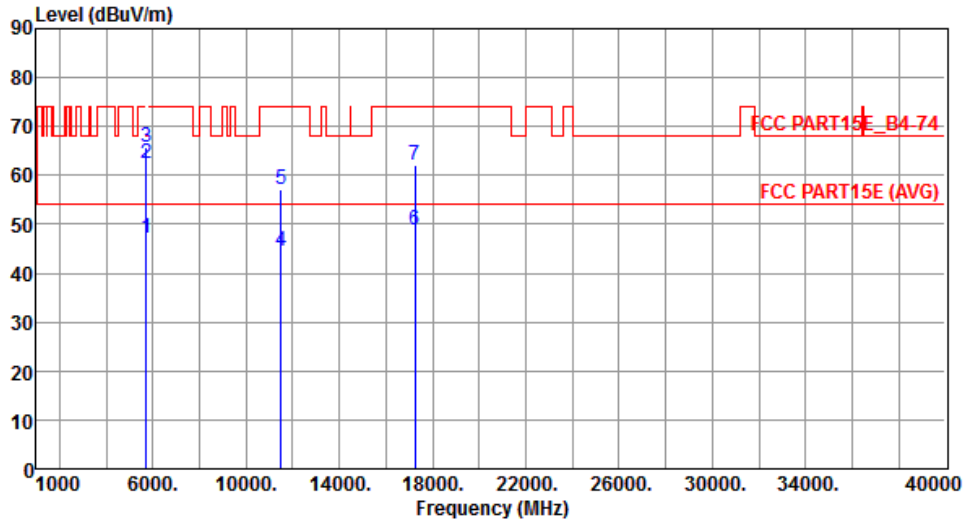

	Freq. MHz	Emission level dBuV/m	Limit dBuV/m	Margin dB	SA reading dBuV	Factor dB	Remark	ANT High cm	Turn Table deg
1	5715.00	47.13	54.00	-6.87	39.93	7.20	Average	268	55
2	5715.00	62.44	74.00	-11.56	55.24	7.20	Peak	268	55
3	5725.00	65.72	78.20	-12.48	58.48	7.24	Peak	268	55
4	11490.00	44.44	54.00	-9.56	27.53	16.91	Average	150	185
5	11490.00	57.07	74.00	-16.93	40.16	16.91	Peak	150	185
6	17235.00	48.82	54.00	-5.18	29.50	19.32	Average	150	168
7	17235.00	62.06	74.00	-11.94	42.74	19.32	Peak	150	168

Note 1: Emission Level (dBuV/m) = SA Reading (dBuV/m) + Factor\* (dB)  
 \*Factor includes antenna factor , cable loss and amplifier gain  
 Note 2: Margin (dB) = Emission level (dBuV/m) – Limit (dBuV/m).

<b>Modulation</b>	11a	<b>Test Freq. (MHz)</b>	5785
<b>Polarization</b>	Horizontal	<b>Test Configuration</b>	2

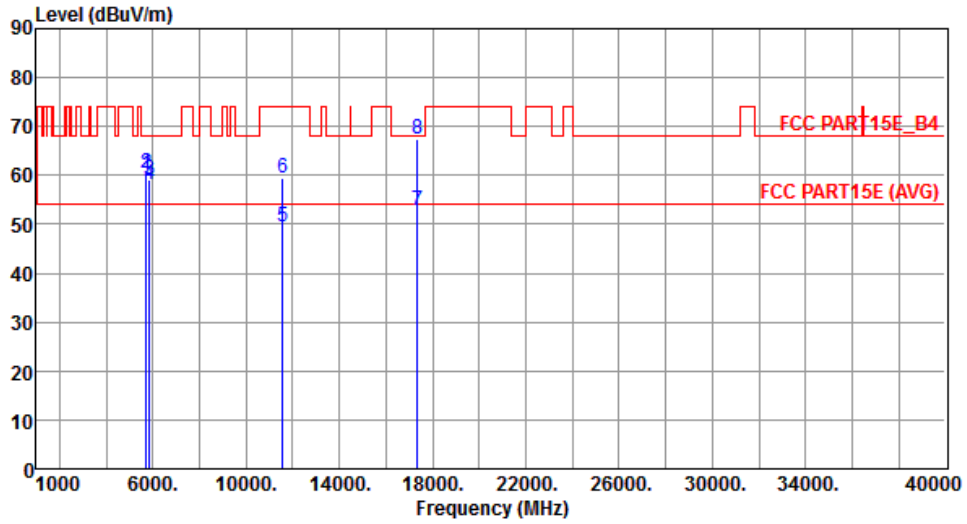

	Freq. MHz	Emission level dBuV/m	Limit dBuV/m	Margin dB	SA reading dBuV	Factor dB	Remark	ANT High cm	Turn Table deg
1	5715.00	59.95	68.20	-8.25	52.75	7.20	Peak	246	198
2	5725.00	60.35	78.20	-17.85	53.11	7.24	Peak	246	198
3	5850.00	59.05	78.20	-19.15	51.55	7.50	Peak	246	198
4	5860.00	58.09	68.20	-10.11	50.58	7.51	Peak	246	198
5	11570.00	49.51	54.00	-4.49	32.71	16.80	Average	207	342
6	11570.00	59.49	74.00	-14.51	42.69	16.80	Peak	207	342
7	17355.00	52.65	54.00	-1.35	33.16	19.49	Average	214	325
8	17355.00	67.33	68.20	-0.87	47.84	19.49	Peak	214	325

Note 1: Emission Level (dBuV/m) = SA Reading (dBuV/m) + Factor\* (dB)

\*Factor includes antenna factor , cable loss and amplifier gain

Note 2: Margin (dB) = Emission level (dBuV/m) – Limit (dBuV/m).



<b>Modulation</b>	11a	<b>Test Freq. (MHz)</b>	5785
<b>Polarization</b>	Vertical	<b>Test Configuration</b>	2

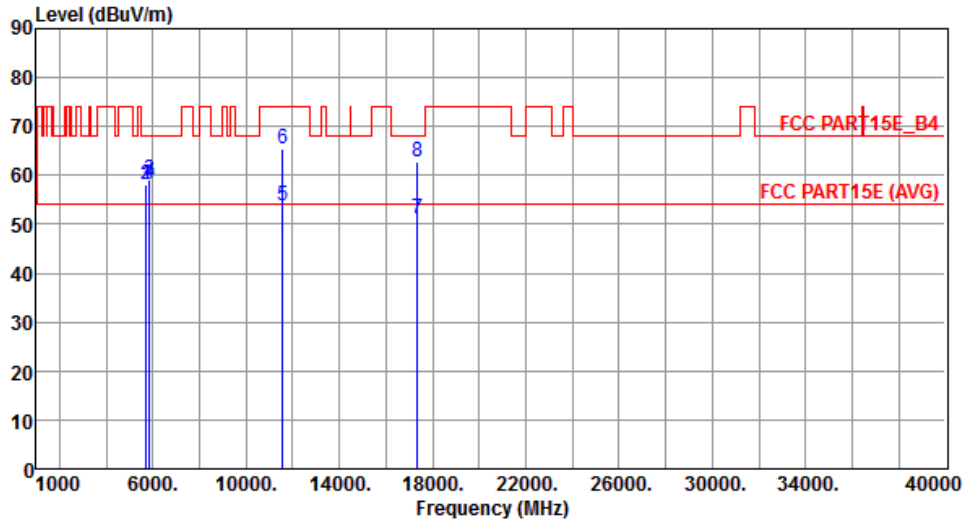

	Freq. MHz	Emission level dBuV/m	Limit dBuV/m	Margin dB	SA reading dBuV	Factor dB	Remark	ANT High cm	Turn Table deg
1	5715.00	58.18	68.20	-10.02	50.98	7.20	Peak	268	108
2	5725.00	57.97	78.20	-20.23	50.73	7.24	Peak	268	108
3	5850.00	59.14	78.20	-19.06	51.64	7.50	Peak	268	108
4	5860.00	58.49	68.20	-9.71	50.98	7.51	Peak	268	108
5	11570.00	53.80	54.00	-0.20	37.00	16.80	Average	162	358
6	11570.00	65.28	74.00	-8.72	48.48	16.80	Peak	162	358
7	17355.00	51.29	54.00	-2.71	31.80	19.49	Average	151	317
8	17355.00	62.72	68.20	-5.48	43.23	19.49	Peak	151	317

Note 1: Emission Level (dBuV/m) = SA Reading (dBuV/m) + Factor\* (dB)

\*Factor includes antenna factor , cable loss and amplifier gain

Note 2: Margin (dB) = Emission level (dBuV/m) – Limit (dBuV/m).

<b>Modulation</b>	11a	<b>Test Freq. (MHz)</b>	5825
<b>Polarization</b>	Horizontal	<b>Test Configuration</b>	2

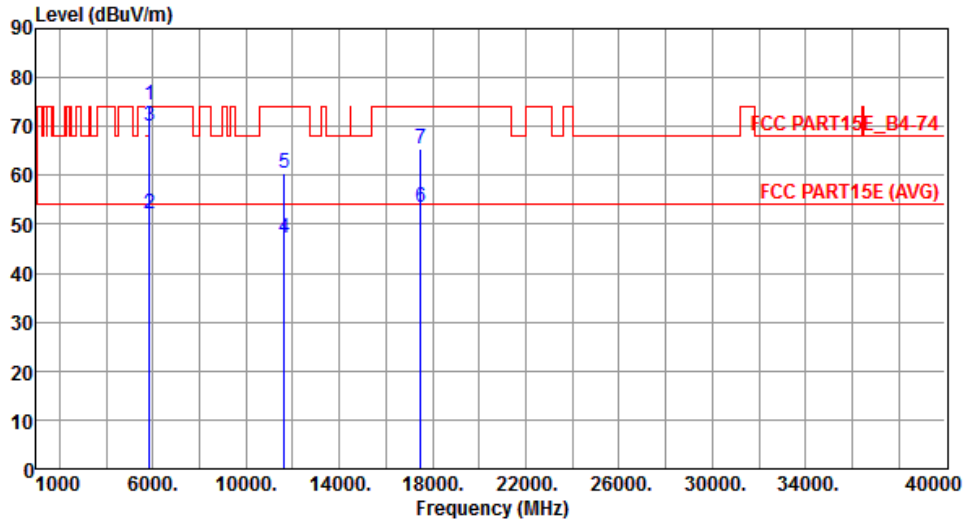

	Freq. MHz	Emission level dBuV/m	Limit dBuV/m	Margin dB	SA reading dBuV	Factor dB	Remark	ANT High cm	Turn Table deg
1	5850.00	74.39	78.20	-3.81	66.89	7.50	Peak	227	197
2	5860.00	52.29	54.00	-1.71	44.78	7.51	Average	227	197
3	5860.00	69.99	74.00	-4.01	62.48	7.51	Peak	227	197
4	11650.00	47.06	54.00	-6.94	30.41	16.65	Average	215	160
5	11650.00	60.30	74.00	-13.70	43.65	16.65	Peak	215	160
6	17475.00	53.36	54.00	-0.64	33.70	19.66	Average	225	140
7	17475.00	65.49	74.00	-8.51	45.83	19.66	Peak	225	140

Note 1: Emission Level (dBuV/m) = SA Reading (dBuV/m) + Factor\* (dB)

\*Factor includes antenna factor , cable loss and amplifier gain

Note 2: Margin (dB) = Emission level (dBuV/m) – Limit (dBuV/m).

<b>Modulation</b>	11a	<b>Test Freq. (MHz)</b>	5825
<b>Polarization</b>	Vertical	<b>Test Configuration</b>	2

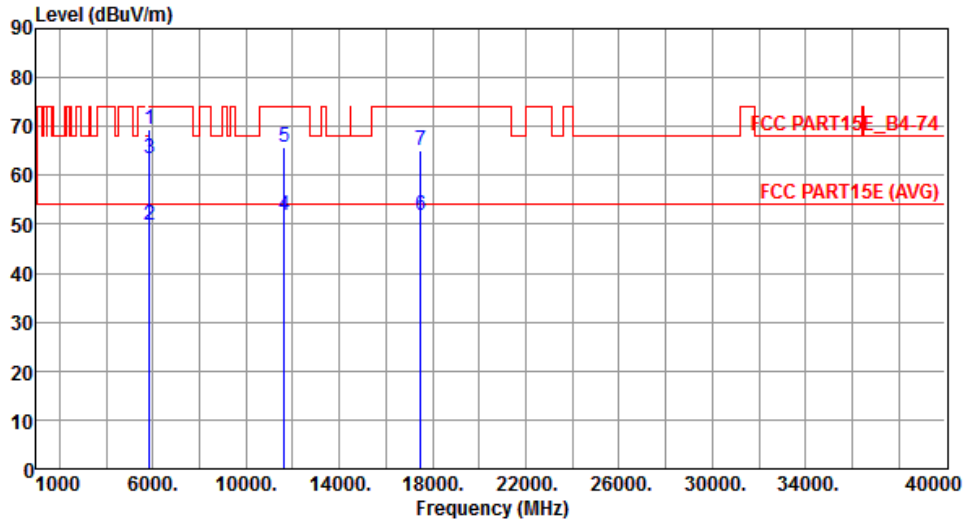

	Freq. MHz	Emission level dBuV/m	Limit dBuV/m	Margin dB	SA reading dBuV	Factor dB	Remark	ANT High cm	Turn Table deg
1	5850.00	69.30	78.20	-8.90	61.80	7.50	Peak	254	80
2	5860.00	49.71	54.00	-4.29	42.20	7.51	Average	254	80
3	5860.00	63.46	74.00	-10.54	55.95	7.51	Peak	254	80
4	11650.00	51.85	54.00	-2.15	35.20	16.65	Average	161	164
5	11650.00	65.61	74.00	-8.39	48.96	16.65	Peak	161	164
6	17475.00	51.96	54.00	-2.04	32.30	19.66	Average	155	155
7	17475.00	65.10	74.00	-8.90	45.44	19.66	Peak	155	155

Note 1: Emission Level (dBuV/m) = SA Reading (dBuV/m) + Factor\* (dB)

\*Factor includes antenna factor , cable loss and amplifier gain

Note 2: Margin (dB) = Emission level (dBuV/m) – Limit (dBuV/m).

### 3.5.10 Transmitter Radiated Unwanted Emissions (Above 1GHz) for HT20

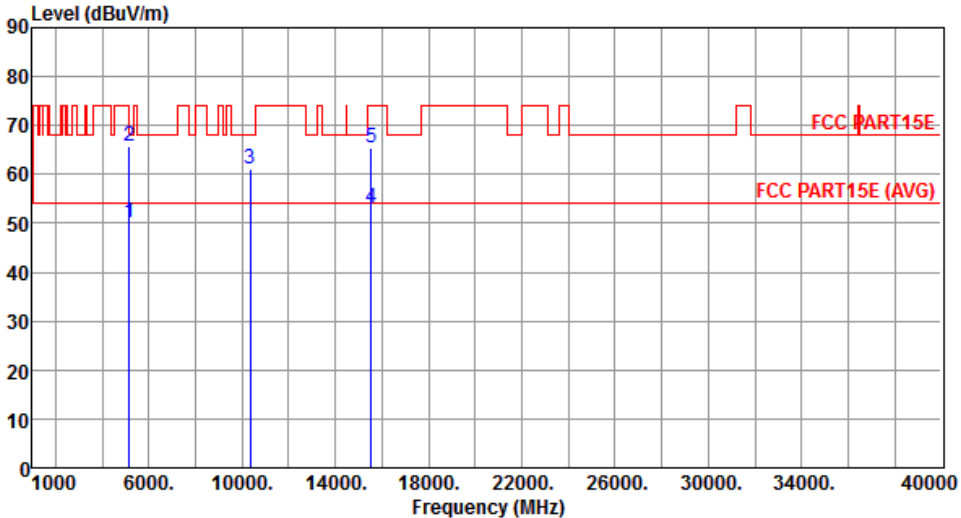
Modulation	HT20	Test Freq. (MHz)	5180																																																																					
Polarization	Horizontal	Test Configuration	2																																																																					
																																																																								
	<table border="1"> <thead> <tr> <th>Freq.</th> <th>Emission level</th> <th>Limit</th> <th>Margin</th> <th>SA reading</th> <th>Factor</th> <th>Remark</th> <th>ANT High</th> <th>Turn Table</th> </tr> <tr> <th>MHz</th> <th>dBuV/m</th> <th>dBuV/m</th> <th>dB</th> <th>dBuV</th> <th>dB</th> <th></th> <th>cm</th> <th>deg</th> </tr> </thead> <tbody> <tr> <td>1</td> <td>5150.00</td> <td>50.16</td> <td>54.00</td> <td>-3.84</td> <td>43.85</td> <td>6.31</td> <td>Average</td> <td>284</td> <td>28</td> </tr> <tr> <td>2</td> <td>5150.00</td> <td>65.84</td> <td>74.00</td> <td>-8.16</td> <td>59.53</td> <td>6.31</td> <td>Peak</td> <td>284</td> <td>28</td> </tr> <tr> <td>3</td> <td>10360.00</td> <td>61.27</td> <td>68.20</td> <td>-6.93</td> <td>44.93</td> <td>16.34</td> <td>Peak</td> <td>165</td> <td>123</td> </tr> <tr> <td>4</td> <td>15540.00</td> <td>53.22</td> <td>54.00</td> <td>-0.78</td> <td>35.72</td> <td>17.50</td> <td>Average</td> <td>165</td> <td>123</td> </tr> <tr> <td>5</td> <td>15540.00</td> <td>65.52</td> <td>74.00</td> <td>-8.48</td> <td>48.02</td> <td>17.50</td> <td>Peak</td> <td>165</td> <td>123</td> </tr> </tbody> </table>	Freq.	Emission level	Limit	Margin	SA reading	Factor	Remark	ANT High	Turn Table	MHz	dBuV/m	dBuV/m	dB	dBuV	dB		cm	deg	1	5150.00	50.16	54.00	-3.84	43.85	6.31	Average	284	28	2	5150.00	65.84	74.00	-8.16	59.53	6.31	Peak	284	28	3	10360.00	61.27	68.20	-6.93	44.93	16.34	Peak	165	123	4	15540.00	53.22	54.00	-0.78	35.72	17.50	Average	165	123	5	15540.00	65.52	74.00	-8.48	48.02	17.50	Peak	165	123			
Freq.	Emission level	Limit	Margin	SA reading	Factor	Remark	ANT High	Turn Table																																																																
MHz	dBuV/m	dBuV/m	dB	dBuV	dB		cm	deg																																																																
1	5150.00	50.16	54.00	-3.84	43.85	6.31	Average	284	28																																																															
2	5150.00	65.84	74.00	-8.16	59.53	6.31	Peak	284	28																																																															
3	10360.00	61.27	68.20	-6.93	44.93	16.34	Peak	165	123																																																															
4	15540.00	53.22	54.00	-0.78	35.72	17.50	Average	165	123																																																															
5	15540.00	65.52	74.00	-8.48	48.02	17.50	Peak	165	123																																																															
<p>Note 1: Emission Level (dBuV/m) = SA Reading (dBuV/m) + Factor* (dB)            *Factor includes antenna factor , cable loss and amplifier gain            Note 2: Margin (dB) = Emission level (dBuV/m) – Limit (dBuV/m).</p>																																																																								

<b>Modulation</b>	HT20	<b>Test Freq. (MHz)</b>	5180
<b>Polarization</b>	Vertical	<b>Test Configuration</b>	2

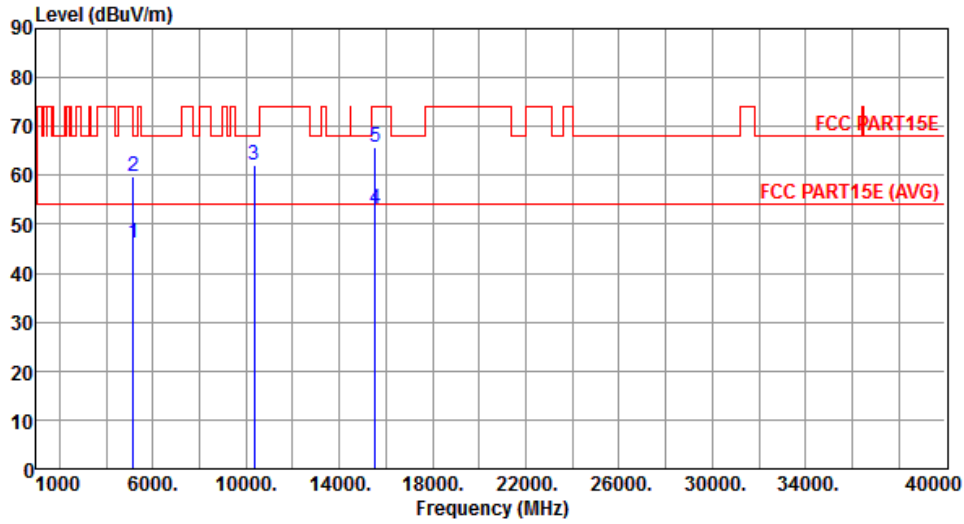

	Freq. MHz	Emission level dBuV/m	Limit dBuV/m	Margin dB	SA reading dBuV	Factor dB	Remark	ANT High cm	Turn Table deg
1	5150.00	46.21	54.00	-7.79	39.90	6.31	Average	230	111
2	5150.00	59.88	74.00	-14.12	53.57	6.31	Peak	230	111
3	10360.00	62.02	68.20	-6.18	45.68	16.34	Peak	397	181
4	15540.00	53.00	54.00	-1.00	35.50	17.50	Average	167	207
5	15540.00	65.61	74.00	-8.39	48.11	17.50	Peak	167	207

Note 1: Emission Level (dBuV/m) = SA Reading (dBuV/m) + Factor\* (dB)

\*Factor includes antenna factor , cable loss and amplifier gain

Note 2: Margin (dB) = Emission level (dBuV/m) – Limit (dBuV/m).

<b>Modulation</b>	HT20	<b>Test Freq. (MHz)</b>	5200
<b>Polarization</b>	Horizontal	<b>Test Configuration</b>	2

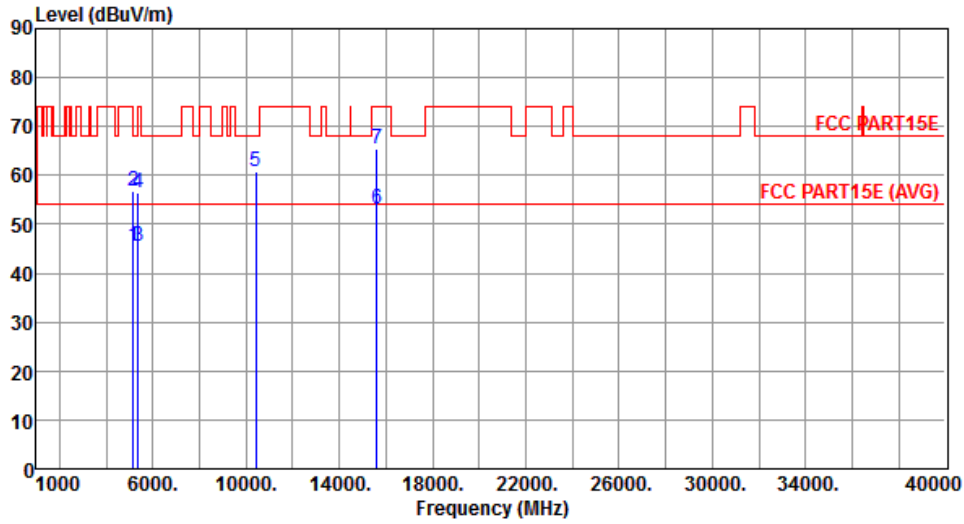

	Freq. MHz	Emission level dBuV/m	Limit dBuV/m	Margin dB	SA reading dBuV	Factor dB	Remark	ANT High cm	Turn Table deg
1	5150.00	45.50	54.00	-8.50	39.19	6.31	Average	150	3
2	5150.00	56.81	74.00	-17.19	50.50	6.31	Peak	150	3
3	5350.00	45.57	54.00	-8.43	38.95	6.62	Average	150	3
4	5350.00	56.30	74.00	-17.70	49.68	6.62	Peak	150	3
5	10400.00	60.68	68.20	-7.52	44.26	16.42	Peak	309	111
6	15600.00	53.21	54.00	-0.79	35.83	17.38	Average	150	198
7	15600.00	65.32	74.00	-8.68	47.94	17.38	Peak	150	198

Note 1: Emission Level (dBuV/m) = SA Reading (dBuV/m) + Factor\* (dB)

\*Factor includes antenna factor , cable loss and amplifier gain

Note 2: Margin (dB) = Emission level (dBuV/m) – Limit (dBuV/m).

<b>Modulation</b>	HT20	<b>Test Freq. (MHz)</b>	5200
<b>Polarization</b>	Vertical	<b>Test Configuration</b>	2

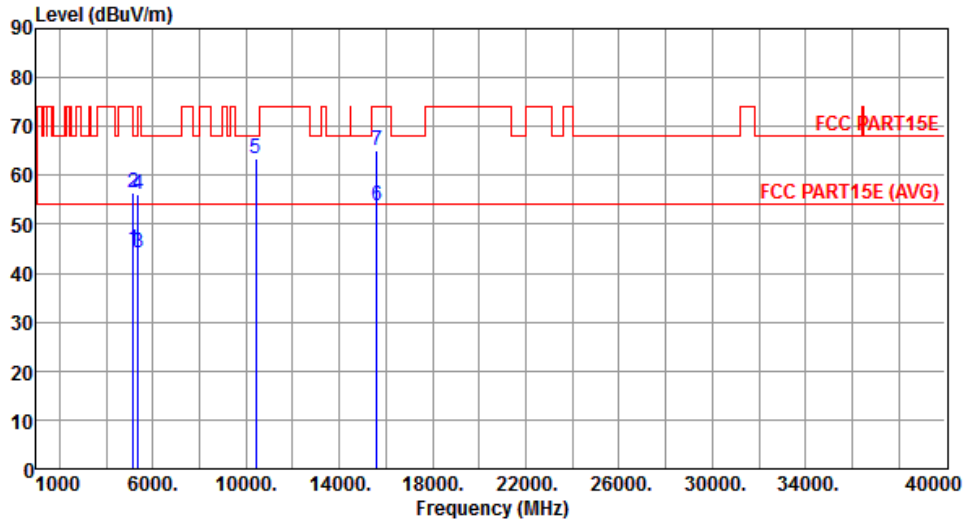

	Freq. MHz	Emission level dBuV/m	Limit dBuV/m	Margin dB	SA reading dBuV	Factor dB	Remark	ANT High cm	Turn Table deg
1	5150.00	44.90	54.00	-9.10	38.59	6.31	Average	385	342
2	5150.00	56.49	74.00	-17.51	50.18	6.31	Peak	385	342
3	5350.00	44.12	54.00	-9.88	37.50	6.62	Average	385	342
4	5350.00	55.97	74.00	-18.03	49.35	6.62	Peak	385	342
5	10400.00	63.29	68.20	-4.91	46.87	16.42	Peak	383	103
6	15600.00	53.66	54.00	-0.34	36.28	17.38	Average	150	186
7	15600.00	65.12	74.00	-8.88	47.74	17.38	Peak	150	186

Note 1: Emission Level (dBuV/m) = SA Reading (dBuV/m) + Factor\* (dB)

\*Factor includes antenna factor , cable loss and amplifier gain

Note 2: Margin (dB) = Emission level (dBuV/m) – Limit (dBuV/m).

<b>Modulation</b>	HT20	<b>Test Freq. (MHz)</b>	5240
<b>Polarization</b>	Horizontal	<b>Test Configuration</b>	2

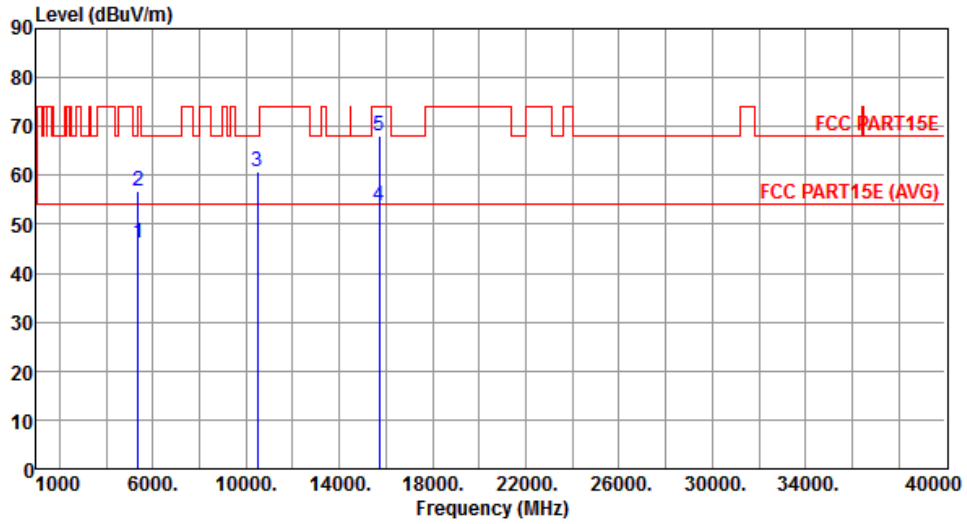

	Freq. MHz	Emission level dBuV/m	Limit dBuV/m	Margin dB	SA reading dBuV	Factor dB	Remark	ANT High cm	Turn Table deg
1	5350.00	46.18	54.00	-7.82	39.56	6.62	Average	150	2
2	5350.00	56.77	74.00	-17.23	50.15	6.62	Peak	150	2
3	10480.00	60.69	68.20	-7.51	44.13	16.56	Peak	207	243
4	15720.00	53.87	54.00	-0.13	36.72	17.15	Average	206	139
5	15720.00	68.15	74.00	-5.85	51.00	17.15	Peak	206	139

Note 1: Emission Level (dBuV/m) = SA Reading (dBuV/m) + Factor\* (dB)

\*Factor includes antenna factor , cable loss and amplifier gain

Note 2: Margin (dB) = Emission level (dBuV/m) – Limit (dBuV/m).



<b>Modulation</b>	HT20	<b>Test Freq. (MHz)</b>	5240
<b>Polarization</b>	Vertical	<b>Test Configuration</b>	2

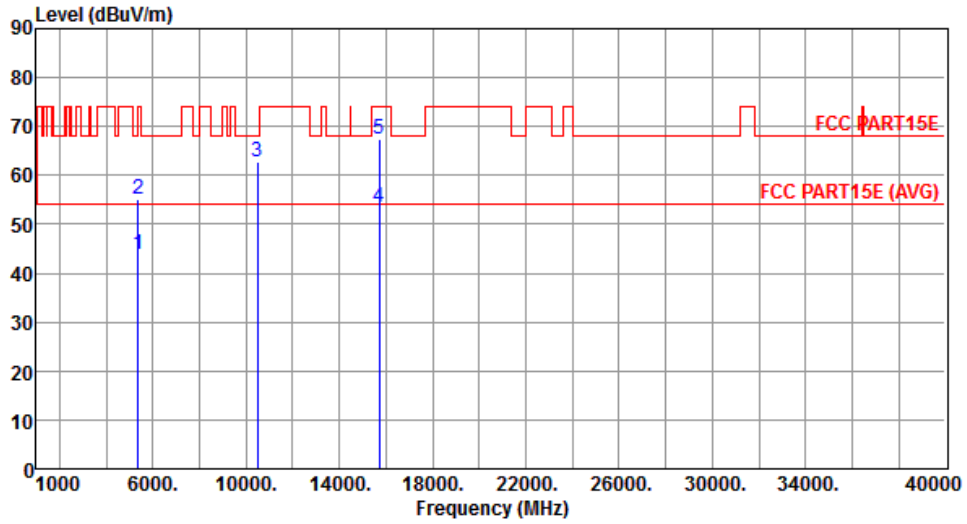

	Freq. MHz	Emission level dBuV/m	Limit dBuV/m	Margin dB	SA reading dBuV	Factor dB	Remark	ANT High cm	Turn Table deg
1	5350.00	43.78	54.00	-10.22	37.16	6.62	Average	379	215
2	5350.00	55.27	74.00	-18.73	48.65	6.62	Peak	379	215
3	10480.00	62.62	68.20	-5.58	46.06	16.56	Peak	376	216
4	15720.00	53.51	54.00	-0.49	36.36	17.15	Average	150	193
5	15720.00	67.28	74.00	-6.72	50.13	17.15	Peak	150	193

Note 1: Emission Level (dBuV/m) = SA Reading (dBuV/m) + Factor\* (dB)

\*Factor includes antenna factor , cable loss and amplifier gain

Note 2: Margin (dB) = Emission level (dBuV/m) – Limit (dBuV/m).

<b>Modulation</b>	HT20	<b>Test Freq. (MHz)</b>	5260
<b>Polarization</b>	Horizontal	<b>Test Configuration</b>	2

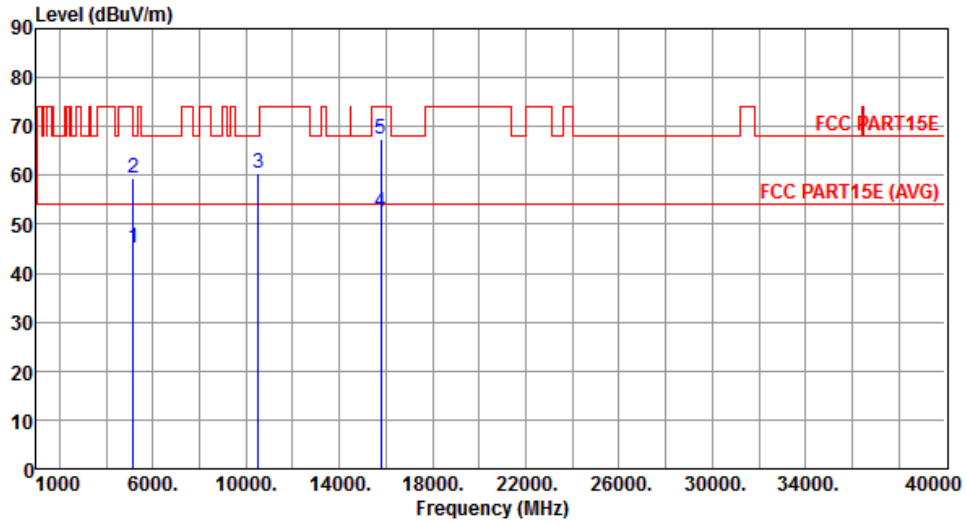

	Freq. MHz	Emission level dBuV/m	Limit dBuV/m	Margin dB	SA reading dBuV	Factor dB	Remark	ANT High cm	Turn Table deg
1	5150.00	45.09	54.00	-8.91	38.78	6.31	Average	203	345
2	5150.00	59.49	74.00	-14.51	53.18	6.31	Peak	203	345
3	10520.00	60.58	68.20	-7.62	43.98	16.60	Peak	252	263
4	15780.00	52.36	54.00	-1.64	35.31	17.05	Average	265	148
5	15780.00	67.25	74.00	-6.75	50.20	17.05	Peak	265	148

Note 1: Emission Level (dBuV/m) = SA Reading (dBuV/m) + Factor\* (dB)

\*Factor includes antenna factor , cable loss and amplifier gain

Note 2: Margin (dB) = Emission level (dBuV/m) – Limit (dBuV/m).

<b>Modulation</b>	HT20	<b>Test Freq. (MHz)</b>	5260
<b>Polarization</b>	Vertical	<b>Test Configuration</b>	2

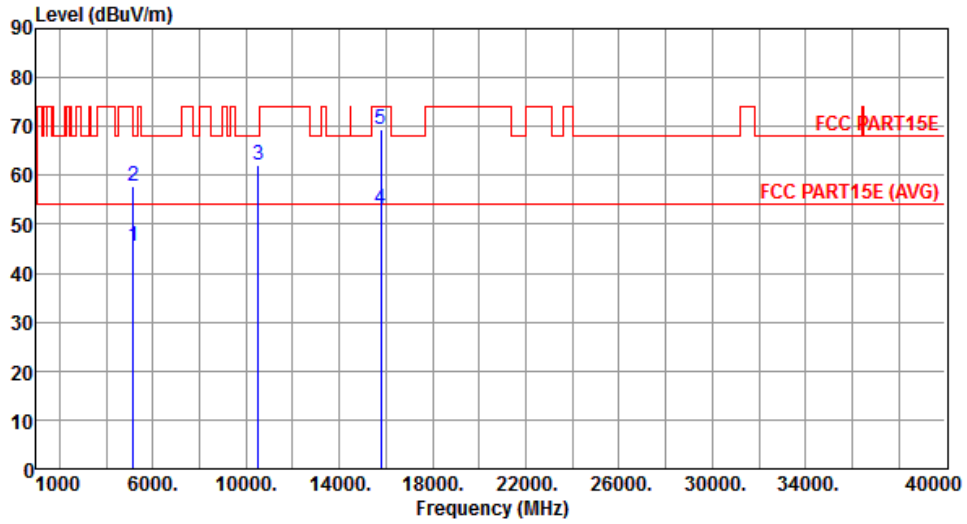

	Freq. MHz	Emission level dBuV/m	Limit dBuV/m	Margin dB	SA reading dBuV	Factor dB	Remark	ANT High cm	Turn Table deg
1	5150.00	45.51	54.00	-8.49	39.20	6.31	Average	251	87
2	5150.00	57.85	74.00	-16.15	51.54	6.31	Peak	251	87
3	10520.00	62.25	68.20	-5.95	45.65	16.60	Peak	266	191
4	15780.00	53.08	54.00	-0.92	36.03	17.05	Average	150	190
5	15780.00	69.43	74.00	-4.57	52.38	17.05	Peak	150	190

Note 1: Emission Level (dBuV/m) = SA Reading (dBuV/m) + Factor\* (dB)

\*Factor includes antenna factor , cable loss and amplifier gain

Note 2: Margin (dB) = Emission level (dBuV/m) – Limit (dBuV/m).

<b>Modulation</b>	HT20	<b>Test Freq. (MHz)</b>	5300
<b>Polarization</b>	Horizontal	<b>Test Configuration</b>	2

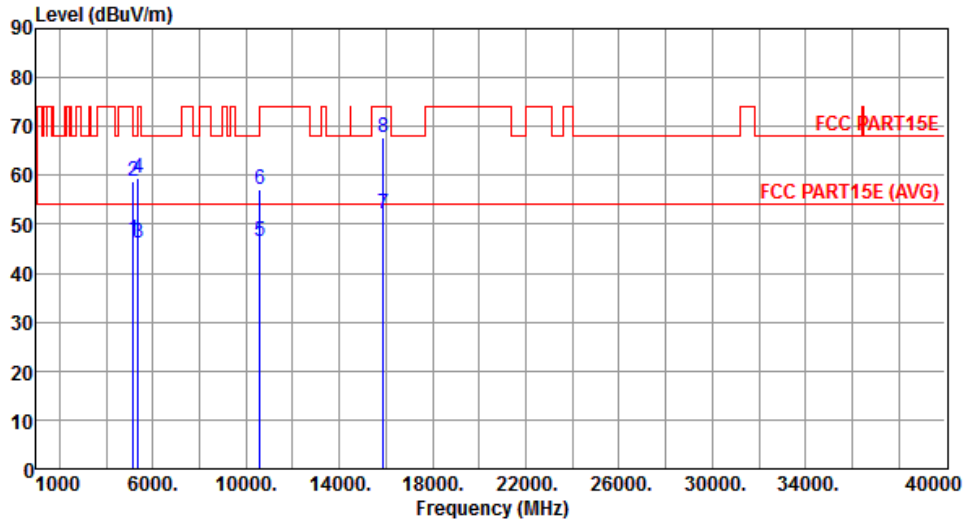

	Freq. MHz	Emission level dBuV/m	Limit dBuV/m	Margin dB	SA reading dBuV	Factor dB	Remark	ANT High cm	Turn Table deg
1	5150.00	46.88	54.00	-7.12	40.57	6.31	Average	155	8
2	5150.00	58.66	74.00	-15.34	52.35	6.31	Peak	155	8
3	5350.00	46.17	54.00	-7.83	39.55	6.62	Average	155	8
4	5350.00	59.55	74.00	-14.45	52.93	6.62	Peak	155	8
5	10600.00	46.44	54.00	-7.56	29.82	16.62	Average	226	118
6	10600.00	57.13	74.00	-16.87	40.51	16.62	Peak	226	118
7	15900.00	52.14	54.00	-1.86	35.32	16.82	Average	243	124
8	15900.00	67.78	74.00	-6.22	50.96	16.82	Peak	243	124

Note 1: Emission Level (dBuV/m) = SA Reading (dBuV/m) + Factor\* (dB)

\*Factor includes antenna factor , cable loss and amplifier gain

Note 2: Margin (dB) = Emission level (dBuV/m) – Limit (dBuV/m).

<b>Modulation</b>	HT20	<b>Test Freq. (MHz)</b>	5300
<b>Polarization</b>	Vertical	<b>Test Configuration</b>	2

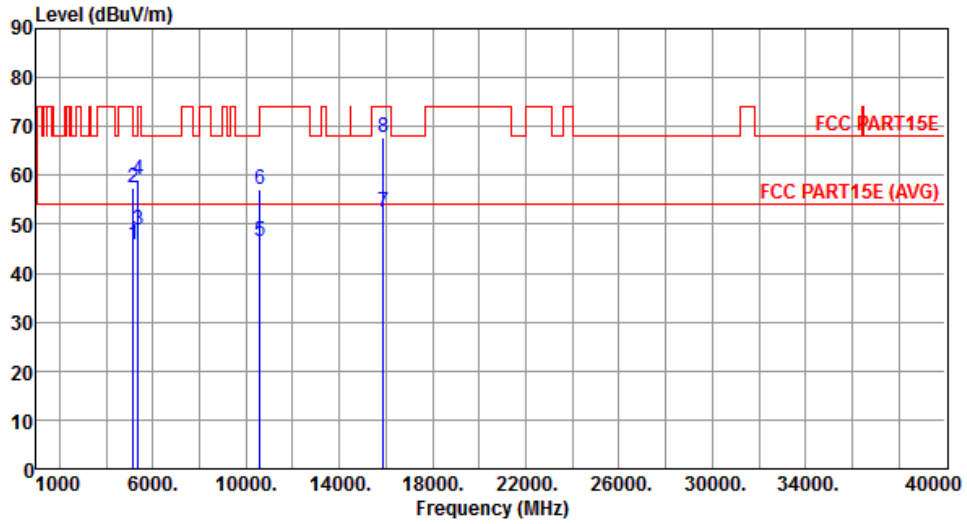

	Freq. MHz	Emission level dBuV/m	Limit dBuV/m	Margin dB	SA reading dBuV	Factor dB	Remark	ANT High cm	Turn Table deg
1	5150.00	45.95	54.00	-8.05	39.64	6.31	Average	150	321
2	5150.00	57.59	74.00	-16.41	51.28	6.31	Peak	150	321
3	5350.00	48.73	54.00	-5.27	42.11	6.62	Average	150	321
4	5350.00	59.04	74.00	-14.96	52.42	6.62	Peak	150	321
5	10600.00	46.51	54.00	-7.49	29.89	16.62	Average	150	333
6	10600.00	57.21	74.00	-16.79	40.59	16.62	Peak	150	333
7	15900.00	52.60	54.00	-1.40	35.78	16.82	Average	150	189
8	15900.00	67.65	74.00	-6.35	50.83	16.82	Peak	150	189

Note 1: Emission Level (dBuV/m) = SA Reading (dBuV/m) + Factor\* (dB)

\*Factor includes antenna factor , cable loss and amplifier gain

Note 2: Margin (dB) = Emission level (dBuV/m) – Limit (dBuV/m).

<b>Modulation</b>	HT20	<b>Test Freq. (MHz)</b>	5320
<b>Polarization</b>	Horizontal	<b>Test Configuration</b>	2

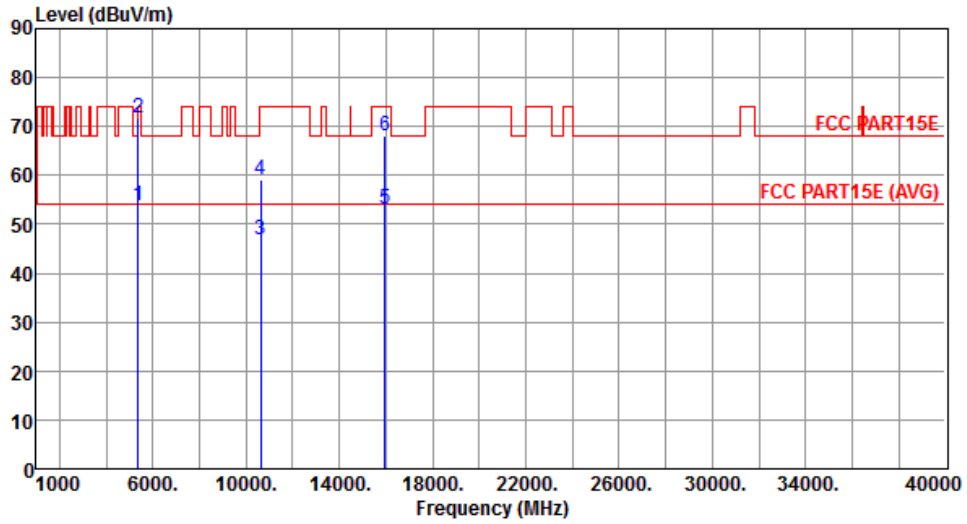

	Freq. MHz	Emission level dBuV/m	Limit dBuV/m	Margin dB	SA reading dBuV	Factor dB	Remark	ANT High cm	Turn Table deg
1	5350.00	53.66	54.00	-0.34	47.04	6.62	Average	236	171
2	5350.00	71.62	74.00	-2.38	65.00	6.62	Peak	236	171
3	10640.00	46.92	54.00	-7.08	30.29	16.63	Average	150	193
4	10640.00	59.18	74.00	-14.82	42.55	16.63	Peak	150	193
5	15960.00	53.00	54.00	-1.00	36.30	16.70	Average	150	188
6	15960.00	67.92	74.00	-6.08	51.22	16.70	Peak	150	188

Note 1: Emission Level (dBuV/m) = SA Reading (dBuV/m) + Factor\* (dB)

\*Factor includes antenna factor , cable loss and amplifier gain

Note 2: Margin (dB) = Emission level (dBuV/m) – Limit (dBuV/m).

<b>Modulation</b>	HT20	<b>Test Freq. (MHz)</b>	5320
<b>Polarization</b>	Vertical	<b>Test Configuration</b>	2

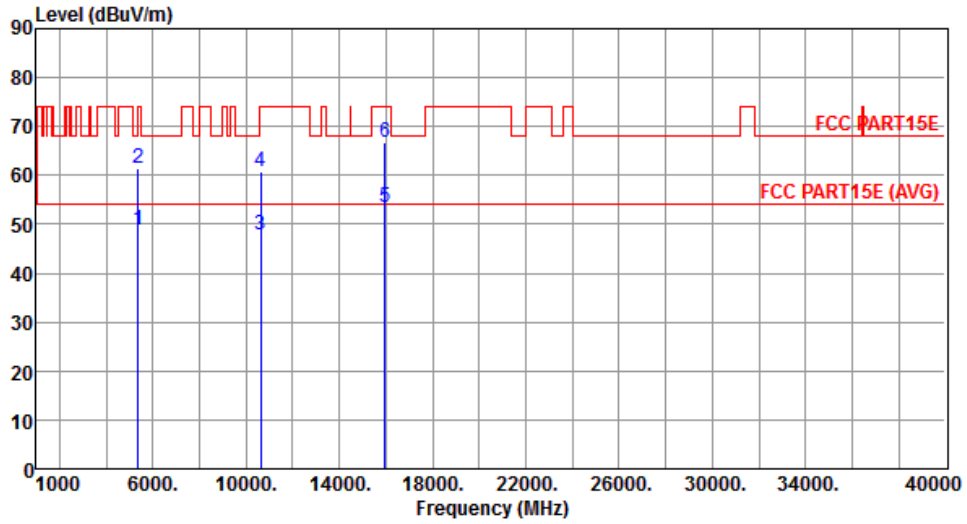

	Freq. MHz	Emission level dBuV/m	Limit dBuV/m	Margin dB	SA reading dBuV	Factor dB	Remark	ANT High cm	Turn Table deg
1	5350.00	48.96	54.00	-5.04	42.34	6.62	Average	329	250
2	5350.00	61.41	74.00	-12.59	54.79	6.62	Peak	329	250
3	10640.00	47.92	54.00	-6.08	31.29	16.63	Average	150	178
4	10640.00	60.77	74.00	-13.23	44.14	16.63	Peak	150	178
5	15960.00	53.45	54.00	-0.55	36.75	16.70	Average	150	184
6	15960.00	66.84	74.00	-7.16	50.14	16.70	Peak	150	184

Note 1: Emission Level (dBuV/m) = SA Reading (dBuV/m) + Factor\* (dB)

\*Factor includes antenna factor , cable loss and amplifier gain

Note 2: Margin (dB) = Emission level (dBuV/m) – Limit (dBuV/m).

<b>Modulation</b>	HT20	<b>Test Freq. (MHz)</b>	5500
<b>Polarization</b>	Horizontal	<b>Test Configuration</b>	2

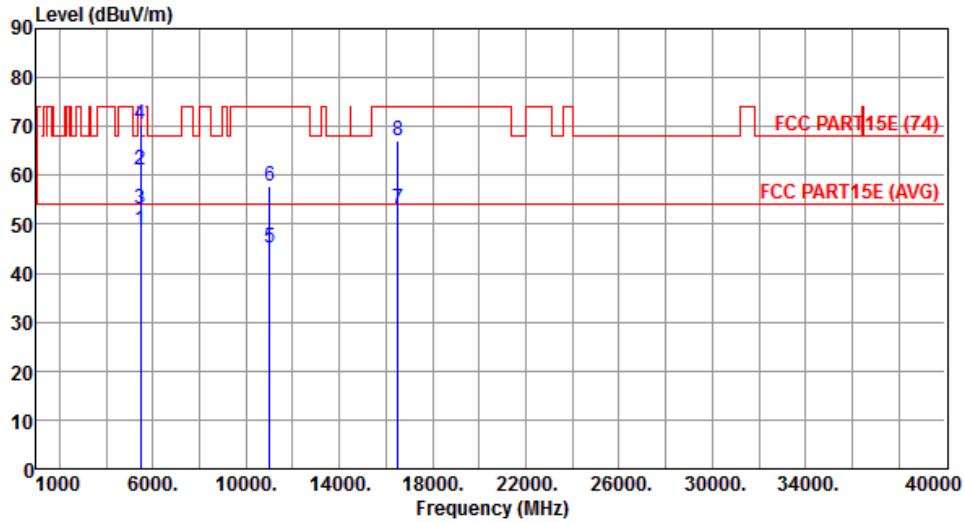

	Freq. MHz	Emission level dBuV/m	Limit dBuV/m	Margin dB	SA reading dBuV	Factor dB	Remark	ANT High cm	Turn Table deg
1	5460.00	48.87	54.00	-5.13	42.11	6.76	Average	161	17
2	5460.00	61.15	74.00	-12.85	54.39	6.76	Peak	161	17
3	5470.00	53.20	54.00	-0.80	46.43	6.77	Average	161	17
4	5470.00	70.24	74.00	-3.76	63.47	6.77	Peak	161	17
5	11000.00	45.03	54.00	-8.97	28.31	16.72	Average	254	143
6	11000.00	57.63	74.00	-16.37	40.91	16.72	Peak	254	143
7	16500.00	53.12	54.00	-0.88	35.25	17.87	Average	154	132
8	16500.00	67.18	74.00	-6.82	49.31	17.87	Peak	154	132

Note 1: Emission Level (dBuV/m) = SA Reading (dBuV/m) + Factor\* (dB)

\*Factor includes antenna factor , cable loss and amplifier gain

Note 2: Margin (dB) = Emission level (dBuV/m) – Limit (dBuV/m).



<b>Modulation</b>	HT20	<b>Test Freq. (MHz)</b>	5500
<b>Polarization</b>	Vertical	<b>Test Configuration</b>	2

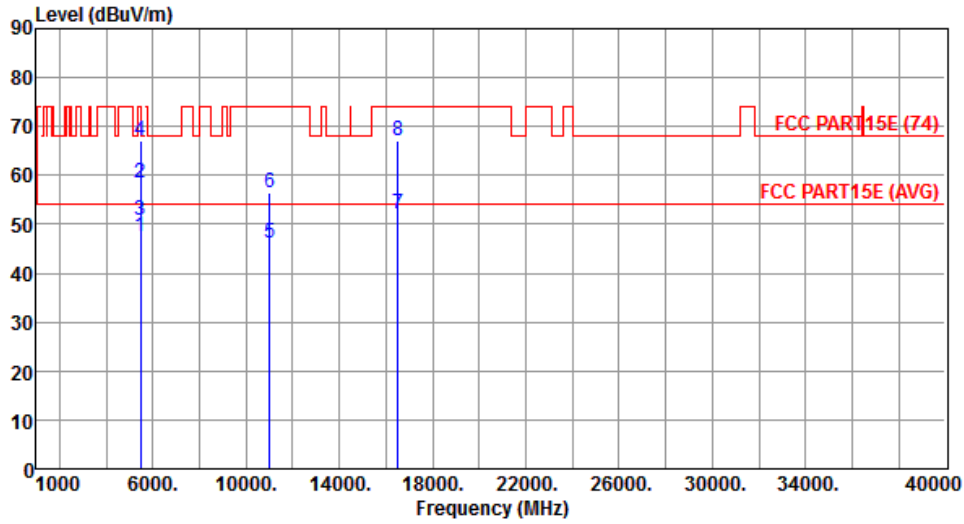

	Freq. MHz	Emission level dBuV/m	Limit dBuV/m	Margin dB	SA reading dBuV	Factor dB	Remark	ANT High cm	Turn Table deg
1	5460.00	47.60	54.00	-6.40	40.84	6.76	Average	395	118
2	5460.00	58.47	74.00	-15.53	51.71	6.76	Peak	395	118
3	5470.00	50.86	54.00	-3.14	44.09	6.77	Average	395	118
4	5470.00	67.08	74.00	-6.92	60.31	6.77	Peak	395	118
5	11000.00	46.26	54.00	-7.74	29.54	16.72	Average	216	4
6	11000.00	56.33	74.00	-17.67	39.61	16.72	Peak	216	4
7	16500.00	52.24	54.00	-1.76	34.37	17.87	Average	158	186
8	16500.00	67.13	74.00	-6.87	49.26	17.87	Peak	158	186

Note 1: Emission Level (dBuV/m) = SA Reading (dBuV/m) + Factor\* (dB)

\*Factor includes antenna factor , cable loss and amplifier gain

Note 2: Margin (dB) = Emission level (dBuV/m) – Limit (dBuV/m).

<b>Modulation</b>	HT20	<b>Test Freq. (MHz)</b>	5580
<b>Polarization</b>	Horizontal	<b>Test Configuration</b>	2

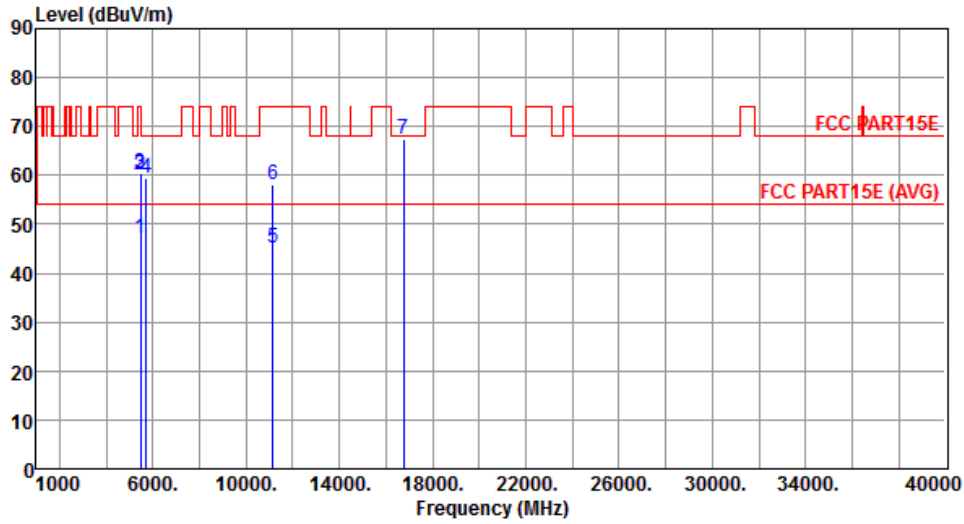

	Freq. MHz	Emission level dBuV/m	Limit dBuV/m	Margin dB	SA reading dBuV	Factor dB	Remark	ANT High cm	Turn Table deg
1	5460.00	47.10	54.00	-6.90	40.34	6.76	Average	250	147
2	5460.00	60.24	74.00	-13.76	53.48	6.76	Peak	250	147
3	5470.00	60.54	68.20	-7.66	53.77	6.77	Peak	250	147
4	5725.00	59.59	68.20	-8.61	52.35	7.24	Peak	250	147
5	11160.00	45.21	54.00	-8.79	28.42	16.79	Average	250	147
6	11160.00	57.96	74.00	-16.04	41.17	16.79	Peak	250	147
7	16740.00	67.53	68.20	-0.67	49.13	18.40	Peak	250	147

Note 1: Emission Level (dBuV/m) = SA Reading (dBuV/m) + Factor\* (dB)

\*Factor includes antenna factor , cable loss and amplifier gain

Note 2: Margin (dB) = Emission level (dBuV/m) – Limit (dBuV/m).

<b>Modulation</b>	HT20	<b>Test Freq. (MHz)</b>	5580
<b>Polarization</b>	Vertical	<b>Test Configuration</b>	2

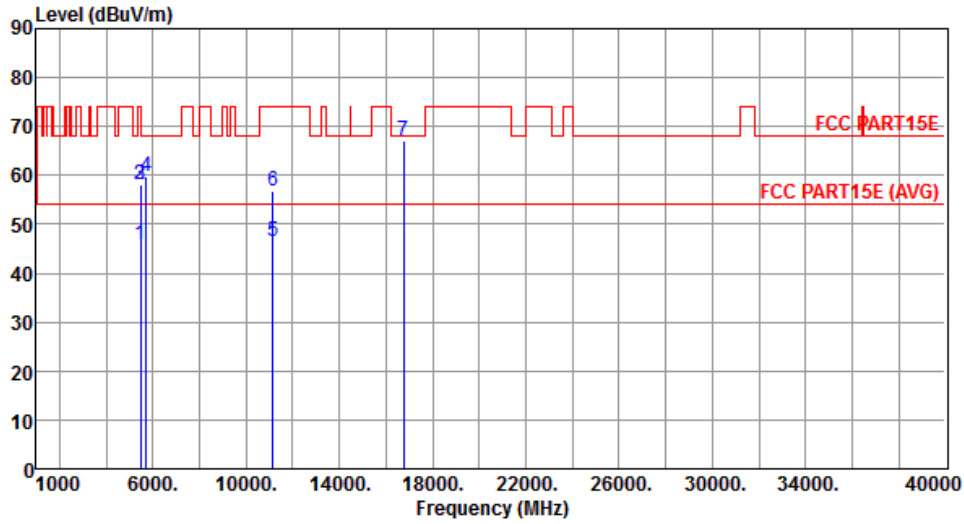

	Freq. MHz	Emission level dBuV/m	Limit dBuV/m	Margin dB	SA reading dBuV	Factor dB	Remark	ANT High cm	Turn Table deg
1	5460.00	45.74	54.00	-8.26	38.98	6.76	Average	253	56
2	5460.00	58.10	74.00	-15.90	51.34	6.76	Peak	253	56
3	5470.00	58.15	68.20	-10.05	51.38	6.77	Peak	253	56
4	5725.00	59.67	68.20	-8.53	52.43	7.24	Peak	150	202
5	11160.00	46.63	54.00	-7.37	29.84	16.79	Average	212	2
6	11160.00	56.67	74.00	-17.33	39.88	16.79	Peak	212	2
7	16740.00	66.93	68.20	-1.27	48.53	18.40	Peak	150	202

Note 1: Emission Level (dBuV/m) = SA Reading (dBuV/m) + Factor\* (dB)

\*Factor includes antenna factor , cable loss and amplifier gain

Note 2: Margin (dB) = Emission level (dBuV/m) – Limit (dBuV/m).

<b>Modulation</b>	HT20	<b>Test Freq. (MHz)</b>	5700
<b>Polarization</b>	Horizontal	<b>Test Configuration</b>	2

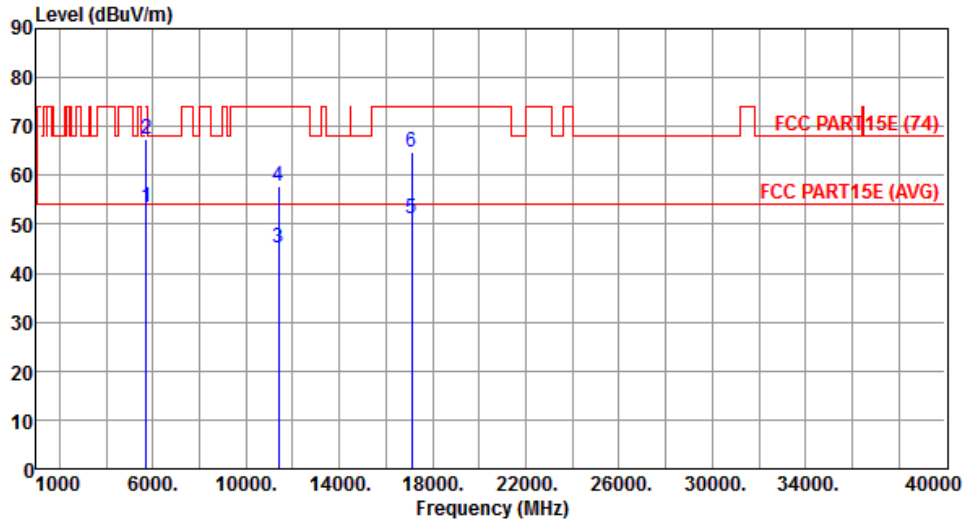

	Freq. MHz	Emission level dBuV/m	Limit dBuV/m	Margin dB	SA reading dBuV	Factor dB	Remark	ANT High cm	Turn Table deg
1	5725.00	53.33	54.00	-0.67	46.09	7.24	Average	150	17
2	5725.00	67.31	74.00	-6.69	60.07	7.24	Peak	150	17
3	11400.00	45.26	54.00	-8.74	28.38	16.88	Average	253	144
4	11400.00	57.64	74.00	-16.36	40.76	16.88	Peak	253	144
5	17100.00	51.13	54.00	-2.87	32.01	19.12	Average	153	138
6	17100.00	64.84	74.00	-9.16	45.72	19.12	Peak	153	138

Note 1: Emission Level (dBuV/m) = SA Reading (dBuV/m) + Factor\* (dB)

\*Factor includes antenna factor , cable loss and amplifier gain

Note 2: Margin (dB) = Emission level (dBuV/m) – Limit (dBuV/m).

<b>Modulation</b>	HT20	<b>Test Freq. (MHz)</b>	5700
<b>Polarization</b>	Vertical	<b>Test Configuration</b>	2

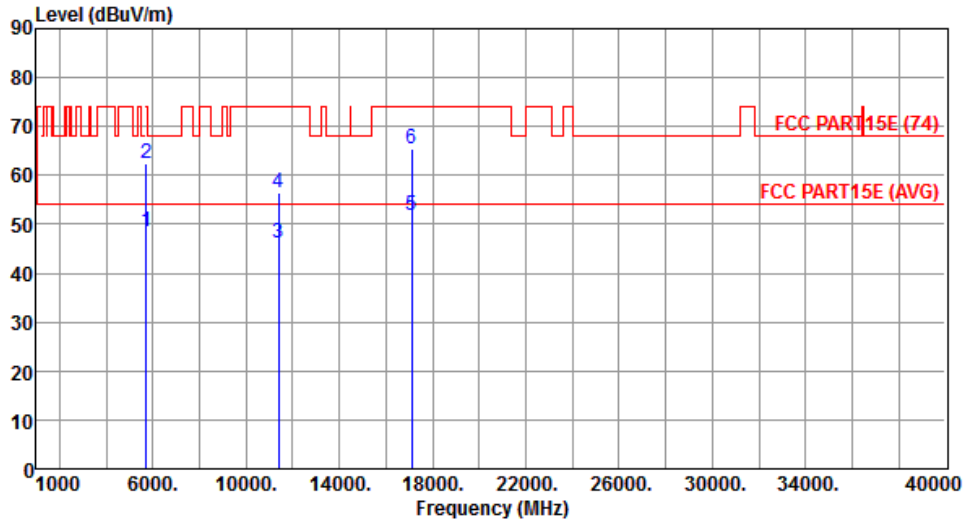

	Freq. MHz	Emission level dBuV/m	Limit dBuV/m	Margin dB	SA reading dBuV	Factor dB	Remark	ANT High cm	Turn Table deg
1	5725.00	48.39	54.00	-5.61	41.15	7.24	Average	380	118
2	5725.00	62.34	74.00	-11.66	55.10	7.24	Peak	380	118
3	11400.00	46.28	54.00	-7.72	29.40	16.88	Average	214	5
4	11400.00	56.54	74.00	-17.46	39.66	16.88	Peak	214	5
5	17100.00	51.72	54.00	-2.28	32.60	19.12	Average	150	211
6	17100.00	65.49	74.00	-8.51	46.37	19.12	Peak	150	211

Note 1: Emission Level (dBuV/m) = SA Reading (dBuV/m) + Factor\* (dB)

\*Factor includes antenna factor , cable loss and amplifier gain

Note 2: Margin (dB) = Emission level (dBuV/m) – Limit (dBuV/m).

<b>Modulation</b>	HT20	<b>Test Freq. (MHz)</b>	5745
<b>Polarization</b>	Horizontal	<b>Test Configuration</b>	2

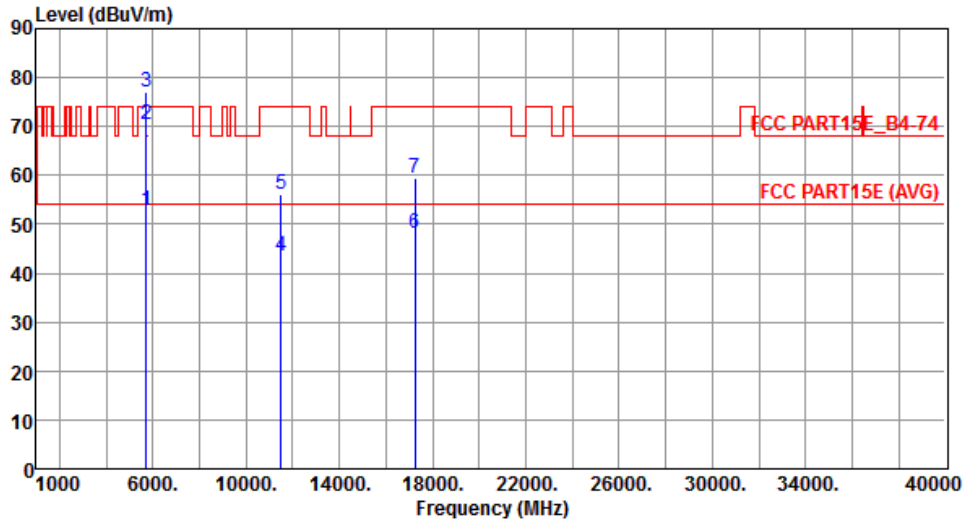

	Freq. MHz	Emission level dBuV/m	Limit dBuV/m	Margin dB	SA reading dBuV	Factor dB	Remark	ANT High cm	Turn Table deg
1	5715.00	52.67	54.00	-1.33	45.47	7.20	Average	188	184
2	5715.00	70.47	74.00	-3.53	63.27	7.20	Peak	188	184
3	5725.00	76.96	78.20	-1.24	69.72	7.24	Peak	188	184
4	11490.00	43.35	54.00	-10.65	26.44	16.91	Average	203	151
5	11490.00	56.07	74.00	-17.93	39.16	16.91	Peak	203	151
6	17235.00	48.20	54.00	-5.80	28.88	19.32	Average	290	106
7	17235.00	59.58	74.00	-14.42	40.26	19.32	Peak	290	106

Note 1: Emission Level (dBuV/m) = SA Reading (dBuV/m) + Factor\* (dB)  
 \*Factor includes antenna factor , cable loss and amplifier gain  
 Note 2: Margin (dB) = Emission level (dBuV/m) – Limit (dBuV/m).

<b>Modulation</b>	HT20	<b>Test Freq. (MHz)</b>	5745
<b>Polarization</b>	Vertical	<b>Test Configuration</b>	2

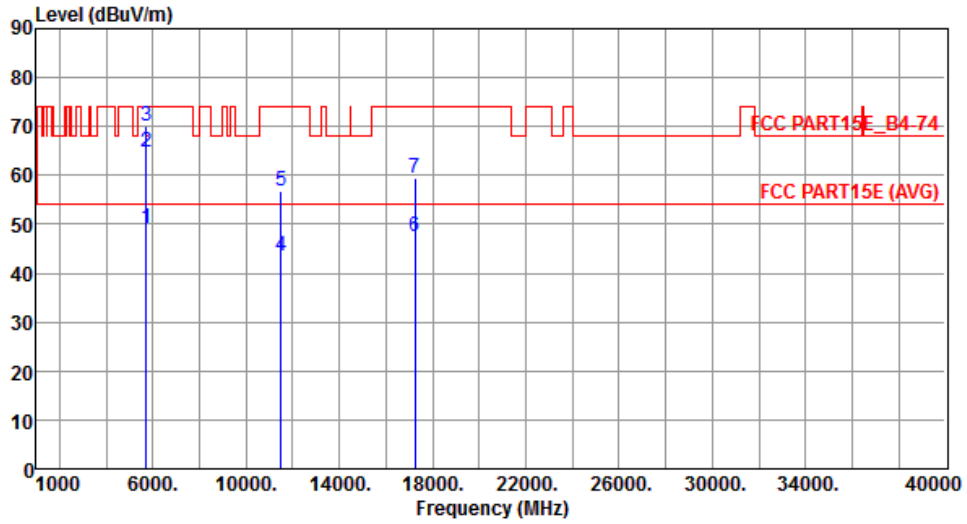

	Freq. MHz	Emission level dBuV/m	Limit dBuV/m	Margin dB	SA reading dBuV	Factor dB	Remark	ANT High cm	Turn Table deg
1	5715.00	49.02	54.00	-4.98	41.82	7.20	Average	377	123
2	5715.00	64.65	74.00	-9.35	57.45	7.20	Peak	377	123
3	5725.00	70.22	78.20	-7.98	62.98	7.24	Peak	377	123
4	11490.00	43.43	54.00	-10.57	26.52	16.91	Average	231	89
5	11490.00	56.70	74.00	-17.30	39.79	16.91	Peak	231	89
6	17235.00	47.42	54.00	-6.58	28.10	19.32	Average	150	203
7	17235.00	59.42	74.00	-14.58	40.10	19.32	Peak	150	203

Note 1: Emission Level (dBuV/m) = SA Reading (dBuV/m) + Factor\* (dB)

\*Factor includes antenna factor , cable loss and amplifier gain

Note 2: Margin (dB) = Emission level (dBuV/m) – Limit (dBuV/m).

<b>Modulation</b>	HT20	<b>Test Freq. (MHz)</b>	5785
<b>Polarization</b>	Horizontal	<b>Test Configuration</b>	2

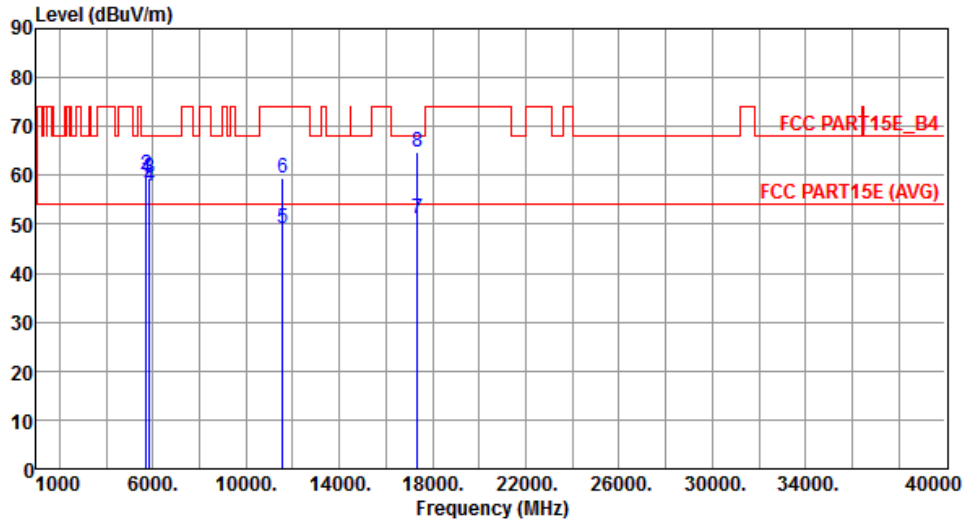

	Freq. MHz	Emission level dBuV/m	Limit dBuV/m	Margin dB	SA reading dBuV	Factor dB	Remark	ANT High cm	Turn Table deg
1	5715.00	59.27	68.20	-8.93	52.07	7.20	Peak	214	332
2	5725.00	59.99	78.20	-18.21	52.75	7.24	Peak	214	332
3	5850.00	59.52	78.20	-18.68	52.02	7.50	Peak	214	332
4	5860.00	57.80	68.20	-10.40	50.29	7.51	Peak	214	332
5	11570.00	49.25	54.00	-4.75	32.45	16.80	Average	234	179
6	11570.00	59.33	74.00	-14.67	42.53	16.80	Peak	234	179
7	17355.00	51.15	54.00	-2.85	31.66	19.49	Average	224	112
8	17355.00	64.80	68.20	-3.40	45.31	19.49	Peak	224	112

Note 1: Emission Level (dBuV/m) = SA Reading (dBuV/m) + Factor\* (dB)

\*Factor includes antenna factor , cable loss and amplifier gain

Note 2: Margin (dB) = Emission level (dBuV/m) – Limit (dBuV/m).



<b>Modulation</b>	HT20	<b>Test Freq. (MHz)</b>	5785
<b>Polarization</b>	Vertical	<b>Test Configuration</b>	2

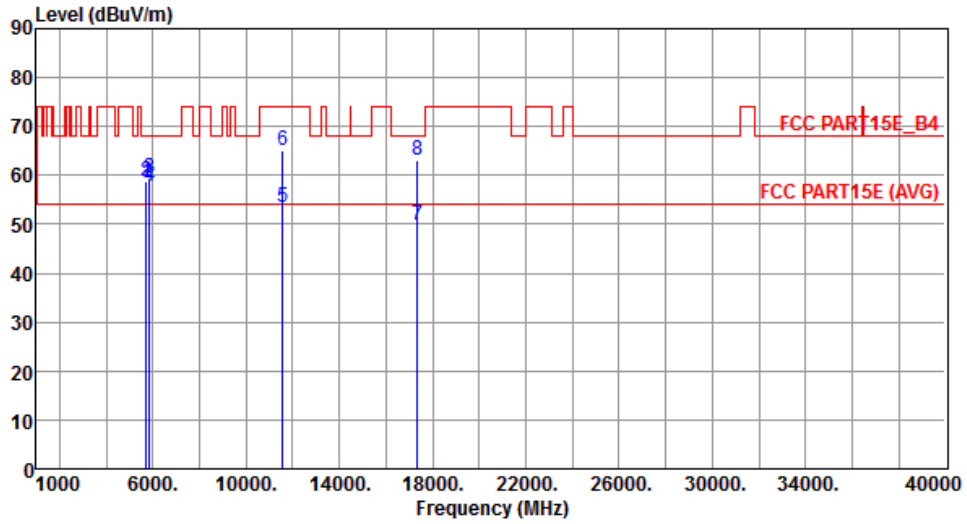

	Freq. MHz	Emission level dBuV/m	Limit dBuV/m	Margin dB	SA reading dBuV	Factor dB	Remark	ANT High cm	Turn Table deg
1	5715.00	58.61	68.20	-9.59	51.41	7.20	Peak	275	71
2	5725.00	58.69	78.20	-19.51	51.45	7.24	Peak	275	71
3	5850.00	59.59	78.20	-18.61	52.09	7.50	Peak	275	71
4	5860.00	57.74	68.20	-10.46	50.23	7.51	Peak	275	71
5	11570.00	53.62	54.00	-0.38	36.82	16.80	Average	150	202
6	11570.00	65.12	74.00	-8.88	48.32	16.80	Peak	150	202
7	17355.00	49.89	54.00	-4.11	30.40	19.49	Average	215	170
8	17355.00	63.15	68.20	-5.05	43.66	19.49	Peak	215	170

Note 1: Emission Level (dBuV/m) = SA Reading (dBuV/m) + Factor\* (dB)

\*Factor includes antenna factor , cable loss and amplifier gain

Note 2: Margin (dB) = Emission level (dBuV/m) – Limit (dBuV/m).

<b>Modulation</b>	HT20	<b>Test Freq. (MHz)</b>	5825
<b>Polarization</b>	Horizontal	<b>Test Configuration</b>	2

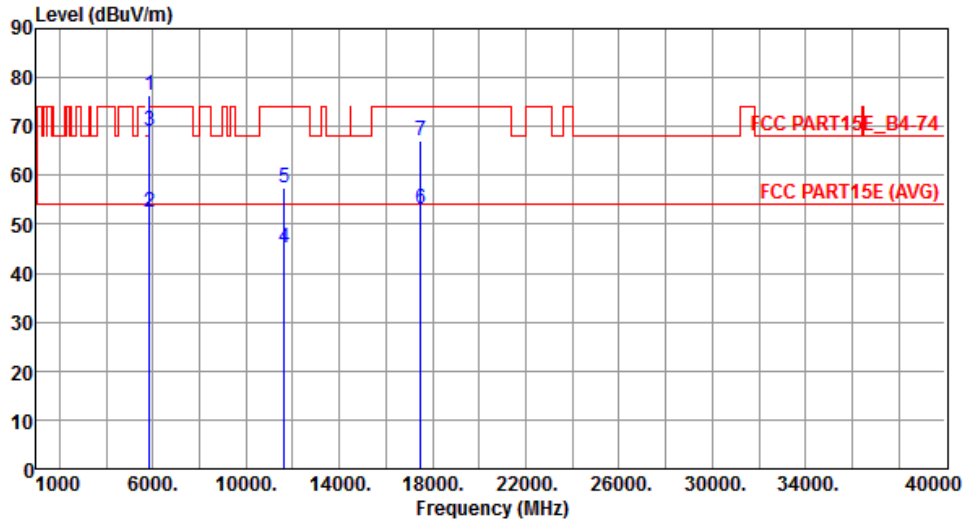

	Freq. MHz	Emission level dBuV/m	Limit dBuV/m	Margin dB	SA reading dBuV	Factor dB	Remark	ANT High cm	Turn Table deg
1	5850.00	76.45	78.20	-1.75	68.95	7.50	Peak	229	198
2	5860.00	52.46	54.00	-1.54	44.95	7.51	Average	229	198
3	5860.00	68.94	74.00	-5.06	61.43	7.51	Peak	229	198
4	11650.00	45.21	54.00	-8.79	28.56	16.65	Average	150	160
5	11650.00	57.50	74.00	-16.50	40.85	16.65	Peak	150	160
6	17475.00	53.11	54.00	-0.89	33.45	19.66	Average	227	139
7	17475.00	66.96	74.00	-7.04	47.30	19.66	Peak	227	139

Note 1: Emission Level (dBuV/m) = SA Reading (dBuV/m) + Factor\* (dB)

\*Factor includes antenna factor , cable loss and amplifier gain

Note 2: Margin (dB) = Emission level (dBuV/m) – Limit (dBuV/m).

<b>Modulation</b>	HT20	<b>Test Freq. (MHz)</b>	5825
<b>Polarization</b>	Vertical	<b>Test Configuration</b>	2

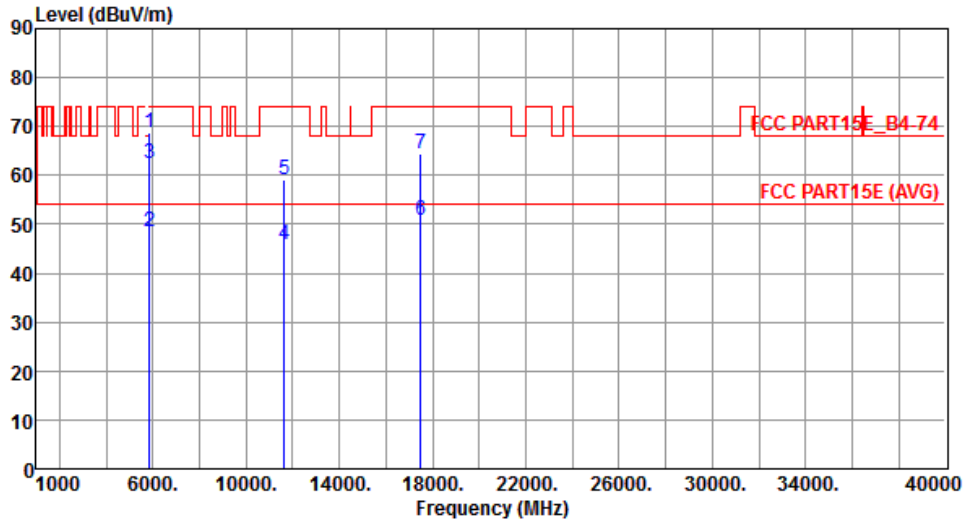

	Freq. MHz	Emission level dBuV/m	Limit dBuV/m	Margin dB	SA reading dBuV	Factor dB	Remark	ANT High cm	Turn Table deg
1	5850.00	68.63	78.20	-9.57	61.13	7.50	Peak	334	122
2	5860.00	48.43	54.00	-5.57	40.92	7.51	Average	334	122
3	5860.00	62.30	74.00	-11.70	54.79	7.51	Peak	334	122
4	11650.00	45.95	54.00	-8.05	29.30	16.65	Average	208	205
5	11650.00	59.15	74.00	-14.85	42.50	16.65	Peak	208	205
6	17475.00	50.89	54.00	-3.11	31.23	19.66	Average	215	169
7	17475.00	64.51	74.00	-9.49	44.85	19.66	Peak	215	169

Note 1: Emission Level (dBuV/m) = SA Reading (dBuV/m) + Factor\* (dB)

\*Factor includes antenna factor , cable loss and amplifier gain

Note 2: Margin (dB) = Emission level (dBuV/m) – Limit (dBuV/m).

### 3.5.11 Transmitter Radiated Unwanted Emissions (Above 1GHz) for HT40

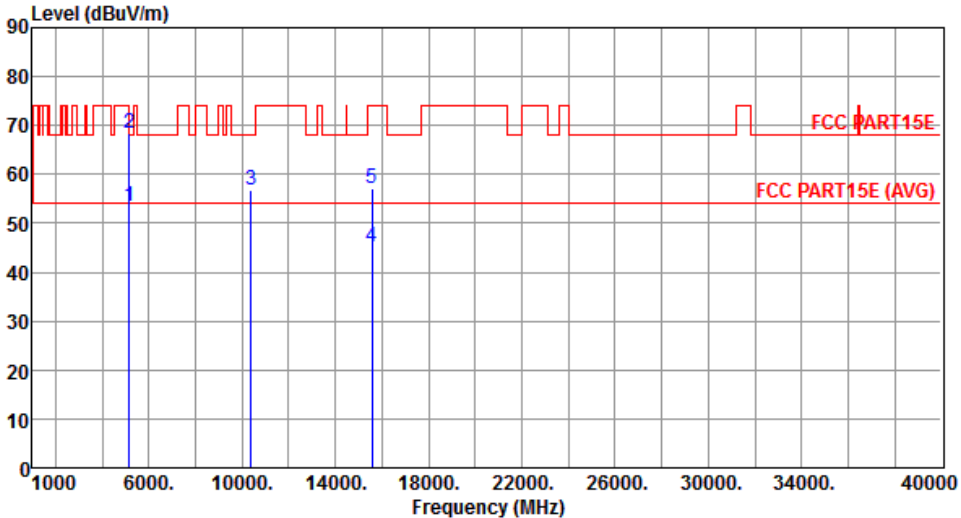
Modulation	HT40	Test Freq. (MHz)	5190																																																																					
Polarization	Horizontal	Test Configuration	2																																																																					
																																																																								
	<table border="1"> <thead> <tr> <th>Freq.</th> <th>Emission level</th> <th>Limit</th> <th>Margin</th> <th>SA reading</th> <th>Factor</th> <th>Remark</th> <th>ANT High</th> <th>Turn Table</th> </tr> <tr> <th>MHz</th> <th>dBuV/m</th> <th>dBuV/m</th> <th>dB</th> <th>dBuV</th> <th>dB</th> <th></th> <th>cm</th> <th>deg</th> </tr> </thead> <tbody> <tr> <td>1</td> <td>5150.00</td> <td>53.34</td> <td>54.00</td> <td>-0.66</td> <td>47.03</td> <td>6.31</td> <td>Average</td> <td>150</td> <td>204</td> </tr> <tr> <td>2</td> <td>5150.00</td> <td>68.32</td> <td>74.00</td> <td>-5.68</td> <td>62.01</td> <td>6.31</td> <td>Peak</td> <td>150</td> <td>204</td> </tr> <tr> <td>3</td> <td>10380.00</td> <td>56.63</td> <td>68.20</td> <td>-11.57</td> <td>40.26</td> <td>16.37</td> <td>Peak</td> <td>294</td> <td>175</td> </tr> <tr> <td>4</td> <td>15570.00</td> <td>45.09</td> <td>54.00</td> <td>-8.91</td> <td>27.66</td> <td>17.43</td> <td>Average</td> <td>170</td> <td>204</td> </tr> <tr> <td>5</td> <td>15570.00</td> <td>57.02</td> <td>74.00</td> <td>-16.98</td> <td>39.59</td> <td>17.43</td> <td>Peak</td> <td>170</td> <td>204</td> </tr> </tbody> </table>	Freq.	Emission level	Limit	Margin	SA reading	Factor	Remark	ANT High	Turn Table	MHz	dBuV/m	dBuV/m	dB	dBuV	dB		cm	deg	1	5150.00	53.34	54.00	-0.66	47.03	6.31	Average	150	204	2	5150.00	68.32	74.00	-5.68	62.01	6.31	Peak	150	204	3	10380.00	56.63	68.20	-11.57	40.26	16.37	Peak	294	175	4	15570.00	45.09	54.00	-8.91	27.66	17.43	Average	170	204	5	15570.00	57.02	74.00	-16.98	39.59	17.43	Peak	170	204			
Freq.	Emission level	Limit	Margin	SA reading	Factor	Remark	ANT High	Turn Table																																																																
MHz	dBuV/m	dBuV/m	dB	dBuV	dB		cm	deg																																																																
1	5150.00	53.34	54.00	-0.66	47.03	6.31	Average	150	204																																																															
2	5150.00	68.32	74.00	-5.68	62.01	6.31	Peak	150	204																																																															
3	10380.00	56.63	68.20	-11.57	40.26	16.37	Peak	294	175																																																															
4	15570.00	45.09	54.00	-8.91	27.66	17.43	Average	170	204																																																															
5	15570.00	57.02	74.00	-16.98	39.59	17.43	Peak	170	204																																																															
<p>Note 1: Emission Level (dBuV/m) = SA Reading (dBuV/m) + Factor* (dB)            *Factor includes antenna factor , cable loss and amplifier gain            Note 2: Margin (dB) = Emission level (dBuV/m) – Limit (dBuV/m).</p>																																																																								

<b>Modulation</b>	HT40	<b>Test Freq. (MHz)</b>	5190
<b>Polarization</b>	Vertical	<b>Test Configuration</b>	2

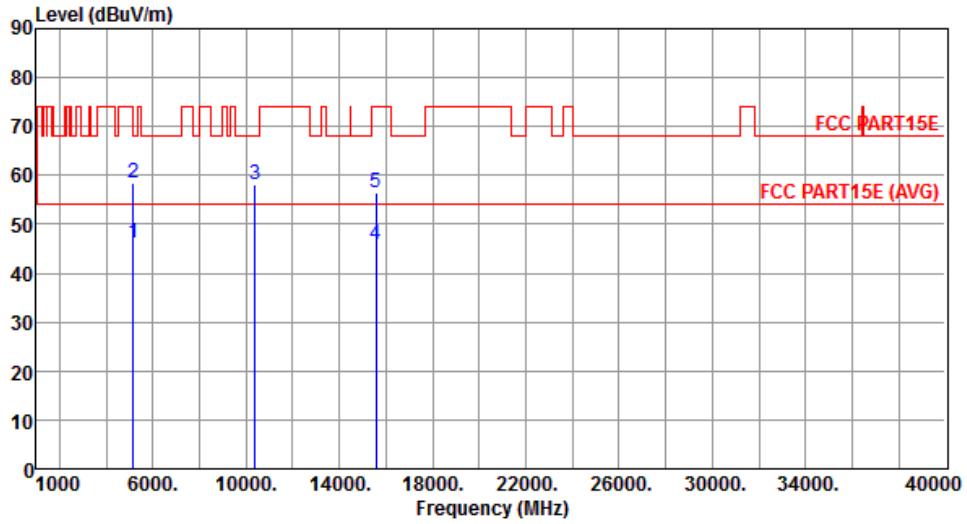

	Freq. MHz	Emission level dBuV/m	Limit dBuV/m	Margin dB	SA reading dBuV	Factor dB	Remark	ANT High cm	Turn Table deg
1	5150.00	46.02	54.00	-7.98	39.71	6.31	Average	295	80
2	5150.00	58.41	74.00	-15.59	52.10	6.31	Peak	295	80
3	10380.00	58.10	68.20	-10.10	41.73	16.37	Peak	343	211
4	15570.00	45.72	54.00	-8.28	28.29	17.43	Average	150	204
5	15570.00	56.61	74.00	-17.39	39.18	17.43	Peak	150	204

Note 1: Emission Level (dBuV/m) = SA Reading (dBuV/m) + Factor\* (dB)

\*Factor includes antenna factor , cable loss and amplifier gain

Note 2: Margin (dB) = Emission level (dBuV/m) – Limit (dBuV/m).

<b>Modulation</b>	HT40	<b>Test Freq. (MHz)</b>	5230
<b>Polarization</b>	Horizontal	<b>Test Configuration</b>	2

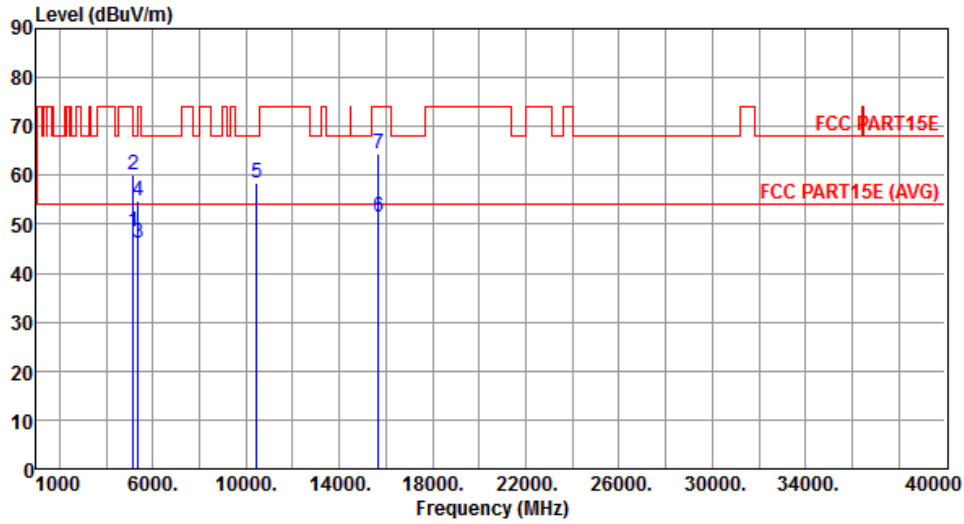

	Freq. MHz	Emission level dBuV/m	Limit dBuV/m	Margin dB	SA reading dBuV	Factor dB	Remark	ANT High cm	Turn Table deg
1	5150.00	48.60	54.00	-5.40	42.29	6.31	Average	150	7
2	5150.00	60.14	74.00	-13.86	53.83	6.31	Peak	150	7
3	5350.00	46.32	54.00	-7.68	39.70	6.62	Average	150	7
4	5350.00	54.92	74.00	-19.08	48.30	6.62	Peak	150	7
5	10460.00	58.30	68.20	-9.90	41.77	16.53	Peak	172	166
6	15690.00	51.62	54.00	-2.38	34.40	17.22	Average	276	142
7	15690.00	64.35	74.00	-9.65	47.13	17.22	Peak	276	142

Note 1: Emission Level (dBuV/m) = SA Reading (dBuV/m) + Factor\* (dB)

\*Factor includes antenna factor , cable loss and amplifier gain

Note 2: Margin (dB) = Emission level (dBuV/m) – Limit (dBuV/m).

<b>Modulation</b>	HT40	<b>Test Freq. (MHz)</b>	5230
<b>Polarization</b>	Vertical	<b>Test Configuration</b>	2

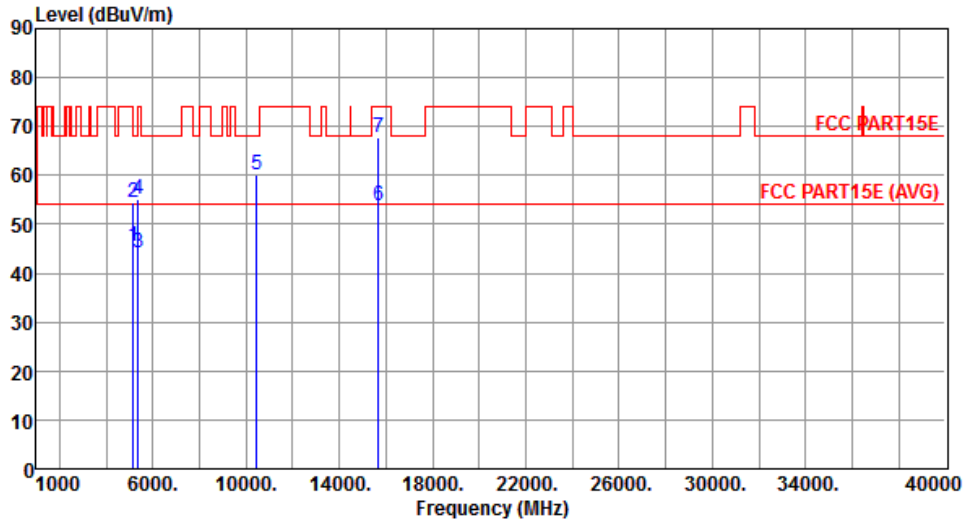

	Freq. MHz	Emission level dBuV/m	Limit dBuV/m	Margin dB	SA reading dBuV	Factor dB	Remark	ANT High cm	Turn Table deg
1	5150.00	45.65	54.00	-8.35	39.34	6.31	Average	375	295
2	5150.00	54.59	74.00	-19.41	48.28	6.31	Peak	375	295
3	5350.00	44.18	54.00	-9.82	37.56	6.62	Average	375	295
4	5350.00	55.00	74.00	-19.00	48.38	6.62	Peak	375	295
5	10460.00	60.07	68.20	-8.13	43.54	16.53	Peak	376	215
6	15690.00	53.70	54.00	-0.30	36.48	17.22	Average	150	188
7	15690.00	67.86	74.00	-6.14	50.64	17.22	Peak	150	188

Note 1: Emission Level (dBuV/m) = SA Reading (dBuV/m) + Factor\* (dB)

\*Factor includes antenna factor , cable loss and amplifier gain

Note 2: Margin (dB) = Emission level (dBuV/m) – Limit (dBuV/m).

<b>Modulation</b>	HT40	<b>Test Freq. (MHz)</b>	5270
<b>Polarization</b>	Horizontal	<b>Test Configuration</b>	2

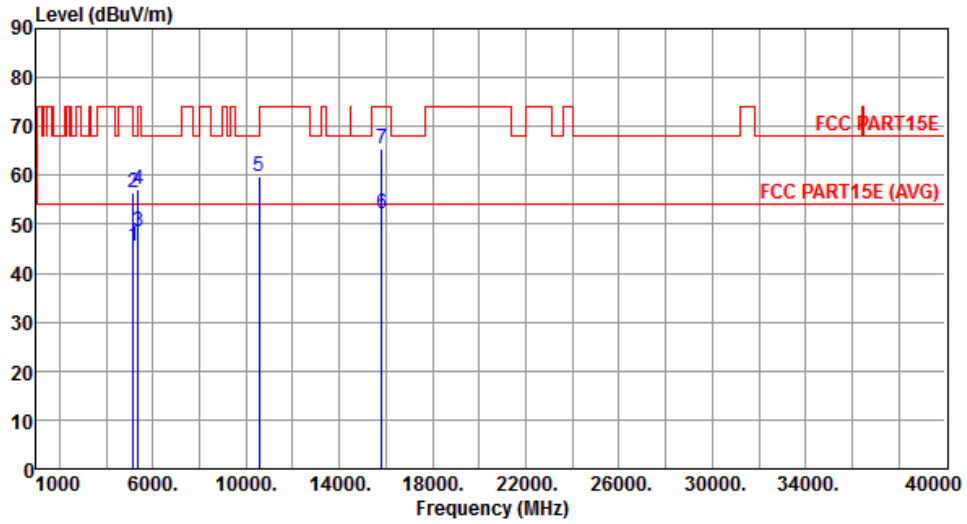

	Freq. MHz	Emission level dBuV/m	Limit dBuV/m	Margin dB	SA reading dBuV	Factor dB	Remark	ANT High cm	Turn Table deg
1	5150.00	45.64	54.00	-8.36	39.33	6.31	Average	209	203
2	5150.00	56.59	74.00	-17.41	50.28	6.31	Peak	209	203
3	5350.00	48.54	54.00	-5.46	41.92	6.62	Average	209	203
4	5350.00	57.27	74.00	-16.73	50.65	6.62	Peak	209	203
5	10540.00	59.87	68.20	-8.33	43.27	16.60	Peak	168	165
6	15810.00	52.19	54.00	-1.81	35.21	16.98	Average	192	130
7	15810.00	65.36	74.00	-8.64	48.38	16.98	Peak	192	130

Note 1: Emission Level (dBuV/m) = SA Reading (dBuV/m) + Factor\* (dB)

\*Factor includes antenna factor , cable loss and amplifier gain

Note 2: Margin (dB) = Emission level (dBuV/m) – Limit (dBuV/m).



<b>Modulation</b>	HT40	<b>Test Freq. (MHz)</b>	5270
<b>Polarization</b>	Vertical	<b>Test Configuration</b>	2

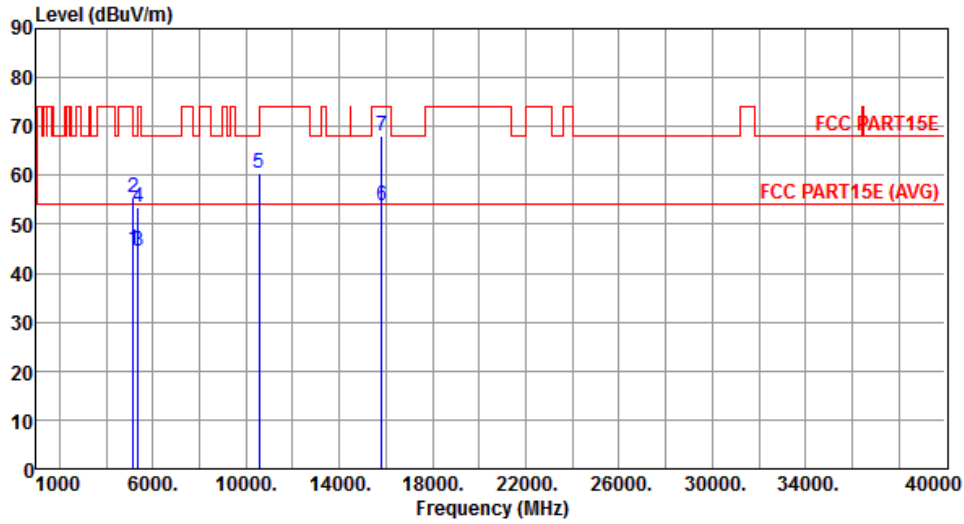

	Freq. MHz	Emission level dBuV/m	Limit dBuV/m	Margin dB	SA reading dBuV	Factor dB	Remark	ANT High cm	Turn Table deg
1	5150.00	44.80	54.00	-9.20	38.49	6.31	Average	359	209
2	5150.00	55.38	74.00	-18.62	49.07	6.31	Peak	359	209
3	5350.00	44.51	54.00	-9.49	37.89	6.62	Average	359	209
4	5350.00	53.32	74.00	-20.68	46.70	6.62	Peak	359	209
5	10540.00	60.56	68.20	-7.64	43.96	16.60	Peak	400	204
6	15810.00	53.67	54.00	-0.33	36.69	16.98	Average	150	189
7	15810.00	68.20	74.00	-5.80	51.22	16.98	Peak	150	189

Note 1: Emission Level (dBuV/m) = SA Reading (dBuV/m) + Factor\* (dB)

\*Factor includes antenna factor , cable loss and amplifier gain

Note 2: Margin (dB) = Emission level (dBuV/m) – Limit (dBuV/m).

<b>Modulation</b>	HT40	<b>Test Freq. (MHz)</b>	5310
<b>Polarization</b>	Horizontal	<b>Test Configuration</b>	2

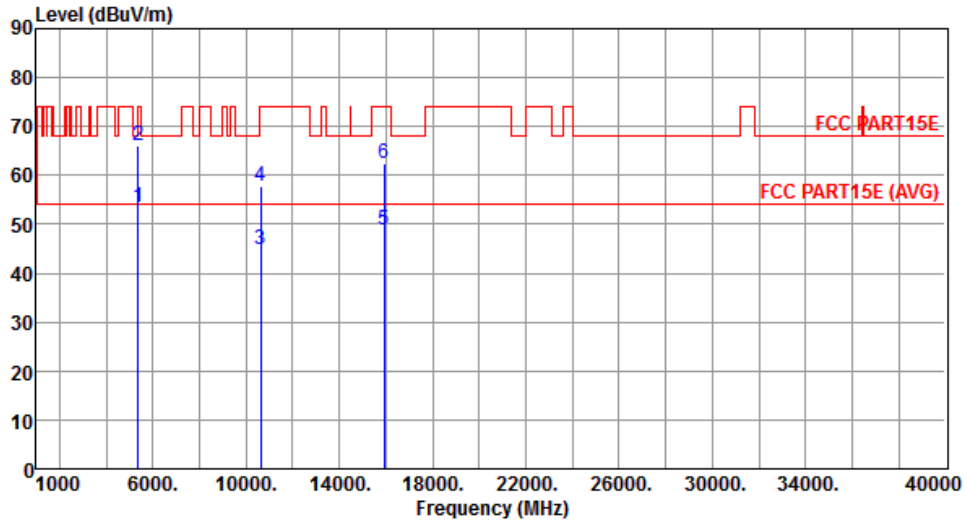

	Freq. MHz	Emission level dBuV/m	Limit dBuV/m	Margin dB	SA reading dBuV	Factor dB	Remark	ANT High cm	Turn Table deg
1	5350.00	53.32	54.00	-0.68	46.70	6.62	Average	202	347
2	5350.00	66.16	74.00	-7.84	59.54	6.62	Peak	202	347
3	10620.00	44.89	54.00	-9.11	28.27	16.62	Average	171	162
4	10620.00	57.75	74.00	-16.25	41.13	16.62	Peak	171	162
5	15930.00	48.87	54.00	-5.13	32.10	16.77	Average	236	131
6	15930.00	62.54	74.00	-11.46	45.77	16.77	Peak	236	131

Note 1: Emission Level (dBuV/m) = SA Reading (dBuV/m) + Factor\* (dB)

\*Factor includes antenna factor , cable loss and amplifier gain

Note 2: Margin (dB) = Emission level (dBuV/m) – Limit (dBuV/m).

<b>Modulation</b>	HT40	<b>Test Freq. (MHz)</b>	5310
<b>Polarization</b>	Vertical	<b>Test Configuration</b>	2

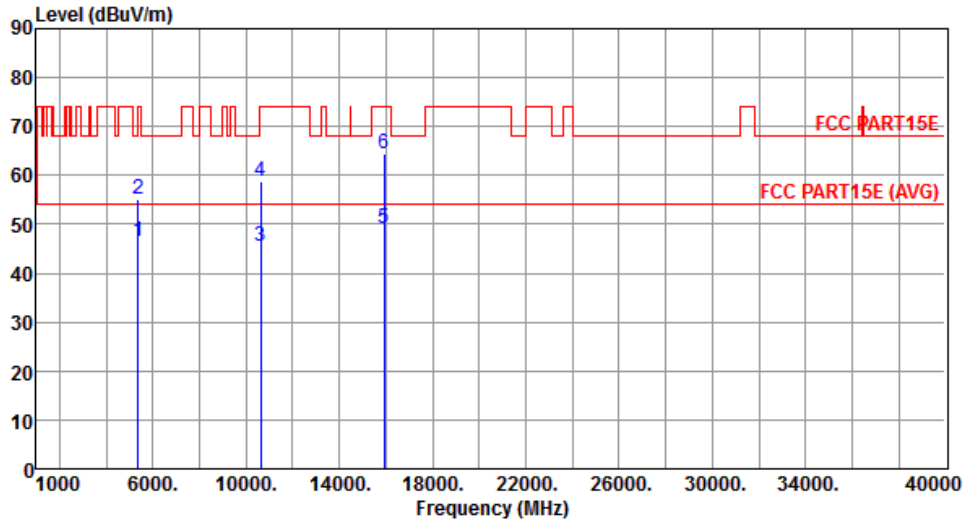

	Freq. MHz	Emission level dBuV/m	Limit dBuV/m	Margin dB	SA reading dBuV	Factor dB	Remark	ANT High cm	Turn Table deg
1	5350.00	46.42	54.00	-7.58	39.80	6.62	Average	280	79
2	5350.00	54.98	74.00	-19.02	48.36	6.62	Peak	280	79
3	10620.00	45.58	54.00	-8.42	28.96	16.62	Average	385	184
4	10620.00	58.68	74.00	-15.32	42.06	16.62	Peak	385	184
5	15930.00	49.27	54.00	-4.73	32.50	16.77	Average	152	190
6	15930.00	64.35	74.00	-9.65	47.58	16.77	Peak	152	190

Note 1: Emission Level (dBuV/m) = SA Reading (dBuV/m) + Factor\* (dB)

\*Factor includes antenna factor , cable loss and amplifier gain

Note 2: Margin (dB) = Emission level (dBuV/m) – Limit (dBuV/m).

<b>Modulation</b>	HT40	<b>Test Freq. (MHz)</b>	5510
<b>Polarization</b>	Horizontal	<b>Test Configuration</b>	2

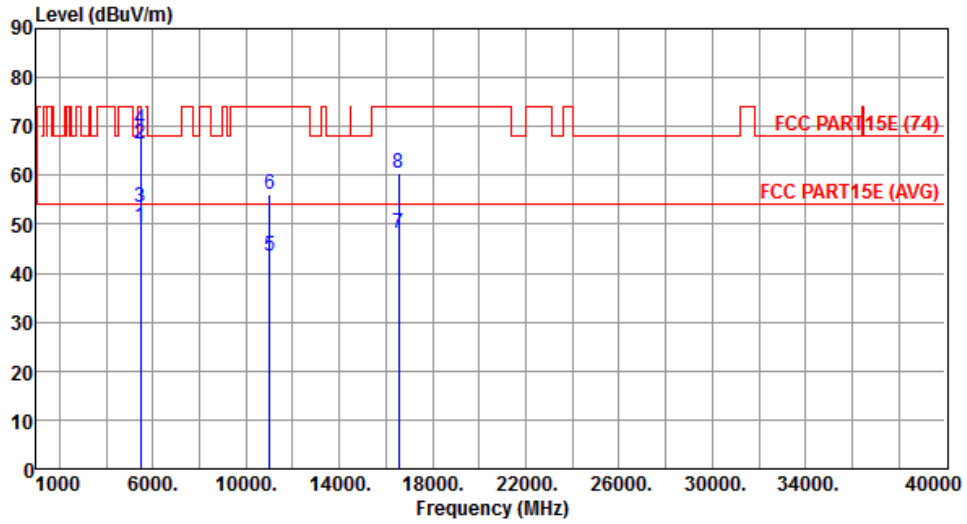

	Freq. MHz	Emission level dBuV/m	Limit dBuV/m	Margin dB	SA reading dBuV	Factor dB	Remark	ANT High cm	Turn Table deg
1	5460.00	49.63	54.00	-4.37	42.87	6.76	Average	243	184
2	5460.00	66.48	74.00	-7.52	59.72	6.76	Peak	243	184
3	5470.00	53.63	54.00	-0.37	46.86	6.77	Average	243	184
4	5470.00	69.34	74.00	-4.66	62.57	6.77	Peak	243	184
5	11020.00	43.46	54.00	-10.54	26.73	16.73	Average	170	160
6	11020.00	56.18	74.00	-17.82	39.45	16.73	Peak	170	160
7	16530.00	48.05	54.00	-5.95	30.11	17.94	Average	150	127
8	16530.00	60.57	74.00	-13.43	42.63	17.94	Peak	150	127

Note 1: Emission Level (dBuV/m) = SA Reading (dBuV/m) + Factor\* (dB)

\*Factor includes antenna factor , cable loss and amplifier gain

Note 2: Margin (dB) = Emission level (dBuV/m) – Limit (dBuV/m).

<b>Modulation</b>	HT40	<b>Test Freq. (MHz)</b>	5510
<b>Polarization</b>	Vertical	<b>Test Configuration</b>	2

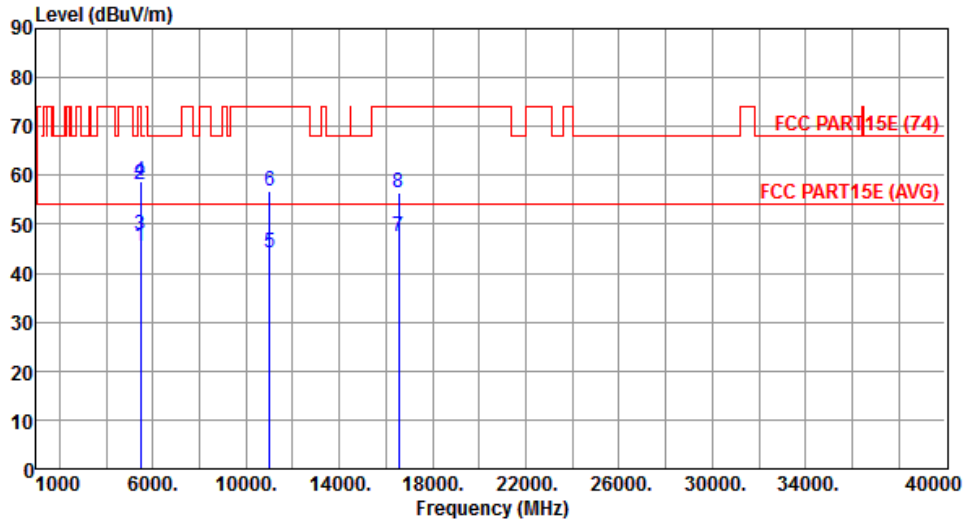

	Freq. MHz	Emission level dBuV/m	Limit dBuV/m	Margin dB	SA reading dBuV	Factor dB	Remark	ANT High cm	Turn Table deg
1	5460.00	45.65	54.00	-8.35	38.89	6.76	Average	250	109
2	5460.00	58.05	74.00	-15.95	51.29	6.76	Peak	250	109
3	5470.00	47.76	54.00	-6.24	40.99	6.77	Average	250	109
4	5470.00	58.84	74.00	-15.16	52.07	6.77	Peak	250	109
5	11020.00	44.03	54.00	-9.97	27.30	16.73	Average	384	192
6	11020.00	56.93	74.00	-17.07	40.20	16.73	Peak	384	192
7	16530.00	47.44	54.00	-6.56	29.50	17.94	Average	150	191
8	16530.00	56.54	74.00	-17.46	38.60	17.94	Peak	150	191

Note 1: Emission Level (dBuV/m) = SA Reading (dBuV/m) + Factor\* (dB)

\*Factor includes antenna factor , cable loss and amplifier gain

Note 2: Margin (dB) = Emission level (dBuV/m) – Limit (dBuV/m).

<b>Modulation</b>	HT40	<b>Test Freq. (MHz)</b>	5590
<b>Polarization</b>	Horizontal	<b>Test Configuration</b>	2

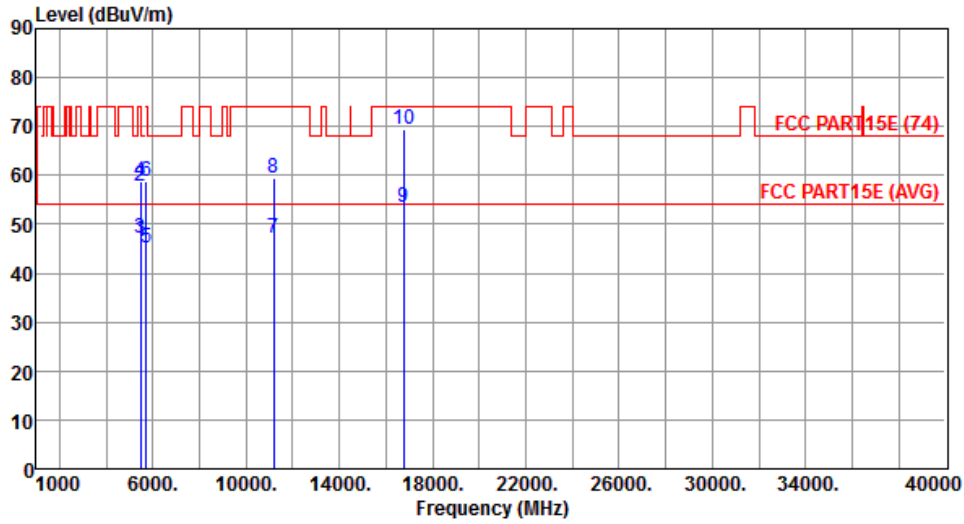

	Freq. MHz	Emission level dBuV/m	Limit dBuV/m	Margin dB	SA reading dBuV	Factor dB	Remark	ANT High cm	Turn Table deg
1	5460.00	46.71	54.00	-7.29	39.95	6.76	Average	155	19
2	5460.00	57.91	74.00	-16.09	51.15	6.76	Peak	155	19
3	5470.00	47.02	54.00	-6.98	40.25	6.77	Average	155	19
4	5470.00	58.71	74.00	-15.29	51.94	6.77	Peak	155	19
5	5725.00	45.16	54.00	-8.84	37.92	7.24	Average	150	211
6	5725.00	58.77	74.00	-15.23	51.53	7.24	Peak	150	211
7	11180.00	47.00	54.00	-7.00	30.21	16.79	Average	172	226
8	11180.00	59.38	74.00	-14.62	42.59	16.79	Peak	172	226
9	16770.00	53.53	54.00	-0.47	35.06	18.47	Average	226	132
10	16770.00	69.46	74.00	-4.54	50.99	18.47	Peak	226	132

Note 1: Emission Level (dBuV/m) = SA Reading (dBuV/m) + Factor\* (dB)

\*Factor includes antenna factor , cable loss and amplifier gain

Note 2: Margin (dB) = Emission level (dBuV/m) – Limit (dBuV/m).

<b>Modulation</b>	HT40	<b>Test Freq. (MHz)</b>	5590
<b>Polarization</b>	Vertical	<b>Test Configuration</b>	2

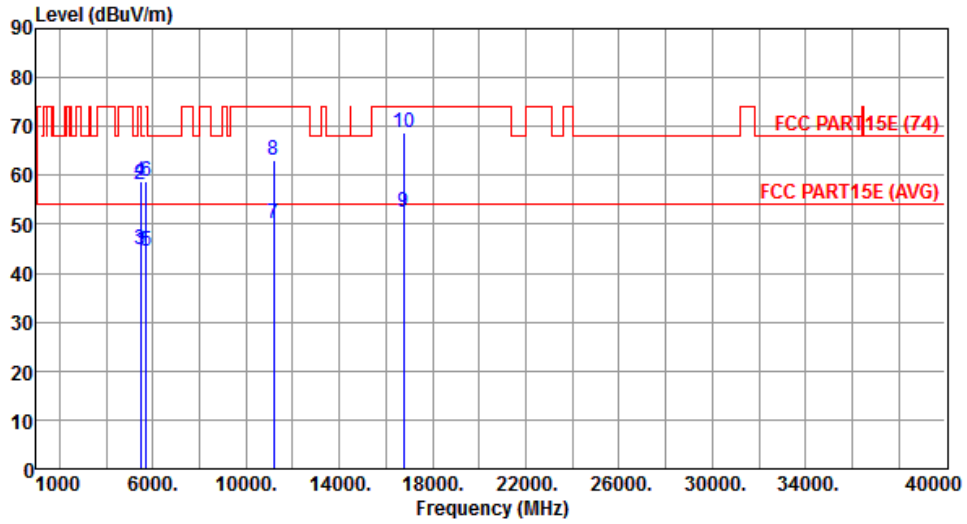

	Freq. MHz	Emission level dBuV/m	Limit dBuV/m	Margin dB	SA reading dBuV	Factor dB	Remark	ANT High cm	Turn Table deg
1	5460.00	44.34	54.00	-9.66	37.58	6.76	Average	150	199
2	5460.00	58.18	74.00	-15.82	51.42	6.76	Peak	150	199
3	5470.00	44.79	54.00	-9.21	38.02	6.77	Average	150	199
4	5470.00	58.62	74.00	-15.38	51.85	6.77	Peak	150	199
5	5725.00	44.67	54.00	-9.33	37.43	7.24	Average	150	132
6	5725.00	58.83	74.00	-15.17	51.59	7.24	Peak	150	132
7	11180.00	50.11	54.00	-3.89	33.32	16.79	Average	150	176
8	11180.00	63.01	74.00	-10.99	46.22	16.79	Peak	150	176
9	16770.00	52.46	54.00	-1.54	33.99	18.47	Average	150	211
10	16770.00	68.63	74.00	-5.37	50.16	18.47	Peak	150	211

Note 1: Emission Level (dBuV/m) = SA Reading (dBuV/m) + Factor\* (dB)

\*Factor includes antenna factor , cable loss and amplifier gain

Note 2: Margin (dB) = Emission level (dBuV/m) – Limit (dBuV/m).

<b>Modulation</b>	HT40	<b>Test Freq. (MHz)</b>	5670
<b>Polarization</b>	Horizontal	<b>Test Configuration</b>	2

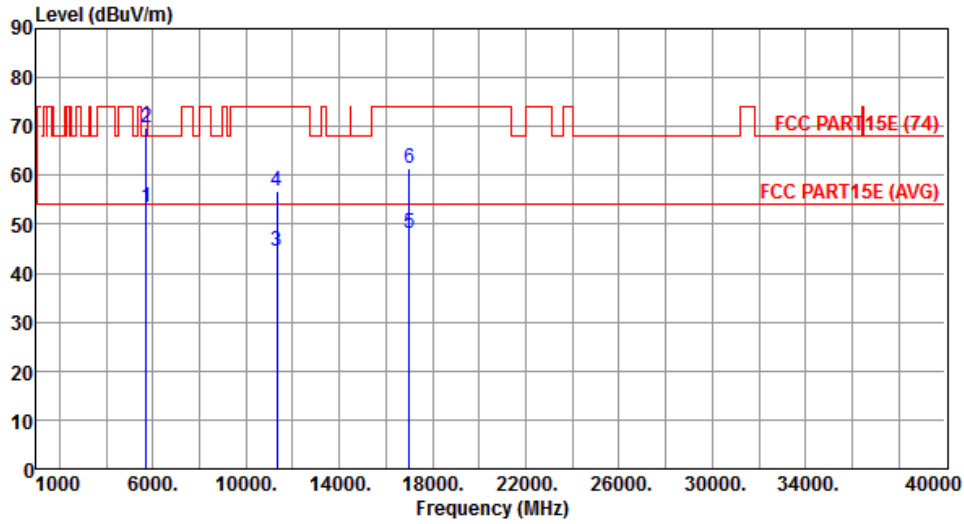

	Freq. MHz	Emission level dBuV/m	Limit dBuV/m	Margin dB	SA reading dBuV	Factor dB	Remark	ANT High cm	Turn Table deg
1	5725.00	53.32	54.00	-0.68	46.08	7.24	Average	180	342
2	5725.00	69.83	74.00	-4.17	62.59	7.24	Peak	180	342
3	11340.00	44.39	54.00	-9.61	27.54	16.85	Average	235	165
4	11340.00	56.84	74.00	-17.16	39.99	16.85	Peak	235	165
5	17010.00	48.31	54.00	-5.69	29.32	18.99	Average	221	135
6	17010.00	61.50	74.00	-12.50	42.51	18.99	Peak	221	135

Note 1: Emission Level (dBuV/m) = SA Reading (dBuV/m) + Factor\* (dB)

\*Factor includes antenna factor , cable loss and amplifier gain

Note 2: Margin (dB) = Emission level (dBuV/m) – Limit (dBuV/m).



<b>Modulation</b>	HT40	<b>Test Freq. (MHz)</b>	5670
<b>Polarization</b>	Vertical	<b>Test Configuration</b>	2

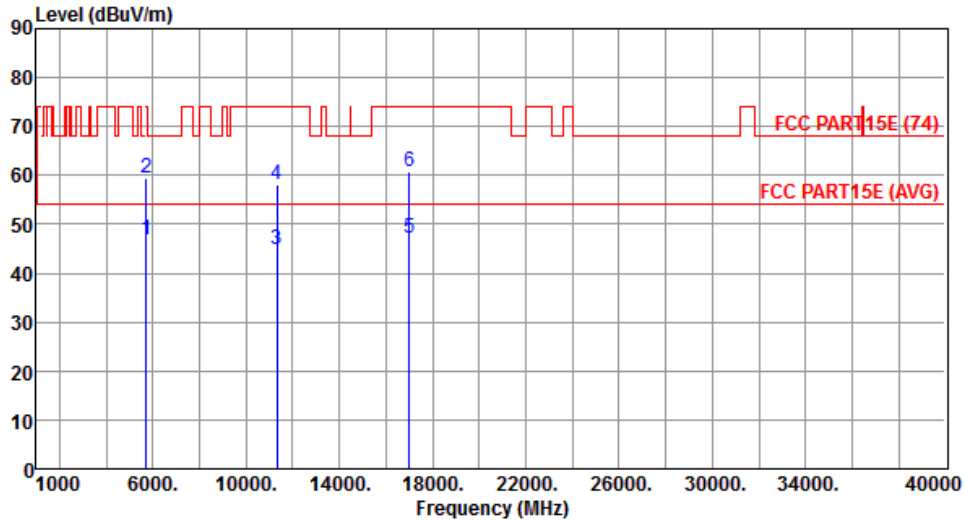

	Freq. MHz	Emission level dBuV/m	Limit dBuV/m	Margin dB	SA reading dBuV	Factor dB	Remark	ANT High cm	Turn Table deg
1	5725.00	46.75	54.00	-7.25	39.51	7.24	Average	182	44
2	5725.00	59.35	74.00	-14.65	52.11	7.24	Peak	182	44
3	11340.00	44.97	54.00	-9.03	28.12	16.85	Average	220	197
4	11340.00	58.15	74.00	-15.85	41.30	16.85	Peak	220	197
5	17010.00	47.31	54.00	-6.69	28.32	18.99	Average	155	201
6	17010.00	60.64	74.00	-13.36	41.65	18.99	Peak	155	201

Note 1: Emission Level (dBuV/m) = SA Reading (dBuV/m) + Factor\* (dB)

\*Factor includes antenna factor , cable loss and amplifier gain

Note 2: Margin (dB) = Emission level (dBuV/m) – Limit (dBuV/m).

<b>Modulation</b>	HT40	<b>Test Freq. (MHz)</b>	5755
<b>Polarization</b>	Horizontal	<b>Test Configuration</b>	2

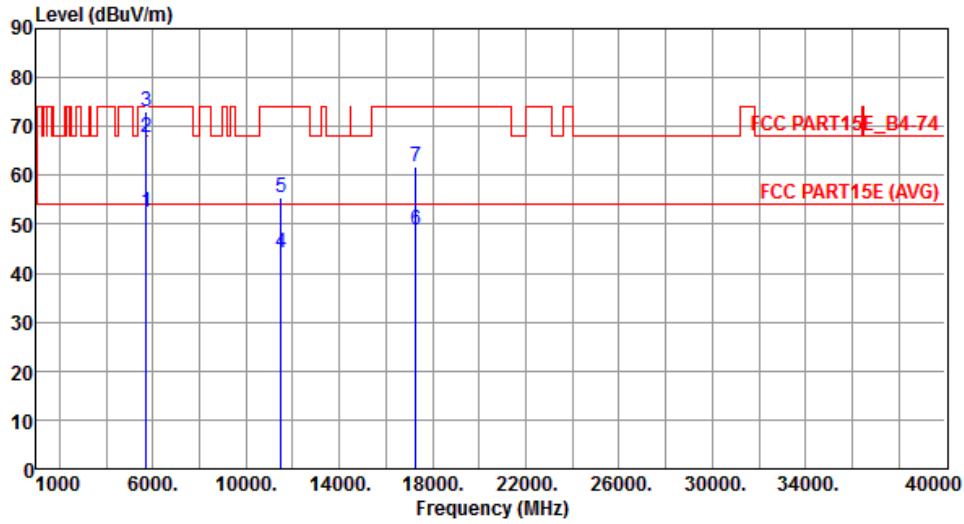

	Freq. MHz	Emission level dBuV/m	Limit dBuV/m	Margin dB	SA reading dBuV	Factor dB	Remark	ANT High cm	Turn Table deg
1	5715.00	52.44	54.00	-1.56	45.24	7.20	Average	237	190
2	5715.00	67.88	74.00	-6.12	60.68	7.20	Peak	237	190
3	5725.00	73.00	78.20	-5.20	65.76	7.24	Peak	237	190
4	11510.00	44.06	54.00	-9.94	27.16	16.90	Average	163	221
5	11510.00	55.59	74.00	-18.41	38.69	16.90	Peak	163	221
6	17265.00	48.89	54.00	-5.11	29.53	19.36	Average	215	141
7	17265.00	61.68	74.00	-12.32	42.32	19.36	Peak	215	141

Note 1: Emission Level (dBuV/m) = SA Reading (dBuV/m) + Factor\* (dB)  
 \*Factor includes antenna factor , cable loss and amplifier gain  
 Note 2: Margin (dB) = Emission level (dBuV/m) – Limit (dBuV/m).

<b>Modulation</b>	HT40	<b>Test Freq. (MHz)</b>	5755
<b>Polarization</b>	Vertical	<b>Test Configuration</b>	2

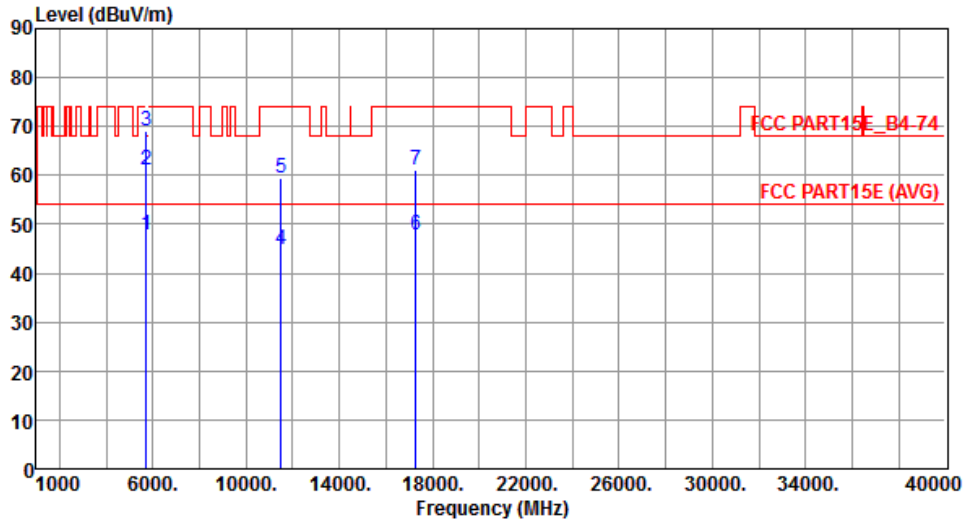

	Freq. MHz	Emission level dBuV/m	Limit dBuV/m	Margin dB	SA reading dBuV	Factor dB	Remark	ANT High cm	Turn Table deg
1	5715.00	47.80	54.00	-6.20	40.60	7.20	Average	227	95
2	5715.00	60.97	74.00	-13.03	53.77	7.20	Peak	227	95
3	5725.00	69.21	78.20	-8.99	61.97	7.24	Peak	227	95
4	11510.00	44.79	54.00	-9.21	27.89	16.90	Average	252	136
5	11510.00	59.43	74.00	-14.57	42.53	16.90	Peak	252	136
6	17265.00	47.82	54.00	-6.18	28.46	19.36	Average	276	159
7	17265.00	61.05	74.00	-12.95	41.69	19.36	Peak	276	159

Note 1: Emission Level (dBuV/m) = SA Reading (dBuV/m) + Factor\* (dB)

\*Factor includes antenna factor , cable loss and amplifier gain

Note 2: Margin (dB) = Emission level (dBuV/m) – Limit (dBuV/m).

<b>Modulation</b>	HT40	<b>Test Freq. (MHz)</b>	5795
<b>Polarization</b>	Horizontal	<b>Test Configuration</b>	2

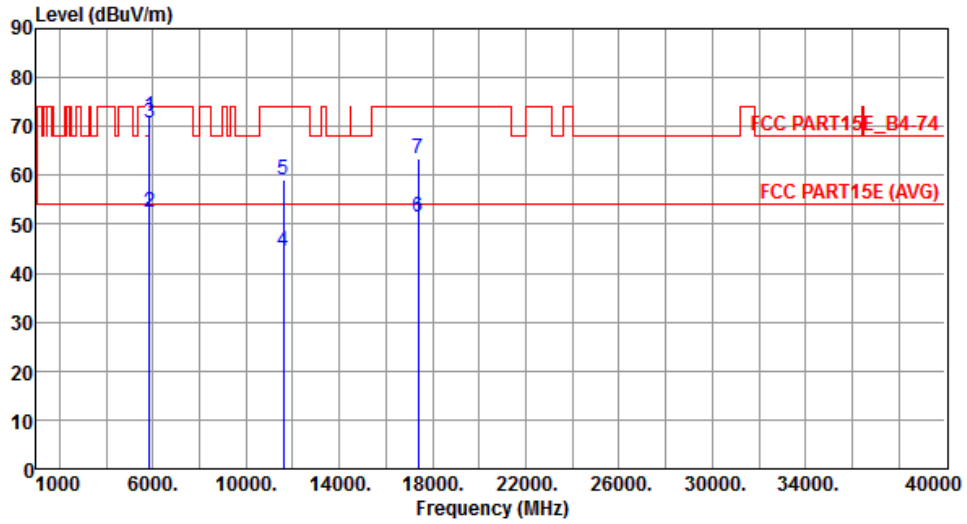

	Freq. MHz	Emission level dBuV/m	Limit dBuV/m	Margin dB	SA reading dBuV	Factor dB	Remark	ANT High cm	Turn Table deg
1	5850.00	72.08	78.20	-6.12	64.58	7.50	Peak	168	193
2	5860.00	52.54	54.00	-1.46	45.03	7.51	Average	168	193
3	5860.00	70.80	74.00	-3.20	63.29	7.51	Peak	168	193
4	11590.00	44.38	54.00	-9.62	27.62	16.76	Average	198	226
5	11590.00	58.95	74.00	-15.05	42.19	16.76	Peak	198	226
6	17385.00	51.45	54.00	-2.55	31.91	19.54	Average	198	146
7	17385.00	63.39	74.00	-10.61	43.85	19.54	Peak	198	146

Note 1: Emission Level (dBuV/m) = SA Reading (dBuV/m) + Factor\* (dB)

\*Factor includes antenna factor , cable loss and amplifier gain

Note 2: Margin (dB) = Emission level (dBuV/m) – Limit (dBuV/m).

<b>Modulation</b>	HT40	<b>Test Freq. (MHz)</b>	5795
<b>Polarization</b>	Vertical	<b>Test Configuration</b>	2

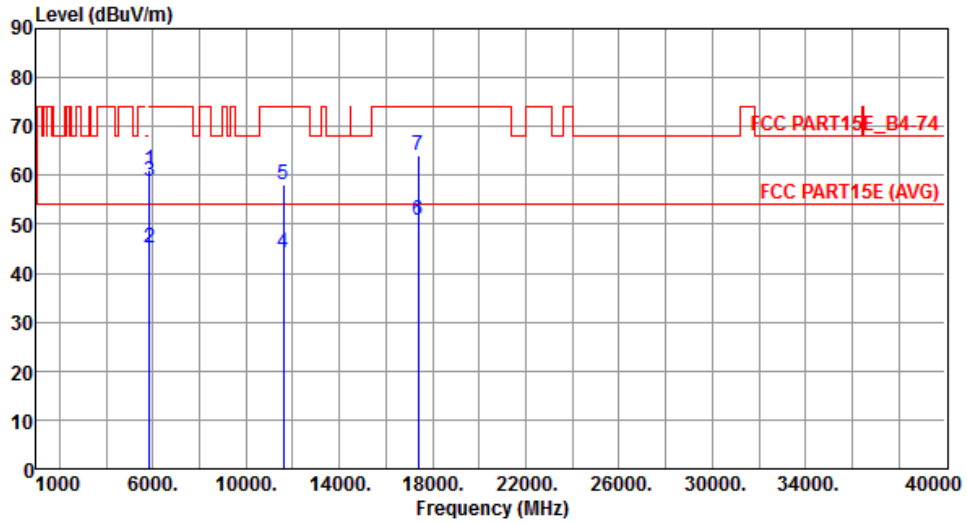

	Freq. MHz	Emission level dBuV/m	Limit dBuV/m	Margin dB	SA reading dBuV	Factor dB	Remark	ANT High cm	Turn Table deg
1	5850.00	61.12	78.20	-17.08	53.62	7.50	Peak	169	165
2	5860.00	45.26	54.00	-8.74	37.75	7.51	Average	169	165
3	5860.00	58.77	74.00	-15.23	51.26	7.51	Peak	169	165
4	11590.00	44.29	54.00	-9.71	27.53	16.76	Average	169	211
5	11590.00	58.27	74.00	-15.73	41.51	16.76	Peak	169	211
6	17385.00	50.81	54.00	-3.19	31.27	19.54	Average	184	169
7	17385.00	63.96	74.00	-10.04	44.42	19.54	Peak	184	169

Note 1: Emission Level (dBuV/m) = SA Reading (dBuV/m) + Factor\* (dB)

\*Factor includes antenna factor , cable loss and amplifier gain

Note 2: Margin (dB) = Emission level (dBuV/m) – Limit (dBuV/m).

### Test Configuration 3: Isolated Magnetic Dipole antenna

#### 3.5.12 Transmitter Radiated Unwanted Emissions (Below 1GHz)

<b>Modulation</b>	HT40	<b>Test Freq. (MHz)</b>	5590
<b>Polarization</b>	Horizontal	<b>Test Configuration</b>	3

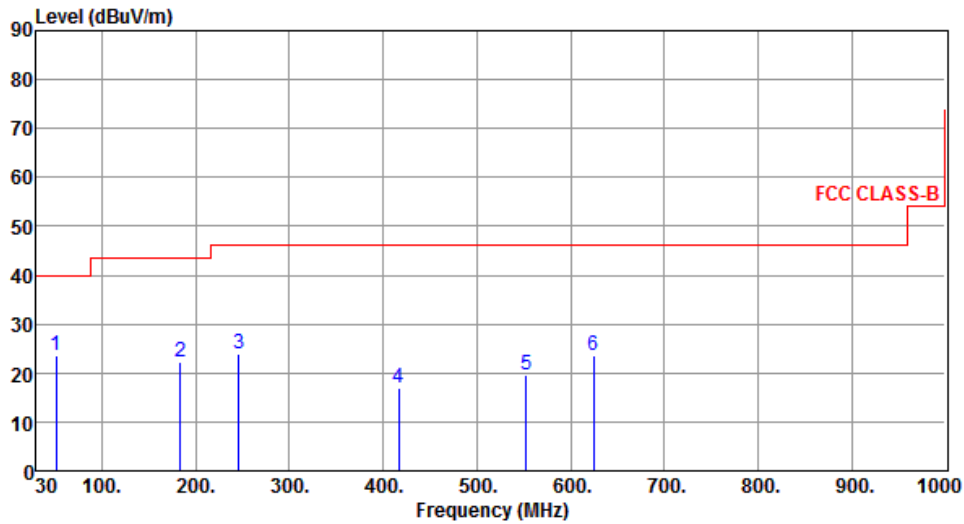

	Freq. MHz	Emission level dBUV/m	Limit dBUV/m	Margin dB	SA reading dBUV	Factor dB	Remark	ANT High cm	Turn Table deg
1	51.34	23.64	40.00	-16.36	36.77	-13.13	Peak	---	---
2	183.26	22.15	43.50	-21.35	37.77	-15.62	Peak	---	---
3	246.31	24.02	46.00	-21.98	38.76	-14.74	Peak	---	---
4	417.03	16.78	46.00	-29.22	26.39	-9.61	Peak	---	---
5	552.83	19.62	46.00	-26.38	26.65	-7.03	Peak	---	---
6	624.61	23.43	46.00	-22.57	28.87	-5.44	Peak	---	---

Note 1: Emission Level (dBUV/m) = SA Reading (dBUV/m) + Factor\* (dB)

\*Factor includes antenna factor , cable loss and amplifier gain

Note 2: Margin (dB) = Emission level (dBUV/m) – Limit (dBUV/m).

Note 3: All spurious emissions below 30MHz are more than 20 dB below the limit.

<b>Modulation</b>	HT40	<b>Test Freq. (MHz)</b>	5590
<b>Polarization</b>	Vertical	<b>Test Configuration</b>	3

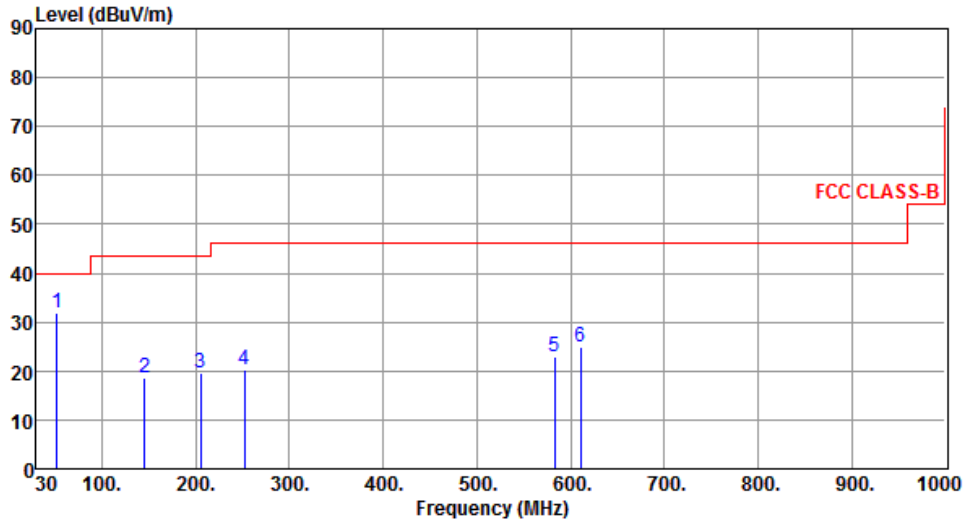

	Freq. MHz	Emission level dBuV/m	Limit dBuV/m	Margin dB	SA reading dBuV	Factor dB	Remark	ANT High cm	Turn Table deg
1	52.31	32.00	40.00	-8.00	45.27	-13.27	Peak	---	---
2	145.43	18.71	43.50	-24.79	32.29	-13.58	Peak	---	---
3	205.57	19.52	43.50	-23.98	36.00	-16.48	Peak	---	---
4	252.13	20.21	46.00	-25.79	34.88	-14.67	Peak	---	---
5	582.90	22.87	46.00	-23.13	29.12	-6.25	Peak	---	---
6	611.03	24.88	46.00	-21.12	30.51	-5.63	Peak	---	---

Note 1: Emission Level (dBuV/m) = SA Reading (dBuV/m) + Factor\* (dB)

\*Factor includes antenna factor , cable loss and amplifier gain

Note 2: Margin (dB) = Emission level (dBuV/m) – Limit (dBuV/m).

Note 3: All spurious emissions below 30MHz are more than 20 dB below the limit.

<b>Modulation</b>	11a	<b>Test Freq. (MHz)</b>	5785
<b>Polarization</b>	Horizontal	<b>Test Configuration</b>	3

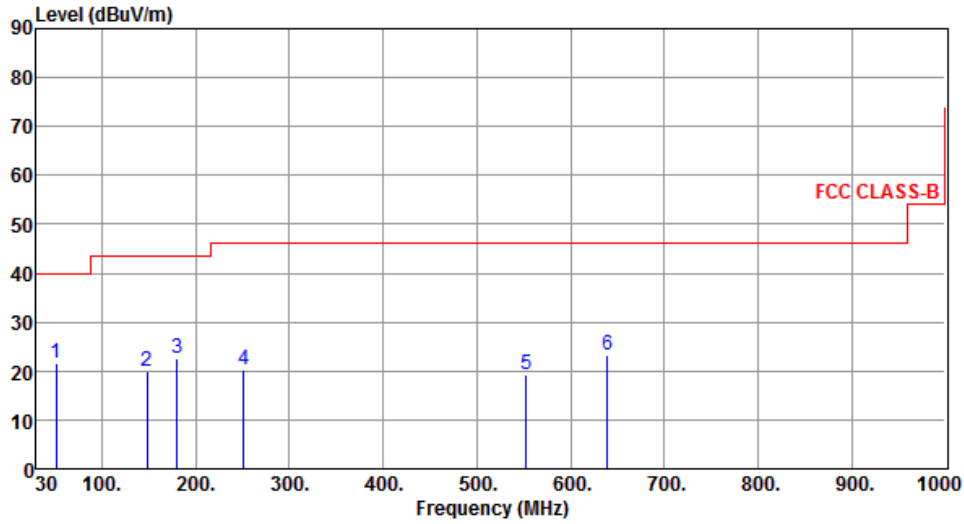

	Freq. MHz	Emission level dBuV/m	Limit dBuV/m	Margin dB	SA reading dBuV	Factor dB	Remark	ANT High cm	Turn Table deg
1	51.34	21.73	40.00	-18.27	34.86	-13.13	Peak	---	---
2	148.34	19.78	43.50	-23.72	33.26	-13.48	Peak	---	---
3	180.35	22.47	43.50	-21.03	37.78	-15.31	Peak	---	---
4	251.16	20.17	46.00	-25.83	34.88	-14.71	Peak	---	---
5	552.83	19.30	46.00	-26.70	26.33	-7.03	Peak	---	---
6	639.16	23.26	46.00	-22.74	28.49	-5.23	Peak	---	---

Note 1: Emission Level (dBuV/m) = SA Reading (dBuV/m) + Factor\* (dB)

\*Factor includes antenna factor , cable loss and amplifier gain

Note 2: Margin (dB) = Emission level (dBuV/m) – Limit (dBuV/m).

Note 3: All spurious emissions below 30MHz are more than 20 dB below the limit.



<b>Modulation</b>	11a	<b>Test Freq. (MHz)</b>	5785
<b>Polarization</b>	Vertical	<b>Test Configuration</b>	3

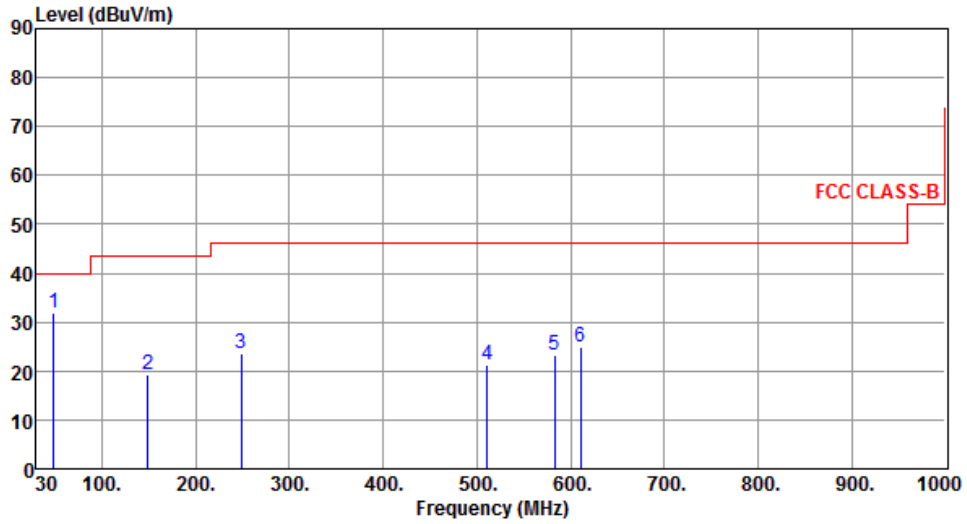

	Freq. MHz	Emission level dBuV/m	Limit dBuV/m	Margin dB	SA reading dBuV	Factor dB	Remark	ANT High cm	Turn Table deg
1	48.43	31.76	40.00	-8.24	44.67	-12.91	Peak	---	---
2	149.31	19.16	43.50	-24.34	32.61	-13.45	Peak	---	---
3	248.25	23.44	46.00	-22.56	38.18	-14.74	Peak	---	---
4	511.12	21.11	46.00	-24.89	28.65	-7.54	Peak	---	---
5	582.90	23.11	46.00	-22.89	29.36	-6.25	Peak	---	---
6	611.03	24.99	46.00	-21.01	30.62	-5.63	Peak	---	---

Note 1: Emission Level (dBuV/m) = SA Reading (dBuV/m) + Factor\* (dB)

\*Factor includes antenna factor , cable loss and amplifier gain

Note 2: Margin (dB) = Emission level (dBuV/m) – Limit (dBuV/m).

Note 3: All spurious emissions below 30MHz are more than 20 dB below the limit.

### 3.5.13 Transmitter Radiated Unwanted Emissions (Above 1GHz) for 11a

Modulation	11a	Test Freq. (MHz)	5180
Polarization	Horizontal	Test Configuration	3

  

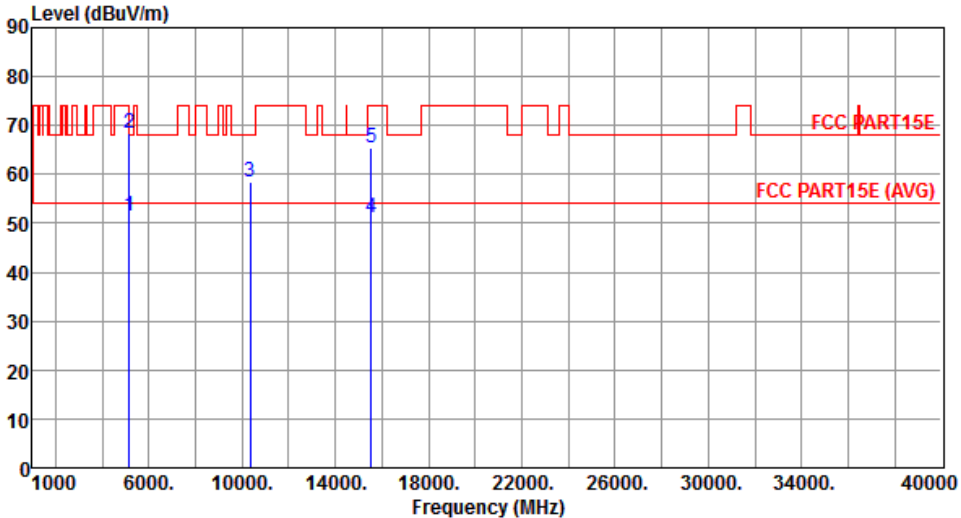

	Freq. MHz	Emission level dBuV/m	Limit dBuV/m	Margin dB	SA reading dBuV	Factor dB	Remark	ANT High cm	Turn Table deg
1	5150.00	51.62	54.00	-2.38	45.31	6.31	Average	160	146
2	5150.00	68.56	74.00	-5.44	62.25	6.31	Peak	160	146
3	10360.00	58.54	68.20	-9.66	42.20	16.34	Peak	259	237
4	15540.00	51.13	54.00	-2.87	33.63	17.50	Average	228	130
5	15540.00	65.39	74.00	-8.61	47.89	17.50	Peak	228	130

Note 1: Emission Level (dBuV/m) = SA Reading (dBuV/m) + Factor\* (dB)  
\*Factor includes antenna factor , cable loss and amplifier gain  
Note 2: Margin (dB) = Emission level (dBuV/m) – Limit (dBuV/m).

<b>Modulation</b>	11a	<b>Test Freq. (MHz)</b>	5180
<b>Polarization</b>	Vertical	<b>Test Configuration</b>	3

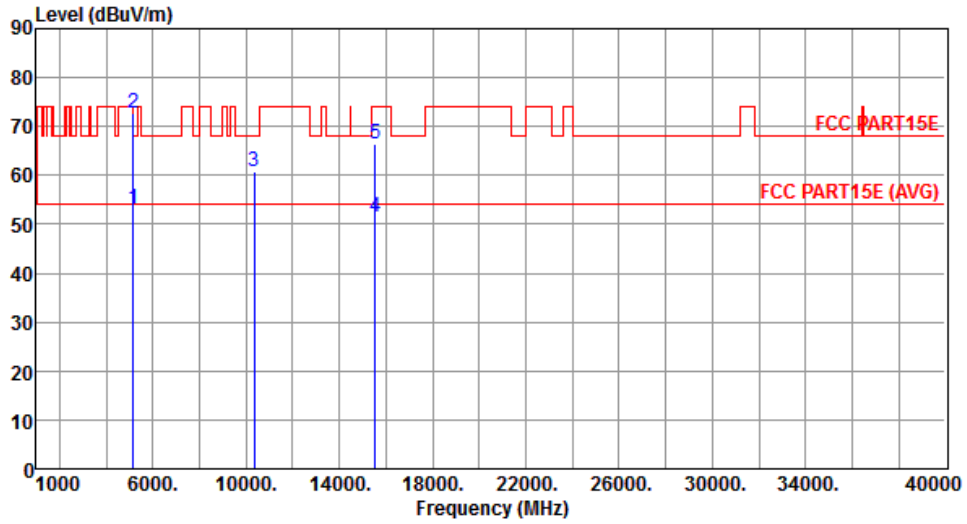

	Freq. MHz	Emission level dBuV/m	Limit dBuV/m	Margin dB	SA reading dBuV	Factor dB	Remark	ANT High cm	Turn Table deg
1	5150.00	53.08	54.00	-0.92	46.77	6.31	Average	296	110
2	5150.00	72.76	74.00	-1.24	66.45	6.31	Peak	296	110
3	10360.00	60.84	68.20	-7.36	44.50	16.34	Peak	395	209
4	15540.00	51.33	54.00	-2.67	33.83	17.50	Average	150	186
5	15540.00	66.48	74.00	-7.52	48.98	17.50	Peak	150	186

Note 1: Emission Level (dBuV/m) = SA Reading (dBuV/m) + Factor\* (dB)

\*Factor includes antenna factor , cable loss and amplifier gain

Note 2: Margin (dB) = Emission level (dBuV/m) – Limit (dBuV/m).

<b>Modulation</b>	11a	<b>Test Freq. (MHz)</b>	5200
<b>Polarization</b>	Horizontal	<b>Test Configuration</b>	3

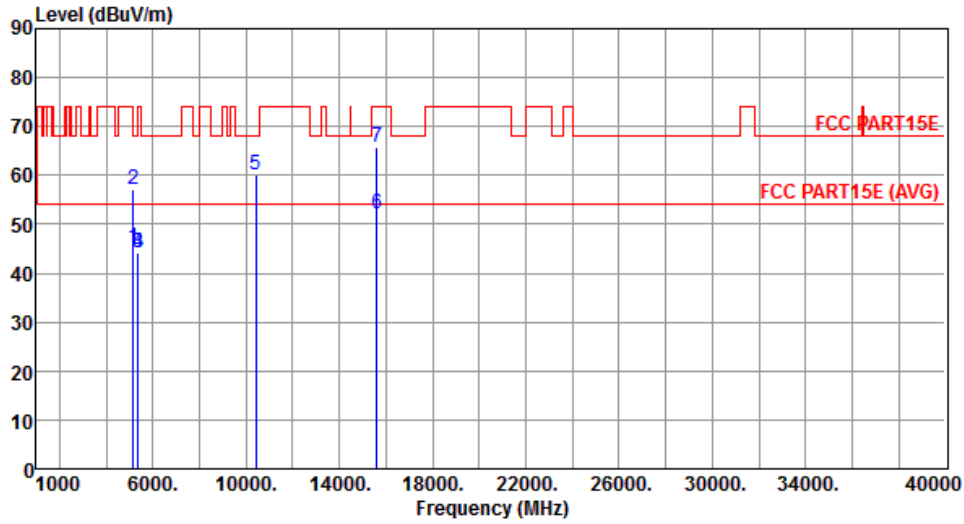

	Freq. MHz	Emission level dBuV/m	Limit dBuV/m	Margin dB	SA reading dBuV	Factor dB	Remark	ANT High cm	Turn Table deg
1	5150.00	45.19	54.00	-8.81	38.88	6.31	Average	150	116
2	5150.00	57.18	74.00	-16.82	50.87	6.31	Peak	150	116
3	5350.00	44.27	54.00	-9.73	37.65	6.62	Average	150	116
4	5350.00	44.27	74.00	-29.73	37.65	6.62	Peak	150	116
5	10400.00	60.06	68.20	-8.14	43.64	16.42	Peak	282	233
6	15600.00	52.15	54.00	-1.85	34.77	17.38	Average	230	122
7	15600.00	65.83	74.00	-8.17	48.45	17.38	Peak	230	122

Note 1: Emission Level (dBuV/m) = SA Reading (dBuV/m) + Factor\* (dB)

\*Factor includes antenna factor , cable loss and amplifier gain

Note 2: Margin (dB) = Emission level (dBuV/m) – Limit (dBuV/m).

<b>Modulation</b>	11a	<b>Test Freq. (MHz)</b>	5200
<b>Polarization</b>	Vertical	<b>Test Configuration</b>	3

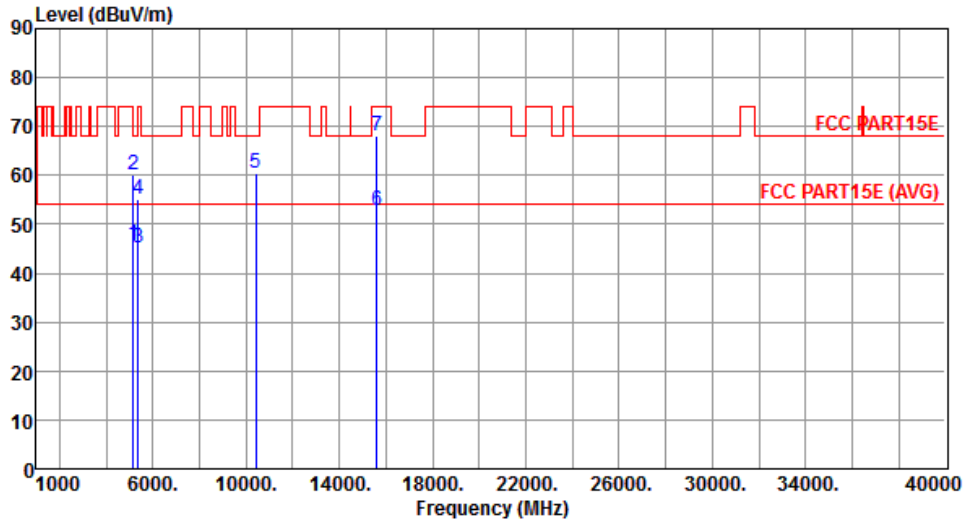

	Freq. MHz	Emission level dBuV/m	Limit dBuV/m	Margin dB	SA reading dBuV	Factor dB	Remark	ANT High cm	Turn Table deg
1	5150.00	45.75	54.00	-8.25	39.44	6.31	Average	296	110
2	5150.00	60.26	74.00	-13.74	53.95	6.31	Peak	296	110
3	5350.00	45.24	54.00	-8.76	38.62	6.62	Average	296	110
4	5350.00	54.97	74.00	-19.03	48.35	6.62	Peak	296	110
5	10400.00	60.33	68.20	-7.87	43.91	16.42	Peak	381	191
6	15600.00	52.83	54.00	-1.17	35.45	17.38	Average	158	186
7	15600.00	67.97	74.00	-6.03	50.59	17.38	Peak	158	186

Note 1: Emission Level (dBuV/m) = SA Reading (dBuV/m) + Factor\* (dB)

\*Factor includes antenna factor , cable loss and amplifier gain

Note 2: Margin (dB) = Emission level (dBuV/m) – Limit (dBuV/m).

<b>Modulation</b>	11a	<b>Test Freq. (MHz)</b>	5240
<b>Polarization</b>	Horizontal	<b>Test Configuration</b>	3

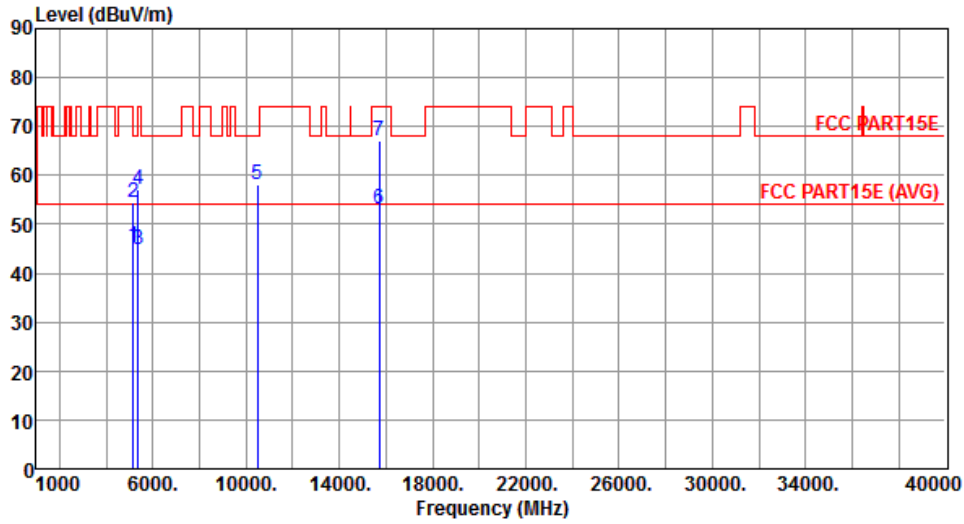

	Freq. MHz	Emission level dBuV/m	Limit dBuV/m	Margin dB	SA reading dBuV	Factor dB	Remark	ANT High cm	Turn Table deg
1	5150.00	45.36	54.00	-8.64	39.05	6.31	Average	158	135
2	5150.00	54.47	74.00	-19.53	48.16	6.31	Peak	158	135
3	5350.00	44.80	54.00	-9.20	38.18	6.62	Average	158	135
4	5350.00	56.98	74.00	-17.02	50.36	6.62	Peak	158	135
5	10480.00	58.13	68.20	-10.07	41.57	16.56	Peak	283	242
6	15720.00	53.14	54.00	-0.86	35.99	17.15	Average	242	119
7	15720.00	67.04	74.00	-6.96	49.89	17.15	Peak	242	119

Note 1: Emission Level (dBuV/m) = SA Reading (dBuV/m) + Factor\* (dB)

\*Factor includes antenna factor , cable loss and amplifier gain

Note 2: Margin (dB) = Emission level (dBuV/m) – Limit (dBuV/m).

<b>Modulation</b>	11a	<b>Test Freq. (MHz)</b>	5240
<b>Polarization</b>	Vertical	<b>Test Configuration</b>	3

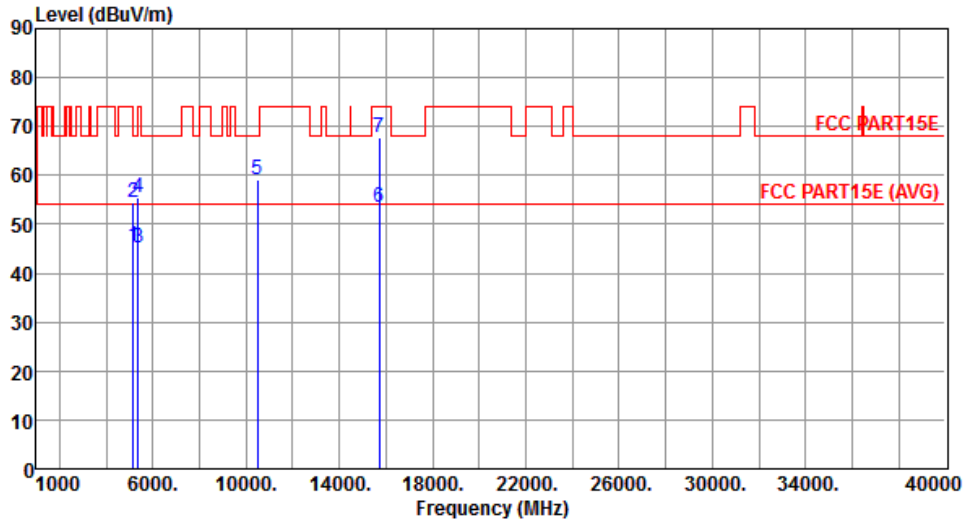

	Freq. MHz	Emission level dBuV/m	Limit dBuV/m	Margin dB	SA reading dBuV	Factor dB	Remark	ANT High cm	Turn Table deg
1	5150.00	45.45	54.00	-8.55	39.14	6.31	Average	294	109
2	5150.00	54.47	74.00	-19.53	48.16	6.31	Peak	294	109
3	5350.00	45.21	54.00	-8.79	38.59	6.62	Average	294	109
4	5350.00	55.36	74.00	-18.64	48.74	6.62	Peak	294	109
5	10480.00	59.25	68.20	-8.95	42.69	16.56	Peak	397	184
6	15720.00	53.31	54.00	-0.69	36.16	17.15	Average	157	187
7	15720.00	67.62	74.00	-6.38	50.47	17.15	Peak	157	187

Note 1: Emission Level (dBuV/m) = SA Reading (dBuV/m) + Factor\* (dB)

\*Factor includes antenna factor , cable loss and amplifier gain

Note 2: Margin (dB) = Emission level (dBuV/m) – Limit (dBuV/m).

<b>Modulation</b>	11a	<b>Test Freq. (MHz)</b>	5260
<b>Polarization</b>	Horizontal	<b>Test Configuration</b>	3

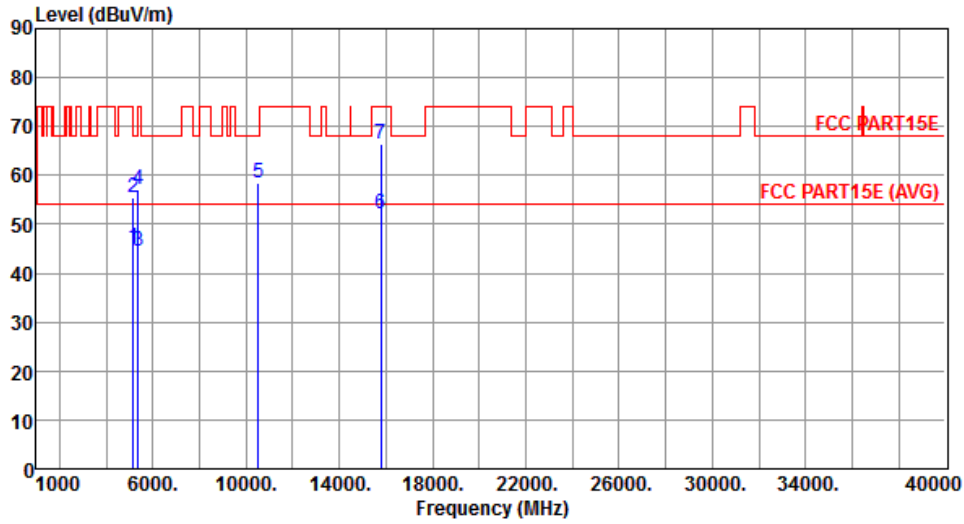

	Freq. MHz	Emission level dBuV/m	Limit dBuV/m	Margin dB	SA reading dBuV	Factor dB	Remark	ANT High cm	Turn Table deg
1	5150.00	45.26	54.00	-8.74	38.95	6.31	Average	163	39
2	5150.00	55.60	74.00	-18.40	49.29	6.31	Peak	163	39
3	5350.00	44.61	54.00	-9.39	37.99	6.62	Average	163	39
4	5350.00	57.28	74.00	-16.72	50.66	6.62	Peak	163	39
5	10520.00	58.36	68.20	-9.84	41.76	16.60	Peak	250	239
6	15780.00	52.14	54.00	-1.86	35.09	17.05	Average	239	132
7	15780.00	66.36	74.00	-7.64	49.31	17.05	Peak	239	132

Note 1: Emission Level (dBuV/m) = SA Reading (dBuV/m) + Factor\* (dB)

\*Factor includes antenna factor , cable loss and amplifier gain

Note 2: Margin (dB) = Emission level (dBuV/m) – Limit (dBuV/m).



<b>Modulation</b>	11a	<b>Test Freq. (MHz)</b>	5260
<b>Polarization</b>	Vertical	<b>Test Configuration</b>	3

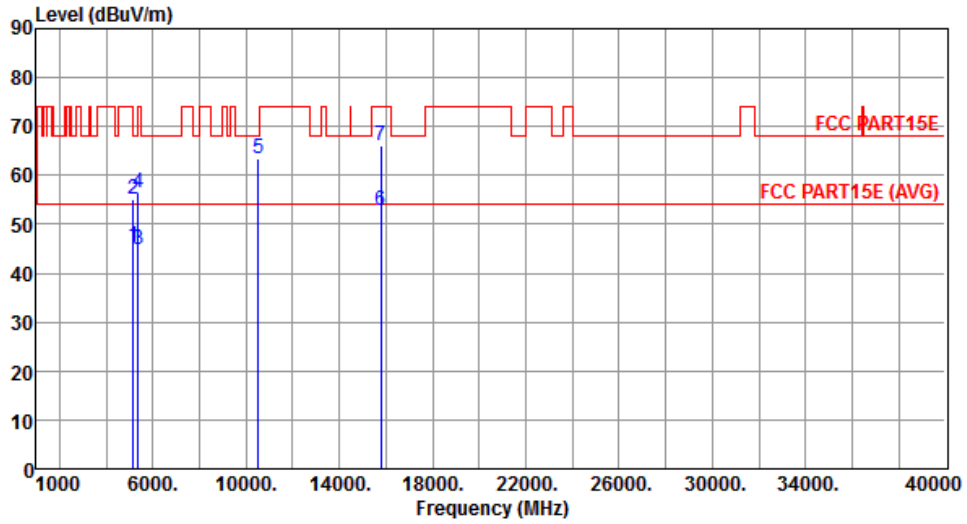

	Freq. MHz	Emission level dBuV/m	Limit dBuV/m	Margin dB	SA reading dBuV	Factor dB	Remark	ANT High cm	Turn Table deg
1	5150.00	45.46	54.00	-8.54	39.15	6.31	Average	293	110
2	5150.00	55.25	74.00	-18.75	48.94	6.31	Peak	293	110
3	5350.00	44.87	54.00	-9.13	38.25	6.62	Average	293	110
4	5350.00	56.42	74.00	-17.58	49.80	6.62	Peak	293	110
5	10520.00	63.54	68.20	-4.66	46.94	16.60	Peak	363	202
6	15780.00	52.92	54.00	-1.08	35.87	17.05	Average	155	185
7	15780.00	65.97	74.00	-8.03	48.92	17.05	Peak	155	185

Note 1: Emission Level (dBuV/m) = SA Reading (dBuV/m) + Factor\* (dB)

\*Factor includes antenna factor , cable loss and amplifier gain

Note 2: Margin (dB) = Emission level (dBuV/m) – Limit (dBuV/m).

<b>Modulation</b>	11a	<b>Test Freq. (MHz)</b>	5300
<b>Polarization</b>	Horizontal	<b>Test Configuration</b>	3

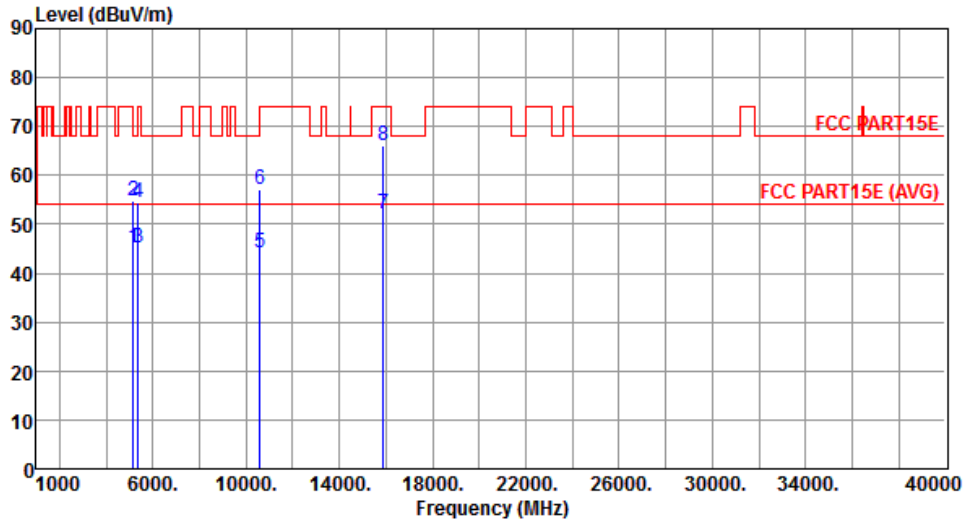

	Freq. MHz	Emission level dBuV/m	Limit dBuV/m	Margin dB	SA reading dBuV	Factor dB	Remark	ANT High cm	Turn Table deg
1	5150.00	45.13	54.00	-8.87	38.82	6.31	Average	182	44
2	5150.00	54.68	74.00	-19.32	48.37	6.31	Peak	182	44
3	5350.00	45.02	54.00	-8.98	38.40	6.62	Average	182	44
4	5350.00	54.49	74.00	-19.51	47.87	6.62	Peak	182	44
5	10600.00	44.02	54.00	-9.98	27.40	16.62	Average	255	244
6	10600.00	57.22	74.00	-16.78	40.60	16.62	Peak	255	244
7	15900.00	52.06	54.00	-1.94	35.24	16.82	Average	254	120
8	15900.00	66.01	74.00	-7.99	49.19	16.82	Peak	254	120

Note 1: Emission Level (dBuV/m) = SA Reading (dBuV/m) + Factor\* (dB)

\*Factor includes antenna factor , cable loss and amplifier gain

Note 2: Margin (dB) = Emission level (dBuV/m) – Limit (dBuV/m).

<b>Modulation</b>	11a	<b>Test Freq. (MHz)</b>	5300
<b>Polarization</b>	Vertical	<b>Test Configuration</b>	3

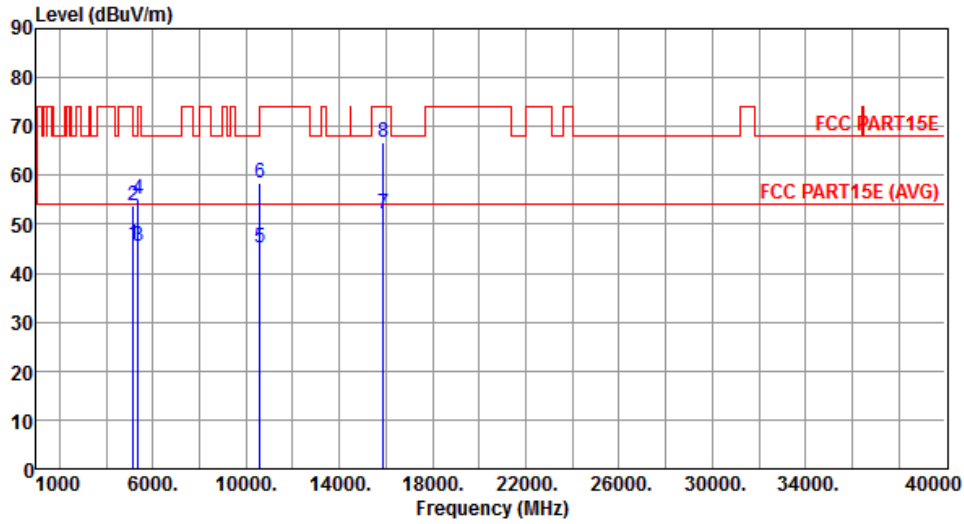

	Freq. MHz	Emission level dBuV/m	Limit dBuV/m	Margin dB	SA reading dBuV	Factor dB	Remark	ANT High cm	Turn Table deg
1	5150.00	45.72	54.00	-8.28	39.41	6.31	Average	322	109
2	5150.00	53.76	74.00	-20.24	47.45	6.31	Peak	322	109
3	5350.00	45.37	54.00	-8.63	38.75	6.62	Average	322	109
4	5350.00	54.97	74.00	-19.03	48.35	6.62	Peak	322	109
5	10600.00	45.22	54.00	-8.78	28.60	16.62	Average	162	183
6	10600.00	58.60	74.00	-15.40	41.98	16.62	Peak	162	183
7	15900.00	52.17	54.00	-1.83	35.35	16.82	Average	155	187
8	15900.00	66.79	74.00	-7.21	49.97	16.82	Peak	155	187

Note 1: Emission Level (dBuV/m) = SA Reading (dBuV/m) + Factor\* (dB)

\*Factor includes antenna factor , cable loss and amplifier gain

Note 2: Margin (dB) = Emission level (dBuV/m) – Limit (dBuV/m).

<b>Modulation</b>	11a	<b>Test Freq. (MHz)</b>	5320
<b>Polarization</b>	Horizontal	<b>Test Configuration</b>	3

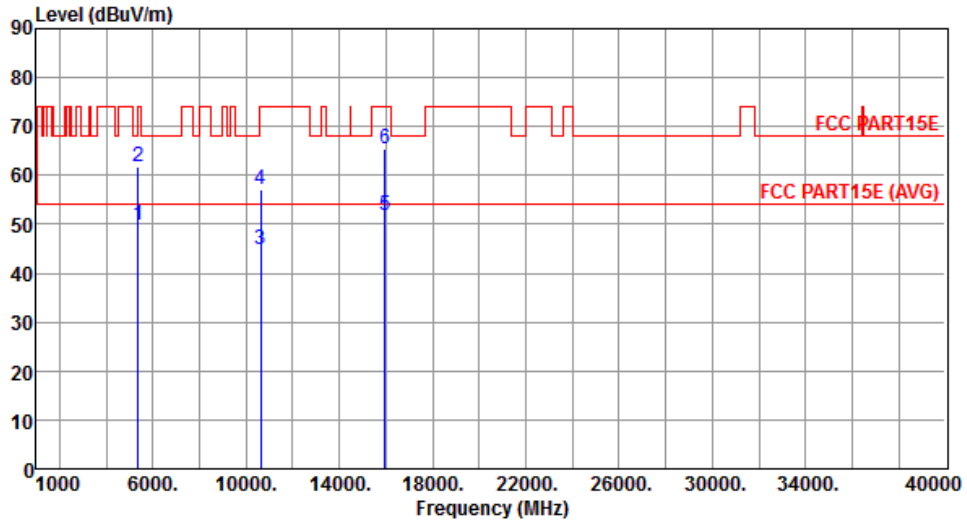

	Freq. MHz	Emission level dBuV/m	Limit dBuV/m	Margin dB	SA reading dBuV	Factor dB	Remark	ANT High cm	Turn Table deg
1	5350.00	49.72	54.00	-4.28	43.10	6.62	Average	170	39
2	5350.00	61.66	74.00	-12.34	55.04	6.62	Peak	170	39
3	10640.00	44.95	54.00	-9.05	28.32	16.63	Average	150	156
4	10640.00	57.19	74.00	-16.81	40.56	16.63	Peak	150	156
5	15960.00	51.83	54.00	-2.17	35.13	16.70	Average	233	127
6	15960.00	65.47	74.00	-8.53	48.77	16.70	Peak	233	127

Note 1: Emission Level (dBuV/m) = SA Reading (dBuV/m) + Factor\* (dB)

\*Factor includes antenna factor , cable loss and amplifier gain

Note 2: Margin (dB) = Emission level (dBuV/m) – Limit (dBuV/m).

<b>Modulation</b>	11a	<b>Test Freq. (MHz)</b>	5320
<b>Polarization</b>	Vertical	<b>Test Configuration</b>	3

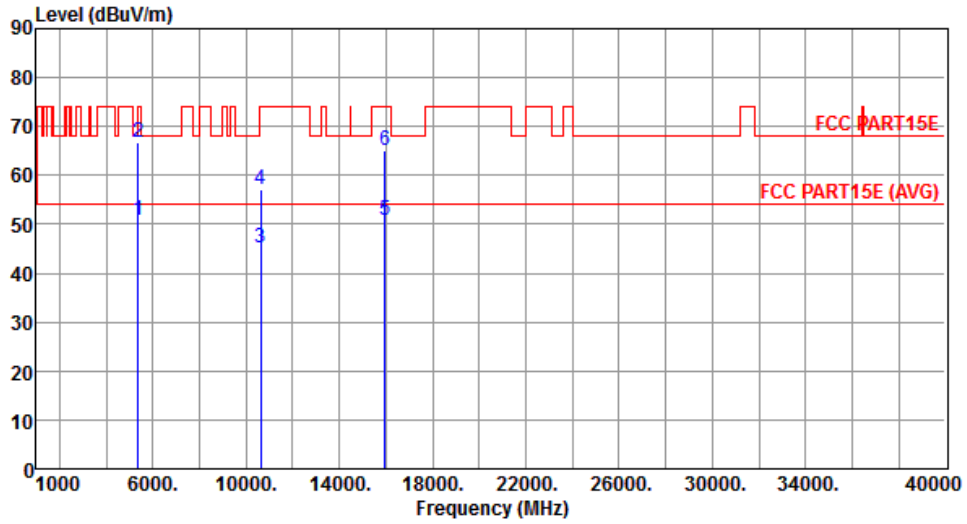

	Freq. MHz	Emission level dBuV/m	Limit dBuV/m	Margin dB	SA reading dBuV	Factor dB	Remark	ANT High cm	Turn Table deg
1	5350.00	50.89	54.00	-3.11	44.27	6.62	Average	318	111
2	5350.00	66.76	74.00	-7.24	60.14	6.62	Peak	318	111
3	10640.00	45.09	54.00	-8.91	28.46	16.63	Average	160	180
4	10640.00	57.01	74.00	-16.99	40.38	16.63	Peak	160	180
5	15960.00	50.81	54.00	-3.19	34.11	16.70	Average	163	189
6	15960.00	64.97	74.00	-9.03	48.27	16.70	Peak	163	189

Note 1: Emission Level (dBuV/m) = SA Reading (dBuV/m) + Factor\* (dB)

\*Factor includes antenna factor , cable loss and amplifier gain

Note 2: Margin (dB) = Emission level (dBuV/m) – Limit (dBuV/m).

<b>Modulation</b>	11a	<b>Test Freq. (MHz)</b>	5500
<b>Polarization</b>	Horizontal	<b>Test Configuration</b>	3

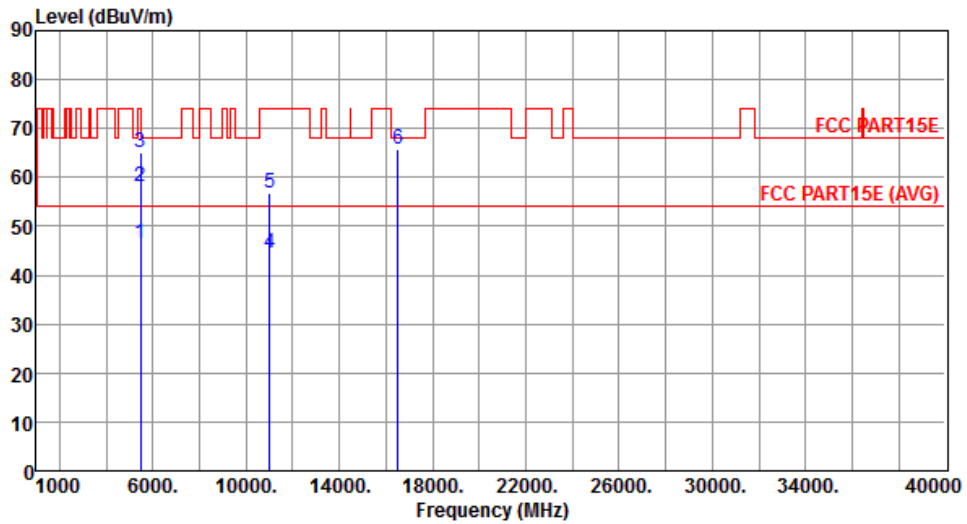

	Freq. MHz	Emission level dBuV/m	Limit dBuV/m	Margin dB	SA reading dBuV	Factor dB	Remark	ANT High cm	Turn Table deg
1	5460.00	46.34	54.00	-7.66	39.58	6.76	Average	275	38
2	5460.00	58.19	74.00	-15.81	51.43	6.76	Peak	275	38
3	5470.00	64.96	68.20	-3.24	58.19	6.77	Peak	275	38
4	11000.00	44.52	54.00	-9.48	27.80	16.72	Average	251	193
5	11000.00	56.80	74.00	-17.20	40.08	16.72	Peak	251	193
6	16500.00	65.63	68.20	-2.57	47.76	17.87	Peak	258	147

Note 1: Emission Level (dBuV/m) = SA Reading (dBuV/m) + Factor\* (dB)

\*Factor includes antenna factor , cable loss and amplifier gain

Note 2: Margin (dB) = Emission level (dBuV/m) – Limit (dBuV/m).

<b>Modulation</b>	11a	<b>Test Freq. (MHz)</b>	5500
<b>Polarization</b>	Vertical	<b>Test Configuration</b>	3

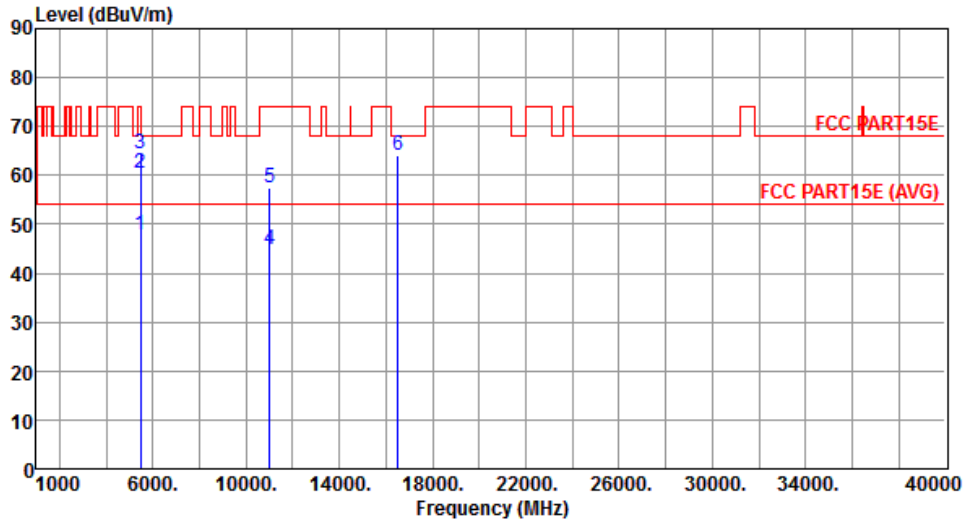

	Freq. MHz	Emission level dBuV/m	Limit dBuV/m	Margin dB	SA reading dBuV	Factor dB	Remark	ANT High cm	Turn Table deg
1	5460.00	47.90	54.00	-6.10	41.14	6.76	Average	335	107
2	5460.00	60.41	74.00	-13.59	53.65	6.76	Peak	335	107
3	5470.00	64.41	68.20	-3.79	57.64	6.77	Peak	335	107
4	11000.00	44.98	54.00	-9.02	28.26	16.72	Average	153	188
5	11000.00	57.30	74.00	-16.70	40.58	16.72	Peak	153	188
6	16500.00	64.01	68.20	-4.19	46.14	17.87	Peak	154	183

Note 1: Emission Level (dBuV/m) = SA Reading (dBuV/m) + Factor\* (dB)

\*Factor includes antenna factor , cable loss and amplifier gain

Note 2: Margin (dB) = Emission level (dBuV/m) – Limit (dBuV/m).

<b>Modulation</b>	11a	<b>Test Freq. (MHz)</b>	5580
<b>Polarization</b>	Horizontal	<b>Test Configuration</b>	3

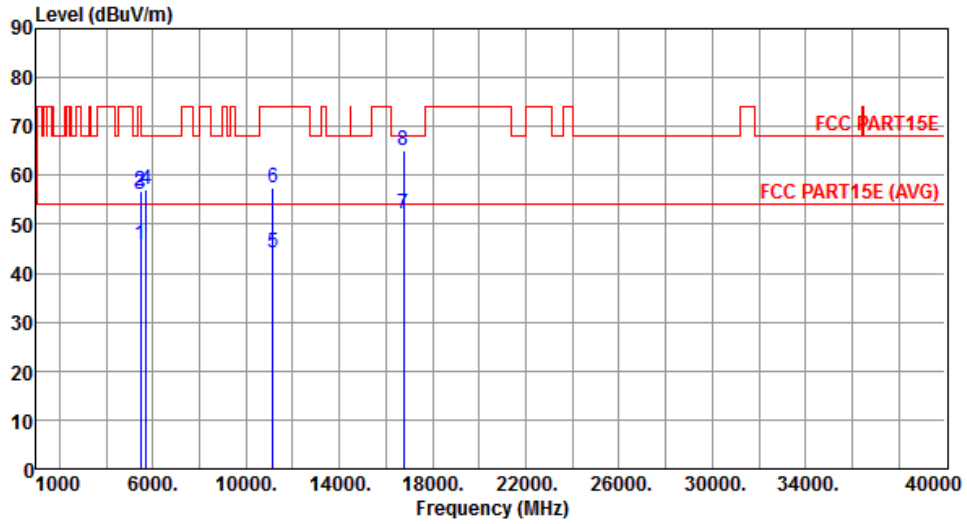

	Freq. MHz	Emission level dBuV/m	Limit dBuV/m	Margin dB	SA reading dBuV	Factor dB	Remark	ANT High cm	Turn Table deg
1	5460.00	45.94	54.00	-8.06	39.18	6.76	Average	150	136
2	5460.00	56.95	74.00	-17.05	50.19	6.76	Peak	150	136
3	5470.00	55.96	68.20	-12.24	49.19	6.77	Peak	150	136
4	5725.00	57.12	68.20	-11.08	49.88	7.24	Peak	150	136
5	11160.00	44.10	54.00	-9.90	27.31	16.79	Average	258	190
6	11160.00	57.37	74.00	-16.63	40.58	16.79	Peak	258	190
7	16740.00	52.30	54.00	-1.70	33.90	18.40	Average	250	142
8	16740.00	65.05	68.20	-3.15	46.65	18.40	Peak	250	142

Note 1: Emission Level (dBuV/m) = SA Reading (dBuV/m) + Factor\* (dB)

\*Factor includes antenna factor , cable loss and amplifier gain

Note 2: Margin (dB) = Emission level (dBuV/m) – Limit (dBuV/m).



<b>Modulation</b>	11a	<b>Test Freq. (MHz)</b>	5580
<b>Polarization</b>	Vertical	<b>Test Configuration</b>	3

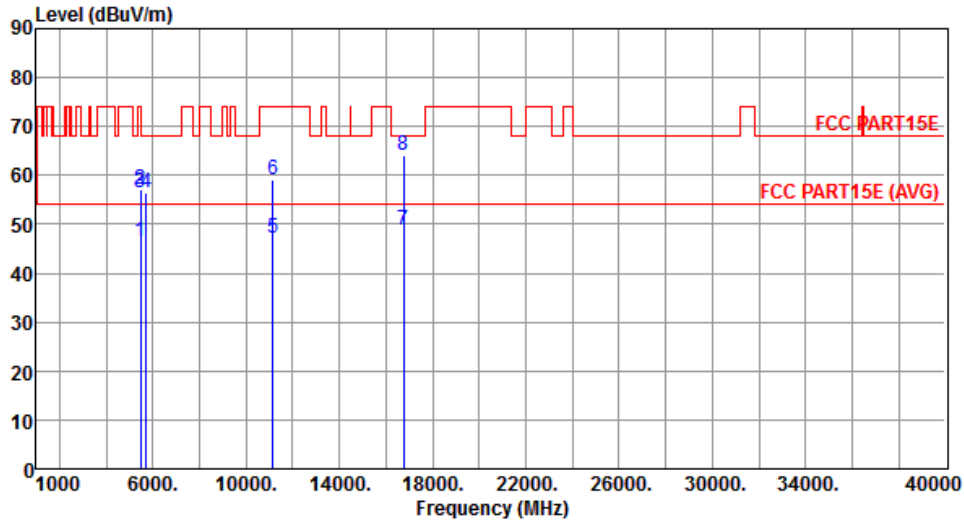

	Freq. MHz	Emission level dBuV/m	Limit dBuV/m	Margin dB	SA reading dBuV	Factor dB	Remark	ANT High cm	Turn Table deg
1	5460.00	46.45	54.00	-7.55	39.69	6.76	Average	332	108
2	5460.00	57.01	74.00	-16.99	50.25	6.76	Peak	332	108
3	5470.00	56.53	68.20	-11.67	49.76	6.77	Peak	332	108
4	5725.00	56.42	68.20	-11.78	49.18	7.24	Peak	332	108
5	11160.00	47.04	54.00	-6.96	30.25	16.79	Average	176	191
6	11160.00	59.16	74.00	-14.84	42.37	16.79	Peak	176	191
7	16740.00	48.90	54.00	-5.10	30.50	18.40	Average	153	197
8	16740.00	63.99	68.20	-4.21	45.59	18.40	Peak	153	197

Note 1: Emission Level (dBuV/m) = SA Reading (dBuV/m) + Factor\* (dB)

\*Factor includes antenna factor , cable loss and amplifier gain

Note 2: Margin (dB) = Emission level (dBuV/m) – Limit (dBuV/m).

<b>Modulation</b>	11a	<b>Test Freq. (MHz)</b>	5700
<b>Polarization</b>	Horizontal	<b>Test Configuration</b>	3

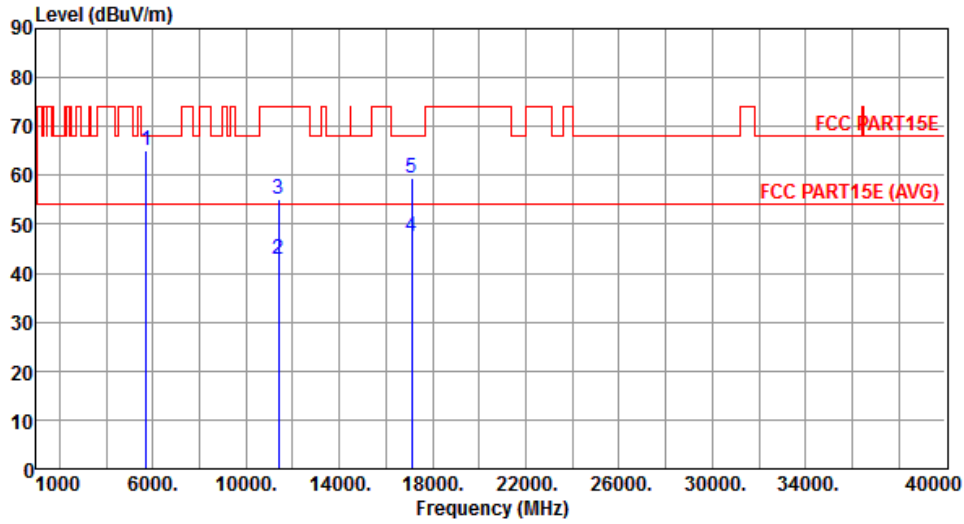

	Freq. MHz	Emission level dBuV/m	Limit dBuV/m	Margin dB	SA reading dBuV	Factor dB	Remark	ANT High cm	Turn Table deg
1	5725.00	64.93	68.20	-3.27	57.69	7.24	Peak	153	128
2	11400.00	42.88	54.00	-11.12	26.00	16.88	Average	271	143
3	11400.00	55.01	74.00	-18.99	38.13	16.88	Peak	271	143
4	17100.00	47.39	54.00	-6.61	28.27	19.12	Average	277	116
5	17100.00	59.52	68.20	-8.68	40.40	19.12	Peak	277	116

Note 1: Emission Level (dBuV/m) = SA Reading (dBuV/m) + Factor\* (dB)

\*Factor includes antenna factor , cable loss and amplifier gain

Note 2: Margin (dB) = Emission level (dBuV/m) – Limit (dBuV/m).

<b>Modulation</b>	11a	<b>Test Freq. (MHz)</b>	5700
<b>Polarization</b>	Vertical	<b>Test Configuration</b>	3

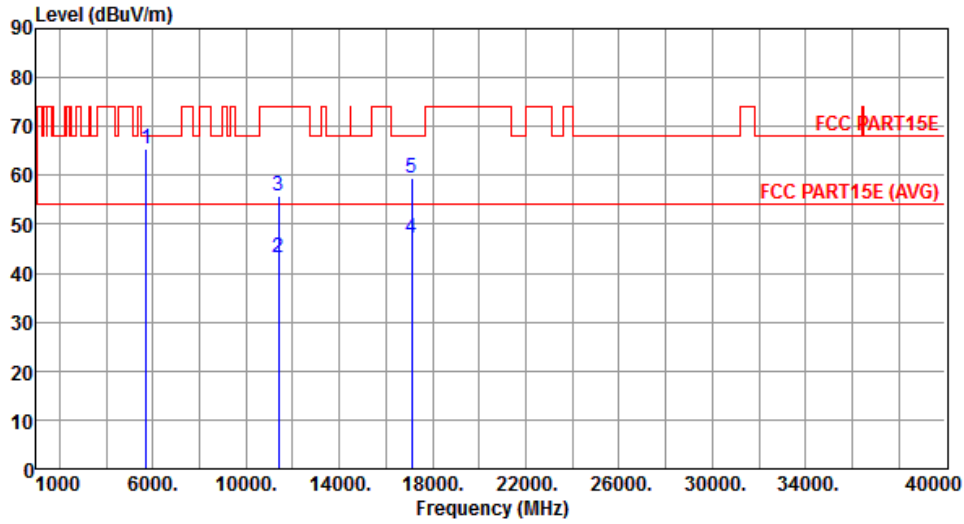

	Freq. MHz	Emission level dBuV/m	Limit dBuV/m	Margin dB	SA reading dBuV	Factor dB	Remark	ANT High cm	Turn Table deg
1	5725.00	65.55	68.20	-2.65	58.31	7.24	Peak	353	107
2	11400.00	43.13	54.00	-10.87	26.25	16.88	Average	179	351
3	11400.00	55.63	74.00	-18.37	38.75	16.88	Peak	179	351
4	17100.00	47.00	54.00	-7.00	27.88	19.12	Average	180	171
5	17100.00	59.38	68.20	-8.82	40.26	19.12	Peak	180	171

Note 1: Emission Level (dBuV/m) = SA Reading (dBuV/m) + Factor\* (dB)

\*Factor includes antenna factor , cable loss and amplifier gain

Note 2: Margin (dB) = Emission level (dBuV/m) – Limit (dBuV/m).

<b>Modulation</b>	11a	<b>Test Freq. (MHz)</b>	5745
<b>Polarization</b>	Horizontal	<b>Test Configuration</b>	3

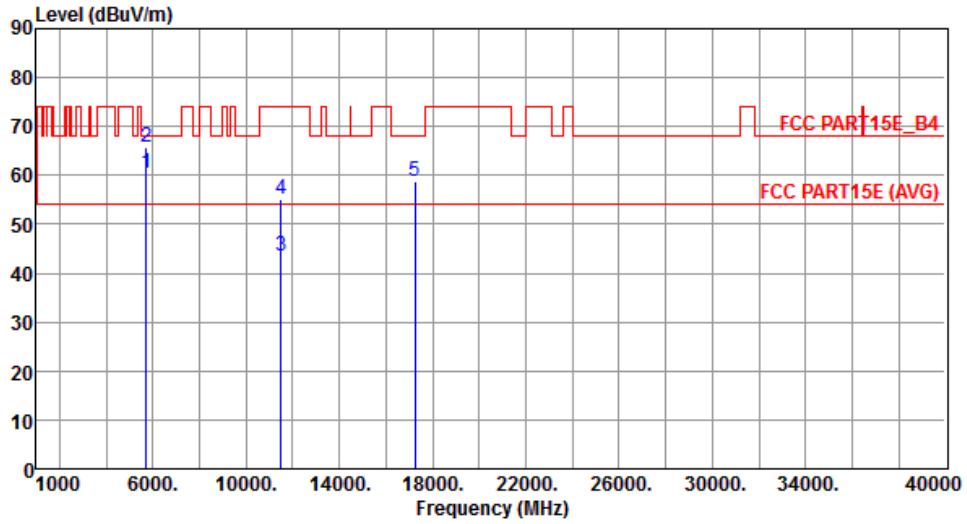

	Freq. MHz	Emission level dBuV/m	Limit dBuV/m	Margin dB	SA reading dBuV	Factor dB	Remark	ANT High cm	Turn Table deg
1	5715.00	60.51	68.20	-7.69	53.31	7.20	Peak	314	206
2	5725.00	65.65	78.20	-12.55	58.41	7.24	Peak	314	206
3	11490.00	43.34	54.00	-10.66	26.43	16.91	Average	255	231
4	11490.00	55.16	74.00	-18.84	38.25	16.91	Peak	255	231
5	17235.00	58.89	68.20	-9.31	39.57	19.32	Peak	153	194

Note 1: Emission Level (dBuV/m) = SA Reading (dBuV/m) + Factor\* (dB)

\*Factor includes antenna factor , cable loss and amplifier gain

Note 2: Margin (dB) = Emission level (dBuV/m) – Limit (dBuV/m).

<b>Modulation</b>	11a	<b>Test Freq. (MHz)</b>	5745
<b>Polarization</b>	Vertical	<b>Test Configuration</b>	3

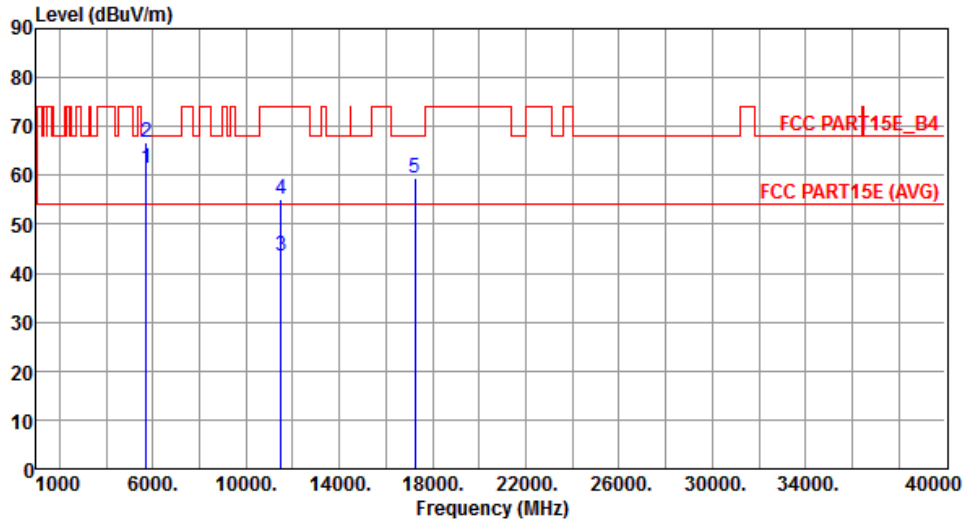

	Freq. MHz	Emission level dBuV/m	Limit dBuV/m	Margin dB	SA reading dBuV	Factor dB	Remark	ANT High cm	Turn Table deg
1	5715.00	61.45	68.20	-6.75	54.25	7.20	Peak	150	105
2	5725.00	66.90	78.20	-11.30	59.66	7.24	Peak	150	105
3	11490.00	43.50	54.00	-10.50	26.59	16.91	Average	218	162
4	11490.00	55.29	74.00	-18.71	38.38	16.91	Peak	218	162
5	17235.00	59.46	68.20	-8.74	40.14	19.32	Peak	185	185

Note 1: Emission Level (dBuV/m) = SA Reading (dBuV/m) + Factor\* (dB)

\*Factor includes antenna factor , cable loss and amplifier gain

Note 2: Margin (dB) = Emission level (dBuV/m) – Limit (dBuV/m).

<b>Modulation</b>	11a	<b>Test Freq. (MHz)</b>	5785
<b>Polarization</b>	Horizontal	<b>Test Configuration</b>	3

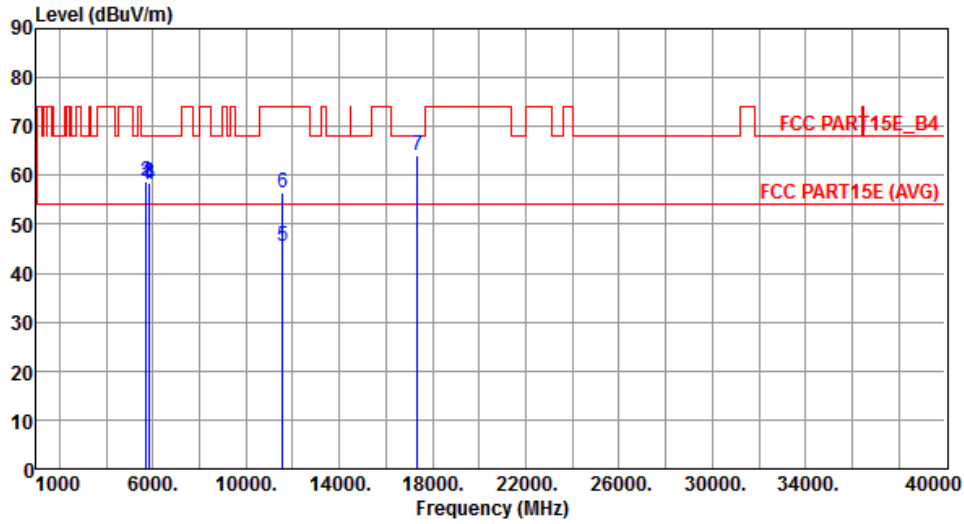

	Freq. MHz	Emission level dBuV/m	Limit dBuV/m	Margin dB	SA reading dBuV	Factor dB	Remark	ANT High cm	Turn Table deg
1	5715.00	58.24	68.20	-9.96	51.04	7.20	Peak	284	202
2	5725.00	58.83	78.20	-19.37	51.59	7.24	Peak	284	202
3	5850.00	58.49	78.20	-19.71	50.99	7.50	Peak	284	202
4	5860.00	58.14	68.20	-10.06	50.63	7.51	Peak	284	202
5	11570.00	45.63	54.00	-8.37	28.83	16.80	Average	289	121
6	11570.00	56.33	74.00	-17.67	39.53	16.80	Peak	289	121
7	17355.00	64.09	68.20	-4.11	44.60	19.49	Peak	185	130

Note 1: Emission Level (dBuV/m) = SA Reading (dBuV/m) + Factor\* (dB)

\*Factor includes antenna factor , cable loss and amplifier gain

Note 2: Margin (dB) = Emission level (dBuV/m) – Limit (dBuV/m).

<b>Modulation</b>	11a	<b>Test Freq. (MHz)</b>	5785
<b>Polarization</b>	Vertical	<b>Test Configuration</b>	3

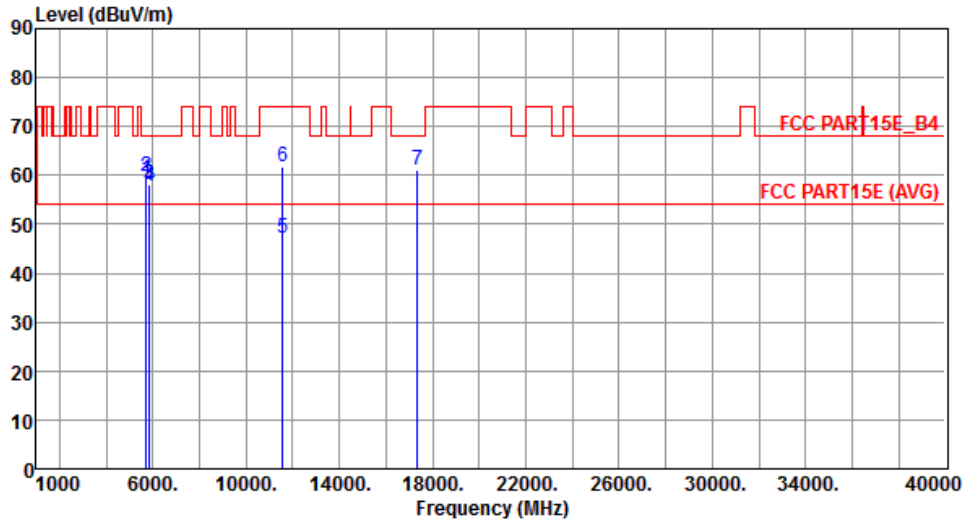

	Freq. MHz	Emission level dBuV/m	Limit dBuV/m	Margin dB	SA reading dBuV	Factor dB	Remark	ANT High cm	Turn Table deg
1	5715.00	59.19	68.20	-9.01	51.99	7.20	Peak	321	112
2	5725.00	59.94	78.20	-18.26	52.70	7.24	Peak	321	112
3	5850.00	58.05	78.20	-20.15	50.55	7.50	Peak	321	112
4	5860.00	57.78	68.20	-10.42	50.27	7.51	Peak	321	112
5	11570.00	47.28	54.00	-6.72	30.48	16.80	Average	203	187
6	11570.00	61.78	74.00	-12.22	44.98	16.80	Peak	203	187
7	17355.00	60.99	68.20	-7.21	41.50	19.49	Peak	169	165

Note 1: Emission Level (dBuV/m) = SA Reading (dBuV/m) + Factor\* (dB)

\*Factor includes antenna factor , cable loss and amplifier gain

Note 2: Margin (dB) = Emission level (dBuV/m) – Limit (dBuV/m).

<b>Modulation</b>	11a	<b>Test Freq. (MHz)</b>	5825
<b>Polarization</b>	Horizontal	<b>Test Configuration</b>	3

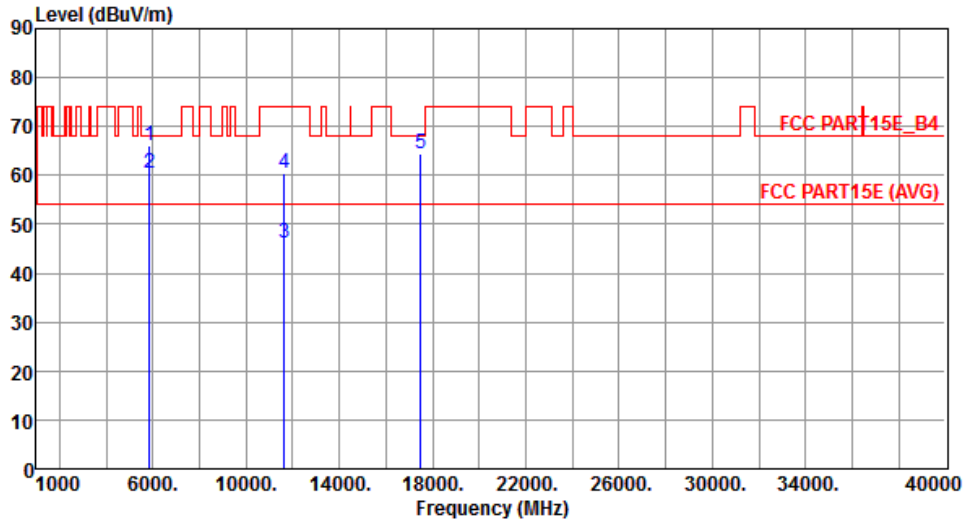

	Freq. MHz	Emission level dBuV/m	Limit dBuV/m	Margin dB	SA reading dBuV	Factor dB	Remark	ANT High cm	Turn Table deg
1	5850.00	66.12	78.20	-12.08	58.62	7.50	Peak	265	203
2	5860.00	60.56	68.20	-7.64	53.05	7.51	Peak	265	203
3	11650.00	46.22	54.00	-7.78	29.57	16.65	Average	158	163
4	11650.00	60.59	74.00	-13.41	43.94	16.65	Peak	158	163
5	17475.00	64.44	68.20	-3.76	44.78	19.66	Peak	278	241

Note 1: Emission Level (dBuV/m) = SA Reading (dBuV/m) + Factor\* (dB)

\*Factor includes antenna factor, cable loss and amplifier gain

Note 2: Margin (dB) = Emission level (dBuV/m) – Limit (dBuV/m).



<b>Modulation</b>	11a	<b>Test Freq. (MHz)</b>	5825
<b>Polarization</b>	Vertical	<b>Test Configuration</b>	3

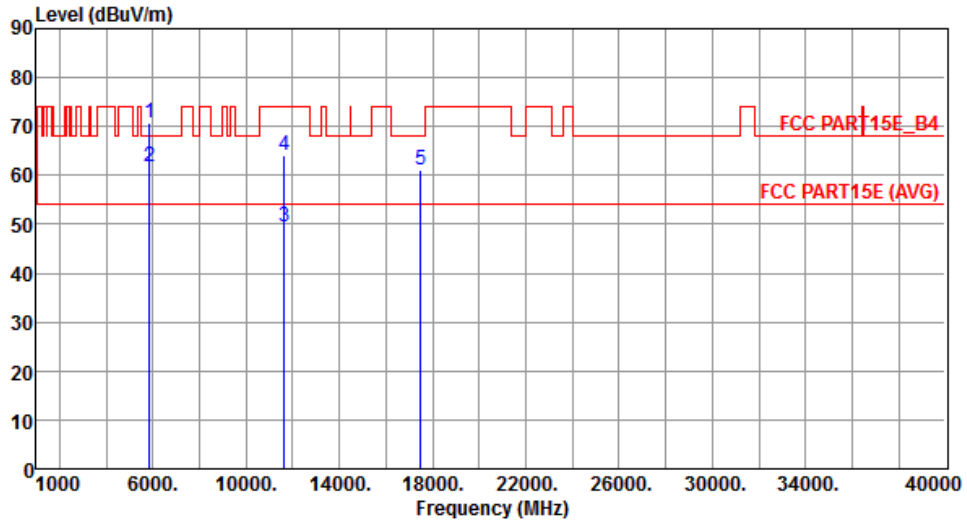

	Freq. MHz	Emission level dBuV/m	Limit dBuV/m	Margin dB	SA reading dBuV	Factor dB	Remark	ANT High cm	Turn Table deg
1	5850.00	70.82	78.20	-7.38	63.32	7.50	Peak	209	92
2	5860.00	61.70	68.20	-6.50	54.19	7.51	Peak	209	92
3	11650.00	49.57	54.00	-4.43	32.92	16.65	Average	179	172
4	11650.00	64.12	74.00	-9.88	47.47	16.65	Peak	179	172
5	17475.00	60.96	68.20	-7.24	41.30	19.66	Peak	162	187

Note 1: Emission Level (dBuV/m) = SA Reading (dBuV/m) + Factor\* (dB)

\*Factor includes antenna factor , cable loss and amplifier gain

Note 2: Margin (dB) = Emission level (dBuV/m) – Limit (dBuV/m).

### 3.5.14 Transmitter Radiated Unwanted Emissions (Above 1GHz) for HT20

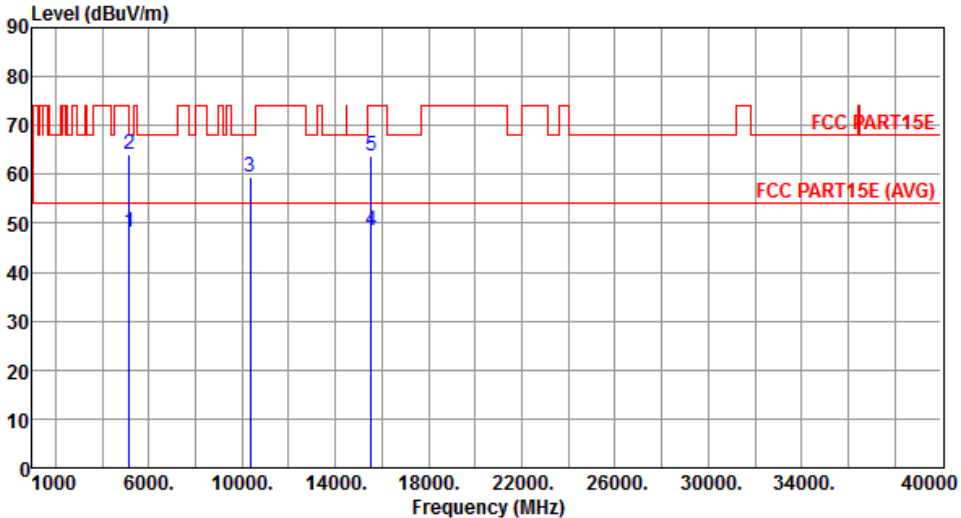
Modulation	HT20	Test Freq. (MHz)	5180																																																																					
Polarization	Horizontal	Test Configuration	3																																																																					
																																																																								
	<table border="1"> <thead> <tr> <th>Freq.</th> <th>Emission level</th> <th>Limit</th> <th>Margin</th> <th>SA reading</th> <th>Factor</th> <th>Remark</th> <th>ANT High</th> <th>Turn Table</th> </tr> <tr> <th>MHz</th> <th>dBuV/m</th> <th>dBuV/m</th> <th>dB</th> <th>dBuV</th> <th>dB</th> <th></th> <th>cm</th> <th>deg</th> </tr> </thead> <tbody> <tr> <td>1</td> <td>5150.00</td> <td>48.25</td> <td>54.00</td> <td>-5.75</td> <td>41.94</td> <td>6.31</td> <td>Average</td> <td>170</td> <td>150</td> </tr> <tr> <td>2</td> <td>5150.00</td> <td>64.10</td> <td>74.00</td> <td>-9.90</td> <td>57.79</td> <td>6.31</td> <td>Peak</td> <td>170</td> <td>150</td> </tr> <tr> <td>3</td> <td>10360.00</td> <td>59.48</td> <td>68.20</td> <td>-8.72</td> <td>43.14</td> <td>16.34</td> <td>Peak</td> <td>206</td> <td>225</td> </tr> <tr> <td>4</td> <td>15540.00</td> <td>48.39</td> <td>54.00</td> <td>-5.61</td> <td>30.89</td> <td>17.50</td> <td>Average</td> <td>242</td> <td>129</td> </tr> <tr> <td>5</td> <td>15540.00</td> <td>63.82</td> <td>74.00</td> <td>-10.18</td> <td>46.32</td> <td>17.50</td> <td>Peak</td> <td>242</td> <td>129</td> </tr> </tbody> </table>	Freq.	Emission level	Limit	Margin	SA reading	Factor	Remark	ANT High	Turn Table	MHz	dBuV/m	dBuV/m	dB	dBuV	dB		cm	deg	1	5150.00	48.25	54.00	-5.75	41.94	6.31	Average	170	150	2	5150.00	64.10	74.00	-9.90	57.79	6.31	Peak	170	150	3	10360.00	59.48	68.20	-8.72	43.14	16.34	Peak	206	225	4	15540.00	48.39	54.00	-5.61	30.89	17.50	Average	242	129	5	15540.00	63.82	74.00	-10.18	46.32	17.50	Peak	242	129			
Freq.	Emission level	Limit	Margin	SA reading	Factor	Remark	ANT High	Turn Table																																																																
MHz	dBuV/m	dBuV/m	dB	dBuV	dB		cm	deg																																																																
1	5150.00	48.25	54.00	-5.75	41.94	6.31	Average	170	150																																																															
2	5150.00	64.10	74.00	-9.90	57.79	6.31	Peak	170	150																																																															
3	10360.00	59.48	68.20	-8.72	43.14	16.34	Peak	206	225																																																															
4	15540.00	48.39	54.00	-5.61	30.89	17.50	Average	242	129																																																															
5	15540.00	63.82	74.00	-10.18	46.32	17.50	Peak	242	129																																																															
<p>Note 1: Emission Level (dBuV/m) = SA Reading (dBuV/m) + Factor* (dB)            *Factor includes antenna factor , cable loss and amplifier gain            Note 2: Margin (dB) = Emission level (dBuV/m) – Limit (dBuV/m).</p>																																																																								

<b>Modulation</b>	HT20	<b>Test Freq. (MHz)</b>	5180
<b>Polarization</b>	Vertical	<b>Test Configuration</b>	3

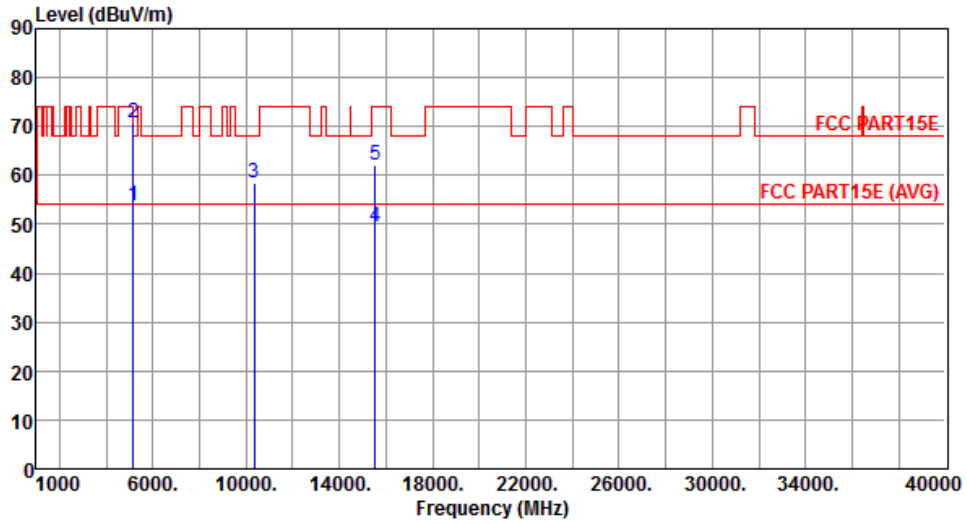

	Freq. MHz	Emission level dBuV/m	Limit dBuV/m	Margin dB	SA reading dBuV	Factor dB	Remark	ANT High cm	Turn Table deg
1	5150.00	53.83	54.00	-0.17	47.52	6.31	Average	296	110
2	5150.00	70.74	74.00	-3.26	64.43	6.31	Peak	296	110
3	10360.00	58.60	68.20	-9.60	42.26	16.34	Peak	271	269
4	15540.00	49.59	54.00	-4.41	32.09	17.50	Average	152	183
5	15540.00	62.17	74.00	-11.83	44.67	17.50	Peak	152	183

Note 1: Emission Level (dBuV/m) = SA Reading (dBuV/m) + Factor\* (dB)

\*Factor includes antenna factor , cable loss and amplifier gain

Note 2: Margin (dB) = Emission level (dBuV/m) – Limit (dBuV/m).

<b>Modulation</b>	HT20	<b>Test Freq. (MHz)</b>	5200
<b>Polarization</b>	Horizontal	<b>Test Configuration</b>	3

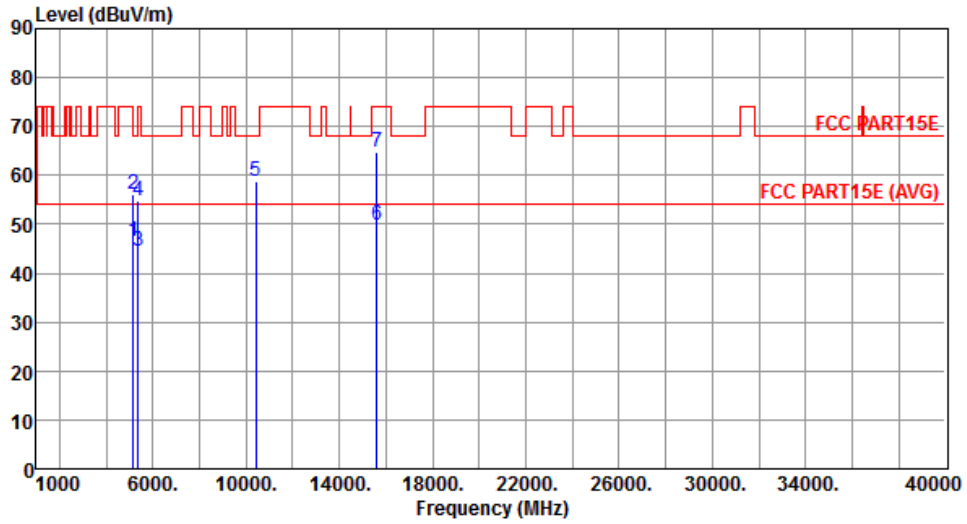

	Freq. MHz	Emission level dBuV/m	Limit dBuV/m	Margin dB	SA reading dBuV	Factor dB	Remark	ANT High cm	Turn Table deg
1	5150.00	46.56	54.00	-7.44	40.25	6.31	Average	156	144
2	5150.00	56.19	74.00	-17.81	49.88	6.31	Peak	156	144
3	5350.00	44.59	54.00	-9.41	37.97	6.62	Average	156	144
4	5350.00	54.95	74.00	-19.05	48.33	6.62	Peak	156	144
5	10400.00	58.78	68.20	-9.42	42.36	16.42	Peak	214	155
6	15600.00	49.86	54.00	-4.14	32.48	17.38	Average	235	128
7	15600.00	64.73	74.00	-9.27	47.35	17.38	Peak	235	128

Note 1: Emission Level (dBuV/m) = SA Reading (dBuV/m) + Factor\* (dB)

\*Factor includes antenna factor , cable loss and amplifier gain

Note 2: Margin (dB) = Emission level (dBuV/m) – Limit (dBuV/m).

<b>Modulation</b>	HT20	<b>Test Freq. (MHz)</b>	5200
<b>Polarization</b>	Vertical	<b>Test Configuration</b>	3

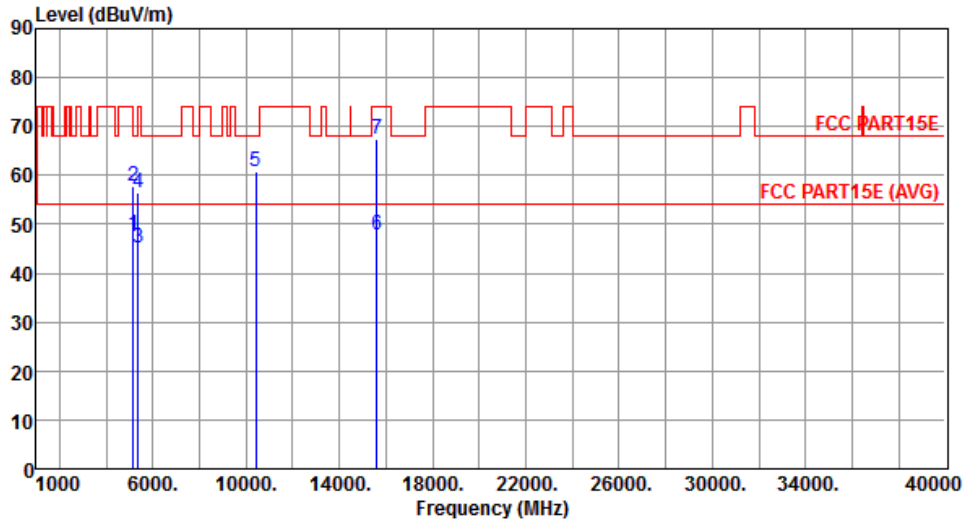

	Freq. MHz	Emission level dBuV/m	Limit dBuV/m	Margin dB	SA reading dBuV	Factor dB	Remark	ANT High cm	Turn Table deg
1	5150.00	47.72	54.00	-6.28	41.41	6.31	Average	296	109
2	5150.00	57.95	74.00	-16.05	51.64	6.31	Peak	296	109
3	5350.00	45.31	54.00	-8.69	38.69	6.62	Average	296	109
4	5350.00	56.49	74.00	-17.51	49.87	6.62	Peak	296	109
5	10400.00	60.78	68.20	-7.42	44.36	16.42	Peak	226	190
6	15600.00	47.96	54.00	-6.04	30.58	17.38	Average	155	184
7	15600.00	67.26	74.00	-6.74	49.88	17.38	Peak	155	184

Note 1: Emission Level (dBuV/m) = SA Reading (dBuV/m) + Factor\* (dB)

\*Factor includes antenna factor , cable loss and amplifier gain

Note 2: Margin (dB) = Emission level (dBuV/m) – Limit (dBuV/m).

<b>Modulation</b>	HT20	<b>Test Freq. (MHz)</b>	5240
<b>Polarization</b>	Horizontal	<b>Test Configuration</b>	3

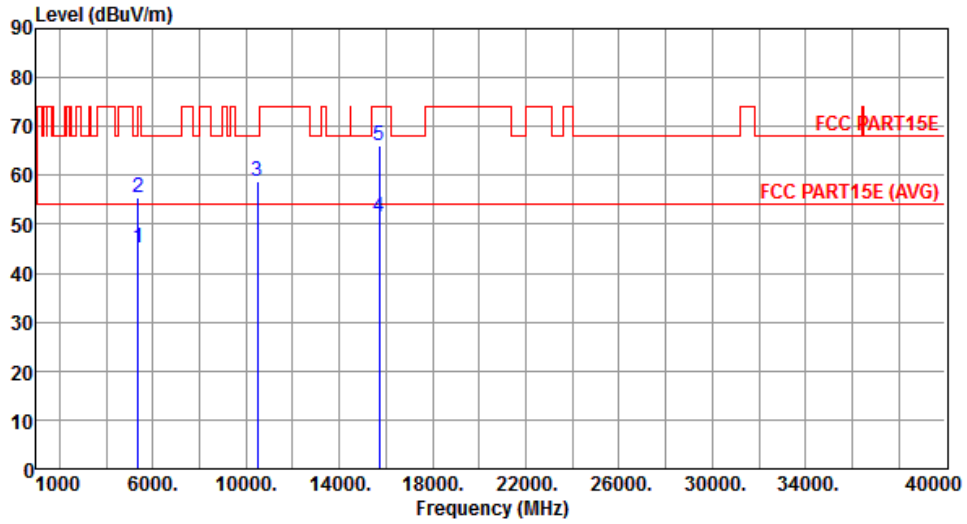

	Freq. MHz	Emission level dBuV/m	Limit dBuV/m	Margin dB	SA reading dBuV	Factor dB	Remark	ANT High cm	Turn Table deg
1	5350.00	45.30	54.00	-8.70	38.68	6.62	Average	157	135
2	5350.00	55.39	74.00	-18.61	48.77	6.62	Peak	157	135
3	10480.00	58.73	68.20	-9.47	42.17	16.56	Peak	311	267
4	15720.00	51.57	54.00	-2.43	34.42	17.15	Average	231	124
5	15720.00	66.06	74.00	-7.94	48.91	17.15	Peak	231	124

Note 1: Emission Level (dBuV/m) = SA Reading (dBuV/m) + Factor\* (dB)

\*Factor includes antenna factor , cable loss and amplifier gain

Note 2: Margin (dB) = Emission level (dBuV/m) – Limit (dBuV/m).

<b>Modulation</b>	HT20	<b>Test Freq. (MHz)</b>	5240
<b>Polarization</b>	Vertical	<b>Test Configuration</b>	3

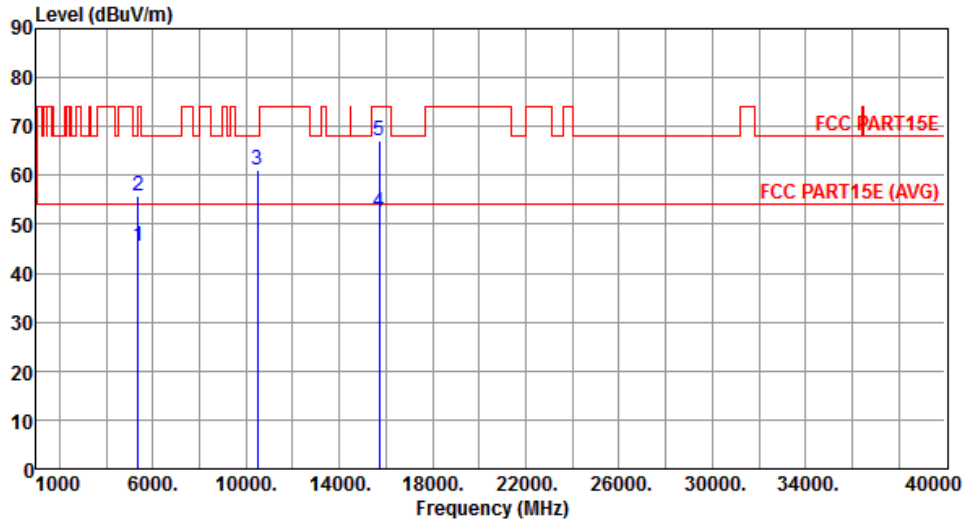

	Freq. MHz	Emission level dBuV/m	Limit dBuV/m	Margin dB	SA reading dBuV	Factor dB	Remark	ANT High cm	Turn Table deg
1	5350.00	45.43	54.00	-8.57	38.81	6.62	Average	294	110
2	5350.00	55.91	74.00	-18.09	49.29	6.62	Peak	294	110
3	10480.00	61.19	68.20	-7.01	44.63	16.56	Peak	176	267
4	15720.00	52.50	54.00	-1.50	35.35	17.15	Average	154	183
5	15720.00	66.95	74.00	-7.05	49.80	17.15	Peak	154	183

Note 1: Emission Level (dBuV/m) = SA Reading (dBuV/m) + Factor\* (dB)

\*Factor includes antenna factor , cable loss and amplifier gain

Note 2: Margin (dB) = Emission level (dBuV/m) – Limit (dBuV/m).

<b>Modulation</b>	HT20	<b>Test Freq. (MHz)</b>	5260
<b>Polarization</b>	Horizontal	<b>Test Configuration</b>	3

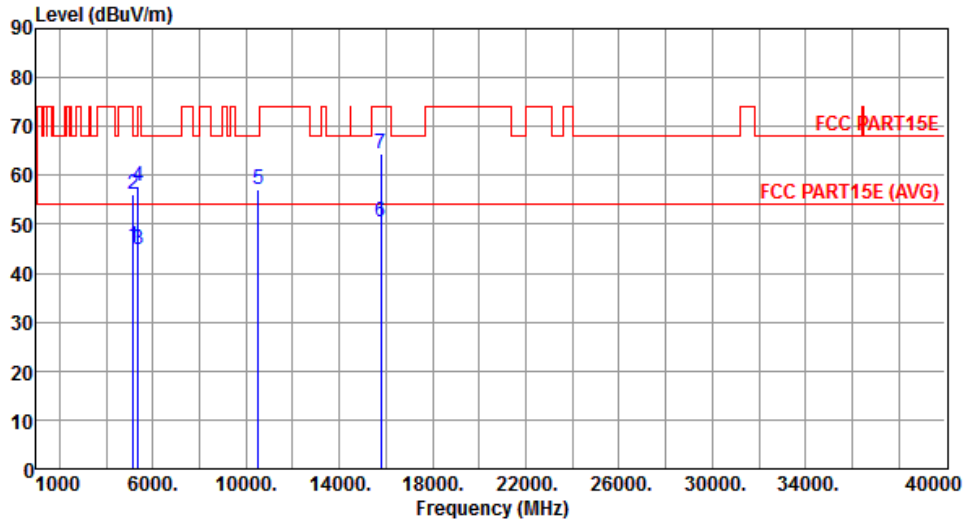

	Freq. MHz	Emission level dBuV/m	Limit dBuV/m	Margin dB	SA reading dBuV	Factor dB	Remark	ANT High cm	Turn Table deg
1	5150.00	45.57	54.00	-8.43	39.26	6.31	Average	158	42
2	5150.00	55.96	74.00	-18.04	49.65	6.31	Peak	158	42
3	5350.00	44.96	54.00	-9.04	38.34	6.62	Average	158	42
4	5350.00	57.63	74.00	-16.37	51.01	6.62	Peak	158	42
5	10520.00	57.11	68.20	-11.09	40.51	16.60	Peak	258	231
6	15780.00	50.33	54.00	-3.67	33.28	17.05	Average	235	124
7	15780.00	64.27	74.00	-9.73	47.22	17.05	Peak	235	124

Note 1: Emission Level (dBuV/m) = SA Reading (dBuV/m) + Factor\* (dB)

\*Factor includes antenna factor , cable loss and amplifier gain

Note 2: Margin (dB) = Emission level (dBuV/m) – Limit (dBuV/m).



<b>Modulation</b>	HT20	<b>Test Freq. (MHz)</b>	5260
<b>Polarization</b>	Vertical	<b>Test Configuration</b>	3

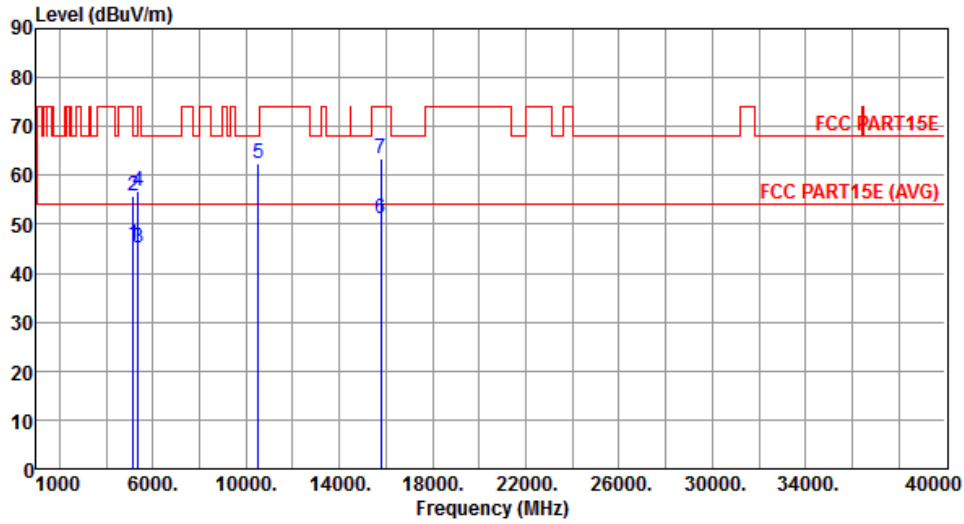

	Freq. MHz	Emission level dBuV/m	Limit dBuV/m	Margin dB	SA reading dBuV	Factor dB	Remark	ANT High cm	Turn Table deg
1	5150.00	45.85	54.00	-8.15	39.54	6.31	Average	287	113
2	5150.00	55.63	74.00	-18.37	49.32	6.31	Peak	287	113
3	5350.00	45.15	54.00	-8.85	38.53	6.62	Average	287	113
4	5350.00	56.87	74.00	-17.13	50.25	6.62	Peak	287	113
5	10520.00	62.27	68.20	-5.93	45.67	16.60	Peak	150	178
6	15780.00	51.17	54.00	-2.83	34.12	17.05	Average	150	173
7	15780.00	63.48	74.00	-10.52	46.43	17.05	Peak	150	173

Note 1: Emission Level (dBuV/m) = SA Reading (dBuV/m) + Factor\* (dB)

\*Factor includes antenna factor , cable loss and amplifier gain

Note 2: Margin (dB) = Emission level (dBuV/m) – Limit (dBuV/m).

<b>Modulation</b>	HT20	<b>Test Freq. (MHz)</b>	5300
<b>Polarization</b>	Horizontal	<b>Test Configuration</b>	3

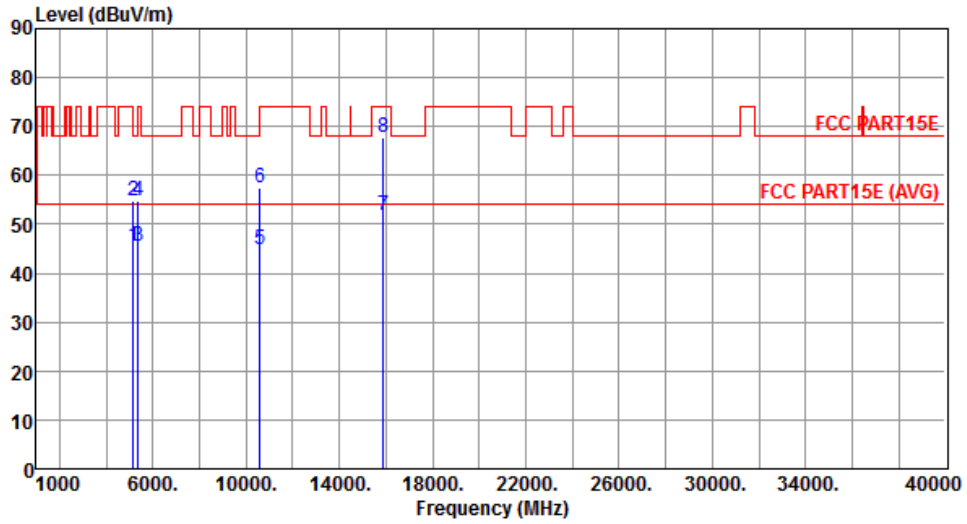

	Freq. MHz	Emission level dBuV/m	Limit dBuV/m	Margin dB	SA reading dBuV	Factor dB	Remark	ANT High cm	Turn Table deg
1	5150.00	45.38	54.00	-8.62	39.07	6.31	Average	185	43
2	5150.00	54.96	74.00	-19.04	48.65	6.31	Peak	185	43
3	5350.00	45.36	54.00	-8.64	38.74	6.62	Average	185	43
4	5350.00	54.82	74.00	-19.18	48.20	6.62	Peak	185	43
5	10600.00	44.88	54.00	-9.12	28.26	16.62	Average	257	235
6	10600.00	57.43	74.00	-16.57	40.81	16.62	Peak	257	235
7	15900.00	51.71	54.00	-2.29	34.89	16.82	Average	240	115
8	15900.00	67.61	74.00	-6.39	50.79	16.82	Peak	240	115

Note 1: Emission Level (dBuV/m) = SA Reading (dBuV/m) + Factor\* (dB)

\*Factor includes antenna factor , cable loss and amplifier gain

Note 2: Margin (dB) = Emission level (dBuV/m) – Limit (dBuV/m).

<b>Modulation</b>	HT20	<b>Test Freq. (MHz)</b>	5300
<b>Polarization</b>	Vertical	<b>Test Configuration</b>	3

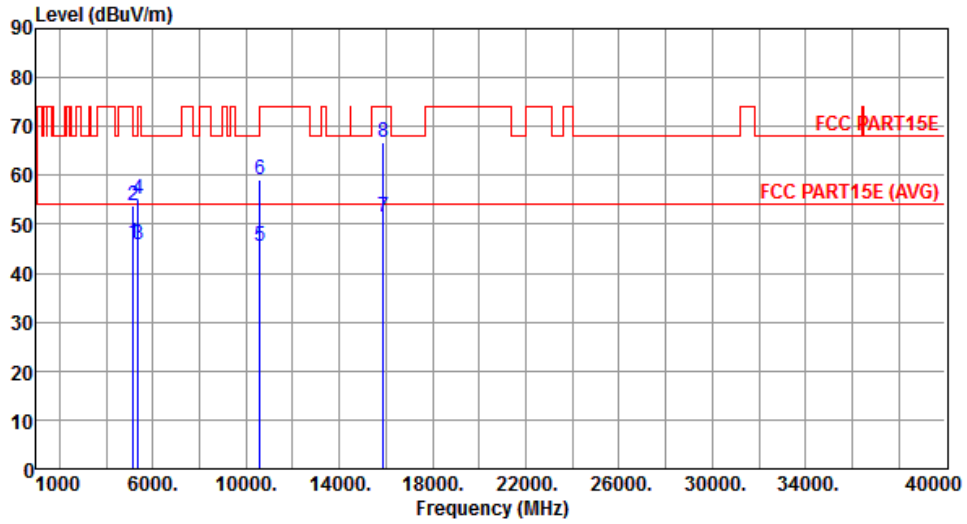

	Freq. MHz	Emission level dBuV/m	Limit dBuV/m	Margin dB	SA reading dBuV	Factor dB	Remark	ANT High cm	Turn Table deg
1	5150.00	46.00	54.00	-8.00	39.69	6.31	Average	311	102
2	5150.00	53.92	74.00	-20.08	47.61	6.31	Peak	311	102
3	5350.00	45.70	54.00	-8.30	39.08	6.62	Average	311	102
4	5350.00	55.15	74.00	-18.85	48.53	6.62	Peak	311	102
5	10600.00	45.48	54.00	-8.52	28.86	16.62	Average	150	174
6	10600.00	59.06	74.00	-14.94	42.44	16.62	Peak	150	174
7	15900.00	51.51	54.00	-2.49	34.69	16.82	Average	150	180
8	15900.00	66.61	74.00	-7.39	49.79	16.82	Peak	150	180

Note 1: Emission Level (dBuV/m) = SA Reading (dBuV/m) + Factor\* (dB)

\*Factor includes antenna factor , cable loss and amplifier gain

Note 2: Margin (dB) = Emission level (dBuV/m) – Limit (dBuV/m).

<b>Modulation</b>	HT20	<b>Test Freq. (MHz)</b>	5320
<b>Polarization</b>	Horizontal	<b>Test Configuration</b>	3

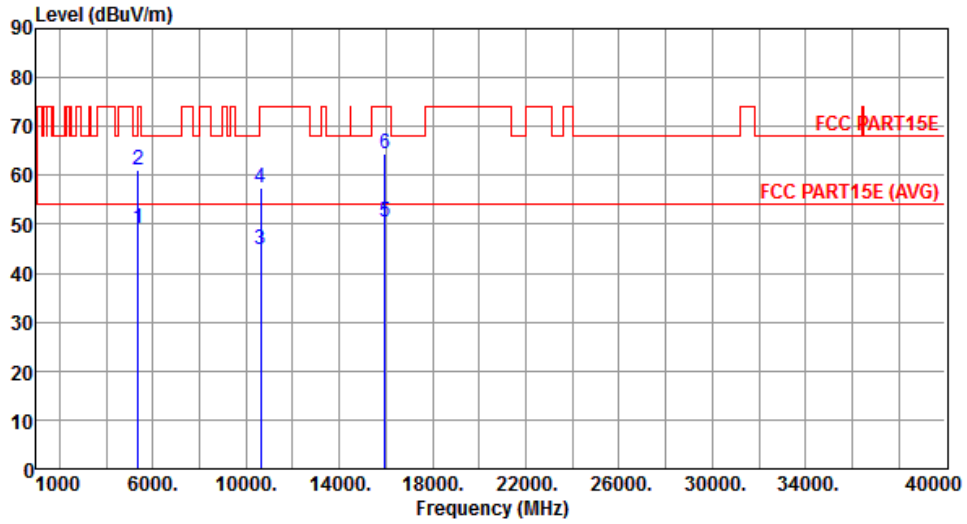

	Freq. MHz	Emission level dBuV/m	Limit dBuV/m	Margin dB	SA reading dBuV	Factor dB	Remark	ANT High cm	Turn Table deg
1	5350.00	49.02	54.00	-4.98	42.40	6.62	Average	150	40
2	5350.00	61.09	74.00	-12.91	54.47	6.62	Peak	150	40
3	10640.00	44.72	54.00	-9.28	28.09	16.63	Average	153	162
4	10640.00	57.43	74.00	-16.57	40.80	16.63	Peak	153	162
5	15960.00	50.33	54.00	-3.67	33.63	16.70	Average	276	138
6	15960.00	64.53	74.00	-9.47	47.83	16.70	Peak	276	138

Note 1: Emission Level (dBuV/m) = SA Reading (dBuV/m) + Factor\* (dB)

\*Factor includes antenna factor , cable loss and amplifier gain

Note 2: Margin (dB) = Emission level (dBuV/m) – Limit (dBuV/m).

<b>Modulation</b>	HT20	<b>Test Freq. (MHz)</b>	5320
<b>Polarization</b>	Vertical	<b>Test Configuration</b>	3

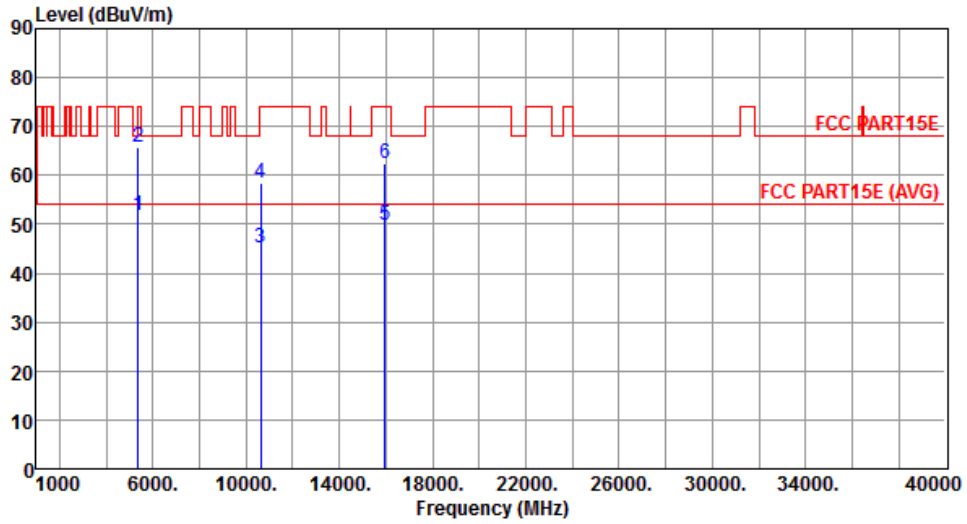

	Freq. MHz	Emission level dBuV/m	Limit dBuV/m	Margin dB	SA reading dBuV	Factor dB	Remark	ANT High cm	Turn Table deg
1	5350.00	51.86	54.00	-2.14	45.24	6.62	Average	220	89
2	5350.00	65.72	74.00	-8.28	59.10	6.62	Peak	220	89
3	10640.00	45.09	54.00	-8.91	28.46	16.63	Average	150	190
4	10640.00	58.33	74.00	-15.67	41.70	16.63	Peak	150	190
5	15960.00	49.77	54.00	-4.23	33.07	16.70	Average	150	181
6	15960.00	62.29	74.00	-11.71	45.59	16.70	Peak	150	181

Note 1: Emission Level (dBuV/m) = SA Reading (dBuV/m) + Factor\* (dB)

\*Factor includes antenna factor , cable loss and amplifier gain

Note 2: Margin (dB) = Emission level (dBuV/m) – Limit (dBuV/m).

<b>Modulation</b>	HT20	<b>Test Freq. (MHz)</b>	5500
<b>Polarization</b>	Horizontal	<b>Test Configuration</b>	3

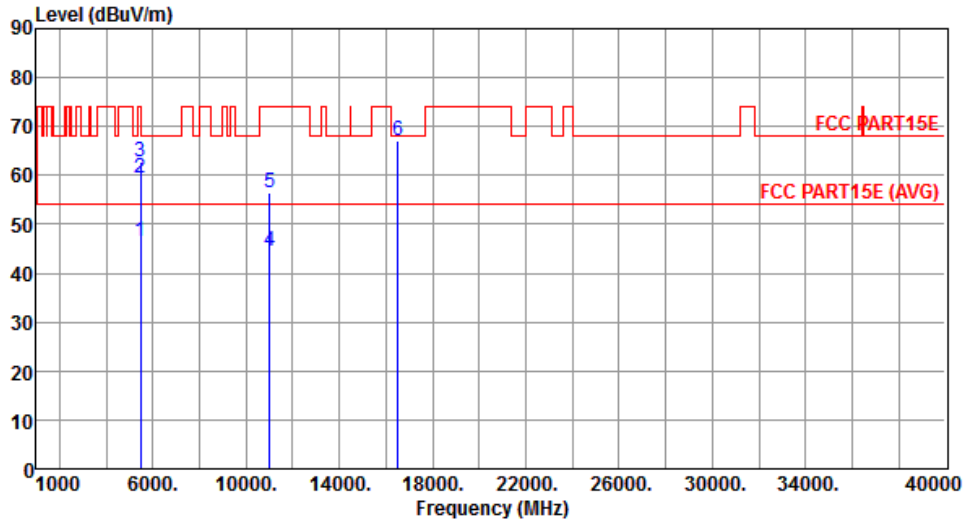

	Freq. MHz	Emission level dBuV/m	Limit dBuV/m	Margin dB	SA reading dBuV	Factor dB	Remark	ANT High cm	Turn Table deg
1	5460.00	46.55	54.00	-7.45	39.79	6.76	Average	271	37
2	5460.00	59.48	74.00	-14.52	52.72	6.76	Peak	271	37
3	5470.00	62.73	68.20	-5.47	55.96	6.77	Peak	271	37
4	11000.00	44.34	54.00	-9.66	27.62	16.72	Average	255	187
5	11000.00	56.57	74.00	-17.43	39.85	16.72	Peak	255	187
6	16500.00	67.09	68.20	-1.11	49.22	17.87	Peak	217	115

Note 1: Emission Level (dBuV/m) = SA Reading (dBuV/m) + Factor\* (dB)

\*Factor includes antenna factor , cable loss and amplifier gain

Note 2: Margin (dB) = Emission level (dBuV/m) – Limit (dBuV/m).

<b>Modulation</b>	HT20	<b>Test Freq. (MHz)</b>	5500
<b>Polarization</b>	Vertical	<b>Test Configuration</b>	3

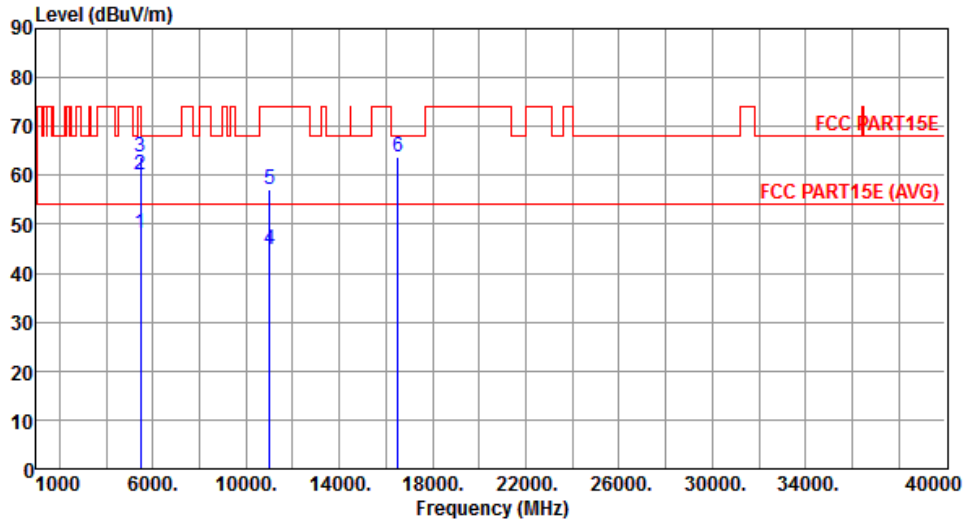

	Freq. MHz	Emission level dBuV/m	Limit dBuV/m	Margin dB	SA reading dBuV	Factor dB	Remark	ANT High cm	Turn Table deg
1	5460.00	47.99	54.00	-6.01	41.23	6.76	Average	150	106
2	5460.00	60.09	74.00	-13.91	53.33	6.76	Peak	150	106
3	5470.00	63.73	68.20	-4.47	56.96	6.77	Peak	150	106
4	11000.00	44.85	54.00	-9.15	28.13	16.72	Average	157	184
5	11000.00	57.15	74.00	-16.85	40.43	16.72	Peak	157	184
6	16500.00	63.78	68.20	-4.42	45.91	17.87	Peak	154	188

Note 1: Emission Level (dBuV/m) = SA Reading (dBuV/m) + Factor\* (dB)

\*Factor includes antenna factor , cable loss and amplifier gain

Note 2: Margin (dB) = Emission level (dBuV/m) – Limit (dBuV/m).

<b>Modulation</b>	HT20	<b>Test Freq. (MHz)</b>	5580
<b>Polarization</b>	Horizontal	<b>Test Configuration</b>	3

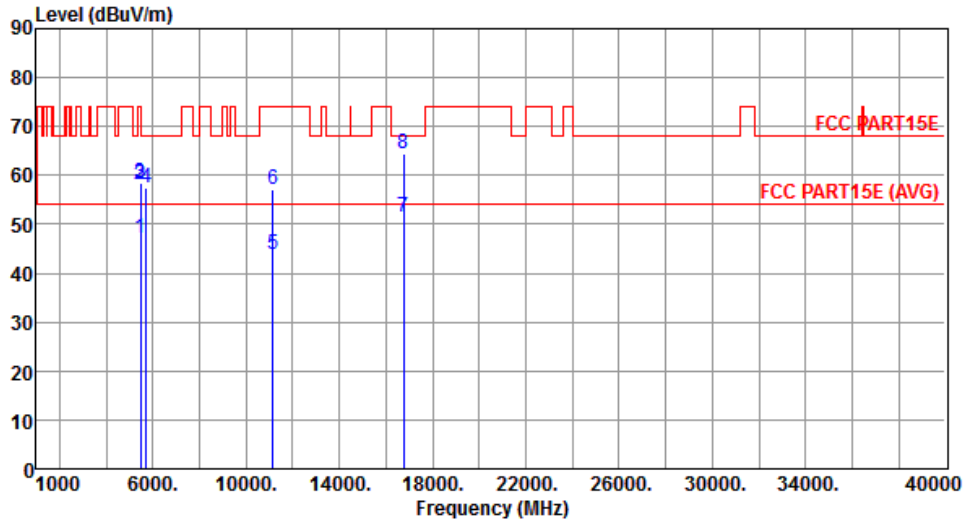

	Freq. MHz	Emission level dBuV/m	Limit dBuV/m	Margin dB	SA reading dBuV	Factor dB	Remark	ANT High cm	Turn Table deg
1	5460.00	47.06	54.00	-6.94	40.30	6.76	Average	240	29
2	5460.00	58.18	74.00	-15.82	51.42	6.76	Peak	240	29
3	5470.00	58.56	68.20	-9.64	51.79	6.77	Peak	240	29
4	5725.00	57.49	68.20	-10.71	50.25	7.24	Peak	240	29
5	11160.00	43.87	54.00	-10.13	27.08	16.79	Average	254	183
6	11160.00	57.06	74.00	-16.94	40.27	16.79	Peak	254	183
7	16740.00	51.64	54.00	-2.36	33.24	18.40	Average	186	122
8	16740.00	64.38	68.20	-3.82	45.98	18.40	Peak	186	122

Note 1: Emission Level (dBuV/m) = SA Reading (dBuV/m) + Factor\* (dB)

\*Factor includes antenna factor , cable loss and amplifier gain

Note 2: Margin (dB) = Emission level (dBuV/m) – Limit (dBuV/m).



<b>Modulation</b>	HT20	<b>Test Freq. (MHz)</b>	5580
<b>Polarization</b>	Vertical	<b>Test Configuration</b>	3

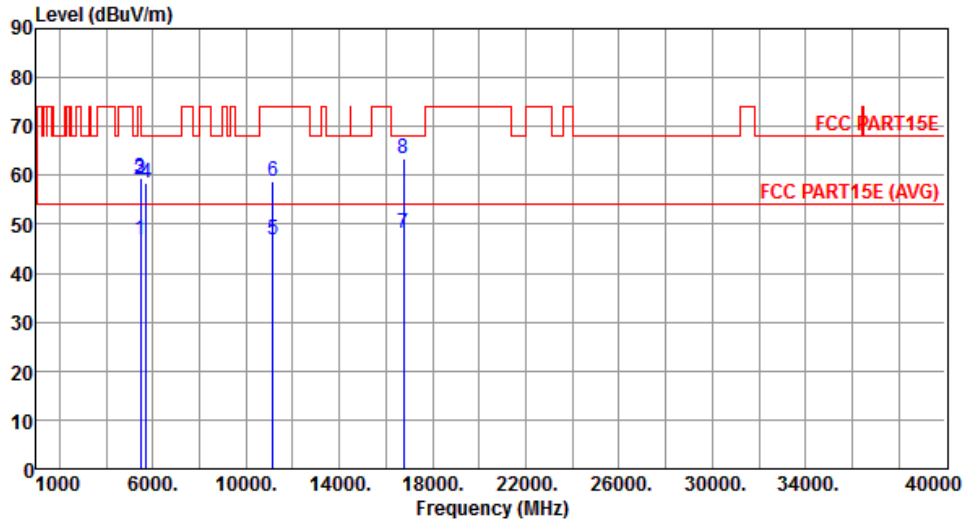

	Freq. MHz	Emission level dBuV/m	Limit dBuV/m	Margin dB	SA reading dBuV	Factor dB	Remark	ANT High cm	Turn Table deg
1	5460.00	46.91	54.00	-7.09	40.15	6.76	Average	331	111
2	5460.00	59.12	74.00	-14.88	52.36	6.76	Peak	331	111
3	5470.00	59.60	68.20	-8.60	52.83	6.77	Peak	331	111
4	5725.00	58.35	68.20	-9.85	51.11	7.24	Peak	331	111
5	11160.00	46.74	54.00	-7.26	29.95	16.79	Average	172	185
6	11160.00	58.83	74.00	-15.17	42.04	16.79	Peak	172	185
7	16740.00	48.23	54.00	-5.77	29.83	18.40	Average	160	183
8	16740.00	63.37	68.20	-4.83	44.97	18.40	Peak	160	183

Note 1: Emission Level (dBuV/m) = SA Reading (dBuV/m) + Factor\* (dB)

\*Factor includes antenna factor , cable loss and amplifier gain

Note 2: Margin (dB) = Emission level (dBuV/m) – Limit (dBuV/m).

<b>Modulation</b>	HT20	<b>Test Freq. (MHz)</b>	5700
<b>Polarization</b>	Horizontal	<b>Test Configuration</b>	3

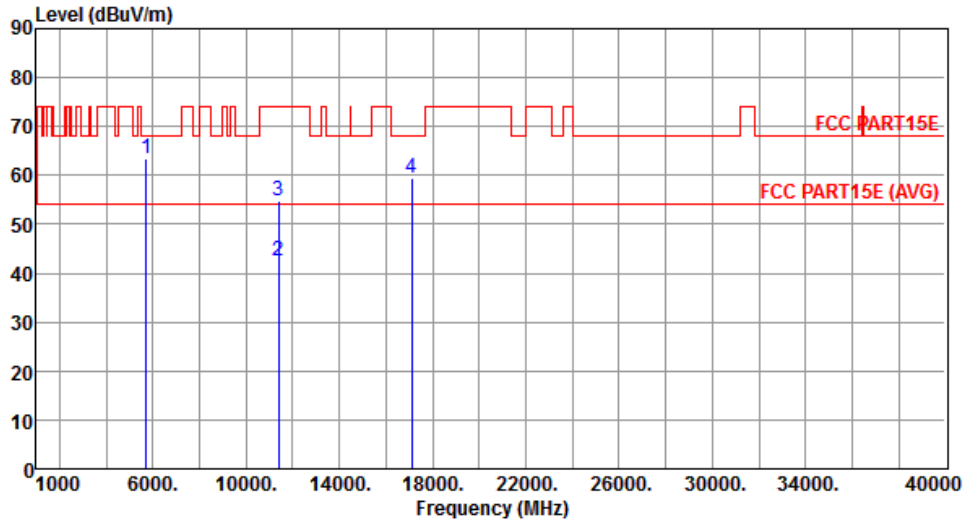

	Freq. MHz	Emission level dBuV/m	Limit dBuV/m	Margin dB	SA reading dBuV	Factor dB	Remark	ANT High cm	Turn Table deg
1	5725.00	63.46	68.20	-4.74	56.22	7.24	Peak	236	26
2	11400.00	42.43	54.00	-11.57	25.55	16.88	Average	274	134
3	11400.00	54.78	74.00	-19.22	37.90	16.88	Peak	274	134
4	17100.00	59.30	68.20	-8.90	40.18	19.12	Peak	269	112

Note 1: Emission Level (dBuV/m) = SA Reading (dBuV/m) + Factor\* (dB)

\*Factor includes antenna factor , cable loss and amplifier gain

Note 2: Margin (dB) = Emission level (dBuV/m) – Limit (dBuV/m).

<b>Modulation</b>	HT20	<b>Test Freq. (MHz)</b>	5700
<b>Polarization</b>	Vertical	<b>Test Configuration</b>	3

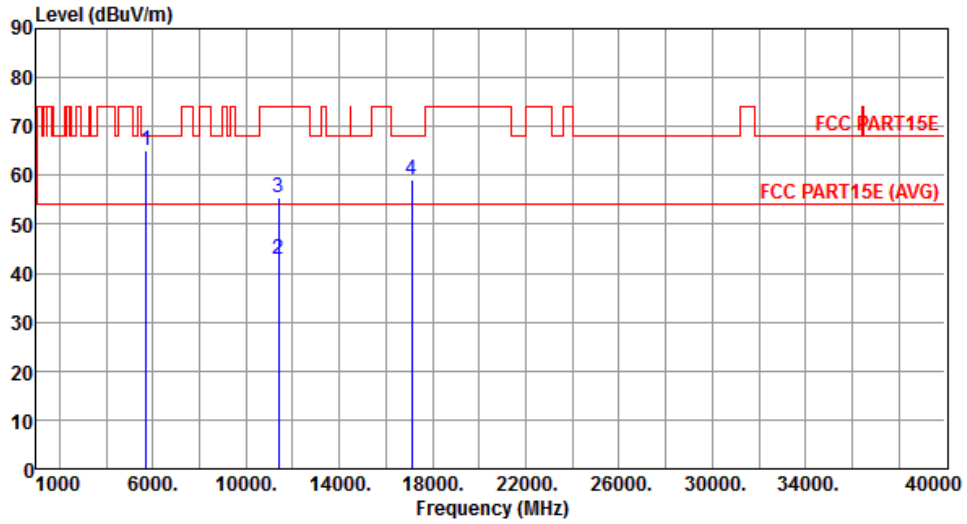

	Freq. MHz	Emission level dBuV/m	Limit dBuV/m	Margin dB	SA reading dBuV	Factor dB	Remark	ANT High cm	Turn Table deg
1	5725.00	65.12	68.20	-3.08	57.88	7.24	Peak	209	92
2	11400.00	42.78	54.00	-11.22	25.90	16.88	Average	172	344
3	11400.00	55.34	74.00	-18.66	38.46	16.88	Peak	172	334
4	17100.00	59.03	68.20	-9.17	39.91	19.12	Peak	182	174

Note 1: Emission Level (dBuV/m) = SA Reading (dBuV/m) + Factor\* (dB)

\*Factor includes antenna factor , cable loss and amplifier gain

Note 2: Margin (dB) = Emission level (dBuV/m) – Limit (dBuV/m).

<b>Modulation</b>	HT20	<b>Test Freq. (MHz)</b>	5745
<b>Polarization</b>	Horizontal	<b>Test Configuration</b>	3

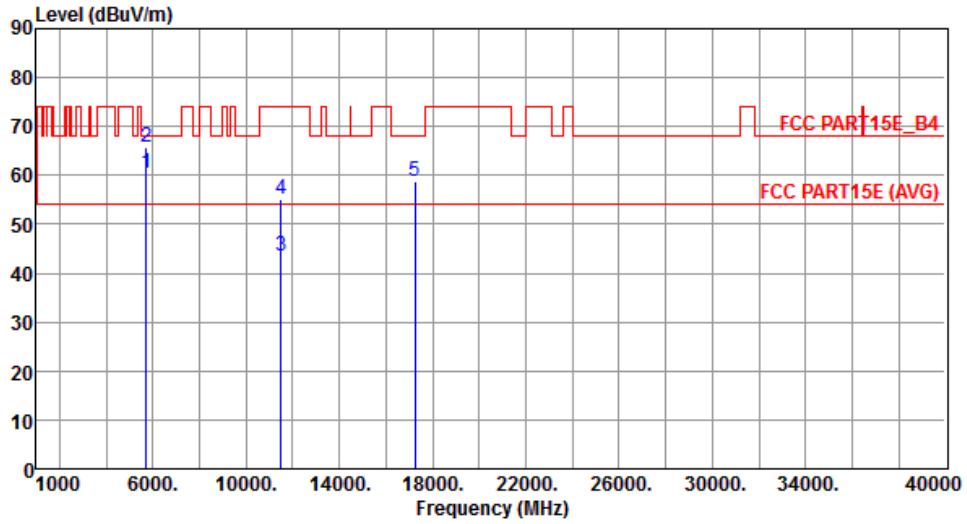

	Freq. MHz	Emission level dBuV/m	Limit dBuV/m	Margin dB	SA reading dBuV	Factor dB	Remark	ANT High cm	Turn Table deg
1	5715.00	60.51	68.20	-7.69	53.31	7.20	Peak	314	206
2	5725.00	65.65	78.20	-12.55	58.41	7.24	Peak	314	206
3	11490.00	43.34	54.00	-10.66	26.43	16.91	Average	255	231
4	11490.00	55.16	74.00	-18.84	38.25	16.91	Peak	255	231
5	17235.00	58.89	68.20	-9.31	39.57	19.32	Peak	153	194

Note 1: Emission Level (dBuV/m) = SA Reading (dBuV/m) + Factor\* (dB)

\*Factor includes antenna factor , cable loss and amplifier gain

Note 2: Margin (dB) = Emission level (dBuV/m) – Limit (dBuV/m).

<b>Modulation</b>	HT20	<b>Test Freq. (MHz)</b>	5745
<b>Polarization</b>	Vertical	<b>Test Configuration</b>	3

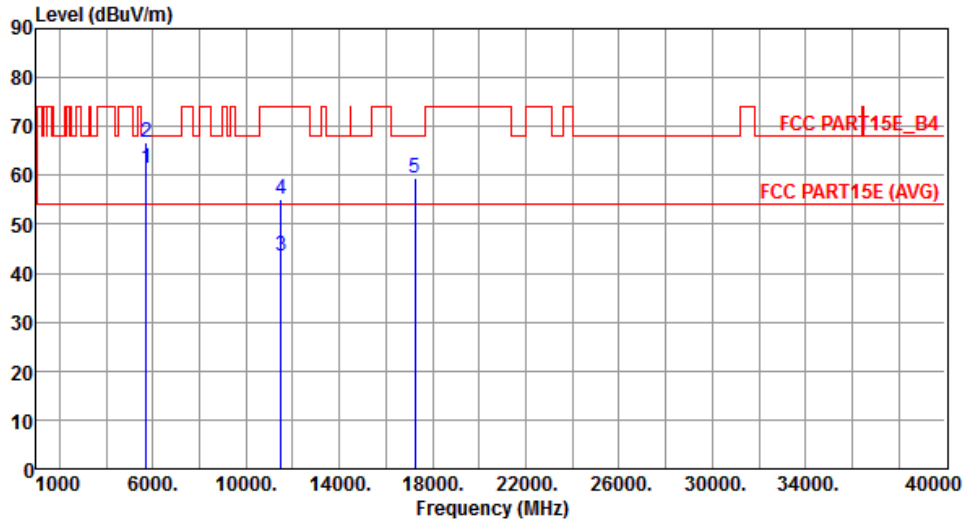

	Freq. MHz	Emission level dBuV/m	Limit dBuV/m	Margin dB	SA reading dBuV	Factor dB	Remark	ANT High cm	Turn Table deg
1	5715.00	61.45	68.20	-6.75	54.25	7.20	Peak	150	105
2	5725.00	66.90	78.20	-11.30	59.66	7.24	Peak	150	105
3	11490.00	43.50	54.00	-10.50	26.59	16.91	Average	218	162
4	11490.00	55.29	74.00	-18.71	38.38	16.91	Peak	218	162
5	17235.00	59.46	68.20	-8.74	40.14	19.32	Peak	185	185

Note 1: Emission Level (dBuV/m) = SA Reading (dBuV/m) + Factor\* (dB)

\*Factor includes antenna factor , cable loss and amplifier gain

Note 2: Margin (dB) = Emission level (dBuV/m) – Limit (dBuV/m).

<b>Modulation</b>	HT20	<b>Test Freq. (MHz)</b>	5785
<b>Polarization</b>	Horizontal	<b>Test Configuration</b>	3

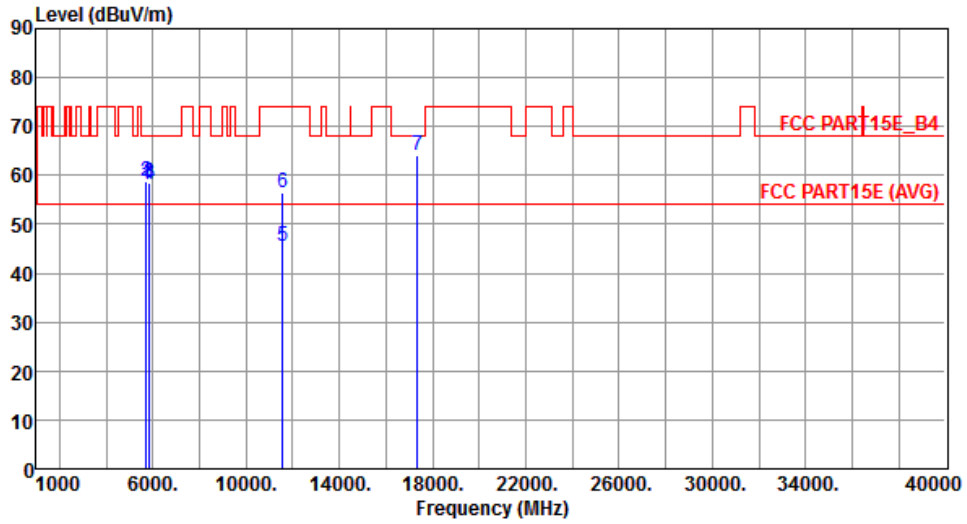

	Freq. MHz	Emission level dBuV/m	Limit dBuV/m	Margin dB	SA reading dBuV	Factor dB	Remark	ANT High cm	Turn Table deg
1	5715.00	58.24	68.20	-9.96	51.04	7.20	Peak	284	202
2	5725.00	58.83	78.20	-19.37	51.59	7.24	Peak	284	202
3	5850.00	58.49	78.20	-19.71	50.99	7.50	Peak	284	202
4	5860.00	58.14	68.20	-10.06	50.63	7.51	Peak	284	202
5	11570.00	45.63	54.00	-8.37	28.83	16.80	Average	289	121
6	11570.00	56.33	74.00	-17.67	39.53	16.80	Peak	289	121
7	17355.00	64.09	68.20	-4.11	44.60	19.49	Peak	185	130

Note 1: Emission Level (dBuV/m) = SA Reading (dBuV/m) + Factor\* (dB)

\*Factor includes antenna factor , cable loss and amplifier gain

Note 2: Margin (dB) = Emission level (dBuV/m) – Limit (dBuV/m).

<b>Modulation</b>	HT20	<b>Test Freq. (MHz)</b>	5785
<b>Polarization</b>	Vertical	<b>Test Configuration</b>	3

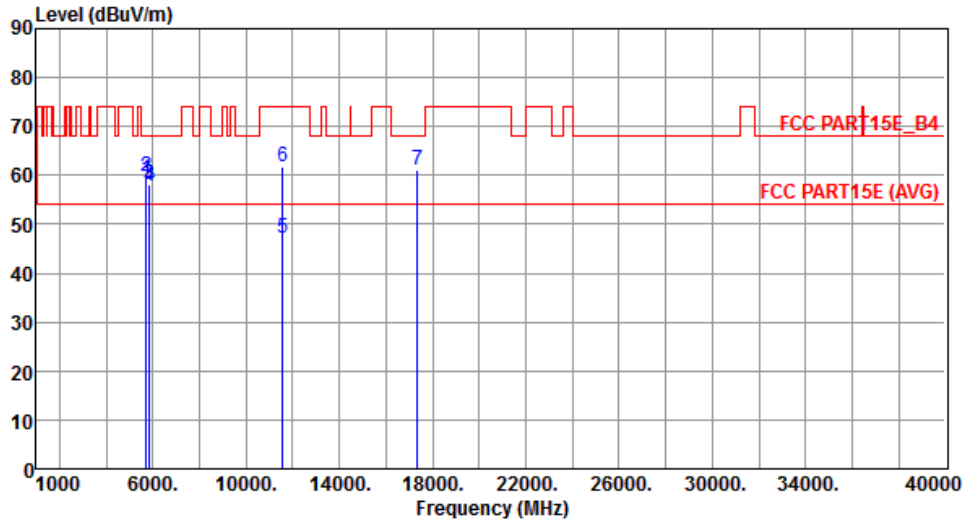

	Freq. MHz	Emission level dBuV/m	Limit dBuV/m	Margin dB	SA reading dBuV	Factor dB	Remark	ANT High cm	Turn Table deg
1	5715.00	59.19	68.20	-9.01	51.99	7.20	Peak	321	112
2	5725.00	59.94	78.20	-18.26	52.70	7.24	Peak	321	112
3	5850.00	58.05	78.20	-20.15	50.55	7.50	Peak	321	112
4	5860.00	57.78	68.20	-10.42	50.27	7.51	Peak	321	112
5	11570.00	47.28	54.00	-6.72	30.48	16.80	Average	203	187
6	11570.00	61.78	74.00	-12.22	44.98	16.80	Peak	203	187
7	17355.00	60.99	68.20	-7.21	41.50	19.49	Peak	169	165

Note 1: Emission Level (dBuV/m) = SA Reading (dBuV/m) + Factor\* (dB)

\*Factor includes antenna factor , cable loss and amplifier gain

Note 2: Margin (dB) = Emission level (dBuV/m) – Limit (dBuV/m).

<b>Modulation</b>	HT20	<b>Test Freq. (MHz)</b>	5825
<b>Polarization</b>	Horizontal	<b>Test Configuration</b>	3

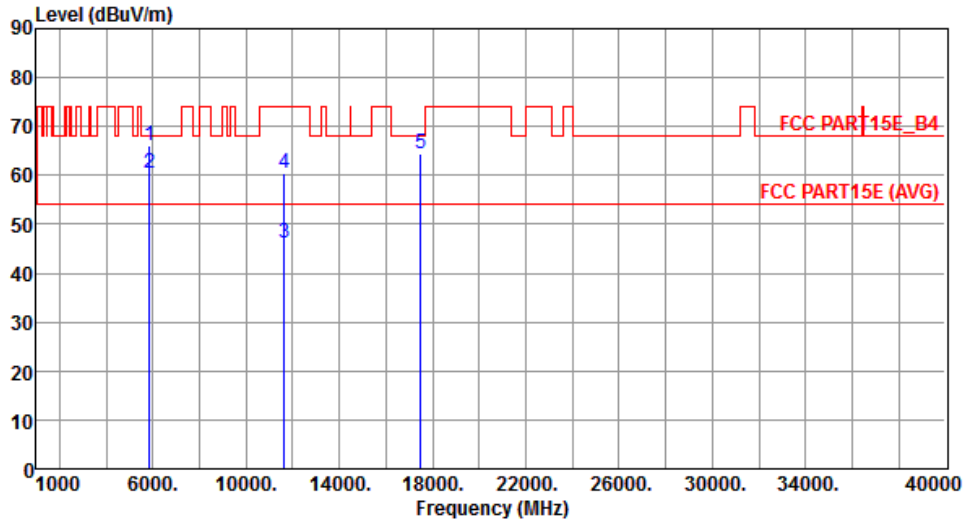

	Freq. MHz	Emission level dBuV/m	Limit dBuV/m	Margin dB	SA reading dBuV	Factor dB	Remark	ANT High cm	Turn Table deg
1	5850.00	66.12	78.20	-12.08	58.62	7.50	Peak	265	203
2	5860.00	60.56	68.20	-7.64	53.05	7.51	Peak	265	203
3	11650.00	46.22	54.00	-7.78	29.57	16.65	Average	158	163
4	11650.00	60.59	74.00	-13.41	43.94	16.65	Peak	158	163
5	17475.00	64.44	68.20	-3.76	44.78	19.66	Peak	278	241

Note 1: Emission Level (dBuV/m) = SA Reading (dBuV/m) + Factor\* (dB)

\*Factor includes antenna factor , cable loss and amplifier gain

Note 2: Margin (dB) = Emission level (dBuV/m) – Limit (dBuV/m).



<b>Modulation</b>	HT20	<b>Test Freq. (MHz)</b>	5825
<b>Polarization</b>	Vertical	<b>Test Configuration</b>	3

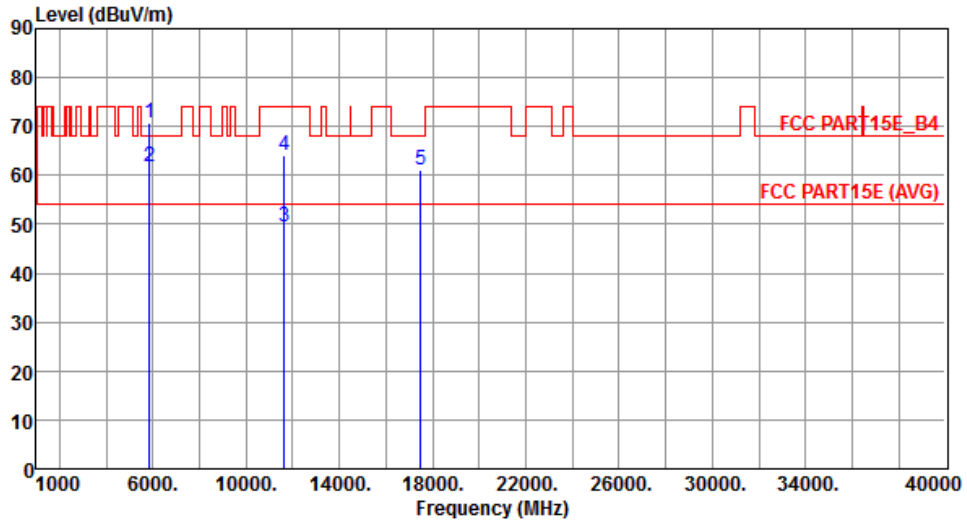

	Freq. MHz	Emission level dBuV/m	Limit dBuV/m	Margin dB	SA reading dBuV	Factor dB	Remark	ANT High cm	Turn Table deg
1	5850.00	70.82	78.20	-7.38	63.32	7.50	Peak	209	92
2	5860.00	61.70	68.20	-6.50	54.19	7.51	Peak	209	92
3	11650.00	49.57	54.00	-4.43	32.92	16.65	Average	179	172
4	11650.00	64.12	74.00	-9.88	47.47	16.65	Peak	179	172
5	17475.00	60.96	68.20	-7.24	41.30	19.66	Peak	162	187

Note 1: Emission Level (dBuV/m) = SA Reading (dBuV/m) + Factor\* (dB)

\*Factor includes antenna factor , cable loss and amplifier gain

Note 2: Margin (dB) = Emission level (dBuV/m) – Limit (dBuV/m).

### 3.5.15 Transmitter Radiated Unwanted Emissions (Above 1GHz) for HT40

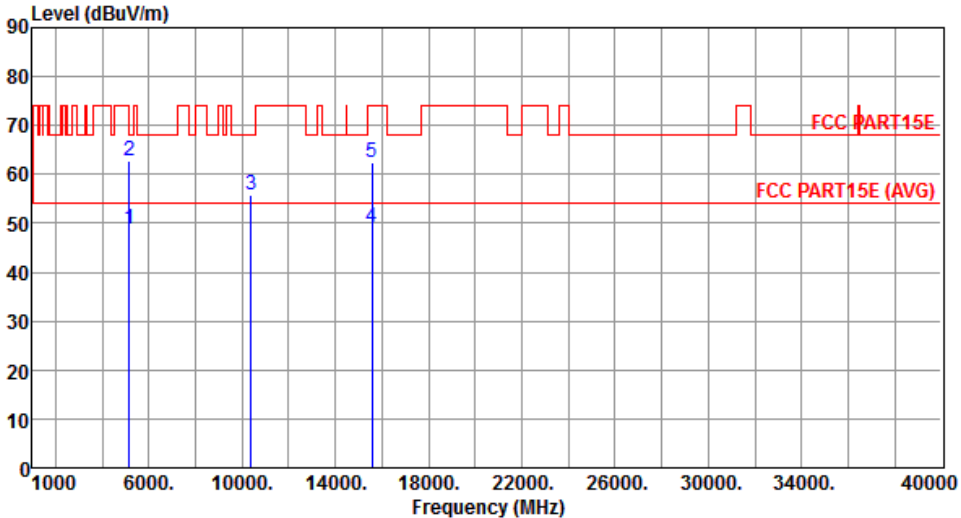
Modulation	HT40	Test Freq. (MHz)	5190																																																																					
Polarization	Horizontal	Test Configuration	3																																																																					
																																																																								
	<table border="1"> <thead> <tr> <th>Freq.</th> <th>Emission level</th> <th>Limit</th> <th>Margin</th> <th>SA reading</th> <th>Factor</th> <th>Remark</th> <th>ANT High cm</th> <th>Turn Table deg</th> </tr> <tr> <th>MHz</th> <th>dBuV/m</th> <th>dBuV/m</th> <th>dB</th> <th>dBuV</th> <th>dB</th> <th></th> <th></th> <th></th> </tr> </thead> <tbody> <tr> <td>1</td> <td>5150.00</td> <td>48.74</td> <td>54.00</td> <td>-5.26</td> <td>42.43</td> <td>6.31</td> <td>Average</td> <td>245</td> <td>211</td> </tr> <tr> <td>2</td> <td>5150.00</td> <td>62.84</td> <td>74.00</td> <td>-11.16</td> <td>56.53</td> <td>6.31</td> <td>Peak</td> <td>245</td> <td>211</td> </tr> <tr> <td>3</td> <td>10380.00</td> <td>55.72</td> <td>68.20</td> <td>-12.48</td> <td>39.35</td> <td>16.37</td> <td>Peak</td> <td>346</td> <td>138</td> </tr> <tr> <td>4</td> <td>15570.00</td> <td>49.02</td> <td>54.00</td> <td>-4.98</td> <td>31.59</td> <td>17.43</td> <td>Average</td> <td>167</td> <td>131</td> </tr> <tr> <td>5</td> <td>15570.00</td> <td>62.54</td> <td>74.00</td> <td>-11.46</td> <td>45.11</td> <td>17.43</td> <td>Peak</td> <td>167</td> <td>131</td> </tr> </tbody> </table>	Freq.	Emission level	Limit	Margin	SA reading	Factor	Remark	ANT High cm	Turn Table deg	MHz	dBuV/m	dBuV/m	dB	dBuV	dB				1	5150.00	48.74	54.00	-5.26	42.43	6.31	Average	245	211	2	5150.00	62.84	74.00	-11.16	56.53	6.31	Peak	245	211	3	10380.00	55.72	68.20	-12.48	39.35	16.37	Peak	346	138	4	15570.00	49.02	54.00	-4.98	31.59	17.43	Average	167	131	5	15570.00	62.54	74.00	-11.46	45.11	17.43	Peak	167	131			
Freq.	Emission level	Limit	Margin	SA reading	Factor	Remark	ANT High cm	Turn Table deg																																																																
MHz	dBuV/m	dBuV/m	dB	dBuV	dB																																																																			
1	5150.00	48.74	54.00	-5.26	42.43	6.31	Average	245	211																																																															
2	5150.00	62.84	74.00	-11.16	56.53	6.31	Peak	245	211																																																															
3	10380.00	55.72	68.20	-12.48	39.35	16.37	Peak	346	138																																																															
4	15570.00	49.02	54.00	-4.98	31.59	17.43	Average	167	131																																																															
5	15570.00	62.54	74.00	-11.46	45.11	17.43	Peak	167	131																																																															
<p>Note 1: Emission Level (dBuV/m) = SA Reading (dBuV/m) + Factor* (dB)            *Factor includes antenna factor , cable loss and amplifier gain            Note 2: Margin (dB) = Emission level (dBuV/m) – Limit (dBuV/m).</p>																																																																								

<b>Modulation</b>	HT40	<b>Test Freq. (MHz)</b>	5190
<b>Polarization</b>	Vertical	<b>Test Configuration</b>	3

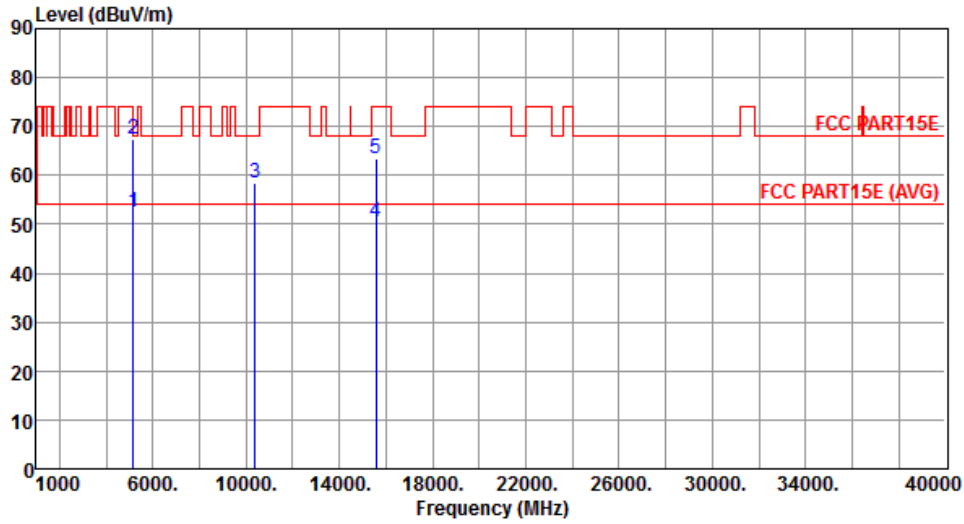

	Freq. MHz	Emission level dBuV/m	Limit dBuV/m	Margin dB	SA reading dBuV	Factor dB	Remark	ANT High cm	Turn Table deg
1	5150.00	52.62	54.00	-1.38	46.31	6.31	Average	332	110
2	5150.00	67.53	74.00	-6.47	61.22	6.31	Peak	332	110
3	10380.00	58.32	68.20	-9.88	41.95	16.37	Peak	374	178
4	15570.00	50.63	54.00	-3.37	33.20	17.43	Average	158	182
5	15570.00	63.51	74.00	-10.49	46.08	17.43	Peak	158	182

Note 1: Emission Level (dBuV/m) = SA Reading (dBuV/m) + Factor\* (dB)

\*Factor includes antenna factor , cable loss and amplifier gain

Note 2: Margin (dB) = Emission level (dBuV/m) – Limit (dBuV/m).

<b>Modulation</b>	HT40	<b>Test Freq. (MHz)</b>	5230
<b>Polarization</b>	Horizontal	<b>Test Configuration</b>	3

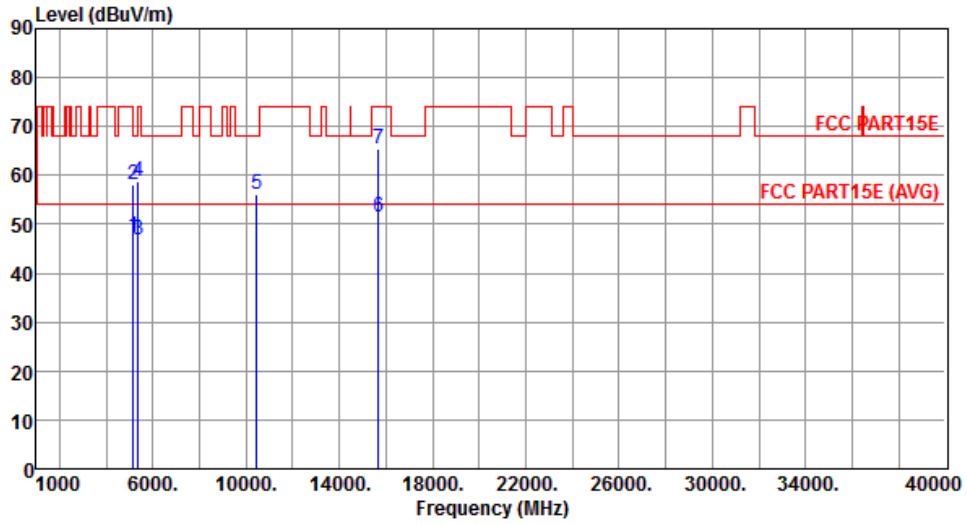

	Freq. MHz	Emission level dBuV/m	Limit dBuV/m	Margin dB	SA reading dBuV	Factor dB	Remark	ANT High cm	Turn Table deg
1	5150.00	47.62	54.00	-6.38	41.31	6.31	Average	158	33
2	5150.00	58.20	74.00	-15.80	51.89	6.31	Peak	158	33
3	5350.00	46.87	54.00	-7.13	40.25	6.62	Average	158	33
4	5350.00	58.92	74.00	-15.08	52.30	6.62	Peak	158	33
5	10460.00	56.19	68.20	-12.01	39.66	16.53	Peak	355	142
6	15690.00	51.35	54.00	-2.65	34.13	17.22	Average	163	132
7	15690.00	65.48	74.00	-8.52	48.26	17.22	Peak	163	132

Note 1: Emission Level (dBuV/m) = SA Reading (dBuV/m) + Factor\* (dB)

\*Factor includes antenna factor , cable loss and amplifier gain

Note 2: Margin (dB) = Emission level (dBuV/m) – Limit (dBuV/m).

<b>Modulation</b>	HT40	<b>Test Freq. (MHz)</b>	5230
<b>Polarization</b>	Vertical	<b>Test Configuration</b>	3

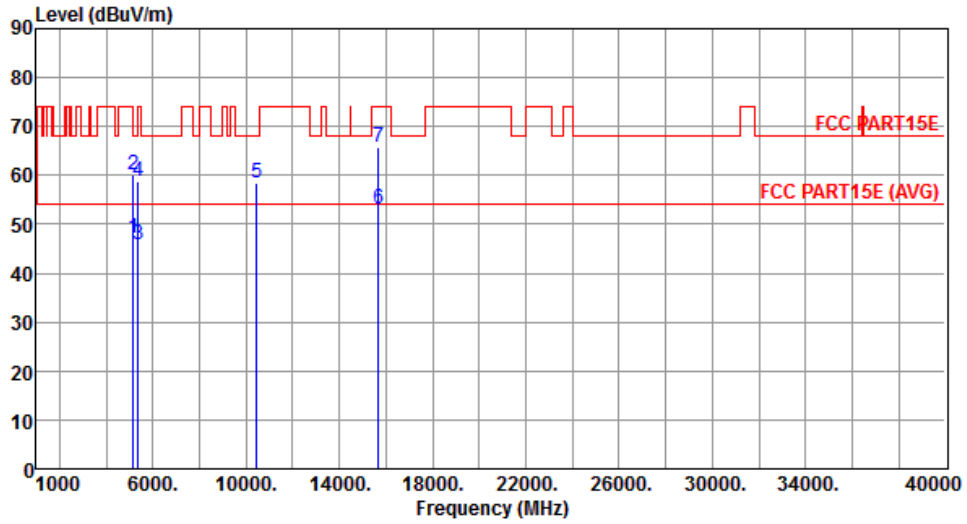

	Freq. MHz	Emission level dBuV/m	Limit dBuV/m	Margin dB	SA reading dBuV	Factor dB	Remark	ANT High cm	Turn Table deg
1	5150.00	47.25	54.00	-6.75	40.94	6.31	Average	326	110
2	5150.00	60.11	74.00	-13.89	53.80	6.31	Peak	326	110
3	5350.00	45.97	54.00	-8.03	39.35	6.62	Average	326	110
4	5350.00	58.69	74.00	-15.31	52.07	6.62	Peak	326	110
5	10460.00	58.32	68.20	-9.88	41.79	16.53	Peak	374	178
6	15690.00	53.12	54.00	-0.88	35.90	17.22	Average	151	188
7	15690.00	65.80	74.00	-8.20	48.58	17.22	Peak	151	188

Note 1: Emission Level (dBuV/m) = SA Reading (dBuV/m) + Factor\* (dB)

\*Factor includes antenna factor , cable loss and amplifier gain

Note 2: Margin (dB) = Emission level (dBuV/m) – Limit (dBuV/m).

<b>Modulation</b>	HT40	<b>Test Freq. (MHz)</b>	5270
<b>Polarization</b>	Horizontal	<b>Test Configuration</b>	3

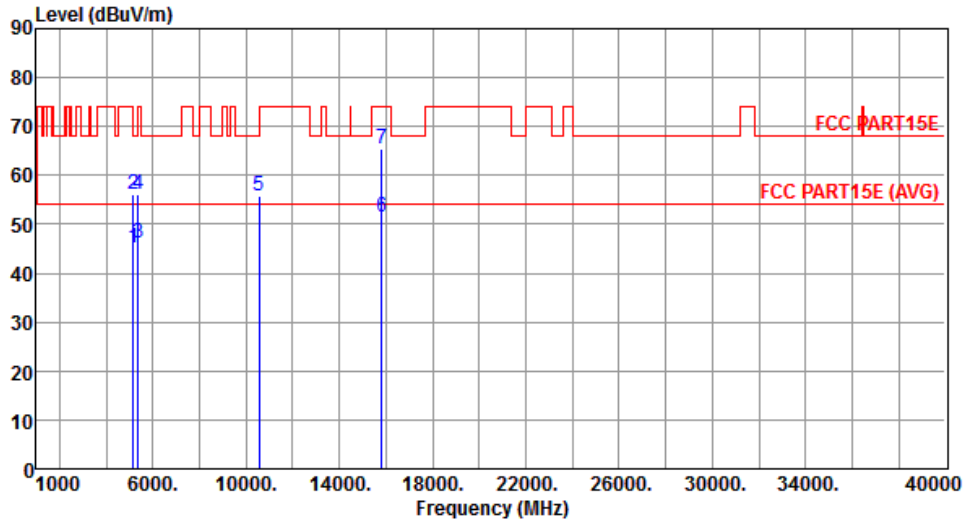

	Freq. MHz	Emission level dBuV/m	Limit dBuV/m	Margin dB	SA reading dBuV	Factor dB	Remark	ANT High cm	Turn Table deg
1	5150.00	45.09	54.00	-8.91	38.78	6.31	Average	150	34
2	5150.00	56.19	74.00	-17.81	49.88	6.31	Peak	150	34
3	5350.00	46.19	54.00	-7.81	39.57	6.62	Average	150	34
4	5350.00	56.02	74.00	-17.98	49.40	6.62	Peak	150	34
5	10540.00	55.87	68.20	-12.33	39.27	16.60	Peak	177	238
6	15810.00	51.41	54.00	-2.59	34.43	16.98	Average	150	241
7	15810.00	65.26	74.00	-8.74	48.28	16.98	Peak	150	241

Note 1: Emission Level (dBuV/m) = SA Reading (dBuV/m) + Factor\* (dB)

\*Factor includes antenna factor , cable loss and amplifier gain

Note 2: Margin (dB) = Emission level (dBuV/m) – Limit (dBuV/m).

<b>Modulation</b>	HT40	<b>Test Freq. (MHz)</b>	5270
<b>Polarization</b>	Vertical	<b>Test Configuration</b>	3

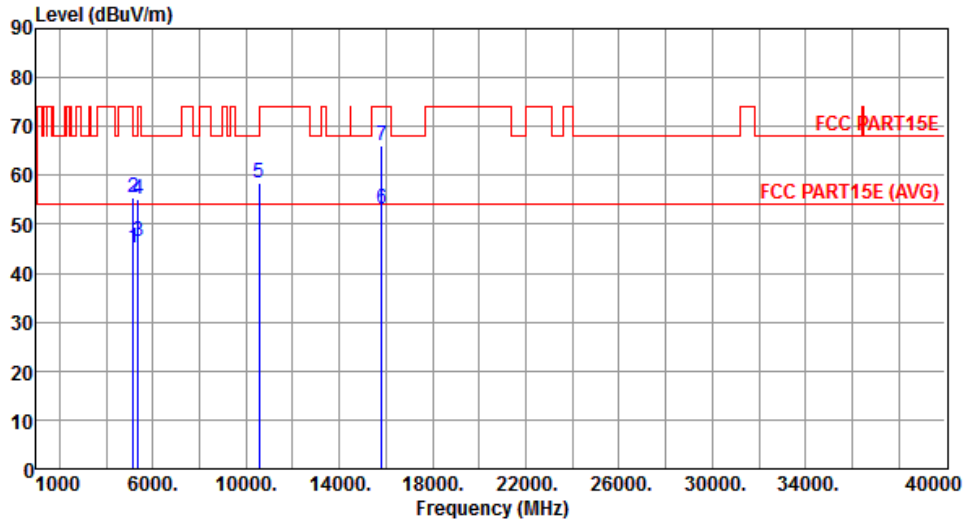

	Freq. MHz	Emission level dBuV/m	Limit dBuV/m	Margin dB	SA reading dBuV	Factor dB	Remark	ANT High cm	Turn Table deg
1	5150.00	45.32	54.00	-8.68	39.01	6.31	Average	322	108
2	5150.00	55.56	74.00	-18.44	49.25	6.31	Peak	322	108
3	5350.00	46.49	54.00	-7.51	39.87	6.62	Average	322	108
4	5350.00	55.21	74.00	-18.79	48.59	6.62	Peak	322	108
5	10540.00	58.29	68.20	-9.91	41.69	16.60	Peak	376	198
6	15810.00	53.11	54.00	-0.89	36.13	16.98	Average	153	187
7	15810.00	66.22	74.00	-7.78	49.24	16.98	Peak	153	187

Note 1: Emission Level (dBuV/m) = SA Reading (dBuV/m) + Factor\* (dB)

\*Factor includes antenna factor , cable loss and amplifier gain

Note 2: Margin (dB) = Emission level (dBuV/m) – Limit (dBuV/m).

<b>Modulation</b>	HT40	<b>Test Freq. (MHz)</b>	5310
<b>Polarization</b>	Horizontal	<b>Test Configuration</b>	3

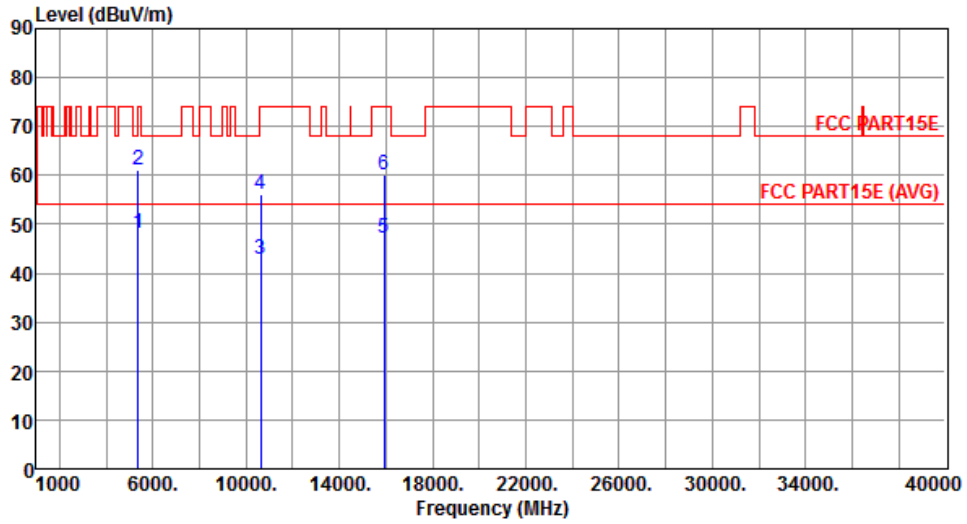

	Freq. MHz	Emission level dBuV/m	Limit dBuV/m	Margin dB	SA reading dBuV	Factor dB	Remark	ANT High cm	Turn Table deg
1	5350.00	48.19	54.00	-5.81	41.57	6.62	Average	150	39
2	5350.00	61.18	74.00	-12.82	54.56	6.62	Peak	150	39
3	10620.00	42.94	54.00	-11.06	26.32	16.62	Average	310	260
4	10620.00	56.18	74.00	-17.82	39.56	16.62	Peak	310	260
5	15930.00	47.22	54.00	-6.78	30.45	16.77	Average	254	133
6	15930.00	60.17	74.00	-13.83	43.40	16.77	Peak	254	133

Note 1: Emission Level (dBuV/m) = SA Reading (dBuV/m) + Factor\* (dB)

\*Factor includes antenna factor , cable loss and amplifier gain

Note 2: Margin (dB) = Emission level (dBuV/m) – Limit (dBuV/m).



<b>Modulation</b>	HT40	<b>Test Freq. (MHz)</b>	5310
<b>Polarization</b>	Vertical	<b>Test Configuration</b>	3

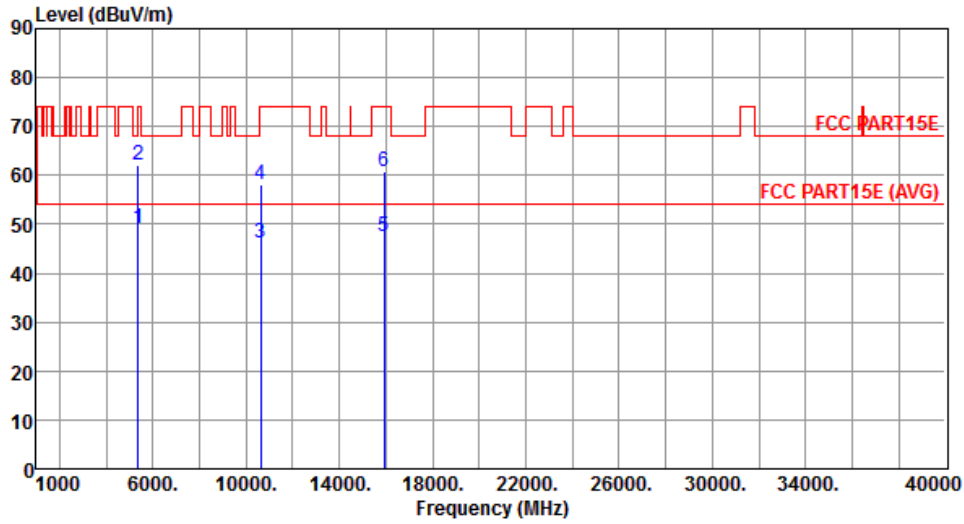

	Freq. MHz	Emission level dBuV/m	Limit dBuV/m	Margin dB	SA reading dBuV	Factor dB	Remark	ANT High cm	Turn Table deg
1	5350.00	49.17	54.00	-4.83	42.55	6.62	Average	293	120
2	5350.00	61.98	74.00	-12.02	55.36	6.62	Peak	293	120
3	10620.00	46.02	54.00	-7.98	29.40	16.62	Average	261	209
4	10620.00	58.08	74.00	-15.92	41.46	16.62	Peak	261	209
5	15930.00	47.45	54.00	-6.55	30.68	16.77	Average	155	186
6	15930.00	60.63	74.00	-13.37	43.86	16.77	Peak	155	186

Note 1: Emission Level (dBuV/m) = SA Reading (dBuV/m) + Factor\* (dB)

\*Factor includes antenna factor , cable loss and amplifier gain

Note 2: Margin (dB) = Emission level (dBuV/m) – Limit (dBuV/m).

<b>Modulation</b>	HT40	<b>Test Freq. (MHz)</b>	5510
<b>Polarization</b>	Horizontal	<b>Test Configuration</b>	3

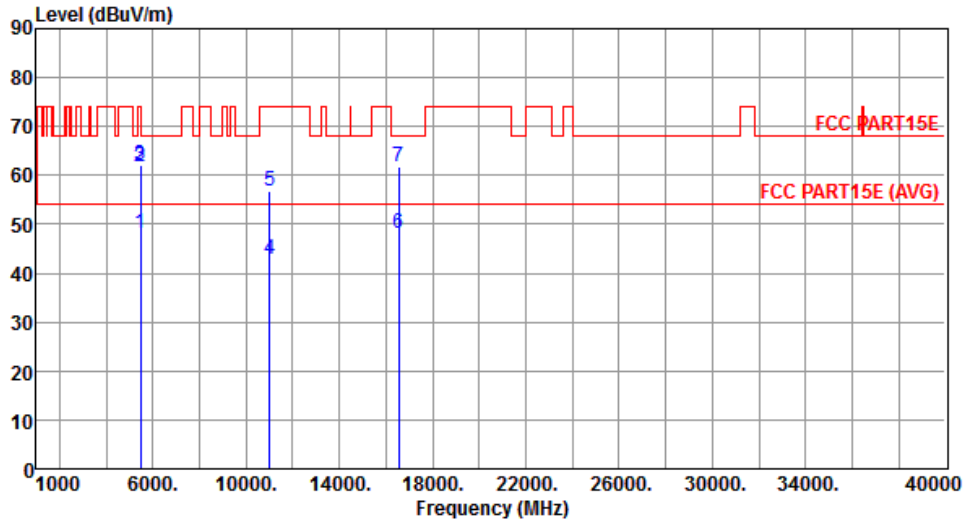

	Freq. MHz	Emission level dBuV/m	Limit dBuV/m	Margin dB	SA reading dBuV	Factor dB	Remark	ANT High cm	Turn Table deg
1	5460.00	48.03	54.00	-5.97	41.27	6.76	Average	150	41
2	5460.00	61.78	74.00	-12.22	55.02	6.76	Peak	150	41
3	5470.00	62.09	68.20	-6.11	55.32	6.77	Peak	150	41
4	11020.00	42.86	54.00	-11.14	26.13	16.73	Average	167	267
5	11020.00	56.75	74.00	-17.25	40.02	16.73	Peak	167	267
6	16530.00	48.08	54.00	-5.92	30.14	17.94	Average	268	144
7	16530.00	61.86	68.20	-6.34	43.92	17.94	Peak	268	144

Note 1: Emission Level (dBuV/m) = SA Reading (dBuV/m) + Factor\* (dB)

\*Factor includes antenna factor , cable loss and amplifier gain

Note 2: Margin (dB) = Emission level (dBuV/m) – Limit (dBuV/m).

<b>Modulation</b>	HT40	<b>Test Freq. (MHz)</b>	5510
<b>Polarization</b>	Vertical	<b>Test Configuration</b>	3

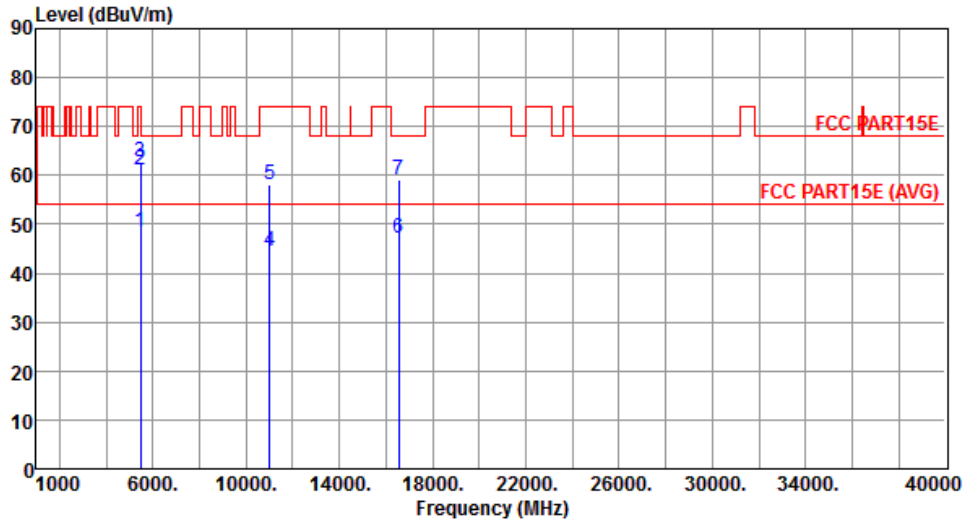

	Freq. MHz	Emission level dBuV/m	Limit dBuV/m	Margin dB	SA reading dBuV	Factor dB	Remark	ANT High cm	Turn Table deg
1	5460.00	48.57	54.00	-5.43	41.81	6.76	Average	339	115
2	5460.00	61.01	74.00	-12.99	54.25	6.76	Peak	339	115
3	5470.00	62.68	68.20	-5.52	55.91	6.77	Peak	339	115
4	11020.00	44.37	54.00	-9.63	27.64	16.73	Average	305	195
5	11020.00	58.13	74.00	-15.87	41.40	16.73	Peak	305	195
6	16530.00	47.20	54.00	-6.80	29.26	17.94	Average	150	178
7	16530.00	59.20	68.20	-9.00	41.26	17.94	Peak	150	178

Note 1: Emission Level (dBuV/m) = SA Reading (dBuV/m) + Factor\* (dB)

\*Factor includes antenna factor , cable loss and amplifier gain

Note 2: Margin (dB) = Emission level (dBuV/m) – Limit (dBuV/m).

<b>Modulation</b>	HT40	<b>Test Freq. (MHz)</b>	5590
<b>Polarization</b>	Horizontal	<b>Test Configuration</b>	3

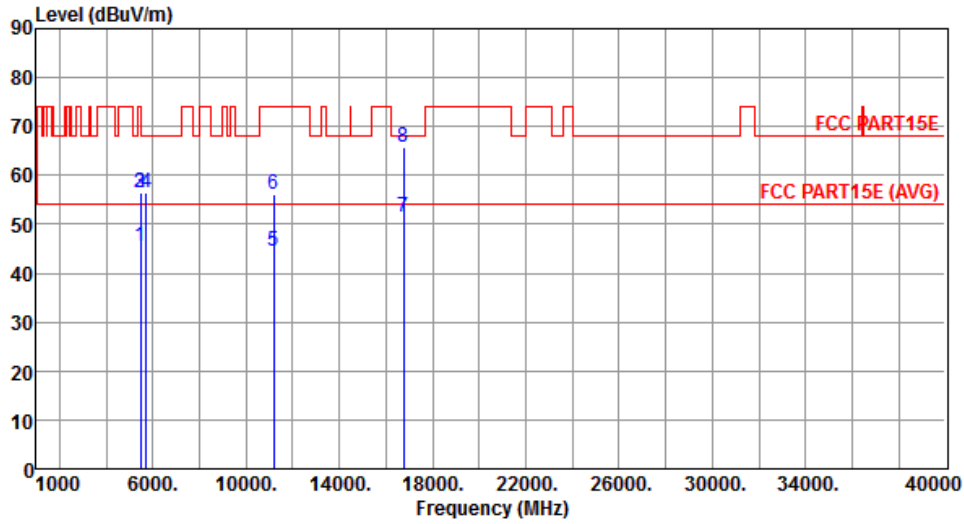

	Freq. MHz	Emission level dBuV/m	Limit dBuV/m	Margin dB	SA reading dBuV	Factor dB	Remark	ANT High cm	Turn Table deg
1	5460.00	45.39	54.00	-8.61	38.63	6.76	Average	150	43
2	5460.00	56.55	74.00	-17.45	49.79	6.76	Peak	150	43
3	5470.00	56.47	68.20	-11.73	49.70	6.77	Peak	150	43
4	5725.00	56.59	68.20	-11.61	49.35	7.24	Peak	150	43
5	11180.00	44.46	54.00	-9.54	27.67	16.79	Average	174	241
6	11180.00	56.28	74.00	-17.72	39.49	16.79	Peak	174	241
7	16770.00	51.44	54.00	-2.56	32.97	18.47	Average	237	131
8	16770.00	65.80	68.20	-2.40	47.33	18.47	Peak	237	131

Note 1: Emission Level (dBuV/m) = SA Reading (dBuV/m) + Factor\* (dB)

\*Factor includes antenna factor , cable loss and amplifier gain

Note 2: Margin (dB) = Emission level (dBuV/m) – Limit (dBuV/m).

<b>Modulation</b>	HT40	<b>Test Freq. (MHz)</b>	5590
<b>Polarization</b>	Vertical	<b>Test Configuration</b>	3

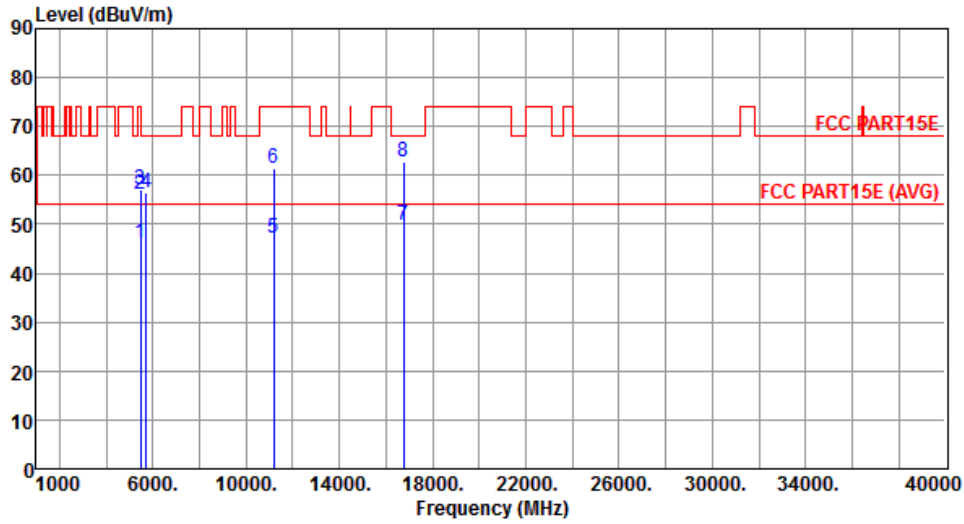

	Freq. MHz	Emission level dBuV/m	Limit dBuV/m	Margin dB	SA reading dBuV	Factor dB	Remark	ANT High cm	Turn Table deg
1	5460.00	46.32	54.00	-7.68	39.56	6.76	Average	331	115
2	5460.00	56.01	74.00	-17.99	49.25	6.76	Peak	331	115
3	5470.00	57.19	68.20	-11.01	50.42	6.77	Peak	331	115
4	5725.00	56.51	68.20	-11.69	49.27	7.24	Peak	331	115
5	11180.00	47.08	54.00	-6.92	30.29	16.79	Average	297	185
6	11180.00	61.36	74.00	-12.64	44.57	16.79	Peak	297	185
7	16770.00	49.79	54.00	-4.21	31.32	18.47	Average	151	170
8	16770.00	62.65	68.20	-5.55	44.18	18.47	Peak	151	170

Note 1: Emission Level (dBuV/m) = SA Reading (dBuV/m) + Factor\* (dB)

\*Factor includes antenna factor , cable loss and amplifier gain

Note 2: Margin (dB) = Emission level (dBuV/m) – Limit (dBuV/m).

<b>Modulation</b>	HT40	<b>Test Freq. (MHz)</b>	5670
<b>Polarization</b>	Horizontal	<b>Test Configuration</b>	3

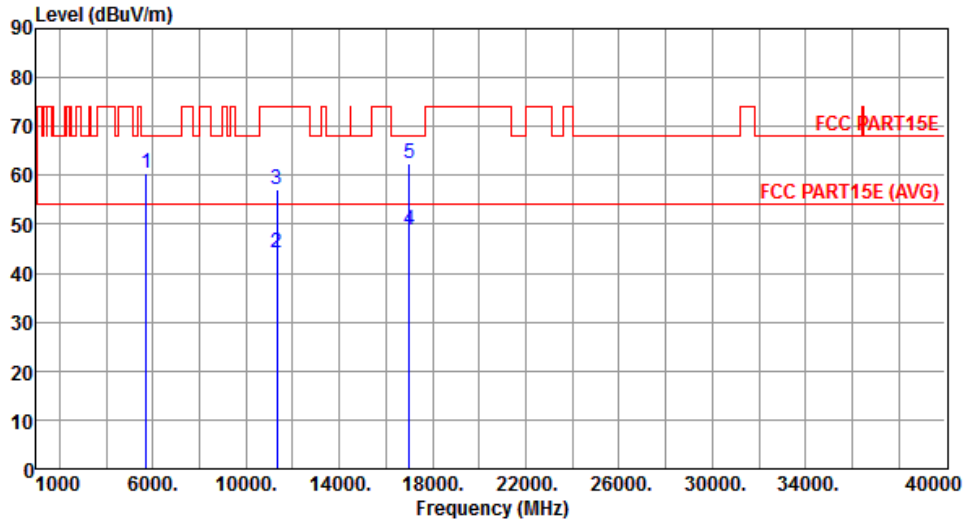

	Freq. MHz	Emission level dBuV/m	Limit dBuV/m	Margin dB	SA reading dBuV	Factor dB	Remark	ANT High cm	Turn Table deg
1	5725.00	60.60	68.20	-7.60	53.36	7.24	Peak	150	35
2	11340.00	44.25	54.00	-9.75	27.40	16.85	Average	271	230
3	11340.00	57.15	74.00	-16.85	40.30	16.85	Peak	271	230
4	17010.00	48.68	54.00	-5.32	29.69	18.99	Average	225	132
5	17010.00	62.51	68.20	-5.69	43.52	18.99	Peak	225	132

Note 1: Emission Level (dBuV/m) = SA Reading (dBuV/m) + Factor\* (dB)

\*Factor includes antenna factor , cable loss and amplifier gain

Note 2: Margin (dB) = Emission level (dBuV/m) – Limit (dBuV/m).

<b>Modulation</b>	HT40	<b>Test Freq. (MHz)</b>	5670
<b>Polarization</b>	Vertical	<b>Test Configuration</b>	3

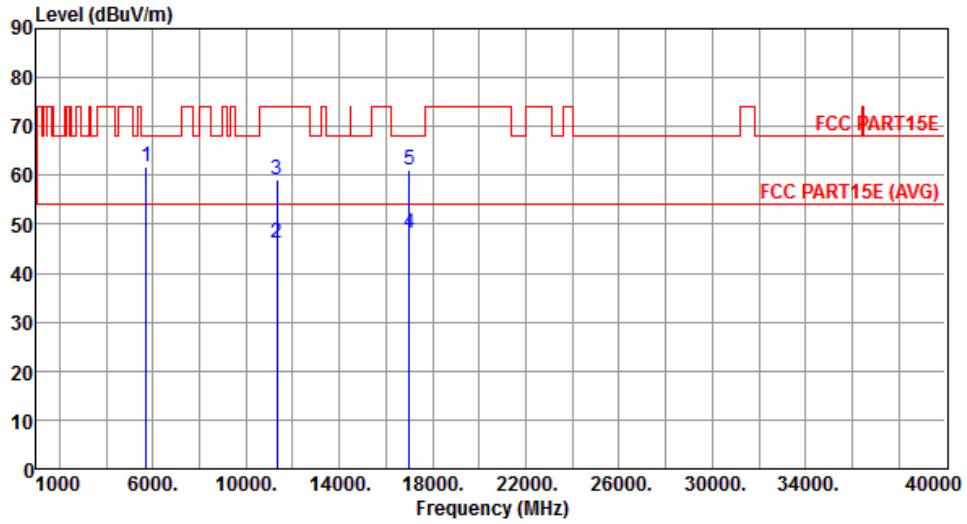

	Freq. MHz	Emission level dBuV/m	Limit dBuV/m	Margin dB	SA reading dBuV	Factor dB	Remark	ANT High cm	Turn Table deg
1	5725.00	61.84	68.20	-6.36	54.60	7.24	Peak	324	115
2	11340.00	46.03	54.00	-7.97	29.18	16.85	Average	390	62
3	11340.00	59.12	74.00	-14.88	42.27	16.85	Peak	390	62
4	17010.00	48.29	54.00	-5.71	29.30	18.99	Average	162	160
5	17010.00	60.94	68.20	-7.26	41.95	18.99	Peak	162	160

Note 1: Emission Level (dBuV/m) = SA Reading (dBuV/m) + Factor\* (dB)

\*Factor includes antenna factor , cable loss and amplifier gain

Note 2: Margin (dB) = Emission level (dBuV/m) – Limit (dBuV/m).

<b>Modulation</b>	HT40	<b>Test Freq. (MHz)</b>	5755
<b>Polarization</b>	Horizontal	<b>Test Configuration</b>	3

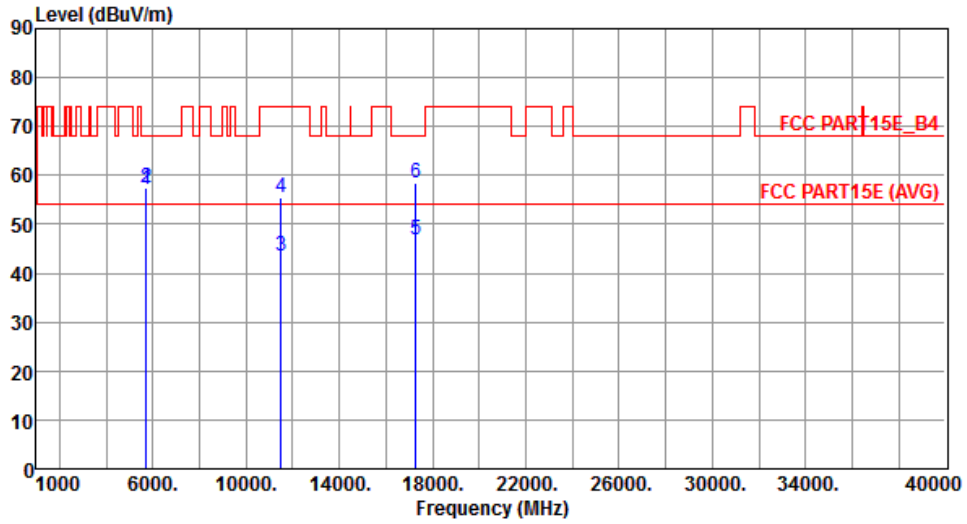

	Freq. MHz	Emission level dBuV/m	Limit dBuV/m	Margin dB	SA reading dBuV	Factor dB	Remark	ANT High cm	Turn Table deg
1	5715.00	57.19	68.20	-11.01	49.99	7.20	Peak	150	36
2	5725.00	57.50	78.20	-20.70	50.26	7.24	Peak	150	36
3	11510.00	43.60	54.00	-10.40	26.70	16.90	Average	261	205
4	11510.00	55.52	74.00	-18.48	38.62	16.90	Peak	261	205
5	17265.00	46.68	54.00	-7.32	27.32	19.36	Average	150	39
6	17265.00	58.32	68.20	-9.88	38.96	19.36	Peak	150	39

Note 1: Emission Level (dBuV/m) = SA Reading (dBuV/m) + Factor\* (dB)

\*Factor includes antenna factor , cable loss and amplifier gain

Note 2: Margin (dB) = Emission level (dBuV/m) – Limit (dBuV/m).



<b>Modulation</b>	HT40	<b>Test Freq. (MHz)</b>	5755
<b>Polarization</b>	Vertical	<b>Test Configuration</b>	3

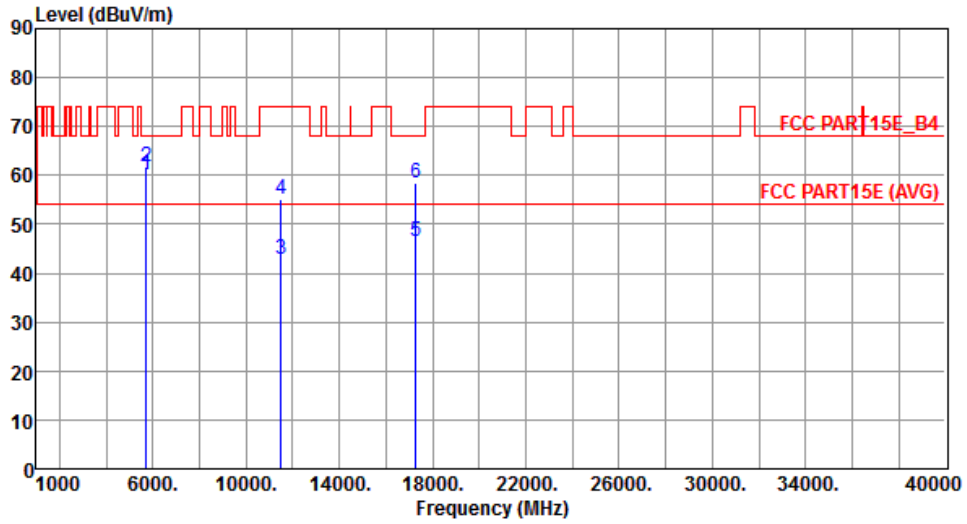

	Freq. MHz	Emission level dBuV/m	Limit dBuV/m	Margin dB	SA reading dBuV	Factor dB	Remark	ANT High cm	Turn Table deg
1	5715.00	60.01	68.20	-8.19	52.81	7.20	Peak	195	86
2	5725.00	61.72	78.20	-16.48	54.48	7.24	Peak	195	86
3	11510.00	43.00	54.00	-11.00	26.10	16.90	Average	351	277
4	11510.00	55.16	74.00	-18.84	38.26	16.90	Peak	351	277
5	17265.00	46.39	54.00	-7.61	27.03	19.36	Average	150	180
6	17265.00	58.49	68.20	-9.71	39.13	19.36	Peak	150	180

Note 1: Emission Level (dBuV/m) = SA Reading (dBuV/m) + Factor\* (dB)

\*Factor includes antenna factor , cable loss and amplifier gain

Note 2: Margin (dB) = Emission level (dBuV/m) – Limit (dBuV/m).

<b>Modulation</b>	HT40	<b>Test Freq. (MHz)</b>	5795
<b>Polarization</b>	Horizontal	<b>Test Configuration</b>	3

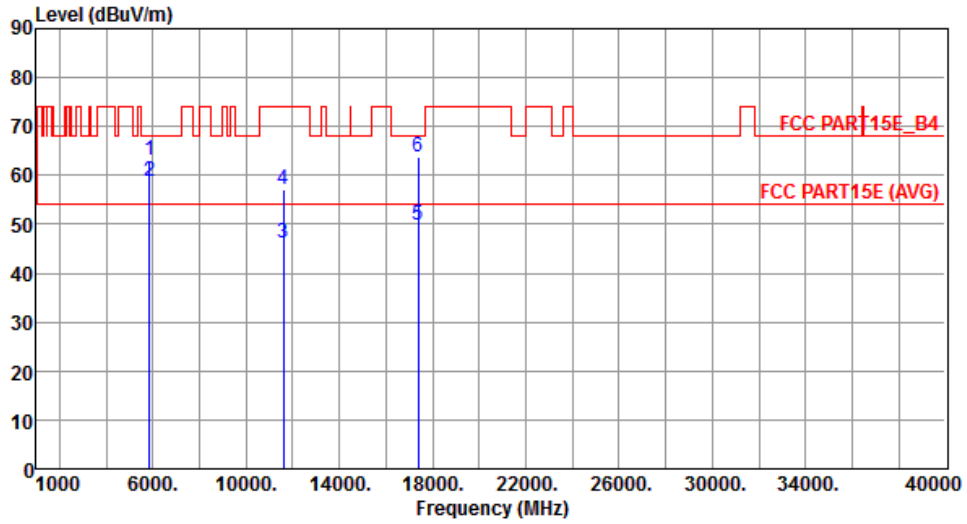

	Freq. MHz	Emission level dBuV/m	Limit dBuV/m	Margin dB	SA reading dBuV	Factor dB	Remark	ANT High cm	Turn Table deg
1	5850.00	63.11	78.20	-15.09	55.61	7.50	Peak	307	201
2	5860.00	58.77	68.20	-9.43	51.26	7.51	Peak	307	201
3	11590.00	46.15	54.00	-7.85	29.39	16.76	Average	150	166
4	11590.00	57.22	74.00	-16.78	40.46	16.76	Peak	150	166
5	17385.00	49.88	54.00	-4.12	30.34	19.54	Average	225	142
6	17385.00	63.82	68.20	-4.38	44.28	19.54	Peak	225	142

Note 1: Emission Level (dBuV/m) = SA Reading (dBuV/m) + Factor\* (dB)

\*Factor includes antenna factor , cable loss and amplifier gain

Note 2: Margin (dB) = Emission level (dBuV/m) – Limit (dBuV/m).

<b>Modulation</b>	HT40	<b>Test Freq. (MHz)</b>	5795
<b>Polarization</b>	Vertical	<b>Test Configuration</b>	3

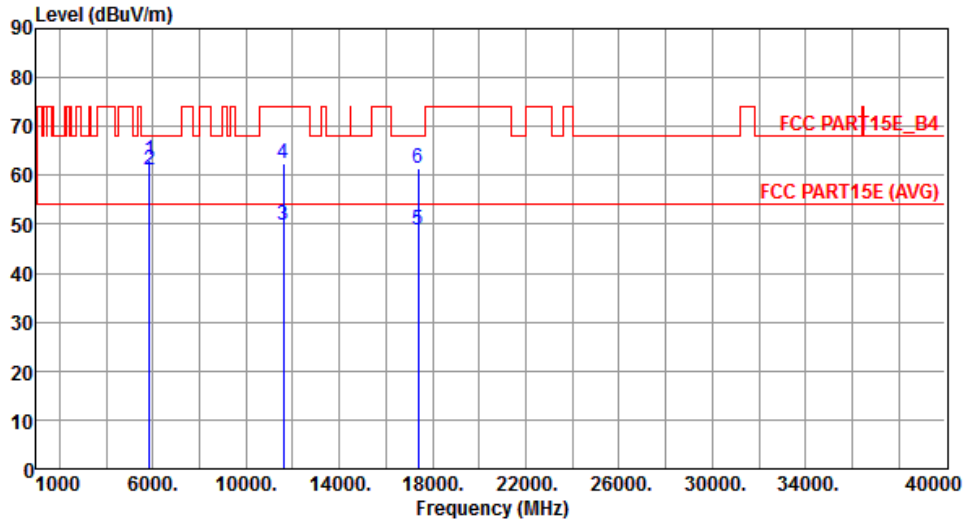

	Freq. MHz	Emission level dBuV/m	Limit dBuV/m	Margin dB	SA reading dBuV	Factor dB	Remark	ANT High cm	Turn Table deg
1	5850.00	63.18	78.20	-15.02	55.68	7.50	Peak	195	86
2	5860.00	61.09	68.20	-7.11	53.58	7.51	Peak	195	86
3	11590.00	49.83	54.00	-4.17	33.07	16.76	Average	150	172
4	11590.00	62.35	74.00	-11.65	45.59	16.76	Peak	150	172
5	17385.00	48.79	54.00	-5.21	29.25	19.54	Average	220	159
6	17385.00	61.33	68.20	-6.87	41.79	19.54	Peak	220	159

Note 1: Emission Level (dBuV/m) = SA Reading (dBuV/m) + Factor\* (dB)

\*Factor includes antenna factor , cable loss and amplifier gain

Note 2: Margin (dB) = Emission level (dBuV/m) – Limit (dBuV/m).

## 3.6 Frequency Stability

### 3.6.1 Limit of Frequency Stability

Manufacturers of U-NII devices are responsible for ensuring frequency stability such that an emission is maintained within the band of operation under all conditions of normal operation as specified in the user's manual.

### 3.6.2 Test Procedures

1. The EUT is installed in an environment test chamber with external power source.
2. Set the chamber to operate at 50 centigrade and external power source to output at nominal voltage of EUT.
3. A sufficient stabilization period at each temperature is used prior to each frequency measurement.
4. When temperature is stabled, measure the frequency stability.
5. The test shall be performed under -40 to 85 centigrade and 85 to 115 percent of the nominal voltage. Change setting of chamber and external power source to complete all conditions.

### 3.6.3 Test Setup

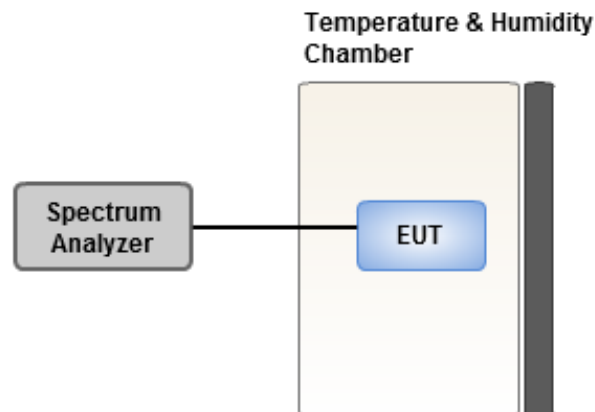

### 3.6.4 Test Result of Frequency Stability

Frequency: 5320 MHz	Frequency Drift (ppm)			
	0 minute	2 minutes	5 minutes	10 minutes
T20°CVmax	-0.11	0.48	0.59	0.35
T20°CVmin	0.35	0.77	0.61	0.17
T85°CVnom	-0.05	0.16	0.36	0.25
T80°CVnom	0.33	0.33	0.32	0.11
T70°CVnom	-0.20	0.04	-0.34	-0.12
T60°CVnom	0.39	0.98	0.13	0.78
T50°CVnom	1.00	1.56	1.07	1.45
T40°CVnom	0.13	0.56	0.87	0.36
T30°CVnom	0.33	0.64	0.45	0.53
T20°CVnom	0.27	0.91	0.12	0.30
T10°CVnom	0.18	0.30	0.70	0.54
T0°CVnom	0.50	0.68	0.28	0.81
T-10°CVnom	0.57	0.98	0.31	0.73
T-20°CVnom	0.74	0.48	0.66	1.18
T-30°CVnom	0.33	-0.06	0.70	0.59
T-40°CVnom	-0.11	0.37	-0.09	-0.10
Vnom [Vdc]: 3.3		Vmax [Vdc]: 3.795		Vmin [Vdc]: 2.805
Tnom [°C]: 20		Tmax [°C]: 85		Tmin [°C]: -40

Frequency: 5785 MHz	Frequency Drift (ppm)			
	0 minute	2 minutes	5 minutes	10 minutes
T20°CVmax	5.53	5.74	6.26	5.78
T20°CVmin	3.91	3.93	4.34	4.50
T85°CVnom	4.41	5.22	4.38	4.17
T80°CVnom	2.85	3.23	3.01	2.62
T70°CVnom	2.61	2.69	2.17	2.39
T60°CVnom	2.94	3.22	2.91	2.67
T50°CVnom	2.77	2.72	3.13	2.37
T40°CVnom	2.82	2.69	3.11	2.92
T30°CVnom	2.07	2.60	2.55	1.76
T20°CVnom	1.05	1.13	0.85	0.95
T10°CVnom	0.90	0.89	0.69	0.62
T0°CVnom	0.67	0.68	0.77	1.35
T-10°CVnom	5.82	6.10	6.04	5.98
T-20°CVnom	4.22	4.78	4.76	4.20
T-30°CVnom	4.62	4.45	4.97	4.57
T-40°CVnom	3.16	3.23	3.19	3.46
Vnom [Vdc]: 3.3	Vmax [Vdc]: 3.795		Vmin [Vdc]: 2.805	
Tnom [°C]: 20	Tmax [°C]: 85		Tmin [°C]: -40	

## 4 Test laboratory information

Established in 2012, ICC provides foremost EMC & RF Testing and advisory consultation services by our skilled engineers and technicians. Our services employ a wide variety of advanced edge test equipment and one of the widest certification extents in the business.

International Certification Corp, it is our definitive objective is to institute long term, trust-based associations with our clients. The expectation we set up with our clients is based on outstanding service, practical expertise and devotion to a certified value structure. Our passion is to grant our clients with best EMC / RF services by oriented knowledgeable and accommodating staff.

Our Test sites are located at Linkou District and Kwei Shan Hsiang. Location map can be found on our website <http://www.icertifi.com.tw>.

### **Linkou**

Tel: 886-2-2601-1640

No. 30-2, Ding Fwu Tsuen, Lin  
Kou District, New Taipei City,  
Taiwan, R.O.C.

### **Kwei Shan**

Tel: 886-3-271-8666

No. 3-1, Lane 6, Wen San 3rd St.,  
Kwei Shan Hsiang, Tao Yuan  
Hsien 333, Taiwan, R.O.C.

### **Kwei Shan Site II**

Tel: 886-3-271-8640

No. 14-1, Lane 19, Wen San 3rd  
St., Kwei Shan Hsiang, Tao Yuan  
Hsien 333, Taiwan, R.O.C.

If you have any suggestion, please feel free to contact us as below information

Tel: 886-3-271-8666

Fax: 886-3-318-0155

Email: ICC\_Service@icertifi.com.tw

==END==