

FCC Test Report

FCC ID : SQG-M2SD50NBT
Equipment : 802.11abgn M.2 module w/SDIO interface
Model No. : M2SD50NBT
Brand Name : Laird Technologies
Applicant : Laird Technologies
Address : 11160 Thompson Ave., Lenexa, Kansas 66219,
USA
Standard : 47 CFR FCC Part 15.247
Received Date : Sep. 11, 2015
Tested Date : Dec. 11, 2015 ~ Jan. 12, 2016

We, International Certification Corp., would like to declare that the tested sample has been evaluated and in compliance with the requirement of the above standards. The test results contained in this report refer exclusively to the product. It may be duplicated completely for legal use with the approval of the applicant. It shall not be reproduced except in full without the written approval of our laboratory.

Approved & Reviewed by:



Gary Chang / Manager



Table of Contents

1	GENERAL DESCRIPTION	5
1.1	Information.....	5
1.2	Local Support Equipment List	7
1.3	Test Setup Chart	7
1.4	Test Equipment List and Calibration Data.....	8
1.5	Test Standards	9
1.6	Measurement Uncertainty	9
2	TEST CONFIGURATION	10
2.1	Testing Condition	10
2.2	The Worst Test Modes and Channel Details	10
3	TRANSMITTER TEST RESULTS.....	11
3.1	Conducted Emissions.....	11
3.2	6dB and Occupied Bandwidth	14
3.3	RF Output Power.....	16
3.4	Power Spectral Density	18
3.5	Emissions in Restricted Frequency Bands.....	20
3.6	Emissions in non-restricted Frequency Bands.....	46
4	TEST LABORATORY INFORMATION	49

Release Record

Report No.	Version	Description	Issued Date
FR591102AE	Rev. 01	Initial issue	Feb. 16, 2016

Summary of Test Results

FCC Rules	Test Items	Measured	Result
15.207	AC Power Line Conducted Emissions	[dBuV]: 21.260MHz 20.17 (Margin -29.83dB) - AV	Pass
15.247(d) 15.209	Radiated Emissions	[dBuV/m at 3m]: 2483.50MHz 53.90 (Margin -0.10dB) - AV	Pass
15.247(b)(3)	Maximum Output Power	Power [dBm]: 7.24	Pass
15.247(a)(2)	6dB Bandwidth	Meet the requirement of limit	Pass
15.247(e)	Power Spectral Density	Meet the requirement of limit	Pass
15.203	Antenna Requirement	Meet the requirement of limit	Pass

1 General Description

1.1 Information

1.1.1 Specification of the Equipment under Test (EUT)

RF General Information				
Frequency Range (MHz)	Bluetooth Mode	Ch. Freq. (MHz)	Channel Number	Data Rate
2400-2483.5	V4.0 LE	2402-2480	0-39 [40]	1 Mbps

Note 1: Bluetooth LE (Low energy) uses GFSK modulation.

1.1.2 Antenna Details

Ant. No.	Model	Type	Connector	Operating Frequencies (MHz) / Antenna Gain (dBi)				
				2400~2483.5	5150~5250	5250~5350	5470~5725	5725~5850
1	Laird MAF94051	Dipole	RP-SMA	2.1	2.4	2.6	3.4	3.4
2	Laird NanoBlade-IP04	PCB Dipole	IPEX MHF	2	3.9	3.9	4	4
3	Laird MAF95310 Mini NanoBlade Flex	PCB Dipole	IPEX MHF	2.79	3.38	3.38	3.38	3.38
4	Laird NanoBlue-IP04	PCB Dipole	IPEX MHF	2	---	---	---	---
5	Ethertronics WLAN_1000146	Isolated Magnetic Dipole	IPEX MHF	2.5	3.5	3.5	3.5	3.5

Note: Ant. No. 1, 3 & 5 were for 2.4G final test.

Ant. No. 1, 2 & 5 were for 5G final test.

1.1.3 Power Supply Type of Equipment under Test (EUT)

Power Supply Type	3.3Vdc from host
--------------------------	------------------

1.1.4 Channel List

Frequency band (MHz)				2400~2483.5			
Channel	Frequency (MHz)	Channel	Frequency (MHz)	Channel	Frequency (MHz)	Channel	Frequency (MHz)
37	2402	9	2422	18	2442	28	2462
0	2404	10	2424	19	2444	29	2464
1	2406	38	2426	20	2446	30	2466
2	2408	11	2428	21	2448	31	2468
3	2410	12	2430	22	2450	32	2470
4	2412	13	2432	23	2452	33	2472
5	2414	14	2434	24	2454	34	2474
6	2416	15	2436	25	2456	35	2476
7	2418	16	2438	26	2458	36	2478
8	2420	17	2440	27	2460	39	2480

1.1.5 Test Tool and Duty Cycle

Test tool	BlueSuite, V2.5.8
Duty cycle of test signal (%)	65.33%
Duty Factor (dB)	1.85

1.1.6 Power Setting

Modulation Mode	Test Frequency (MHz)		
	2402	2440	2480
GFSK/1Mbps	Default	Default	Default

1.2 Local Support Equipment List

Support Equipment List						
No.	Equipment	Brand	Model	S/N	FCC ID	Signal cable / Length (m)
1	DC Power Supply	GW INSTEK	GPC-3060D	EM884797	---	---
2	Notebook	DELL	Latitude E6430	9ZFB4X1	DoC	---

1.3 Test Setup Chart

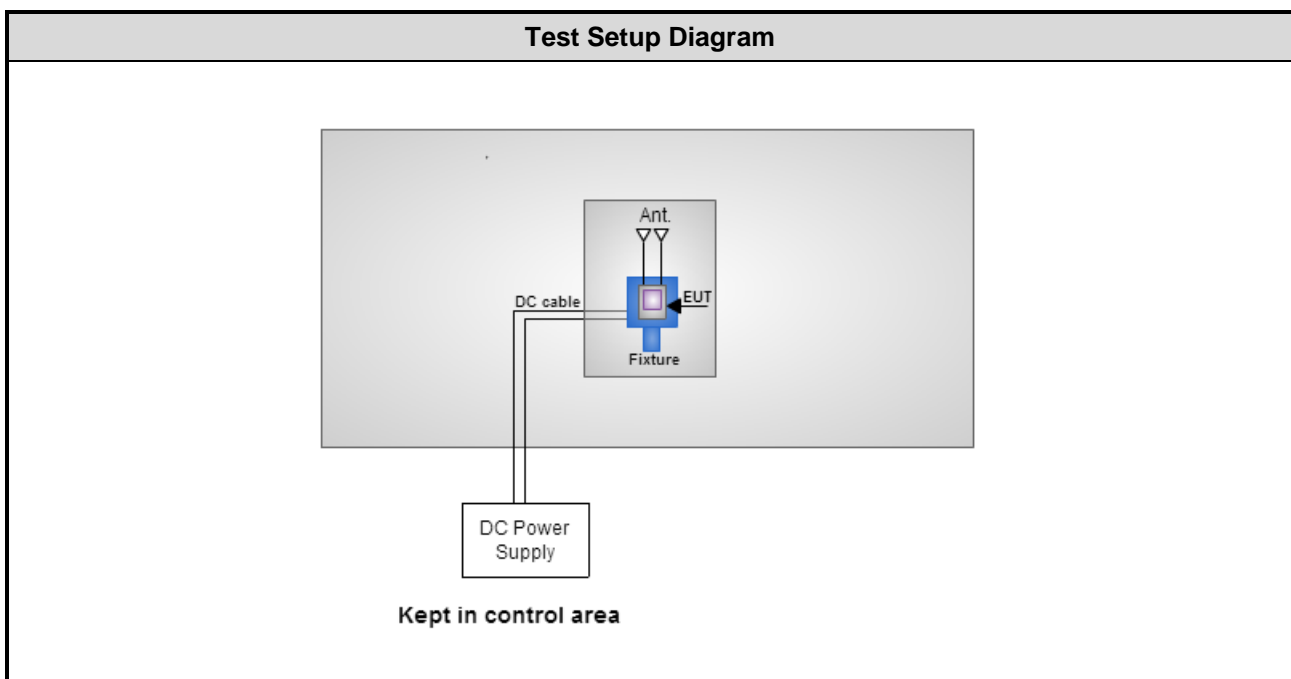

Note: The support notebook was disconnected from EUT and removed from test table when EUT is set to transmit continuously.

1.4 Test Equipment List and Calibration Data

Test Item	Conducted Emission				
Test Site	Conduction room 1 / (CO01-WS)				
Tested Date	Jan. 07, 2016				
Instrument	Manufacturer	Model No.	Serial No.	Calibration Date	Calibration Until
EMC Receiver	R&S	ESCS 30	100169	Oct. 21, 2015	Oct. 20, 2016
LISN	SCHWARZBECK	Schwarzbeck 8127	8127-667	Nov. 13, 2015	Nov. 12, 2016
RF Cable-CON	EMC	EMCCFD300-BM-BM-6000	50821	Dec. 21, 2015	Dec. 20, 2016
Measurement Software	AUDIX	e3	6.120210k	NA	NA
Note: Calibration Interval of instruments listed above is one year.					

Test Item	Radiated Emission				
Test Site	966 chamber 3 / (03CH03-WS)				
Tested Date	Dec. 11 ~ Dec. 28, 2015				
Instrument	Manufacturer	Model No.	Serial No.	Calibration Date	Calibration Until
Spectrum Analyzer	Agilent	N9010A	MY53400091	Sep. 14, 2015	Sep. 13, 2016
Receiver	Agilent	N9038A	MY53290044	Oct. 14, 2015	Oct. 13, 2016
Bilog Antenna	SCHWARZBECK	VULB9168	VULB9168-563	Dec. 30, 2014	Dec. 29, 2015
Horn Antenna 1G-18G	SCHWARZBECK	BBHA 9120 D	BBHA 9120 D 1206	Feb. 03, 2015	Feb. 02, 2016
Horn Antenna 18G-40G	SCHWARZBECK	BBHA 9170	BBHA 9170517	Nov. 04, 2015	Nov. 03, 2016
Preamplifier	EMC	EMC02325	980187	Sep. 21, 2015	Sep. 20, 2016
Preamplifier	Agilent	83017A	MY53270014	Sep. 07, 2015	Sep. 06, 2016
Preamplifier	EMC	EMC184045B	980192	Sep. 01, 2015	Aug. 31, 2016
RF cable-3M	HUBER+SUHNER	SUCOFLEX104	MY22620/4	Feb. 09, 2015	Feb. 08, 2016
RF cable-8M	HUBER+SUHNER	SUCOFLEX104	MY22600/4	Feb. 09, 2015	Feb. 08, 2016
RF cable-1M	HUBER+SUHNER	SUCOFLEX104	MY22624/4	Feb. 09, 2015	Feb. 08, 2016
LF cable-0.8M	EMC	EMC8D-NM-NM-800	EMC8D-NM-NM-800-001	Feb. 09, 2015	Feb. 08, 2016
LF cable-3M	EMC	EMC8D-NM-NM-3000	131103	Feb. 09, 2015	Feb. 08, 2016
LF cable-13M	EMC	EMC8D-NM-NM-13000	131104	Feb. 09, 2015	Feb. 08, 2016
Measurement Software	AUDIX	e3	6.120210g	NA	NA
Note: Calibration Interval of instruments listed above is one year.					

Test Item	RF Conducted				
Test Site	(TH01-WS)				
Tested Date	Jan. 12, 2016				
Instrument	Manufacturer	Model No.	Serial No.	Calibration Date	Calibration Until
Spectrum Analyzer	R&S	FSV40	101063	Feb. 03, 2015	Feb. 02, 2016
Power Meter	Anritsu	ML2495A	1241002	Sep. 21, 2015	Sep. 20, 2016
Power Sensor	Anritsu	MA2411B	1207366	Sep. 21, 2015	Sep. 20, 2016
DC POWER SOURCE	GW INSTEK	GPC-3060D	EM884797	Oct. 20, 2015	Oct. 19, 2016
Measurement Software	Sporton	Sporton_1	1.3.30	NA	NA
Note: Calibration Interval of instruments listed above is one year.					

1.5 Test Standards

According to the specification of EUT, the EUT must comply with following standards and KDB documents.

47 CFR FCC Part 15.247

ANSI C63.10-2013

FCC KDB 558074 D01 DTS Meas Guidance v03r04

1.6 Measurement Uncertainty

ISO/IEC 17025 requires that an estimate of the measurement uncertainties associated with the emissions test results be included in the report. The measurement uncertainties given below are based on a 95% confidence level (based on a coverage factor (k=2))

Measurement Uncertainty	
Parameters	Uncertainty
Bandwidth	±34.134 Hz
Conducted power	±0.808 dB
Power density	±0.463 dB
Conducted emission	±2.670 dB
AC conducted emission	±2.90 dB
Radiated emission ≤ 1GHz	±3.66 dB
Radiated emission > 1GHz	±5.37 dB

2 Test Configuration

2.1 Testing Condition

Test Item	Test Site	Ambient Condition	Tested By
AC Conduction	CO01-WS	20°C / 60%	Peter Lin
Radiated Emissions	03CH03-WS	20-23°C / 64-65%	Warren Lee Felix Sung Vincent Yeh
RF Conducted	TH01-WS	22°C / 63%	Alex Huang

➤ FCC site registration No.: 390588

➤ IC site registration No.: 10807C-1

2.2 The Worst Test Modes and Channel Details

Test item	Mode	Test Frequency (MHz)	Data Rate	Test Configuration
AC Power Line Conducted Emissions	BT LE	2440	1Mbps	2
Radiated Emissions ≤ 1GHz	BT LE	2440	1Mbps	1, 2, 3
Radiated Emissions > 1GHz	BT LE	2402, 2440, 2480	1Mbps	1, 2, 3
Maximum Output Power	BT LE	2402, 2440, 2480	1Mbps	2
6dB bandwidth				
Power spectral density				

NOTE:

- The EUT was pretested with 3 orientations placed on the table for the radiated emission measurement – X, Y, and Z-plane. The **Y-plane** results were found as the worst case and were shown in this report.
- The following antennas are used for final testing for this module: (See item 1.1.2 for more details.)
 - Configuration 1 : Dipole antenna
 - Configuration 2 : PCB Dipole antenna
 - Configuration 3 : Isolated Magnetic Dipole antenna

3 Transmitter Test Results

3.1 Conducted Emissions

3.1.1 Limit of Conducted Emissions

Conducted Emissions Limit		
Frequency Emission (MHz)	Quasi-Peak	Average
0.15-0.5	66 - 56 *	56 - 46 *
0.5-5	56	46
5-30	60	50

Note 1: * Decreases with the logarithm of the frequency.

3.1.2 Test Procedures

1. The device is placed on a test table, raised 80 cm above the reference ground plane. The vertical conducting plane is located 40 cm to the rear of the device.
2. The device is connected to line impedance stabilization network (LISN) and other accessories are connected to other LISN. Measured levels of AC power line conducted emission are across the 50 Ω LISN port.
3. AC conducted emission measurements is made over frequency range from 150 kHz to 30 MHz.
4. This measurement was performed with AC 120V/60Hz

3.1.3 Test Setup

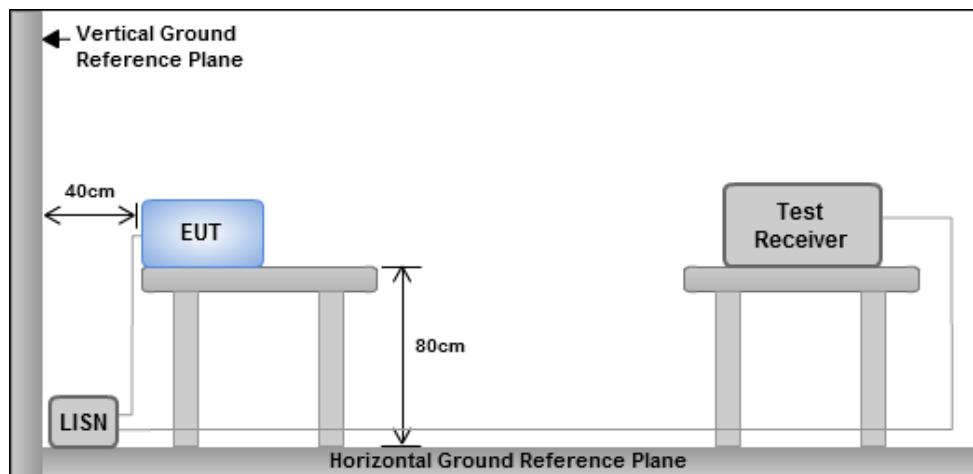

- Note: 1. Support units were connected to second LISN.
 2. Both of LISNs (AMN) are 80 cm from EUT and at least 80 cm from other units and other metal planes

3.1.4 Test Result of Conducted Emissions

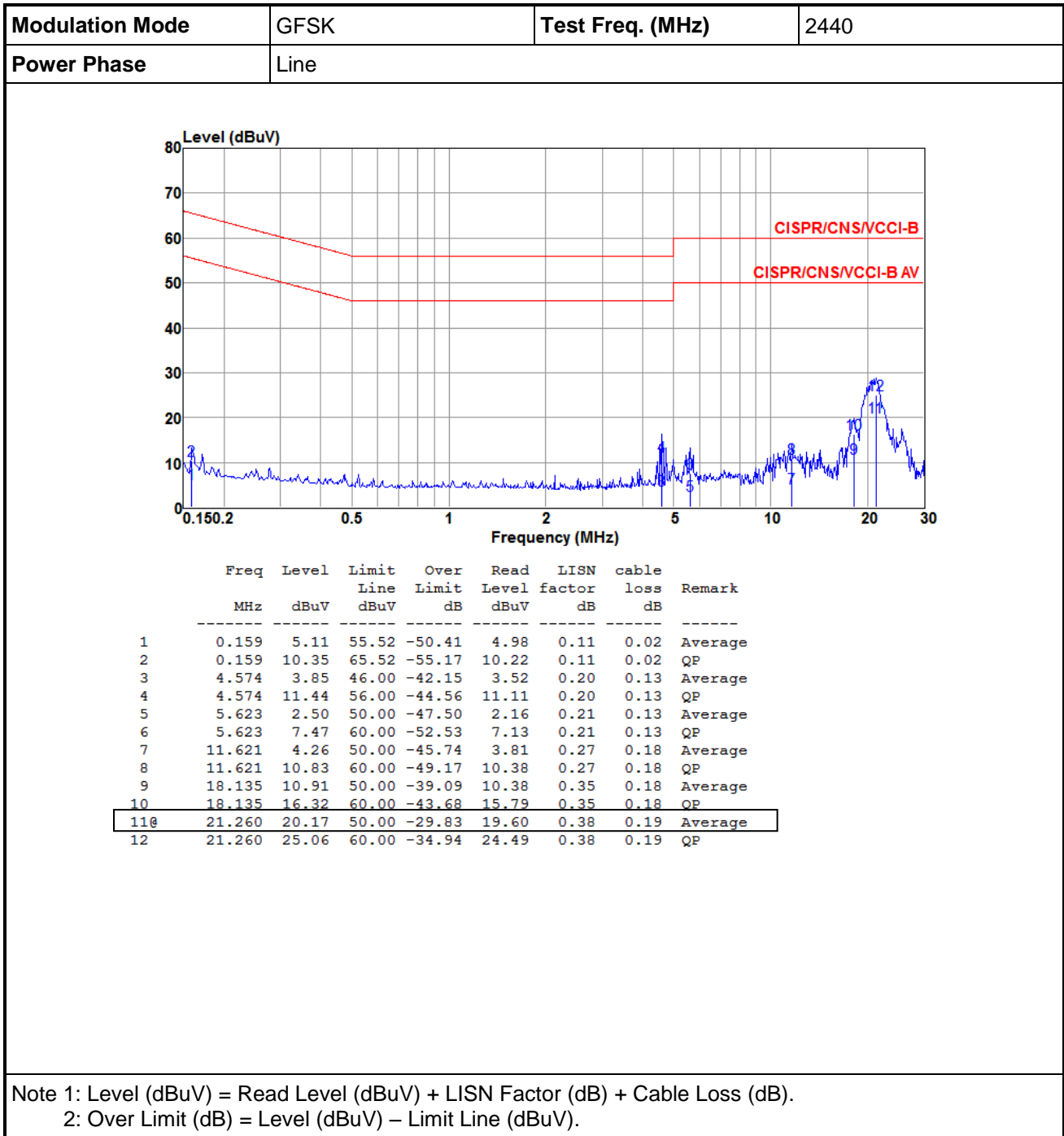

Modulation Mode	GFSK	Test Freq. (MHz)	2440
Power Phase	Neutral		

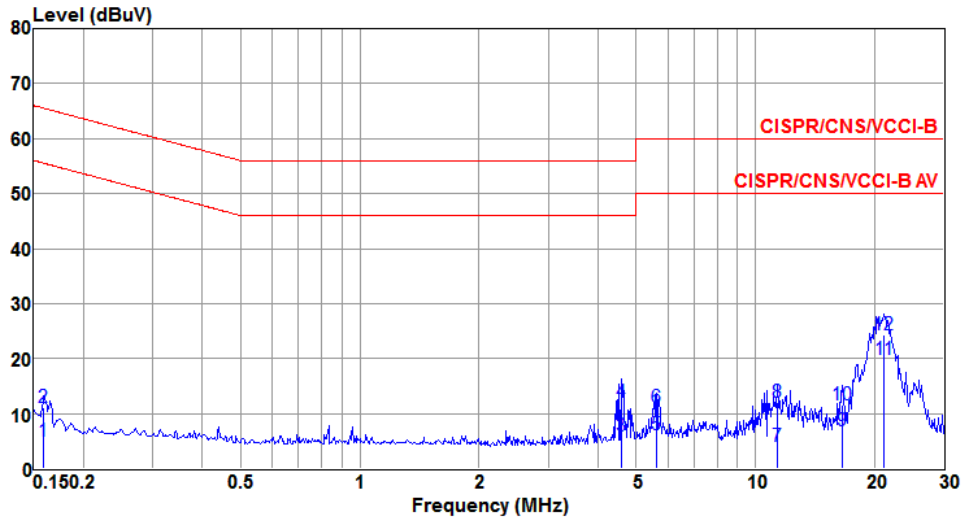

	Freq MHz	Level dBuV	Limit Line dBuV	Over Limit dB	Read Level dBuV	LISN factor dB	cable loss dB	Remark
1	0.159	4.98	55.52	-50.54	4.84	0.12	0.02	Average
2	0.159	11.08	65.52	-54.44	10.94	0.12	0.02	QP
3	4.574	5.97	46.00	-40.03	5.66	0.18	0.13	Average
4	4.574	12.03	56.00	-43.97	11.72	0.18	0.13	QP
5	5.623	6.06	50.00	-43.94	5.72	0.21	0.13	Average
6	5.623	11.19	60.00	-48.81	10.85	0.21	0.13	QP
7	11.377	4.04	50.00	-45.96	3.58	0.29	0.17	Average
8	11.377	11.97	60.00	-48.03	11.51	0.29	0.17	QP
9	16.573	6.96	50.00	-43.04	6.40	0.36	0.20	Average
10	16.573	11.64	60.00	-48.36	11.08	0.36	0.20	QP
11@	21.147	19.91	50.00	-30.09	19.31	0.41	0.19	Average
12	21.147	24.40	60.00	-35.60	23.80	0.41	0.19	QP

Note 1: Level (dBuV) = Read Level (dBuV) + LISN Factor (dB) + Cable Loss (dB).
 2: Over Limit (dB) = Level (dBuV) – Limit Line (dBuV).

3.2 6dB and Occupied Bandwidth

3.2.1 Limit of 6dB Bandwidth

The minimum 6dB bandwidth shall be at least 500 kHz.

3.2.2 Test Procedures

6dB Bandwidth

1. Set resolution bandwidth (RBW) = 100 kHz, Video bandwidth = 300 kHz.
2. Detector = Peak, Trace mode = max hold.
3. Sweep = auto couple, Allow the trace to stabilize.
4. Measure the maximum width of the emission that is constrained by the frequencies associated with the two outermost amplitude points (upper and lower) that are attenuated by 6dB relative to the maximum level measured in the fundamental emission.

Occupied Bandwidth

1. Set resolution bandwidth (RBW) = 30 kHz, Video bandwidth = 100 kHz.
2. Detector = Sample, Trace mode = max hold.
3. Sweep = auto couple, Allow the trace to stabilize.
4. Use the OBW measurement function of spectrum analyzer to measure the occupied bandwidth.

3.2.3 Test Setup

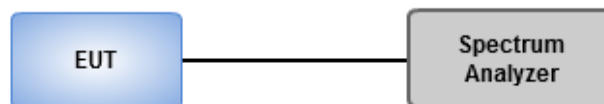

3.2.4 Test Result of 6dB and Occupied Bandwidth

Mode	Freq. (MHz)	6dB Bandwidth (MHz)	99% Occupied Bandwidth (MHz)	Limit of 6dB Bandwidth (kHz)
BT LE	2402	0.691	1.02	500
BT LE	2440	0.696	1.03	500
BT LE	2480	0.700	1.05	500

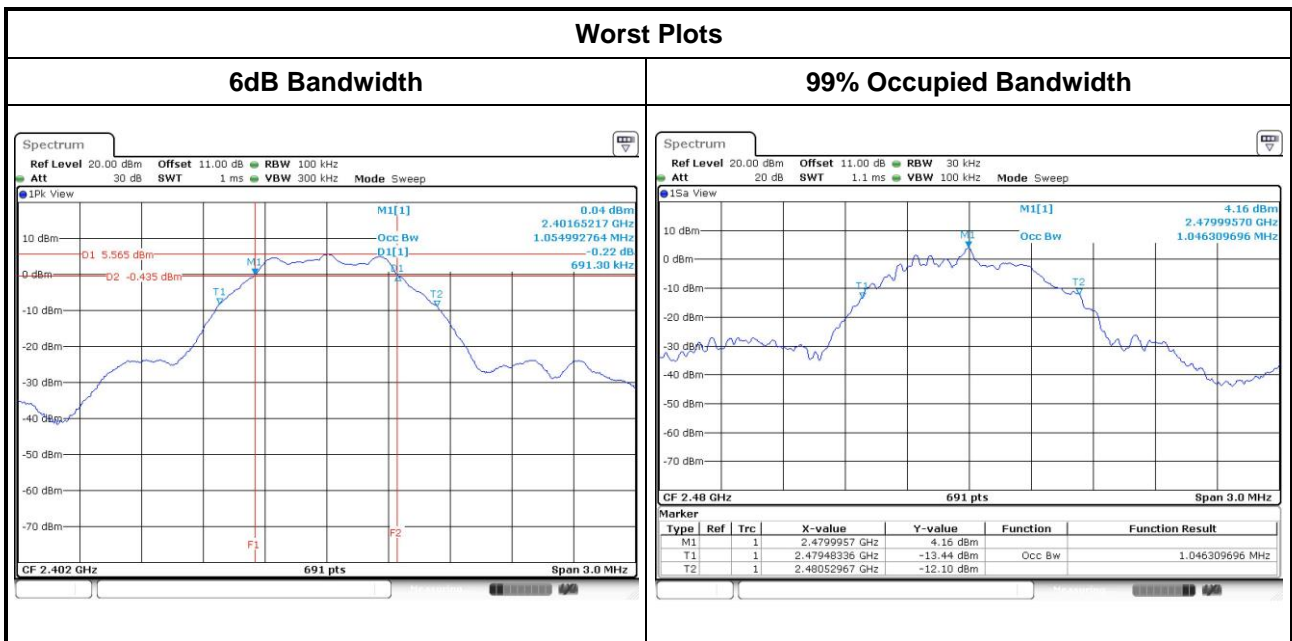

3.3 RF Output Power

3.3.1 Limit of RF Output Power

Conducted power shall not exceed 1Watt.

- Antenna gain \leq 6dBi, no any corresponding reduction is in output power limit.
- Antenna gain $>$ 6dBi
 - Non Fixed, point to point operations.
The conducted output power from the intentional radiator shall be reduced by the amount in dB that the directional gain of the antenna exceeds 6 dB
 - Fixed, point to point operations
Systems operating in the 2400–2483.5 MHz band that are used exclusively for fixed, point-to-point Operations, maximum peak output power of the intentional radiator is reduced by 1 dB for every 3 dB that the directional gain of the antenna exceeds 6 dBi.

Systems operating in the 5725–5850 MHz band that are used exclusively for fixed, point-to-point operations ,no any corresponding reduction is in transmitter peak output power

3.3.2 Test Procedures

- Maximum Peak Conducted Output Power
 - Spectrum analyzer**
 1. Set RBW = 1MHz, VBW = 3MHz, Detector = Peak.
 2. Sweep time = auto, Trace mode = max hold, Allow trace to fully stabilize.
 3. Use the spectrum analyzer channel power measurement function with the band limits set equal to the DTS bandwidth edges.
 - Power meter**
 1. A broadband Peak RF power meter is used for output power measurement. The video bandwidth of power meter is greater than DTS bandwidth of EUT. If duty cycle of test signal is not 100 %, trigger and gating function of power meter will be enabled to capture transmission burst for measuring output power.
- Maximum Conducted Average Output Power (For reference only)
 - Power meter**
 1. A broadband Average RF power meter is used for output power measurement. The video bandwidth of power meter is greater than DTS bandwidth of EUT. If duty cycle of test signal is not 100 %, trigger and gating function of power meter will be enabled to capture transmission burst for measuring output power.

3.3.3 Test Setup

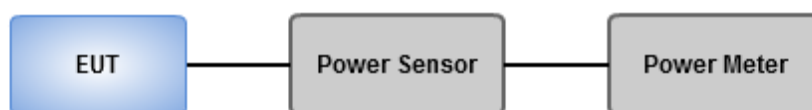

3.3.4 Test Result of Maximum Output Power

Mode	Freq. (MHz)	Peak Power			Antenna gain (dBi)	EIRP (dBm)	EIRP Limit (dBm)
		Power (mW)	Power (dBm)	Limit (dBm)			
BT LE	2402	4.295	6.33	30	2.79	9.12	36
BT LE	2440	5.297	7.24	30	2.79	10.03	36
BT LE	2480	5.248	7.20	30	2.79	9.99	36

Mode	Freq. (MHz)	AV Power (mW)	AV Power (dBm)	Limit (dBm)
BT LE	2402	4.027	6.05	---
BT LE	2440	5.012	7.00	---
BT LE	2480	5.000	6.99	---

Note: Average power is for reference only

3.4 Power Spectral Density

3.4.1 Limit of Power Spectral Density

Power spectral density shall not be greater than 8 dBm in any 3 kHz band.

3.4.2 Test Procedures

- Maximum peak conducted output power was used to demonstrate compliance to the fundamental output power limit.
 1. Set the RBW = 3kHz, VBW = 10kHz.
 2. Detector = Peak, Sweep time = auto couple.
 3. Trace mode = max hold, allow trace to fully stabilize.
 4. Use the peak marker function to determine the maximum amplitude level.
- Maximum (average) conducted output power was used to demonstrate compliance to the fundamental output power limit.
 1. Set the RBW = 100kHz, VBW = 300 kHz.
 2. Detector = RMS, Sweep time = auto couple.
 3. Set the sweep time to: $\geq 10 \times (\text{number of measurement points in sweep}) \times (\text{maximum data rate per stream})$.
 4. Perform the measurement over a single sweep.
 5. Use the peak marker function to determine the maximum amplitude level.\

3.4.3 Test Setup

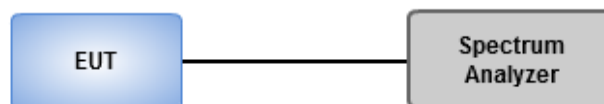

3.4.4 Test Result of Power Spectral Density

Mode	Freq. (MHz)	Total Power Spectral Density (dBm/3kHz)	Limit (dBm/3kHz)
BT LE	2402	-9.74	8
BT LE	2440	-8.92	8
BT LE	2480	-9.23	8

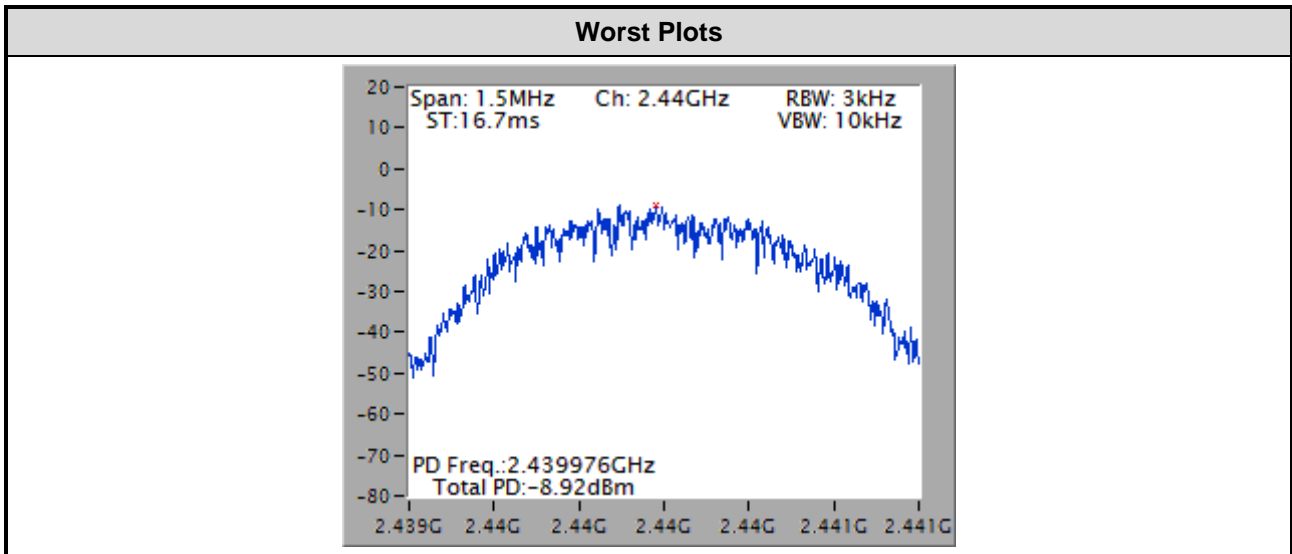

3.5 Emissions in Restricted Frequency Bands

3.5.1 Limit of Emissions in Restricted Frequency Bands

Restricted Band Emissions Limit			
Frequency Range (MHz)	Field Strength (uV/m)	Field Strength (dBuV/m)	Measure Distance (m)
0.009~0.490	2400/F(kHz)	48.5 - 13.8	300
0.490~1.705	24000/F(kHz)	33.8 - 23	30
1.705~30.0	30	29	30
30~88	100	40	3
88~216	150	43.5	3
216~960	200	46	3
Above 960	500	54	3

Note 1:
Quasi-Peak value is measured for frequency below 1GHz except for 9–90 kHz, 110–490 kHz frequency band. Peak and average value are measured for frequency above 1GHz. The limit on average radio frequency emission is as above table. The limit on peak radio frequency emissions is 20 dB above the maximum permitted average emission limit

Note 2:
Measurements may be performed at a distance other than what is specified provided. When performing measurements at a distance other than that specified, the results shall be extrapolated to the specified distance using an extrapolation factor as below, Frequency at or above 30 MHz: 20 dB/decade Frequency below 30 MHz: 40 dB/decade.

3.5.2 Test Procedures

1. Measurement is made at a semi-anechoic chamber that incorporates a turntable allowing a EUT rotation of 360°. A continuously-rotating, remotely-controlled turntable is installed at the test site to support the EUT and facilitate determination of the direction of maximum radiation for each EUT emission frequency. The EUT is placed at test table. For emissions testing at or below 1 GHz, the table height is 80 cm above the reference ground plane. For emission measurements above 1 GHz, the table height is 1.5 m
2. Measurement is made with the antenna positioned in both the horizontal and vertical planes of polarization. The measurement antenna is varied in height (1m ~ 4m) above the reference ground plane to obtain the maximum signal strength. Distance between EUT and antenna is 3 m.
3. This investigation is performed with the EUT rotated 360°, the antenna height scanned between 1 m and 4 m, and the antenna rotated to repeat the measurements for both the horizontal and vertical antenna polarizations.

Note:

1. 120kHz measurement bandwidth of test receiver and Quasi-peak detector is for radiated emission below 1GHz.
2. RBW=1MHz, VBW=3MHz and Peak detector is for peak measured value of radiated emission above 1GHz.
3. RBW=1MHz, VBW=1/T and Peak detector is for average measured value of radiated emission above 1GHz.

3.5.3 Test Setup

Radiated Emissions below 1 GHz

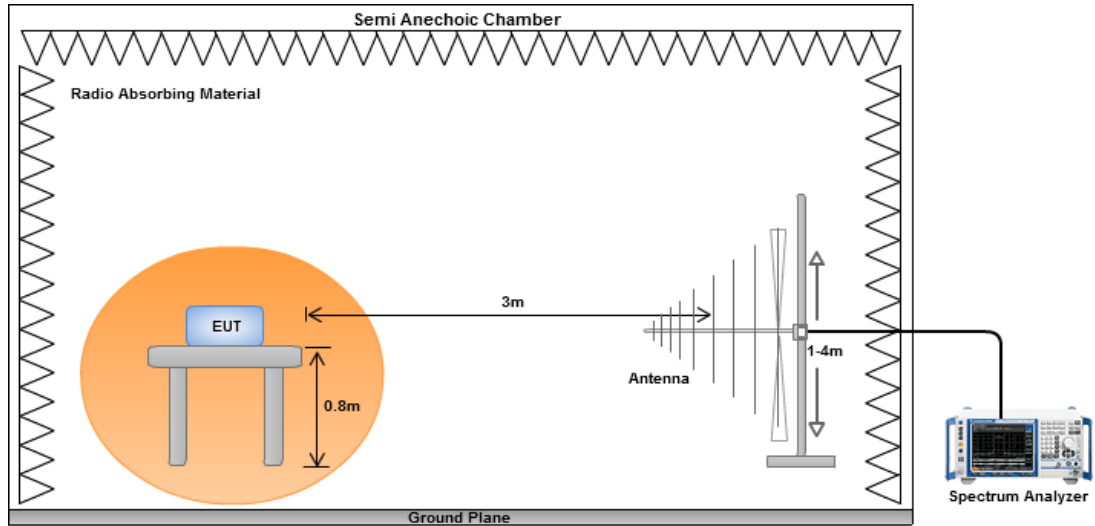

Radiated Emissions above 1 GHz

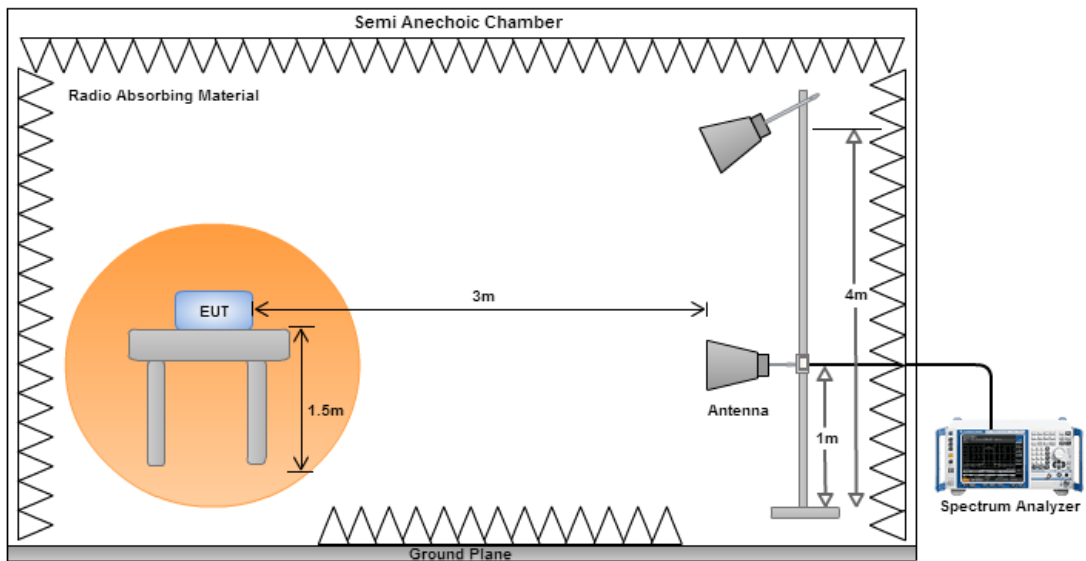

Test Configuration 1: Dipole antenna

3.5.4 Transmitter Radiated Unwanted Emissions (Below 1GHz)

Modulation	GFSK	Test Freq. (MHz)	2440
Polarization	Horizontal	Test Configuration	1

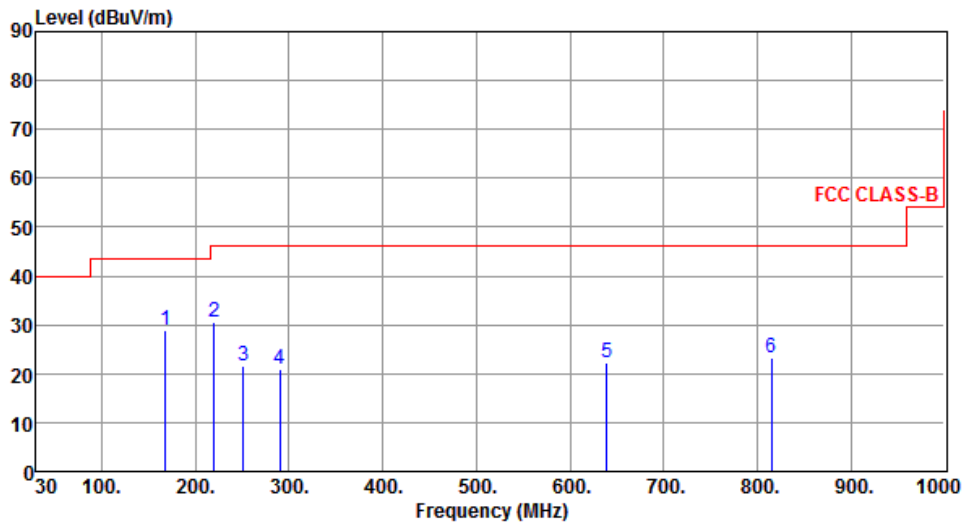

	Freq. MHz	Emission level dBuV/m	Limit dBuV/m	Margin dB	SA reading dBuV	Factor dB	Remark	ANT High cm	Turn Table deg
1	167.74	28.89	43.50	-14.61	42.88	-13.99	Peak	---	---
2	220.12	30.64	46.00	-15.36	46.60	-15.96	Peak	---	---
3	251.16	21.69	46.00	-24.31	36.40	-14.71	Peak	---	---
4	289.96	20.96	46.00	-25.04	34.08	-13.12	Peak	---	---
5	639.16	22.21	46.00	-23.79	27.44	-5.23	Peak	---	---
6	814.73	23.08	46.00	-22.92	25.46	-2.38	Peak	---	---

Note 1: Emission Level (dBuV/m) = SA Reading (dBuV/m) + Factor* (dB)

*Factor includes antenna factor , cable loss and amplifier gain

Note 2: Margin (dB) = Emission level (dBuV/m) – Limit (dBuV/m).

Note 3: All spurious emissions below 30MHz are more than 20 dB below the limit.

Modulation	GFSK	Test Freq. (MHz)	2440
Polarization	Vertical	Test Configuration	1

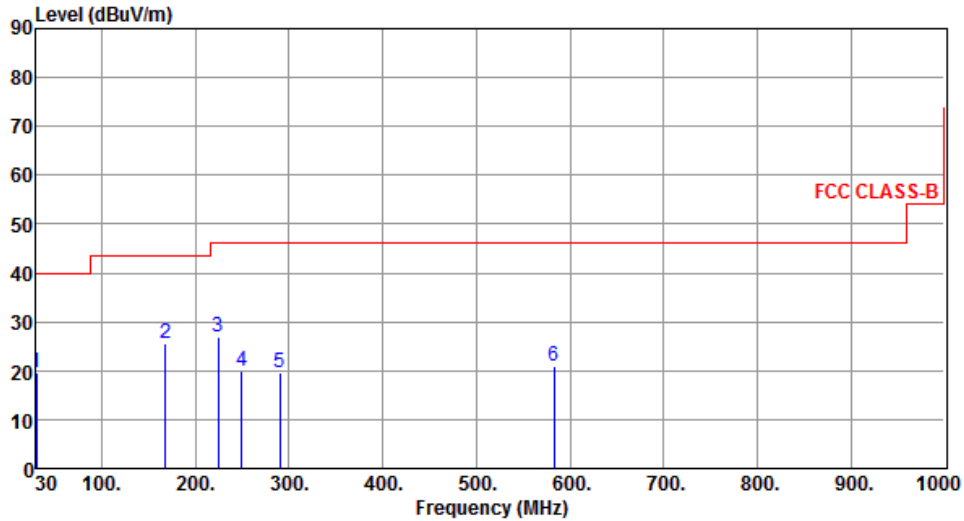

	Freq. MHz	Emission level dBuV/m	Limit dBuV/m	Margin dB	SA reading dBuV	Factor dB	Remark	ANT High cm	Turn Table deg
1	30.00	19.76	40.00	-20.24	33.27	-13.51	Peak	---	---
2	167.74	25.43	43.50	-18.07	39.42	-13.99	Peak	---	---
3	224.00	27.05	46.00	-18.95	42.77	-15.72	Peak	---	---
4	249.22	20.09	46.00	-25.91	34.83	-14.74	Peak	---	---
5	289.96	19.74	46.00	-26.26	32.86	-13.12	Peak	---	---
6	582.90	20.77	46.00	-25.23	27.02	-6.25	Peak	---	---

Note 1: Emission Level (dBuV/m) = SA Reading (dBuV/m) + Factor* (dB)

*Factor includes antenna factor , cable loss and amplifier gain

Note 2: Margin (dB) = Emission level (dBuV/m) – Limit (dBuV/m).

Note 3: All spurious emissions below 30MHz are more than 20 dB below the limit.

3.5.5 Transmitter Radiated Unwanted Emissions (Above 1GHz) for GFSK

Modulation	GFSK	Test Freq. (MHz)	2402
Polarization	Horizontal	Test Configuration	1

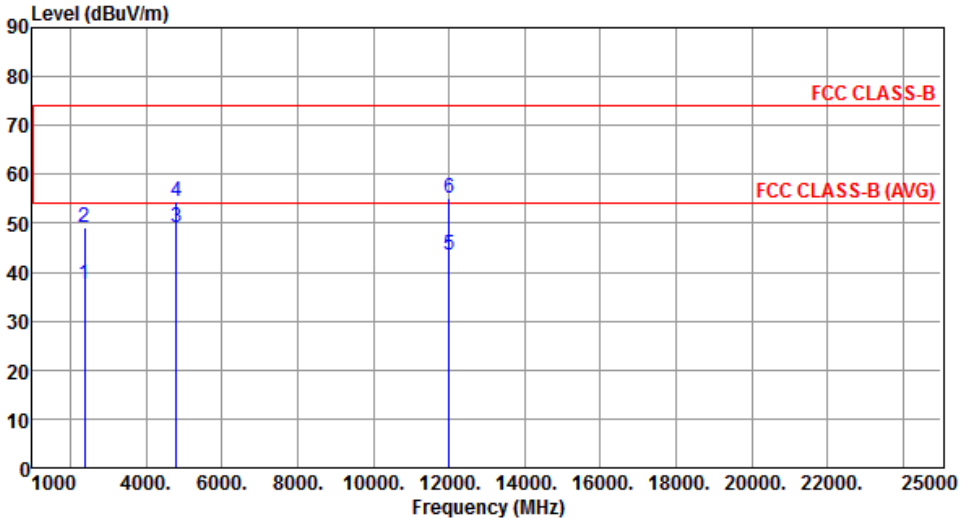

	Freq. MHz	Emission level dBuV/m	Limit dBuV/m	Margin dB	SA reading dBuV	Factor dB	Remark	ANT High cm	Turn Table deg
1	2390.00	37.58	54.00	-16.42	38.94	-1.36	Average	125	41
2	2390.00	49.23	74.00	-24.77	50.59	-1.36	Peak	125	41
3	4804.00	49.19	54.00	-4.81	43.26	5.93	Average	167	7
4	4804.00	54.43	74.00	-19.57	48.50	5.93	Peak	167	7
5	12010.00	43.37	54.00	-10.63	27.35	16.02	Average	206	271
6	12010.00	55.26	74.00	-18.74	39.24	16.02	Peak	206	271

Note 1: Emission Level (dBuV/m) = SA Reading (dBuV/m) + Factor* (dB)
 *Factor includes antenna factor , cable loss and amplifier gain
 Note 2: Margin (dB) = Emission level (dBuV/m) – Limit (dBuV/m).

Modulation	GFSK	Test Freq. (MHz)	2402
Polarization	Vertical	Test Configuration	1

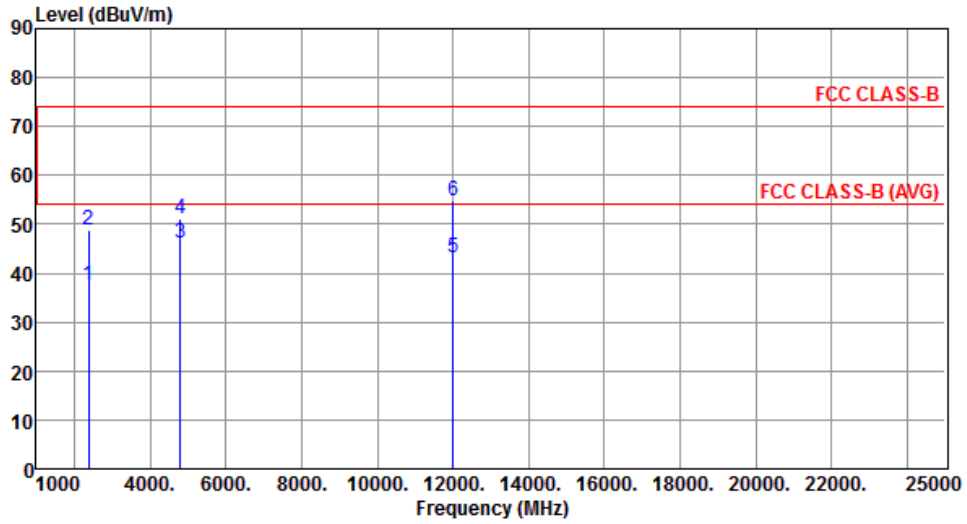

	Freq. MHz	Emission level dBuV/m	Limit dBuV/m	Margin dB	SA reading dBuV	Factor dB	Remark	ANT High cm	Turn Table deg
1	2390.00	37.52	54.00	-16.48	38.88	-1.36	Average	123	0
2	2390.00	48.92	74.00	-25.08	50.28	-1.36	Peak	123	0
3	4804.00	46.30	54.00	-7.70	40.37	5.93	Average	190	319
4	4804.00	51.29	74.00	-22.71	45.36	5.93	Peak	190	319
5	12010.00	43.05	54.00	-10.95	27.03	16.02	Average	169	214
6	12010.00	54.66	74.00	-19.34	38.64	16.02	Peak	169	214

Note 1: Emission Level (dBuV/m) = SA Reading (dBuV/m) + Factor* (dB)

*Factor includes antenna factor , cable loss and amplifier gain

Note 2: Margin (dB) = Emission level (dBuV/m) – Limit (dBuV/m).

Modulation	GFSK	Test Freq. (MHz)	2440
Polarization	Horizontal	Test Configuration	1

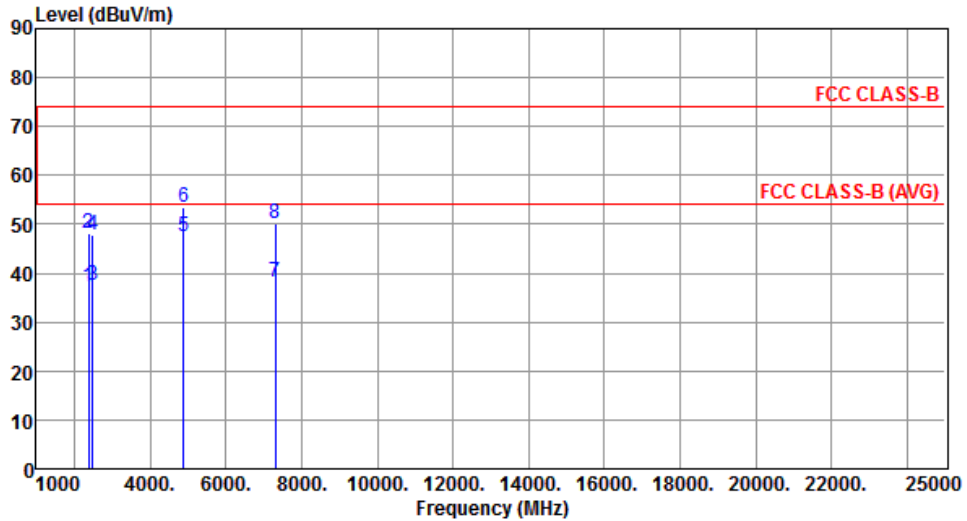

	Freq. MHz	Emission level dBuV/m	Limit dBuV/m	Margin dB	SA reading dBuV	Factor dB	Remark	ANT High cm	Turn Table deg
1	2390.00	37.13	54.00	-16.87	38.49	-1.36	Average	163	143
2	2390.00	47.99	74.00	-26.01	49.35	-1.36	Peak	163	143
3	2483.50	37.38	54.00	-16.62	38.40	-1.02	Average	163	143
4	2483.50	47.76	74.00	-26.24	48.78	-1.02	Peak	163	143
5	4880.00	47.65	54.00	-6.35	41.67	5.98	Average	170	8
6	4880.00	53.58	74.00	-20.42	47.60	5.98	Peak	170	8
7	7320.00	38.09	54.00	-15.91	27.33	10.76	Average	184	207
8	7320.00	50.13	74.00	-23.87	39.37	10.76	Peak	184	207

Note 1: Emission Level (dBuV/m) = SA Reading (dBuV/m) + Factor* (dB)

*Factor includes antenna factor , cable loss and amplifier gain

Note 2: Margin (dB) = Emission level (dBuV/m) – Limit (dBuV/m).

Modulation	GFSK	Test Freq. (MHz)	2440
Polarization	Vertical	Test Configuration	1

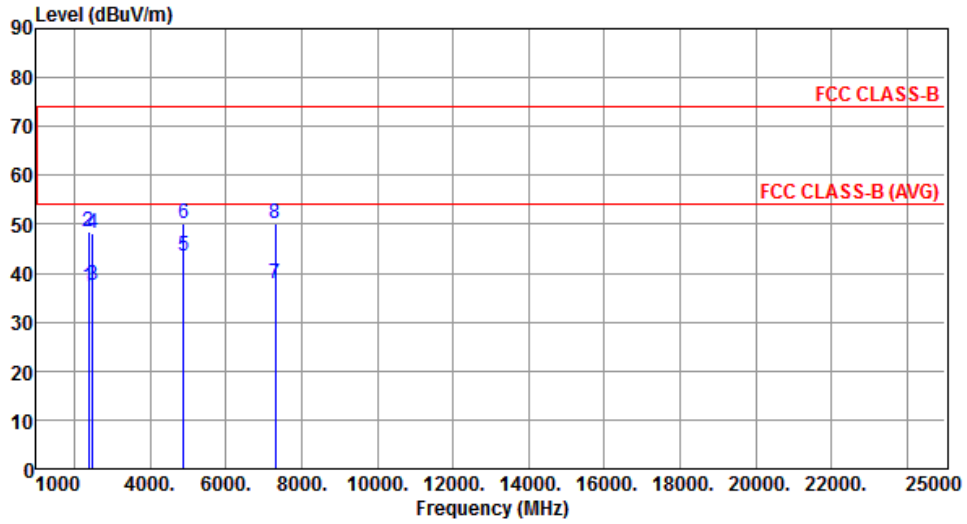

	Freq. MHz	Emission level dBuV/m	Limit dBuV/m	Margin dB	SA reading dBuV	Factor dB	Remark	ANT High cm	Turn Table deg
1	2390.00	37.19	54.00	-16.81	38.55	-1.36	Average	400	287
2	2390.00	48.62	74.00	-25.38	49.98	-1.36	Peak	400	287
3	2483.50	37.66	54.00	-16.34	38.68	-1.02	Average	400	287
4	2483.50	48.23	74.00	-25.77	49.25	-1.02	Peak	400	287
5	4880.00	43.38	54.00	-10.62	37.40	5.98	Average	180	316
6	4880.00	50.13	74.00	-23.87	44.15	5.98	Peak	180	316
7	7320.00	37.79	54.00	-16.21	27.03	10.76	Average	178	246
8	7320.00	50.02	74.00	-23.98	39.26	10.76	Peak	178	246

Note 1: Emission Level (dBuV/m) = SA Reading (dBuV/m) + Factor* (dB)

*Factor includes antenna factor , cable loss and amplifier gain

Note 2: Margin (dB) = Emission level (dBuV/m) – Limit (dBuV/m).

Modulation	GFSK	Test Freq. (MHz)	2480
Polarization	Horizontal	Test Configuration	1

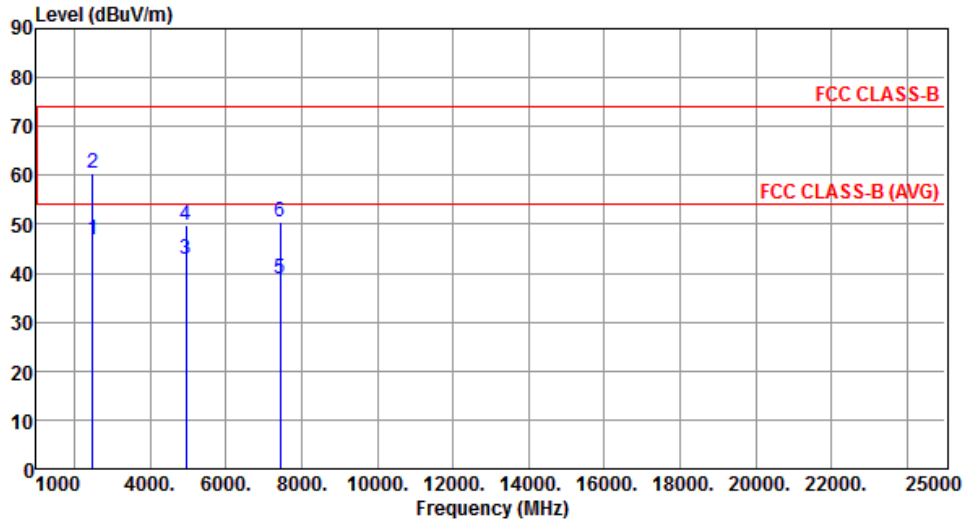

	Freq. MHz	Emission level dBuV/m	Limit dBuV/m	Margin dB	SA reading dBuV	Factor dB	Remark	ANT High cm	Turn Table deg
1	2483.50	46.86	54.00	-7.14	47.88	-1.02	Average	122	152
2	2483.50	60.49	74.00	-13.51	61.51	-1.02	Peak	122	152
3	4960.00	42.75	54.00	-11.25	36.72	6.03	Average	233	311
4	4960.00	49.76	74.00	-24.24	43.73	6.03	Peak	233	311
5	7440.00	39.00	54.00	-15.00	27.98	11.02	Average	228	168
6	7440.00	50.62	74.00	-23.38	39.60	11.02	Peak	228	168

Note 1: Emission Level (dBuV/m) = SA Reading (dBuV/m) + Factor* (dB)

*Factor includes antenna factor , cable loss and amplifier gain

Note 2: Margin (dB) = Emission level (dBuV/m) – Limit (dBuV/m).

Modulation	GFSK	Test Freq. (MHz)	2480
Polarization	Vertical	Test Configuration	1

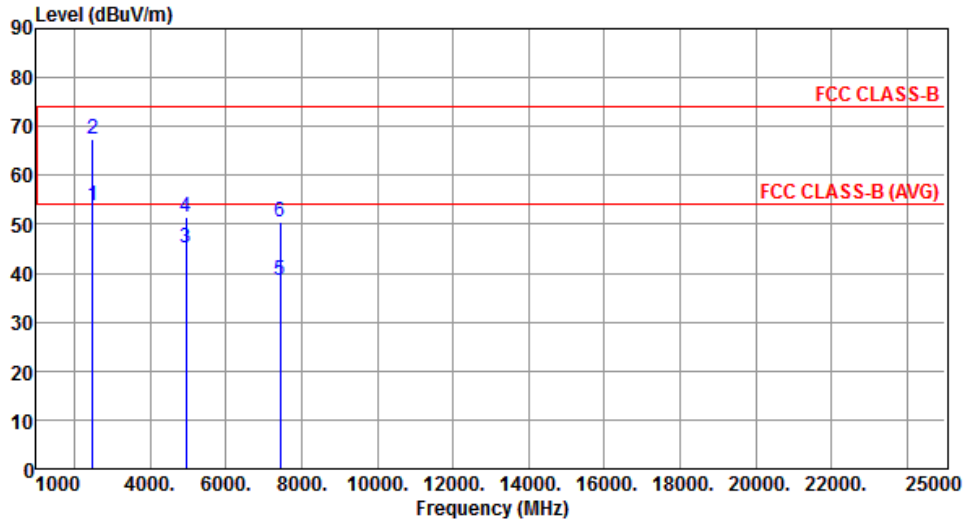

	Freq. MHz	Emission level dBuV/m	Limit dBuV/m	Margin dB	SA reading dBuV	Factor dB	Remark	ANT High cm	Turn Table deg
1	2483.50	53.90	54.00	-0.10	54.92	-1.02	Average	400	280
2	2483.50	67.57	74.00	-6.43	68.59	-1.02	Peak	400	280
3	4960.00	45.03	54.00	-8.97	39.00	6.03	Average	120	0
4	4960.00	51.51	74.00	-22.49	45.48	6.03	Peak	120	0
5	7440.00	38.65	54.00	-15.35	27.63	11.02	Average	361	275
6	7440.00	50.62	74.00	-23.38	39.60	11.02	Peak	361	275

Note 1: Emission Level (dBuV/m) = SA Reading (dBuV/m) + Factor* (dB)

*Factor includes antenna factor , cable loss and amplifier gain

Note 2: Margin (dB) = Emission level (dBuV/m) – Limit (dBuV/m).

Test Configuration 2: PCB Dipole antenna

3.5.6 Transmitter Radiated Unwanted Emissions (Below 1GHz)

Modulation	GFSK	Test Freq. (MHz)	2440
Polarization	Horizontal	Test Configuration	2

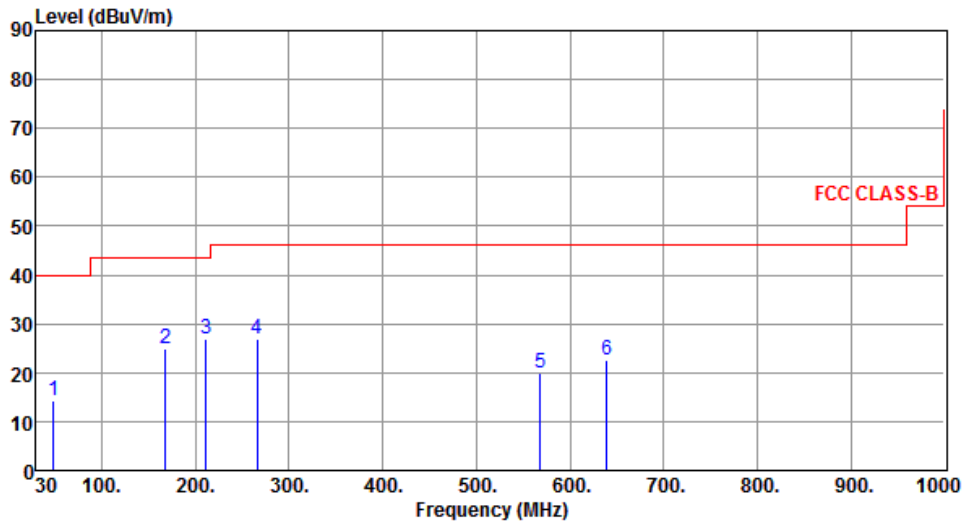

	Freq. MHz	Emission level dBuV/m	Limit dBuV/m	Margin dB	SA reading dBuV	Factor dB	Remark	ANT High cm	Turn Table deg
1	48.43	14.33	40.00	-25.67	27.24	-12.91	Peak	---	---
2	167.74	24.78	43.50	-18.72	38.77	-13.99	Peak	---	---
3	211.39	26.90	43.50	-16.60	43.31	-16.41	Peak	---	---
4	265.71	27.02	46.00	-18.98	41.12	-14.10	Peak	---	---
5	568.35	19.97	46.00	-26.03	26.60	-6.63	Peak	---	---
6	639.16	22.73	46.00	-23.27	27.96	-5.23	Peak	---	---

Note 1: Emission Level (dBuV/m) = SA Reading (dBuV/m) + Factor* (dB)

*Factor includes antenna factor, cable loss and amplifier gain

Note 2: Margin (dB) = Emission level (dBuV/m) – Limit (dBuV/m).

Note 3: All spurious emissions below 30MHz are more than 20 dB below the limit.

Modulation	GFSK	Test Freq. (MHz)	2440
Polarization	Vertical	Test Configuration	2

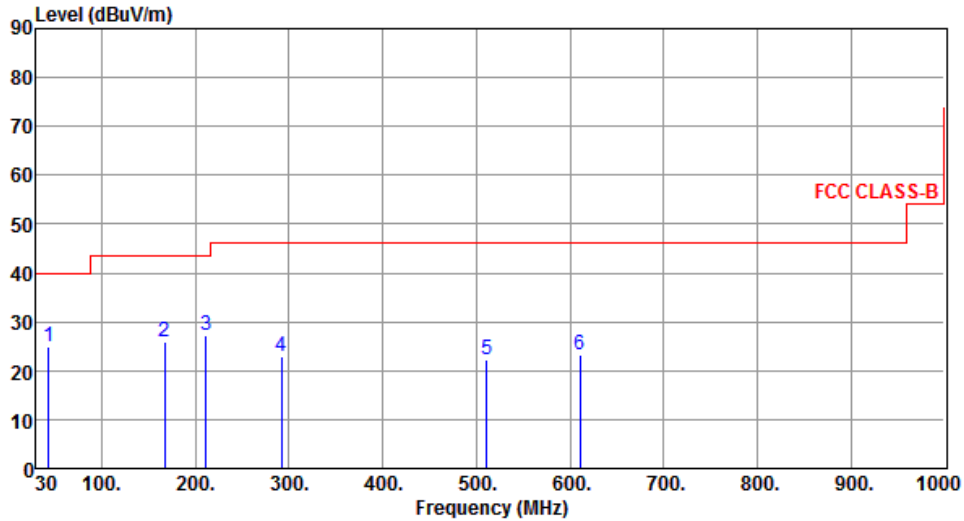

	Freq. MHz	Emission level dBuV/m	Limit dBuV/m	Margin dB	SA reading dBuV	Factor dB	Remark	ANT High cm	Turn Table deg
1	43.58	25.01	40.00	-14.99	37.93	-12.92	Peak	---	---
2	166.77	25.78	43.50	-17.72	39.72	-13.94	Peak	---	---
3	211.39	27.09	43.50	-16.41	43.50	-16.41	Peak	---	---
4	291.90	23.08	46.00	-22.92	36.12	-13.04	Peak	---	---
5	511.12	22.16	46.00	-23.84	29.70	-7.54	Peak	---	---
6	611.03	23.32	46.00	-22.68	28.95	-5.63	Peak	---	---

Note 1: Emission Level (dBuV/m) = SA Reading (dBuV/m) + Factor* (dB)

*Factor includes antenna factor , cable loss and amplifier gain

Note 2: Margin (dB) = Emission level (dBuV/m) – Limit (dBuV/m).

Note 3: All spurious emissions below 30MHz are more than 20 dB below the limit.

3.5.7 Transmitter Radiated Unwanted Emissions (Above 1GHz) for GFSK

Modulation	GFSK	Test Freq. (MHz)	2402
Polarization	Horizontal	Test Configuration	2

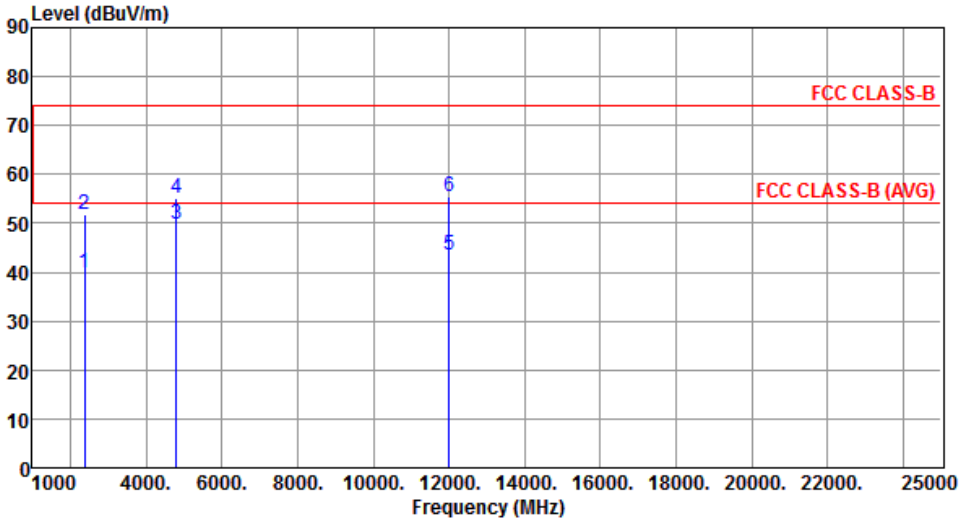

	Freq. MHz	Emission level dBuV/m	Limit dBuV/m	Margin dB	SA reading dBuV	Factor dB	Remark	ANT High cm	Turn Table deg
1	2390.00	39.89	54.00	-14.11	41.25	-1.36	Average	166	352
2	2390.00	51.92	74.00	-22.08	53.28	-1.36	Peak	166	352
3	4804.00	49.88	54.00	-4.12	43.95	5.93	Average	150	183
4	4804.00	55.27	74.00	-18.73	49.34	5.93	Peak	150	183
5	12010.00	43.37	54.00	-10.63	27.35	16.02	Average	166	211
6	12010.00	55.55	74.00	-18.45	39.53	16.02	Peak	166	211

Note 1: Emission Level (dBuV/m) = SA Reading (dBuV/m) + Factor* (dB)
 *Factor includes antenna factor , cable loss and amplifier gain
 Note 2: Margin (dB) = Emission level (dBuV/m) – Limit (dBuV/m).

Modulation	GFSK	Test Freq. (MHz)	2402
Polarization	Vertical	Test Configuration	2

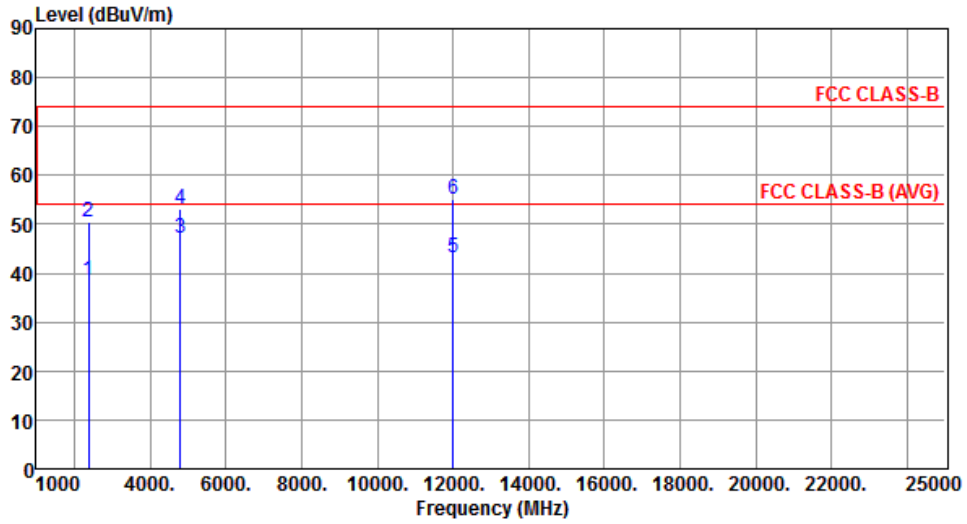

	Freq. MHz	Emission level dBuV/m	Limit dBuV/m	Margin dB	SA reading dBuV	Factor dB	Remark	ANT High cm	Turn Table deg
1	2390.00	38.66	54.00	-15.34	40.02	-1.36	Average	150	29
2	2390.00	50.59	74.00	-23.41	51.95	-1.36	Peak	150	29
3	4804.00	47.15	54.00	-6.85	41.22	5.93	Average	151	173
4	4804.00	53.09	74.00	-20.91	47.16	5.93	Peak	151	173
5	12010.00	43.20	54.00	-10.80	27.18	16.02	Average	156	321
6	12010.00	55.06	74.00	-18.94	39.04	16.02	Peak	156	321

Note 1: Emission Level (dBuV/m) = SA Reading (dBuV/m) + Factor* (dB)

*Factor includes antenna factor , cable loss and amplifier gain

Note 2: Margin (dB) = Emission level (dBuV/m) – Limit (dBuV/m).

Modulation	GFSK	Test Freq. (MHz)	2440
Polarization	Horizontal	Test Configuration	2

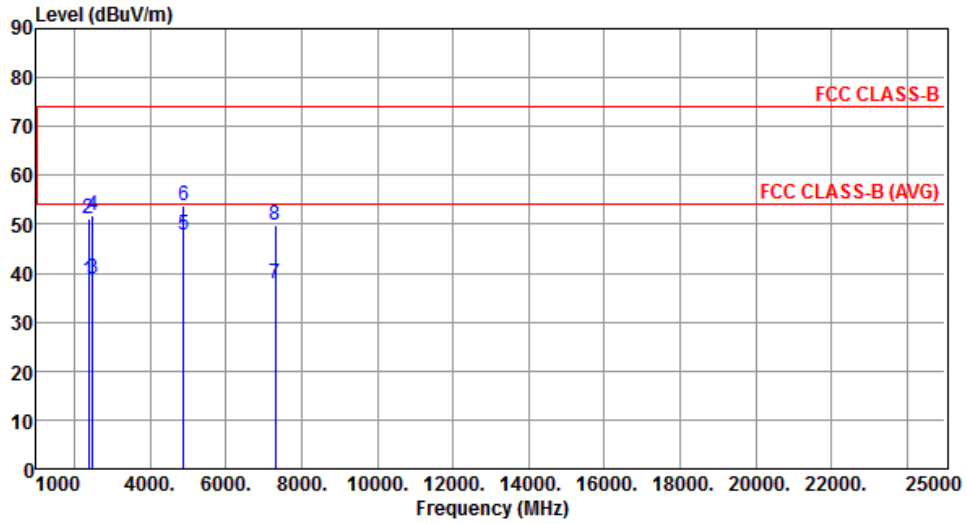

	Freq. MHz	Emission level dBuV/m	Limit dBuV/m	Margin dB	SA reading dBuV	Factor dB	Remark	ANT High cm	Turn Table deg
1	2390.00	38.52	54.00	-15.48	39.65	-1.13	Average	170	351
2	2390.00	51.31	74.00	-22.69	52.67	-1.36	Peak	170	351
3	2483.50	38.89	54.00	-15.11	39.91	-1.02	Average	170	351
4	2483.50	51.73	74.00	-22.27	52.75	-1.02	Peak	170	351
5	4880.00	47.90	54.00	-6.10	41.92	5.98	Average	150	184
6	4880.00	53.64	74.00	-20.36	47.66	5.98	Peak	150	184
7	7320.00	37.79	54.00	-16.21	27.03	10.76	Average	150	166
8	7320.00	49.95	74.00	-24.05	39.19	10.76	Peak	150	166

Note 1: Emission Level (dBuV/m) = SA Reading (dBuV/m) + Factor* (dB)

*Factor includes antenna factor , cable loss and amplifier gain

Note 2: Margin (dB) = Emission level (dBuV/m) – Limit (dBuV/m).

Modulation	GFSK	Test Freq. (MHz)	2440
Polarization	Vertical	Test Configuration	2

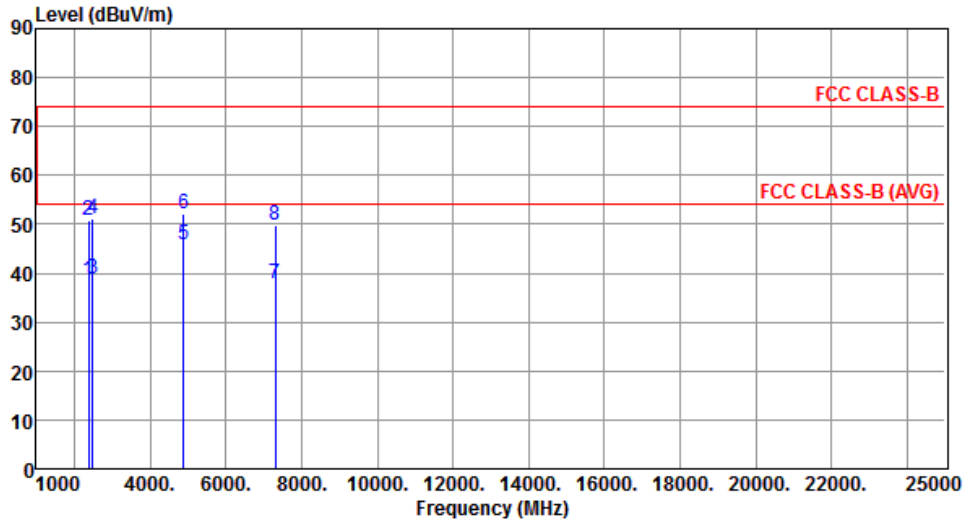

	Freq. MHz	Emission level dBuV/m	Limit dBuV/m	Margin dB	SA reading dBuV	Factor dB	Remark	ANT High cm	Turn Table deg
1	2390.00	38.37	54.00	-15.63	39.73	-1.36	Average	155	82
2	2390.00	50.82	74.00	-23.18	52.18	-1.36	Peak	155	82
3	2483.50	38.74	54.00	-15.26	39.76	-1.02	Average	155	82
4	2483.50	51.00	74.00	-23.00	52.02	-1.02	Peak	155	82
5	4880.00	45.96	54.00	-8.04	39.98	5.98	Average	150	169
6	4880.00	52.07	74.00	-21.93	46.09	5.98	Peak	150	169
7	7320.00	37.75	54.00	-16.25	26.99	10.76	Average	166	188
8	7320.00	49.84	74.00	-24.16	39.08	10.76	Peak	166	188

Note 1: Emission Level (dBuV/m) = SA Reading (dBuV/m) + Factor* (dB)

*Factor includes antenna factor , cable loss and amplifier gain

Note 2: Margin (dB) = Emission level (dBuV/m) – Limit (dBuV/m).

Modulation	GFSK	Test Freq. (MHz)	2480
Polarization	Horizontal	Test Configuration	2

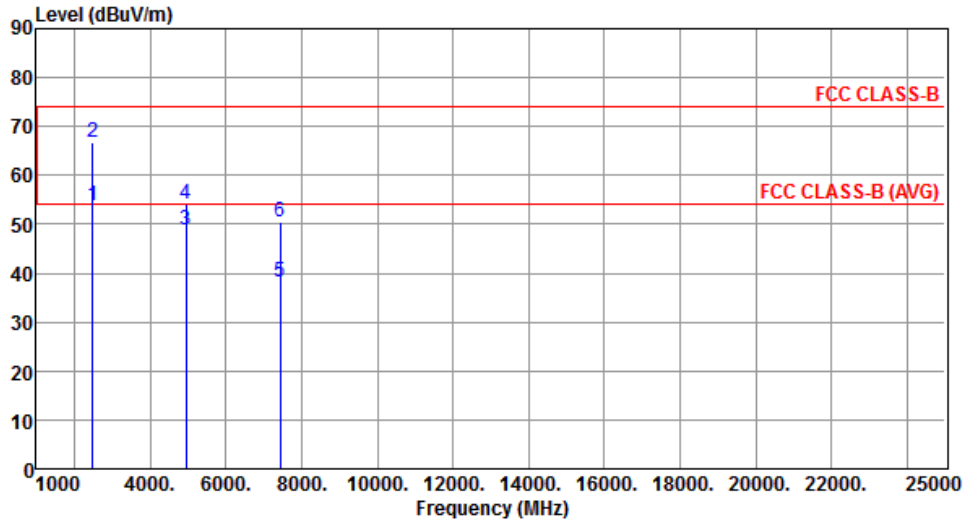

	Freq. MHz	Emission level dBuV/m	Limit dBuV/m	Margin dB	SA reading dBuV	Factor dB	Remark	ANT High cm	Turn Table deg
1	2483.50	53.73	54.00	-0.27	54.75	-1.02	Average	180	358
2	2483.50	66.68	74.00	-7.32	67.70	-1.02	Peak	180	358
3	4960.00	48.68	54.00	-5.32	42.65	6.03	Average	181	178
4	4960.00	54.12	74.00	-19.88	48.09	6.03	Peak	181	178
5	7440.00	38.23	54.00	-15.77	27.21	11.02	Average	166	159
6	7440.00	50.34	74.00	-23.66	39.32	11.02	Peak	166	159

Note 1: Emission Level (dBuV/m) = SA Reading (dBuV/m) + Factor* (dB)

*Factor includes antenna factor , cable loss and amplifier gain

Note 2: Margin (dB) = Emission level (dBuV/m) – Limit (dBuV/m).

Modulation	GFSK	Test Freq. (MHz)	2480
Polarization	Vertical	Test Configuration	2

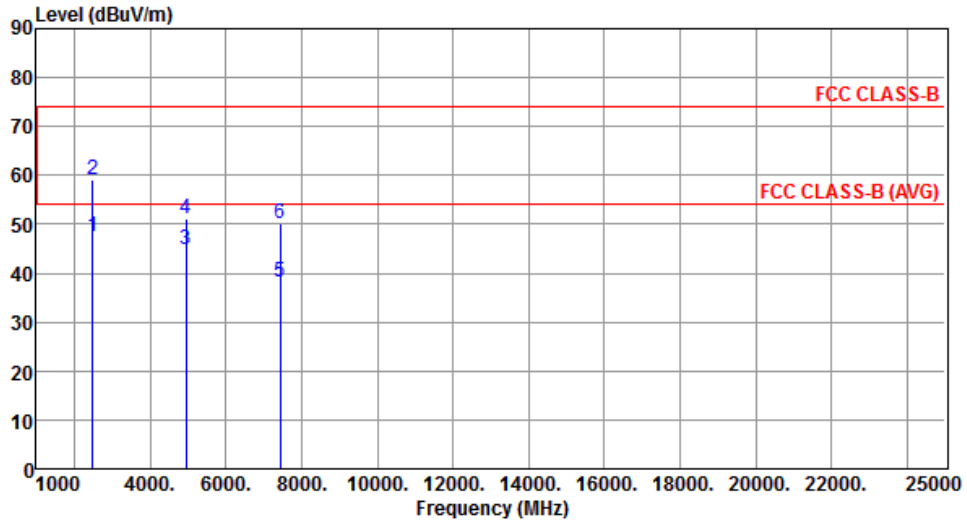

	Freq. MHz	Emission level dBuV/m	Limit dBuV/m	Margin dB	SA reading dBuV	Factor dB	Remark	ANT High cm	Turn Table deg
1	2483.50	47.33	54.00	-6.67	48.35	-1.02	Average	153	60
2	2483.50	59.18	74.00	-14.82	60.20	-1.02	Peak	153	60
3	4960.00	44.69	54.00	-9.31	38.66	6.03	Average	151	169
4	4960.00	51.21	74.00	-22.79	45.18	6.03	Peak	151	169
5	7440.00	38.10	54.00	-15.90	27.08	11.02	Average	155	166
6	7440.00	50.16	74.00	-23.84	39.14	11.02	Peak	155	166

Note 1: Emission Level (dBuV/m) = SA Reading (dBuV/m) + Factor* (dB)

*Factor includes antenna factor , cable loss and amplifier gain

Note 2: Margin (dB) = Emission level (dBuV/m) – Limit (dBuV/m).

Test Configuration 3: Isolated Magnetic Dipole antenna

3.5.8 Transmitter Radiated Unwanted Emissions (Below 1GHz)

Modulation	GFSK	Test Freq. (MHz)	2440
Polarization	Horizontal	Test Configuration	3

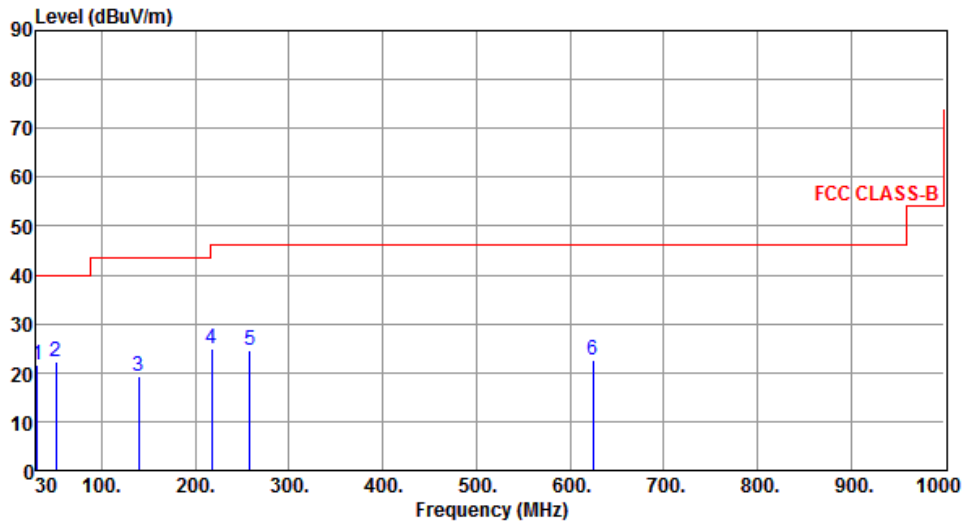

	Freq. MHz	Emission level dBuV/m	Limit dBuV/m	Margin dB	SA reading dBuV	Factor dB	Remark	ANT High cm	Turn Table deg
1	30.97	21.66	40.00	-18.34	35.17	-13.51	Peak	---	---
2	51.34	22.23	40.00	-17.77	35.36	-13.13	Peak	---	---
3	139.61	19.43	43.50	-24.07	33.21	-13.78	Peak	---	---
4	217.21	24.85	46.00	-21.15	40.96	-16.11	Peak	---	---
5	257.95	24.60	46.00	-21.40	39.07	-14.47	Peak	---	---
6	624.61	22.67	46.00	-23.33	28.11	-5.44	Peak	---	---

Note 1: Emission Level (dBuV/m) = SA Reading (dBuV/m) + Factor* (dB)

*Factor includes antenna factor, cable loss and amplifier gain

Note 2: Margin (dB) = Emission level (dBuV/m) – Limit (dBuV/m).

Note 3: All spurious emissions below 30MHz are more than 20 dB below the limit.

Modulation	GFSK	Test Freq. (MHz)	2440
Polarization	Vertical	Test Configuration	3

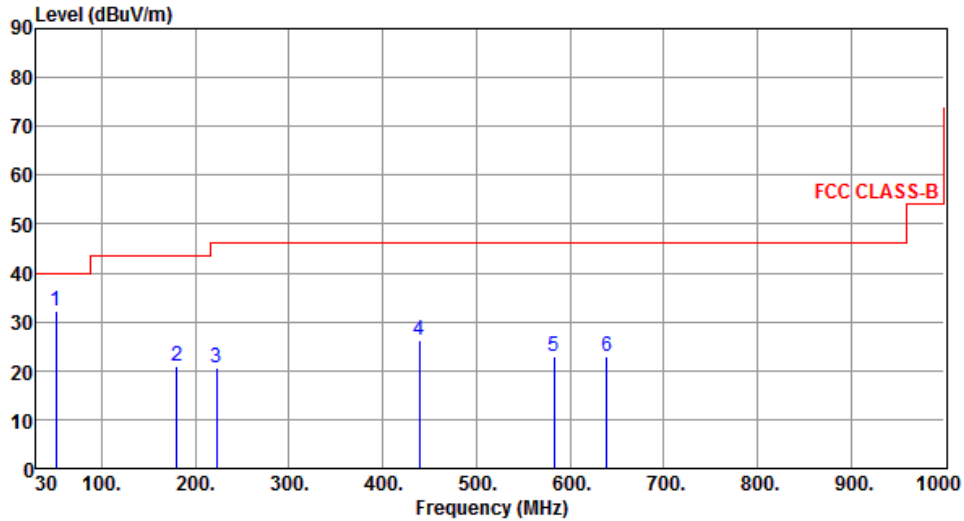

	Freq. MHz	Emission level dBuV/m	Limit dBuV/m	Margin dB	SA reading dBuV	Factor dB	Remark	ANT High cm	Turn Table deg
1	51.34	32.14	40.00	-7.86	45.27	-13.13	Peak	---	---
2	180.35	20.82	43.50	-22.68	36.13	-15.31	Peak	---	---
3	223.03	20.65	46.00	-25.35	36.43	-15.78	Peak	---	---
4	439.34	26.18	46.00	-19.82	35.23	-9.05	Peak	---	---
5	582.90	22.95	46.00	-23.05	29.20	-6.25	Peak	---	---
6	639.16	22.90	46.00	-23.10	28.13	-5.23	Peak	---	---

Note 1: Emission Level (dBuV/m) = SA Reading (dBuV/m) + Factor* (dB)

*Factor includes antenna factor , cable loss and amplifier gain

Note 2: Margin (dB) = Emission level (dBuV/m) – Limit (dBuV/m).

Note 3: All spurious emissions below 30MHz are more than 20 dB below the limit.

3.5.9 Transmitter Radiated Unwanted Emissions (Above 1GHz) for GFSK

Modulation	GFSK	Test Freq. (MHz)	2402
Polarization	Horizontal	Test Configuration	3

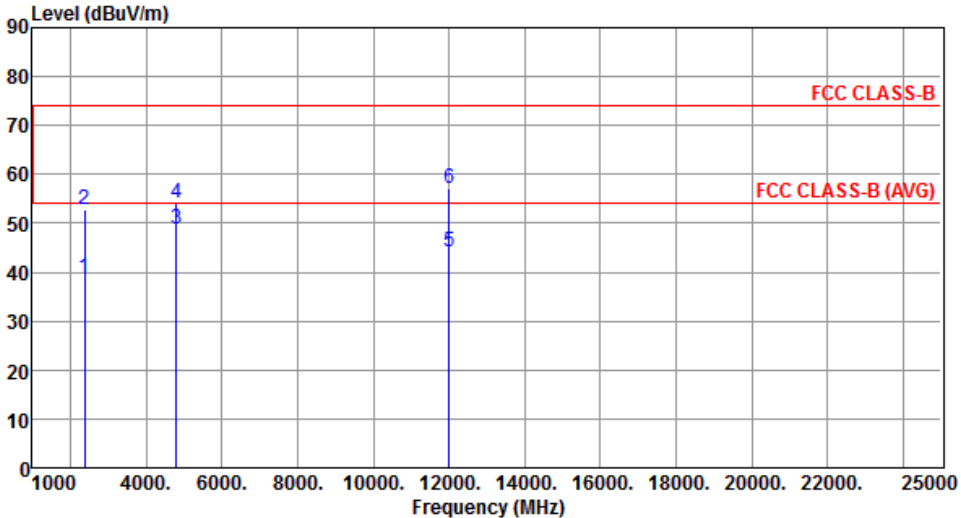

The graph plots Level (dBuV/m) on the y-axis (0 to 90) against Frequency (MHz) on the x-axis (1000 to 25000). Two horizontal red lines represent the FCC CLASS-B limit at approximately 74 dBuV/m and the FCC CLASS-B (AVG) limit at approximately 54 dBuV/m. Six vertical blue lines represent individual test points, labeled 1 through 6, with their corresponding emission levels and margins indicated by the table below.

	Freq. MHz	Emission level dBuV/m	Limit dBuV/m	Margin dB	SA reading dBuV	Factor dB	Remark	ANT High cm	Turn Table deg
1	2390.00	38.88	54.00	-15.12	40.24	-1.36	Average	150	183
2	2390.00	52.94	74.00	-21.06	54.30	-1.36	Peak	150	183
3	4804.00	48.66	54.00	-5.34	42.73	5.93	Average	150	183
4	4804.00	54.22	74.00	-19.78	48.29	5.93	Peak	150	183
5	12010.00	44.13	54.00	-9.87	28.11	16.02	Average	150	199
6	12010.00	57.28	74.00	-16.72	41.26	16.02	Peak	150	199

Note 1: Emission Level (dBuV/m) = SA Reading (dBuV/m) + Factor* (dB)
 *Factor includes antenna factor , cable loss and amplifier gain
 Note 2: Margin (dB) = Emission level (dBuV/m) – Limit (dBuV/m).

Modulation	GFSK	Test Freq. (MHz)	2402
Polarization	Vertical	Test Configuration	3

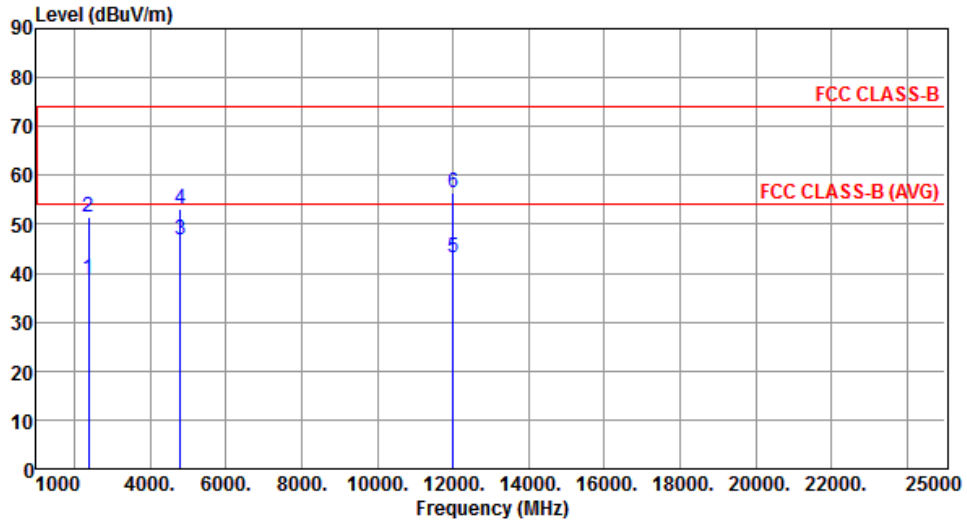

	Freq. MHz	Emission level dBuV/m	Limit dBuV/m	Margin dB	SA reading dBuV	Factor dB	Remark	ANT High cm	Turn Table deg
1	2390.00	38.74	54.00	-15.26	40.10	-1.36	Average	188	115
2	2390.00	51.62	74.00	-22.38	52.98	-1.36	Peak	188	115
3	4804.00	46.89	54.00	-7.11	40.96	5.93	Average	150	188
4	4804.00	53.02	74.00	-20.98	47.09	5.93	Peak	150	188
5	12010.00	43.34	54.00	-10.66	27.32	16.02	Average	150	166
6	12010.00	56.60	74.00	-17.40	40.58	16.02	Peak	150	166

Note 1: Emission Level (dBuV/m) = SA Reading (dBuV/m) + Factor* (dB)

*Factor includes antenna factor , cable loss and amplifier gain

Note 2: Margin (dB) = Emission level (dBuV/m) – Limit (dBuV/m).

Modulation	GFSK	Test Freq. (MHz)	2440
Polarization	Horizontal	Test Configuration	3

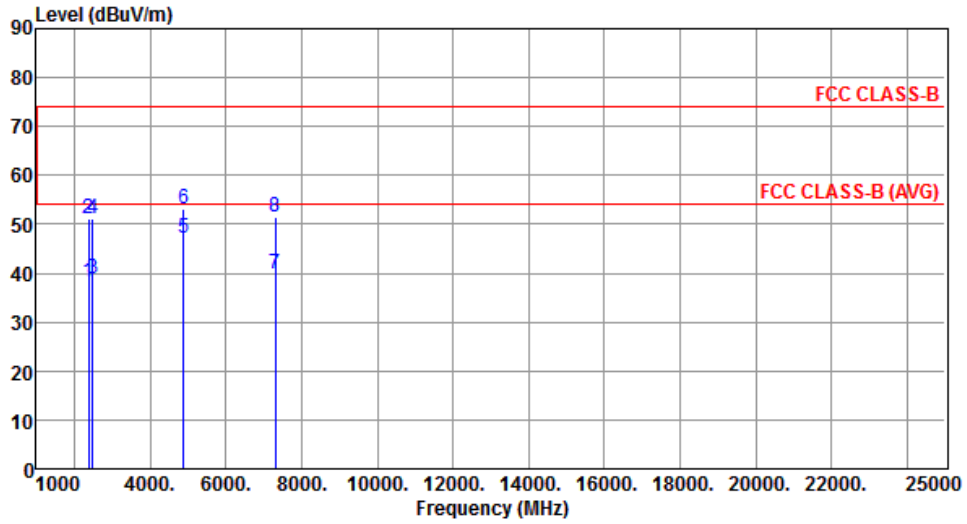

	Freq. MHz	Emission level dBuV/m	Limit dBuV/m	Margin dB	SA reading dBuV	Factor dB	Remark	ANT High cm	Turn Table deg
1	2390.00	38.25	54.00	-15.75	39.61	-1.36	Average	150	184
2	2390.00	51.28	74.00	-22.72	52.64	-1.36	Peak	150	184
3	2483.50	38.71	54.00	-15.29	39.73	-1.02	Average	150	184
4	2483.50	51.18	74.00	-22.82	52.20	-1.02	Peak	150	184
5	4880.00	47.21	54.00	-6.79	41.23	5.98	Average	150	188
6	4880.00	53.27	74.00	-20.73	47.29	5.98	Peak	150	188
7	7320.00	39.92	54.00	-14.08	29.16	10.76	Average	166	196
8	7320.00	51.35	74.00	-22.65	40.59	10.76	Peak	166	196

Note 1: Emission Level (dBuV/m) = SA Reading (dBuV/m) + Factor* (dB)

*Factor includes antenna factor , cable loss and amplifier gain

Note 2: Margin (dB) = Emission level (dBuV/m) – Limit (dBuV/m).

Modulation	GFSK	Test Freq. (MHz)	2440
Polarization	Vertical	Test Configuration	3

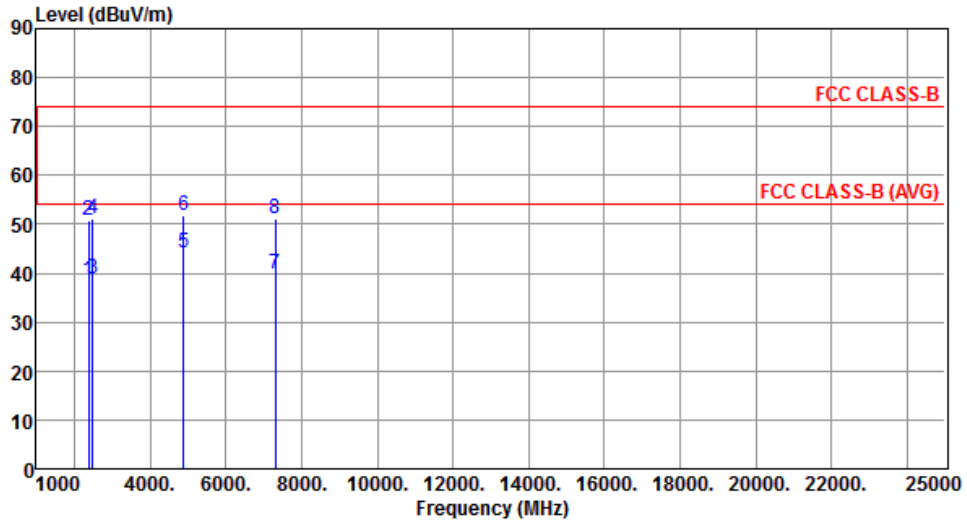

	Freq. MHz	Emission level dBuV/m	Limit dBuV/m	Margin dB	SA reading dBuV	Factor dB	Remark	ANT High cm	Turn Table deg
1	2390.00	38.55	54.00	-15.45	39.91	-1.36	Average	184	101
2	2390.00	50.94	74.00	-23.06	52.30	-1.36	Peak	184	101
3	2483.50	38.76	54.00	-15.24	39.78	-1.02	Average	184	101
4	2483.50	51.08	74.00	-22.92	52.10	-1.02	Peak	184	101
5	4880.00	44.29	54.00	-9.71	38.31	5.98	Average	150	186
6	4880.00	51.84	74.00	-22.16	45.86	5.98	Peak	150	186
7	7320.00	39.79	54.00	-14.21	29.03	10.76	Average	166	183
8	7320.00	51.29	74.00	-22.71	40.53	10.76	Peak	166	183

Note 1: Emission Level (dBuV/m) = SA Reading (dBuV/m) + Factor* (dB)

*Factor includes antenna factor , cable loss and amplifier gain

Note 2: Margin (dB) = Emission level (dBuV/m) – Limit (dBuV/m).

Modulation	GFSK	Test Freq. (MHz)	2480
Polarization	Horizontal	Test Configuration	3

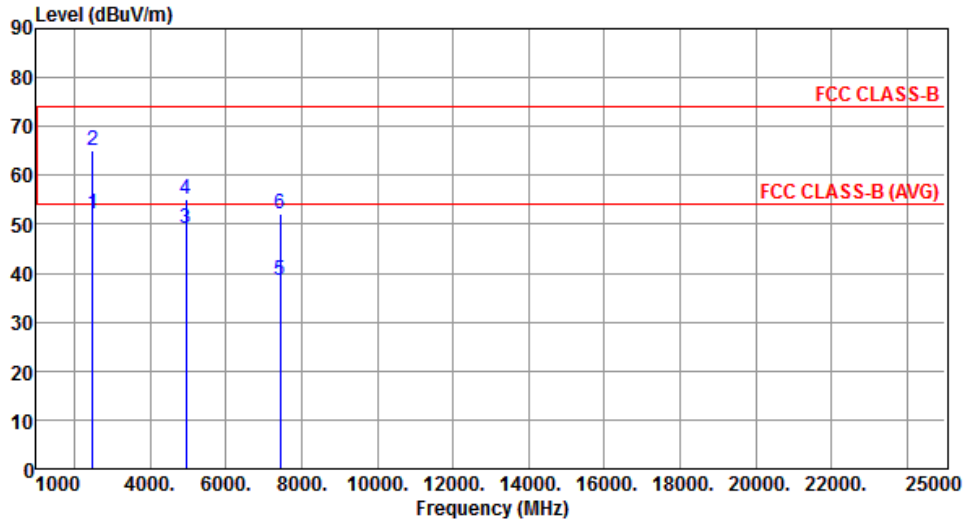

	Freq. MHz	Emission level dBuV/m	Limit dBuV/m	Margin dB	SA reading dBuV	Factor dB	Remark	ANT High cm	Turn Table deg
1	2483.50	52.23	54.00	-1.77	53.25	-1.02	Average	150	184
2	2483.50	65.02	74.00	-8.98	66.04	-1.02	Peak	150	184
3	4960.00	49.18	54.00	-4.82	43.15	6.03	Average	150	175
4	4960.00	55.02	74.00	-18.98	48.99	6.03	Peak	150	175
5	7440.00	38.37	54.00	-15.63	27.35	11.02	Average	150	198
6	7440.00	52.05	74.00	-21.95	41.03	11.02	Peak	150	198

Note 1: Emission Level (dBuV/m) = SA Reading (dBuV/m) + Factor* (dB)

*Factor includes antenna factor , cable loss and amplifier gain

Note 2: Margin (dB) = Emission level (dBuV/m) – Limit (dBuV/m).

Modulation	GFSK	Test Freq. (MHz)	2480
Polarization	Vertical	Test Configuration	3

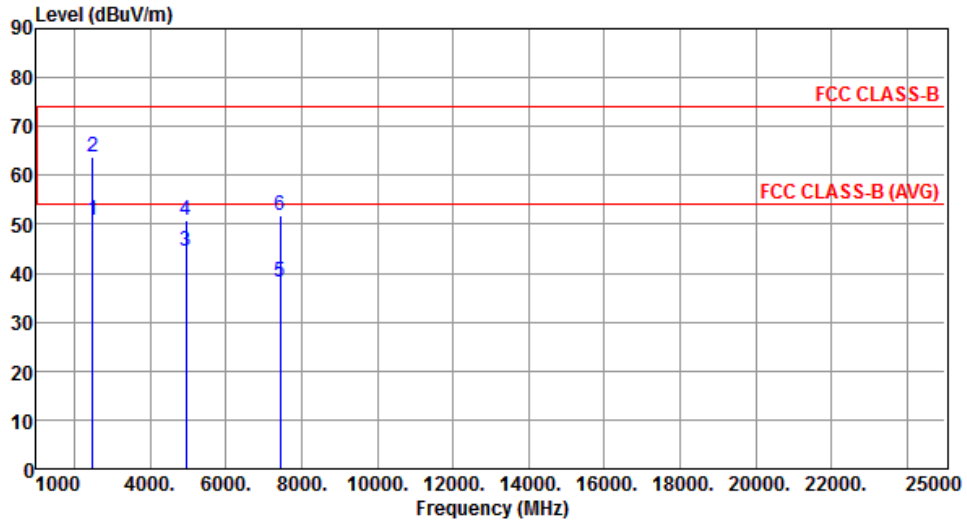

	Freq. MHz	Emission level dBuV/m	Limit dBuV/m	Margin dB	SA reading dBuV	Factor dB	Remark	ANT High cm	Turn Table deg
1	2483.50	50.90	54.00	-3.10	51.92	-1.02	Average	181	102
2	2483.50	63.68	74.00	-10.32	64.70	-1.02	Peak	181	102
3	4960.00	44.48	54.00	-9.52	38.45	6.03	Average	150	183
4	4960.00	50.81	74.00	-23.19	44.78	6.03	Peak	150	183
5	7440.00	38.28	54.00	-15.72	27.26	11.02	Average	196	222
6	7440.00	51.88	74.00	-22.12	40.86	11.02	Peak	196	222

Note 1: Emission Level (dBuV/m) = SA Reading (dBuV/m) + Factor* (dB)

*Factor includes antenna factor , cable loss and amplifier gain

Note 2: Margin (dB) = Emission level (dBuV/m) – Limit (dBuV/m).

3.6 Emissions in non-restricted Frequency Bands

3.6.1 Emissions in non-restricted frequency bands limit

The peak output power measured in any 100 kHz bandwidth outside of the authorized frequency band shall be attenuated by at least 20 dB relative to the maximum in-band peak PSD level in 100 kHz.

3.6.2 Test Procedures

Reference Level Measurement

1. Set the RBW = 100 kHz, VBW = 300 kHz, Detector = peak.
2. Set Sweep time = auto couple, Trace mode = max hold.
3. Allow trace to fully stabilize.
4. Use the peak marker function to determine the maximum amplitude level.

Unwanted Emissions Level Measurement

1. Set RBW = 100 kHz, VBW = 300 kHz, Detector = peak.
2. Trace Mode = max hold, Sweep = auto couple.
3. Allow the trace to stabilize.
4. Use peak marker function to determine maximum amplitude of all unwanted emissions within any 100 kHz bandwidth.

3.6.3 Test Setup

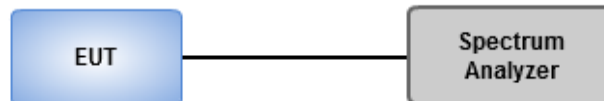

3.6.4 Test Result of Emissions in non-restricted Frequency Bands

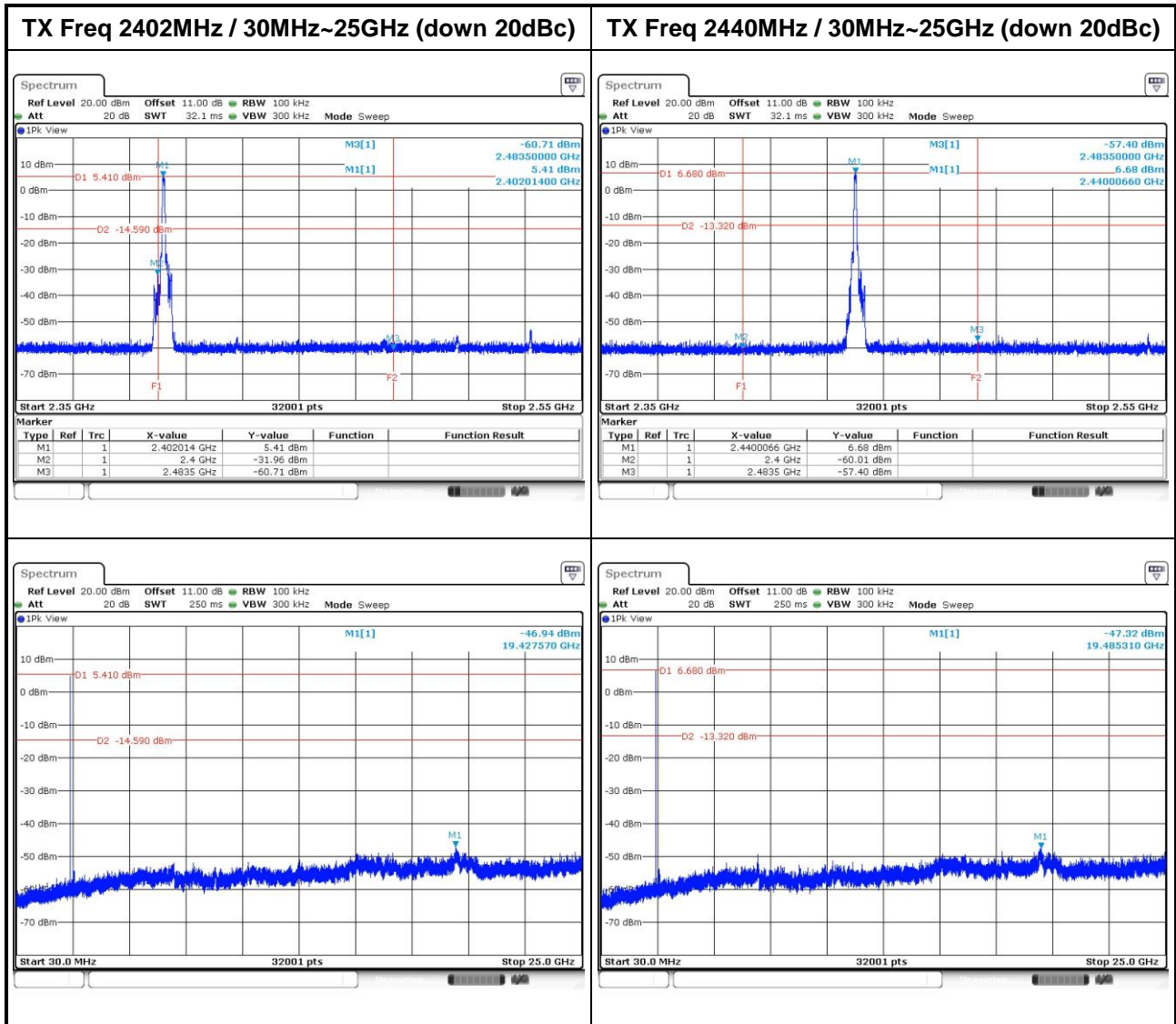

TX Freq 2480MHz / 30MHz~25GHz (down 20dBc)

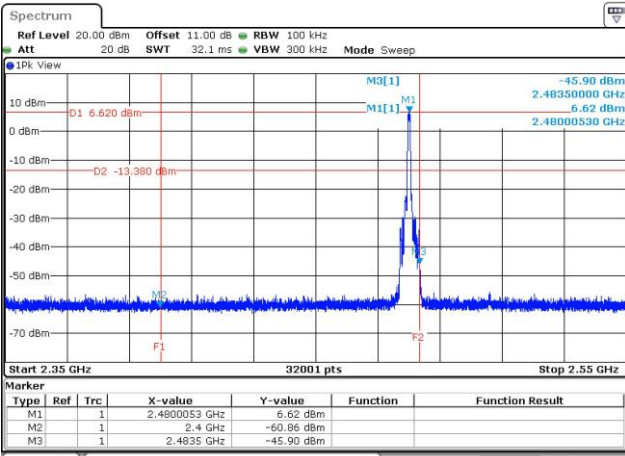

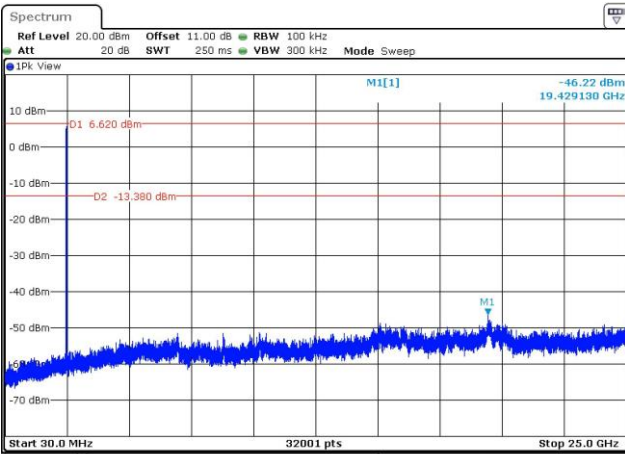

4 Test laboratory information

Established in 2012, ICC provides foremost EMC & RF Testing and advisory consultation services by our skilled engineers and technicians. Our services employ a wide variety of advanced edge test equipment and one of the widest certification extents in the business.

International Certification Corp, it is our definitive objective is to institute long term, trust-based associations with our clients. The expectation we set up with our clients is based on outstanding service, practical expertise and devotion to a certified value structure. Our passion is to grant our clients with best EMC / RF services by oriented knowledgeable and accommodating staff.

Our Test sites are located at Linkou District and Kwei Shan Hsiang. Location map can be found on our website <http://www.icertifi.com.tw>.

Linkou

Tel: 886-2-2601-1640

No. 30-2, Ding Fwu Tsuen, Lin Kou
District, New Taipei City, Taiwan,
R.O.C.

Kwei Shan

Tel: 886-3-271-8666

No. 3-1, Lane 6, Wen San 3rd
St., Kwei Shan Hsiang, Tao Yuan
Hsien 333, Taiwan, R.O.C.

Kwei Shan Site II

Tel: 886-3-271-8640

No. 14-1, Lane 19, Wen San 3rd
St., Kwei Shan Hsiang, Tao Yuan
Hsien 333, Taiwan, R.O.C.

If you have any suggestion, please feel free to contact us as below information

Tel: 886-3-271-8666

Fax: 886-3-318-0155

Email: ICC_Service@icertifi.com.tw

==END==