

FCC Test Report

FCC ID : SQG-M2SD50NBT
Equipment : 802.11abgn M.2 module w/SDIO interface
Model No. : M2SD50NBT
Brand Name : Laird Technologies
Applicant : Laird Technologies
Address : 11160 Thompson Ave., Lenexa, Kansas 66219,
USA
Standard : 47 CFR FCC Part 15.247
Received Date : Sep. 11, 2015
Tested Date : Dec. 02, 2015 ~ Jan. 11, 2016

We, International Certification Corp., would like to declare that the tested sample has been evaluated and in compliance with the requirement of the above standards. The test results contained in this report refer exclusively to the product. It may be duplicated completely for legal use with the approval of the applicant. It shall not be reproduced except in full without the written approval of our laboratory.

Approved & Reviewed by:



Gary Chang / Manager



Table of Contents

1	GENERAL DESCRIPTION	5
1.1	Information.....	5
1.2	Local Support Equipment List	7
1.3	Test Setup Chart	7
1.4	The Equipment List	8
1.5	Test Standards	9
1.6	Measurement Uncertainty	9
2	TEST CONFIGURATION	10
2.1	Testing Condition	10
2.2	The Worst Test Modes and Channel Details	10
3	TRANSMITTER TEST RESULTS.....	11
3.1	Conducted Emissions.....	11
3.2	6dB and Occupied Bandwidth	14
3.3	RF Output Power	17
3.4	Power Spectral Density	19
3.5	Unwanted Emissions into Restricted Frequency Bands	21
3.6	Emissions in Non-Restricted Frequency Bands	83
4	TEST LABORATORY INFORMATION	93

Release Record

Report No.	Version	Description	Issued Date
FR591102AC	Rev. 01	Initial issue	Feb. 16, 2016

Summary of Test Results

FCC Rules	Test Items	Measured	Result
15.207	Conducted Emissions	[dBuV]: 21.147MHz 20.18 (Margin -29.82dB) - AV	Pass
15.247(d) 15.209	Radiated Emissions	[dBuV/m at 3m]: 2483.50MHz 73.87 (Margin -0.13dB) - PK	Pass
15.247(b)(3)	Maximum Output Power	Max Power [dBm]: 26.89	Pass
15.247(a)(2)	6dB Bandwidth	Meet the requirement of limit	Pass
15.247(e)	Power Spectral Density	Meet the requirement of limit	Pass
15.203	Antenna Requirement	Meet the requirement of limit	Pass

1 General Description

1.1 Information

1.1.1 Specification of the Equipment under Test (EUT)

RF General Information					
Frequency Range (MHz)	IEEE Std. 802.11	Ch. Freq. (MHz)	Channel Number	Transmit Chains (N _{TX})	Data Rate / MCS
2400-2483.5	b	2412-2462	1-11 [11]	1 2	1-11 Mbps
2400-2483.5	g	2412-2462	1-11 [11]	1 2	6-54 Mbps
2400-2483.5	n (HT20)	2412-2462	1-11 [11]	1 2 2	MCS 0-7 MCS 0-7 MCS 8-15

Note 1: RF output power specifies that Maximum Peak Conducted Output Power.
 Note 2: 802.11b uses a combination of DSSS-DBPSK, DQPSK, CCK modulation.
 Note 3: 802.11g/n uses a combination of OFDM-BPSK, QPSK, 16QAM, 64QAM modulation.
 Note 4: The device supports TX antenna diversity function. The conducted power of single chain is same for 1TX and 2TX operating mode. Therefore, Ant1+Ant2 configuration is chosen for final testing.

1.1.2 Antenna Details

Ant. No.	Model	Type	Connector	Operating Frequencies (MHz) / Antenna Gain (dBi)				
				2400~2483.5	5150~5250	5250~5350	5470~5725	5725~5850
1	Laird MAF94051	Dipole	RP-SMA	2.1	2.4	2.6	3.4	3.4
2	Laird NanoBlade-IP04	PCB Dipole	IPEX MHF	2	3.9	3.9	4	4
3	Laird MAF95310 Mini NanoBlade Flex	PCB Dipole	IPEX MHF	2.79	3.38	3.38	3.38	3.38
4	Laird NanoBlue-IP04	PCB Dipole	IPEX MHF	2	---	---	---	---
5	Ethertronics WLAN_1000146	Isolated Magnetic Dipole	IPEX MHF	2.5	3.5	3.5	3.5	3.5

Note: Ant. No. 1, 3 & 5 were for 2.4G final test.

Ant. No. 1, 2 & 5 were for 5G final test.

1.1.3 Power Supply Type of Equipment under Test (EUT)

Power Supply Type	3.3Vdc from host
--------------------------	------------------

1.1.4 Accessories

N/A

1.1.5 Channel List

Channel	Frequency(MHz)
1	2412
2	2417
3	2422
4	2427
5	2432
6	2437
7	2442
8	2447
9	2452
10	2457
11	2462

1.1.6 Test Tool and Duty Cycle

Test Tool	ART2 GUI, V2.3		
Duty Cycle and Duty Factor	Mode	Duty cycle (%)	Duty factor (dB)
	11b	100.00%	0.00
	11g	98.26%	0.08
	HT20	98.13%	0.08

1.1.7 Power Setting

Modulation Mode	Test Frequency (MHz)	Power Set
11b	2412	16.5
11b	2437	19
11b	2462	19
11g	2412	17
11g	2437	20.5
11g	2462	17
HT20	2412	16.5
HT20	2437	21
HT20	2462	16.5

1.2 Local Support Equipment List

Support Equipment List						
No.	Equipment	Brand	Model	S/N	FCC ID	Signal cable / Length (m)
1	DC Power Supply	GW INSTEK	GPC-3060D	EM884797	---	---
2	Notebook	DELL	Latitude E6430	9ZFB4X1	DoC	---

1.3 Test Setup Chart

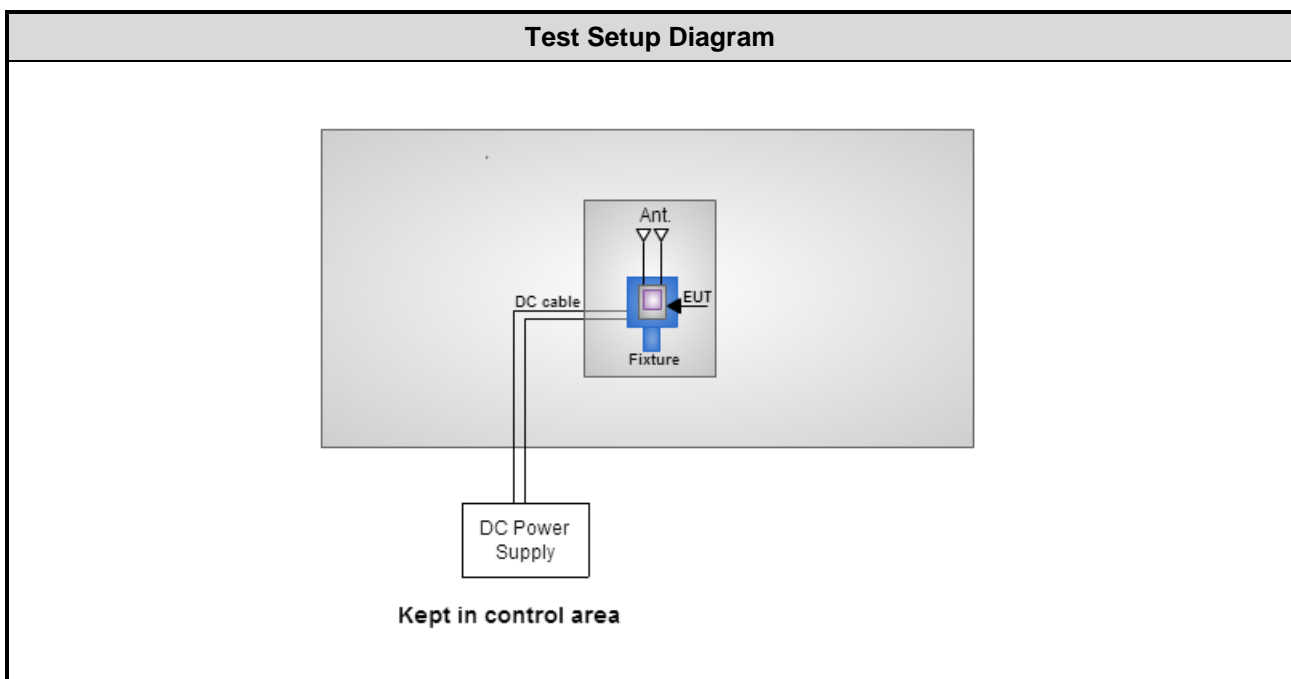

Note: The support notebook was disconnected from EUT and removed from test table when EUT is set to transmit continuously.

1.4 The Equipment List

Test Item	Conducted Emission				
Test Site	Conduction room 1 / (CO01-WS)				
Tested Date	Jan. 07, 2016				
Instrument	Manufacturer	Model No.	Serial No.	Calibration Date	Calibration Until
EMC Receiver	R&S	ESCS 30	100169	Oct. 21, 2015	Oct. 20, 2016
LISN	SCHWARZBECK	Schwarzbeck 8127	8127-667	Nov. 13, 2015	Nov. 12, 2016
RF Cable-CON	EMC	EMCCFD300-BM-BM-6000	50821	Dec. 21, 2015	Dec. 20, 2016
Measurement Software	AUDIX	e3	6.120210k	NA	NA
Note: Calibration Interval of instruments listed above is one year.					

Test Item	Radiated Emission				
Test Site	966 chamber 3 / (03CH03-WS)				
Tested Date	Dec. 02 ~ Dec. 15, 2015				
Instrument	Manufacturer	Model No.	Serial No.	Calibration Date	Calibration Until
Spectrum Analyzer	Agilent	N9010A	MY53400091	Sep. 14, 2015	Sep. 13, 2016
Receiver	Agilent	N9038A	MY53290044	Oct. 14, 2015	Oct. 13, 2016
Bilog Antenna	SCHWARZBECK	VULB9168	VULB9168-563	Dec. 30, 2014	Dec. 29, 2015
Horn Antenna 1G-18G	SCHWARZBECK	BBHA 9120 D	BBHA 9120 D 1206	Feb. 03, 2015	Feb. 02, 2016
Horn Antenna 18G-40G	SCHWARZBECK	BBHA 9170	BBHA 9170517	Nov. 04, 2015	Nov. 03, 2016
Preamplifier	EMC	EMC02325	980187	Sep. 21, 2015	Sep. 20, 2016
Preamplifier	Agilent	83017A	MY53270014	Sep. 07, 2015	Sep. 06, 2016
Preamplifier	EMC	EMC184045B	980192	Sep. 01, 2015	Aug. 31, 2016
RF cable-3M	HUBER+SUHNER	SUCOFLEX104	MY22620/4	Feb. 09, 2015	Feb. 08, 2016
RF cable-8M	HUBER+SUHNER	SUCOFLEX104	MY22600/4	Feb. 09, 2015	Feb. 08, 2016
RF cable-1M	HUBER+SUHNER	SUCOFLEX104	MY22624/4	Feb. 09, 2015	Feb. 08, 2016
LF cable-0.8M	EMC	EMC8D-NM-NM-800	EMC8D-NM-NM-800-001	Feb. 09, 2015	Feb. 08, 2016
LF cable-3M	EMC	EMC8D-NM-NM-3000	131103	Feb. 09, 2015	Feb. 08, 2016
LF cable-13M	EMC	EMC8D-NM-NM-13000	131104	Feb. 09, 2015	Feb. 08, 2016
Measurement Software	AUDIX	e3	6.120210g	NA	NA
Note: Calibration Interval of instruments listed above is one year.					

Test Item	RF Conducted				
Test Site	(TH01-WS)				
Tested Date	Jan. 09 ~ Jan. 11, 2016				
Instrument	Manufacturer	Model No.	Serial No.	Calibration Date	Calibration Until
Spectrum Analyzer	R&S	FSV40	101063	Feb. 03, 2015	Feb. 02, 2016
Power Meter	Anritsu	ML2495A	1241002	Sep. 21, 2015	Sep. 20, 2016
Power Sensor	Anritsu	MA2411B	1207366	Sep. 21, 2015	Sep. 20, 2016
DC POWER SOURCE	GW INSTRON	GPC-3060D	EM884797	Oct. 20, 2015	Oct. 19, 2016
Measurement Software	Sporton	Sporton_1	1.3.30	NA	NA
Note: Calibration Interval of instruments listed above is one year.					

1.5 Test Standards

According to the specification of EUT, the EUT must comply with following standards and KDB documents.

47 CFR FCC Part 15.247

ANSI C63.10-2013

FCC KDB 558074 D01 DTS Meas Guidance v03r04

FCC KDB 662911 D01 Multiple Transmitter Output v02r01

1.6 Measurement Uncertainty

ISO/IEC 17025 requires that an estimate of the measurement uncertainties associated with the emissions test results be included in the report. The measurement uncertainties given below are based on a 95% confidence level (based on a coverage factor ($k=2$))

Measurement Uncertainty	
Parameters	Uncertainty
Bandwidth	± 34.134 Hz
Conducted power	± 0.808 dB
Power density	± 0.463 dB
Conducted emission	± 2.670 dB
AC conducted emission	± 2.90 dB
Radiated emission ≤ 1 GHz	± 3.66 dB
Radiated emission > 1 GHz	± 5.37 dB

2 Test Configuration

2.1 Testing Condition

Test Item	Test Site	Ambient Condition	Tested By
AC Conduction	CO01-WS	20°C / 60%	Peter Lin
Radiated Emissions	03CH03-WS	19-23°C / 60-64%	Anderson Hong Felix Sung Vincent Yeh
RF Conducted	TH01-WS	21°C / 64%	Alex Huang

➤ FCC site registration No.: 390588

➤ IC site registration No.: 10807C-1

2.2 The Worst Test Modes and Channel Details

Test item	Modulation Mode	Test Frequency (MHz)	Data Rate	Test Configuration
Conducted Emissions	HT20	2437	MCS 0	2
Radiated Emissions ≤1GHz	HT20	2437	MCS 0	1, 2, 3
Radiated Emissions >1GHz	11b 11g HT20	2412 / 2437 / 2462 2412 / 2437 / 2462 2412 / 2437 / 2462	1 Mbps 6 Mbps MCS 0	1, 2, 3
Maximum Output Power 6dB bandwidth Power spectral density	11b 11g HT20	2412 / 2437 / 2462 2412 / 2437 / 2462 2412 / 2437 / 2462	1 Mbps 6 Mbps MCS 0	2

NOTE:

1. The EUT was pretested with 3 orientations placed on the table for the radiated emission measurement – X, Y, and Z-plane. The **Y-plane** results were found as the worst case and were shown in this report.
2. The following antennas are used for final testing for this module: (See item 1.1.2 for more details.)
 - 1) Configuration 1 : Dipole antenna
 - 2) Configuration 2 : PCB Dipole antenna
 - 3) Configuration 3 : Isolated Magnetic Dipole antenna

3 Transmitter Test Results

3.1 Conducted Emissions

3.1.1 Limit of Conducted Emissions

Conducted Emissions Limit		
Frequency Emission (MHz)	Quasi-Peak	Average
0.15-0.5	66 - 56 *	56 - 46 *
0.5-5	56	46
5-30	60	50

Note 1: * Decreases with the logarithm of the frequency.

3.1.2 Test Procedures

1. The device is placed on a test table, raised 80 cm above the reference ground plane. The vertical conducting plane is located 40 cm to the rear of the device.
2. The device is connected to line impedance stabilization network (LISN) and other accessories are connected to other LISN. Measured levels of AC power line conducted emission are across the 50 Ω LISN port.
3. AC conducted emission measurements is made over frequency range from 150 kHz to 30 MHz.
4. This measurement was performed with AC 120V / 60Hz.

3.1.3 Test Setup



- Note: 1. Support units were connected to second LISN.
 2. Both of LISNs (AMN) are 80 cm from EUT and at least 80 cm from other units and other metal planes

3.1.4 Test Result of Conducted Emissions

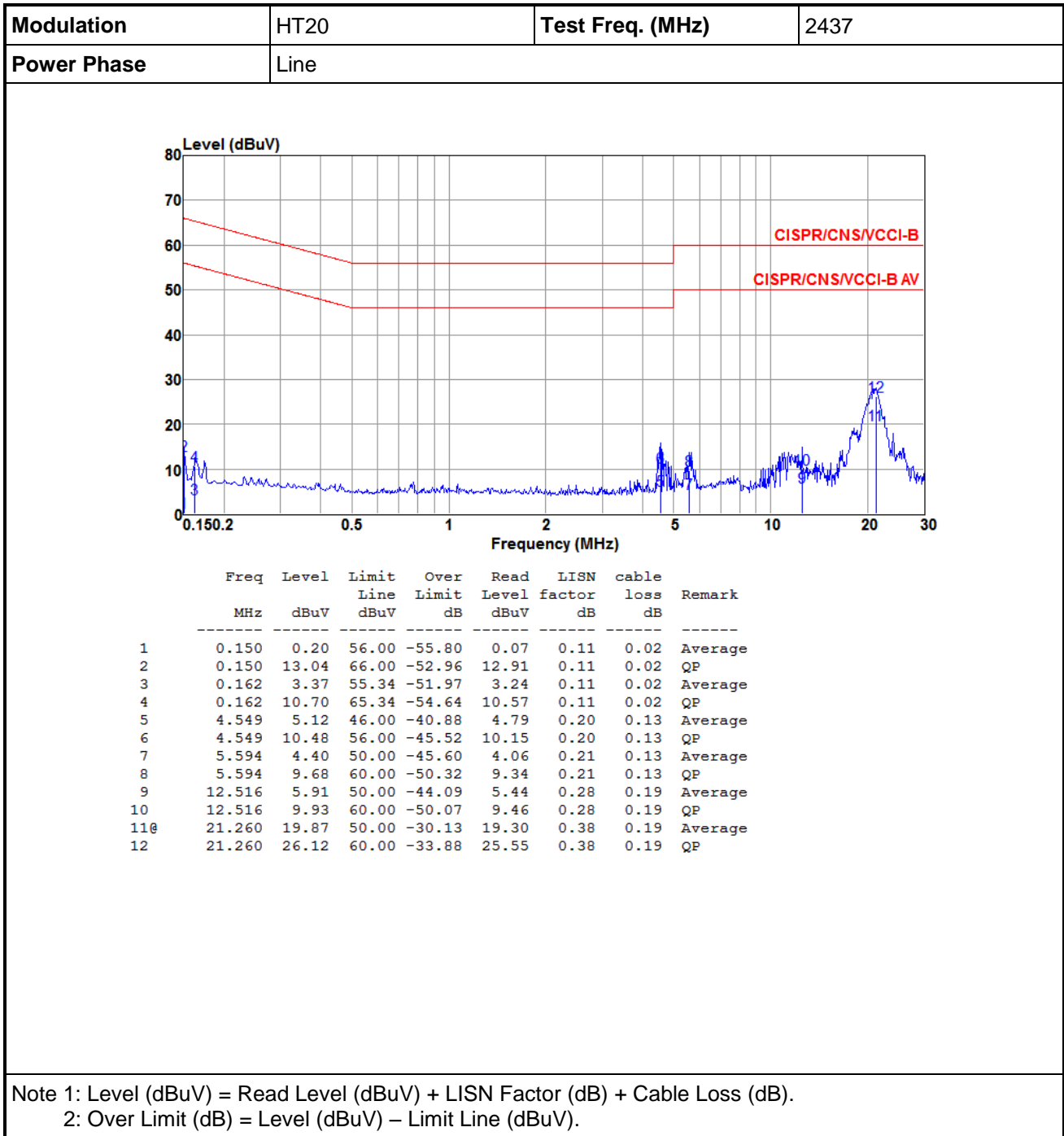

Modulation	HT20	Test Freq. (MHz)	2437
Power Phase	Neutral		

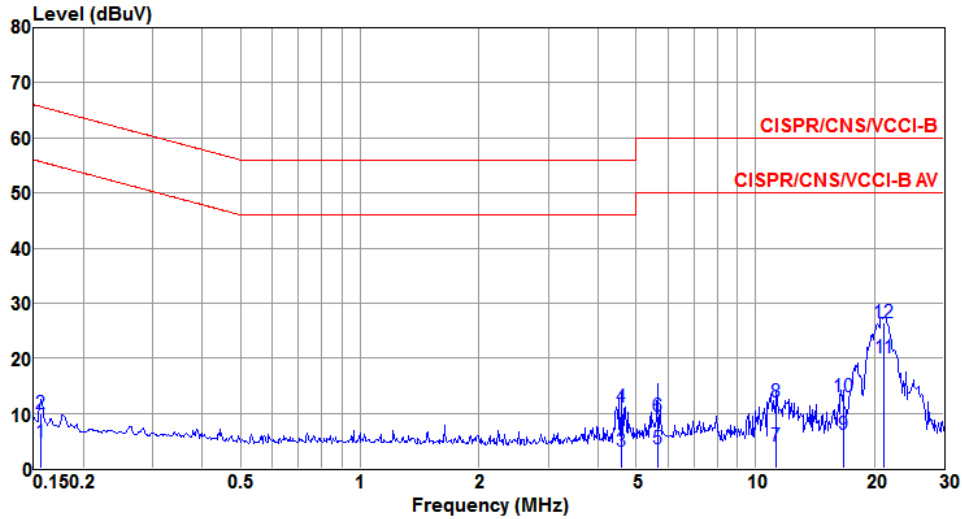

	Freq MHz	Level dBuV	Limit Line dBuV	Over Limit dB	Read Level dBuV	LISN factor dB	cable loss dB	Remark
1	0.156	4.78	55.65	-50.87	4.63	0.13	0.02	Average
2	0.156	10.01	65.65	-55.64	9.86	0.13	0.02	QP
3	4.598	2.97	46.00	-43.03	2.65	0.19	0.13	Average
4	4.598	11.16	56.00	-44.84	10.84	0.19	0.13	QP
5	5.653	3.63	50.00	-46.37	3.29	0.21	0.13	Average
6	5.653	9.42	60.00	-50.58	9.08	0.21	0.13	QP
7	11.317	4.11	50.00	-45.89	3.65	0.29	0.17	Average
8	11.317	11.96	60.00	-48.04	11.50	0.29	0.17	QP
9	16.661	6.17	50.00	-43.83	5.61	0.36	0.20	Average
10	16.661	12.98	60.00	-47.02	12.42	0.36	0.20	QP
11	21.147	20.18	50.00	-29.82	19.58	0.41	0.19	Average
12	21.147	26.32	60.00	-33.68	25.72	0.41	0.19	QP

Note 1: Level (dBuV) = Read Level (dBuV) + LISN Factor (dB) + Cable Loss (dB).
 2: Over Limit (dB) = Level (dBuV) – Limit Line (dBuV).

3.2 6dB and Occupied Bandwidth

3.2.1 Limit of 6dB Bandwidth

The minimum 6dB bandwidth shall be at least 500 kHz.

3.2.2 Test Procedures

6dB Bandwidth

1. Set resolution bandwidth (RBW) = 100 kHz, Video bandwidth = 300 kHz.
2. Detector = Peak, Trace mode = max hold.
3. Sweep = auto couple, Allow the trace to stabilize.
4. Measure the maximum width of the emission that is constrained by the frequencies associated with the two outermost amplitude points (upper and lower) that are attenuated by 6dB relative to the maximum level measured in the fundamental emission.

Occupied Bandwidth

1. Set resolution bandwidth (RBW) = 300 kHz, Video bandwidth = 1 MHz.
2. Detector = Sample, Trace mode = max hold.
3. Sweep = auto couple, Allow the trace to stabilize.
4. Use the OBW measurement function of spectrum analyzer to measure the occupied bandwidth.

3.2.3 Test Setup

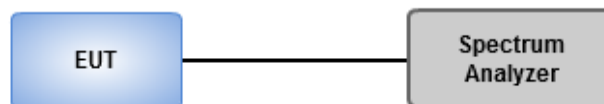

3.2.4 Test Result of 6dB and Occupied Bandwidth

Modulation Mode	N _{TX}	Freq. (MHz)	6dB Bandwidth (MHz)				Limit (kHz)
			Chain 0	Chain 1	Chain 2	Chain 3	
11b	2	2412	6.55	7.07	---	---	500
11b	2	2437	7.07	7.07	---	---	500
11b	2	2462	7.07	7.07	---	---	500
11g	2	2412	16.35	16.29	---	---	500
11g	2	2437	16.35	16.35	---	---	500
11g	2	2462	16.35	16.35	---	---	500
HT20	2	2412	17.22	16.99	---	---	500
HT20	2	2437	17.57	16.93	---	---	500
HT20	2	2462	17.33	17.22	---	---	500

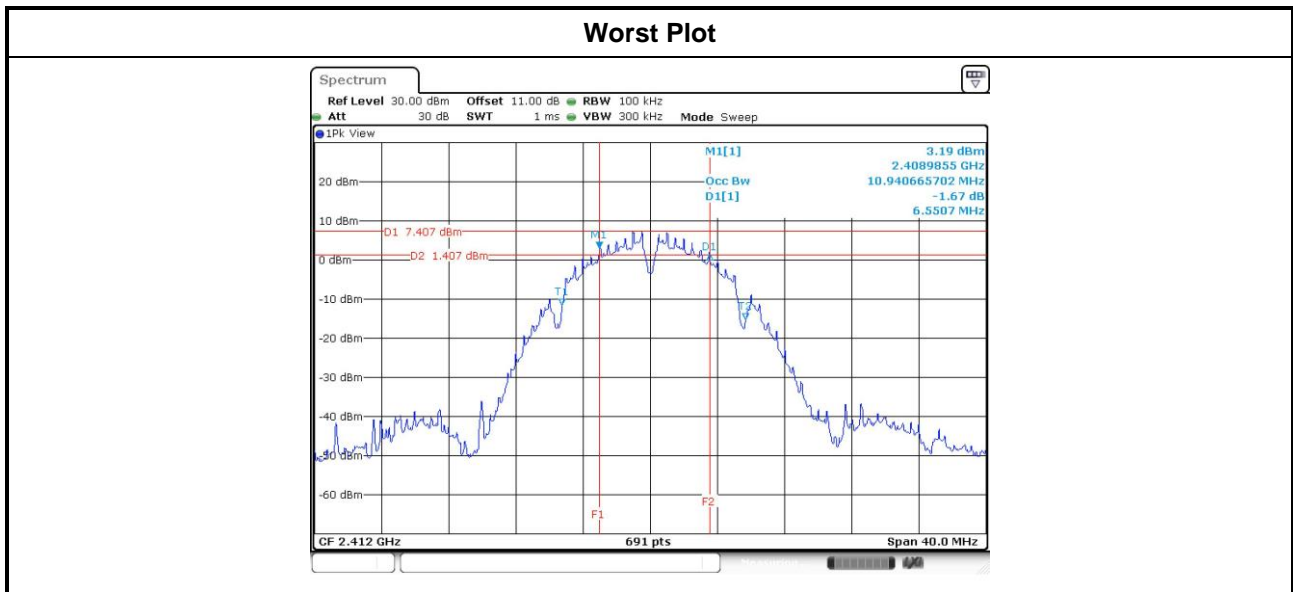

Modulation Mode	N _{TX}	Freq. (MHz)	99% Occupied Bandwidth (MHz)			
			Chain 0	Chain 1	Chain 2	Chain 3
11b	2	2412	11.48	11.15	---	---
11b	2	2437	12.05	11.83	---	---
11b	2	2462	11.98	11.79	---	---
11g	2	2412	16.64	16.56	---	---
11g	2	2437	16.94	16.85	---	---
11g	2	2462	16.64	16.56	---	---
HT20	2	2412	17.75	17.71	---	---
HT20	2	2437	17.96	17.88	---	---
HT20	2	2462	17.77	17.72	---	---

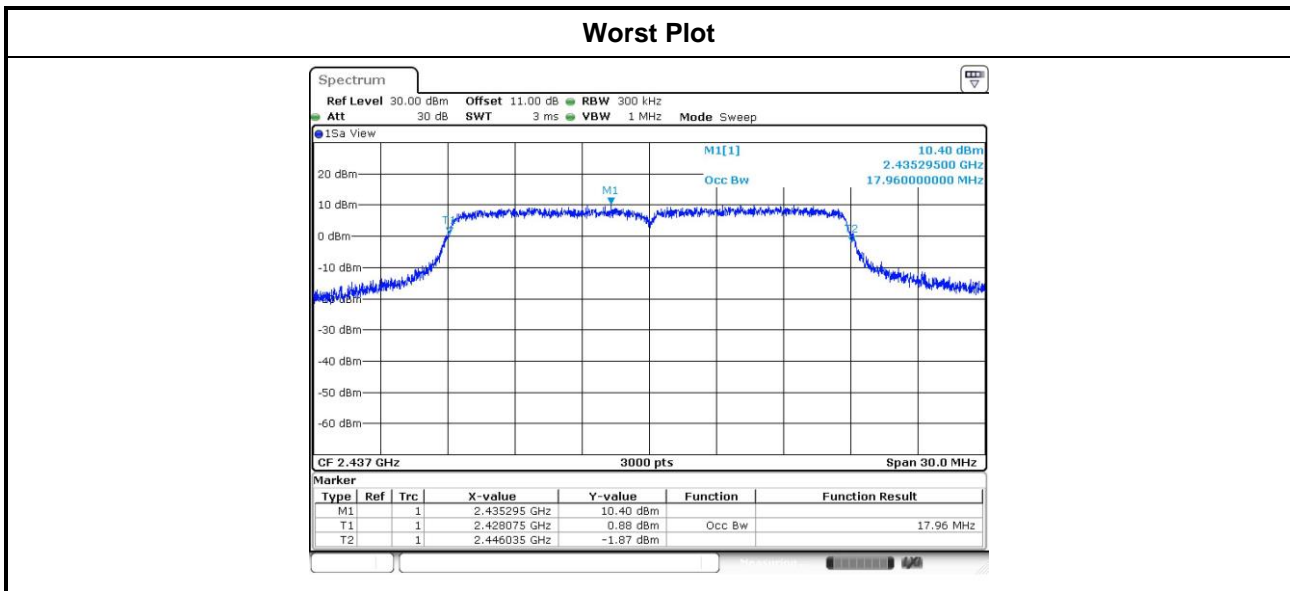

3.3 RF Output Power

3.3.1 Limit of RF Output Power

Conducted power shall not exceed 1Watt.

- Antenna gain \leq 6dBi, no any corresponding reduction is in output power limit.
- Antenna gain $>$ 6dBi
 - Non Fixed, point to point operations.
The conducted output power from the intentional radiator shall be reduced by the amount in dB that the directional gain of the antenna exceeds 6 dB
 - Fixed, point to point operations
Systems operating in the 2400–2483.5 MHz band that are used exclusively for fixed, point-to-point Operations, maximum peak output power of the intentional radiator is reduced by 1 dB for every 3 dB that the directional gain of the antenna exceeds 6 dBi.

Systems operating in the 5725–5850 MHz band that are used exclusively for fixed, point-to-point operations ,no any corresponding reduction is in transmitter peak output power

3.3.2 Test Procedures

- Maximum Peak Conducted Output Power
 - Spectrum analyzer**
 1. Set RBW = 1MHz, VBW = 3MHz, Detector = Peak.
 2. Sweep time = auto, Trace mode = max hold, Allow trace to fully stabilize.
 3. Use the spectrum analyzer channel power measurement function with the band limits set equal to the DTS bandwidth edges.
 - Power meter**
 1. A broadband Peak RF power meter is used for output power measurement. The video bandwidth of power meter is greater than DTS bandwidth of EUT. If duty cycle of test signal is not 100 %, trigger and gating function of power meter will be enabled to capture transmission burst for measuring output power.
- Maximum Conducted Output Power (For reference only)
 - Power meter**
 1. A broadband Average RF power meter is used for output power measurement. The video bandwidth of power meter is greater than DTS bandwidth of EUT. If duty cycle of test signal is not 100 %, trigger and gating function of power meter will be enabled to capture transmission burst for measuring output power.

3.3.3 Test Setup

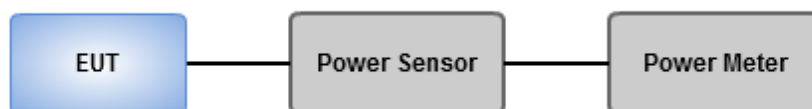

3.3.4 Test Result of Maximum Output Power

Modulation Mode	N _{TX}	Freq. (MHz)	Peak conducted Output Power (dBm)							Ant. Gain (dBi)	EIRP (dBm)	EIRP Limit (dBm)
			Chain 0	Chain 1	Chain 2	Chain 3	Total Power (mW)	Total Power (dBm)	Limit (dBm)			
11b	2	2412	19.21	19.13	---	---	165.215	22.18	30.00	2.79	24.97	36.00
11b	2	2437	21.45	21.36	---	---	276.410	24.42	30.00	2.79	27.21	36.00
11b	2	2462	21.35	21.16	---	---	267.075	24.27	30.00	2.79	27.06	36.00
11g	2	2412	22.23	22.12	---	---	330.039	25.19	30.00	2.79	27.98	36.00
11g	2	2437	23.63	24.07	---	---	485.945	26.87	30.00	2.79	29.66	36.00
11g	2	2462	22.26	21.94	---	---	324.582	25.11	30.00	2.79	27.90	36.00
HT20	2	2412	21.76	21.86	---	---	303.430	24.82	30.00	2.79	27.61	36.00
HT20	2	2437	23.62	24.13	---	---	488.965	26.89	30.00	2.79	29.68	36.00
HT20	2	2462	21.86	21.67	---	---	300.354	24.78	30.00	2.79	27.57	36.00

Modulation Mode	N _{TX}	Freq. (MHz)	Conducted (Average) Output Power (dBm)				Total Power (mW)	Total Power (dBm)	Limit (dBm)
			Chain 0	Chain 1	Chain 2	Chain 3			
11b	2	2412	16.22	16.05	---	---	82.151	19.15	---
11b	2	2437	19.00	18.80	---	---	155.291	21.91	---
11b	2	2462	18.50	18.20	---	---	136.864	21.36	---
11g	2	2412	16.61	16.59	---	---	91.418	19.61	---
11g	2	2437	19.58	19.51	---	---	180.113	22.56	---
11g	2	2462	16.51	16.26	---	---	87.038	19.40	---
HT20	2	2412	16.00	16.00	---	---	79.621	19.01	---
HT20	2	2437	19.53	19.52	---	---	179.279	22.54	---
HT20	2	2462	16.06	16.01	---	---	80.267	19.05	---

Note: Conducted average output power is for reference only.

3.4 Power Spectral Density

3.4.1 Limit of Power Spectral Density

Power spectral density shall not be greater than 8 dBm in any 3 kHz band.

3.4.2 Test Procedures

- Maximum peak conducted output power was used to demonstrate compliance to the fundamental output power limit.
 1. Set the RBW = 3kHz, VBW = 10kHz.
 2. Detector = Peak, Sweep time = auto couple.
 3. Trace mode = max hold, allow trace to fully stabilize.
 4. Use the peak marker function to determine the maximum amplitude level.
- Maximum (average) conducted output power was used to demonstrate compliance to the fundamental output power limit.
 1. Set the RBW = 100kHz, VBW = 300 kHz.
 2. Detector = RMS, Sweep time = auto couple.
 3. Set the sweep time to: $\geq 10 \times (\text{number of measurement points in sweep}) \times (\text{maximum data rate per stream})$.
 4. Perform the measurement over a single sweep.
 5. Use the peak marker function to determine the maximum amplitude level.

3.4.3 Test Setup

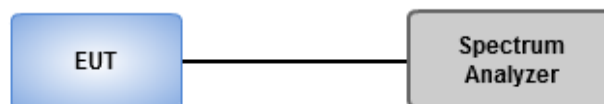

3.4.4 Test Result of Power Spectral Density

Modulation Mode	N _{TX}	Freq. (MHz)	Total Power Spectral Density (dBm/3kHz)	Limit (dBm/3kHz)
11b	2	2412	-4.39	8.00
11b	2	2437	-1.59	8.00
11b	2	2462	-1.91	8.00
11g	2	2412	-7.19	8.00
11g	2	2437	-3.79	8.00
11g	2	2462	-7.25	8.00
HT20	2	2412	-8.52	8.00
HT20	2	2437	-2.79	8.00
HT20	2	2462	-8.12	8.00

Note: Test result is bin-by-bin summing measured value of each TX port.

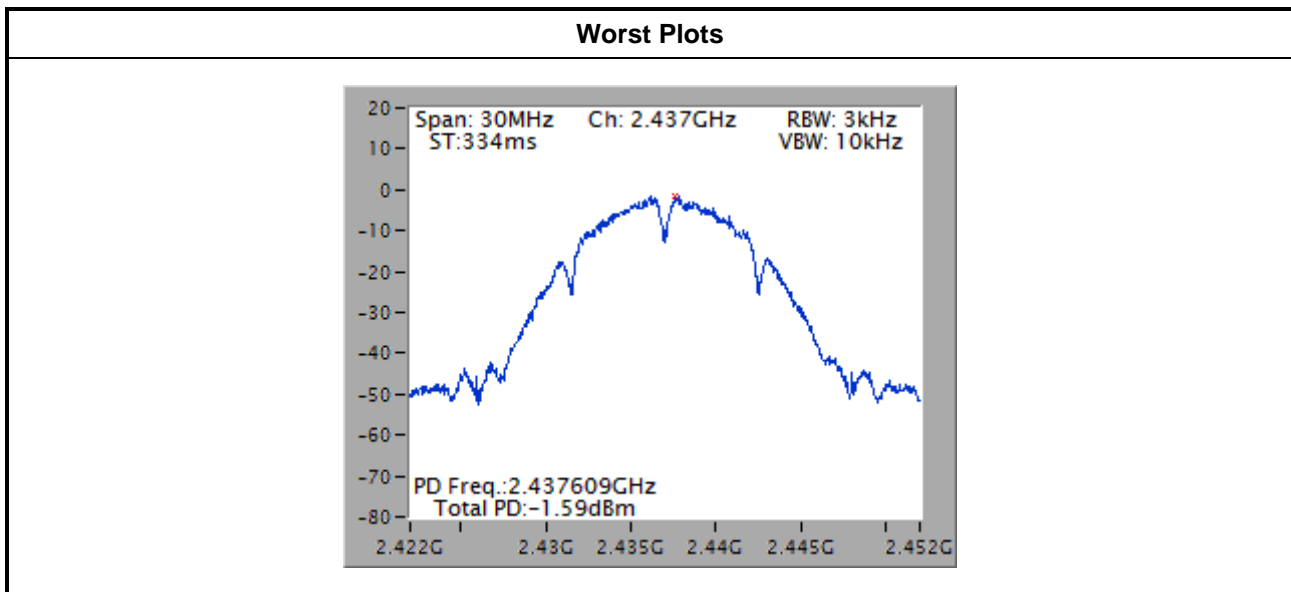

3.5 Unwanted Emissions into Restricted Frequency Bands

3.5.1 Limit of Unwanted Emissions into Restricted Frequency Bands

Restricted Band Emissions Limit			
Frequency Range (MHz)	Field Strength (uV/m)	Field Strength (dBuV/m)	Measure Distance (m)
0.009~0.490	2400/F(kHz)	48.5 - 13.8	300
0.490~1.705	24000/F(kHz)	33.8 - 23	30
1.705~30.0	30	29	30
30~88	100	40	3
88~216	150	43.5	3
216~960	200	46	3
Above 960	500	54	3

Note 1:
Quasi-Peak value is measured for frequency below 1GHz except for 9–90 kHz, 110–490 kHz frequency band. Peak and average value are measured for frequency above 1GHz. The limit on average radio frequency emission is as above table. The limit on peak radio frequency emissions is 20 dB above the maximum permitted average emission limit

Note 2:
Measurements may be performed at a distance other than what is specified provided. When performing measurements at a distance other than that specified, the results shall be extrapolated to the specified distance using an extrapolation factor as below, Frequency at or above 30 MHz: 20 dB/decade Frequency below 30 MHz: 40 dB/decade.

3.5.2 Test Procedures

1. Measurement is made at a semi-anechoic chamber that incorporates a turntable allowing a EUT rotation of 360°. A continuously-rotating, remotely-controlled turntable is installed at the test site to support the EUT and facilitate determination of the direction of maximum radiation for each EUT emission frequency. The EUT is placed at test table. For emissions testing at or below 1 GHz, the table height is 80 cm above the reference ground plane. For emission measurements above 1 GHz, the table height is 1.5 m
2. Measurement is made with the antenna positioned in both the horizontal and vertical planes of polarization. The measurement antenna is varied in height (1m ~ 4m) above the reference ground plane to obtain the maximum signal strength. Distance between EUT and antenna is 3 m.
3. This investigation is performed with the EUT rotated 360°, the antenna height scanned between 1 m and 4 m, and the antenna rotated to repeat the measurements for both the horizontal and vertical antenna polarizations.

Note:

1. 120kHz measurement bandwidth of test receiver and Quasi-peak detector is for radiated emission below 1GHz.
2. RBW=1MHz, VBW=3MHz and Peak detector is for peak measured value of radiated emission above 1GHz.
3. RBW=1MHz, VBW=1/T and Peak detector is for average measured value of radiated emission above 1GHz.

3.5.3 Test Setup

Radiated Emissions below 1 GHz

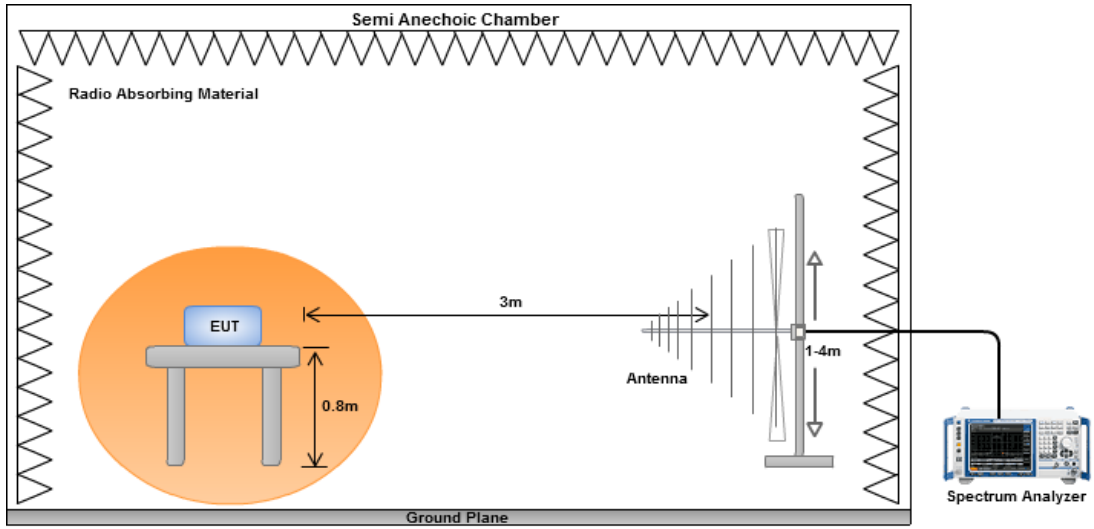

Radiated Emissions above 1 GHz

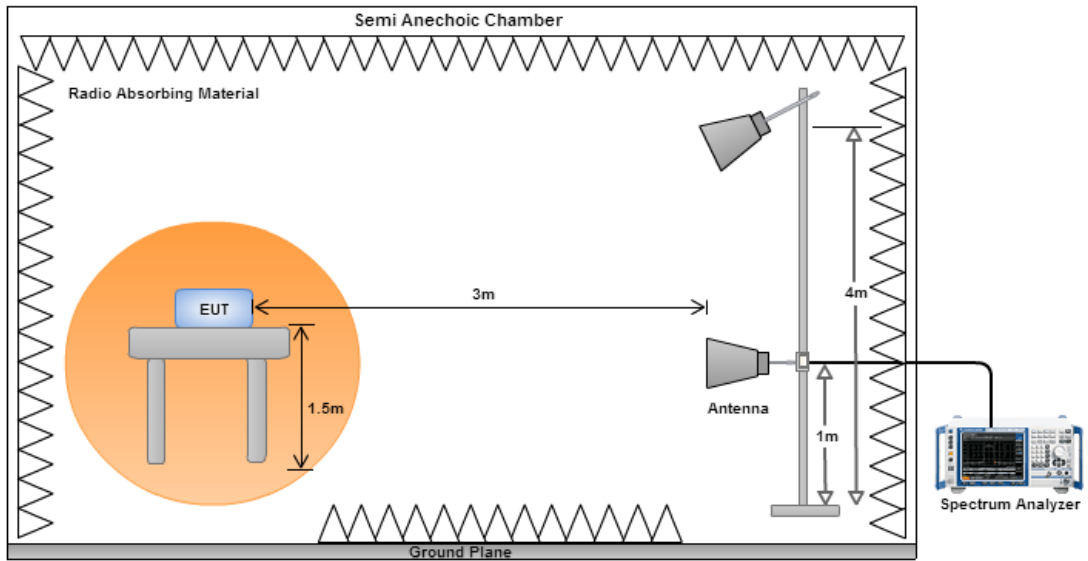

Test Configuration 1: Dipole antenna

3.5.4 Transmitter Radiated Unwanted Emissions (Below 1GHz)

Modulation	HT20	Test Freq. (MHz)	2437
Polarization	Horizontal	Test Configuration	1

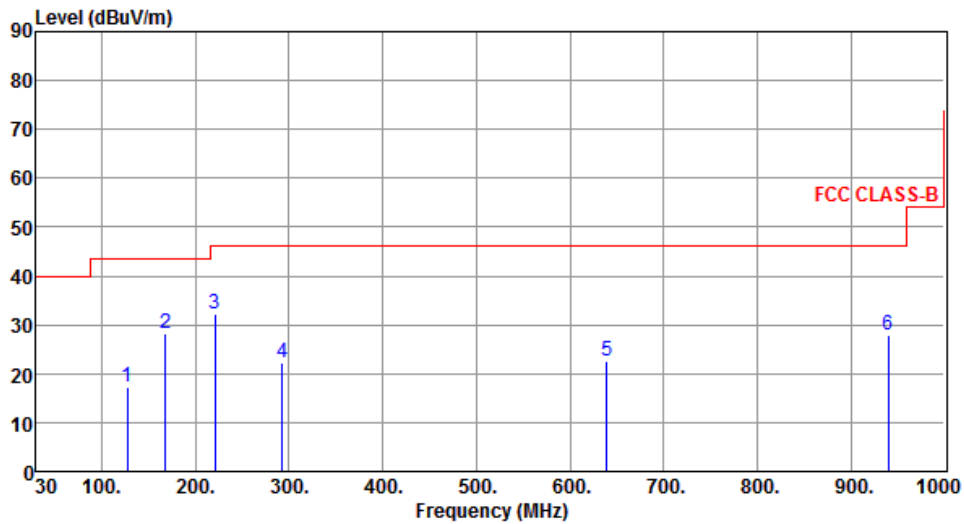

	Freq. MHz	Emission level dBuV/m	Limit dBuV/m	Margin dB	SA reading dBuV	Factor dB	Remark	ANT High cm	Turn Table deg
1	127.00	17.11	43.50	-26.39	32.03	-14.92	Peak	---	---
2	167.74	28.24	43.50	-15.26	42.23	-13.99	Peak	---	---
3	221.09	32.06	46.00	-13.94	47.95	-15.89	Peak	---	---
4	292.87	22.22	46.00	-23.78	35.22	-13.00	Peak	---	---
5	639.16	22.51	46.00	-23.49	27.74	-5.23	Peak	---	---
6	939.86	27.88	46.00	-18.12	27.89	-0.01	Peak	---	---

Note 1: Emission Level (dBuV/m) = SA Reading (dBuV/m) + Factor* (dB)

*Factor includes antenna factor , cable loss and amplifier gain

Note 2: Margin (dB) = Emission level (dBuV/m) – Limit (dBuV/m).

Note 3: All spurious emissions below 30MHz are more than 20 dB below the limit.

Modulation	HT20	Test Freq. (MHz)	2437
Polarization	Vertical	Test Configuration	1

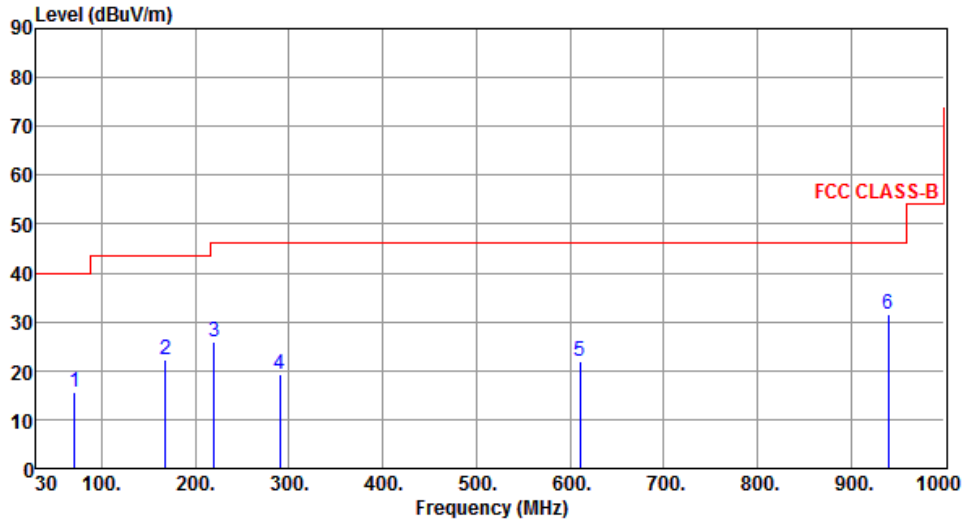

	Freq. MHz	Emission level dBuV/m	Limit dBuV/m	Margin dB	SA reading dBuV	Factor dB	Remark	ANT High cm	Turn Table deg
1	70.74	15.64	40.00	-24.36	31.56	-15.92	Peak	---	---
2	167.74	22.37	43.50	-21.13	36.36	-13.99	Peak	---	---
3	220.12	25.89	46.00	-20.11	41.85	-15.96	Peak	---	---
4	289.96	19.25	46.00	-26.75	32.37	-13.12	Peak	---	---
5	611.03	21.87	46.00	-24.13	27.50	-5.63	Peak	---	---
6	939.86	31.49	46.00	-14.51	31.50	-0.01	Peak	---	---

Note 1: Emission Level (dBuV/m) = SA Reading (dBuV/m) + Factor* (dB)

*Factor includes antenna factor , cable loss and amplifier gain

Note 2: Margin (dB) = Emission level (dBuV/m) – Limit (dBuV/m).

Note 3: All spurious emissions below 30MHz are more than 20 dB below the limit.

3.5.5 Transmitter Radiated Unwanted Emissions (Above 1GHz) for 11b

Modulation	11b	Test Freq. (MHz)	2412
Polarization	Horizontal	Test Configuration	1

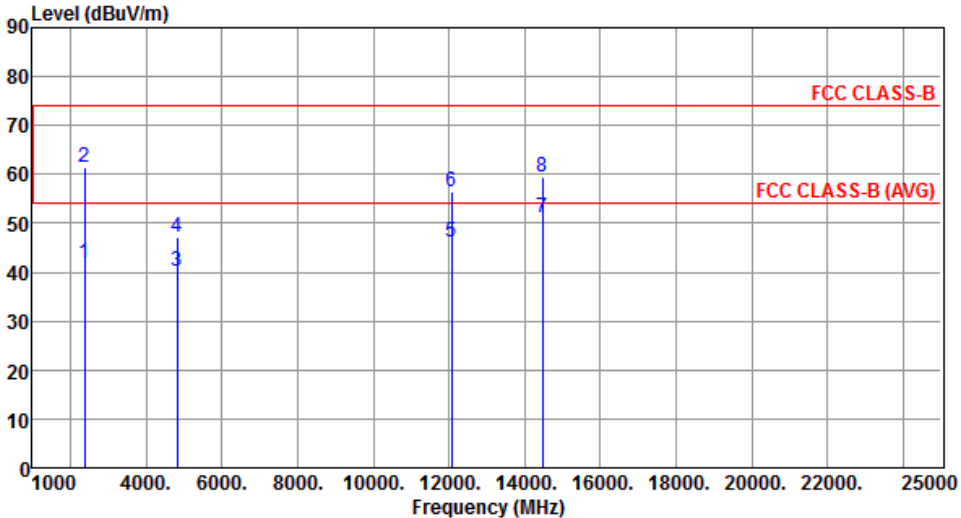

	Freq. MHz	Emission level dBuV/m	Limit dBuV/m	Margin dB	SA reading dBuV	Factor dB	Remark	ANT High cm	Turn Table deg
1	2390.00	41.79	54.00	-12.21	43.15	-1.36	Average	150	144
2	2390.00	61.59	74.00	-12.41	62.95	-1.36	Peak	150	144
3	4824.00	40.16	54.00	-13.84	34.22	5.94	Average	282	177
4	4824.00	47.05	74.00	-26.95	41.11	5.94	Peak	282	177
5	12060.00	46.23	54.00	-7.77	30.26	15.97	Average	167	203
6	12060.00	56.32	74.00	-17.68	40.35	15.97	Peak	167	203
7	14472.00	51.03	54.00	-2.97	31.62	19.41	Average	365	240
8	14472.00	59.52	74.00	-14.48	40.11	19.41	Peak	365	240

Note 1: Emission Level (dBuV/m) = SA Reading (dBuV/m) + Factor* (dB)
*Factor includes antenna factor , cable loss and amplifier gain
Note 2: Margin (dB) = Emission level (dBuV/m) – Limit (dBuV/m).

Modulation	11b	Test Freq. (MHz)	2412
Polarization	Vertical	Test Configuration	1

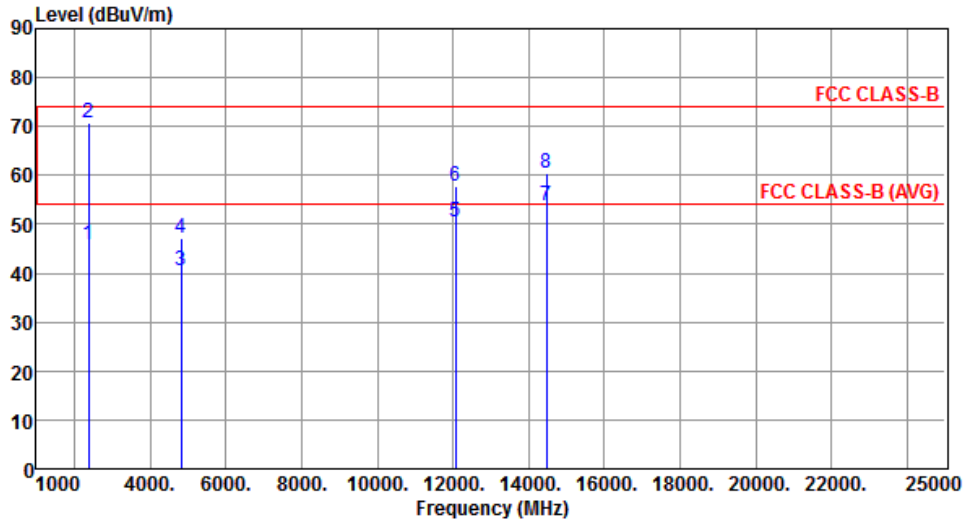

	Freq. MHz	Emission level dBuV/m	Limit dBuV/m	Margin dB	SA reading dBuV	Factor dB	Remark	ANT High cm	Turn Table deg
1	2390.00	45.69	54.00	-8.31	47.05	-1.36	Average	150	162
2	2390.00	70.86	74.00	-3.14	72.22	-1.36	Peak	150	162
3	4824.00	40.53	54.00	-13.47	34.59	5.94	Average	150	207
4	4824.00	47.20	74.00	-26.80	41.26	5.94	Peak	150	207
5	12060.00	50.48	54.00	-3.52	34.51	15.97	Average	177	17
6	12060.00	57.86	74.00	-16.14	41.89	15.97	Peak	177	17
7	14472.00	53.86	54.00	-0.14	34.45	19.41	Average	206	155
8	14472.00	60.57	74.00	-13.43	41.16	19.41	Peak	206	155

Note 1: Emission Level (dBuV/m) = SA Reading (dBuV/m) + Factor* (dB)

*Factor includes antenna factor , cable loss and amplifier gain

Note 2: Margin (dB) = Emission level (dBuV/m) – Limit (dBuV/m).

Modulation	11b	Test Freq. (MHz)	2437
Polarization	Horizontal	Test Configuration	1

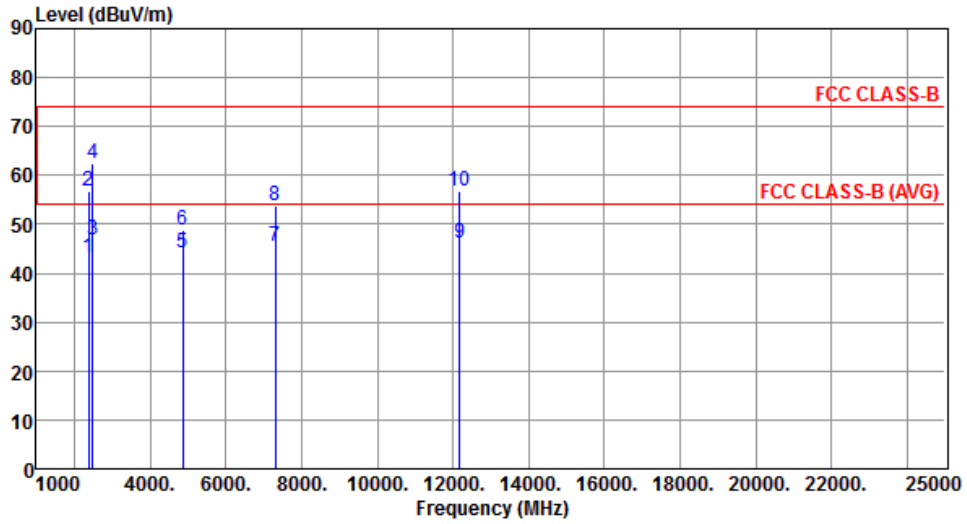

	Freq. MHz	Emission level dBuV/m	Limit dBuV/m	Margin dB	SA reading dBuV	Factor dB	Remark	ANT High cm	Turn Table deg
1	2390.00	43.30	54.00	-10.70	44.66	-1.36	Average	150	145
2	2390.00	56.69	74.00	-17.31	58.05	-1.36	Peak	150	145
3	2483.50	46.81	54.00	-7.19	47.83	-1.02	Average	150	145
4	2483.50	62.56	74.00	-11.44	63.58	-1.02	Peak	150	145
5	4874.00	44.08	54.00	-9.92	38.11	5.97	Average	187	170
6	4874.00	48.66	74.00	-25.34	42.69	5.97	Peak	187	170
7	7311.00	45.45	54.00	-8.55	34.70	10.75	Average	205	203
8	7311.00	53.74	74.00	-20.26	42.99	10.75	Peak	205	203
9	12185.00	46.19	54.00	-7.81	30.35	15.84	Average	200	194
10	12185.00	56.74	74.00	-17.26	40.90	15.84	Peak	200	194

Note 1: Emission Level (dBuV/m) = SA Reading (dBuV/m) + Factor* (dB)

*Factor includes antenna factor , cable loss and amplifier gain

Note 2: Margin (dB) = Emission level (dBuV/m) – Limit (dBuV/m).

Modulation	11b	Test Freq. (MHz)	2437
Polarization	Vertical	Test Configuration	1

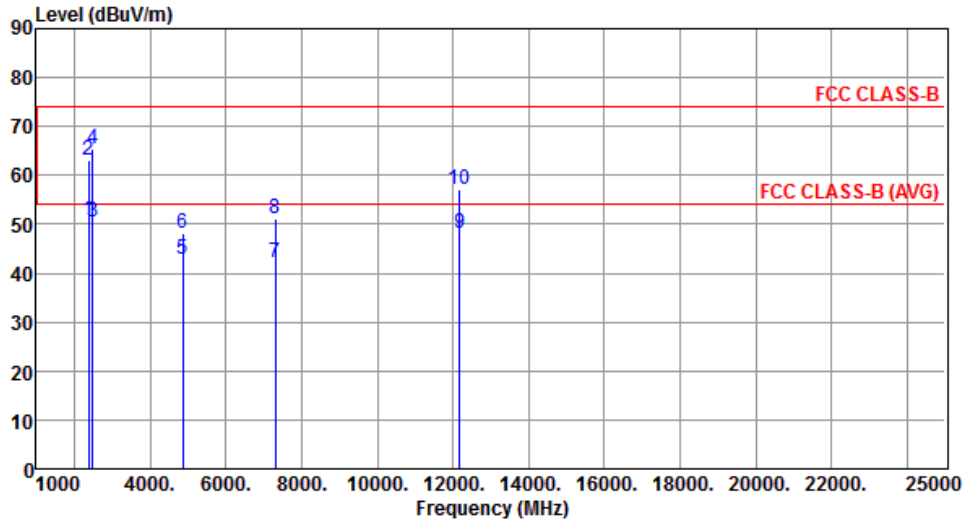

	Freq. MHz	Emission level dBuV/m	Limit dBuV/m	Margin dB	SA reading dBuV	Factor dB	Remark	ANT High cm	Turn Table deg
1	2390.00	50.78	54.00	-3.22	52.14	-1.36	Average	150	162
2	2390.00	63.13	74.00	-10.87	64.49	-1.36	Peak	150	162
3	2483.50	50.51	54.00	-3.49	51.53	-1.02	Average	152	165
4	2483.50	65.27	74.00	-8.73	66.29	-1.02	Peak	152	165
5	4874.00	42.83	54.00	-11.17	36.86	5.97	Average	243	156
6	4874.00	48.15	74.00	-25.85	42.18	5.97	Peak	243	156
7	7311.00	42.29	54.00	-11.71	31.54	10.75	Average	345	162
8	7311.00	51.24	74.00	-22.76	40.49	10.75	Peak	345	162
9	12185.00	48.08	54.00	-5.92	32.24	15.84	Average	243	150
10	12185.00	57.27	74.00	-16.73	41.43	15.84	Peak	243	150

Note 1: Emission Level (dBuV/m) = SA Reading (dBuV/m) + Factor* (dB)

*Factor includes antenna factor , cable loss and amplifier gain

Note 2: Margin (dB) = Emission level (dBuV/m) – Limit (dBuV/m).

Modulation	11b	Test Freq. (MHz)	2462
Polarization	Horizontal	Test Configuration	1

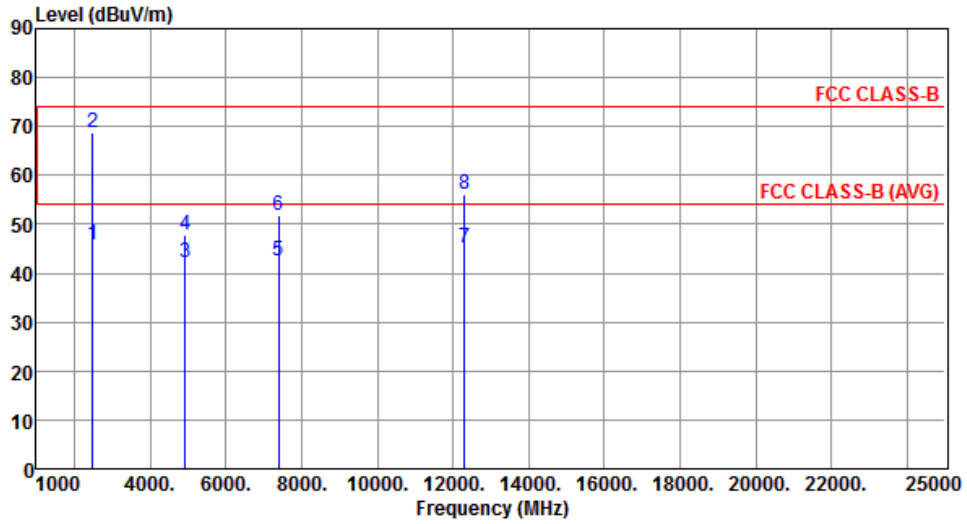

	Freq. MHz	Emission level dBuV/m	Limit dBuV/m	Margin dB	SA reading dBuV	Factor dB	Remark	ANT High cm	Turn Table deg
1	2483.50	45.75	54.00	-8.25	46.77	-1.02	Average	180	178
2	2483.50	68.82	74.00	-5.18	69.84	-1.02	Peak	180	178
3	4924.00	42.27	54.00	-11.73	36.26	6.01	Average	171	187
4	4924.00	47.96	74.00	-26.04	41.95	6.01	Peak	171	187
5	7386.00	42.40	54.00	-11.60	31.50	10.90	Average	230	151
6	7386.00	51.79	74.00	-22.21	40.89	10.90	Peak	230	151
7	12310.00	45.20	54.00	-8.80	29.50	15.70	Average	204	192
8	12310.00	56.20	74.00	-17.80	40.50	15.70	Peak	204	192

Note 1: Emission Level (dBuV/m) = SA Reading (dBuV/m) + Factor* (dB)

*Factor includes antenna factor , cable loss and amplifier gain

Note 2: Margin (dB) = Emission level (dBuV/m) – Limit (dBuV/m).

Modulation	11b	Test Freq. (MHz)	2462
Polarization	Vertical	Test Configuration	1

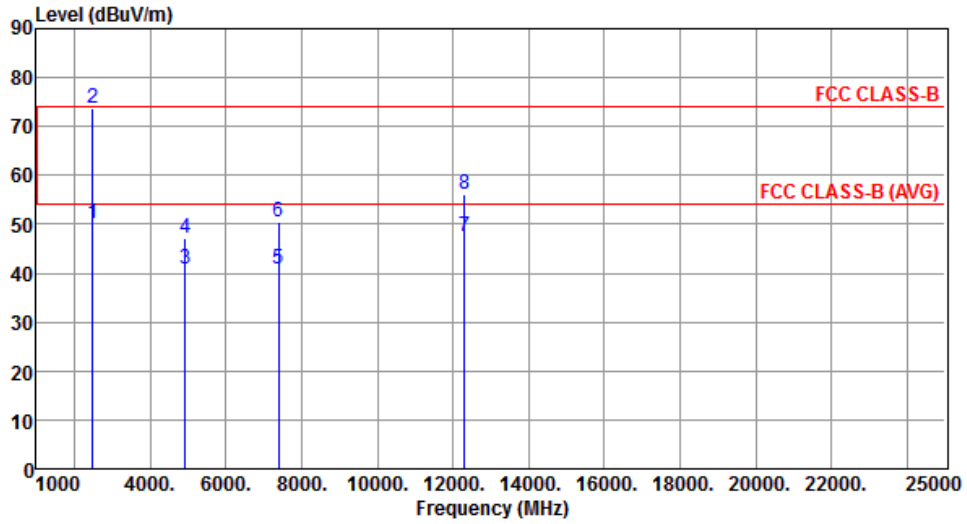

	Freq. MHz	Emission level dBuV/m	Limit dBuV/m	Margin dB	SA reading dBuV	Factor dB	Remark	ANT High cm	Turn Table deg
1	2483.50	50.02	54.00	-3.98	51.04	-1.02	Average	157	144
2	2483.50	73.87	74.00	-0.13	74.89	-1.02	Peak	157	144
3	4924.00	40.86	54.00	-13.14	34.85	6.01	Average	255	156
4	4924.00	47.16	74.00	-26.84	41.15	6.01	Peak	255	156
5	7386.00	41.00	54.00	-13.00	30.10	10.90	Average	327	181
6	7386.00	50.49	74.00	-23.51	39.59	10.90	Peak	327	181
7	12310.00	47.54	54.00	-6.46	31.84	15.70	Average	260	204
8	12310.00	56.10	74.00	-17.90	40.40	15.70	Peak	260	204

Note 1: Emission Level (dBuV/m) = SA Reading (dBuV/m) + Factor* (dB)

*Factor includes antenna factor , cable loss and amplifier gain

Note 2: Margin (dB) = Emission level (dBuV/m) – Limit (dBuV/m).

3.5.6 Transmitter Radiated Unwanted Emissions (Above 1GHz) for 11g

Modulation	11g	Test Freq. (MHz)	2412
Polarization	Horizontal	Test Configuration	1

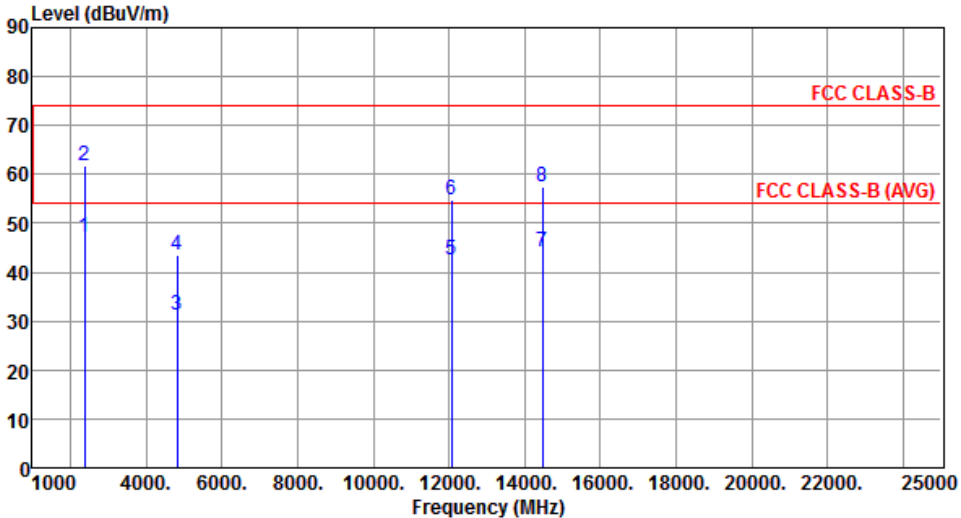

	Freq. MHz	Emission level dBuV/m	Limit dBuV/m	Margin dB	SA reading dBuV	Factor dB	Remark	ANT High cm	Turn Table deg
1	2390.00	47.08	54.00	-6.92	48.44	-1.36	Average	150	174
2	2390.00	61.73	74.00	-12.27	63.09	-1.36	Peak	150	174
3	4824.00	31.29	54.00	-22.71	25.35	5.94	Average	280	185
4	4824.00	43.59	74.00	-30.41	37.65	5.94	Peak	280	185
5	12060.00	42.67	54.00	-11.33	26.70	15.97	Average	160	214
6	12060.00	54.77	74.00	-19.23	38.80	15.97	Peak	160	214
7	14472.00	44.19	54.00	-9.81	24.78	19.41	Average	360	233
8	14472.00	57.47	74.00	-16.53	38.06	19.41	Peak	360	233

Note 1: Emission Level (dBuV/m) = SA Reading (dBuV/m) + Factor* (dB)
*Factor includes antenna factor , cable loss and amplifier gain
Note 2: Margin (dB) = Emission level (dBuV/m) – Limit (dBuV/m).

Modulation	11g	Test Freq. (MHz)	2412
Polarization	Vertical	Test Configuration	1

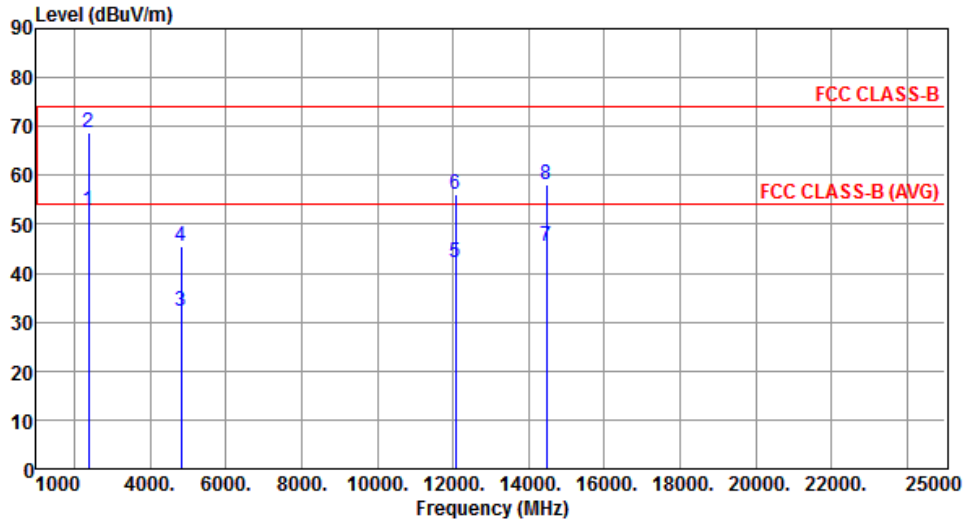

	Freq. MHz	Emission level dBuV/m	Limit dBuV/m	Margin dB	SA reading dBuV	Factor dB	Remark	ANT High cm	Turn Table deg
1	2390.00	52.73	54.00	-1.27	54.09	-1.36	Average	150	177
2	2390.00	68.73	74.00	-5.27	70.09	-1.36	Peak	150	177
3	4824.00	32.32	54.00	-21.68	26.38	5.94	Average	150	194
4	4824.00	45.53	74.00	-28.47	39.59	5.94	Peak	150	194
5	12060.00	42.08	54.00	-11.92	26.11	15.97	Average	200	147
6	12060.00	56.26	74.00	-17.74	40.29	15.97	Peak	200	147
7	14472.00	45.60	54.00	-8.40	26.19	19.41	Average	260	179
8	14472.00	58.00	74.00	-16.00	38.59	19.41	Peak	260	179

Note 1: Emission Level (dBuV/m) = SA Reading (dBuV/m) + Factor* (dB)

*Factor includes antenna factor , cable loss and amplifier gain

Note 2: Margin (dB) = Emission level (dBuV/m) – Limit (dBuV/m).

Modulation	11g	Test Freq. (MHz)	2437
Polarization	Horizontal	Test Configuration	1

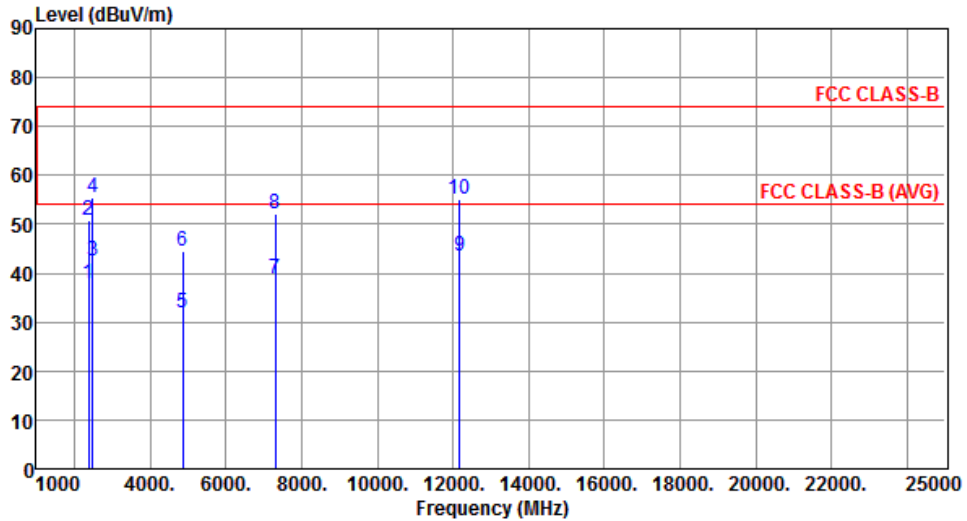

	Freq. MHz	Emission level dBuV/m	Limit dBuV/m	Margin dB	SA reading dBuV	Factor dB	Remark	ANT High cm	Turn Table deg
1	2390.00	37.77	54.00	-16.23	39.13	-1.36	Average	204	182
2	2390.00	50.68	74.00	-23.32	52.04	-1.36	Peak	204	182
3	2483.50	42.47	54.00	-11.53	43.49	-1.02	Average	204	182
4	2483.50	55.44	74.00	-18.56	56.46	-1.02	Peak	204	182
5	4874.00	31.87	54.00	-22.13	25.90	5.97	Average	189	160
6	4874.00	44.62	74.00	-29.38	38.65	5.97	Peak	189	160
7	7311.00	39.01	54.00	-14.99	28.26	10.75	Average	210	217
8	7311.00	52.01	74.00	-21.99	41.26	10.75	Peak	210	217
9	12185.00	43.53	54.00	-10.47	27.69	15.84	Average	198	170
10	12185.00	55.29	74.00	-18.71	39.45	15.84	Peak	198	170

Note 1: Emission Level (dBuV/m) = SA Reading (dBuV/m) + Factor* (dB)

*Factor includes antenna factor , cable loss and amplifier gain

Note 2: Margin (dB) = Emission level (dBuV/m) – Limit (dBuV/m).

Modulation	11g	Test Freq. (MHz)	2437
Polarization	Vertical	Test Configuration	1

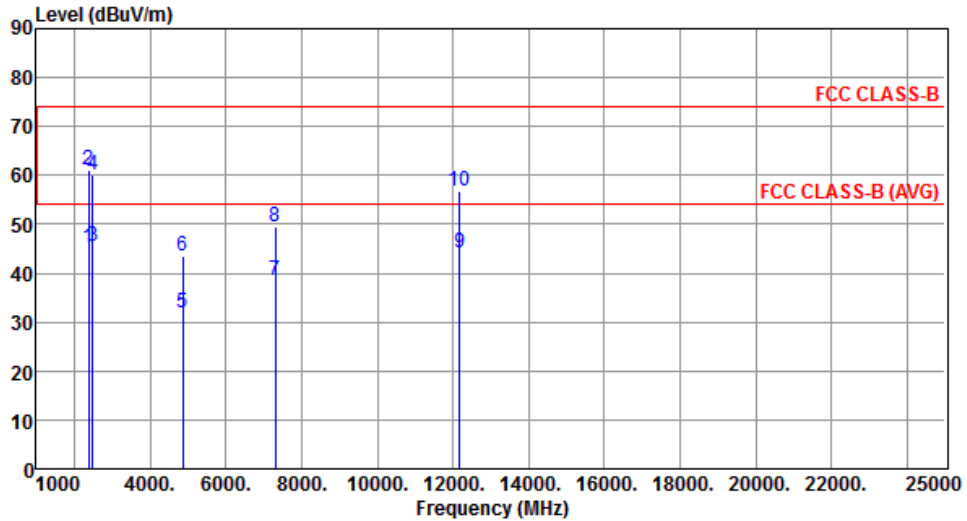

	Freq. MHz	Emission level dBuV/m	Limit dBuV/m	Margin dB	SA reading dBuV	Factor dB	Remark	ANT High cm	Turn Table deg
1	2390.00	45.28	54.00	-8.72	46.64	-1.36	Average	150	165
2	2390.00	61.03	74.00	-12.97	62.39	-1.36	Peak	150	165
3	2483.50	45.64	54.00	-8.36	46.66	-1.02	Average	150	165
4	2483.50	60.26	74.00	-13.74	61.28	-1.02	Peak	150	165
5	4874.00	31.77	54.00	-22.23	25.80	5.97	Average	243	145
6	4874.00	43.47	74.00	-30.53	37.50	5.97	Peak	243	145
7	7311.00	38.45	54.00	-15.55	27.70	10.75	Average	345	165
8	7311.00	49.34	74.00	-24.66	38.59	10.75	Peak	345	165
9	12185.00	44.13	54.00	-9.87	28.29	15.84	Average	240	144
10	12185.00	56.73	74.00	-17.27	40.89	15.84	Peak	240	144

Note 1: Emission Level (dBuV/m) = SA Reading (dBuV/m) + Factor* (dB)

*Factor includes antenna factor , cable loss and amplifier gain

Note 2: Margin (dB) = Emission level (dBuV/m) – Limit (dBuV/m).

Modulation	11g	Test Freq. (MHz)	2462
Polarization	Horizontal	Test Configuration	1

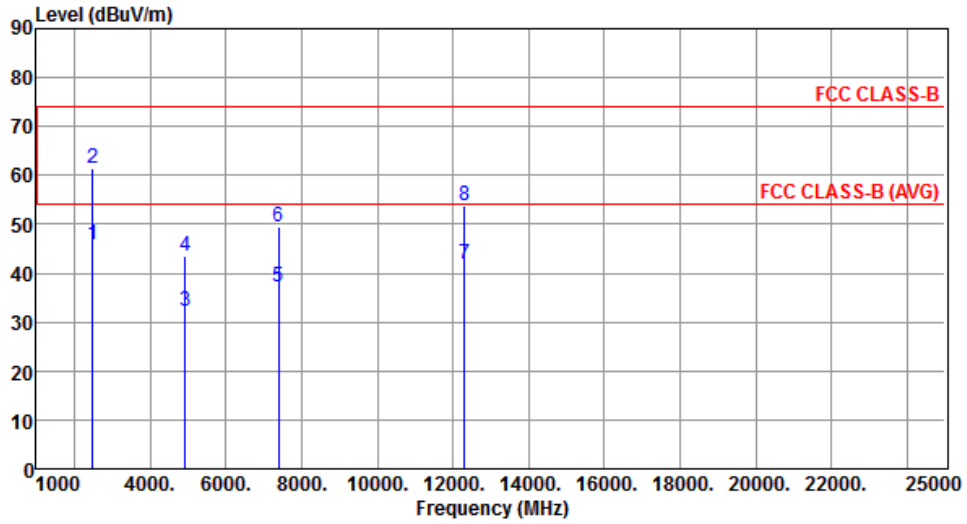

	Freq. MHz	Emission level dBuV/m	Limit dBuV/m	Margin dB	SA reading dBuV	Factor dB	Remark	ANT High cm	Turn Table deg
1	2483.50	45.66	54.00	-8.34	46.68	-1.02	Average	150	144
2	2483.50	61.33	74.00	-12.67	62.35	-1.02	Peak	150	144
3	4924.00	32.27	54.00	-21.73	26.26	6.01	Average	185	155
4	4924.00	43.49	74.00	-30.51	37.48	6.01	Peak	185	155
5	7386.00	37.23	54.00	-16.77	26.33	10.90	Average	219	222
6	7386.00	49.40	74.00	-24.60	38.50	10.90	Peak	219	222
7	12310.00	41.69	54.00	-12.31	25.99	15.70	Average	200	184
8	12310.00	53.87	74.00	-20.13	38.17	15.70	Peak	200	184

Note 1: Emission Level (dBuV/m) = SA Reading (dBuV/m) + Factor* (dB)

*Factor includes antenna factor , cable loss and amplifier gain

Note 2: Margin (dB) = Emission level (dBuV/m) – Limit (dBuV/m).

Modulation	11g	Test Freq. (MHz)	2462
Polarization	Vertical	Test Configuration	1

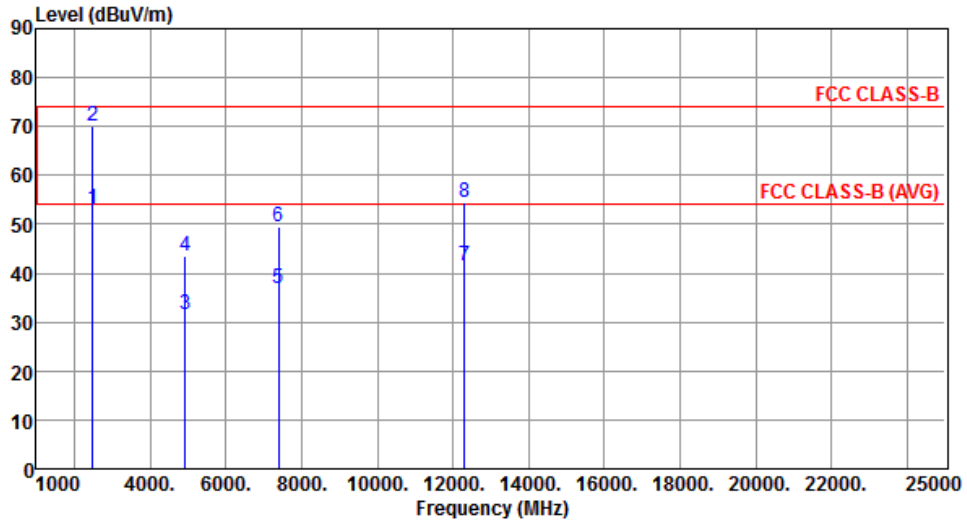

	Freq. MHz	Emission level dBuV/m	Limit dBuV/m	Margin dB	SA reading dBuV	Factor dB	Remark	ANT High cm	Turn Table deg
1	2483.50	53.23	54.00	-0.77	54.25	-1.02	Average	156	143
2	2483.50	70.22	74.00	-3.78	71.24	-1.02	Peak	156	143
3	4924.00	31.70	54.00	-22.30	25.69	6.01	Average	239	132
4	4924.00	43.42	74.00	-30.58	37.41	6.01	Peak	239	132
5	7386.00	36.80	54.00	-17.20	25.90	10.90	Average	355	162
6	7386.00	49.40	74.00	-24.60	38.50	10.90	Peak	355	162
7	12310.00	41.59	54.00	-12.41	25.89	15.70	Average	240	179
8	12310.00	54.36	74.00	-19.64	38.66	15.70	Peak	240	179

Note 1: Emission Level (dBuV/m) = SA Reading (dBuV/m) + Factor* (dB)

*Factor includes antenna factor , cable loss and amplifier gain

Note 2: Margin (dB) = Emission level (dBuV/m) – Limit (dBuV/m).

3.5.7 Transmitter Radiated Unwanted Emissions (Above 1GHz) for HT20

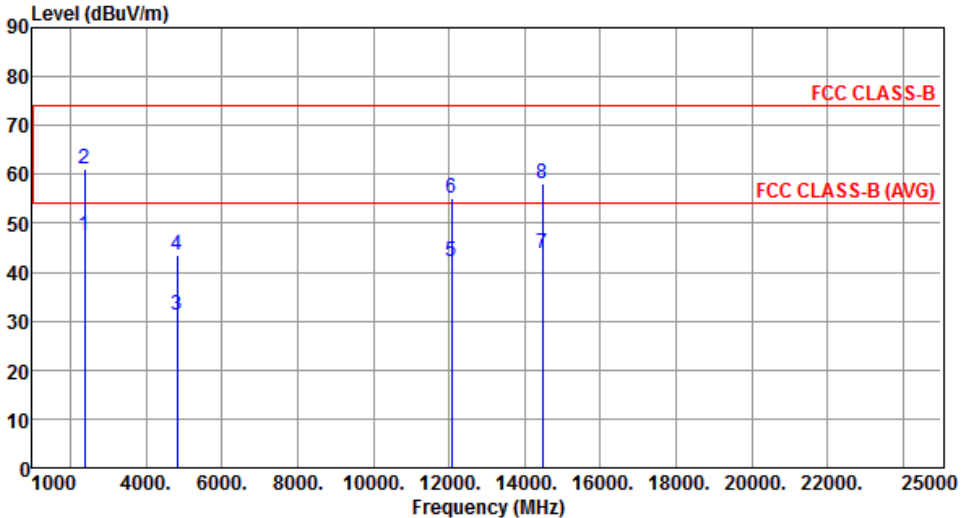
Modulation	HT20	Test Freq. (MHz)	2412																																																																																																				
Polarization	Horizontal	Test Configuration	1																																																																																																				
																																																																																																							
	<table border="1"> <thead> <tr> <th>Freq.</th> <th>Emission level</th> <th>Limit</th> <th>Margin</th> <th>SA reading</th> <th>Factor</th> <th>Remark</th> <th>ANT High</th> <th>Turn Table</th> </tr> <tr> <th>MHz</th> <th>dBuV/m</th> <th>dBuV/m</th> <th>dB</th> <th>dBuV</th> <th>dB</th> <th></th> <th>cm</th> <th>deg</th> </tr> </thead> <tbody> <tr> <td>1</td> <td>2390.00</td> <td>47.60</td> <td>54.00</td> <td>-6.40</td> <td>48.96</td> <td>-1.36</td> <td>Average</td> <td>150</td> <td>174</td> </tr> <tr> <td>2</td> <td>2390.00</td> <td>61.24</td> <td>74.00</td> <td>-12.76</td> <td>62.60</td> <td>-1.36</td> <td>Peak</td> <td>150</td> <td>174</td> </tr> <tr> <td>3</td> <td>4824.00</td> <td>31.31</td> <td>54.00</td> <td>-22.69</td> <td>25.37</td> <td>5.94</td> <td>Average</td> <td>277</td> <td>169</td> </tr> <tr> <td>4</td> <td>4824.00</td> <td>43.35</td> <td>74.00</td> <td>-30.65</td> <td>37.41</td> <td>5.94</td> <td>Peak</td> <td>277</td> <td>169</td> </tr> <tr> <td>5</td> <td>12060.00</td> <td>42.27</td> <td>54.00</td> <td>-11.73</td> <td>26.30</td> <td>15.97</td> <td>Average</td> <td>162</td> <td>147</td> </tr> <tr> <td>6</td> <td>12060.00</td> <td>55.07</td> <td>74.00</td> <td>-18.93</td> <td>39.10</td> <td>15.97</td> <td>Peak</td> <td>162</td> <td>147</td> </tr> <tr> <td>7</td> <td>14472.00</td> <td>43.85</td> <td>54.00</td> <td>-10.15</td> <td>24.44</td> <td>19.41</td> <td>Average</td> <td>361</td> <td>240</td> </tr> <tr> <td>8</td> <td>14472.00</td> <td>58.21</td> <td>74.00</td> <td>-15.79</td> <td>38.80</td> <td>19.41</td> <td>Peak</td> <td>361</td> <td>240</td> </tr> </tbody> </table>	Freq.	Emission level	Limit	Margin	SA reading	Factor	Remark	ANT High	Turn Table	MHz	dBuV/m	dBuV/m	dB	dBuV	dB		cm	deg	1	2390.00	47.60	54.00	-6.40	48.96	-1.36	Average	150	174	2	2390.00	61.24	74.00	-12.76	62.60	-1.36	Peak	150	174	3	4824.00	31.31	54.00	-22.69	25.37	5.94	Average	277	169	4	4824.00	43.35	74.00	-30.65	37.41	5.94	Peak	277	169	5	12060.00	42.27	54.00	-11.73	26.30	15.97	Average	162	147	6	12060.00	55.07	74.00	-18.93	39.10	15.97	Peak	162	147	7	14472.00	43.85	54.00	-10.15	24.44	19.41	Average	361	240	8	14472.00	58.21	74.00	-15.79	38.80	19.41	Peak	361	240				
Freq.	Emission level	Limit	Margin	SA reading	Factor	Remark	ANT High	Turn Table																																																																																															
MHz	dBuV/m	dBuV/m	dB	dBuV	dB		cm	deg																																																																																															
1	2390.00	47.60	54.00	-6.40	48.96	-1.36	Average	150	174																																																																																														
2	2390.00	61.24	74.00	-12.76	62.60	-1.36	Peak	150	174																																																																																														
3	4824.00	31.31	54.00	-22.69	25.37	5.94	Average	277	169																																																																																														
4	4824.00	43.35	74.00	-30.65	37.41	5.94	Peak	277	169																																																																																														
5	12060.00	42.27	54.00	-11.73	26.30	15.97	Average	162	147																																																																																														
6	12060.00	55.07	74.00	-18.93	39.10	15.97	Peak	162	147																																																																																														
7	14472.00	43.85	54.00	-10.15	24.44	19.41	Average	361	240																																																																																														
8	14472.00	58.21	74.00	-15.79	38.80	19.41	Peak	361	240																																																																																														
<p>Note 1: Emission Level (dBuV/m) = SA Reading (dBuV/m) + Factor* (dB) *Factor includes antenna factor , cable loss and amplifier gain Note 2: Margin (dB) = Emission level (dBuV/m) – Limit (dBuV/m).</p>																																																																																																							

Modulation	HT20	Test Freq. (MHz)	2412
Polarization	Vertical	Test Configuration	1

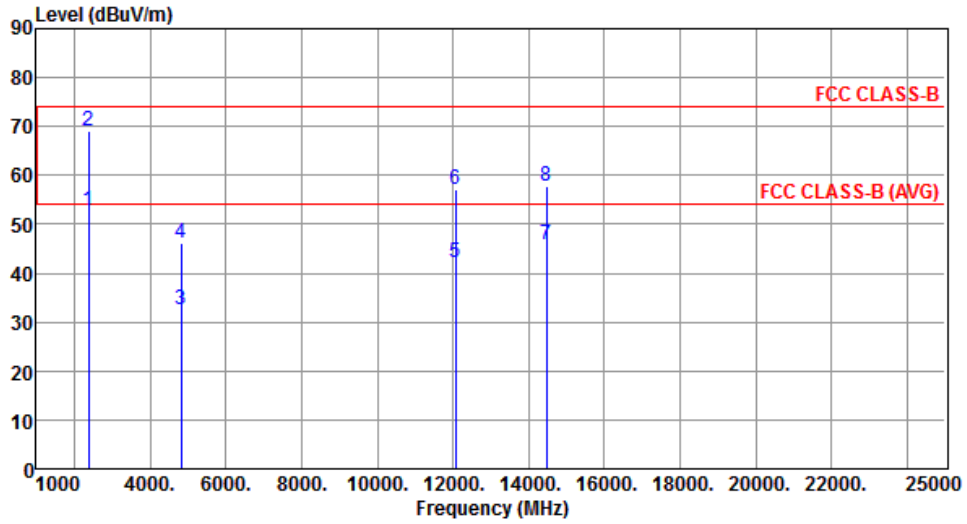

	Freq. MHz	Emission level dBuV/m	Limit dBuV/m	Margin dB	SA reading dBuV	Factor dB	Remark	ANT High cm	Turn Table deg
1	2390.00	52.90	54.00	-1.10	54.26	-1.36	Average	180	194
2	2390.00	69.22	74.00	-4.78	70.58	-1.36	Peak	150	177
3	4824.00	32.55	54.00	-21.45	26.61	5.94	Average	165	134
4	4824.00	46.04	74.00	-27.96	40.10	5.94	Peak	165	134
5	12060.00	42.28	54.00	-11.72	26.31	15.97	Average	214	180
6	12060.00	57.27	74.00	-16.73	41.30	15.97	Peak	214	180
7	14472.00	45.88	54.00	-8.12	26.47	19.41	Average	259	177
8	14472.00	57.84	74.00	-16.16	38.43	19.41	Peak	259	177

Note 1: Emission Level (dBuV/m) = SA Reading (dBuV/m) + Factor* (dB)

*Factor includes antenna factor , cable loss and amplifier gain

Note 2: Margin (dB) = Emission level (dBuV/m) – Limit (dBuV/m).

Modulation	HT20	Test Freq. (MHz)	2437
Polarization	Horizontal	Test Configuration	1

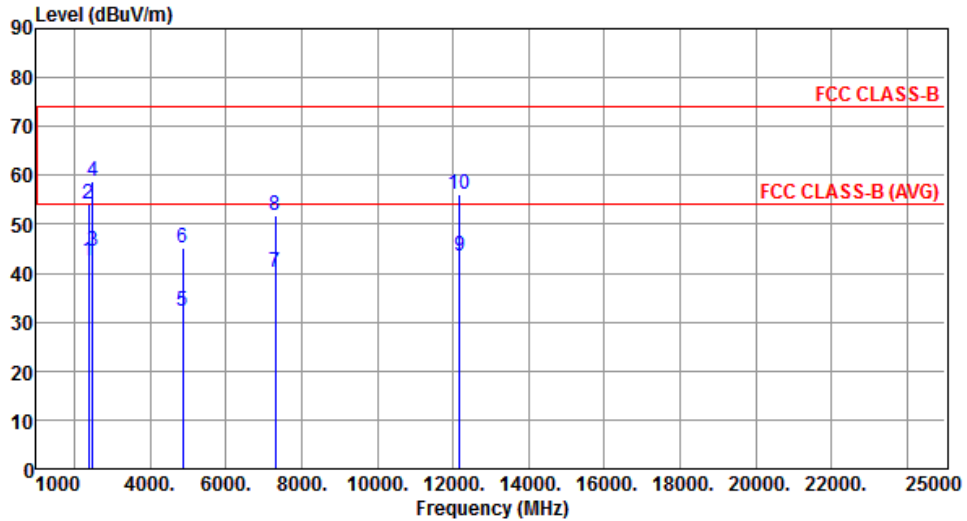

	Freq. MHz	Emission level dBuV/m	Limit dBuV/m	Margin dB	SA reading dBuV	Factor dB	Remark	ANT High cm	Turn Table deg
1	2390.00	42.56	54.00	-11.44	43.92	-1.36	Average	204	182
2	2390.00	54.29	74.00	-19.71	55.65	-1.36	Peak	204	182
3	2483.50	44.63	54.00	-9.37	45.65	-1.02	Average	204	182
4	2483.50	58.62	74.00	-15.38	59.64	-1.02	Peak	204	182
5	4874.00	32.27	54.00	-21.73	26.30	5.97	Average	190	157
6	4874.00	45.17	74.00	-28.83	39.20	5.97	Peak	190	157
7	7311.00	40.05	54.00	-13.95	29.30	10.75	Average	222	230
8	7311.00	51.80	74.00	-22.20	41.05	10.75	Peak	222	230
9	12185.00	43.63	54.00	-10.37	27.79	15.84	Average	200	192
10	12185.00	56.17	74.00	-17.83	40.33	15.84	Peak	200	192

Note 1: Emission Level (dBuV/m) = SA Reading (dBuV/m) + Factor* (dB)

*Factor includes antenna factor , cable loss and amplifier gain

Note 2: Margin (dB) = Emission level (dBuV/m) – Limit (dBuV/m).

Modulation	HT20	Test Freq. (MHz)	2437
Polarization	Vertical	Test Configuration	1

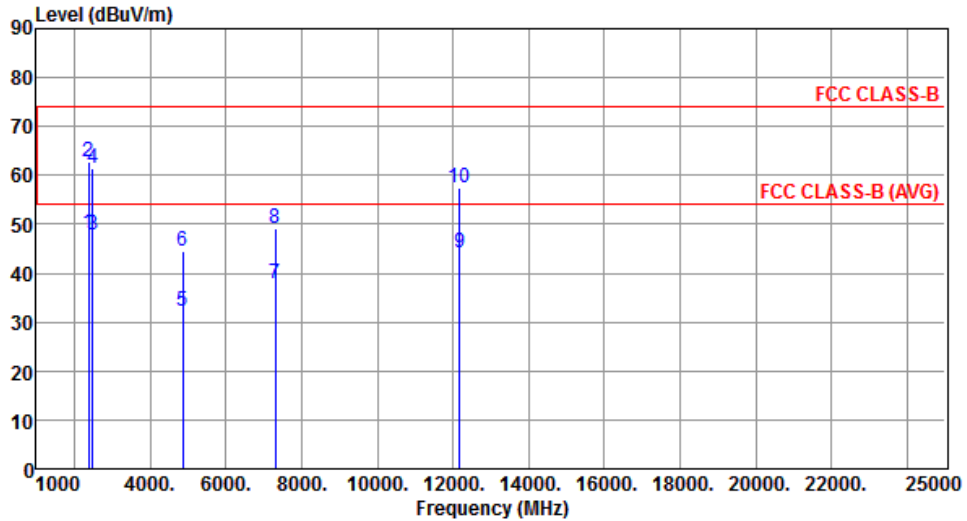

	Freq. MHz	Emission level dBuV/m	Limit dBuV/m	Margin dB	SA reading dBuV	Factor dB	Remark	ANT High cm	Turn Table deg
1	2390.00	48.12	54.00	-5.88	49.48	-1.36	Average	150	167
2	2390.00	62.64	74.00	-11.36	64.00	-1.36	Peak	150	167
3	2483.50	47.82	54.00	-6.18	48.84	-1.02	Average	150	167
4	2483.50	61.44	74.00	-12.56	62.46	-1.02	Peak	150	167
5	4874.00	32.07	54.00	-21.93	26.10	5.97	Average	240	139
6	4874.00	44.37	74.00	-29.63	38.40	5.97	Peak	240	139
7	7311.00	37.85	54.00	-16.15	27.10	10.75	Average	339	147
8	7311.00	49.20	74.00	-24.80	38.45	10.75	Peak	339	147
9	12185.00	44.11	54.00	-9.89	28.27	15.84	Average	231	157
10	12185.00	57.57	74.00	-16.43	41.73	15.84	Peak	231	157

Note 1: Emission Level (dBuV/m) = SA Reading (dBuV/m) + Factor* (dB)

*Factor includes antenna factor , cable loss and amplifier gain

Note 2: Margin (dB) = Emission level (dBuV/m) – Limit (dBuV/m).

Modulation	HT20	Test Freq. (MHz)	2462
Polarization	Horizontal	Test Configuration	1

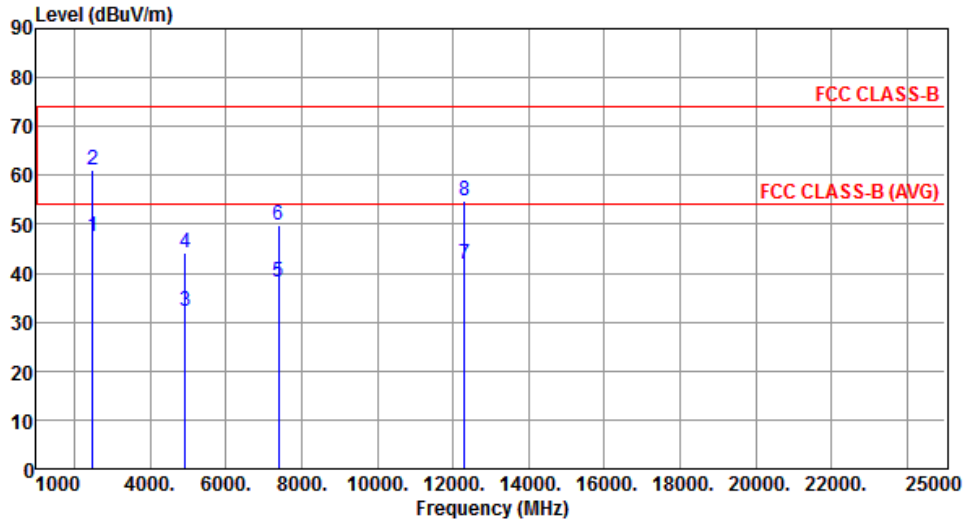

	Freq. MHz	Emission level dBuV/m	Limit dBuV/m	Margin dB	SA reading dBuV	Factor dB	Remark	ANT High cm	Turn Table deg
1	2483.50	47.47	54.00	-6.53	48.49	-1.02	Average	152	146
2	2483.50	61.26	74.00	-12.74	62.28	-1.02	Peak	152	146
3	4924.00	32.38	54.00	-21.62	26.37	6.01	Average	190	165
4	4924.00	44.27	74.00	-29.73	38.26	6.01	Peak	190	165
5	7386.00	38.10	54.00	-15.90	27.20	10.90	Average	214	177
6	7386.00	49.90	74.00	-24.10	39.00	10.90	Peak	214	177
7	12310.00	41.71	54.00	-12.29	26.01	15.70	Average	198	179
8	12310.00	54.96	74.00	-19.04	39.26	15.70	Peak	198	179

Note 1: Emission Level (dBuV/m) = SA Reading (dBuV/m) + Factor* (dB)

*Factor includes antenna factor , cable loss and amplifier gain

Note 2: Margin (dB) = Emission level (dBuV/m) – Limit (dBuV/m).

Modulation	HT20	Test Freq. (MHz)	2462
Polarization	Vertical	Test Configuration	1

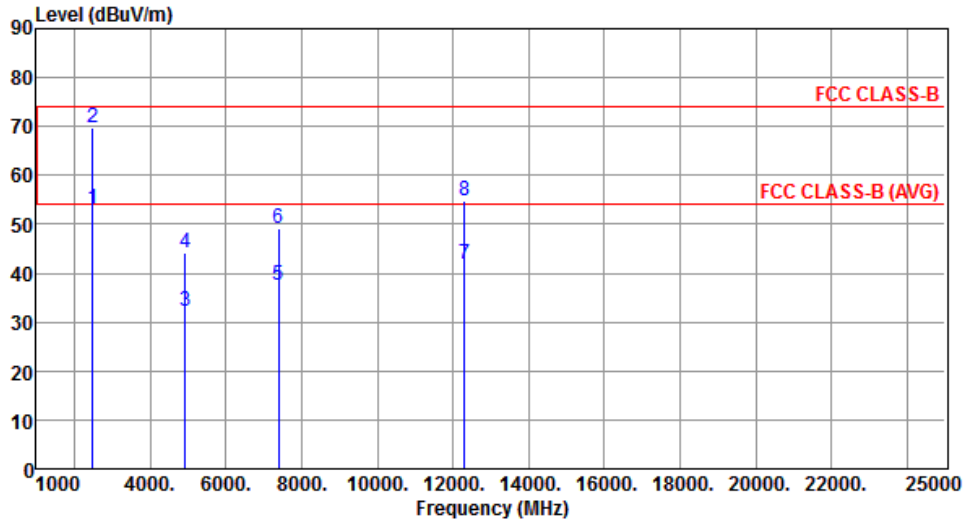

	Freq. MHz	Emission level dBuV/m	Limit dBuV/m	Margin dB	SA reading dBuV	Factor dB	Remark	ANT High cm	Turn Table deg
1	2483.50	53.23	54.00	-0.77	54.25	-1.02	Average	152	162
2	2483.50	69.64	74.00	-4.36	70.66	-1.02	Peak	152	162
3	4924.00	32.11	54.00	-21.89	26.10	6.01	Average	240	142
4	4924.00	44.21	74.00	-29.79	38.20	6.01	Peak	240	142
5	7386.00	37.60	54.00	-16.40	26.70	10.90	Average	361	149
6	7386.00	49.10	74.00	-24.90	38.20	10.90	Peak	361	149
7	12310.00	42.00	54.00	-12.00	26.30	15.70	Average	244	169
8	12310.00	54.90	74.00	-19.10	39.20	15.70	Peak	244	169

Note 1: Emission Level (dBuV/m) = SA Reading (dBuV/m) + Factor* (dB)

*Factor includes antenna factor , cable loss and amplifier gain

Note 2: Margin (dB) = Emission level (dBuV/m) – Limit (dBuV/m).

Test Configuration 2: PCB Dipole antenna

3.5.8 Transmitter Radiated Unwanted Emissions (Below 1GHz)

Modulation	HT20	Test Freq. (MHz)	2437
Polarization	Horizontal	Test Configuration	2

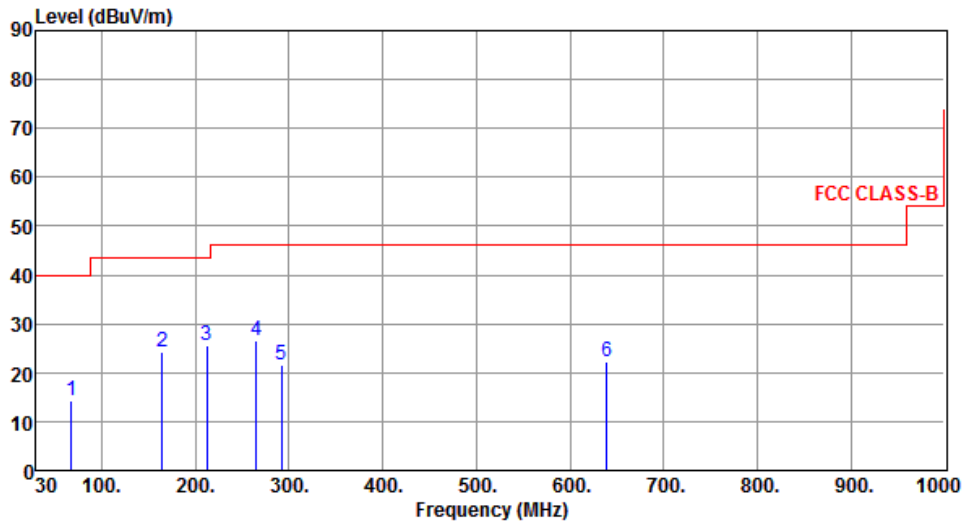

	Freq. MHz	Emission level dBuV/m	Limit dBuV/m	Margin dB	SA reading dBuV	Factor dB	Remark	ANT High cm	Turn Table deg
1	67.83	14.31	40.00	-25.69	29.77	-15.46	Peak	---	---
2	164.83	24.24	43.50	-19.26	38.09	-13.85	Peak	---	---
3	212.36	25.54	43.50	-17.96	41.90	-16.36	Peak	---	---
4	264.74	26.42	46.00	-19.58	40.57	-14.15	Peak	---	---
5	291.90	21.45	46.00	-24.55	34.49	-13.04	Peak	---	---
6	639.16	22.24	46.00	-23.76	27.47	-5.23	Peak	---	---

Note 1: Emission Level (dBuV/m) = SA Reading (dBuV/m) + Factor* (dB)

*Factor includes antenna factor, cable loss and amplifier gain

Note 2: Margin (dB) = Emission level (dBuV/m) – Limit (dBuV/m).

Note 3: All spurious emissions below 30MHz are more than 20 dB below the limit.

Modulation	HT20	Test Freq. (MHz)	2437
Polarization	Vertical	Test Configuration	2

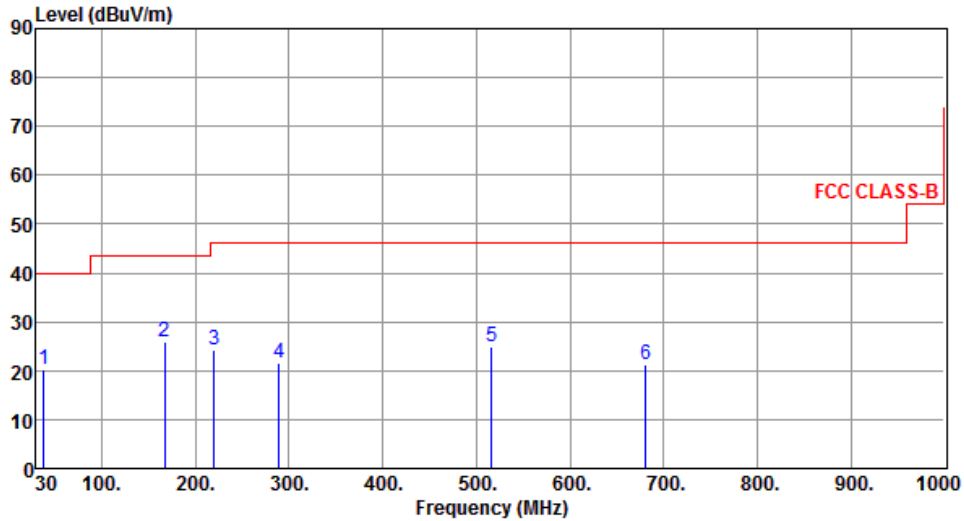

	Freq. MHz	Emission level dBuV/m	Limit dBuV/m	Margin dB	SA reading dBuV	Factor dB	Remark	ANT High cm	Turn Table deg
1	37.76	20.25	40.00	-19.75	33.56	-13.31	Peak	---	---
2	166.77	25.84	43.50	-17.66	39.78	-13.94	Peak	---	---
3	220.12	24.38	46.00	-21.62	40.34	-15.96	Peak	---	---
4	288.99	21.69	46.00	-24.31	34.85	-13.16	Peak	---	---
5	515.97	24.83	46.00	-21.17	32.30	-7.47	Peak	---	---
6	680.87	21.26	46.00	-24.74	25.93	-4.67	Peak	---	---

Note 1: Emission Level (dBuV/m) = SA Reading (dBuV/m) + Factor* (dB)

*Factor includes antenna factor , cable loss and amplifier gain

Note 2: Margin (dB) = Emission level (dBuV/m) – Limit (dBuV/m).

Note 3: All spurious emissions below 30MHz are more than 20 dB below the limit.

3.5.9 Transmitter Radiated Unwanted Emissions (Above 1GHz) for 11b

Modulation	11b	Test Freq. (MHz)	2412
Polarization	Horizontal	Test Configuration	2

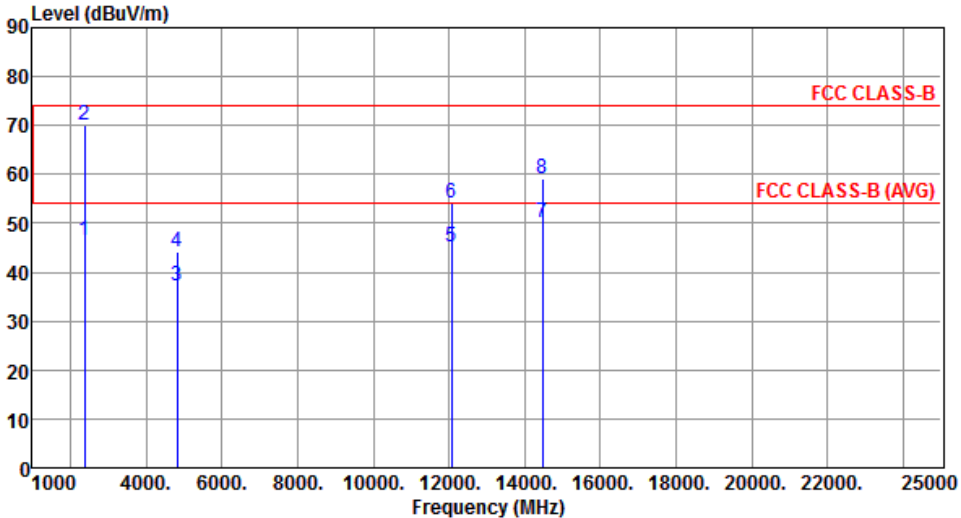

	Freq. MHz	Emission level dBuV/m	Limit dBuV/m	Margin dB	SA reading dBuV	Factor dB	Remark	ANT High cm	Turn Table deg
1	2390.00	46.62	54.00	-7.38	47.98	-1.36	Average	150	189
2	2390.00	70.02	74.00	-3.98	71.38	-1.36	Peak	150	189
3	4824.00	37.34	54.00	-16.66	31.40	5.94	Average	306	8
4	4824.00	44.09	74.00	-29.91	38.15	5.94	Peak	306	8
5	12060.00	45.19	54.00	-8.81	29.22	15.97	Average	324	13
6	12060.00	54.03	74.00	-19.97	38.06	15.97	Peak	324	13
7	14472.00	50.10	54.00	-3.90	30.69	19.41	Average	202	7
8	14472.00	59.02	74.00	-14.98	39.61	19.41	Peak	202	7

Note 1: Emission Level (dBuV/m) = SA Reading (dBuV/m) + Factor* (dB)
*Factor includes antenna factor , cable loss and amplifier gain
Note 2: Margin (dB) = Emission level (dBuV/m) – Limit (dBuV/m).

Modulation	11b	Test Freq. (MHz)	2412
Polarization	Vertical	Test Configuration	2

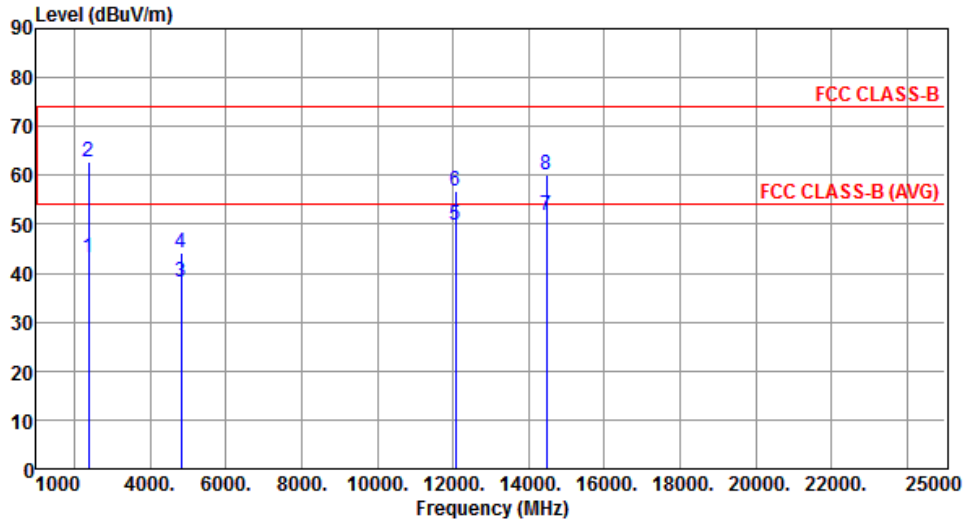

	Freq. MHz	Emission level dBuV/m	Limit dBuV/m	Margin dB	SA reading dBuV	Factor dB	Remark	ANT High cm	Turn Table deg
1	2390.00	43.22	54.00	-10.78	44.58	-1.36	Average	154	0
2	2390.00	62.62	74.00	-11.38	63.98	-1.36	Peak	154	0
3	4824.00	38.24	54.00	-15.76	32.30	5.94	Average	186	358
4	4824.00	44.12	74.00	-29.88	38.18	5.94	Peak	186	358
5	12060.00	49.84	54.00	-4.16	33.87	15.97	Average	164	353
6	12060.00	56.77	74.00	-17.23	40.80	15.97	Peak	164	353
7	14472.00	51.83	54.00	-2.17	32.42	19.41	Average	189	349
8	14472.00	60.17	74.00	-13.83	40.76	19.41	Peak	189	349

Note 1: Emission Level (dBuV/m) = SA Reading (dBuV/m) + Factor* (dB)

*Factor includes antenna factor , cable loss and amplifier gain

Note 2: Margin (dB) = Emission level (dBuV/m) – Limit (dBuV/m).

Modulation	11b	Test Freq. (MHz)	2437
Polarization	Horizontal	Test Configuration	2

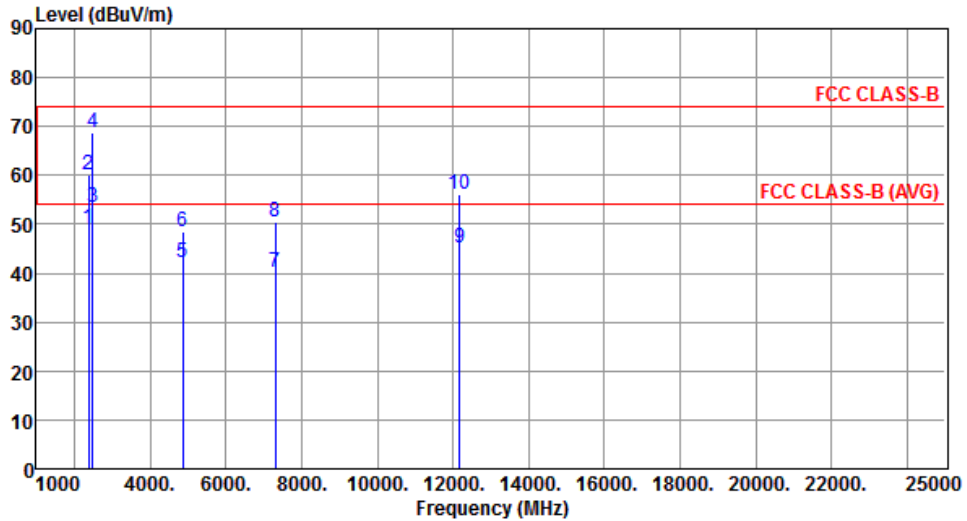

	Freq. MHz	Emission level dBuV/m	Limit dBuV/m	Margin dB	SA reading dBuV	Factor dB	Remark	ANT High cm	Turn Table deg
1	2385.00	49.10	54.00	-4.90	50.49	-1.39	Average	400	183
2	2385.00	59.98	74.00	-14.02	61.37	-1.39	Peak	400	183
3	2489.00	53.39	54.00	-0.61	54.40	-1.01	Average	385	2
4	2489.00	68.71	74.00	-5.29	69.72	-1.01	Peak	385	2
5	4874.00	42.27	54.00	-11.73	36.30	5.97	Average	214	50
6	4874.00	48.58	74.00	-25.42	42.61	5.97	Peak	214	50
7	7311.00	40.25	54.00	-13.75	29.50	10.75	Average	204	31
8	7311.00	50.58	74.00	-23.42	39.83	10.75	Peak	204	31
9	12185.00	45.30	54.00	-8.70	29.46	15.84	Average	211	64
10	12185.00	56.03	74.00	-17.97	40.19	15.84	Peak	211	64

Note 1: Emission Level (dBuV/m) = SA Reading (dBuV/m) + Factor* (dB)

*Factor includes antenna factor , cable loss and amplifier gain

Note 2: Margin (dB) = Emission level (dBuV/m) – Limit (dBuV/m).

Modulation	11b	Test Freq. (MHz)	2437
Polarization	Vertical	Test Configuration	2

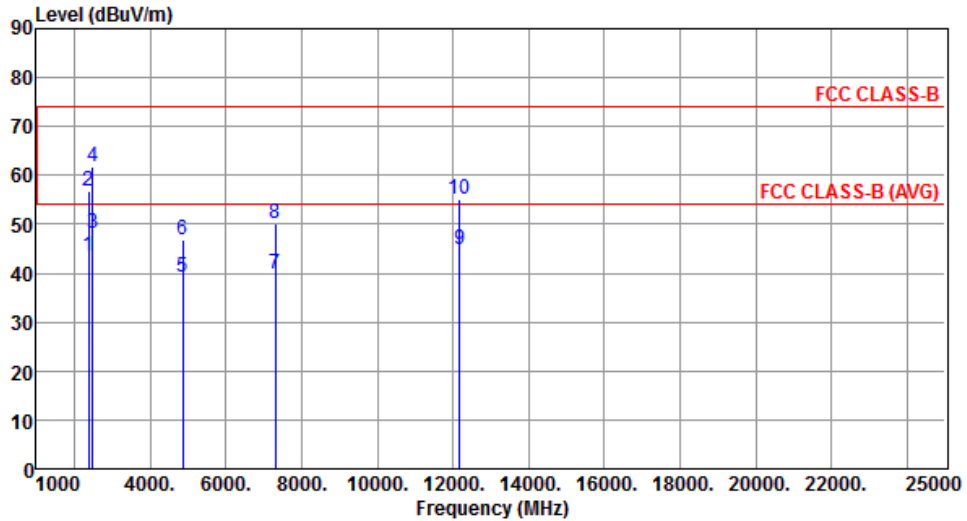

	Freq. MHz	Emission level dBuV/m	Limit dBuV/m	Margin dB	SA reading dBuV	Factor dB	Remark	ANT High cm	Turn Table deg
1	2385.00	43.49	54.00	-10.51	44.88	-1.39	Average	150	354
2	2385.00	56.71	74.00	-17.29	58.10	-1.39	Peak	150	354
3	2489.00	48.25	54.00	-5.75	49.26	-1.01	Average	150	108
4	2489.00	61.64	74.00	-12.36	62.65	-1.01	Peak	150	108
5	4874.00	39.20	54.00	-14.80	33.23	5.97	Average	208	0
6	4874.00	46.75	74.00	-27.25	40.78	5.97	Peak	208	0
7	7311.00	39.89	54.00	-14.11	29.14	10.75	Average	213	347
8	7311.00	50.31	74.00	-23.69	39.56	10.75	Peak	213	347
9	12185.00	44.95	54.00	-9.05	29.11	15.84	Average	212	15
10	12185.00	55.29	74.00	-18.71	39.45	15.84	Peak	212	15

Note 1: Emission Level (dBuV/m) = SA Reading (dBuV/m) + Factor* (dB)

*Factor includes antenna factor , cable loss and amplifier gain

Note 2: Margin (dB) = Emission level (dBuV/m) – Limit (dBuV/m).

Modulation	11b	Test Freq. (MHz)	2462
Polarization	Horizontal	Test Configuration	2

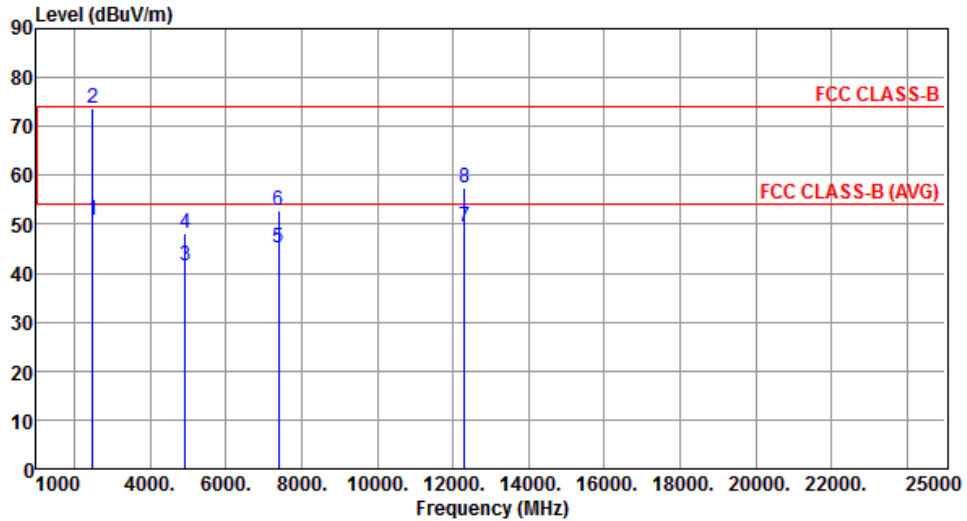

	Freq. MHz	Emission level dBuV/m	Limit dBuV/m	Margin dB	SA reading dBuV	Factor dB	Remark	ANT High cm	Turn Table deg
1	2483.50	50.75	54.00	-3.25	51.77	-1.02	Average	314	140
2	2483.50	73.80	74.00	-0.20	74.82	-1.02	Peak	314	140
3	4924.00	41.68	54.00	-12.32	35.67	6.01	Average	279	350
4	4924.00	48.29	74.00	-25.71	42.28	6.01	Peak	279	350
5	7386.00	45.08	54.00	-8.92	34.18	10.90	Average	283	61
6	7386.00	52.71	74.00	-21.29	41.81	10.90	Peak	283	61
7	12310.00	49.61	54.00	-4.39	33.91	15.70	Average	281	59
8	12310.00	57.45	74.00	-16.55	41.75	15.70	Peak	281	59

Note 1: Emission Level (dBuV/m) = SA Reading (dBuV/m) + Factor* (dB)

*Factor includes antenna factor , cable loss and amplifier gain

Note 2: Margin (dB) = Emission level (dBuV/m) – Limit (dBuV/m).

Modulation	11b	Test Freq. (MHz)	2462
Polarization	Vertical	Test Configuration	2

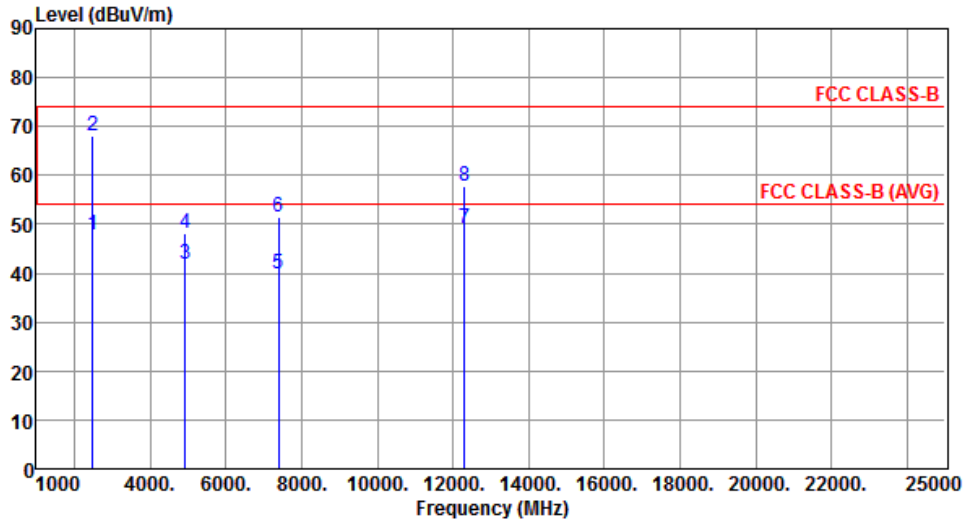

	Freq. MHz	Emission level dBuV/m	Limit dBuV/m	Margin dB	SA reading dBuV	Factor dB	Remark	ANT High cm	Turn Table deg
1	2483.50	47.93	54.00	-6.07	48.95	-1.02	Average	400	73
2	2483.50	68.10	74.00	-5.90	69.12	-1.02	Peak	400	73
3	4924.00	41.89	54.00	-12.11	35.88	6.01	Average	158	16
4	4924.00	48.08	74.00	-25.92	42.07	6.01	Peak	158	16
5	7386.00	39.73	54.00	-14.27	28.83	10.90	Average	150	19
6	7386.00	51.36	74.00	-22.64	40.46	10.90	Peak	150	19
7	12310.00	49.02	54.00	-4.98	33.32	15.70	Average	194	344
8	12310.00	57.94	74.00	-16.06	42.24	15.70	Peak	194	344

Note 1: Emission Level (dBuV/m) = SA Reading (dBuV/m) + Factor* (dB)

*Factor includes antenna factor , cable loss and amplifier gain

Note 2: Margin (dB) = Emission level (dBuV/m) – Limit (dBuV/m).

3.5.10 Transmitter Radiated Unwanted Emissions (Above 1GHz) for 11g

Modulation	11g	Test Freq. (MHz)	2412
Polarization	Horizontal	Test Configuration	2

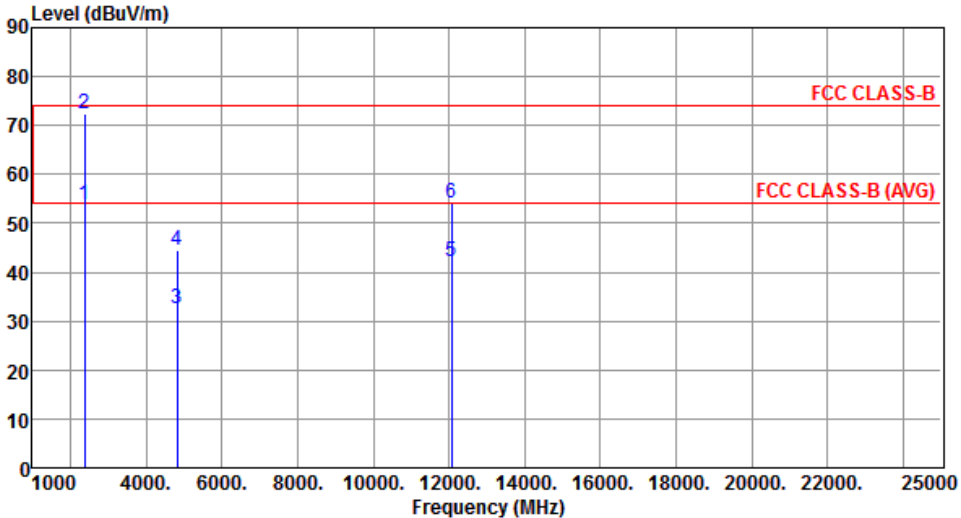

	Freq. MHz	Emission level dBuV/m	Limit dBuV/m	Margin dB	SA reading dBuV	Factor dB	Remark	ANT High cm	Turn Table deg
1	2390.00	53.74	54.00	-0.26	55.10	-1.36	Average	276	349
2	2390.00	72.37	74.00	-1.63	73.73	-1.36	Peak	276	349
3	4824.00	32.45	54.00	-21.55	26.51	5.94	Average	203	217
4	4824.00	44.53	74.00	-29.47	38.59	5.94	Peak	203	217
5	12060.00	42.13	54.00	-11.87	26.16	15.97	Average	221	179
6	12060.00	54.27	74.00	-19.73	38.30	15.97	Peak	221	179

Note 1: Emission Level (dBuV/m) = SA Reading (dBuV/m) + Factor* (dB)
 *Factor includes antenna factor , cable loss and amplifier gain
 Note 2: Margin (dB) = Emission level (dBuV/m) – Limit (dBuV/m).

Modulation	11g	Test Freq. (MHz)	2412
Polarization	Vertical	Test Configuration	2

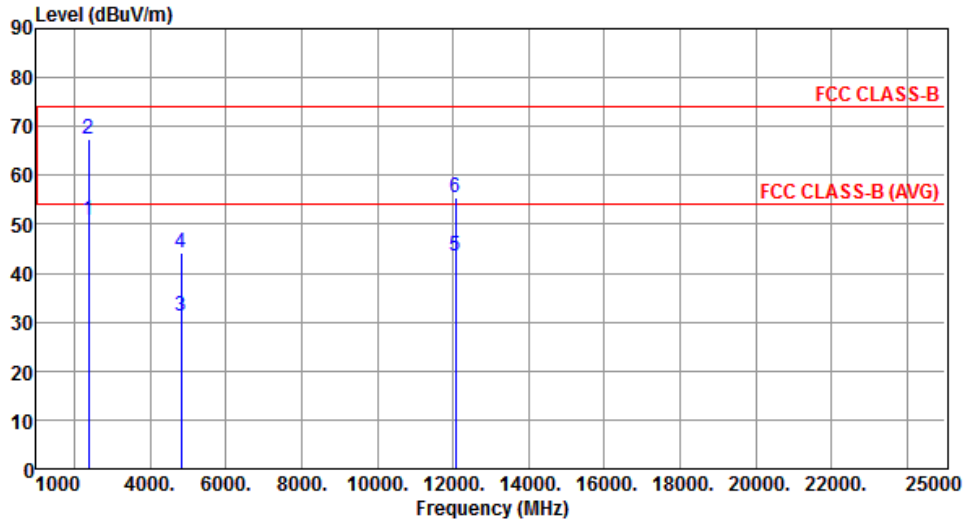

	Freq. MHz	Emission level dBuV/m	Limit dBuV/m	Margin dB	SA reading dBuV	Factor dB	Remark	ANT High cm	Turn Table deg
1	2390.00	50.93	54.00	-3.07	52.29	-1.36	Average	330	271
2	2390.00	67.41	74.00	-6.59	68.77	-1.36	Peak	330	271
3	4824.00	31.28	54.00	-22.72	25.34	5.94	Average	311	253
4	4824.00	44.25	74.00	-29.75	38.31	5.94	Peak	311	253
5	12060.00	43.36	54.00	-10.64	27.39	15.97	Average	218	183
6	12060.00	55.40	74.00	-18.60	39.43	15.97	Peak	218	183

Note 1: Emission Level (dBuV/m) = SA Reading (dBuV/m) + Factor* (dB)

*Factor includes antenna factor , cable loss and amplifier gain

Note 2: Margin (dB) = Emission level (dBuV/m) – Limit (dBuV/m).

Modulation	11g	Test Freq. (MHz)	2437
Polarization	Horizontal	Test Configuration	2

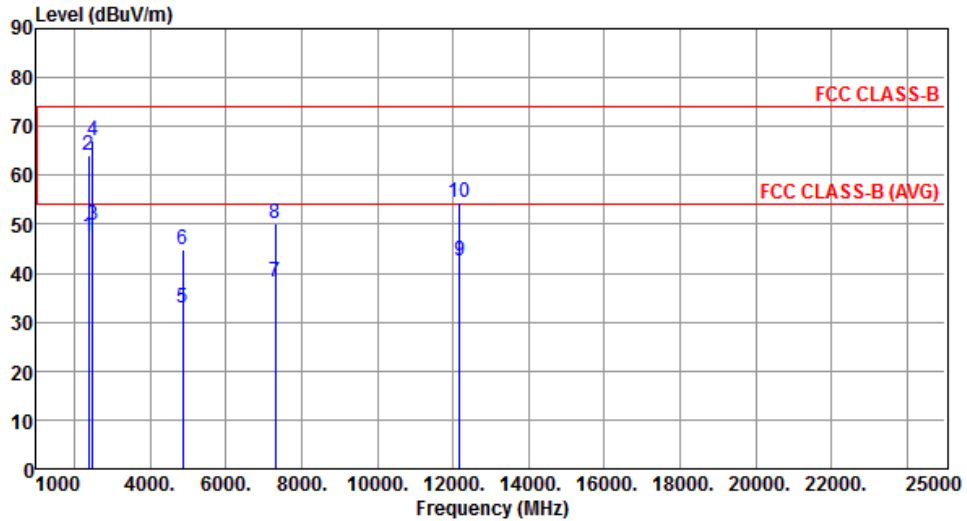

	Freq. MHz	Emission level dBuV/m	Limit dBuV/m	Margin dB	SA reading dBuV	Factor dB	Remark	ANT High cm	Turn Table deg
1	2390.00	47.61	54.00	-6.39	48.97	-1.36	Average	376	4
2	2390.00	64.01	74.00	-9.99	65.37	-1.36	Peak	376	4
3	2483.50	49.69	54.00	-4.31	50.71	-1.02	Average	284	334
4	2483.50	67.23	74.00	-6.77	68.25	-1.02	Peak	284	334
5	4874.00	32.76	54.00	-21.24	26.79	5.97	Average	207	213
6	4874.00	44.76	74.00	-29.24	38.79	5.97	Peak	207	213
7	7311.00	38.36	54.00	-15.64	27.61	10.75	Average	203	153
8	7311.00	50.01	74.00	-23.99	39.26	10.75	Peak	203	153
9	12185.00	42.41	54.00	-11.59	26.57	15.84	Average	229	174
10	12185.00	54.50	74.00	-19.50	38.66	15.84	Peak	229	174

Note 1: Emission Level (dBuV/m) = SA Reading (dBuV/m) + Factor* (dB)

*Factor includes antenna factor , cable loss and amplifier gain

Note 2: Margin (dB) = Emission level (dBuV/m) – Limit (dBuV/m).

Modulation	11g	Test Freq. (MHz)	2437
Polarization	Vertical	Test Configuration	2

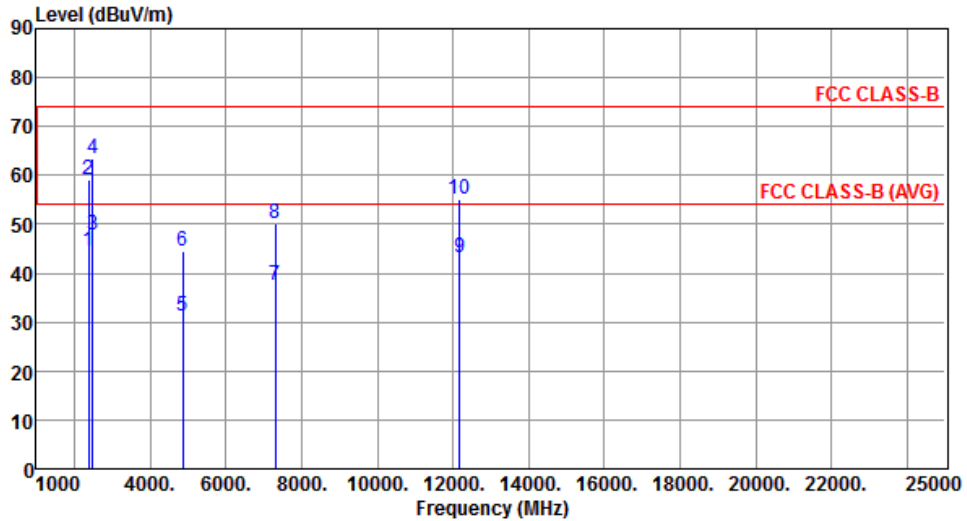

	Freq. MHz	Emission level dBuV/m	Limit dBuV/m	Margin dB	SA reading dBuV	Factor dB	Remark	ANT High cm	Turn Table deg
1	2390.00	44.60	54.00	-9.40	45.96	-1.36	Average	363	248
2	2390.00	59.13	74.00	-14.87	60.49	-1.36	Peak	363	248
3	2483.50	47.90	54.00	-6.10	48.92	-1.02	Average	333	295
4	2483.50	63.46	74.00	-10.54	64.48	-1.02	Peak	333	295
5	4874.00	31.12	54.00	-22.88	25.15	5.97	Average	315	262
6	4874.00	44.58	74.00	-29.42	38.61	5.97	Peak	315	262
7	7311.00	37.37	54.00	-16.63	26.62	10.75	Average	271	145
8	7311.00	50.08	74.00	-23.92	39.33	10.75	Peak	271	145
9	12185.00	43.16	54.00	-10.84	27.32	15.84	Average	214	180
10	12185.00	55.16	74.00	-18.84	39.32	15.84	Peak	214	180

Note 1: Emission Level (dBuV/m) = SA Reading (dBuV/m) + Factor* (dB)

*Factor includes antenna factor , cable loss and amplifier gain

Note 2: Margin (dB) = Emission level (dBuV/m) – Limit (dBuV/m).

Modulation	11g	Test Freq. (MHz)	2462
Polarization	Horizontal	Test Configuration	2

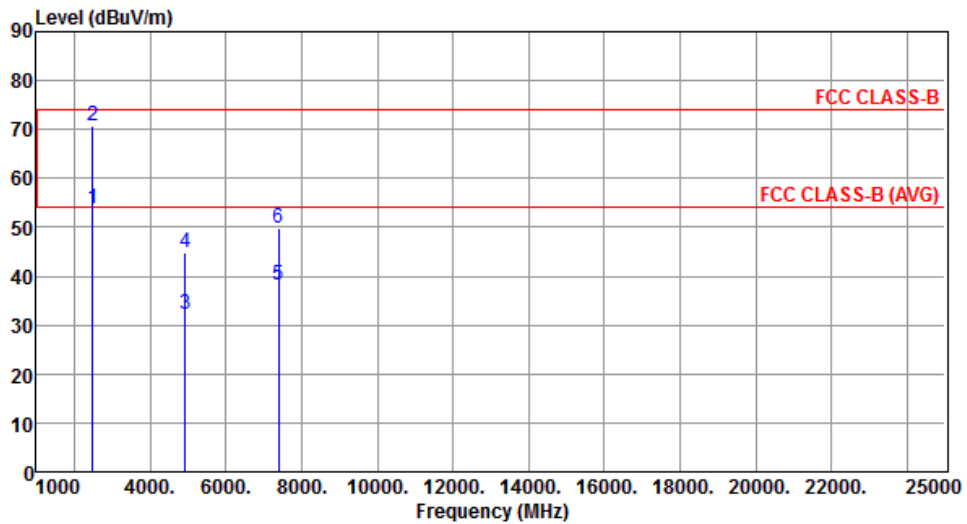

	Freq. MHz	Emission level dBUV/m	Limit dBUV/m	Margin dB	SA reading dBUV	Factor dB	Remark	ANT High cm	Turn Table deg
1	2483.50	53.84	54.00	-0.16	54.86	-1.02	Average	157	202
2	2483.50	70.63	74.00	-3.37	71.65	-1.02	Peak	157	202
3	4924.00	32.38	54.00	-21.62	26.37	6.01	Average	219	218
4	4924.00	44.97	74.00	-29.03	38.96	6.01	Peak	219	218
5	7386.00	38.12	54.00	-15.88	27.22	10.90	Average	208	150
6	7386.00	49.89	74.00	-24.11	38.99	10.90	Peak	208	150

Note 1: Emission Level (dBUV/m) = SA Reading (dBUV/m) + Factor* (dB)

*Factor includes antenna factor , cable loss and amplifier gain

Note 2: Margin (dB) = Emission level (dBUV/m) – Limit (dBUV/m).

Modulation	11g	Test Freq. (MHz)	2462
Polarization	Vertical	Test Configuration	2

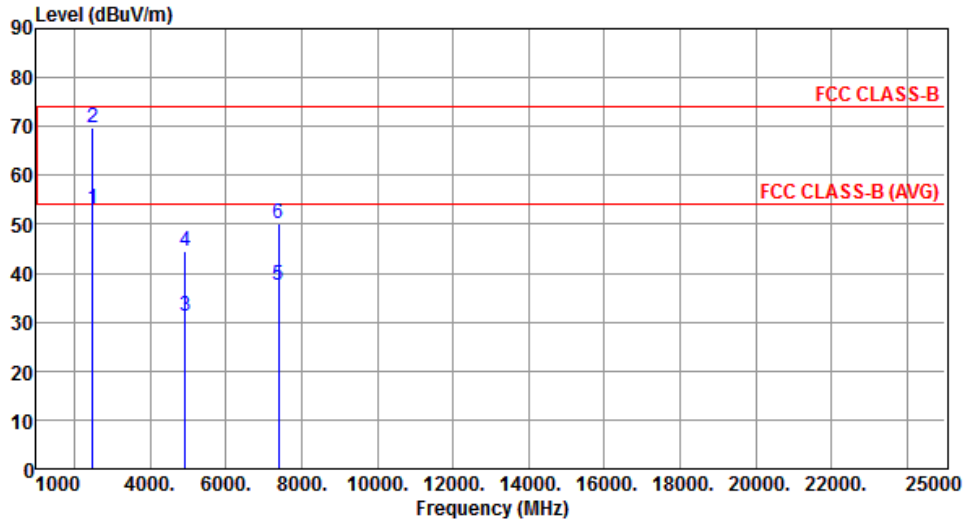

	Freq. MHz	Emission level dBuV/m	Limit dBuV/m	Margin dB	SA reading dBuV	Factor dB	Remark	ANT High cm	Turn Table deg
1	2483.50	52.97	54.00	-1.03	53.99	-1.02	Average	282	273
2	2483.50	69.87	74.00	-4.13	70.89	-1.02	Peak	282	273
3	4924.00	31.24	54.00	-22.76	25.23	6.01	Average	305	270
4	4924.00	44.66	74.00	-29.34	38.65	6.01	Peak	305	270
5	7386.00	37.44	54.00	-16.56	26.54	10.90	Average	265	143
6	7386.00	50.20	74.00	-23.80	39.30	10.90	Peak	265	143

Note 1: Emission Level (dBuV/m) = SA Reading (dBuV/m) + Factor* (dB)

*Factor includes antenna factor , cable loss and amplifier gain

Note 2: Margin (dB) = Emission level (dBuV/m) – Limit (dBuV/m).

3.5.11 Transmitter Radiated Unwanted Emissions (Above 1GHz) for HT20

Modulation	HT20	Test Freq. (MHz)	2412
Polarization	Horizontal	Test Configuration	2

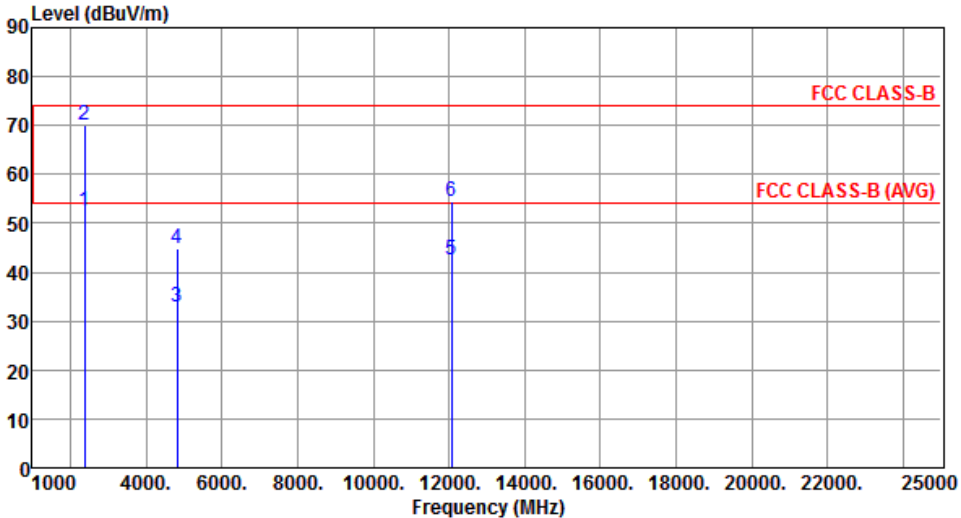

	Freq. MHz	Emission level dBuV/m	Limit dBuV/m	Margin dB	SA reading dBuV	Factor dB	Remark	ANT High cm	Turn Table deg
1	2390.00	52.56	54.00	-1.44	53.92	-1.36	Average	376	182
2	2390.00	70.02	74.00	-3.98	71.38	-1.36	Peak	376	182
3	4824.00	32.87	54.00	-21.13	26.93	5.94	Average	205	214
4	4824.00	44.90	74.00	-29.10	38.96	5.94	Peak	205	214
5	12060.00	42.63	54.00	-11.37	26.66	15.97	Average	222	171
6	12060.00	54.59	74.00	-19.41	38.62	15.97	Peak	222	171

Note 1: Emission Level (dBuV/m) = SA Reading (dBuV/m) + Factor* (dB)
*Factor includes antenna factor , cable loss and amplifier gain
Note 2: Margin (dB) = Emission level (dBuV/m) – Limit (dBuV/m).

Modulation	HT20	Test Freq. (MHz)	2412
Polarization	Vertical	Test Configuration	2

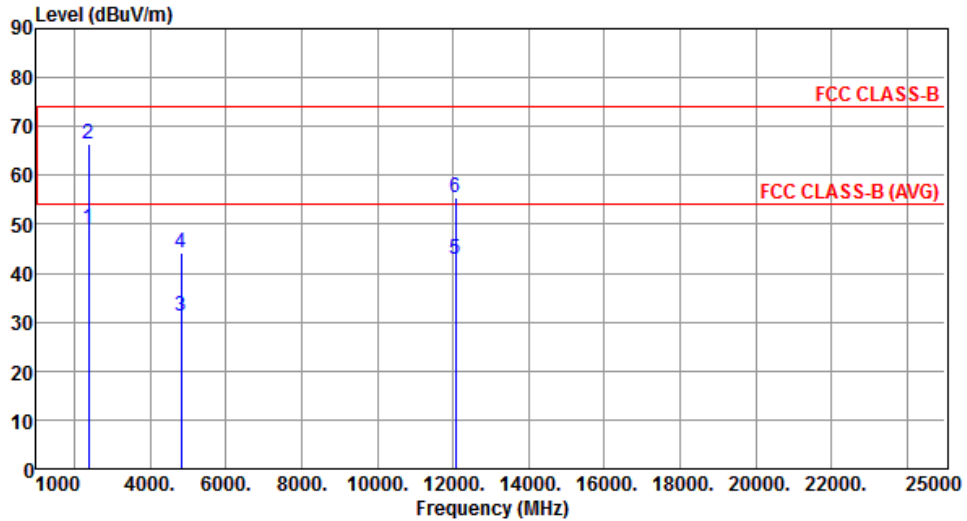

	Freq. MHz	Emission level dBUV/m	Limit dBUV/m	Margin dB	SA reading dBUV	Factor dB	Remark	ANT High cm	Turn Table deg
1	2390.00	49.16	54.00	-4.84	50.52	-1.36	Average	386	63
2	2390.00	66.52	74.00	-7.48	67.88	-1.36	Peak	386	63
3	4824.00	31.29	54.00	-22.71	25.35	5.94	Average	306	257
4	4824.00	44.23	74.00	-29.77	38.29	5.94	Peak	306	257
5	12060.00	43.00	54.00	-11.00	27.03	15.97	Average	211	184
6	12060.00	55.30	74.00	-18.70	39.33	15.97	Peak	211	184

Note 1: Emission Level (dBUV/m) = SA Reading (dBUV/m) + Factor* (dB)

*Factor includes antenna factor , cable loss and amplifier gain

Note 2: Margin (dB) = Emission level (dBUV/m) – Limit (dBUV/m).

Modulation	HT20	Test Freq. (MHz)	2437
Polarization	Horizontal	Test Configuration	2

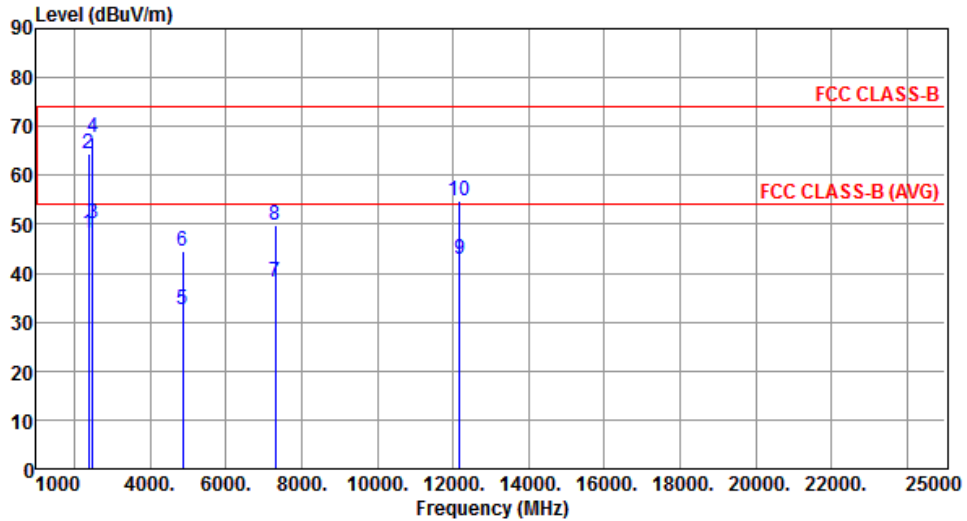

	Freq. MHz	Emission level dBuV/m	Limit dBuV/m	Margin dB	SA reading dBuV	Factor dB	Remark	ANT High cm	Turn Table deg
1	2390.00	48.15	54.00	-5.85	49.51	-1.36	Average	364	9
2	2390.00	64.53	74.00	-9.47	65.89	-1.36	Peak	364	9
3	2483.50	50.12	54.00	-3.88	51.14	-1.02	Average	288	334
4	2483.50	67.67	74.00	-6.33	68.69	-1.02	Peak	288	334
5	4874.00	32.43	54.00	-21.57	26.46	5.97	Average	209	211
6	4874.00	44.65	74.00	-29.35	38.68	5.97	Peak	209	211
7	7311.00	38.16	54.00	-15.84	27.41	10.75	Average	209	148
8	7311.00	49.93	74.00	-24.07	39.18	10.75	Peak	209	148
9	12185.00	42.75	54.00	-11.25	26.91	15.84	Average	225	173
10	12185.00	54.67	74.00	-19.33	38.83	15.84	Peak	225	173

Note 1: Emission Level (dBuV/m) = SA Reading (dBuV/m) + Factor* (dB)

*Factor includes antenna factor , cable loss and amplifier gain

Note 2: Margin (dB) = Emission level (dBuV/m) – Limit (dBuV/m).

Modulation	HT20	Test Freq. (MHz)	2437
Polarization	Vertical	Test Configuration	2

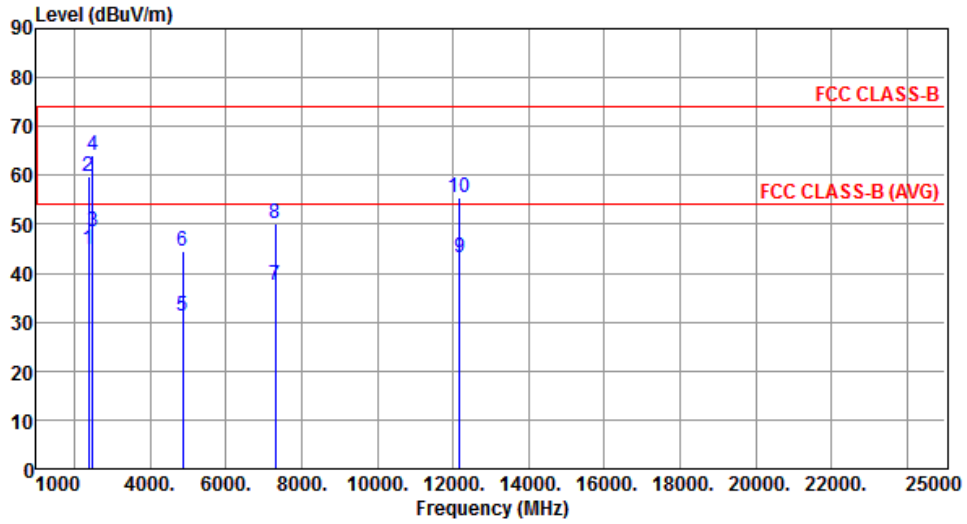

	Freq. MHz	Emission level dBuV/m	Limit dBuV/m	Margin dB	SA reading dBuV	Factor dB	Remark	ANT High cm	Turn Table deg
1	2390.00	44.97	54.00	-9.03	46.33	-1.36	Average	358	243
2	2390.00	59.68	74.00	-14.32	61.04	-1.36	Peak	358	243
3	2483.50	48.43	54.00	-5.57	49.45	-1.02	Average	331	289
4	2483.50	63.95	74.00	-10.05	64.97	-1.02	Peak	331	289
5	4874.00	31.34	54.00	-22.66	25.37	5.97	Average	311	264
6	4874.00	44.38	74.00	-29.62	38.41	5.97	Peak	311	264
7	7311.00	37.62	54.00	-16.38	26.87	10.75	Average	275	143
8	7311.00	50.31	74.00	-23.69	39.56	10.75	Peak	275	143
9	12185.00	43.27	54.00	-10.73	27.43	15.84	Average	216	185
10	12185.00	55.30	74.00	-18.70	39.46	15.84	Peak	216	185

Note 1: Emission Level (dBuV/m) = SA Reading (dBuV/m) + Factor* (dB)

*Factor includes antenna factor , cable loss and amplifier gain

Note 2: Margin (dB) = Emission level (dBuV/m) – Limit (dBuV/m).

Modulation	HT20	Test Freq. (MHz)	2462
Polarization	Horizontal	Test Configuration	2

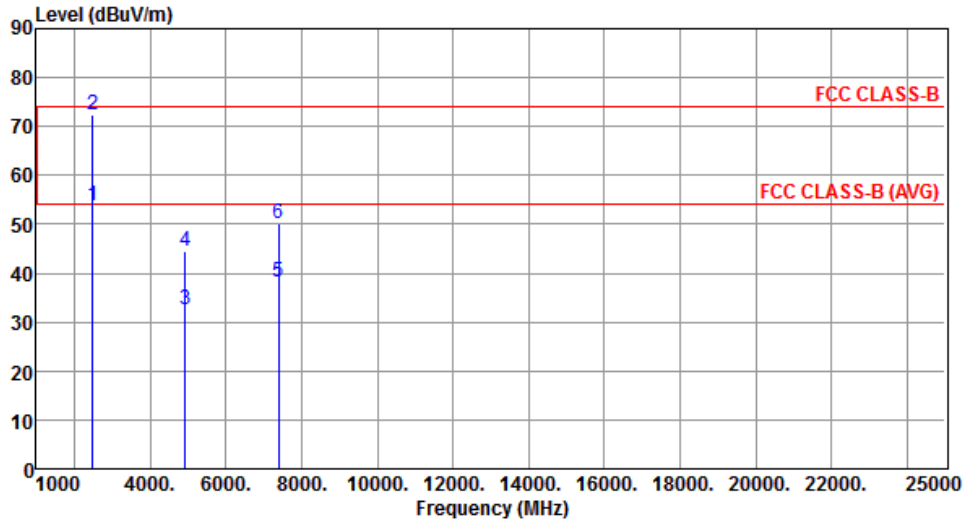

	Freq. MHz	Emission level dBuV/m	Limit dBuV/m	Margin dB	SA reading dBuV	Factor dB	Remark	ANT High cm	Turn Table deg
1	2483.50	53.73	54.00	-0.27	54.75	-1.02	Average	382	189
2	2483.50	72.26	74.00	-1.74	73.28	-1.02	Peak	382	189
3	4924.00	32.52	54.00	-21.48	26.51	6.01	Average	202	211
4	4924.00	44.63	74.00	-29.37	38.62	6.01	Peak	202	211
5	7386.00	38.11	54.00	-15.89	27.21	10.90	Average	200	159
6	7386.00	50.18	74.00	-23.82	39.28	10.90	Peak	200	159

Note 1: Emission Level (dBuV/m) = SA Reading (dBuV/m) + Factor* (dB)

*Factor includes antenna factor , cable loss and amplifier gain

Note 2: Margin (dB) = Emission level (dBuV/m) – Limit (dBuV/m).

Modulation	HT20	Test Freq. (MHz)	2462
Polarization	Vertical	Test Configuration	2

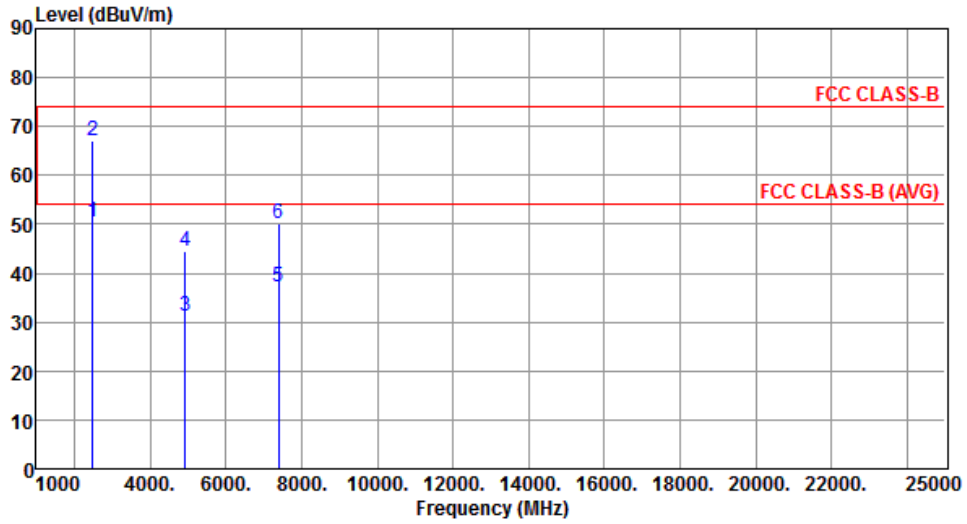

	Freq. MHz	Emission level dBuV/m	Limit dBuV/m	Margin dB	SA reading dBuV	Factor dB	Remark	ANT High cm	Turn Table deg
1	2483.50	50.44	54.00	-3.56	51.46	-1.02	Average	400	62
2	2483.50	66.99	74.00	-7.01	68.01	-1.02	Peak	400	62
3	4924.00	31.26	54.00	-22.74	25.25	6.01	Average	306	264
4	4924.00	44.65	74.00	-29.35	38.64	6.01	Peak	306	264
5	7386.00	37.31	54.00	-16.69	26.41	10.90	Average	279	143
6	7386.00	50.15	74.00	-23.85	39.25	10.90	Peak	279	143

Note 1: Emission Level (dBuV/m) = SA Reading (dBuV/m) + Factor* (dB)

*Factor includes antenna factor , cable loss and amplifier gain

Note 2: Margin (dB) = Emission level (dBuV/m) – Limit (dBuV/m).

Test Configuration 3: Isolated Magnetic Dipole antenna

3.5.12 Transmitter Radiated Unwanted Emissions (Below 1GHz)

Modulation	HT20	Test Freq. (MHz)	2437
Polarization	Horizontal	Test Configuration	3

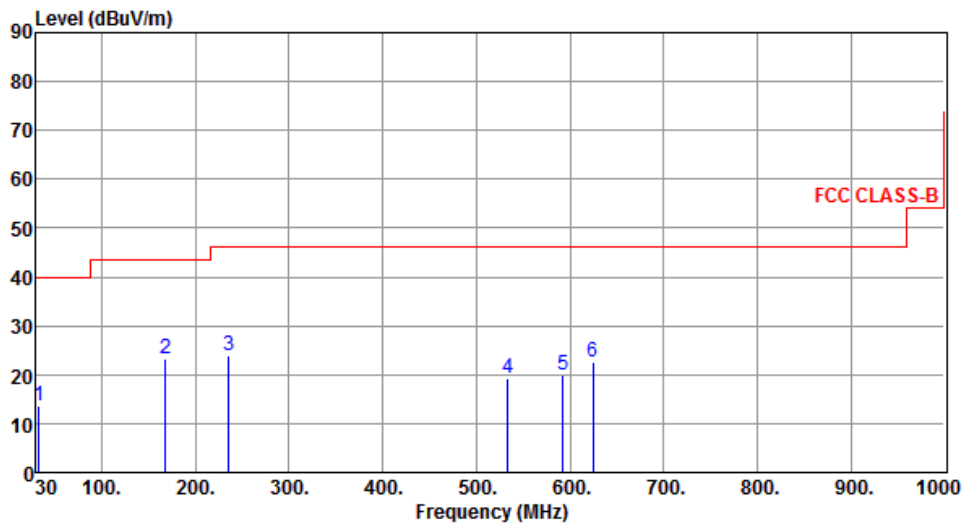

	Freq. MHz	Emission level dBuV/m	Limit dBuV/m	Margin dB	SA reading dBuV	Factor dB	Remark	ANT High cm	Turn Table deg
1	32.91	13.74	40.00	-26.26	27.24	-13.50	Peak	---	---
2	167.74	23.38	43.50	-20.12	37.37	-13.99	Peak	---	---
3	235.64	23.83	46.00	-22.17	38.85	-15.02	Peak	---	---
4	533.43	19.35	46.00	-26.65	26.65	-7.30	Peak	---	---
5	592.60	19.85	46.00	-26.15	25.84	-5.99	Peak	---	---
6	624.61	22.70	46.00	-23.30	28.14	-5.44	Peak	---	---

Note 1: Emission Level (dBuV/m) = SA Reading (dBuV/m) + Factor* (dB)

*Factor includes antenna factor , cable loss and amplifier gain

Note 2: Margin (dB) = Emission level (dBuV/m) – Limit (dBuV/m).

Note 3: All spurious emissions below 30MHz are more than 20 dB below the limit.

Modulation	HT20	Test Freq. (MHz)	2437
Polarization	Vertical	Test Configuration	3

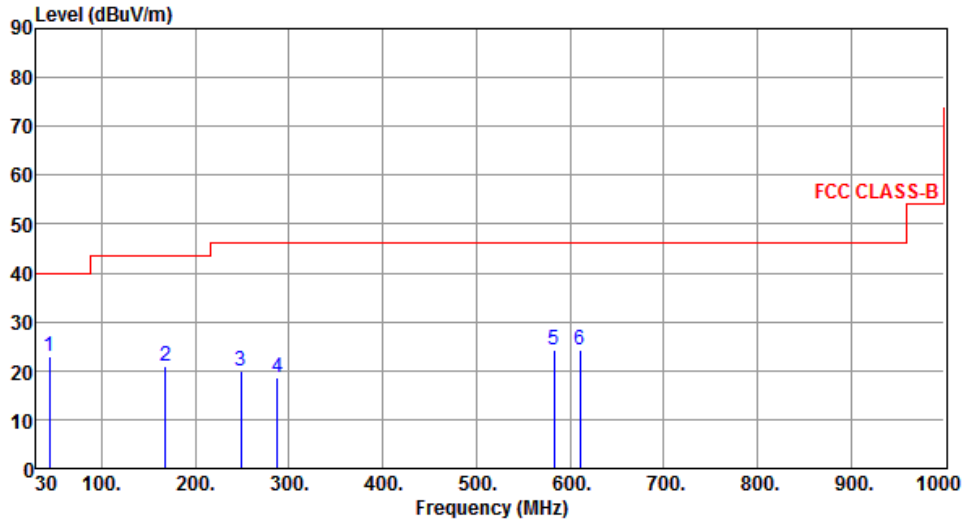

	Freq. MHz	Emission level dBuV/m	Limit dBuV/m	Margin dB	SA reading dBuV	Factor dB	Remark	ANT High cm	Turn Table deg
1	44.55	22.95	40.00	-17.05	35.80	-12.85	Peak	---	---
2	167.74	20.77	43.50	-22.73	34.76	-13.99	Peak	---	---
3	248.25	19.85	46.00	-26.15	34.59	-14.74	Peak	---	---
4	288.02	18.71	46.00	-27.29	31.90	-13.19	Peak	---	---
5	582.90	24.20	46.00	-21.80	30.45	-6.25	Peak	---	---
6	611.03	24.26	46.00	-21.74	29.89	-5.63	Peak	---	---

Note 1: Emission Level (dBuV/m) = SA Reading (dBuV/m) + Factor* (dB)

*Factor includes antenna factor , cable loss and amplifier gain

Note 2: Margin (dB) = Emission level (dBuV/m) – Limit (dBuV/m).

Note 3: All spurious emissions below 30MHz are more than 20 dB below the limit.

3.5.13 Transmitter Radiated Unwanted Emissions (Above 1GHz) for 11b

Modulation	11b	Test Freq. (MHz)	2412
Polarization	Horizontal	Test Configuration	3

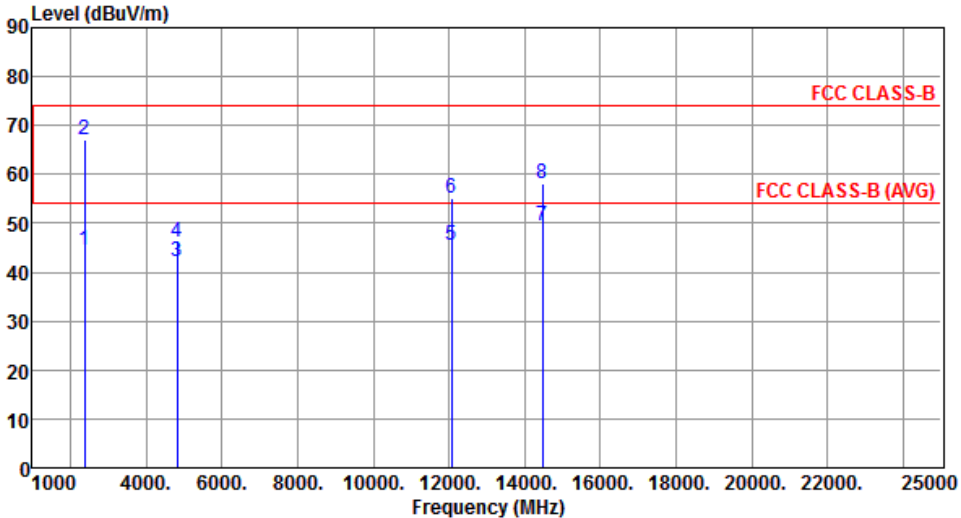

	Freq. MHz	Emission level dBuV/m	Limit dBuV/m	Margin dB	SA reading dBuV	Factor dB	Remark	ANT High cm	Turn Table deg
1	2390.00	44.59	54.00	-9.41	45.95	-1.36	Average	155	208
2	2390.00	67.22	74.00	-6.78	68.58	-1.36	Peak	155	208
3	4824.00	42.09	54.00	-11.91	36.15	5.94	Average	150	196
4	4824.00	46.24	74.00	-27.76	40.30	5.94	Peak	150	196
5	12060.00	45.62	54.00	-8.38	29.65	15.97	Average	270	126
6	12060.00	54.97	74.00	-19.03	39.00	15.97	Peak	270	126
7	14472.00	49.55	54.00	-4.45	30.14	19.41	Average	367	223
8	14472.00	58.03	74.00	-15.97	38.62	19.41	Peak	367	223

Note 1: Emission Level (dBuV/m) = SA Reading (dBuV/m) + Factor* (dB)
 *Factor includes antenna factor , cable loss and amplifier gain
 Note 2: Margin (dB) = Emission level (dBuV/m) – Limit (dBuV/m).

Modulation	11b	Test Freq. (MHz)	2412
Polarization	Vertical	Test Configuration	3

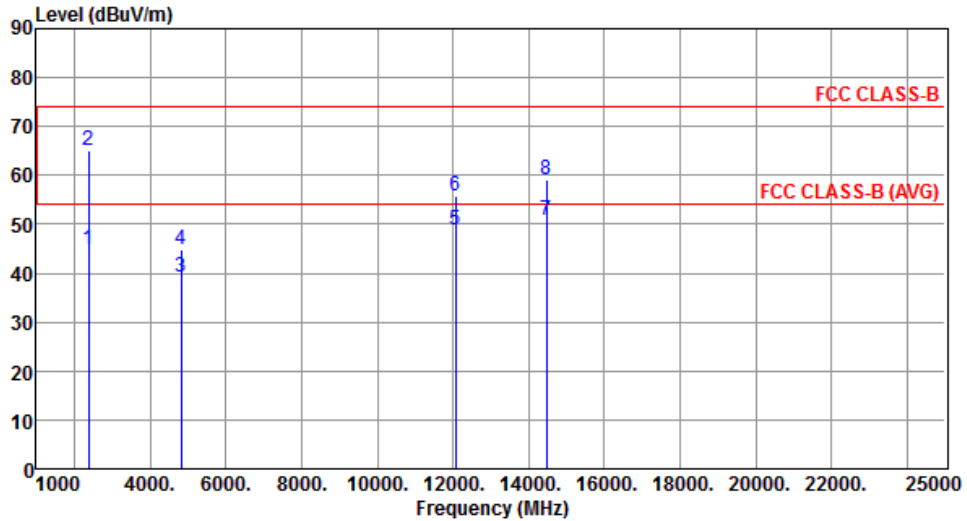

	Freq. MHz	Emission level dBuV/m	Limit dBuV/m	Margin dB	SA reading dBuV	Factor dB	Remark	ANT High cm	Turn Table deg
1	2390.00	44.98	54.00	-9.02	46.34	-1.36	Average	150	77
2	2390.00	65.19	74.00	-8.81	66.55	-1.36	Peak	150	77
3	4824.00	39.04	54.00	-14.96	33.10	5.94	Average	150	192
4	4824.00	44.78	74.00	-29.22	38.84	5.94	Peak	150	192
5	12060.00	48.84	54.00	-5.16	32.87	15.97	Average	209	158
6	12060.00	55.92	74.00	-18.08	39.95	15.97	Peak	209	158
7	14472.00	50.89	54.00	-3.11	31.48	19.41	Average	190	158
8	14472.00	59.05	74.00	-14.95	39.64	19.41	Peak	190	158

Note 1: Emission Level (dBuV/m) = SA Reading (dBuV/m) + Factor* (dB)

*Factor includes antenna factor , cable loss and amplifier gain

Note 2: Margin (dB) = Emission level (dBuV/m) – Limit (dBuV/m).

Modulation	11b	Test Freq. (MHz)	2437
Polarization	Horizontal	Test Configuration	3

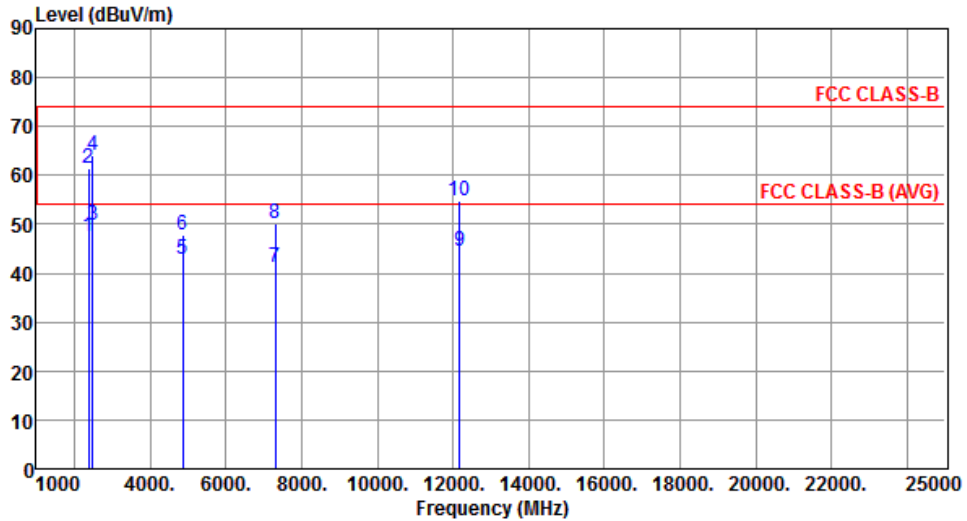

	Freq. MHz	Emission level dBuV/m	Limit dBuV/m	Margin dB	SA reading dBuV	Factor dB	Remark	ANT High cm	Turn Table deg
1	2385.00	47.57	54.00	-6.43	48.96	-1.39	Average	200	183
2	2385.00	61.48	74.00	-12.52	62.87	-1.39	Peak	200	183
3	2489.00	49.90	54.00	-4.10	50.91	-1.01	Average	199	165
4	2489.00	64.07	74.00	-9.93	65.08	-1.01	Peak	199	165
5	4874.00	42.84	54.00	-11.16	36.87	5.97	Average	308	169
6	4874.00	47.72	74.00	-26.28	41.75	5.97	Peak	308	169
7	7311.00	41.06	54.00	-12.94	30.31	10.75	Average	302	236
8	7311.00	50.31	74.00	-23.69	39.56	10.75	Peak	302	236
9	12185.00	44.66	54.00	-9.34	28.82	15.84	Average	212	200
10	12185.00	54.76	74.00	-19.24	38.92	15.84	Peak	212	200

Note 1: Emission Level (dBuV/m) = SA Reading (dBuV/m) + Factor* (dB)

*Factor includes antenna factor , cable loss and amplifier gain

Note 2: Margin (dB) = Emission level (dBuV/m) – Limit (dBuV/m).

Modulation	11b	Test Freq. (MHz)	2437
Polarization	Vertical	Test Configuration	3

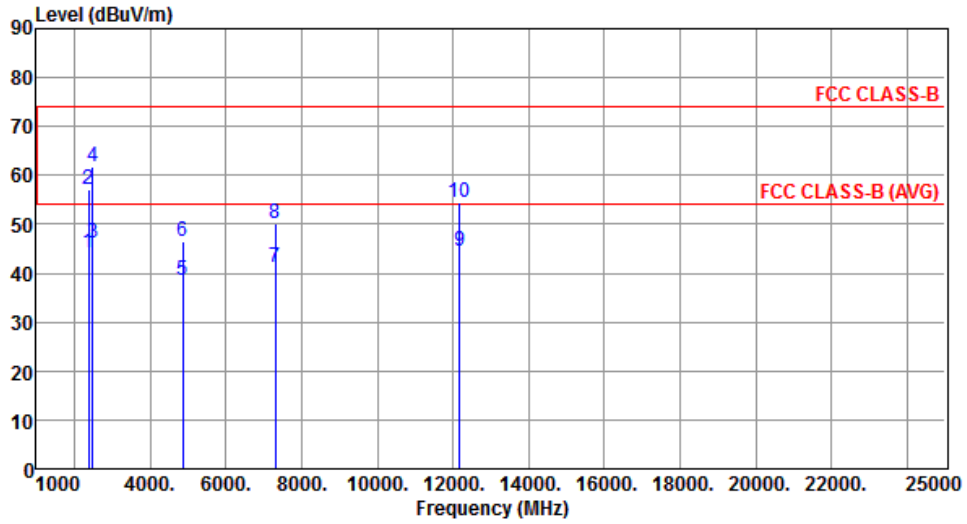

	Freq. MHz	Emission level dBuV/m	Limit dBuV/m	Margin dB	SA reading dBuV	Factor dB	Remark	ANT High cm	Turn Table deg
1	2385.00	44.04	54.00	-9.96	45.43	-1.39	Average	200	321
2	2385.00	57.24	74.00	-16.76	58.63	-1.39	Peak	200	321
3	2489.00	46.09	54.00	-7.91	47.10	-1.01	Average	258	88
4	2489.00	61.81	74.00	-12.19	62.82	-1.01	Peak	258	88
5	4874.00	38.55	54.00	-15.45	32.58	5.97	Average	233	114
6	4874.00	46.59	74.00	-27.41	40.62	5.97	Peak	233	114
7	7311.00	41.11	54.00	-12.89	30.36	10.75	Average	295	170
8	7311.00	50.23	74.00	-23.77	39.48	10.75	Peak	295	170
9	12185.00	44.50	54.00	-9.50	28.66	15.84	Average	293	207
10	12185.00	54.60	74.00	-19.40	38.76	15.84	Peak	293	207

Note 1: Emission Level (dBuV/m) = SA Reading (dBuV/m) + Factor* (dB)

*Factor includes antenna factor , cable loss and amplifier gain

Note 2: Margin (dB) = Emission level (dBuV/m) – Limit (dBuV/m).

Modulation	11b	Test Freq. (MHz)	2462
Polarization	Horizontal	Test Configuration	3

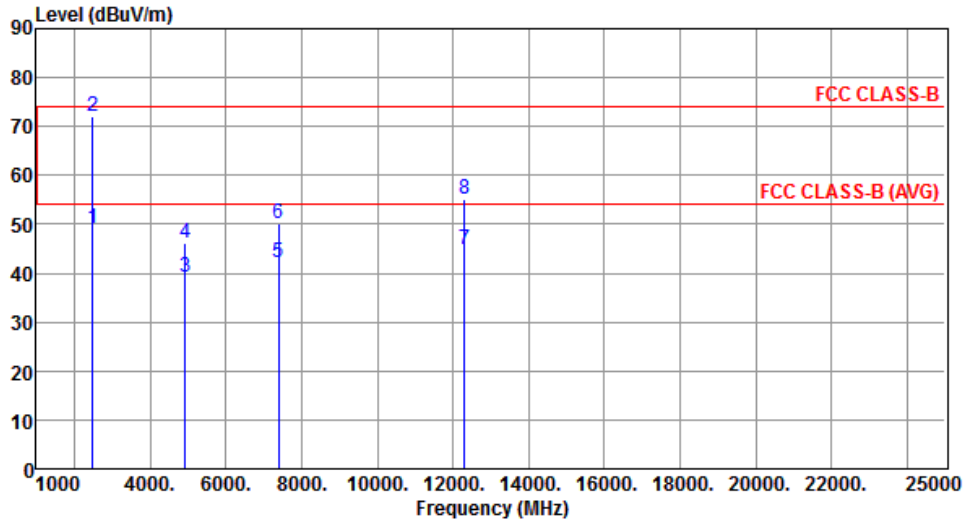

	Freq. MHz	Emission level dBuV/m	Limit dBuV/m	Margin dB	SA reading dBuV	Factor dB	Remark	ANT High cm	Turn Table deg
1	2483.50	49.06	54.00	-4.94	50.08	-1.02	Average	209	173
2	2483.50	72.13	74.00	-1.87	73.15	-1.02	Peak	209	173
3	4924.00	39.09	54.00	-14.91	33.08	6.01	Average	301	182
4	4924.00	46.33	74.00	-27.67	40.32	6.01	Peak	301	182
5	7386.00	42.08	54.00	-11.92	31.18	10.90	Average	224	190
6	7386.00	50.24	74.00	-23.76	39.34	10.90	Peak	224	190
7	12310.00	44.84	54.00	-9.16	29.14	15.70	Average	213	200
8	12310.00	55.14	74.00	-18.86	39.44	15.70	Peak	213	200

Note 1: Emission Level (dBuV/m) = SA Reading (dBuV/m) + Factor* (dB)

*Factor includes antenna factor , cable loss and amplifier gain

Note 2: Margin (dB) = Emission level (dBuV/m) – Limit (dBuV/m).

Modulation	11b	Test Freq. (MHz)	2462
Polarization	Vertical	Test Configuration	3

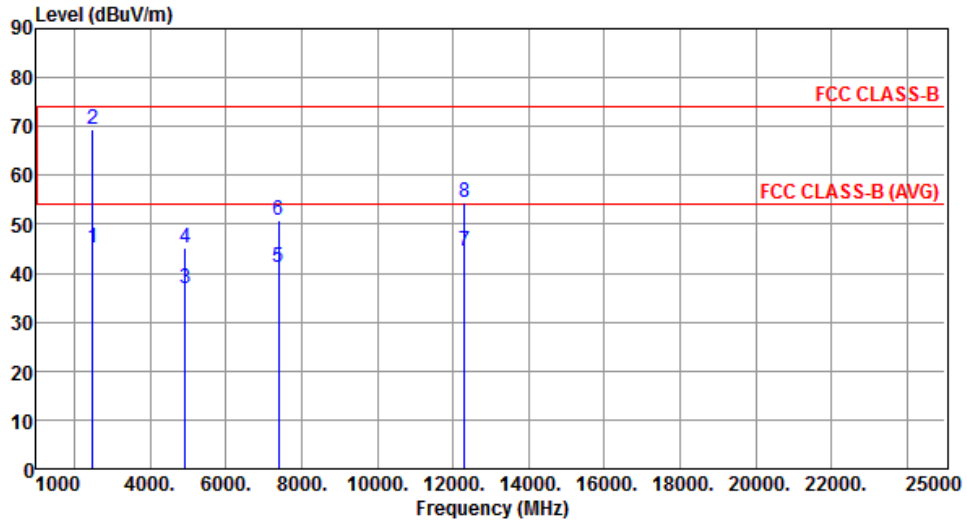

	Freq. MHz	Emission level dBuV/m	Limit dBuV/m	Margin dB	SA reading dBuV	Factor dB	Remark	ANT High cm	Turn Table deg
1	2483.50	45.24	54.00	-8.76	46.26	-1.02	Average	202	347
2	2483.50	69.42	74.00	-4.58	70.44	-1.02	Peak	202	347
3	4924.00	36.78	54.00	-17.22	30.77	6.01	Average	202	105
4	4924.00	45.22	74.00	-28.78	39.21	6.01	Peak	202	105
5	7386.00	41.09	54.00	-12.91	30.19	10.90	Average	311	180
6	7386.00	50.74	74.00	-23.26	39.84	10.90	Peak	311	180
7	12310.00	44.41	54.00	-9.59	28.71	15.70	Average	191	223
8	12310.00	54.33	74.00	-19.67	38.63	15.70	Peak	191	223

Note 1: Emission Level (dBuV/m) = SA Reading (dBuV/m) + Factor* (dB)

*Factor includes antenna factor , cable loss and amplifier gain

Note 2: Margin (dB) = Emission level (dBuV/m) – Limit (dBuV/m).

3.5.14 Transmitter Radiated Unwanted Emissions (Above 1GHz) for 11g

Modulation	11g	Test Freq. (MHz)	2412
Polarization	Horizontal	Test Configuration	3

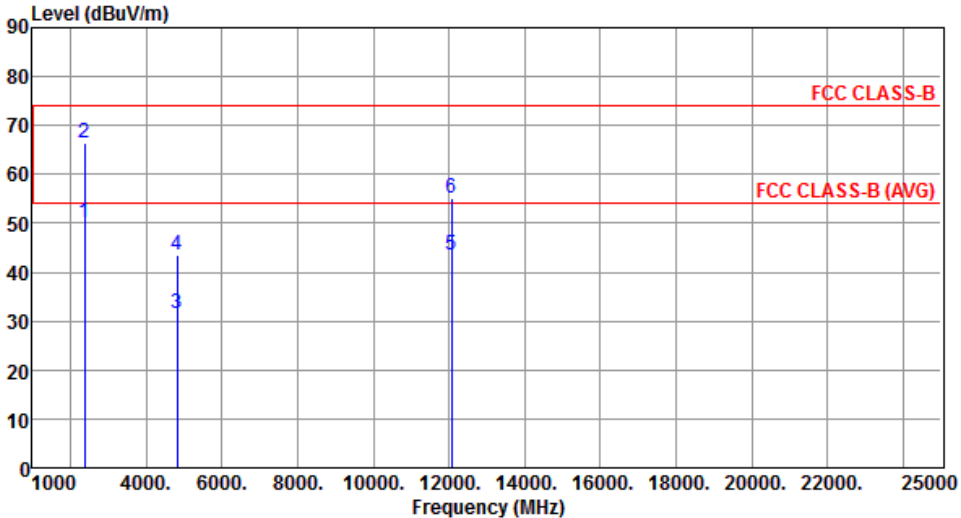

	Freq. MHz	Emission level dBuV/m	Limit dBuV/m	Margin dB	SA reading dBuV	Factor dB	Remark	ANT High cm	Turn Table deg
1	2390.00	50.24	54.00	-3.76	51.60	-1.36	Average	203	269
2	2390.00	66.33	74.00	-7.67	67.69	-1.36	Peak	203	269
3	4824.00	31.41	54.00	-22.59	25.47	5.94	Average	243	122
4	4824.00	43.60	74.00	-30.40	37.66	5.94	Peak	243	122
5	12060.00	43.67	54.00	-10.33	27.70	15.97	Average	236	164
6	12060.00	55.09	74.00	-18.91	39.12	15.97	Peak	236	164

Note 1: Emission Level (dBuV/m) = SA Reading (dBuV/m) + Factor* (dB)
*Factor includes antenna factor , cable loss and amplifier gain
Note 2: Margin (dB) = Emission level (dBuV/m) – Limit (dBuV/m).

Modulation	11g	Test Freq. (MHz)	2412
Polarization	Vertical	Test Configuration	3

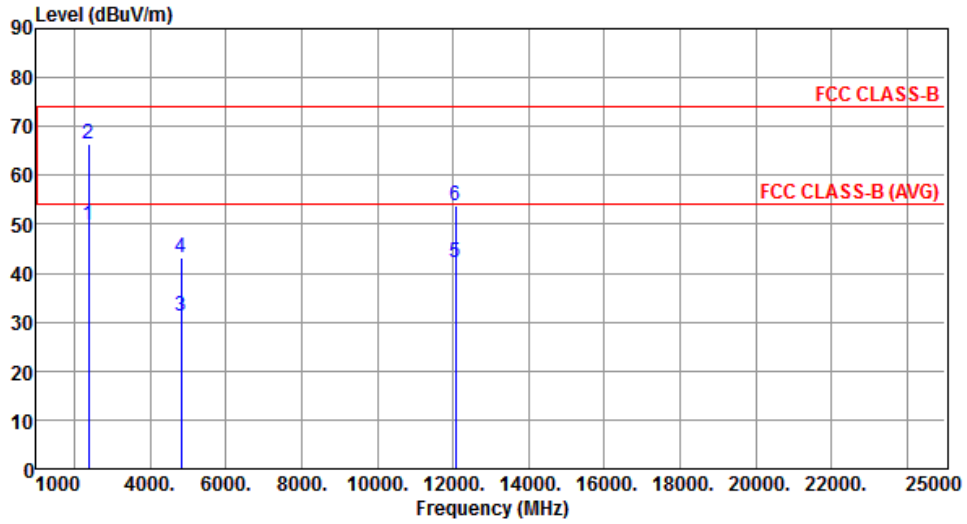

	Freq. MHz	Emission level dBuV/m	Limit dBuV/m	Margin dB	SA reading dBuV	Factor dB	Remark	ANT High cm	Turn Table deg
1	2390.00	49.95	54.00	-4.05	51.31	-1.36	Average	150	188
2	2390.00	66.39	74.00	-7.61	67.75	-1.36	Peak	150	188
3	4824.00	31.34	54.00	-22.66	25.40	5.94	Average	274	209
4	4824.00	43.29	74.00	-30.71	37.35	5.94	Peak	274	209
5	12060.00	42.33	54.00	-11.67	26.36	15.97	Average	318	109
6	12060.00	53.87	74.00	-20.13	37.90	15.97	Peak	318	109

Note 1: Emission Level (dBuV/m) = SA Reading (dBuV/m) + Factor* (dB)

*Factor includes antenna factor , cable loss and amplifier gain

Note 2: Margin (dB) = Emission level (dBuV/m) – Limit (dBuV/m).

Modulation	11g	Test Freq. (MHz)	2437
Polarization	Horizontal	Test Configuration	3

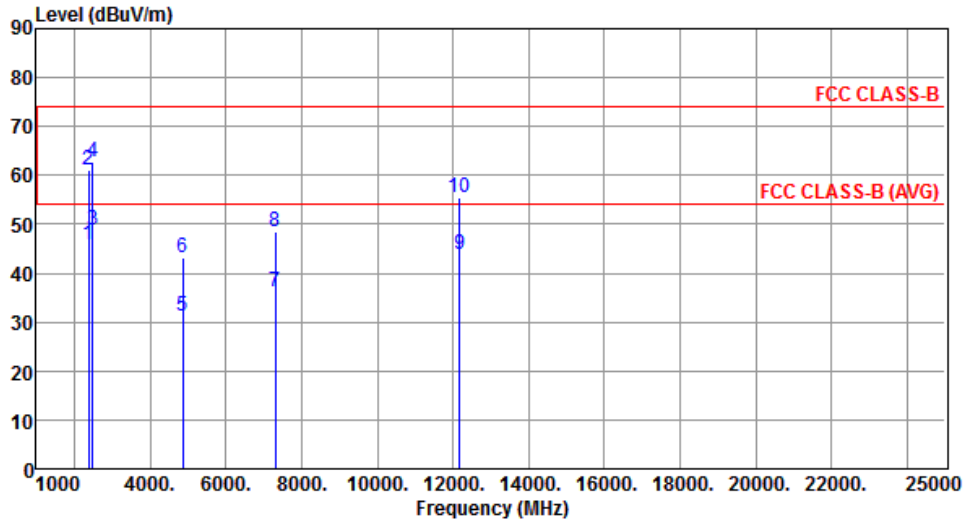

	Freq. MHz	Emission level dBuV/m	Limit dBuV/m	Margin dB	SA reading dBuV	Factor dB	Remark	ANT High cm	Turn Table deg
1	2390.00	45.84	54.00	-8.16	47.20	-1.36	Average	294	125
2	2390.00	61.01	74.00	-12.99	62.37	-1.36	Peak	294	125
3	2483.50	48.95	54.00	-5.05	49.97	-1.02	Average	294	125
4	2483.50	62.84	74.00	-11.16	63.86	-1.02	Peak	294	125
5	4874.00	31.13	54.00	-22.87	25.16	5.97	Average	257	127
6	4874.00	43.32	74.00	-30.68	37.35	5.97	Peak	257	127
7	7311.00	36.07	54.00	-17.93	25.32	10.75	Average	254	7
8	7311.00	48.65	74.00	-25.35	37.90	10.75	Peak	254	7
9	12185.00	43.86	54.00	-10.14	28.02	15.84	Average	232	166
10	12185.00	55.31	74.00	-18.69	39.47	15.84	Peak	232	166

Note 1: Emission Level (dBuV/m) = SA Reading (dBuV/m) + Factor* (dB)

*Factor includes antenna factor , cable loss and amplifier gain

Note 2: Margin (dB) = Emission level (dBuV/m) – Limit (dBuV/m).

Modulation	11g	Test Freq. (MHz)	2437
Polarization	Vertical	Test Configuration	3

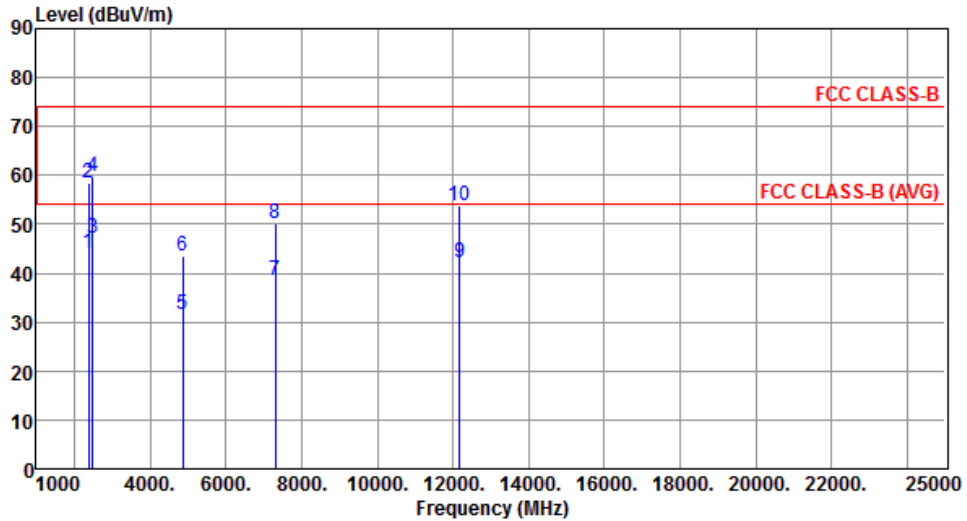

	Freq. MHz	Emission level dBuV/m	Limit dBuV/m	Margin dB	SA reading dBuV	Factor dB	Remark	ANT High cm	Turn Table deg
1	2390.00	44.32	54.00	-9.68	45.68	-1.36	Average	280	198
2	2390.00	58.60	74.00	-15.40	59.96	-1.36	Peak	280	198
3	2483.50	47.02	54.00	-6.98	48.04	-1.02	Average	280	198
4	2483.50	59.83	74.00	-14.17	60.85	-1.02	Peak	280	198
5	4874.00	31.55	54.00	-22.45	25.58	5.97	Average	273	203
6	4874.00	43.49	74.00	-30.51	37.52	5.97	Peak	273	203
7	7311.00	38.60	54.00	-15.40	27.85	10.75	Average	247	211
8	7311.00	50.22	74.00	-23.78	39.47	10.75	Peak	247	211
9	12185.00	42.11	54.00	-11.89	26.27	15.84	Average	317	107
10	12185.00	53.66	74.00	-20.34	37.82	15.84	Peak	317	107

Note 1: Emission Level (dBuV/m) = SA Reading (dBuV/m) + Factor* (dB)

*Factor includes antenna factor , cable loss and amplifier gain

Note 2: Margin (dB) = Emission level (dBuV/m) – Limit (dBuV/m).

Modulation	11g	Test Freq. (MHz)	2462
Polarization	Horizontal	Test Configuration	3

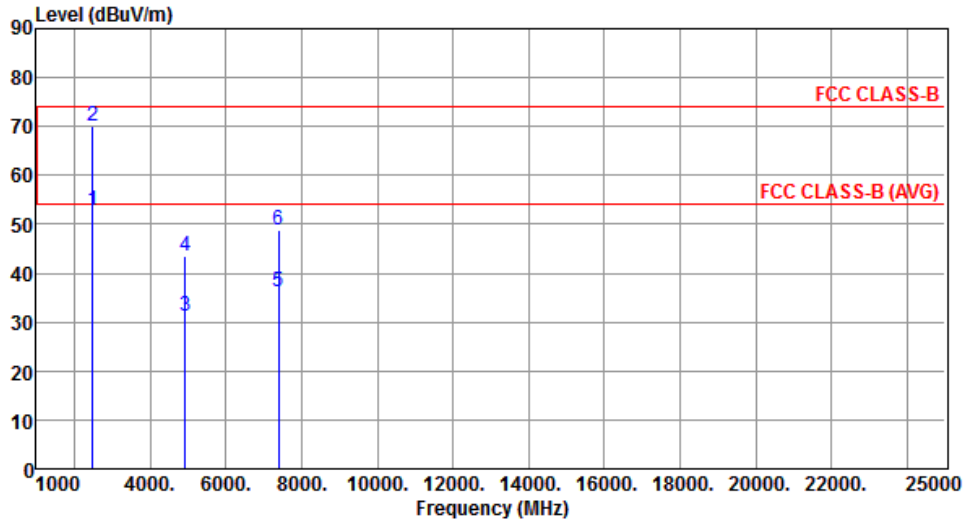

	Freq. MHz	Emission level dBuV/m	Limit dBuV/m	Margin dB	SA reading dBuV	Factor dB	Remark	ANT High cm	Turn Table deg
1	2483.50	52.83	54.00	-1.17	53.85	-1.02	Average	288	108
2	2483.50	70.05	74.00	-3.95	71.07	-1.02	Peak	288	108
3	4924.00	31.38	54.00	-22.62	25.37	6.01	Average	252	126
4	4924.00	43.45	74.00	-30.55	37.44	6.01	Peak	252	126
5	7386.00	36.30	54.00	-17.70	25.40	10.90	Average	259	11
6	7386.00	48.74	74.00	-25.26	37.84	10.90	Peak	259	11

Note 1: Emission Level (dBuV/m) = SA Reading (dBuV/m) + Factor* (dB)

*Factor includes antenna factor , cable loss and amplifier gain

Note 2: Margin (dB) = Emission level (dBuV/m) – Limit (dBuV/m).

Modulation	11g	Test Freq. (MHz)	2462
Polarization	Vertical	Test Configuration	3

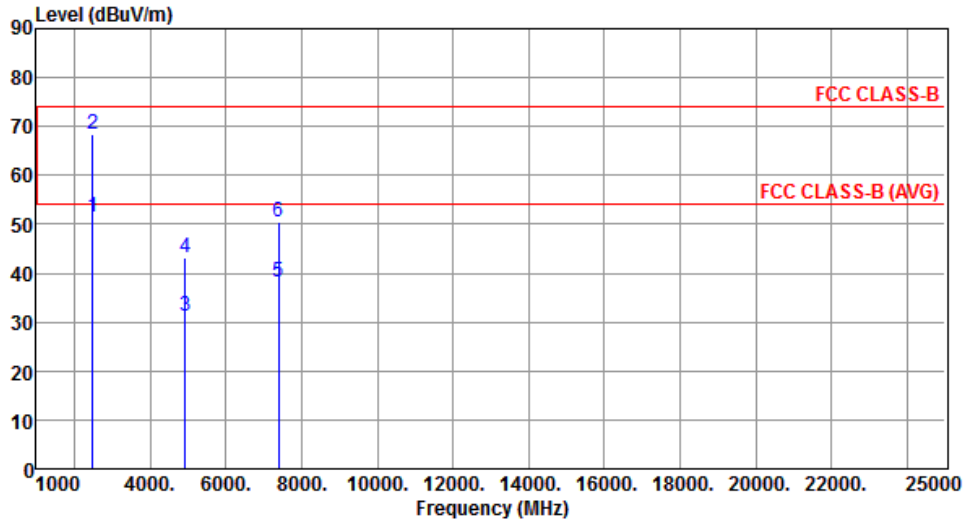

	Freq. MHz	Emission level dBuV/m	Limit dBuV/m	Margin dB	SA reading dBuV	Factor dB	Remark	ANT High cm	Turn Table deg
1	2483.50	51.39	54.00	-2.61	52.41	-1.02	Average	156	186
2	2483.50	68.55	74.00	-5.45	69.57	-1.02	Peak	156	186
3	4924.00	31.34	54.00	-22.66	25.33	6.01	Average	271	206
4	4924.00	43.28	74.00	-30.72	37.27	6.01	Peak	271	206
5	7386.00	38.31	54.00	-15.69	27.41	10.90	Average	242	219
6	7386.00	50.50	74.00	-23.50	39.60	10.90	Peak	242	219

Note 1: Emission Level (dBuV/m) = SA Reading (dBuV/m) + Factor* (dB)

*Factor includes antenna factor , cable loss and amplifier gain

Note 2: Margin (dB) = Emission level (dBuV/m) – Limit (dBuV/m).

3.5.15 Transmitter Radiated Unwanted Emissions (Above 1GHz) for HT20

Modulation	HT20	Test Freq. (MHz)	2412
Polarization	Horizontal	Test Configuration	3

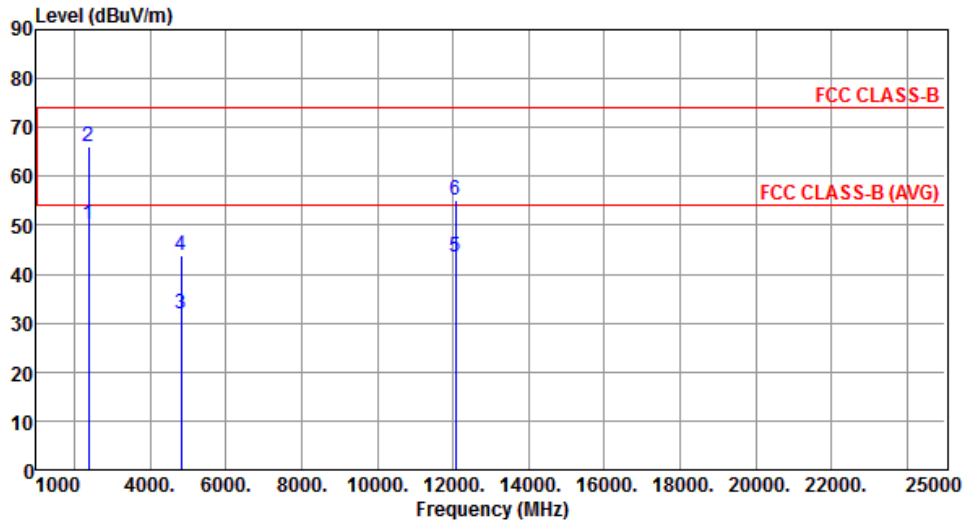

	Freq. MHz	Emission level dBuV/m	Limit dBuV/m	Margin dB	SA reading dBuV	Factor dB	Remark	ANT High cm	Turn Table deg
1	2390.00	50.30	54.00	-3.70	51.66	-1.36	Average	150	89
2	2390.00	66.04	74.00	-7.96	67.40	-1.36	Peak	150	89
3	4824.00	31.74	54.00	-22.26	25.80	5.94	Average	248	129
4	4824.00	43.90	74.00	-30.10	37.96	5.94	Peak	248	129
5	12060.00	43.52	54.00	-10.48	27.55	15.97	Average	233	162
6	12060.00	55.17	74.00	-18.83	39.20	15.97	Peak	233	162

Note 1: Emission Level (dBuV/m) = SA Reading (dBuV/m) + Factor* (dB)

*Factor includes antenna factor , cable loss and amplifier gain

Note 2: Margin (dB) = Emission level (dBuV/m) – Limit (dBuV/m).

Modulation	HT20	Test Freq. (MHz)	2412
Polarization	Vertical	Test Configuration	3

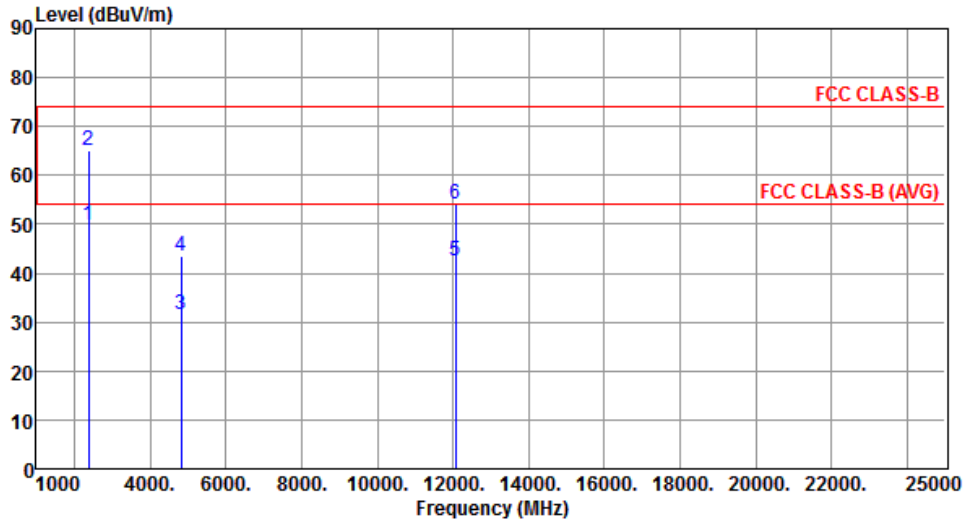

	Freq. MHz	Emission level dBuV/m	Limit dBuV/m	Margin dB	SA reading dBuV	Factor dB	Remark	ANT High cm	Turn Table deg
1	2390.00	49.86	54.00	-4.14	51.22	-1.36	Average	189	189
2	2390.00	64.95	74.00	-9.05	66.31	-1.36	Peak	189	189
3	4824.00	31.49	54.00	-22.51	25.55	5.94	Average	262	201
4	4824.00	43.52	74.00	-30.48	37.58	5.94	Peak	262	201
5	12060.00	42.49	54.00	-11.51	26.52	15.97	Average	315	102
6	12060.00	53.98	74.00	-20.02	38.01	15.97	Peak	315	102

Note 1: Emission Level (dBuV/m) = SA Reading (dBuV/m) + Factor* (dB)

*Factor includes antenna factor , cable loss and amplifier gain

Note 2: Margin (dB) = Emission level (dBuV/m) – Limit (dBuV/m).

Modulation	HT20	Test Freq. (MHz)	2437
Polarization	Horizontal	Test Configuration	3

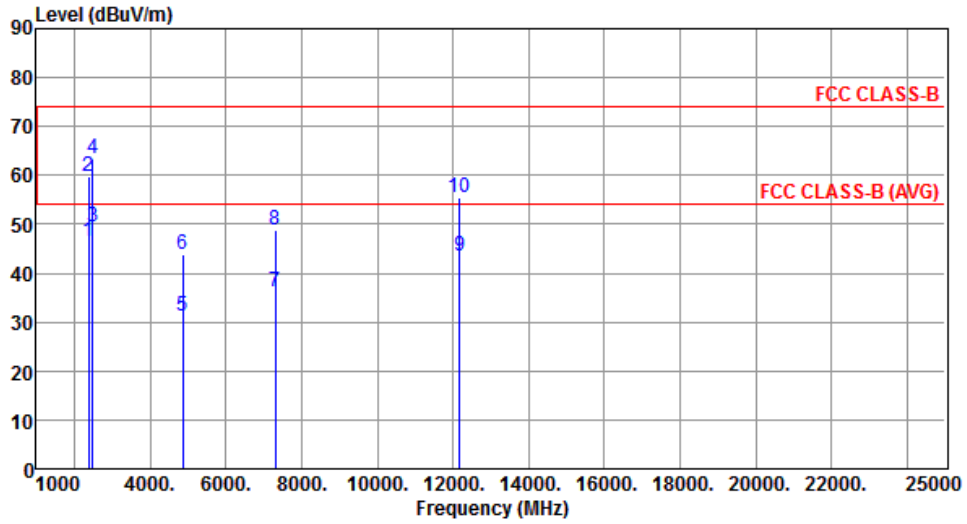

	Freq. MHz	Emission level dBuV/m	Limit dBuV/m	Margin dB	SA reading dBuV	Factor dB	Remark	ANT High cm	Turn Table deg
1	2390.00	46.53	54.00	-7.47	47.89	-1.36	Average	150	105
2	2390.00	59.72	74.00	-14.28	61.08	-1.36	Peak	150	105
3	2483.50	49.56	54.00	-4.44	50.58	-1.02	Average	150	105
4	2483.50	63.48	74.00	-10.52	64.50	-1.02	Peak	150	105
5	4874.00	31.35	54.00	-22.65	25.38	5.97	Average	251	122
6	4874.00	43.70	74.00	-30.30	37.73	5.97	Peak	251	122
7	7311.00	36.30	54.00	-17.70	25.55	10.75	Average	250	15
8	7311.00	48.75	74.00	-25.25	38.00	10.75	Peak	250	15
9	12185.00	43.62	54.00	-10.38	27.78	15.84	Average	236	164
10	12185.00	55.60	74.00	-18.40	39.76	15.84	Peak	236	164

Note 1: Emission Level (dBuV/m) = SA Reading (dBuV/m) + Factor* (dB)

*Factor includes antenna factor , cable loss and amplifier gain

Note 2: Margin (dB) = Emission level (dBuV/m) – Limit (dBuV/m).

Modulation	HT20	Test Freq. (MHz)	2437
Polarization	Vertical	Test Configuration	3

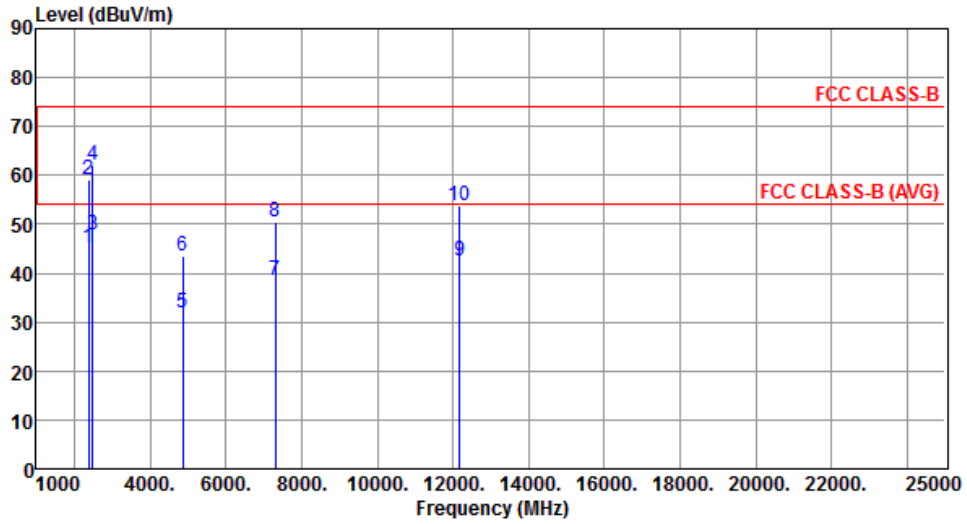

	Freq. MHz	Emission level dBuV/m	Limit dBuV/m	Margin dB	SA reading dBuV	Factor dB	Remark	ANT High cm	Turn Table deg
1	2390.00	45.07	54.00	-8.93	46.43	-1.36	Average	165	186
2	2390.00	59.17	74.00	-14.83	60.53	-1.36	Peak	165	186
3	2483.50	47.87	54.00	-6.13	48.89	-1.02	Average	165	186
4	2483.50	61.98	74.00	-12.02	63.00	-1.02	Peak	165	186
5	4874.00	31.86	54.00	-22.14	25.89	5.97	Average	279	206
6	4874.00	43.55	74.00	-30.45	37.58	5.97	Peak	279	206
7	7311.00	38.43	54.00	-15.57	27.68	10.75	Average	245	204
8	7311.00	50.48	74.00	-23.52	39.73	10.75	Peak	245	204
9	12185.00	42.43	54.00	-11.57	26.59	15.84	Average	315	102
10	12185.00	53.74	74.00	-20.26	37.90	15.84	Peak	315	102

Note 1: Emission Level (dBuV/m) = SA Reading (dBuV/m) + Factor* (dB)

*Factor includes antenna factor , cable loss and amplifier gain

Note 2: Margin (dB) = Emission level (dBuV/m) – Limit (dBuV/m).

Modulation	HT20	Test Freq. (MHz)	2462
Polarization	Horizontal	Test Configuration	3

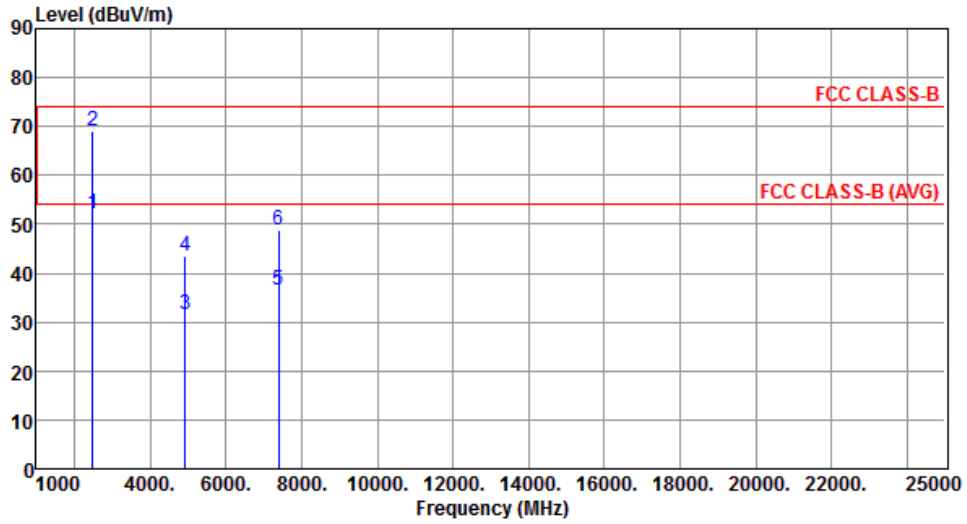

	Freq. MHz	Emission level dBuV/m	Limit dBuV/m	Margin dB	SA reading dBuV	Factor dB	Remark	ANT High cm	Turn Table deg
1	2483.50	52.13	54.00	-1.87	53.15	-1.02	Average	253	19
2	2483.50	69.12	74.00	-4.88	70.14	-1.02	Peak	253	19
3	4924.00	31.47	54.00	-22.53	25.46	6.01	Average	258	122
4	4924.00	43.63	74.00	-30.37	37.62	6.01	Peak	258	122
5	7386.00	36.42	54.00	-17.58	25.52	10.90	Average	253	19
6	7386.00	48.85	74.00	-25.15	37.95	10.90	Peak	253	19

Note 1: Emission Level (dBuV/m) = SA Reading (dBuV/m) + Factor* (dB)

*Factor includes antenna factor , cable loss and amplifier gain

Note 2: Margin (dB) = Emission level (dBuV/m) – Limit (dBuV/m).

Modulation	HT20	Test Freq. (MHz)	2462
Polarization	Vertical	Test Configuration	3

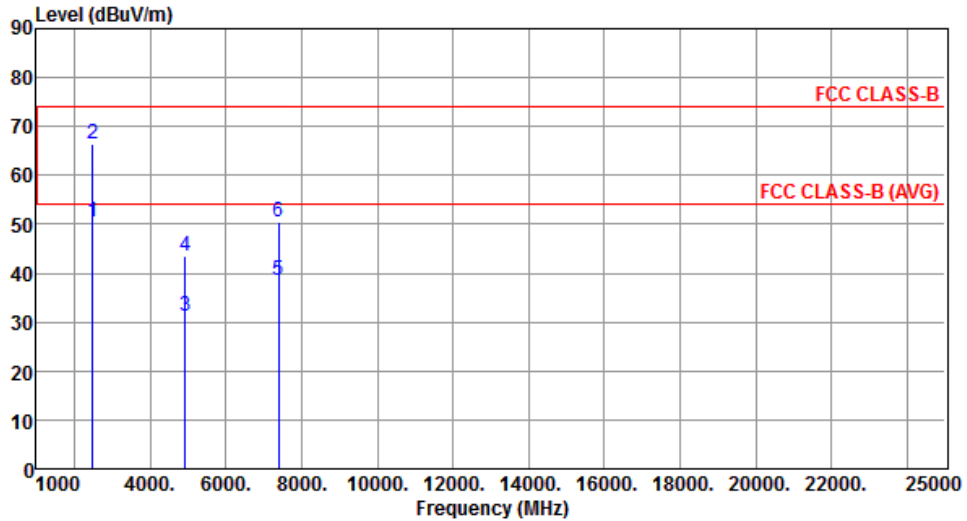

	Freq. MHz	Emission level dBuV/m	Limit dBuV/m	Margin dB	SA reading dBuV	Factor dB	Remark	ANT High cm	Turn Table deg
1	2483.50	50.50	54.00	-3.50	51.52	-1.02	Average	181	185
2	2483.50	66.41	74.00	-7.59	67.43	-1.02	Peak	181	185
3	4924.00	31.28	54.00	-22.72	25.27	6.01	Average	278	202
4	4924.00	43.39	74.00	-30.61	37.38	6.01	Peak	278	202
5	7386.00	38.46	54.00	-15.54	27.56	10.90	Average	235	213
6	7386.00	50.32	74.00	-23.68	39.42	10.90	Peak	235	213

Note 1: Emission Level (dBuV/m) = SA Reading (dBuV/m) + Factor* (dB)

*Factor includes antenna factor , cable loss and amplifier gain

Note 2: Margin (dB) = Emission level (dBuV/m) – Limit (dBuV/m).

3.6 Emissions in Non-Restricted Frequency Bands

3.6.1 Emissions in Non-Restricted Frequency Bands Limit

Peak power in any 100 kHz bandwidth outside of the authorized frequency band shall be attenuated by at least 20 dB relative to the maximum in-band peak PSD level in 100 kHz

3.6.2 Measuring Instruments

Refer a test equipment and calibration data table in this test report.

3.6.3 Test Procedures

Reference level measurement

1. Set RBW=100kHz, VBW = 300kHz , Detector = Peak, Sweep time = Auto
2. Trace = max hold , Allow Trace to fully stabilize
3. Use the peak marker function to determine the maximum PSD level

Emission level measurement

1. Set RBW=100kHz, VBW = 300kHz , Detector = Peak, Sweep time = Auto
2. Trace = max hold , Allow Trace to fully stabilize
3. Scan Frequency range is up to 25GHz
4. Use the peak marker function to determine the maximum amplitude level

3.6.4 Test Setup

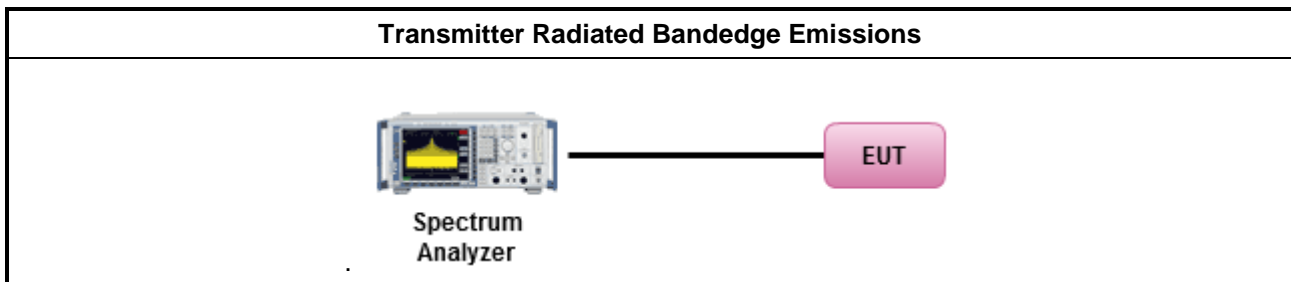

3.6.5 Test Result of Emissions in non-restricted frequency bands

This test item is performed on each TX output individually without summing or adding $10 \log(N_{ANT})$ since measurements are made relative to the in-band emissions on the individual outputs. Only worst test result of each operating mode is presented.

3.6.6 Unwanted Emissions into Non-Restricted Frequency Bands

802.11b

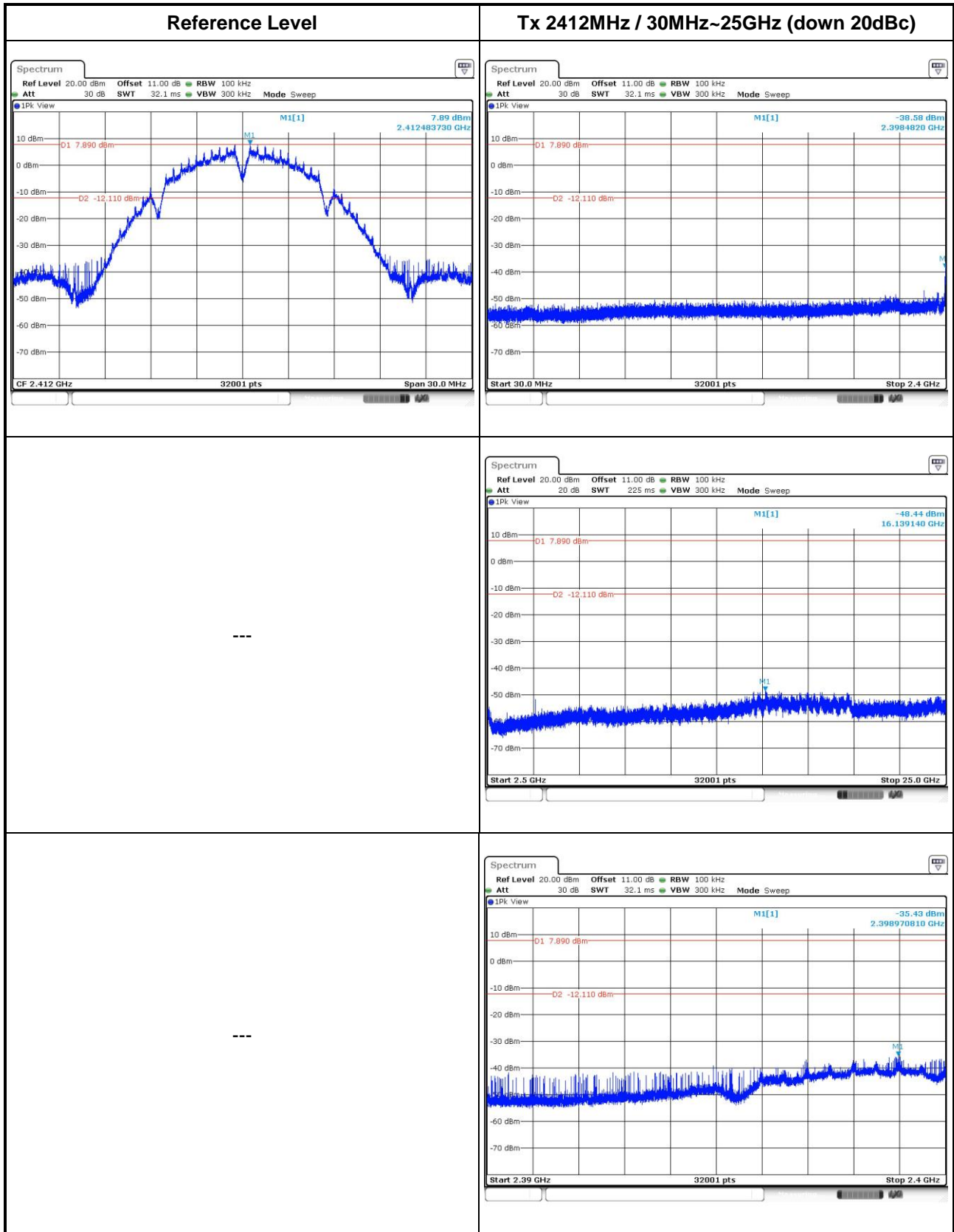

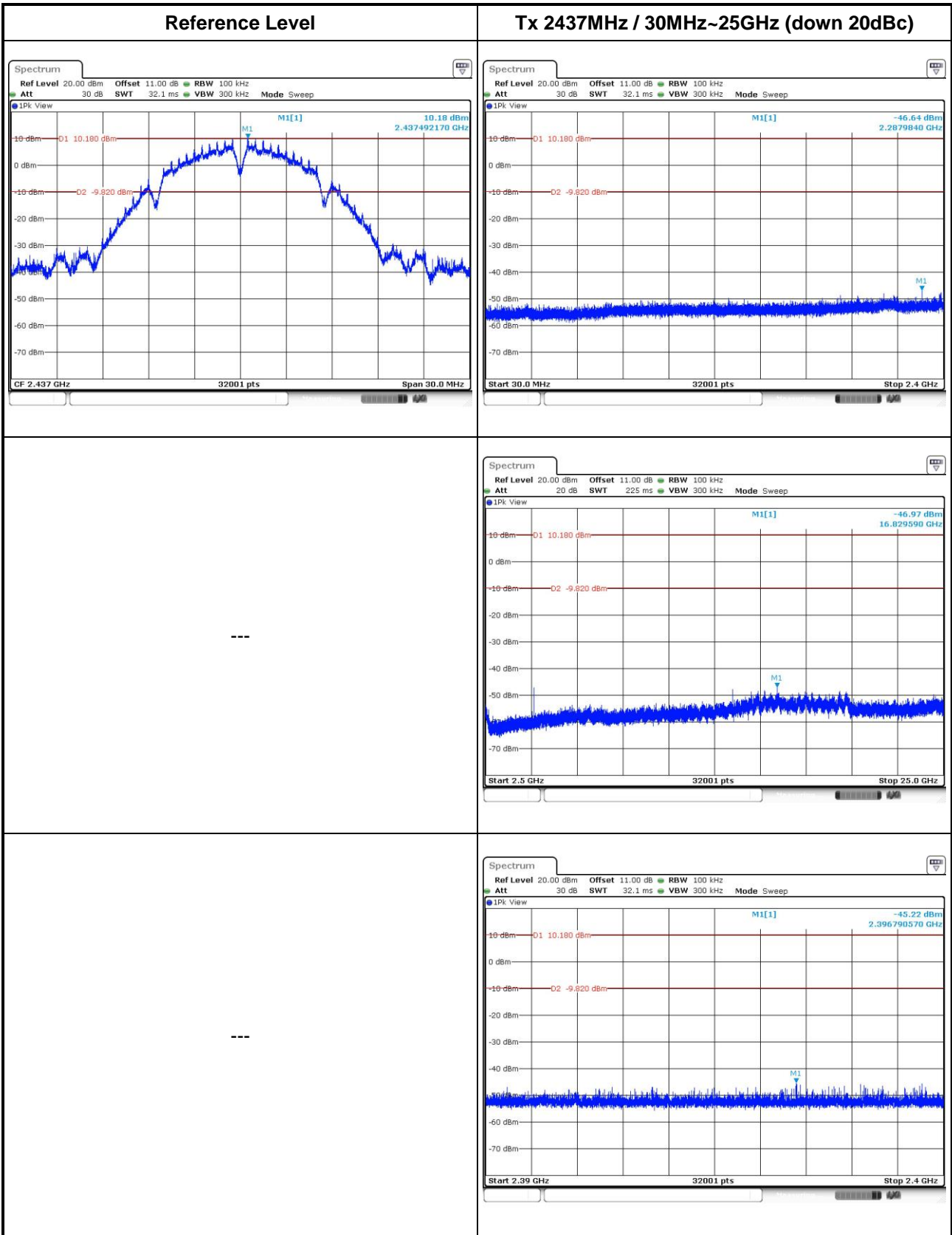

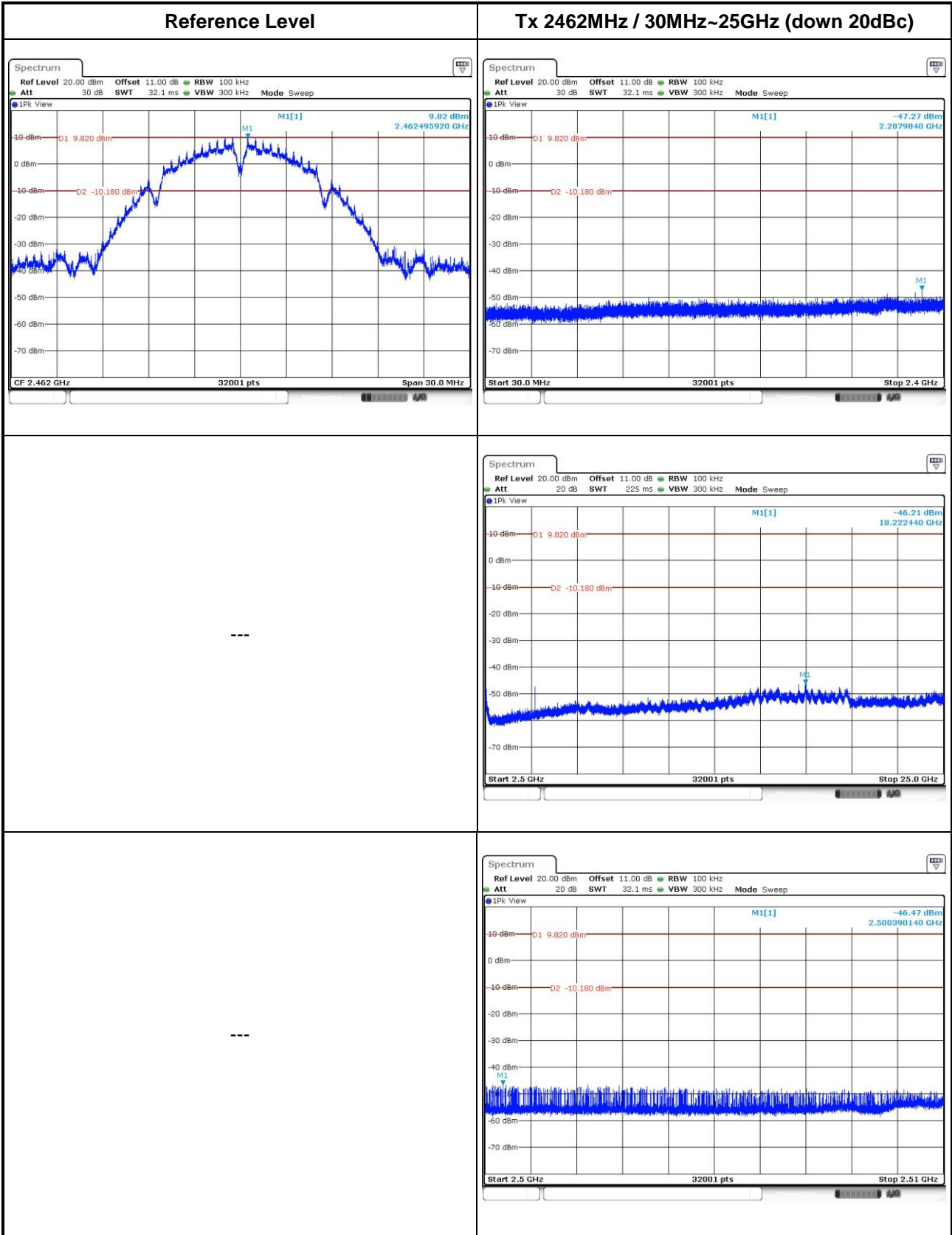

802.11g

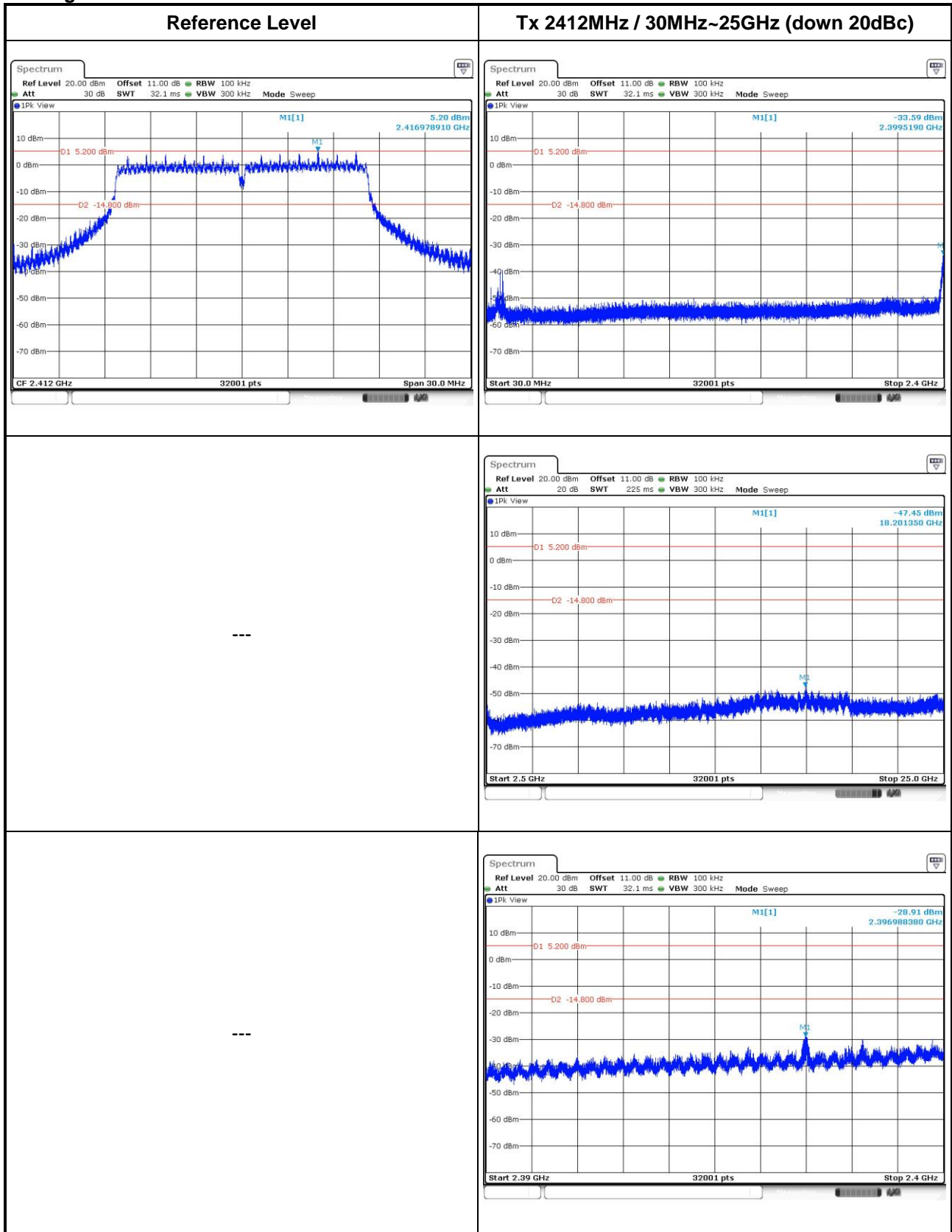

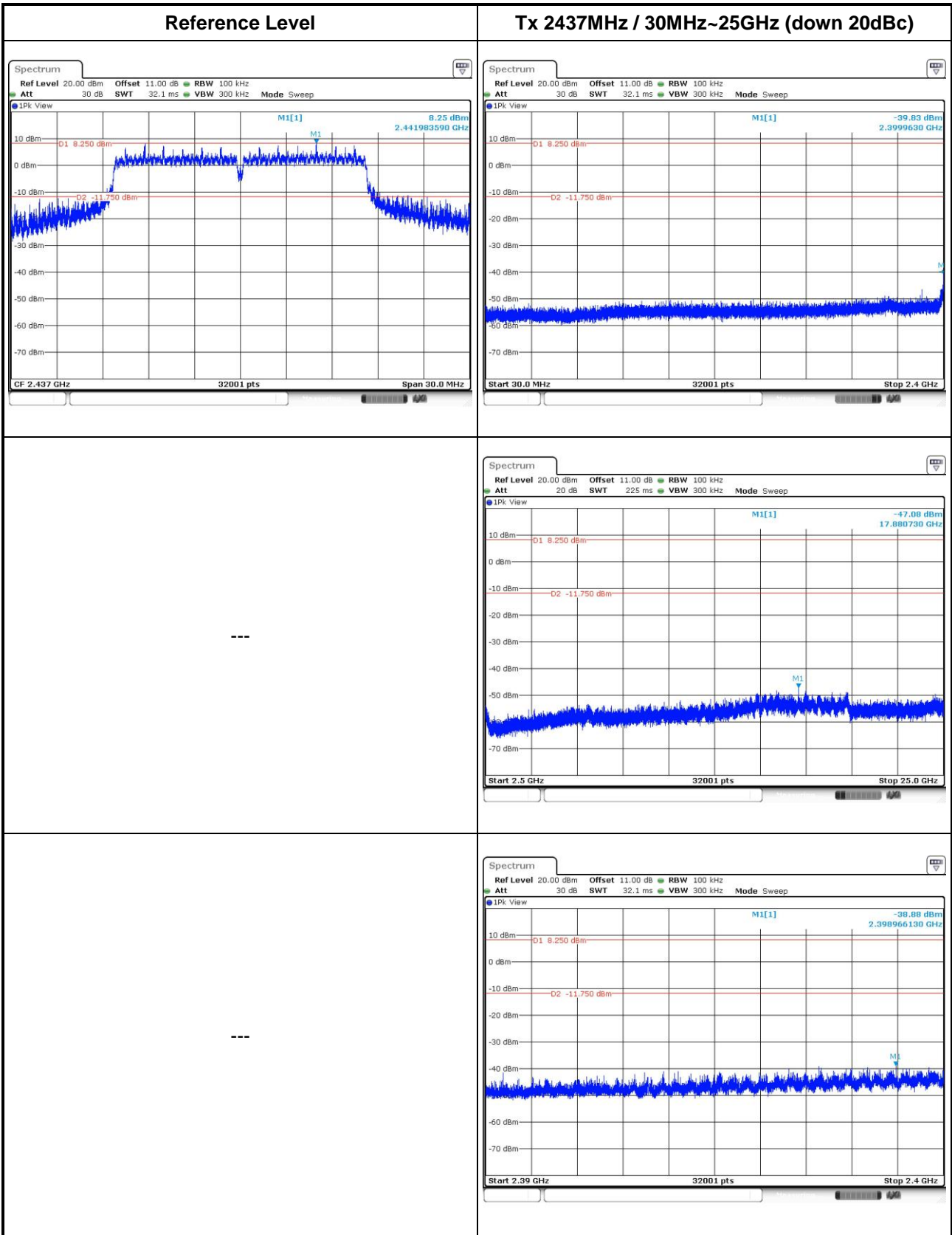

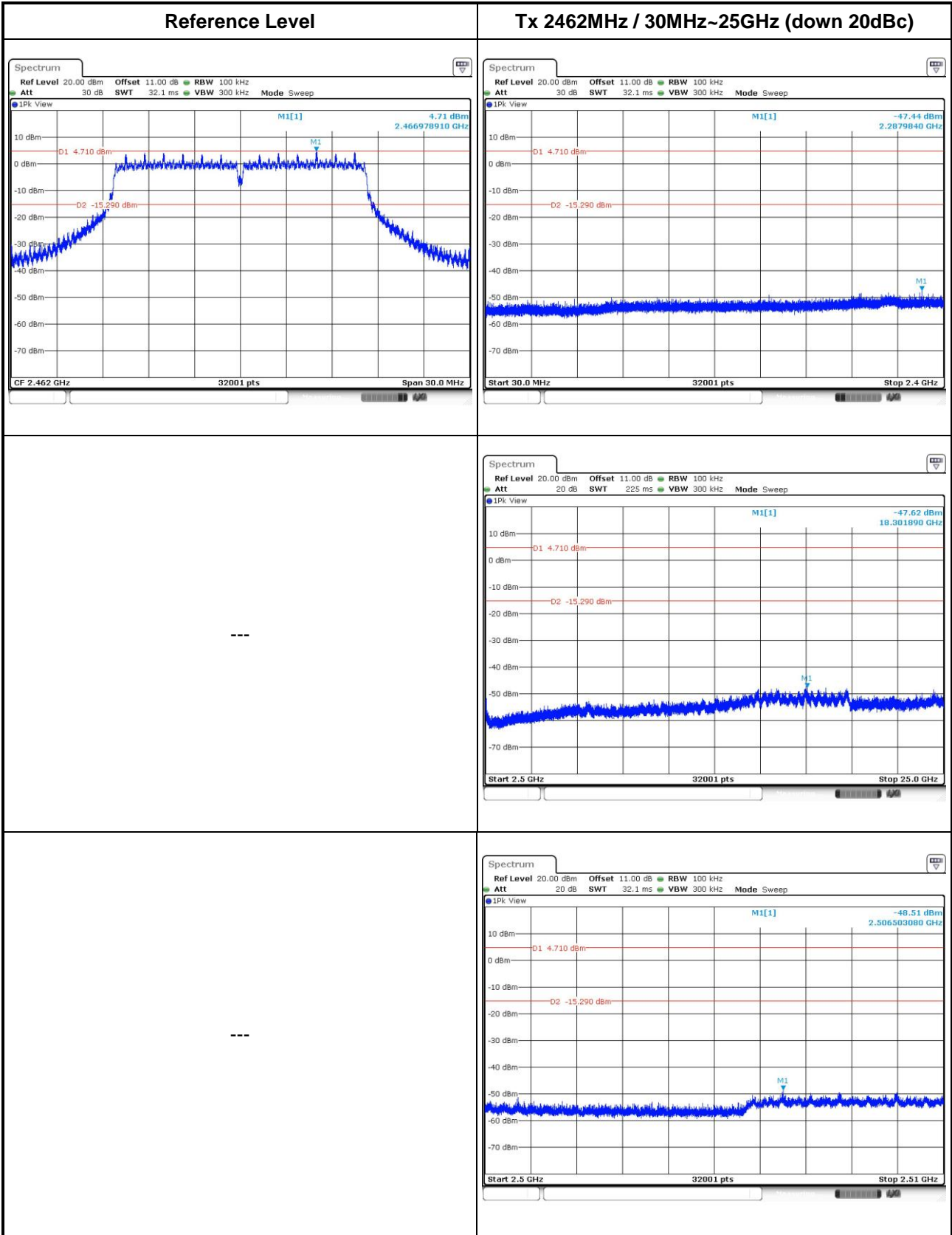

802.11n HT20

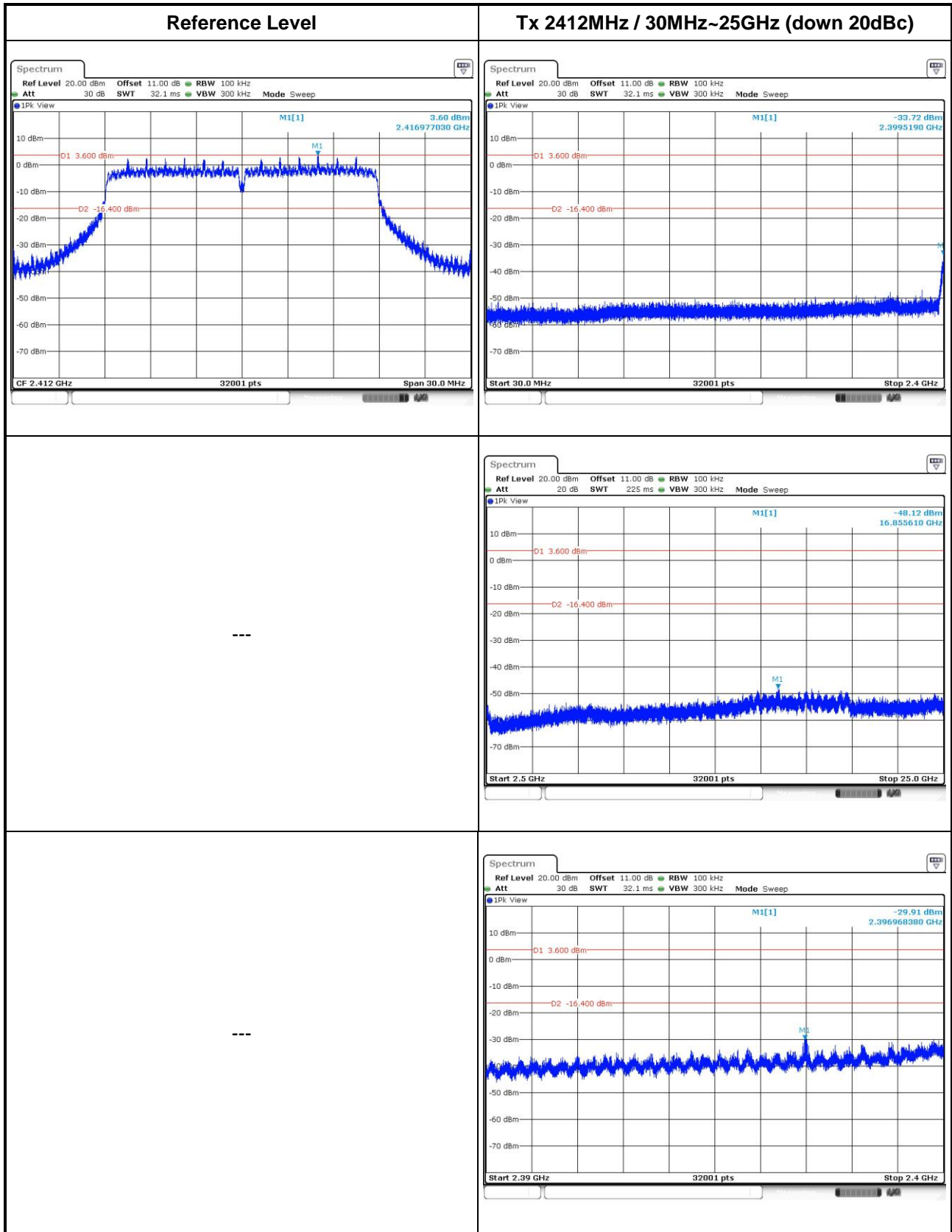

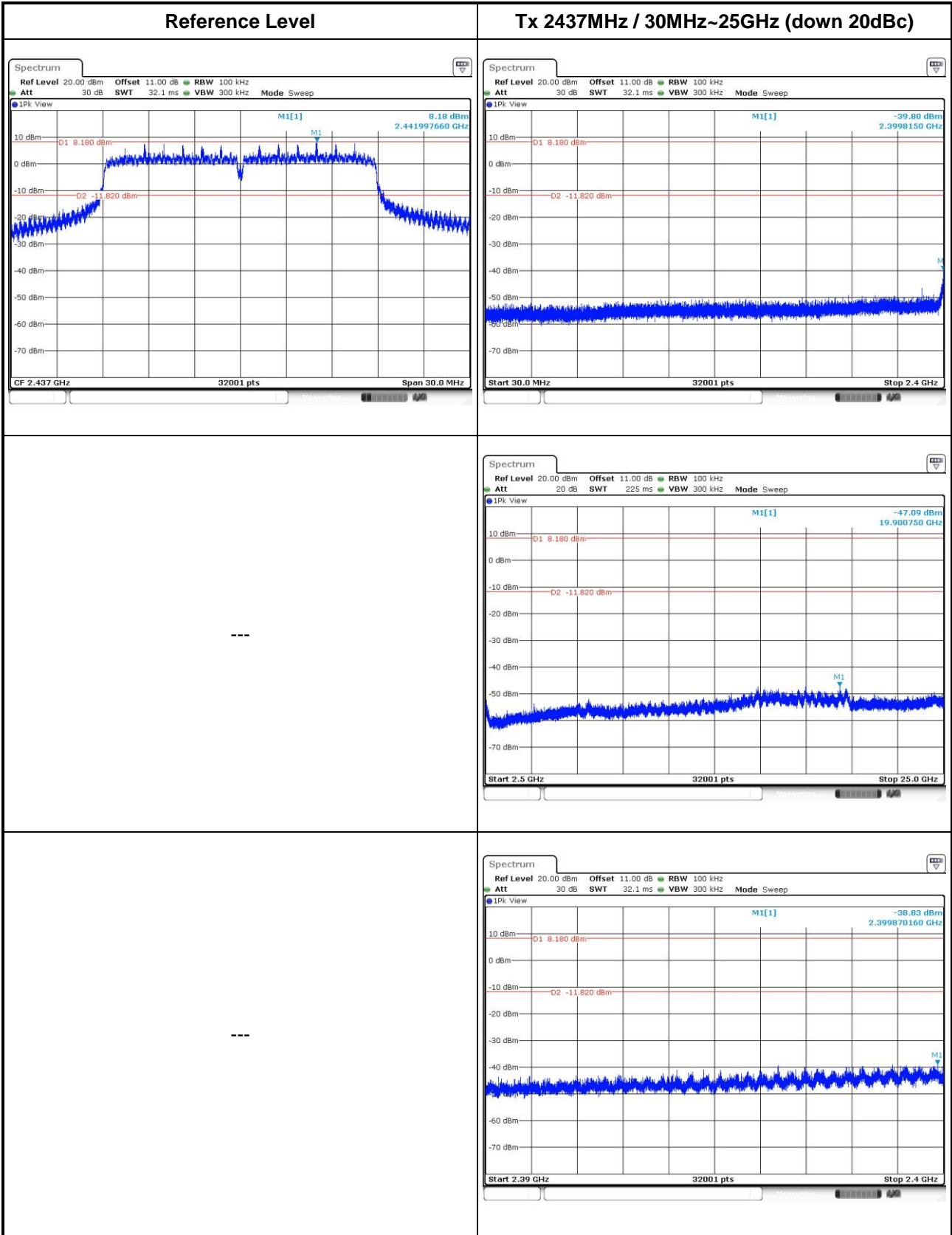

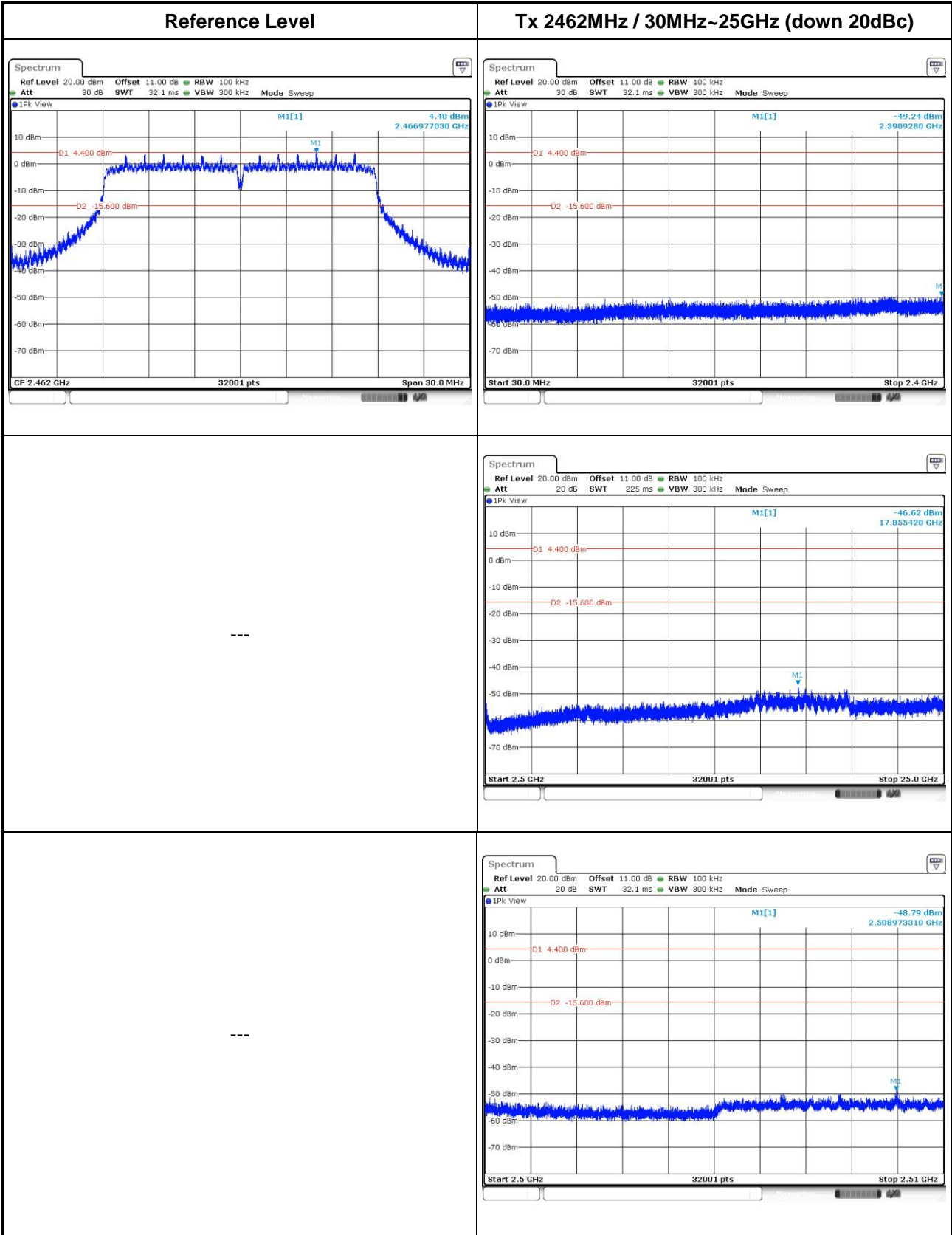

4 Test laboratory information

Established in 2012, ICC provides foremost EMC & RF Testing and advisory consultation services by our skilled engineers and technicians. Our services employ a wide variety of advanced edge test equipment and one of the widest certification extents in the business.

International Certification Corp, it is our definitive objective is to institute long term, trust-based associations with our clients. The expectation we set up with our clients is based on outstanding service, practical expertise and devotion to a certified value structure. Our passion is to grant our clients with best EMC / RF services by oriented knowledgeable and accommodating staff.

Our Test sites are located at Linkou District and Kwei Shan Hsiang. Location map can be found on our website <http://www.icertifi.com.tw>.

Linkou

Tel: 886-2-2601-1640

No. 30-2, Ding Fwu Tsuen, Lin Kou
District, New Taipei City, Taiwan,
R.O.C.

Kwei Shan

Tel: 886-3-271-8666

No. 3-1, Lane 6, Wen San 3rd
St., Kwei Shan Hsiang, Tao Yuan
Hsien 333, Taiwan, R.O.C.

Kwei Shan Site II

Tel: 886-3-271-8640

No. 14-1, Lane 19, Wen San 3rd
St., Kwei Shan Hsiang, Tao Yuan
Hsien 333, Taiwan, R.O.C.

If you have any suggestion, please feel free to contact us as below information

Tel: 886-3-271-8666

Fax: 886-3-318-0155

Email: ICC_Service@icertifi.com.tw

==END==