

# AD1608 Series [Preliminary]

## Multilayer Chip Antenna

### Features

- ❖ Monolithic SMD with small, low-profile and light-weight type.
- ❖ Wide bandwidth
- ❖ RoHS compliant

### Applications

- ❖ Dual-band 2.4/5.5 GHz WLAN

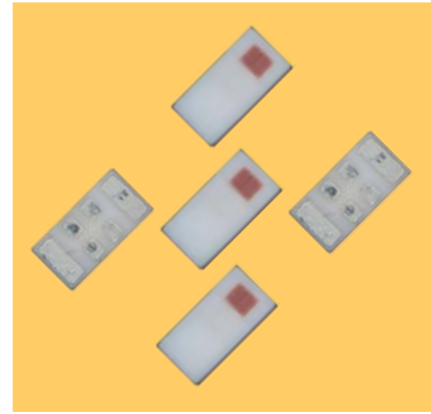

### Specifications

Part Number	Frequency Range (MHz)	Peak Gain (dBi typ.)	Average Gain (dBi typ.)	VSWR	Impedance
AD1608 -A2455AA_	2400~2480	1.0(XZ-Total)	-3.5(XZ-Total)	6.5 max.	50 Ω
	5150~5850	4.0(XZ-Total)	-2.5(XZ-Total)	4.5 max.	50 Ω

Q'ty/Reel (pcs) : 4,000 pcs  
 Operating Temperature Range : -40 ~ +85 °C  
 Storage Temperature Range : -40 ~ +85 °C  
 Storage Period : 12 months max.  
 Power Capacity : 2W max.

### Part Number

AD   1608   -   A   2455   AA   □   □  
 ①   ②   ③   ④   ⑤   ⑥   ⑦

① Type	AD : Dual-band Antenna	② Dimensions ( L x W )	1.6x 0.8 mm
③ Material Code	A	④ Frequency Range	2455=2400/5500 MHz
⑤ Specification Code	AA	⑥ Packaging	T: Tape & Reel B: Bulk
⑦ Soldering	/LF=lead-free		

### Terminal Configuration

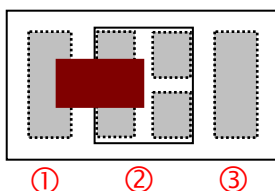

No.	Terminal Name	No.	Terminal Name
①	GND	③	NC
②	Feeding Point		

## Dimensions

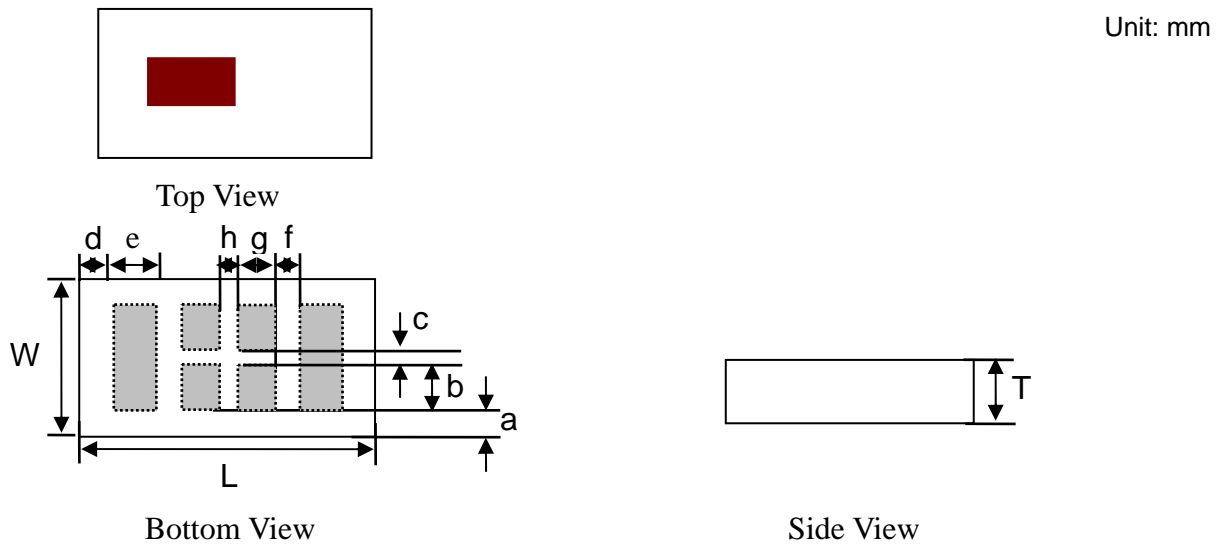

Mark	L	W	T	a	b	c	d	e	f	g	h
Dimensions	1.6	0.8	0.4	0.086	0.208	0.2	0.085	0.215	0.25	0.15	0.2
	$\pm 0.1$	$\pm 0.1$	max	$\pm 0.1$	min	$\pm 0.03$	$\pm 0.03$	$\pm 0.05$	$\pm 0.05$	min	$\pm 0.03$

## Typical Electrical Characteristics (T=25°C)

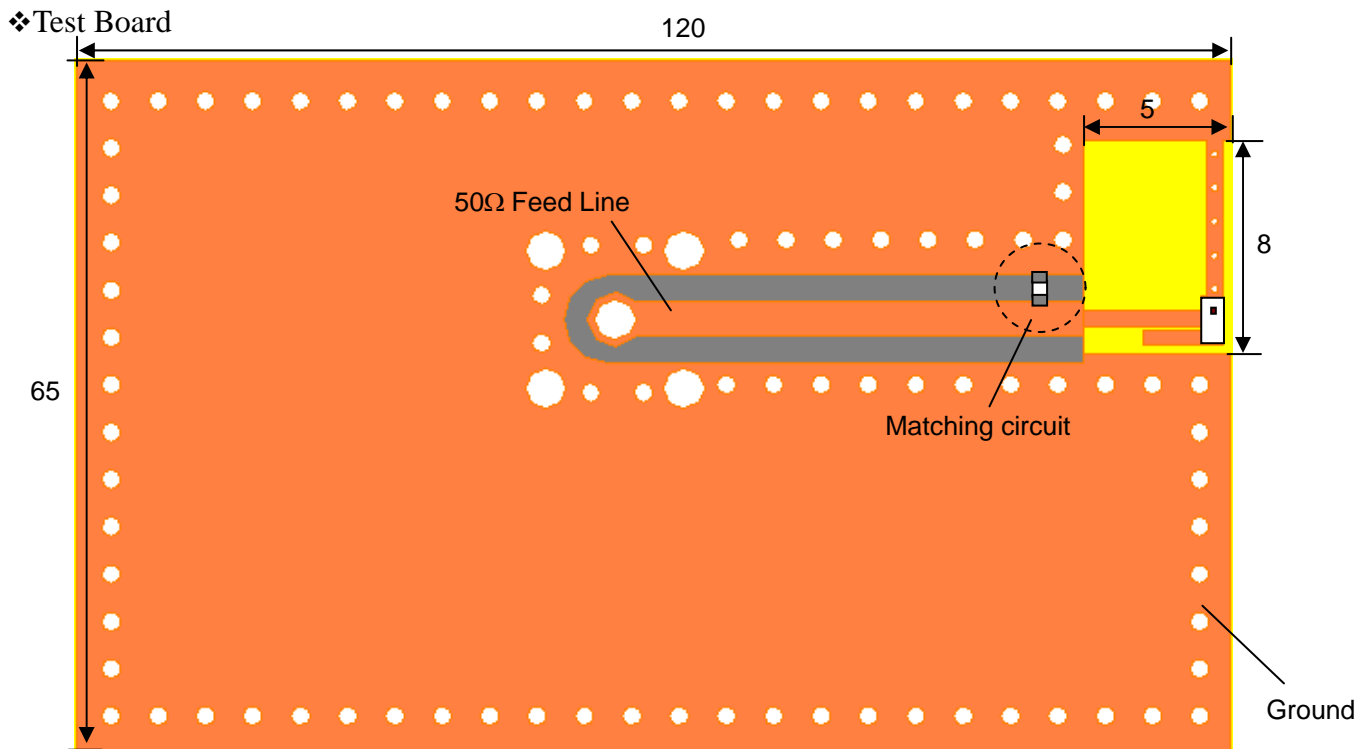

\*Line width should be designed to match 50Ω characteristic impedance, depending on PCB material and thickness.

❖ Antenna Footprint with matching \_top view (Unit in mm)

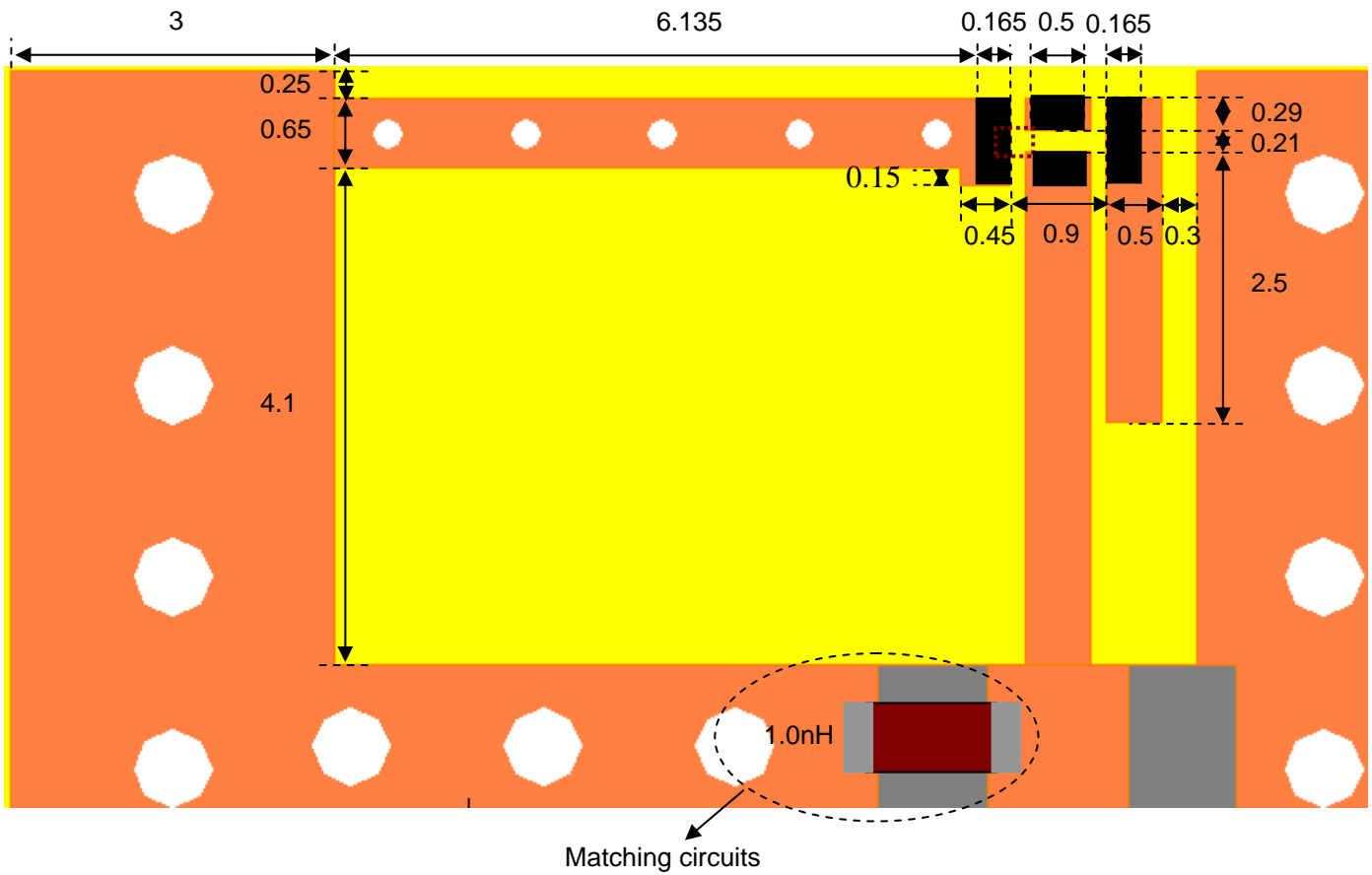

❖ Antenna Footprint with matching \_bottom view (Unit in mm)

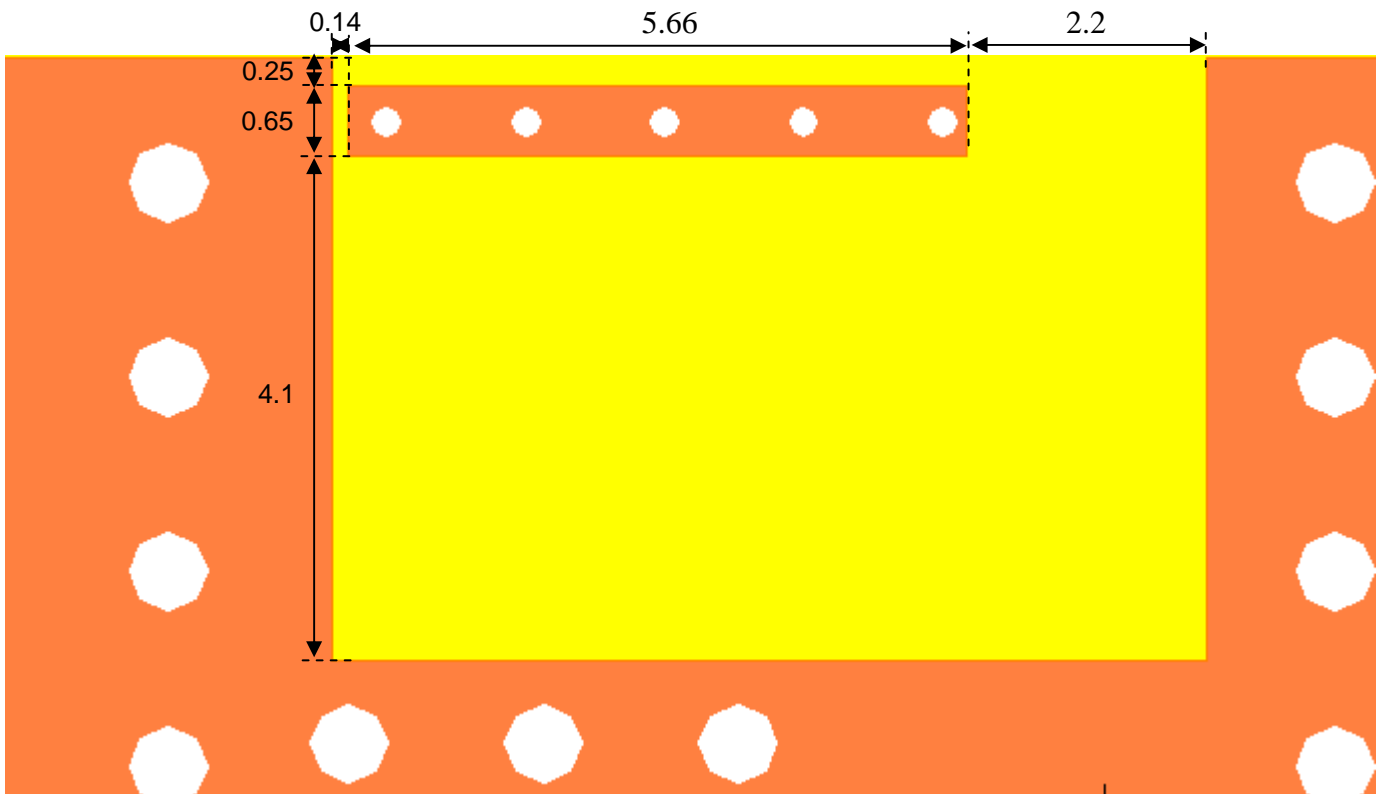

❖ Return Loss (with matching)

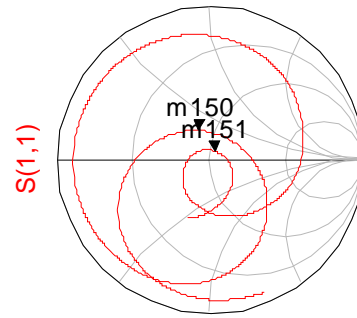
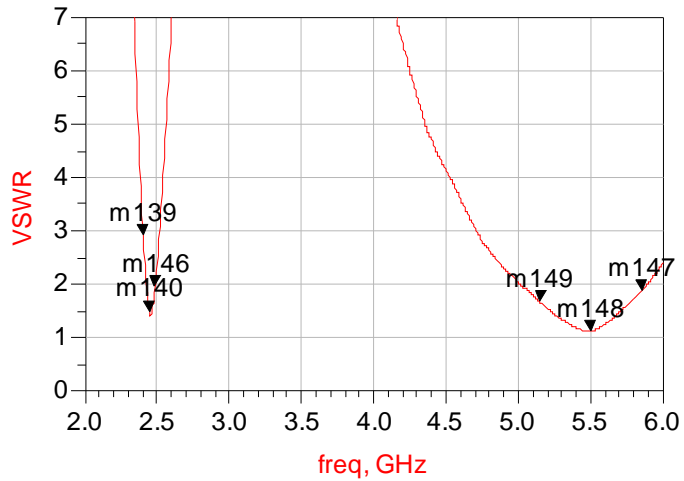

freq (2.000GHz to 6.000GHz)

m150  
freq=2.442GHz  
S(1,1)=0.199 / 110.889  
impedance = 40.626 + j15.755

m151  
freq=5.500GHz  
S(1,1)=0.059 / 59.150  
impedance = 52.817 + j5.324

m139 freq=2.400GHz VSWR=2.919	m140 freq=2.442GHz VSWR=1.498	m146 freq=2.484GHz VSWR=1.944
m149 freq=5.150GHz VSWR=1.664	m148 freq=5.500GHz VSWR=1.124	m147 freq=5.850GHz VSWR=1.876

❖ Radiation Patterns @ 2.44GHz

(Antenna Efficiency 42% @ 2.4GHz ; 60% @ 2.44GHz ; 56% @ 2.48GHz)

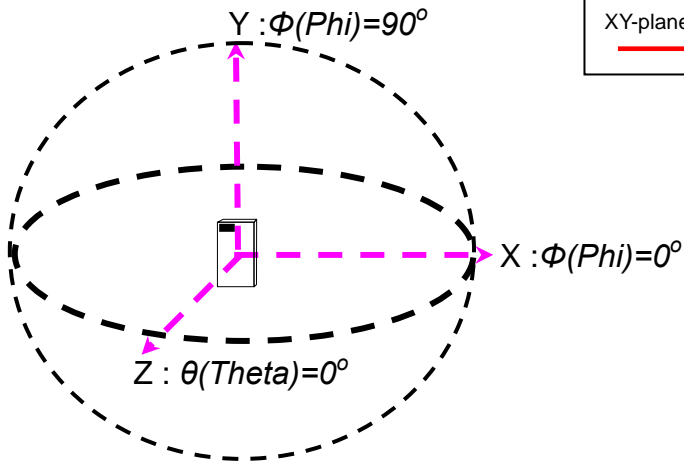

XY-plane @ 2440MHz  
— Total

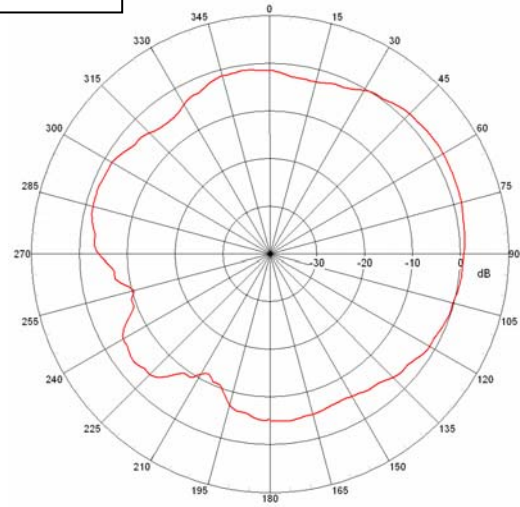

XZ-plane @ 2440MHz  
— Total

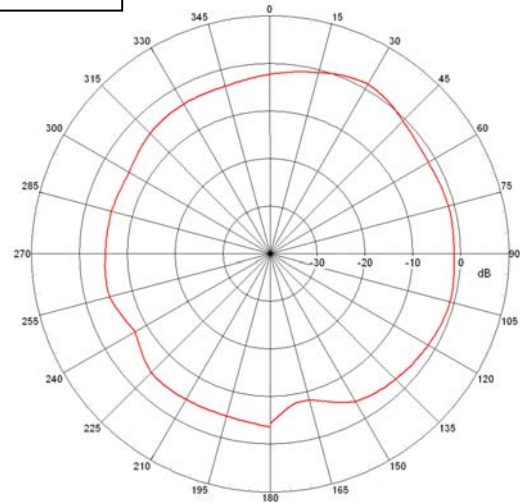

YZ-plane @ 2440MHz  
— Total

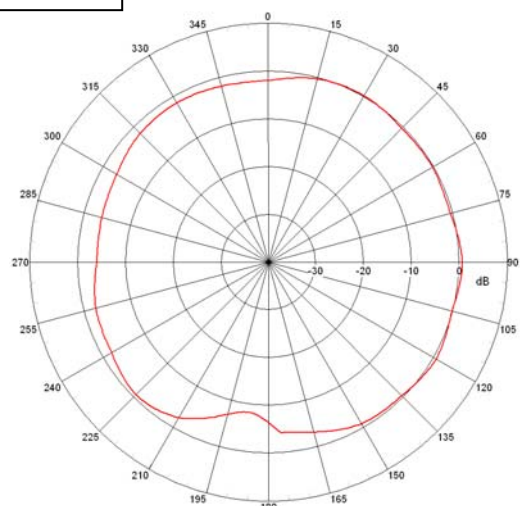

❖ Radiation Patterns@5.5GHz

(Antenna Efficiency 78% @ 5.15GHz ; 86% @5.5GHz ; 76% @5.85GHz)

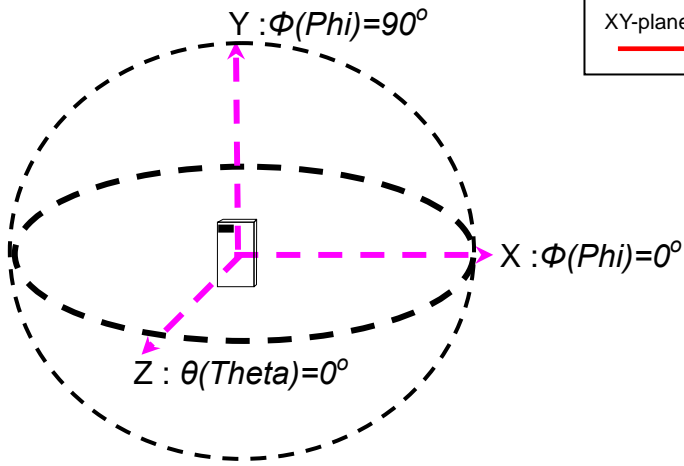

XY-plane @5500MHz  
— Total

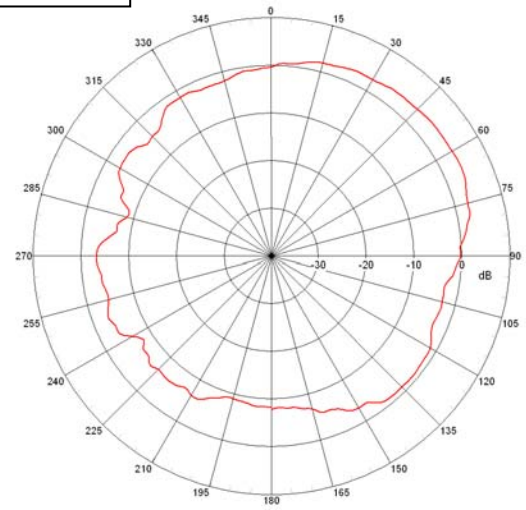

XZ-plane @5500MHz  
— Total

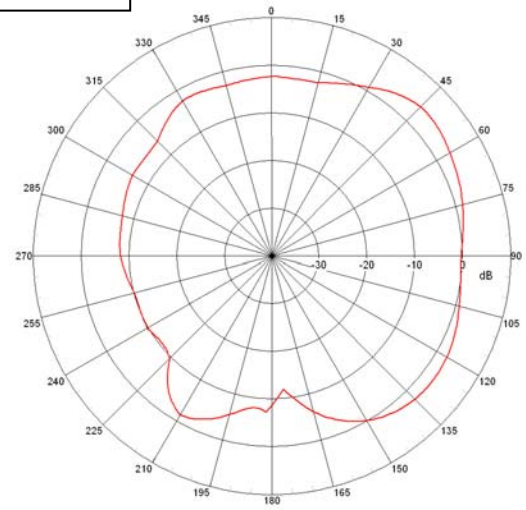

YZ-plane @5500MHz  
— Total

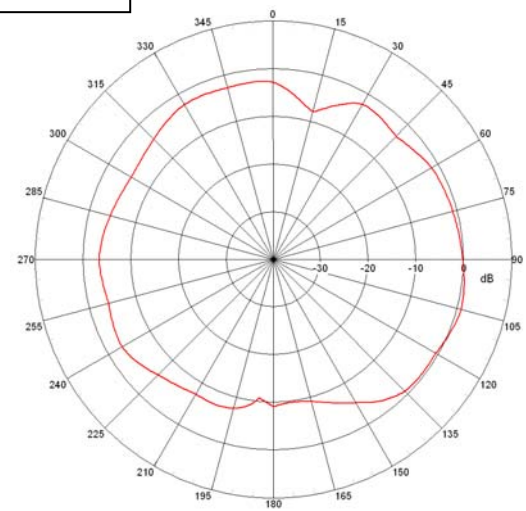

## Taping Specifications

### ❖Tape Dimensions (Unit: mm) & Quantity

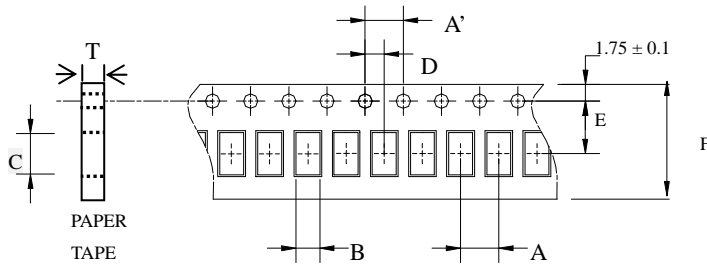

Type	A	A'	B	C	D	E	F	T	Quantity/reel	Tape material
1608	4.0±	4.0±	0.95±	1.80±	2.0±	3.5±	8.0±	0.60±	4,000pcs	Paper
	0.1	0.1	0.1	0.1	0.1	0.1	0.1	0.03		

### ❖Reel Dimensions (Unit: mm)

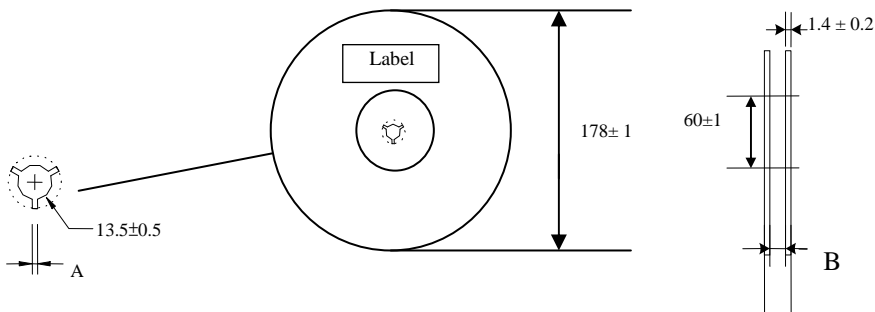

Label: Customer's Name,  
ACX P/N, Q'ty, Date,  
ACX Corp.

Type	A	B
1608	2.3±0.5	9.0±0.3

### ❖Leader and Trailer Tape

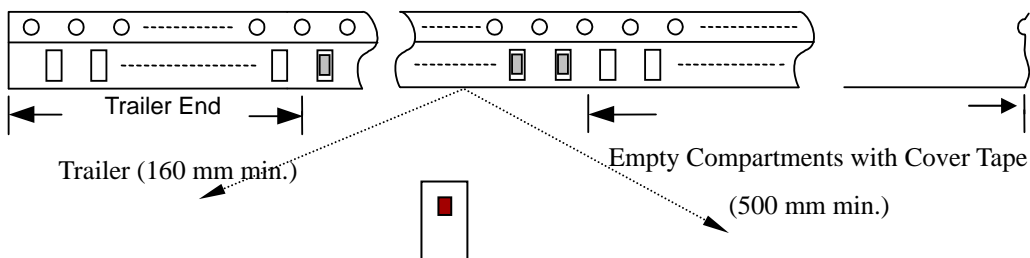

❖ **Peel-off Force**

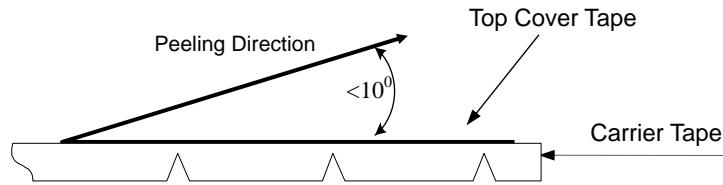

Peel-off force should be in the range of 0.1 – 0.6 N at a peel-off speed of  $300 \pm 10$  mm/min .

❖ **Storage Conditions**

- (1) Temperature: 5 ~35°C , relative humidity (RH): 45~75%.
- (2) Non-corrosive environment

**Notes**

❖ The contents of this data sheet are subject to change without notice. Please confirm the specifications and delivery conditions when placing your order.

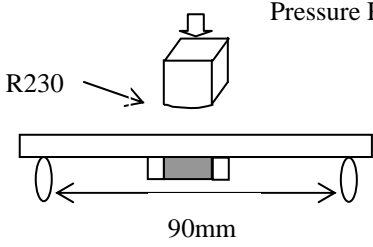

## Mechanical & Environmental Characteristics

Item	Requirements	Procedure
Solderability	<ol style="list-style-type: none"> <li>No apparent damage</li> <li>More than 95% of the terminal electrode shall be covered with new solder</li> </ol>	<ol style="list-style-type: none"> <li>Preheat: <math>120 \pm 5^{\circ}\text{C}</math></li> <li>Solder: <math>245 \pm 5^{\circ}\text{C}</math> for <math>5 \pm 1</math> sec</li> </ol>
Soldering strength (Termination Adhesion)	<ol style="list-style-type: none"> <li>1kg minimum</li> </ol>	<ol style="list-style-type: none"> <li>Solder specimen onto test jig.</li> <li>Apply push force at 0.5mm/s until electrode pads are peeled off or ceramic are broken. Pushing force is applied to longitude direction</li> </ol>
Deflection (Substrate Bending)	<ol style="list-style-type: none"> <li>No apparent damage</li> </ol>	<ol style="list-style-type: none"> <li>Solder specimen onto test jig (FR4, 0.8mm) using the recommend soldering profile.</li> <li>Apply a bending force of 2mm deflection</li> </ol> 
Heat/Humidity Resistance	<ol style="list-style-type: none"> <li>No apparent damage</li> <li>Fulfill the electrical specification after test</li> </ol>	<ol style="list-style-type: none"> <li>Temperature: <math>85 \pm 2^{\circ}\text{C}</math></li> <li>Humidity: 90% ~ 95% RH</li> <li>Duration: <math>1000 \pm 48</math>hrs</li> <li>Recovery: 1-2hrs</li> </ol>
Thermal shock (Temperature Cycle)	<ol style="list-style-type: none"> <li>No apparent damage</li> <li>Fulfill the electrical specification after test</li> </ol>	<ol style="list-style-type: none"> <li>One cycle/step 1 : <math>125 \pm 5^{\circ}\text{C}</math> for 30 min step 2 : <math>-40 \pm 5^{\circ}\text{C}</math> for 30 min</li> <li>No of cycles : 100</li> <li>Recovery: 1-2 hrs</li> </ol>
Low Temperature Resistance	<ol style="list-style-type: none"> <li>No apparent damage</li> <li>Fulfill the electrical specification after test</li> </ol>	<ol style="list-style-type: none"> <li>Temperature: <math>-40 \pm 5^{\circ}\text{C}</math></li> <li>Duration: <math>500 \pm 24</math>hrs</li> <li>Recovery: 1-2hrs</li> </ol>

## Soldering Conditions

### ❖ Typical Soldering Profile for Lead-free Process

Reflow Soldering :

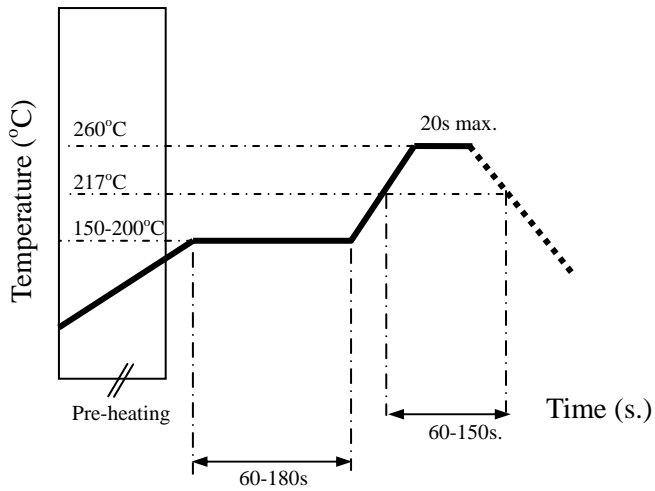

## Notes

❖ The contents of this data sheet are subject to change without notice. Please confirm the specifications and delivery conditions when placing your order.

### Advanced Ceramic X Corp.

16 Tzu Chiang Road, Hsinchu Industrial District Hsinchu Hsien 303, Taiwan

TEL:886-3-5987008 FAX:886-3-5987001

E-mail: [acx@acxc.com.tw](mailto:acx@acxc.com.tw) <http://www.acxc.com.tw>