

FCC Test Report

FCC ID : SQG-EWB1
Equipment : 802.11 b/g/n WLAN, Bluetooth & BLE Module
w/Integrated MCU
Model No. : Sterling™- EWB
Brand Name : Laird Connectivity
Applicant : Laird Connectivity, Inc
Address : W66N220 Commerce Court, Cedarburg,
Wisconsin 53012, USA
Standard : 47 CFR FCC Part 15.247
Received Date : Mar. 14, 2019
Tested Date : Mar. 16 ~ Apr. 03, 2019

We, International Certification Corp., would like to declare that the tested sample has been evaluated and in compliance with the requirement of the above standards. The test results contained in this report refer exclusively to the product. It may be duplicated completely for legal use with the approval of the applicant. It shall not be reproduced except in full without the written approval of our laboratory.

Reviewed by:



Along Chen / Assistant Manager

Approved by:



Gary Chang / Manager



Table of Contents

1	GENERAL DESCRIPTION	5
1.1	Information.....	5
1.2	Local Support Equipment List	8
1.3	Test Setup Chart	8
1.4	The Equipment List	9
1.5	Test Standards	10
1.6	Deviation from Test Standard and Measurement Procedure.....	10
1.7	Measurement Uncertainty	10
2	TEST CONFIGURATION	11
2.1	Testing Condition	11
2.2	The Worst Test Modes and Channel Details	11
3	TRANSMITTER TEST RESULTS.....	12
3.1	Conducted Emissions.....	12
3.2	6dB and Occupied Bandwidth	15
3.3	RF Output Power.....	20
3.4	Power Spectral Density	23
3.5	Unwanted Emissions into Restricted Frequency Bands	28
3.6	Emissions in Non-Restricted Frequency Bands.....	68
4	TEST LABORATORY INFORMATION	72

Release Record

Report No.	Version	Description	Issued Date
FR931402AC	Rev. 01	Initial issue	May 14, 2019

Summary of Test Results

FCC Rules	Test Items	Measured	Result
15.207	Conducted Emissions	[dBuV]: 0.156MHz 54.03 (Margin -11.66dB) - QP	Pass
15.247(d) 15.209	Radiated Emissions	[dBuV/m at 3m]: 7311.00MHz 52.52 (Margin -1.48dB) - AV	Pass
15.247(b)(3)	Maximum Output Power	Max Power [dBm]: 24.28	Pass
15.247(a)(2)	6dB Bandwidth	Meet the requirement of limit	Pass
15.247(e)	Power Spectral Density	Meet the requirement of limit	Pass
15.203	Antenna Requirement	Meet the requirement of limit	Pass

Declaration of Conformity:

The test results with all measurement uncertainty excluded are presented in accordance with the regulation limits or requirements declared by manufacturers.

Comments and Explanations:

The declared of product specification for EUT presented in the report are provided by the manufacturer, and the manufacturer takes all the responsibilities for the accuracy of product specification.

1 General Description

1.1 Information

1.1.1 Product Details

The following models are provided to this EUT.

Brand Name	Model Name	Product Name	Description
Laird Connectivity	Sterling™ - EWB	802.11 b/g/n WLAN, Bluetooth & BLE Module w/Integrated MCU	With Printed PCB Antenna With Connector Type Antenna

1.1.2 Specification of the Equipment under Test (EUT)

RF General Information					
Frequency Range (MHz)	IEEE Std. 802.11	Ch. Freq. (MHz)	Channel Number	Transmit Chains (N _{TX})	Data Rate / MCS
2400-2483.5	b	2412-2462	1-11 [11]	1	1-11 Mbps
2400-2483.5	g	2412-2462	1-11 [11]	1	6-54 Mbps
2400-2483.5	n (HT20)	2412-2462	1-11 [11]	1	MCS 0-7

Note 1: RF output power specifies that Maximum Peak Conducted Output Power.
 Note 2: 802.11b uses a combination of DSSS-DBPSK, DQPSK, CCK modulation.
 Note 3: 802.11g/n uses a combination of OFDM-BPSK, QPSK, 16QAM, 64QAM modulation.

1.1.3 Antenna Details

Ant. No.	Brand	Model	Laird Part Number	Type	Connector	Gain (dBi)	Remark
1	ACX	AT3216-A2R4PAA	AT3216-A2R4PAA	Chip	N/A	1.5	Printed PCB Antenna
2	Laird	001 -0001	001 -0001	Dipole	R-SMA	2	Connector Type Antenna
3	Laird	001-0014	001-0014	FlexPIFA	U.FL	2	Connector Type Antenna
4	Laird	001-0015	001-0015	FlexNotch	U.FL	2	Connector Type Antenna
5	Laird	001-0030	001-0030	PIFA	UFL	2	Connector Type Antenna
6	Laird	NanoBlue	EBL2400A1-10MH4L	PCB Dipole	UFL	2	Connector Type Antenna

1.1.4 Power Supply Type of Equipment under Test (EUT)

Power Supply Type	3.3Vdc from host
--------------------------	------------------

1.1.5 Accessories

N/A

1.1.6 Channel List

Channel	Frequency(MHz)
1	2412
2	2417
3	2422
4	2427
5	2432
6	2437
7	2442
8	2447
9	2452
10	2457
11	2462

1.1.7 Test Tool and Duty Cycle

Test Tool	CMD, Ver. 6.1.7601		
Duty Cycle and Duty Factor	Mode	Duty Cycle (%)	Duty Factor (dB)
	11b	100.00	0.00
	11g	99.65	0.02
	HT20	99.63	0.02

1.1.8 Power Index of Test Tool

Modulation Mode	Test Frequency (MHz)	Power Index
11b	2412	80
11b	2437	86
11b	2462	82
11g	2412	68
11g	2437	68
11g	2462	64
HT20	2412	62
HT20	2437	62
HT20	2462	56

1.2 Local Support Equipment List

Support Equipment List					
No.	Equipment	Brand	Model	FCC ID	Remarks
1	Notebook	DELL	Latitude E6430	DoC	---
2	50Ω load	---	---	---	---
3	Fixture	---	---	---	Provided by applicant.

1.3 Test Setup Chart

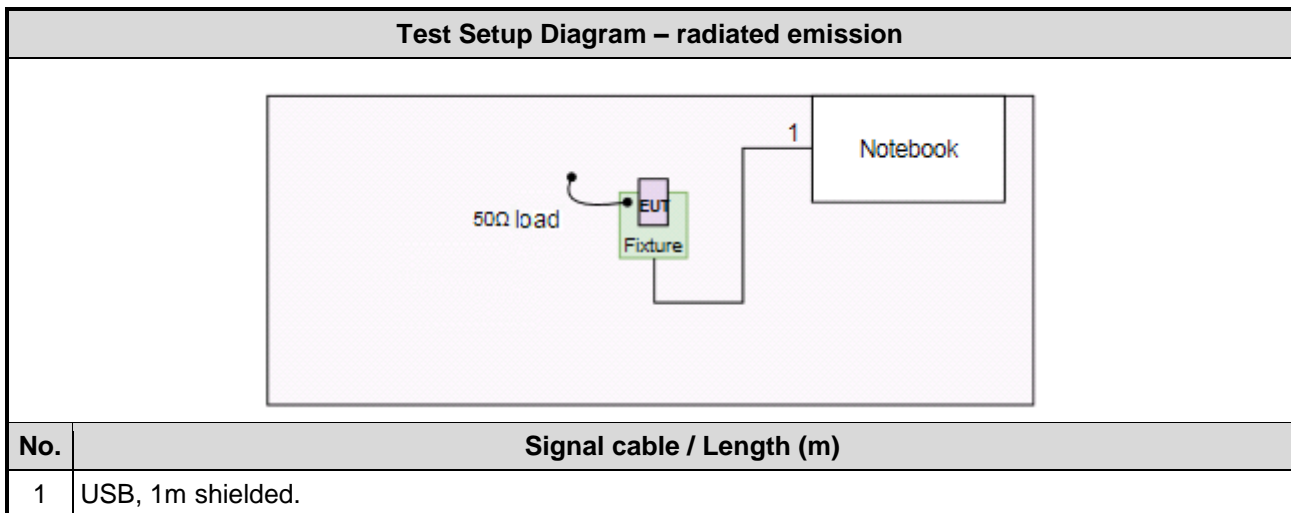
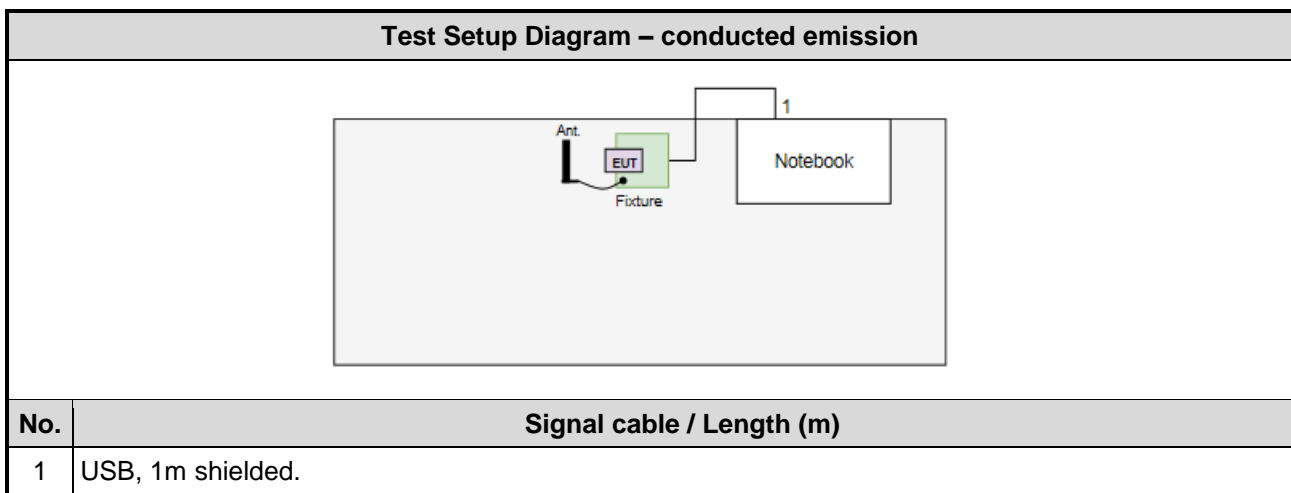

1.4 The Equipment List

Test Item	Conducted Emission				
Test Site	Conduction room 1 / (CO01-WS)				
Instrument	Manufacturer	Model No.	Serial No.	Calibration Date	Calibration Until
Receiver	R&S	ESR3	101657	Jan. 08, 2019	Jan. 07, 2020
LISN	SCHWARZBECK	Schwarzbeck 8127	8127-667	Nov. 05, 2018	Nov. 04, 2019
RF Cable-CON	Woken	CFD200-NL	CFD200-NL-001	Oct. 23, 2018	Oct. 23, 2019
Measurement Software	AUDIX	e3	6.120210k	NA	NA

Note: Calibration Interval of instruments listed above is one year.

Test Item	Radiated Emission				
Test Site	966 chamber1 / (03CH01-WS)				
Instrument	Manufacturer	Model No.	Serial No.	Calibration Date	Calibration Until
Spectrum Analyzer	R&S	FSV40	101498	Dec. 27, 2018	Dec. 26, 2019
Receiver	R&S	ESR3	101658	Dec. 11, 2018	Dec. 10, 2019
Bilog Antenna	SCHWARZBECK	VULB9168	VULB9168-522	Jul. 18, 2018	Jul. 17, 2019
Horn Antenna 1G-18G	SCHWARZBECK	BBHA 9120 D	BBHA 9120 D 1096	Dec. 18, 2018	Dec. 17, 2019
Horn Antenna 18G-40G	SCHWARZBECK	BBHA 9170	BBHA 9170517	Nov. 15, 2018	Nov. 14, 2019
Loop Antenna	R&S	HFH2-Z2	100330	Nov. 09, 2018	Nov. 08, 2019
Loop Antenna Cable	KOAX KABEL	101354-BW	101354-BW	Oct. 08, 2018	Oct. 07, 2019
Preamplifier	EMC	EMC02325	980225	Jul. 20, 2018	Jul. 19, 2019
Preamplifier	Agilent	83017A	MY39501308	Oct. 04, 2018	Oct. 03, 2019
Preamplifier	EMC	EMC184045B	980192	Aug. 09, 2018	Aug. 08, 2019
RF Cable	EMC	EMC104-SM-SM-8000	181106	Oct. 08, 2018	Oct. 07, 2019
RF Cable	HUBER+SUHNER	SUCOFLEX104	MY16019/4	Oct. 08, 2018	Oct. 07, 2019
RF Cable	HUBER+SUHNER	SUCOFLEX104	MY16014/4	Oct. 08, 2018	Oct. 07, 2019
LF cable 1M	EMC	EMCCFD400-NM-NM-1000	160502	Oct. 08, 2018	Oct. 07, 2019
LF cable 3M	Woken	CFD400NL-LW	CFD400NL-001	Oct. 08, 2018	Oct. 07, 2019
LF cable 10M	Woken	CFD400NL-LW	CFD400NL-002	Oct. 08, 2018	Oct. 07, 2019
Measurement Software	AUDIX	e3	6.120210g	NA	NA

Note: Calibration Interval of instruments listed above is one year.

Test Item	RF Conducted				
Test Site	(TH01-WS)				
Instrument	Manufacturer	Model No.	Serial No.	Calibration Date	Calibration Until
Spectrum Analyzer	R&S	FSV40	101063	Apr. 16, 2018	Apr. 15, 2019
Power Meter	Anritsu	ML2495A	1241002	Oct. 09, 2018	Oct. 08, 2019
Power Sensor	Anritsu	MA2411B	1207366	Oct. 09, 2018	Oct. 08, 2019
DC POWER SOURCE	GW INSTEK	GPC-6030D	EM892433	Oct. 25, 2018	Oct. 24, 2019
Measurement Software	Sporton	SENSE-15247_DTS	V5.9	NA	NA
Note: Calibration Interval of instruments listed above is one year.					

1.5 Test Standards

According to the specification of EUT, the EUT must comply with following standards and KDB documents.

47 CFR FCC Part 15.247

ANSI C63.10-2013

FCC KDB 558074 D01 15.247 Meas Guidance v05r02

1.6 Deviation from Test Standard and Measurement Procedure

None

1.7 Measurement Uncertainty

ISO/IEC 17025 requires that an estimate of the measurement uncertainties associated with the emissions test results be included in the report. The measurement uncertainties given below are based on a 95% confidence level (based on a coverage factor (k=2))

Measurement Uncertainty	
Parameters	Uncertainty
Bandwidth	±34.130 Hz
Conducted power	±0.808 dB
Power density	±0.583 dB
Conducted emission	±2.715 dB
AC conducted emission	±2.92 dB
Radiated emission ≤ 1GHz	±3.41 dB
Radiated emission > 1GHz	±4.59 dB

2 Test Configuration

2.1 Testing Condition

Test Item	Test Site	Ambient Condition	Tested By
AC Conduction	CO01-WS	21°C / 66%	Akun Chung
Radiated Emissions	03CH01-WS	22-23°C / 61-62%	Roger Lu Aska Huang
RF Conducted	TH01-WS	21°C / 64%	Felix Sung

- FCC Designation No.: TW2732
- FCC site registration No.: 181692
- ISED#: 10807A
- CAB identifier: TW2732

2.2 The Worst Test Modes and Channel Details

Test item	Modulation Mode	Test Frequency (MHz)	Data Rate	Test Configuration
Conducted Emissions	11g	2437	6 Mbps	---
Radiated Emissions ≤1GHz	11g	2437	6 Mbps	---
Radiated Emissions >1GHz				
Maximum Output Power	11b	2412 / 2437 / 2462	1 Mbps	
6dB bandwidth	11g	2412 / 2437 / 2462	6 Mbps	---
Power spectral density	HT20	2412 / 2437 / 2462	MCS 0	

NOTE:

1. The EUT was pretested with 3 orientations placed on the table for the radiated emission measurement – X, Y, and Z-plane. The **Y-plane** results were found as the worst case and were shown in this report.
2. 50Ω load is connected to antenna port of EUT for radiated emission measurement.

3 Transmitter Test Results

3.1 Conducted Emissions

3.1.1 Limit of Conducted Emissions

Conducted Emissions Limit		
Frequency Emission (MHz)	Quasi-Peak	Average
0.15-0.5	66 - 56 *	56 - 46 *
0.5-5	56	46
5-30	60	50

Note 1: * Decreases with the logarithm of the frequency.

3.1.2 Test Procedures

1. The device is placed on a test table, raised 80 cm above the reference ground plane. The vertical conducting plane is located 40 cm to the rear of the device.
2. The device is connected to line impedance stabilization network (LISN) and other accessories are connected to other LISN. Measured levels of AC power line conducted emission are across the 50 Ω LISN port.
3. AC conducted emission measurements is made over frequency range from 150 kHz to 30 MHz.
4. This measurement was performed with AC 120V / 60Hz.

3.1.3 Test Setup



- Note: 1. Support units were connected to second LISN.
 2. Both of LISNs (AMN) are 80 cm from EUT and at least 80 cm from other units and other metal planes

3.1.4 Test Result of Conducted Emissions

Modulation	11g	Test Freq. (MHz)	2437
Power Phase	Line		

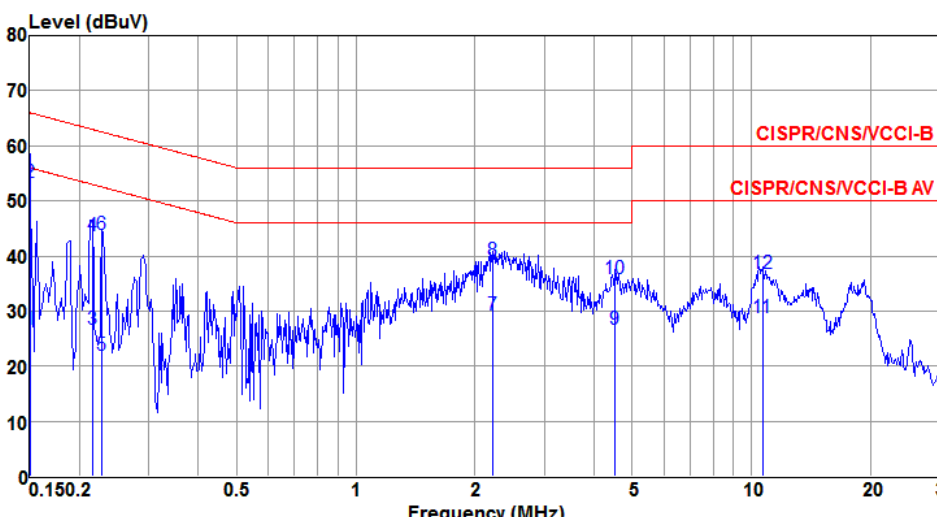

	Freq	Level	Limit	Over	Read	LISN	cable	Remark
	MHz	dBuV	dBuV	dB	dBuV	dB	dB	
1	0.150	26.67	56.00	-29.33	17.09	9.53	0.05	Average
2*	0.150	53.39	66.00	-12.61	43.81	9.53	0.05	QP
3	0.216	26.67	52.96	-26.29	17.06	9.54	0.07	Average
4	0.216	43.72	62.96	-19.24	34.11	9.54	0.07	QP
5	0.228	22.02	52.52	-30.50	12.40	9.55	0.07	Average
6	0.228	43.81	62.52	-18.71	34.19	9.55	0.07	QP
7	2.225	29.33	46.00	-16.67	19.55	9.60	0.18	Average
8	2.225	39.28	56.00	-16.72	29.50	9.60	0.18	QP
9	4.525	26.78	46.00	-19.22	16.86	9.62	0.30	Average
10	4.525	35.94	56.00	-20.06	26.02	9.62	0.30	QP
11	10.676	28.89	50.00	-21.11	18.78	9.65	0.46	Average
12	10.676	36.80	60.00	-23.20	26.69	9.65	0.46	QP

Note 1: Level (dBuV) = Read Level (dBuV) + LISN Factor (dB) + Cable Loss (dB).
 Note 2: Over Limit (dB) = Level (dBuV) – Limit Line (dBuV).

Modulation	11g	Test Freq. (MHz)	2437
-------------------	-----	-------------------------	------

Power Phase	Neutral
--------------------	---------

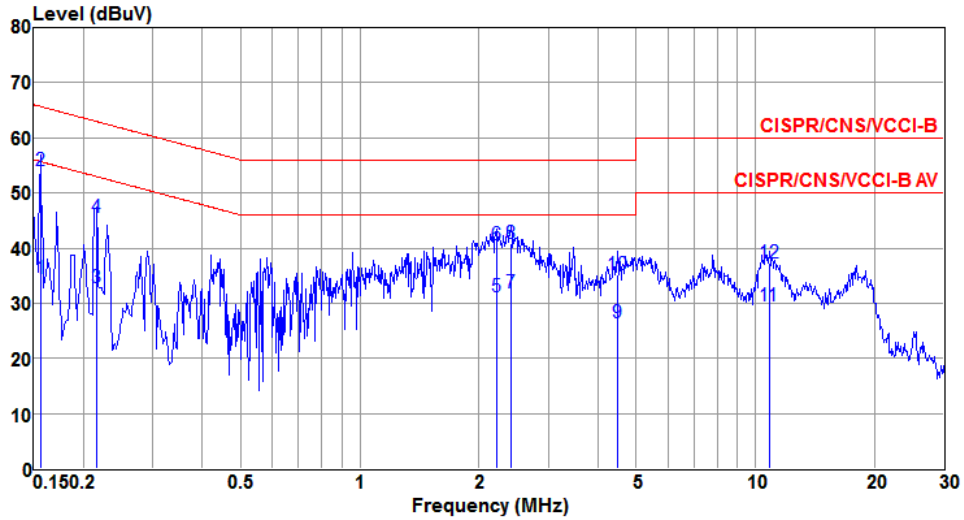

	Freq MHz	Level dBuV	Limit Line dBuV	Over Limit dB	Read Level dBuV	LISN factor dB	cable loss dB	Remark
1	0.156	34.46	55.69	-21.23	24.84	9.57	0.05	Average
2*	0.156	54.03	65.69	-11.66	44.41	9.57	0.05	QP
3	0.216	32.79	52.96	-20.17	23.14	9.58	0.07	Average
4	0.216	45.58	62.96	-17.38	35.93	9.58	0.07	QP
5	2.213	31.18	46.00	-14.82	21.35	9.65	0.18	Average
6	2.213	40.53	56.00	-15.47	30.70	9.65	0.18	QP
7	2.409	31.90	46.00	-14.10	22.06	9.65	0.19	Average
8	2.409	40.94	56.00	-15.06	31.10	9.65	0.19	QP
9	4.478	26.55	46.00	-19.45	16.58	9.67	0.30	Average
10	4.478	35.21	56.00	-20.79	25.24	9.67	0.30	QP
11	10.847	29.45	50.00	-20.55	19.27	9.72	0.46	Average
12	10.847	37.19	60.00	-22.81	27.01	9.72	0.46	QP

Note 1: Level (dBuV) = Read Level (dBuV) + LISN Factor (dB) + Cable Loss (dB).
 2: Over Limit (dB) = Level (dBuV) – Limit Line (dBuV).

3.2 6dB and Occupied Bandwidth

3.2.1 Limit of 6dB Bandwidth

The minimum 6dB bandwidth shall be at least 500 kHz.

3.2.2 Test Procedures

6dB Bandwidth

1. Set resolution bandwidth (RBW) = 100 kHz, Video bandwidth = 300 kHz.
2. Detector = Peak, Trace mode = max hold.
3. Sweep = auto couple, Allow the trace to stabilize.
4. Measure the maximum width of the emission that is constrained by the frequencies associated with the two outermost amplitude points (upper and lower) that are attenuated by 6dB relative to the maximum level measured in the fundamental emission.

Occupied Bandwidth

1. Set resolution bandwidth (RBW) = 1% ~ 5 % of OBW, Video bandwidth = 3 x RBW
2. Detector = Sample, Trace mode = max hold.
3. Sweep = auto couple, Allow the trace to stabilize.
4. Use the OBW measurement function of spectrum analyzer to measure the occupied bandwidth.

3.2.3 Test Setup

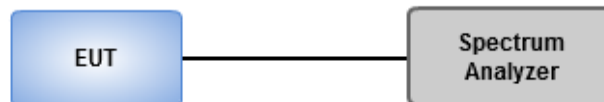

3.2.4 Test Result of 6dB and Occupied Bandwidth

Summary

Mode	Max-N dB (Hz)	Max-OBW (Hz)	ITU-Code	Min-N dB (Hz)	Min-OBW (Hz)
2.4-2.4835GHz	-	-	-	-	-
802.11b_Nss1,(1Mbps)_1TX	8.623M	14.182M	14M2G1D	7.536M	14.038M
802.11g_Nss1,(6Mbps)_1TX	15.362M	16.353M	16M4D1D	14.783M	16.281M
802.11n HT20_Nss1,(MCS0)_1TX	15.072M	17.511M	17M5D1D	14.058M	17.366M

Max-N dB = Maximum 6dB down bandwidth; **Max-OBW** = Maximum 99% occupied bandwidth;
Min-N dB = Minimum 6dB down bandwidth; **Min-OBW** = Minimum 99% occupied bandwidth;

Result

Mode	Result	Limit (Hz)	Port 1-N dB (Hz)	Port 1-OBW (Hz)
802.11b_Nss1,(1Mbps)_1TX	-	-	-	-
2412MHz	Pass	500k	7.536M	14.038M
2437MHz	Pass	500k	8.623M	14.182M
2462MHz	Pass	500k	8.551M	14.11M
802.11g_Nss1,(6Mbps)_1TX	-	-	-	-
2412MHz	Pass	500k	15.362M	16.353M
2437MHz	Pass	500k	14.783M	16.353M
2462MHz	Pass	500k	15.072M	16.281M
802.11n HT20_Nss1,(MCS0)_1TX	-	-	-	-
2412MHz	Pass	500k	14.058M	17.366M
2437MHz	Pass	500k	15M	17.511M
2462MHz	Pass	500k	15.072M	17.511M

Port X-N dB = Port X 6dB down bandwidth; **Port X-OBW** = Port X 99% occupied bandwidth;

802.11b_Nss1,(1Mbps)_1TX

EBW

2412MHz

CF
2.412GHz
Span
50MHz
RBW
100kHz
VBW
300kHz
Sweep Time
1.08ms
Detector Type
Peak

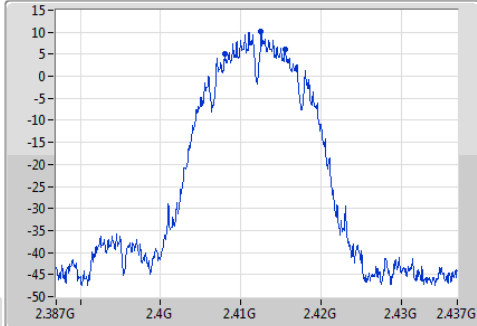

CF
2.412GHz
Span
50MHz
RBW
200kHz
VBW
1MHz
Sweep Time
1.02ms
Detector Type
Sample

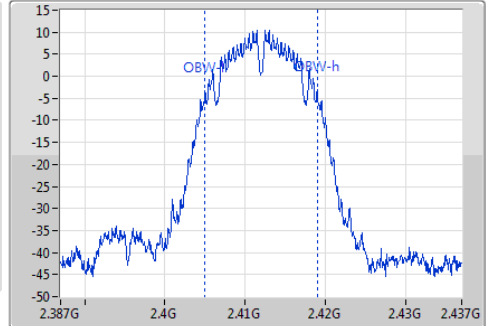

6dB(Hz)	Fl-6dB(Hz)	Fh-6dB(Hz)	OBW(Hz)	Fl-OBW(Hz)	Fh-OBW(Hz)	Limit(Hz)	Port
7.536M	2.408014G	2.415551G	14.038M	2.404981G	2.419019G	500k	1

802.11b_Nss1,(1Mbps)_1TX

EBW

2437MHz

CF
2.437GHz
Span
50MHz
RBW
100kHz
VBW
300kHz
Sweep Time
1.08ms
Detector Type
Peak

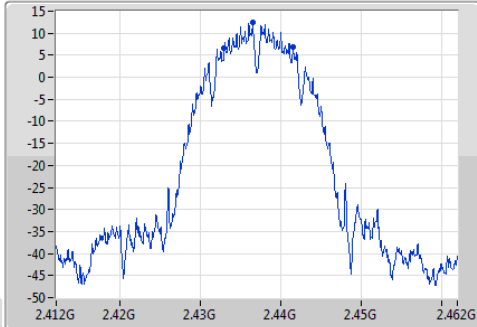

CF
2.437GHz
Span
50MHz
RBW
200kHz
VBW
1MHz
Sweep Time
1.02ms
Detector Type
Sample

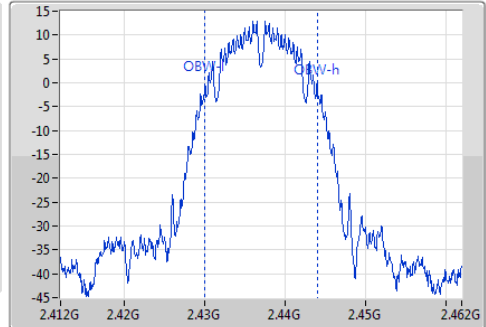

6dB(Hz)	Fl-6dB(Hz)	Fh-6dB(Hz)	OBW(Hz)	Fl-OBW(Hz)	Fh-OBW(Hz)	Limit(Hz)	Port
8.623M	2.432942G	2.441565G	14.182M	2.429909G	2.444091G	500k	1

802.11b_Nss1,(1Mbps)_1TX

EBW

2462MHz

CF
2.462GHz
Span
50MHz
RBW
100kHz
VBW
300kHz
Sweep Time
1.08ms
Detector Type
Peak

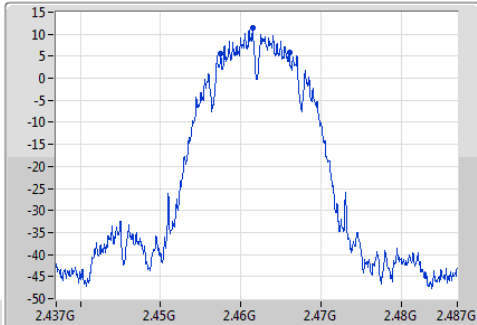

CF
2.462GHz
Span
50MHz
RBW
200kHz
VBW
1MHz
Sweep Time
1.02ms
Detector Type
Sample

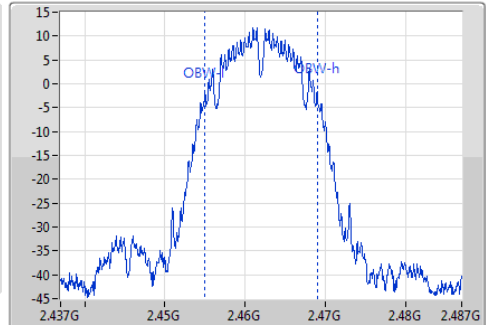

6dB(Hz)	Fl-6dB(Hz)	Fh-6dB(Hz)	OBW(Hz)	Fl-OBW(Hz)	Fh-OBW(Hz)	Limit(Hz)	Port
8.551M	2.457507G	2.466058G	14.11M	2.454909G	2.469019G	500k	1

802.11g_Nss1,(6Mbps)_1TX

EBW

2412MHz

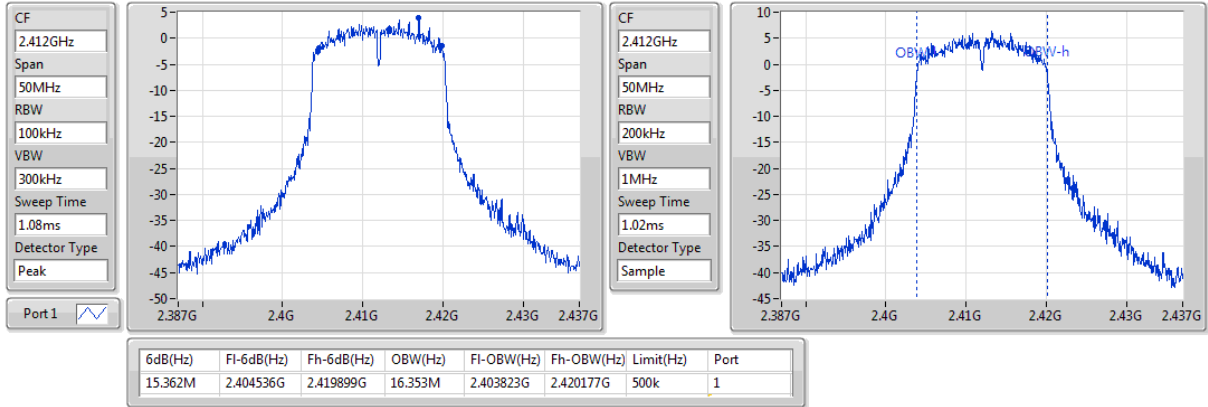

802.11g_Nss1,(6Mbps)_1TX

EBW

2437MHz

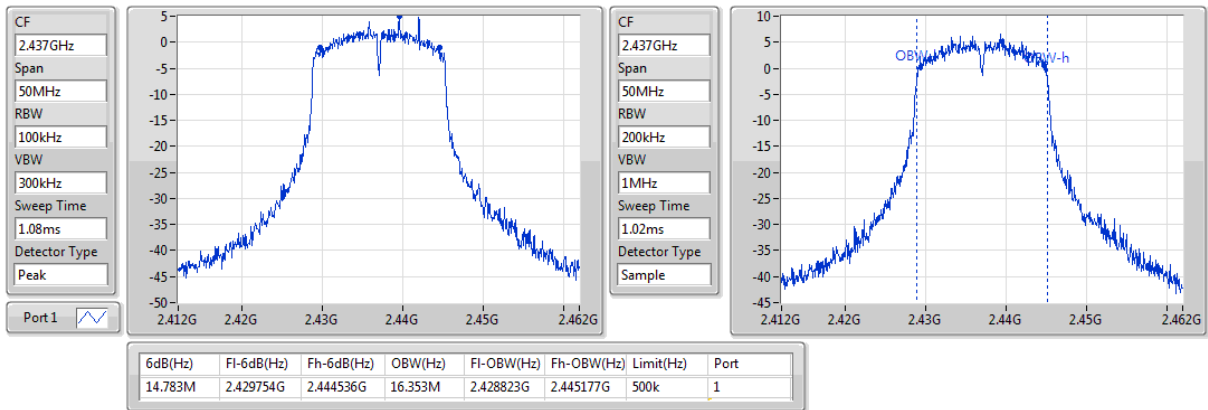

802.11g_Nss1,(6Mbps)_1TX

EBW

2462MHz

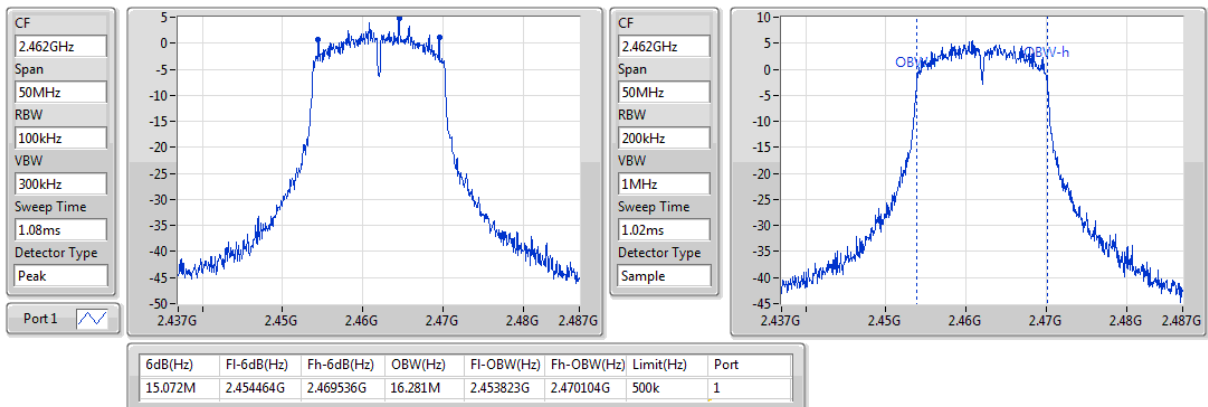

802.11n HT20_Nss1,(MCS0)_1TX

EBW

2412MHz

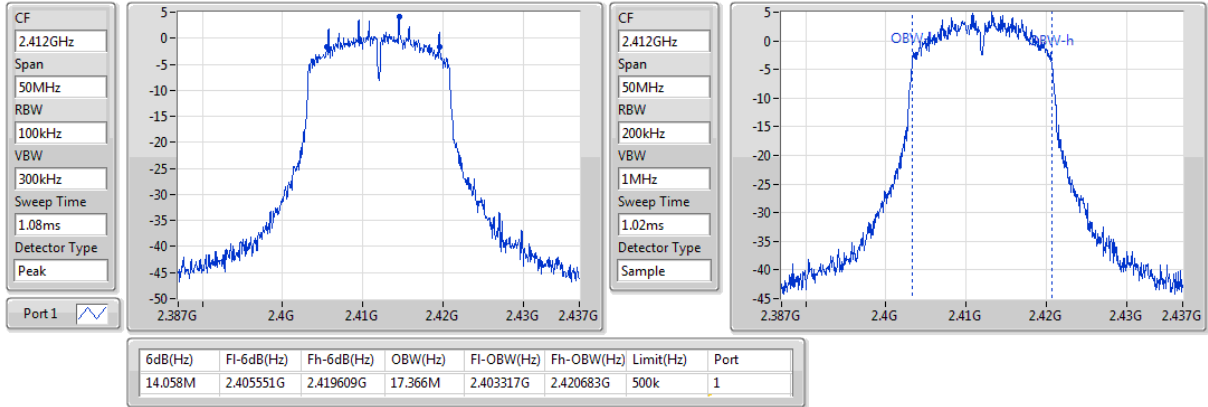

802.11n HT20_Nss1,(MCS0)_1TX

EBW

2437MHz

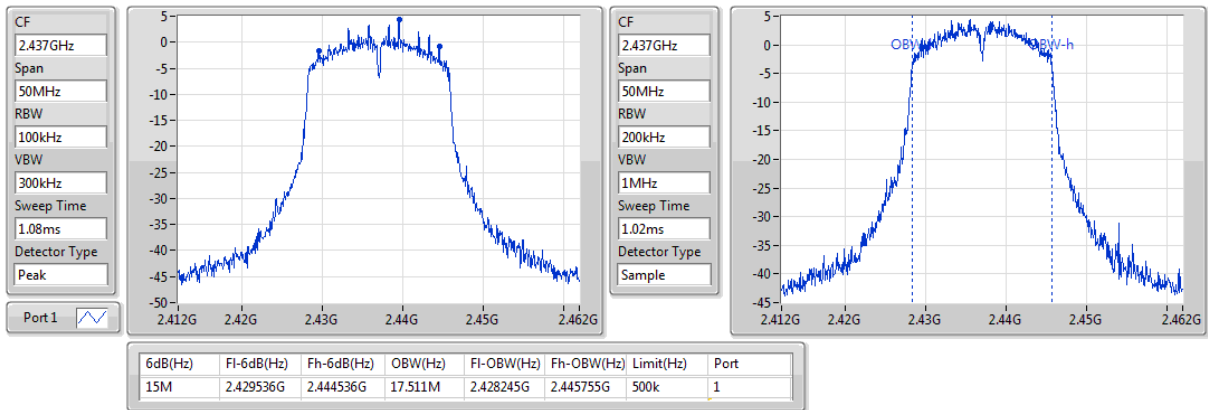

802.11n HT20_Nss1,(MCS0)_1TX

EBW

2462MHz

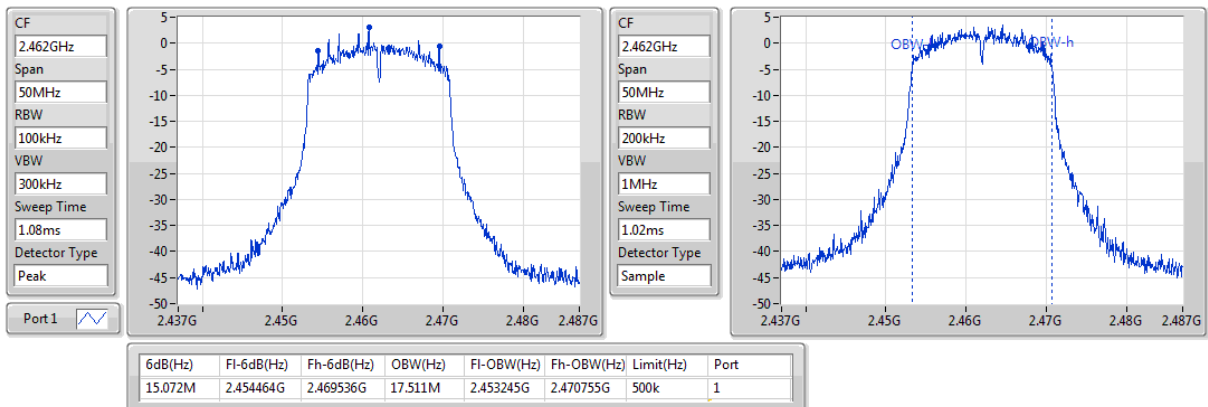

3.3 RF Output Power

3.3.1 Limit of RF Output Power

Conducted power shall not exceed 1Watt.

Antenna gain $\leq 6\text{dBi}$, no any corresponding reduction is in output power limit.

3.3.2 Test Procedures

A broadband RF power meter is used for output power measurement. The video bandwidth of power meter is greater than DTS bandwidth of EUT. If duty cycle of test signal is not 100 %, trigger and gating function of power meter will be enabled to capture transmission burst for measuring output power.

3.3.3 Test Setup

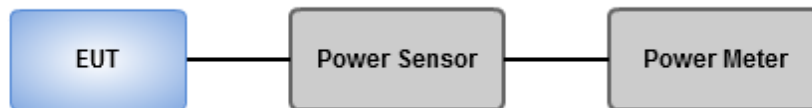

3.3.4 Test Result of Maximum Output Power

Peak Conducted Output Power

Summary

Mode	Total Power (dBm)	Total Power (W)
2.4-2.4835GHz	-	-
802.11b_Nss1,(1Mbps)_1TX	23.12	0.20512
802.11g_Nss1,(6Mbps)_1TX	24.28	0.26792
802.11n HT20_Nss1,(MCS0)_1TX	23.51	0.22439

Result

Mode	Result	DG (dBi)	Port 1 (dBm)	Total Power (dBm)	Power Limit (dBm)
802.11b_Nss1,(1Mbps)_1TX	-	-	-	-	-
2412MHz	Pass	2.00	21.13	21.13	30.00
2437MHz	Pass	2.00	23.12	23.12	30.00
2462MHz	Pass	2.00	21.87	21.87	30.00
802.11g_Nss1,(6Mbps)_1TX	-	-	-	-	-
2412MHz	Pass	2.00	24.21	24.21	30.00
2437MHz	Pass	2.00	24.28	24.28	30.00
2462MHz	Pass	2.00	23.84	23.84	30.00
802.11n HT20_Nss1,(MCS0)_1TX	-	-	-	-	-
2412MHz	Pass	2.00	23.48	23.48	30.00
2437MHz	Pass	2.00	23.51	23.51	30.00
2462MHz	Pass	2.00	22.32	22.32	30.00

DG = Directional Gain; Port X = Port X output power

Conducted (Average) Output Power Summary

Mode	Total Power (dBm)	Total Power (W)
2.4-2.4835GHz	-	-
802.11b_Nss1,(1Mbps)_1TX	20.95	0.12445
802.11g_Nss1,(6Mbps)_1TX	16.04	0.04018
802.11n HT20_Nss1,(MCS0)_1TX	14.62	0.02897

Result

Mode	Result	DG (dBi)	Port 1 (dBm)	Total Power (dBm)	Power Limit (dBm)
802.11b_Nss1,(1Mbps)_1TX	-	-	-	-	-
2412MHz	Pass	2.00	18.81	18.81	-
2437MHz	Pass	2.00	20.95	20.95	-
2462MHz	Pass	2.00	19.54	19.54	-
802.11g_Nss1,(6Mbps)_1TX	-	-	-	-	-
2412MHz	Pass	2.00	16.01	16.01	-
2437MHz	Pass	2.00	16.04	16.04	-
2462MHz	Pass	2.00	15.33	15.33	-
802.11n HT20_Nss1,(MCS0)_1TX	-	-	-	-	-
2412MHz	Pass	2.00	14.58	14.58	-
2437MHz	Pass	2.00	14.62	14.62	-
2462MHz	Pass	2.00	13.39	13.39	-

DG = Directional Gain; Port X = Port X output power

Note : Conducted average output power is for reference only

3.4 Power Spectral Density

3.4.1 Limit of Power Spectral Density

Power spectral density shall not be greater than 8 dBm in any 3 kHz band.

3.4.2 Test Procedures

1. Set the RBW = 3 kHz, VBW = 10 kHz.
2. Detector = Peak, Sweep time = auto couple.
3. Trace mode = max hold, allow trace to fully stabilize.
4. Use the peak marker function to determine the maximum amplitude level.

3.4.3 Test Setup

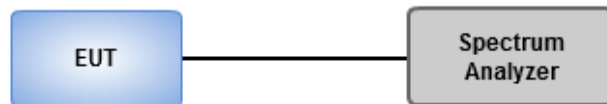

3.4.4 Test Result of Power Spectral Density

Summary

Mode	PD (dBm/RBW)
2.4-2.4835GHz	-
802.11b_Nss1,(1Mbps)_1TX	-0.19
802.11g_Nss1,(6Mbps)_1TX	-8.79
802.11n HT20_Nss1,(MCS0)_1TX	-9.37

RBW=3kHz.

Result

Mode	Result	DG (dBi)	Port 1 (dBm/RBW)	PD (dBm/RBW)	PD Limit (dBm/RBW)
802.11b_Nss1,(1Mbps)_1TX	-	-	-	-	-
2412MHz	Pass	2.00	-3.54	-3.54	8.00
2437MHz	Pass	2.00	-0.19	-0.19	8.00
2462MHz	Pass	2.00	-2.69	-2.69	8.00
802.11g_Nss1,(6Mbps)_1TX	-	-	-	-	-
2412MHz	Pass	2.00	-8.79	-8.79	8.00
2437MHz	Pass	2.00	-9.24	-9.24	8.00
2462MHz	Pass	2.00	-9.13	-9.13	8.00
802.11n HT20_Nss1,(MCS0)_1TX	-	-	-	-	-
2412MHz	Pass	2.00	-10.41	-10.41	8.00
2437MHz	Pass	2.00	-9.37	-9.37	8.00
2462MHz	Pass	2.00	-11.70	-11.70	8.00

DG = Directional Gain;

PD = trace bin-by-bin of each transmits port summing can be performed maximum power density; Port X = Port X power density;

802.11b_Nss1,(1Mbps)_1TX

PSD

2412MHz

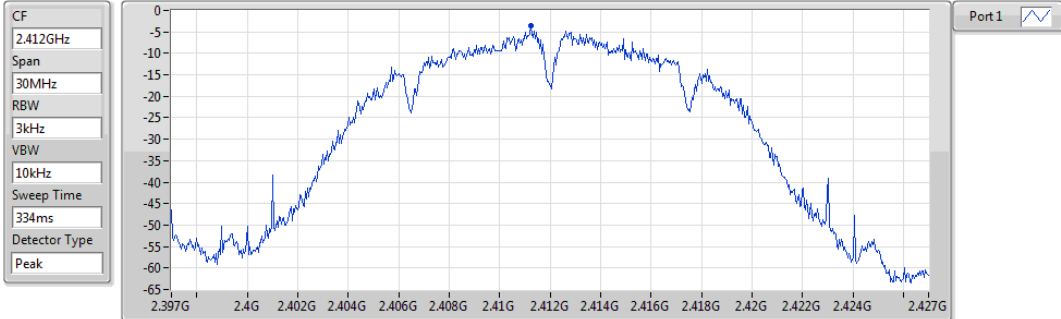

Sum	PD	Port 1
(dBm/10kHz)	(dBm/10kHz)	(dBm/10kHz)
-3.54	-3.54	-3.54

802.11b_Nss1,(1Mbps)_1TX

PSD

2437MHz

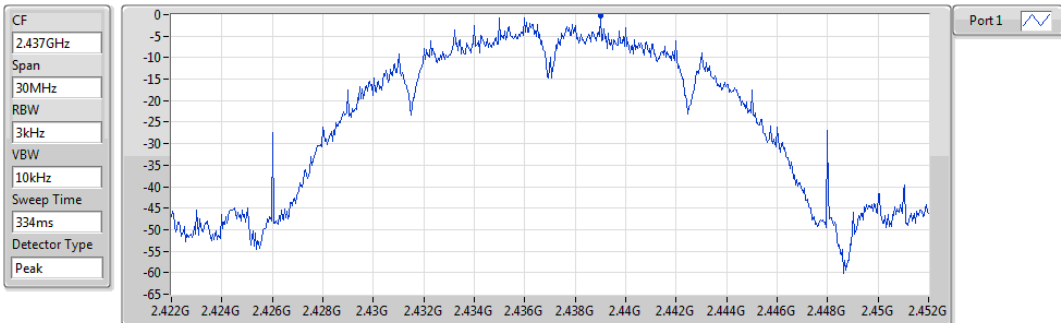

Sum	PD	Port 1
(dBm/10kHz)	(dBm/10kHz)	(dBm/10kHz)
-0.19	-0.19	-0.19

802.11b_Nss1,(1Mbps)_1TX

PSD

2462MHz

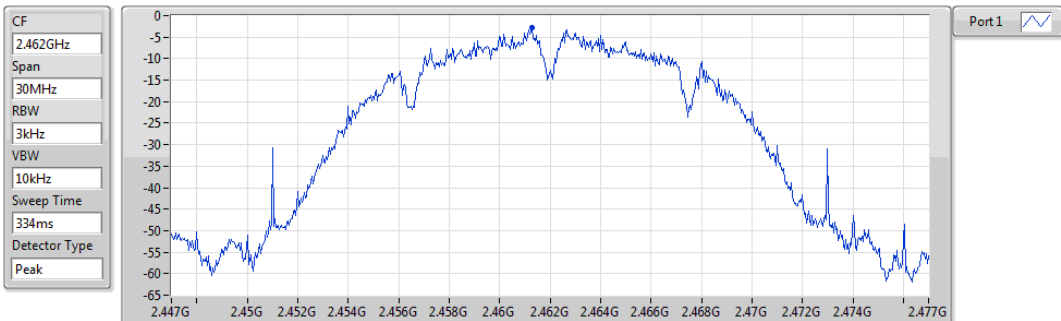

Sum	PD	Port 1
(dBm/10kHz)	(dBm/10kHz)	(dBm/10kHz)
-2.69	-2.69	-2.69

802.11g_Nss1,(6Mbps)_1TX

PSD

2412MHz

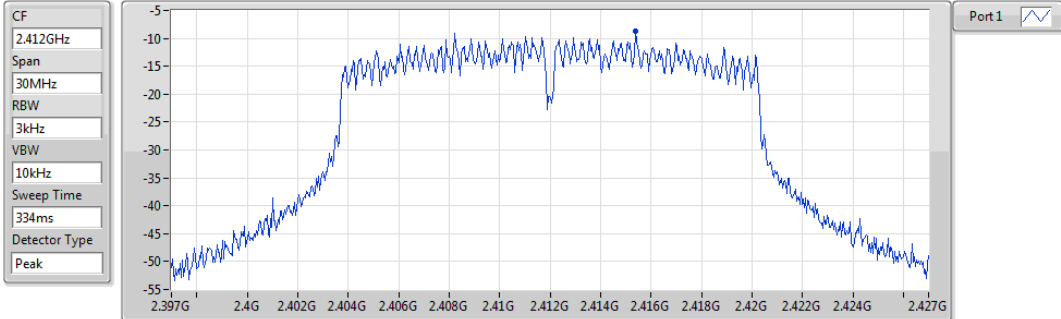

Sum	PD	Port 1
(dBm/RBW)	(dBm/RBW)	(dBm/RBW)
-8.79	-8.79	-8.79

802.11g_Nss1,(6Mbps)_1TX

PSD

2437MHz

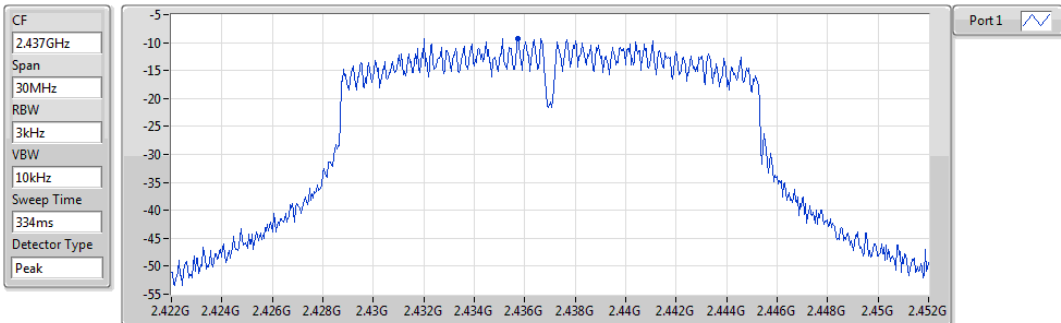

Sum	PD	Port 1
(dBm/RBW)	(dBm/RBW)	(dBm/RBW)
-9.24	-9.24	-9.24

802.11g_Nss1,(6Mbps)_1TX

PSD

2462MHz

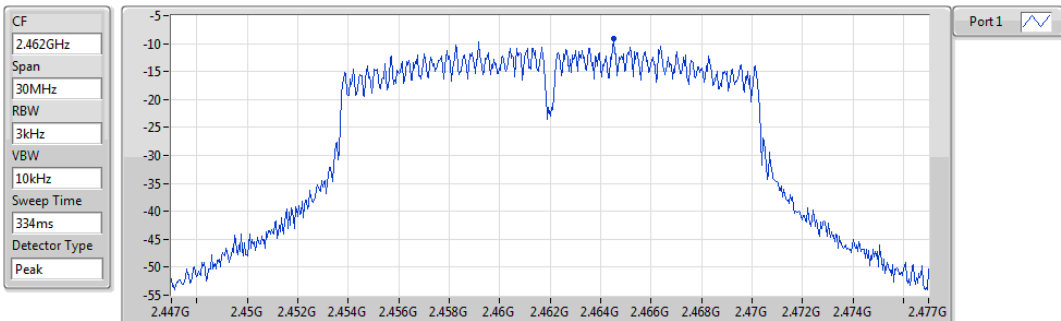

Sum	PD	Port 1
(dBm/RBW)	(dBm/RBW)	(dBm/RBW)
-9.13	-9.13	-9.13

802.11n HT20_Nss1,(MCS0)_1TX

PSD

2412MHz

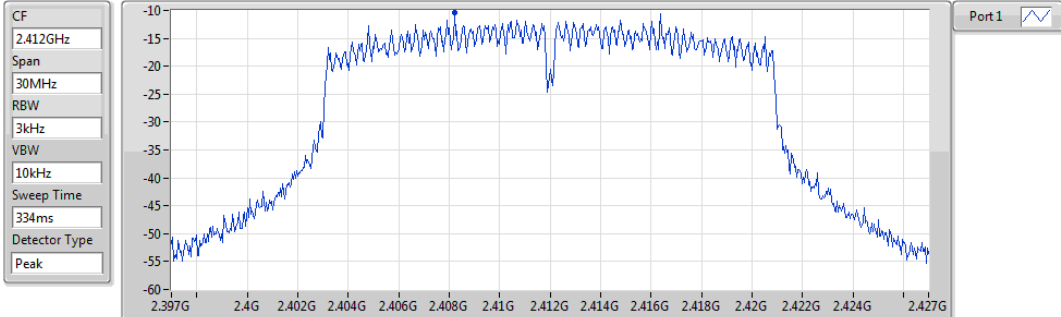

Sum	PD	Port1
(dBm/RBW)	(dBm/RBW)	(dBm/RBW)
-10.41	-10.41	-10.41

802.11n HT20_Nss1,(MCS0)_1TX

PSD

2437MHz

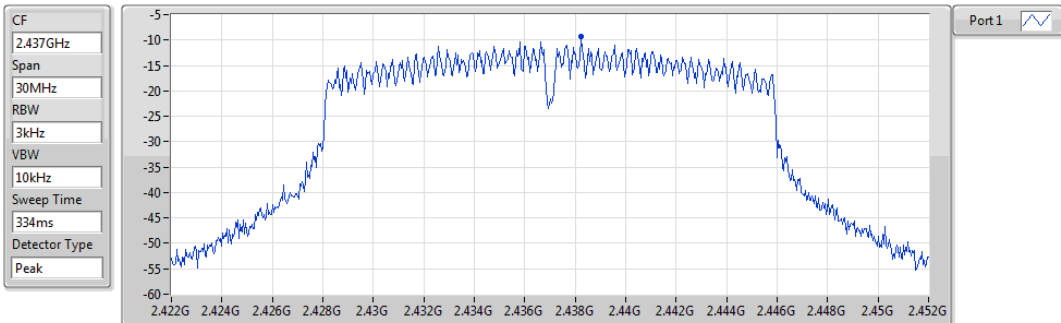

Sum	PD	Port1
(dBm/RBW)	(dBm/RBW)	(dBm/RBW)
-9.37	-9.37	-9.37

802.11n HT20_Nss1,(MCS0)_1TX

PSD

2462MHz

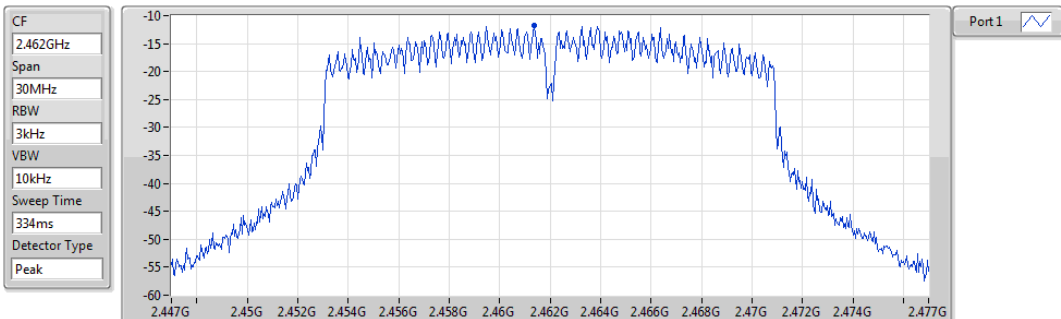

Sum	PD	Port1
(dBm/RBW)	(dBm/RBW)	(dBm/RBW)
-11.70	-11.70	-11.70

3.5 Unwanted Emissions into Restricted Frequency Bands

3.5.1 Limit of Unwanted Emissions into Restricted Frequency Bands

Restricted Band Emissions Limit			
Frequency Range (MHz)	Field Strength (uV/m)	Field Strength (dBuV/m)	Measure Distance (m)
0.009~0.490	2400/F(kHz)	48.5 - 13.8	300
0.490~1.705	24000/F(kHz)	33.8 - 23	30
1.705~30.0	30	29	30
30~88	100	40	3
88~216	150	43.5	3
216~960	200	46	3
Above 960	500	54	3

Note 1:
Quasi-Peak value is measured for frequency below 1GHz except for 9–90 kHz, 110–490 kHz frequency band. Peak and average value are measured for frequency above 1GHz. The limit on average radio frequency emission is as above table. The limit on peak radio frequency emissions is 20 dB above the maximum permitted average emission limit

Note 2:
Measurements may be performed at a distance other than what is specified provided. When performing measurements at a distance other than that specified, the results shall be extrapolated to the specified distance using an extrapolation factor as below, Frequency at or above 30 MHz: 20 dB/decade Frequency below 30 MHz: 40 dB/decade.

3.5.2 Test Procedures

1. Measurement is made at a semi-anechoic chamber that incorporates a turntable allowing a EUT rotation of 360°. A continuously-rotating, remotely-controlled turntable is installed at the test site to support the EUT and facilitate determination of the direction of maximum radiation for each EUT emission frequency. The EUT is placed at test table. For emissions testing at or below 1 GHz, the table height is 80 cm above the reference ground plane. For emission measurements above 1 GHz, the table height is 1.5 m
2. Measurement is made with the antenna positioned in both the horizontal and vertical planes of polarization. The measurement antenna is varied in height (1m ~ 4m) above the reference ground plane to obtain the maximum signal strength. Distance between EUT and antenna is 3 m.
3. This investigation is performed with the EUT rotated 360°, the antenna height scanned between 1 m and 4 m, and the antenna rotated to repeat the measurements for both the horizontal and vertical antenna polarizations.

Note:

1. 120kHz measurement bandwidth of test receiver and Quasi-peak detector is for radiated emission below 1GHz.
2. RBW=1MHz, VBW=3MHz and Peak detector is for peak measured value of radiated emission above 1GHz.
3. RBW=1MHz, VBW=1/T and Peak detector is for average measured value of radiated emission above 1GHz.

3.5.3 Test Setup

Radiated Emissions below 1 GHz

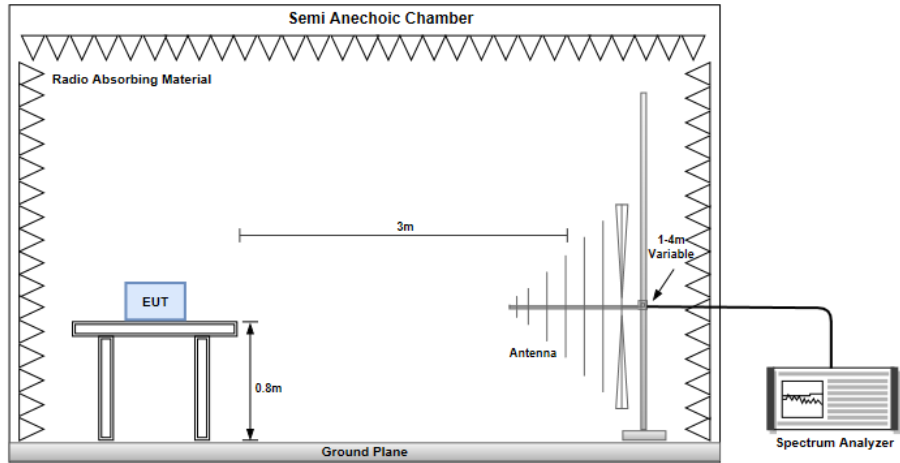

Radiated Emissions above 1 GHz

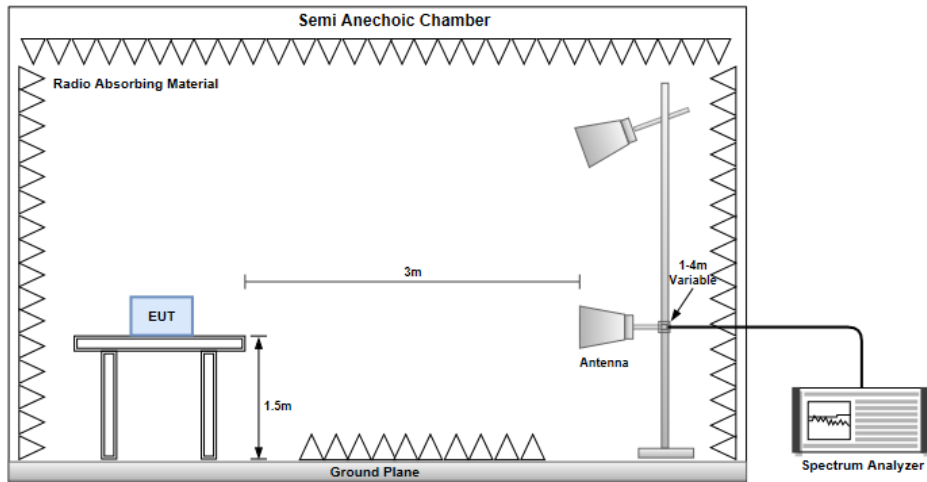

Conducted Emissions

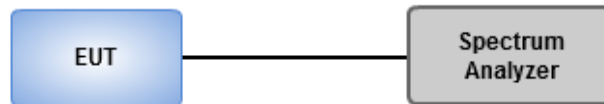

3.5.4 Transmitter Radiated Unwanted Emissions (Below 1GHz)

Modulation	11g	Test Freq. (MHz)	2437
Polarization	Horizontal		

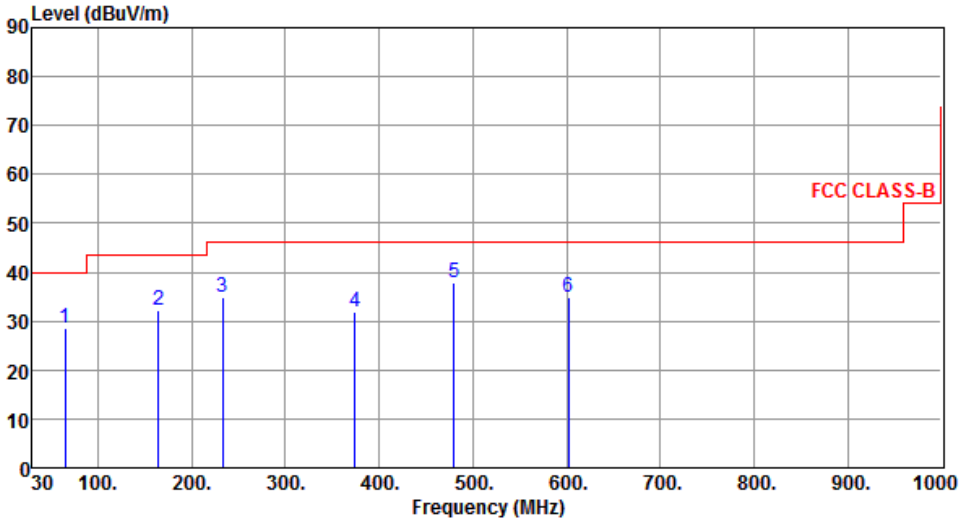

	Freq. MHz	Emission level dBuV/m	Limit dBuV/m	Margin dB	SA reading dBuV	Factor dB	Remark	ANT High cm	Turn Table deg
1	64.92	28.42	40.00	-11.58	38.00	-9.58	Peak	---	---
2	164.83	32.15	43.50	-11.35	40.48	-8.33	Peak	---	---
3	232.73	34.97	46.00	-11.03	45.07	-10.10	Peak	---	---
4	374.35	31.83	46.00	-14.17	37.52	-5.69	Peak	---	---
5	480.08	37.70	46.00	-8.30	41.01	-3.31	Peak	---	---
6	602.30	34.80	46.00	-11.20	35.43	-0.63	Peak	---	---

Note 1: Emission Level (dBuV/m) = SA Reading (dBuV/m) + Factor* (dB)
 *Factor includes antenna factor , cable loss and amplifier gain
 Note 2: Margin (dB) = Emission level (dBuV/m) – Limit (dBuV/m).
 Note 3: All spurious emissions below 30MHz are more than 20 dB below the limit.

Modulation	11g	Test Freq. (MHz)	2437
Polarization	Vertical		

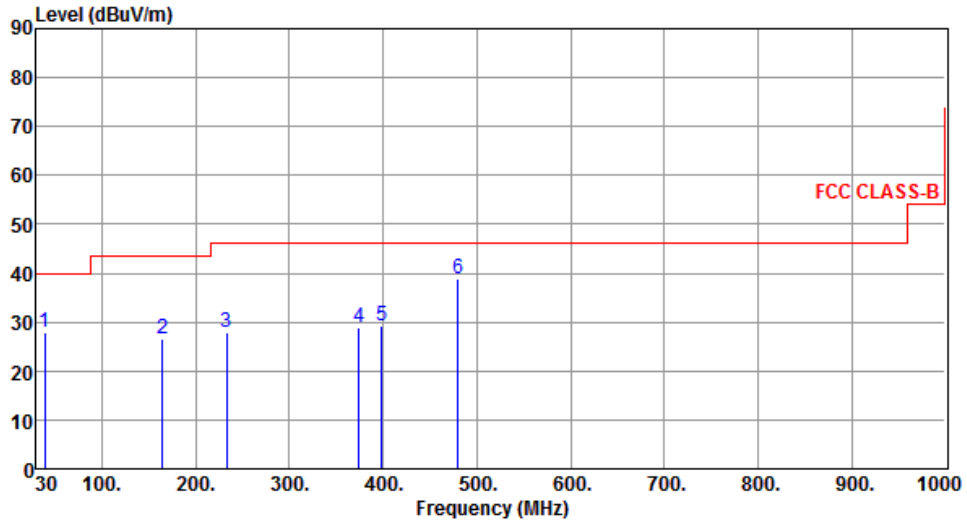

	Freq. MHz	Emission level dBuV/m	Limit dBuV/m	Margin dB	SA reading dBuV	Factor dB	Remark	ANT High cm	Turn Table deg
1	38.73	27.99	40.00	-12.01	36.25	-8.26	Peak	---	---
2	164.83	26.67	43.50	-16.83	35.00	-8.33	Peak	---	---
3	232.73	27.98	46.00	-18.02	38.08	-10.10	Peak	---	---
4	374.35	28.75	46.00	-17.25	34.44	-5.69	Peak	---	---
5	398.60	29.29	46.00	-16.71	34.41	-5.12	Peak	---	---
6	480.08	38.80	46.00	-7.20	42.11	-3.31	Peak	---	---

Note 1: Emission Level (dBuV/m) = SA Reading (dBuV/m) + Factor* (dB)

*Factor includes antenna factor , cable loss and amplifier gain

Note 2: Margin (dB) = Emission level (dBuV/m) – Limit (dBuV/m).

Note 3: All spurious emissions below 30MHz are more than 20 dB below the limit.

3.5.5 Transmitter Radiated Unwanted Emissions (Above 1GHz) for 11b

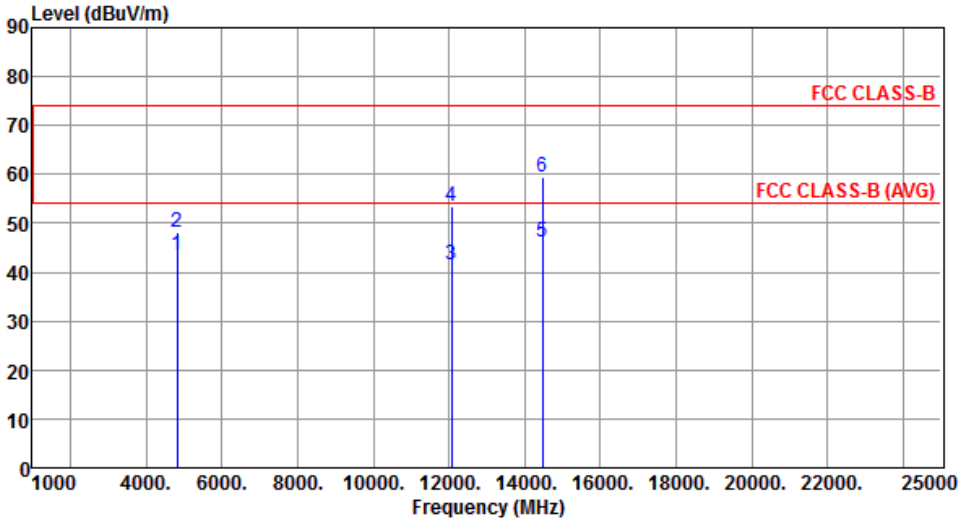
Modulation	11b	Test Freq. (MHz)	2412						
Polarization	Horizontal								
									
	Freq.	Emission level	Limit	Margin	SA reading	Factor	Remark	ANT High	Turn Table
	MHz	dBuV/m	dBuV/m	dB	dBuV	dB		cm	deg
1	4824.00	43.60	54.00	-10.40	40.07	3.53	Average	194	113
2	4824.00	48.23	74.00	-25.77	44.70	3.53	Peak	194	113
3	12060.00	41.47	54.00	-12.53	28.20	13.27	Average	100	30
4	12060.00	53.52	74.00	-20.48	40.25	13.27	Peak	100	30
5	14472.00	46.08	54.00	-7.92	28.47	17.61	Average	100	100
6	14472.00	59.60	74.00	-14.40	41.99	17.61	Peak	100	100
<p>Note 1: Emission Level (dBuV/m) = SA Reading (dBuV/m) + Factor* (dB) *Factor includes antenna factor , cable loss and amplifier gain Note 2: Margin (dB) = Emission level (dBuV/m) – Limit (dBuV/m).</p>									

Modulation	11b	Test Freq. (MHz)	2412
Polarization	Vertical		

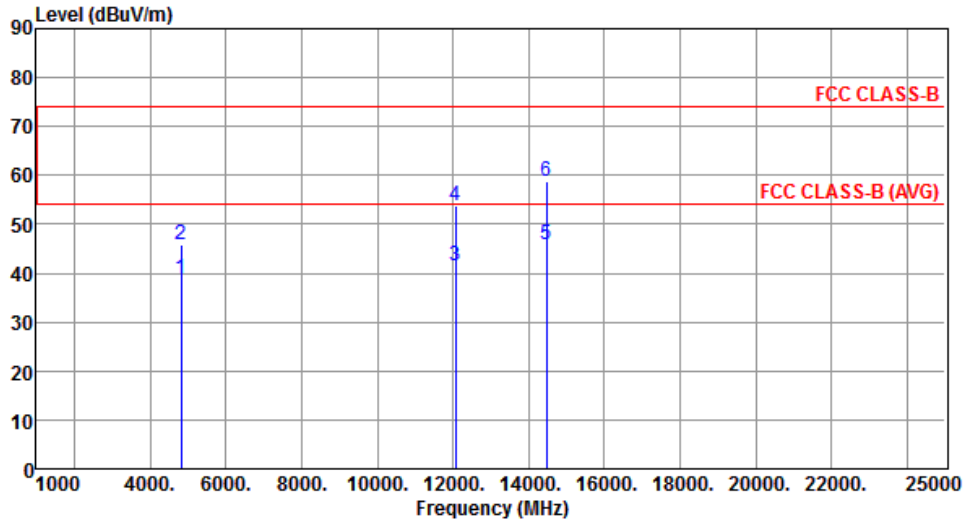

	Freq. MHz	Emission level dBuV/m	Limit dBuV/m	Margin dB	SA reading dBuV	Factor dB	Remark	ANT High cm	Turn Table deg
1	4824.00	38.90	54.00	-15.10	35.37	3.53	Average	129	320
2	4824.00	45.86	74.00	-28.14	42.33	3.53	Peak	129	320
3	12060.00	41.39	54.00	-12.61	28.12	13.27	Average	100	30
4	12060.00	53.81	74.00	-20.19	40.54	13.27	Peak	100	30
5	14472.00	45.96	54.00	-8.04	28.35	17.61	Average	100	30
6	14472.00	58.78	74.00	-15.22	41.17	17.61	Peak	100	30

Note 1: Emission Level (dBuV/m) = SA Reading (dBuV/m) + Factor* (dB)

*Factor includes antenna factor , cable loss and amplifier gain

Note 2: Margin (dB) = Emission level (dBuV/m) – Limit (dBuV/m).

Modulation	11b	Test Freq. (MHz)	2437
Polarization	Horizontal		

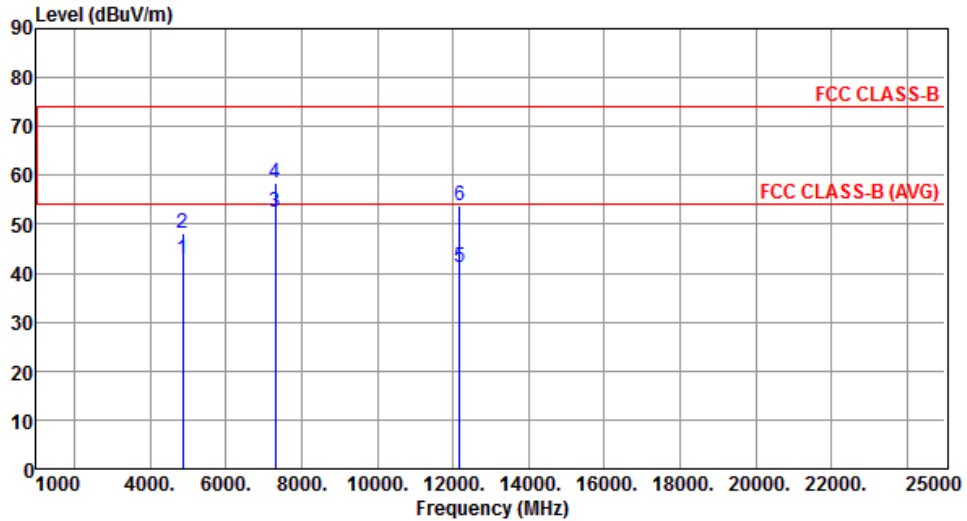

	Freq. MHz	Emission level dBuV/m	Limit dBuV/m	Margin dB	SA reading dBuV	Factor dB	Remark	ANT High cm	Turn Table deg
1	4874.00	42.92	54.00	-11.08	39.32	3.60	Average	182	116
2	4874.00	48.30	74.00	-25.70	44.70	3.60	Peak	182	116
3	7311.00	52.52	54.00	-1.48	43.70	8.82	Average	183	49
4	7311.00	58.61	74.00	-15.39	49.79	8.82	Peak	183	49
5	12185.00	41.32	54.00	-12.68	28.02	13.30	Average	100	50
6	12185.00	53.67	74.00	-20.33	40.37	13.30	Peak	100	50

Note 1: Emission Level (dBuV/m) = SA Reading (dBuV/m) + Factor* (dB)

*Factor includes antenna factor , cable loss and amplifier gain

Note 2: Margin (dB) = Emission level (dBuV/m) – Limit (dBuV/m).

Modulation	11b	Test Freq. (MHz)	2437
Polarization	Vertical		

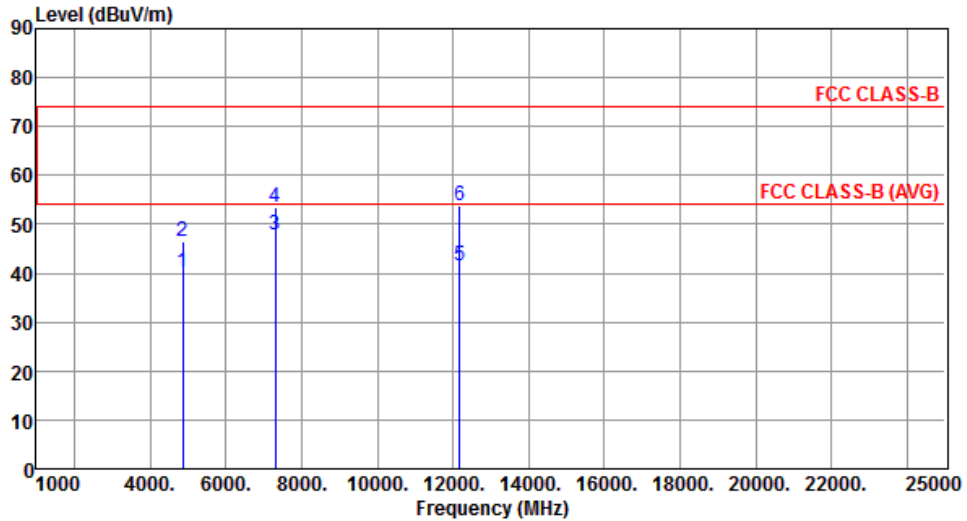

	Freq. MHz	Emission level dBuV/m	Limit dBuV/m	Margin dB	SA reading dBuV	Factor dB	Remark	ANT High cm	Turn Table deg
1	4874.00	40.26	54.00	-13.74	36.66	3.60	Average	110	319
2	4874.00	46.65	74.00	-27.35	43.05	3.60	Peak	110	319
3	7311.00	47.77	54.00	-6.23	38.95	8.82	Average	170	188
4	7311.00	53.58	74.00	-20.42	44.76	8.82	Peak	170	188
5	12185.00	41.52	54.00	-12.48	28.22	13.30	Average	100	20
6	12185.00	53.66	74.00	-20.34	40.36	13.30	Peak	100	20

Note 1: Emission Level (dBuV/m) = SA Reading (dBuV/m) + Factor* (dB)

*Factor includes antenna factor , cable loss and amplifier gain

Note 2: Margin (dB) = Emission level (dBuV/m) – Limit (dBuV/m).

Modulation	11b	Test Freq. (MHz)	2462
Polarization	Horizontal		

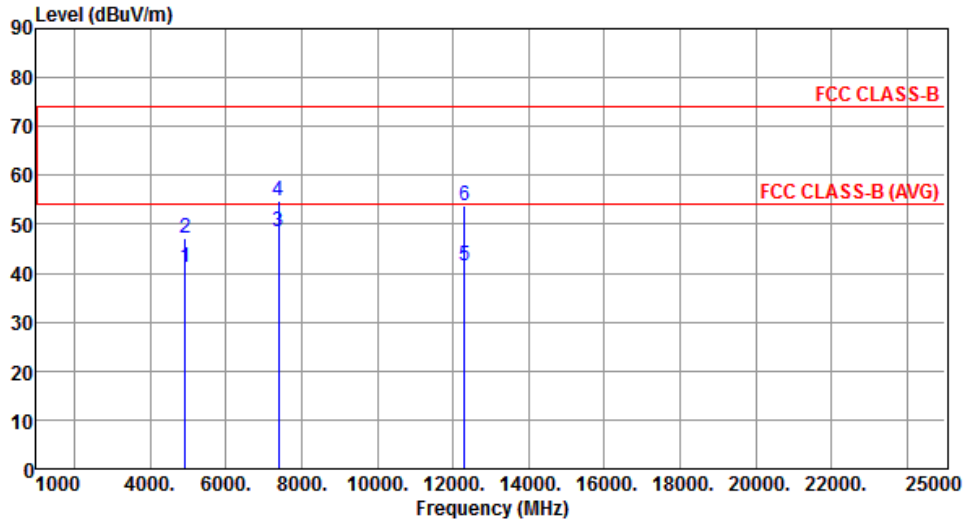

	Freq. MHz	Emission level dBuV/m	Limit dBuV/m	Margin dB	SA reading dBuV	Factor dB	Remark	ANT High cm	Turn Table deg
1	4924.00	41.29	54.00	-12.71	37.58	3.71	Average	193	116
2	4924.00	47.00	74.00	-27.00	43.29	3.71	Peak	193	116
3	7386.00	48.40	54.00	-5.60	39.85	8.55	Average	250	47
4	7386.00	54.95	74.00	-19.05	46.40	8.55	Peak	250	47
5	12310.00	41.46	54.00	-12.54	28.24	13.22	Average	100	100
6	12310.00	53.78	74.00	-20.22	40.56	13.22	Peak	100	100

Note 1: Emission Level (dBuV/m) = SA Reading (dBuV/m) + Factor* (dB)

*Factor includes antenna factor , cable loss and amplifier gain

Note 2: Margin (dB) = Emission level (dBuV/m) – Limit (dBuV/m).

Modulation	11b	Test Freq. (MHz)	2462
Polarization	Vertical		

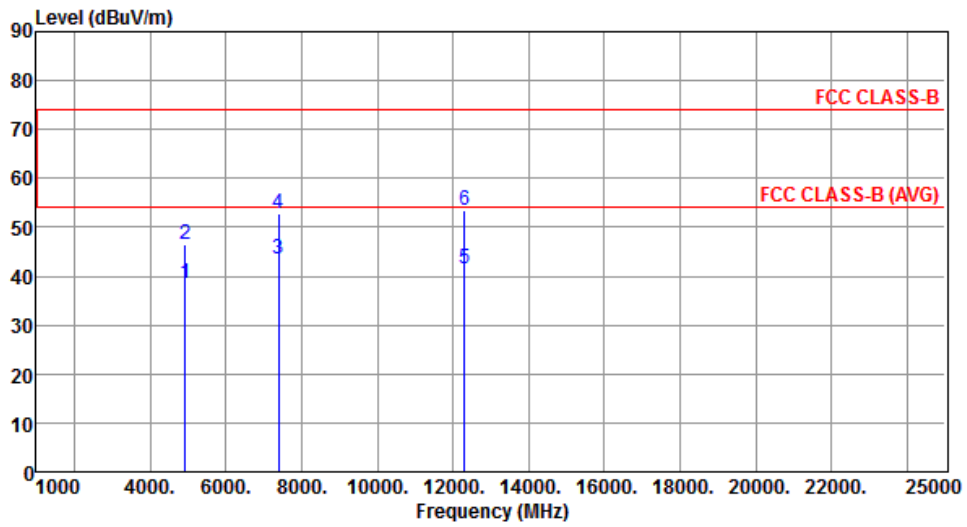

	Freq. MHz	Emission level dBuV/m	Limit dBuV/m	Margin dB	SA reading dBuV	Factor dB	Remark	ANT High cm	Turn Table deg
1	4924.00	38.38	54.00	-15.62	34.67	3.71	Average	129	337
2	4924.00	46.49	74.00	-27.51	42.78	3.71	Peak	129	337
3	7386.00	43.56	54.00	-10.44	35.01	8.55	Average	176	192
4	7386.00	52.81	74.00	-21.19	44.26	8.55	Peak	176	192
5	12310.00	41.35	54.00	-12.65	28.13	13.22	Average	100	20
6	12310.00	53.50	74.00	-20.50	40.28	13.22	Peak	100	20

Note 1: Emission Level (dBuV/m) = SA Reading (dBuV/m) + Factor* (dB)

*Factor includes antenna factor , cable loss and amplifier gain

Note 2: Margin (dB) = Emission level (dBuV/m) – Limit (dBuV/m).

3.5.6 Transmitter Radiated Unwanted Emissions (Above 1GHz) for 11g

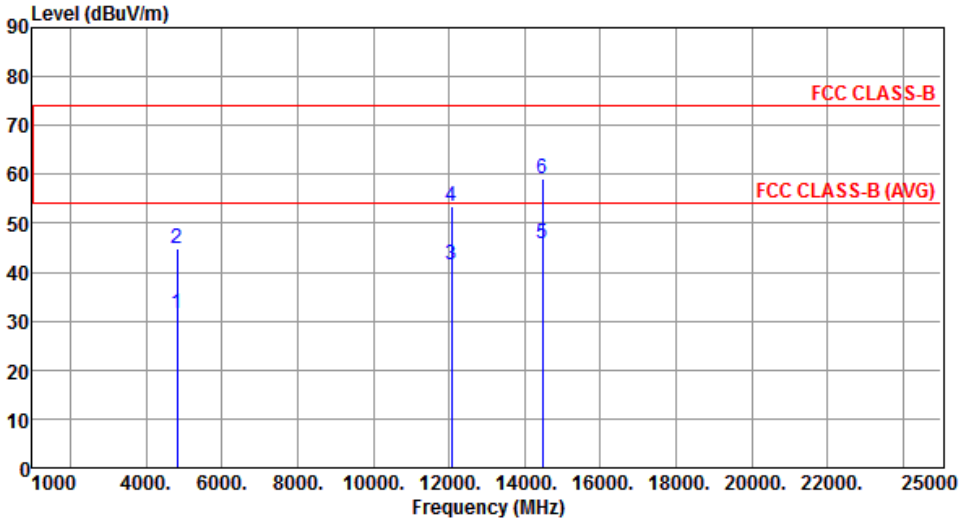
Modulation	11g	Test Freq. (MHz)	2412						
Polarization	Horizontal								
									
	Freq.	Emission level	Limit	Margin	SA reading	Factor	Remark	ANT High	Turn Table
	MHz	dBuV/m	dBuV/m	dB	dBuV	dB		cm	deg
1	4824.00	31.59	54.00	-22.41	28.06	3.53	Average	149	121
2	4824.00	44.77	74.00	-29.23	41.24	3.53	Peak	149	121
3	12060.00	41.39	54.00	-12.61	28.12	13.27	Average	100	20
4	12060.00	53.62	74.00	-20.38	40.35	13.27	Peak	100	20
5	14472.00	45.86	54.00	-8.14	28.25	17.61	Average	100	100
6	14472.00	59.18	74.00	-14.82	41.57	17.61	Peak	100	100
<p>Note 1: Emission Level (dBuV/m) = SA Reading (dBuV/m) + Factor* (dB) *Factor includes antenna factor , cable loss and amplifier gain Note 2: Margin (dB) = Emission level (dBuV/m) – Limit (dBuV/m).</p>									

Modulation	11g	Test Freq. (MHz)	2412
Polarization	Vertical		

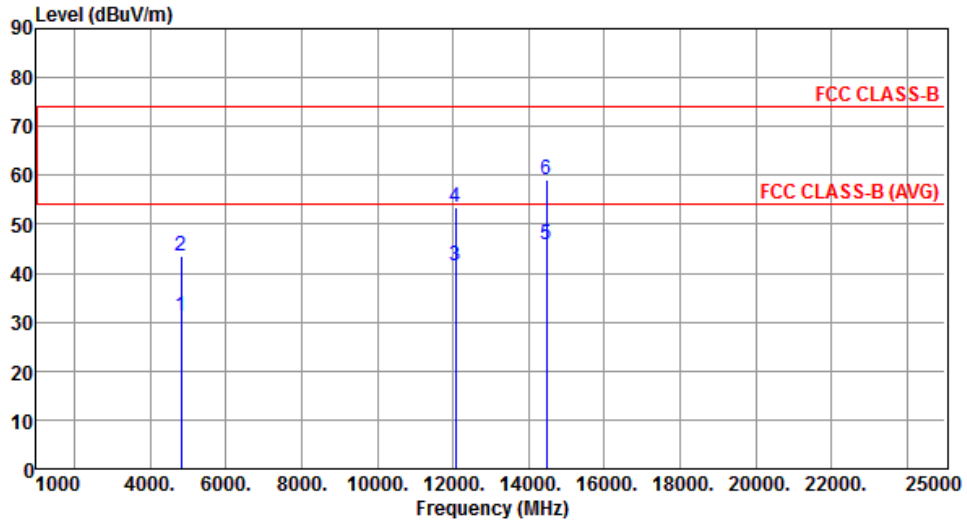

	Freq. MHz	Emission level dBuV/m	Limit dBuV/m	Margin dB	SA reading dBuV	Factor dB	Remark	ANT High cm	Turn Table deg
1	4824.00	31.08	54.00	-22.92	27.55	3.53	Average	100	30
2	4824.00	43.65	74.00	-30.35	40.12	3.53	Peak	100	30
3	12060.00	41.41	54.00	-12.59	28.14	13.27	Average	100	40
4	12060.00	53.53	74.00	-20.47	40.26	13.27	Peak	100	40
5	14472.00	45.86	54.00	-8.14	28.25	17.61	Average	100	90
6	14472.00	59.07	74.00	-14.93	41.46	17.61	Peak	100	90

Note 1: Emission Level (dBuV/m) = SA Reading (dBuV/m) + Factor* (dB)

*Factor includes antenna factor , cable loss and amplifier gain

Note 2: Margin (dB) = Emission level (dBuV/m) – Limit (dBuV/m).

Modulation	11g	Test Freq. (MHz)	2437
Polarization	Horizontal		

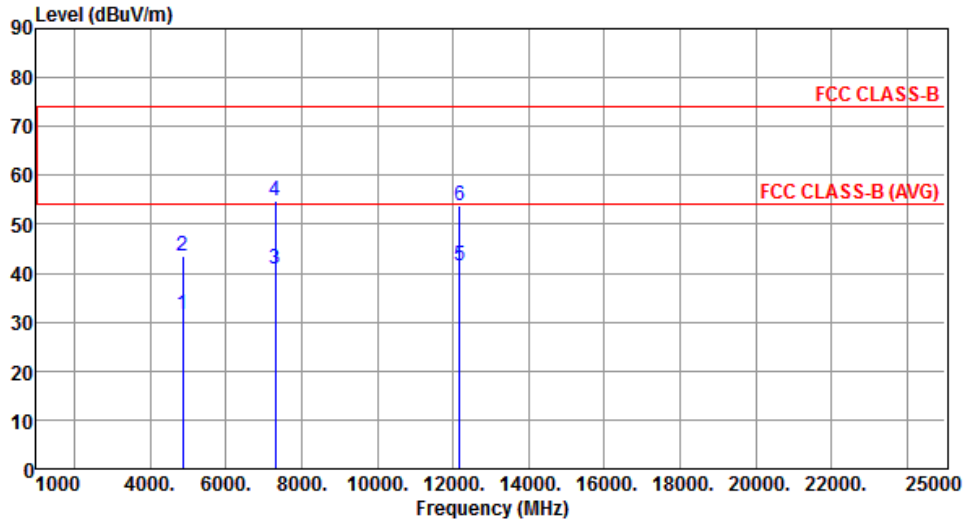

	Freq. MHz	Emission level dBuV/m	Limit dBuV/m	Margin dB	SA reading dBuV	Factor dB	Remark	ANT High cm	Turn Table deg
1	4874.00	31.41	54.00	-22.59	27.81	3.60	Average	121	121
2	4874.00	43.63	74.00	-30.37	40.03	3.60	Peak	121	121
3	7311.00	40.71	54.00	-13.29	31.89	8.82	Average	156	44
4	7311.00	54.66	74.00	-19.34	45.84	8.82	Peak	156	44
5	12185.00	41.54	54.00	-12.46	28.24	13.30	Average	100	30
6	12185.00	53.76	74.00	-20.24	40.46	13.30	Peak	100	30

Note 1: Emission Level (dBuV/m) = SA Reading (dBuV/m) + Factor* (dB)

*Factor includes antenna factor , cable loss and amplifier gain

Note 2: Margin (dB) = Emission level (dBuV/m) – Limit (dBuV/m).

Modulation	11g	Test Freq. (MHz)	2437
Polarization	Vertical		

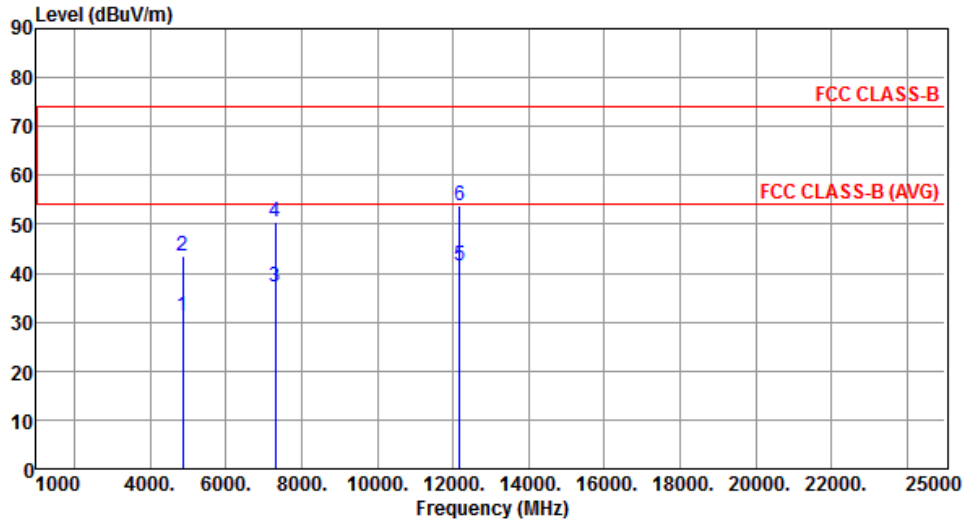

	Freq. MHz	Emission level dBuV/m	Limit dBuV/m	Margin dB	SA reading dBuV	Factor dB	Remark	ANT High cm	Turn Table deg
1	4874.00	31.25	54.00	-22.75	27.65	3.60	Average	100	30
2	4874.00	43.62	74.00	-30.38	40.02	3.60	Peak	100	30
3	7311.00	37.35	54.00	-16.65	28.53	8.82	Average	100	187
4	7311.00	50.58	74.00	-23.42	41.76	8.82	Peak	100	187
5	12185.00	41.46	54.00	-12.54	28.16	13.30	Average	100	30
6	12185.00	53.84	74.00	-20.16	40.54	13.30	Peak	100	30

Note 1: Emission Level (dBuV/m) = SA Reading (dBuV/m) + Factor* (dB)

*Factor includes antenna factor , cable loss and amplifier gain

Note 2: Margin (dB) = Emission level (dBuV/m) – Limit (dBuV/m).

Modulation	11g	Test Freq. (MHz)	2462
Polarization	Horizontal		

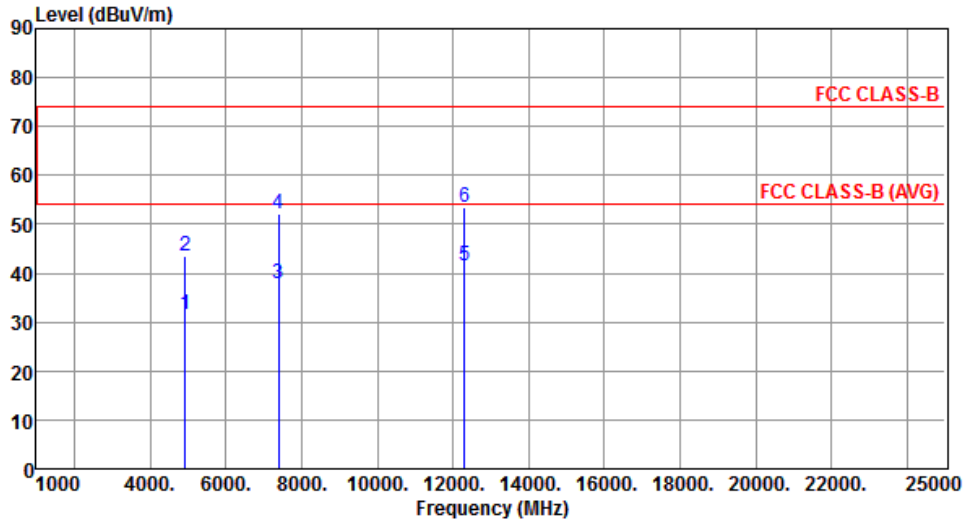

	Freq. MHz	Emission level dBuV/m	Limit dBuV/m	Margin dB	SA reading dBuV	Factor dB	Remark	ANT High cm	Turn Table deg
1	4924.00	31.41	54.00	-22.59	27.70	3.71	Average	100	30
2	4924.00	43.57	74.00	-30.43	39.86	3.71	Peak	100	30
3	7386.00	38.00	54.00	-16.00	29.45	8.55	Average	150	40
4	7386.00	52.24	74.00	-21.76	43.69	8.55	Peak	150	40
5	12310.00	41.46	54.00	-12.54	28.24	13.22	Average	100	30
6	12310.00	53.60	74.00	-20.40	40.38	13.22	Peak	100	30

Note 1: Emission Level (dBuV/m) = SA Reading (dBuV/m) + Factor* (dB)

*Factor includes antenna factor , cable loss and amplifier gain

Note 2: Margin (dB) = Emission level (dBuV/m) – Limit (dBuV/m).

Modulation	11g	Test Freq. (MHz)	2462
Polarization	Vertical		

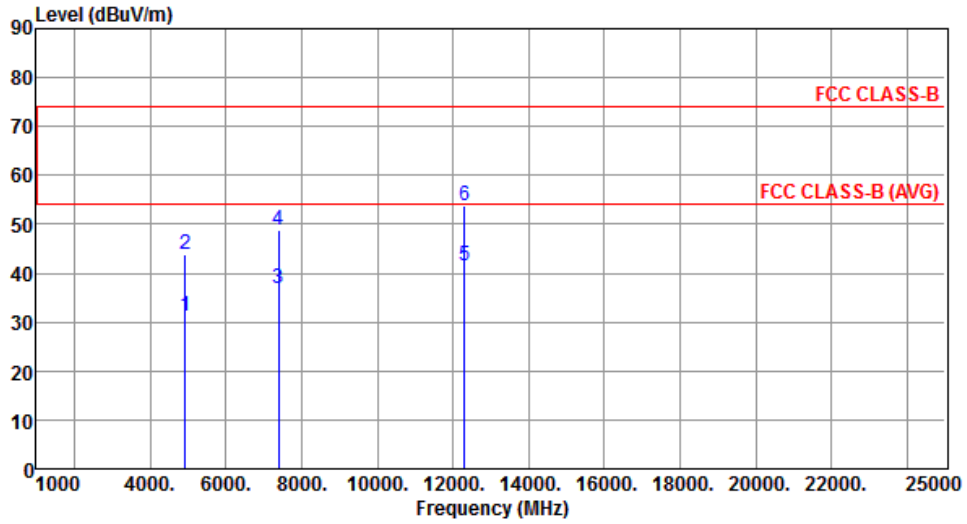

	Freq. MHz	Emission level dBuV/m	Limit dBuV/m	Margin dB	SA reading dBuV	Factor dB	Remark	ANT High cm	Turn Table deg
1	4924.00	31.30	54.00	-22.70	27.59	3.71	Average	100	50
2	4924.00	43.68	74.00	-30.32	39.97	3.71	Peak	100	50
3	7386.00	36.79	54.00	-17.21	28.24	8.55	Average	100	60
4	7386.00	48.82	74.00	-25.18	40.27	8.55	Peak	100	60
5	12310.00	41.35	54.00	-12.65	28.13	13.22	Average	100	80
6	12310.00	53.90	74.00	-20.10	40.68	13.22	Peak	100	80

Note 1: Emission Level (dBuV/m) = SA Reading (dBuV/m) + Factor* (dB)

*Factor includes antenna factor , cable loss and amplifier gain

Note 2: Margin (dB) = Emission level (dBuV/m) – Limit (dBuV/m).

3.5.7 Transmitter Radiated Unwanted Emissions (Above 1GHz) for HT20

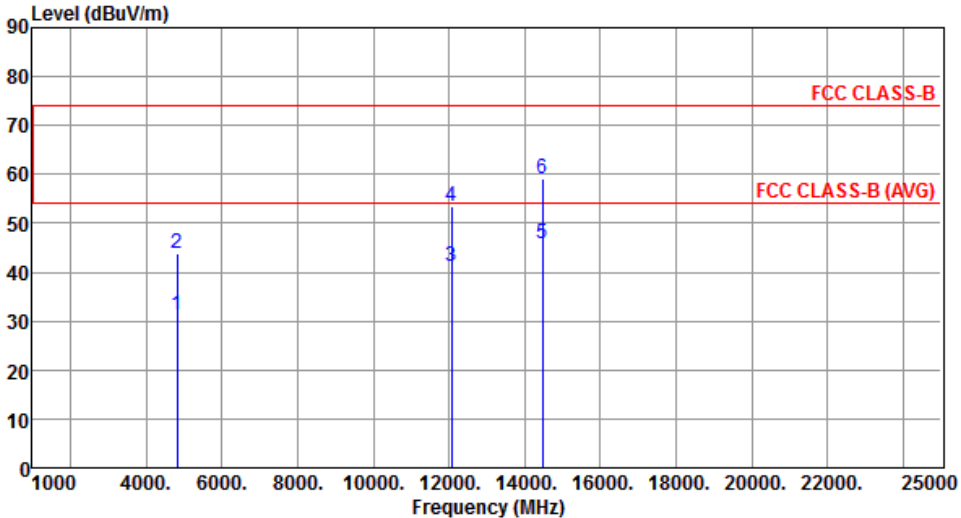
Modulation	HT20	Test Freq. (MHz)	2412						
Polarization	Horizontal								
									
	Freq.	Emission level	Limit	Margin	SA reading	Factor	Remark	ANT High	Turn Table
	MHz	dBuV/m	dBuV/m	dB	dBuV	dB		cm	deg
1	4824.00	31.23	54.00	-22.77	27.70	3.53	Average	100	120
2	4824.00	43.92	74.00	-30.08	40.39	3.53	Peak	100	120
3	12060.00	41.32	54.00	-12.68	28.05	13.27	Average	100	50
4	12060.00	53.48	74.00	-20.52	40.21	13.27	Peak	100	50
5	14472.00	45.75	54.00	-8.25	28.14	17.61	Average	100	90
6	14472.00	59.07	74.00	-14.93	41.46	17.61	Peak	100	90
<p>Note 1: Emission Level (dBuV/m) = SA Reading (dBuV/m) + Factor* (dB) *Factor includes antenna factor , cable loss and amplifier gain Note 2: Margin (dB) = Emission level (dBuV/m) – Limit (dBuV/m).</p>									

Modulation	HT20	Test Freq. (MHz)	2412
Polarization	Vertical		

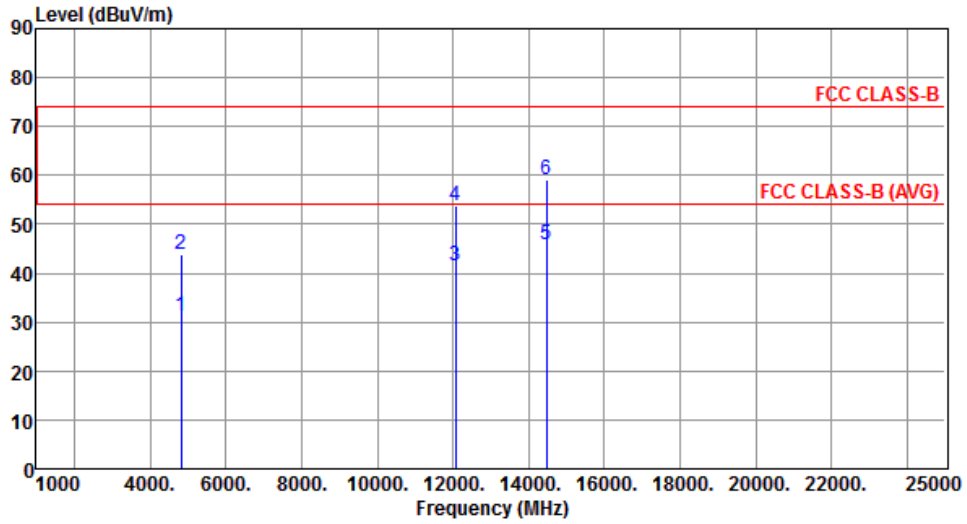

	Freq. MHz	Emission level dBuV/m	Limit dBuV/m	Margin dB	SA reading dBuV	Factor dB	Remark	ANT High cm	Turn Table deg
1	4824.00	31.22	54.00	-22.78	27.69	3.53	Average	100	25
2	4824.00	43.79	74.00	-30.21	40.26	3.53	Peak	100	25
3	12060.00	41.43	54.00	-12.57	28.16	13.27	Average	100	60
4	12060.00	53.65	74.00	-20.35	40.38	13.27	Peak	100	60
5	14472.00	45.81	54.00	-8.19	28.20	17.61	Average	100	70
6	14472.00	58.97	74.00	-15.03	41.36	17.61	Peak	100	70

Note 1: Emission Level (dBuV/m) = SA Reading (dBuV/m) + Factor* (dB)

*Factor includes antenna factor , cable loss and amplifier gain

Note 2: Margin (dB) = Emission level (dBuV/m) – Limit (dBuV/m).

Modulation	HT20	Test Freq. (MHz)	2437
Polarization	Horizontal		

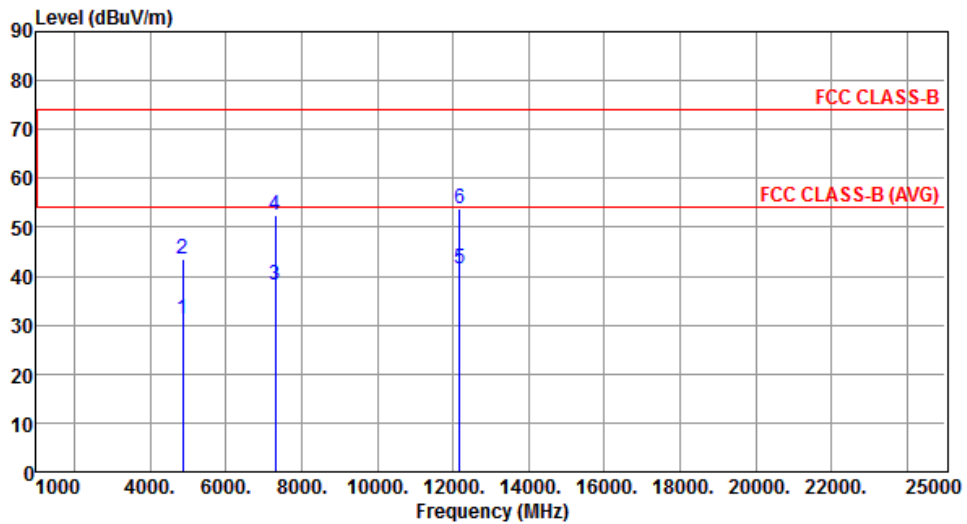

	Freq. MHz	Emission level dBuV/m	Limit dBuV/m	Margin dB	SA reading dBuV	Factor dB	Remark	ANT High cm	Turn Table deg
1	4874.00	31.24	54.00	-22.76	27.64	3.60	Average	100	119
2	4874.00	43.61	74.00	-30.39	40.01	3.60	Peak	100	119
3	7311.00	38.27	54.00	-15.73	29.45	8.82	Average	140	46
4	7311.00	52.47	74.00	-21.53	43.65	8.82	Peak	140	46
5	12185.00	41.42	54.00	-12.58	28.12	13.30	Average	100	25
6	12185.00	53.89	74.00	-20.11	40.59	13.30	Peak	100	25

Note 1: Emission Level (dBuV/m) = SA Reading (dBuV/m) + Factor* (dB)

*Factor includes antenna factor , cable loss and amplifier gain

Note 2: Margin (dB) = Emission level (dBuV/m) – Limit (dBuV/m).

Modulation	HT20	Test Freq. (MHz)	2437
Polarization	Vertical		

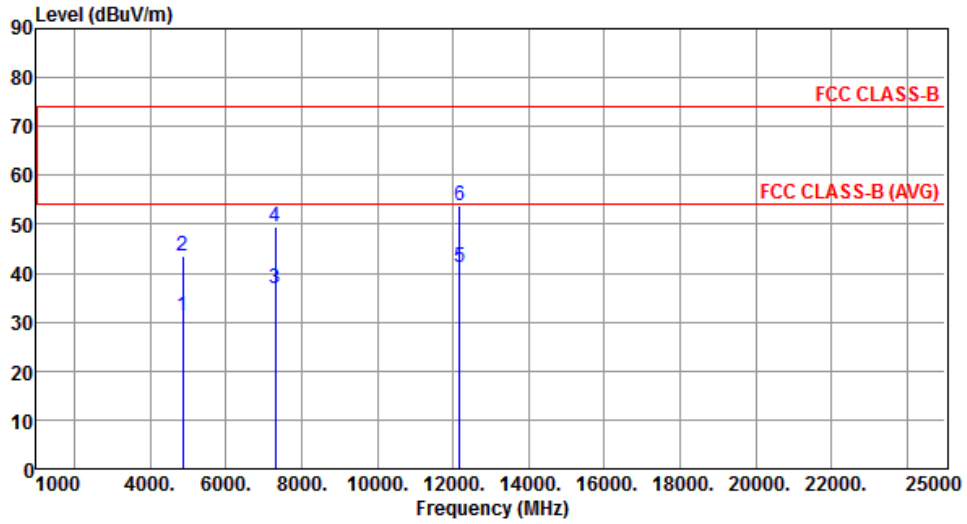

	Freq. MHz	Emission level dBuV/m	Limit dBuV/m	Margin dB	SA reading dBuV	Factor dB	Remark	ANT High cm	Turn Table deg
1	4874.00	31.27	54.00	-22.73	27.67	3.60	Average	100	20
2	4874.00	43.55	74.00	-30.45	39.95	3.60	Peak	100	20
3	7311.00	36.94	54.00	-17.06	28.12	8.82	Average	100	50
4	7311.00	49.40	74.00	-24.60	40.58	8.82	Peak	100	50
5	12185.00	41.34	54.00	-12.66	28.04	13.30	Average	100	60
6	12185.00	53.92	74.00	-20.08	40.62	13.30	Peak	100	60

Note 1: Emission Level (dBuV/m) = SA Reading (dBuV/m) + Factor* (dB)

*Factor includes antenna factor , cable loss and amplifier gain

Note 2: Margin (dB) = Emission level (dBuV/m) – Limit (dBuV/m).

Modulation	HT20	Test Freq. (MHz)	2462
Polarization	Horizontal		

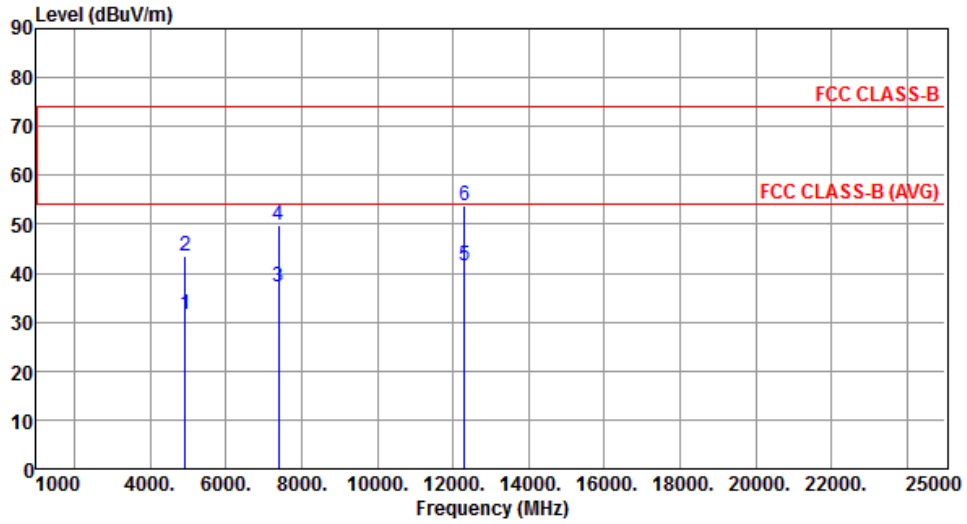

	Freq. MHz	Emission level dBuV/m	Limit dBuV/m	Margin dB	SA reading dBuV	Factor dB	Remark	ANT High cm	Turn Table deg
1	4924.00	31.48	54.00	-22.52	27.77	3.71	Average	100	25
2	4924.00	43.67	74.00	-30.33	39.96	3.71	Peak	100	25
3	7386.00	37.20	54.00	-16.80	28.65	8.55	Average	100	39
4	7386.00	49.81	74.00	-24.19	41.26	8.55	Peak	100	39
5	12310.00	41.48	54.00	-12.52	28.26	13.22	Average	100	40
6	12310.00	53.66	74.00	-20.34	40.44	13.22	Peak	100	40

Note 1: Emission Level (dBuV/m) = SA Reading (dBuV/m) + Factor* (dB)

*Factor includes antenna factor , cable loss and amplifier gain

Note 2: Margin (dB) = Emission level (dBuV/m) – Limit (dBuV/m).

Modulation	HT20	Test Freq. (MHz)	2462
Polarization	Vertical		

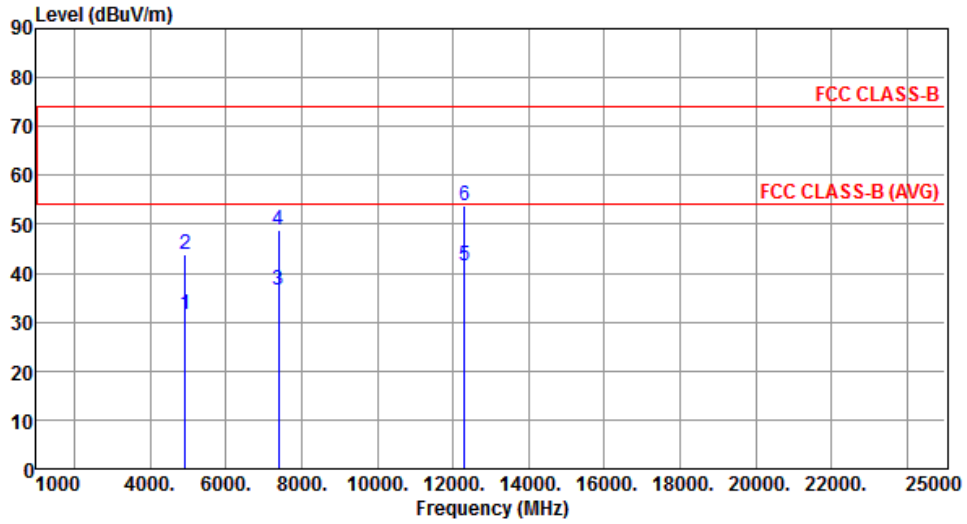

	Freq. MHz	Emission level dBuV/m	Limit dBuV/m	Margin dB	SA reading dBuV	Factor dB	Remark	ANT High cm	Turn Table deg
1	4924.00	31.56	54.00	-22.44	27.85	3.71	Average	100	60
2	4924.00	43.84	74.00	-30.16	40.13	3.71	Peak	100	60
3	7386.00	36.69	54.00	-17.31	28.14	8.55	Average	100	90
4	7386.00	48.88	74.00	-25.12	40.33	8.55	Peak	100	90
5	12310.00	41.45	54.00	-12.55	28.23	13.22	Average	100	70
6	12310.00	53.76	74.00	-20.24	40.54	13.22	Peak	100	70

Note 1: Emission Level (dBuV/m) = SA Reading (dBuV/m) + Factor* (dB)

*Factor includes antenna factor , cable loss and amplifier gain

Note 2: Margin (dB) = Emission level (dBuV/m) – Limit (dBuV/m).

3.5.8 Transmitter Conducted Unwanted Emissions (Below 1 GHz)

Modulation Mode		11b		Frequency		2437MHz	
Range (MHz)	Max Value chain0 (dBm)	DG (dBi)	GRF (dB)	EIRP (dBm)	Min E-Field Limit (dBm)	E-Field Margin (dB)	
30-88	-68.98	2.00	4.77	-62.21	-55.20	-7.01	
88-216	-68.84	2.00	4.77	-62.07	-51.70	-10.37	
216-960	-56.93	2.00	4.77	-50.16	-49.20	-0.96	
960-1000	-68.68	2.00	4.77	-61.91	-41.20	-20.71	

Note:

1. GRF = Ground Reflection Factor.
2. DG = Directional Gain.
3. Worst case of emission limit below 1GHz is selected to be limit.

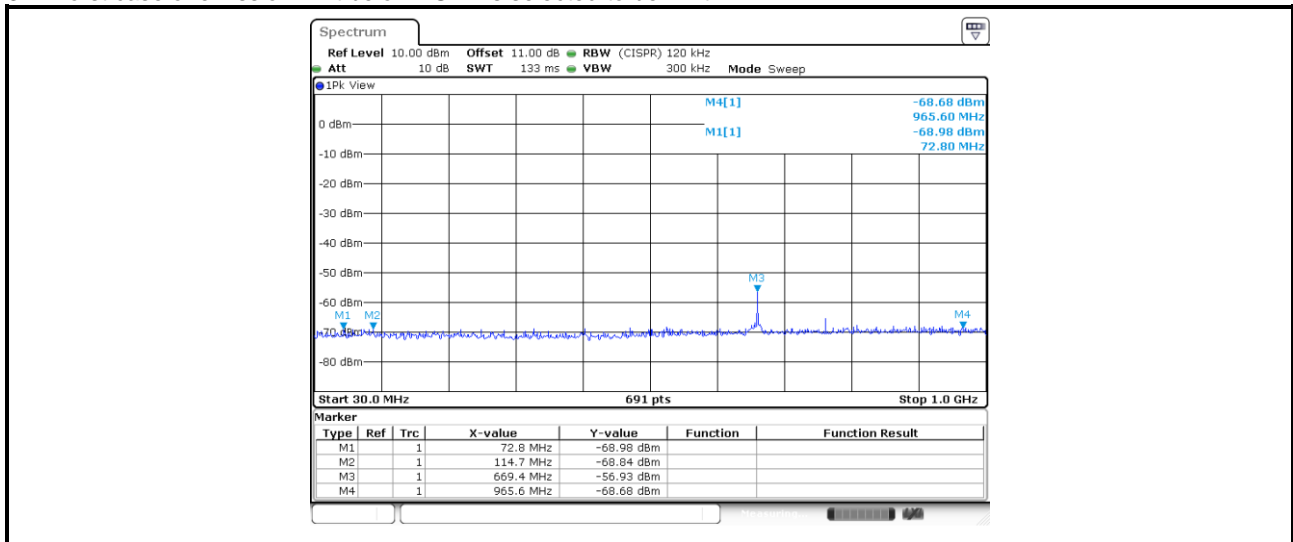

3.5.9 Transmitter Conducted Unwanted Emissions (Above 1GHz)

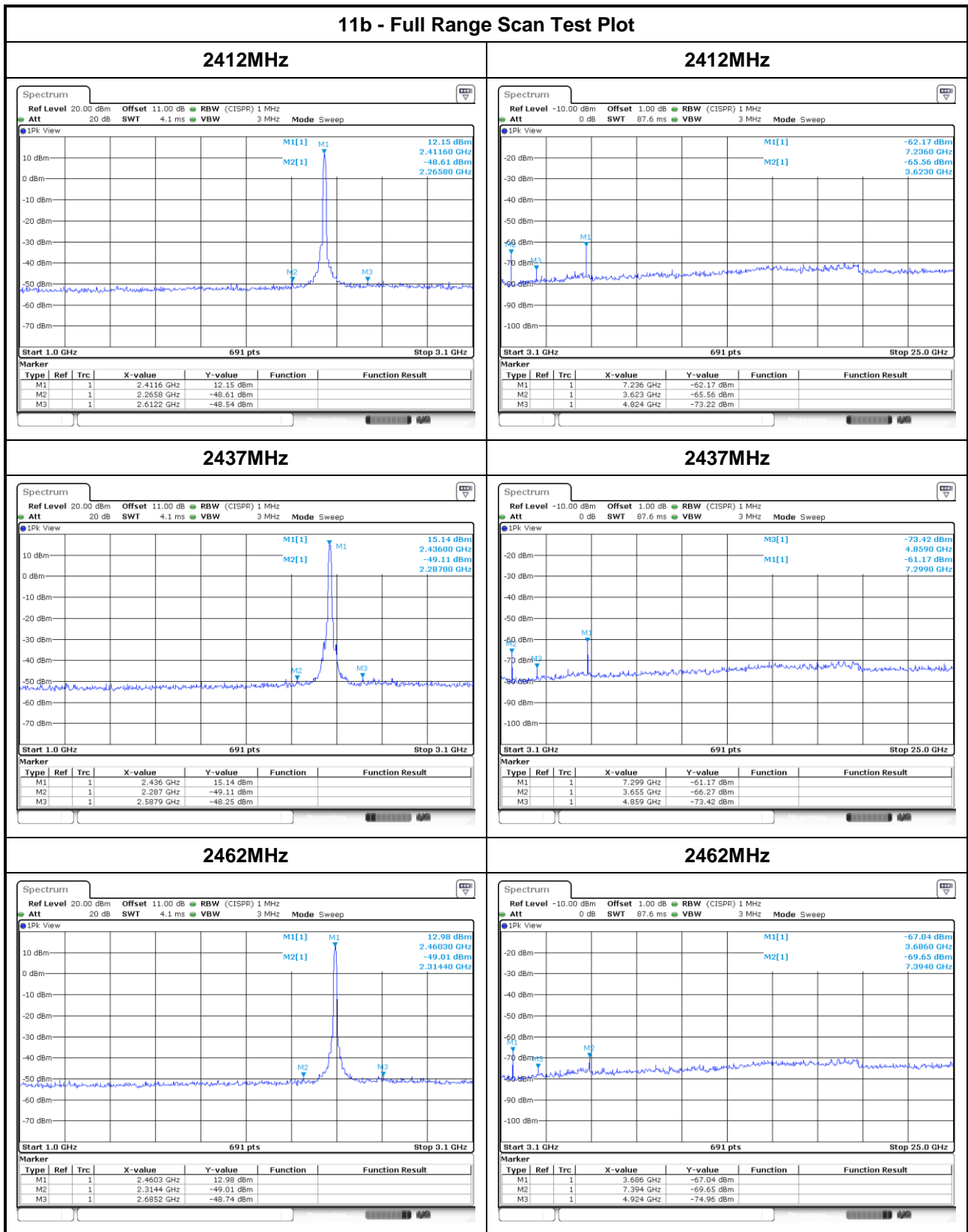

11g - Full Range Scan Test Plot

2412MHz

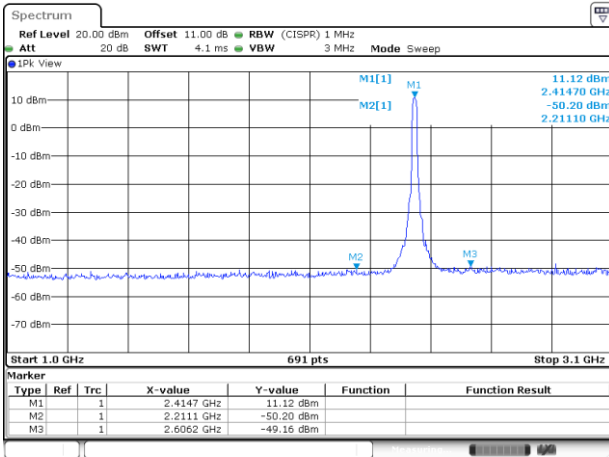

2412MHz

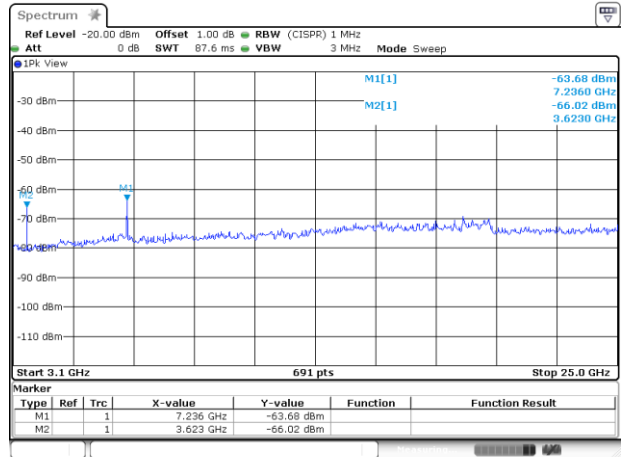

2437MHz

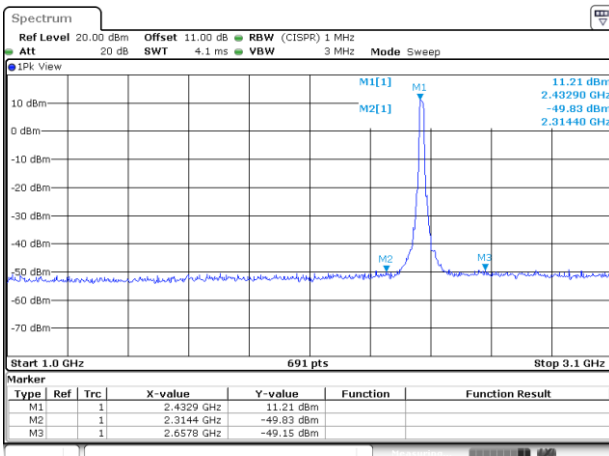

2437MHz

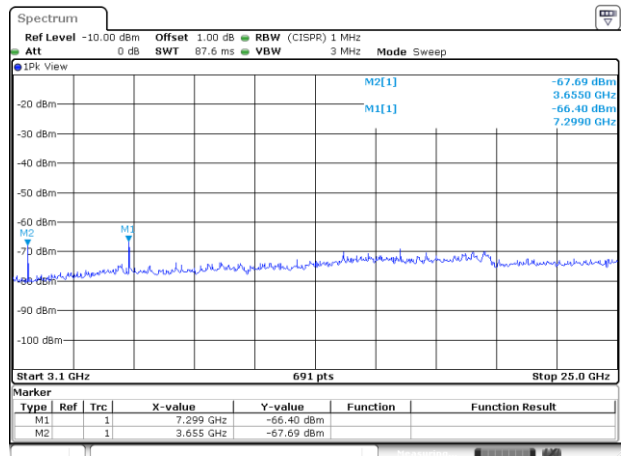

2462MHz

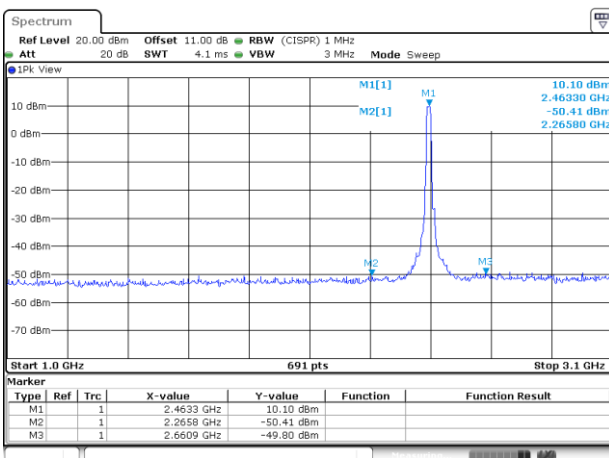

2462MHz

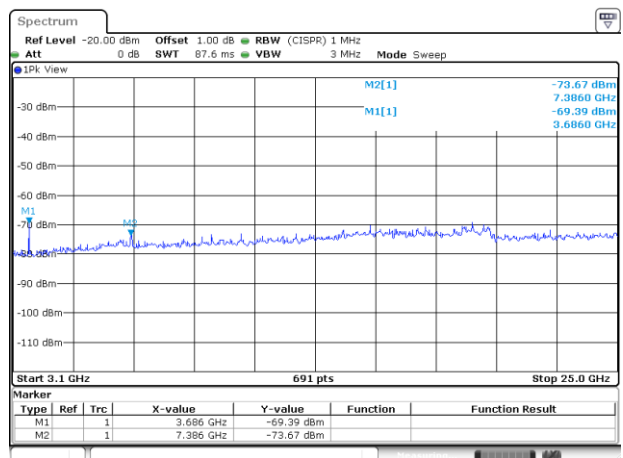

HT20 - Full Range Scan Test Plot

2412MHz

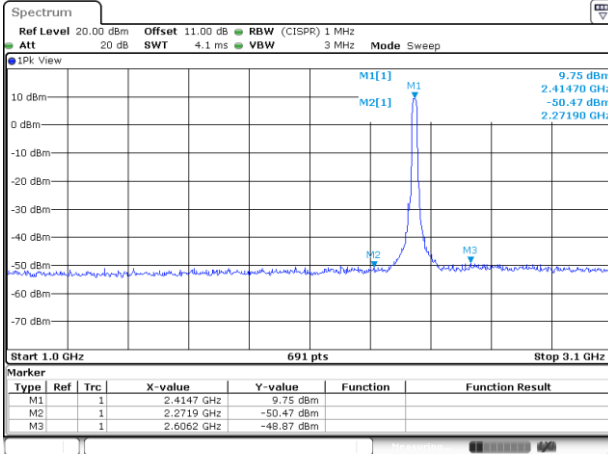

2412MHz

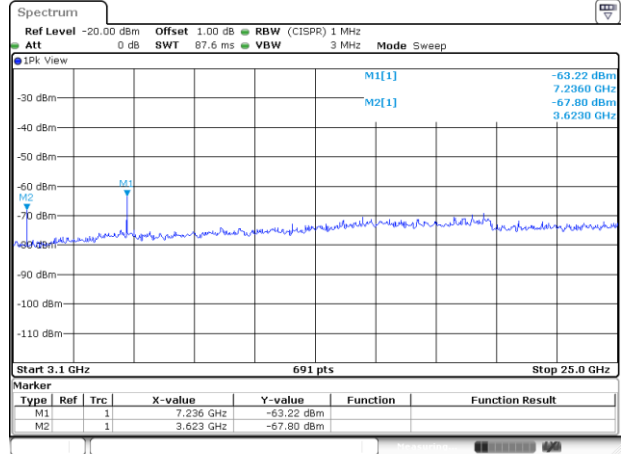

2437MHz

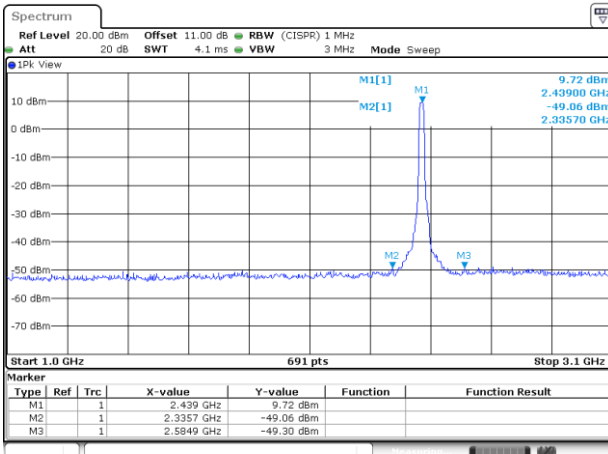

2437MHz

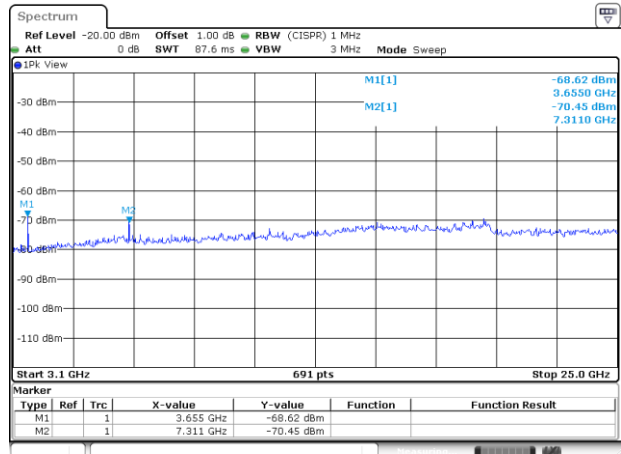

2462MHz

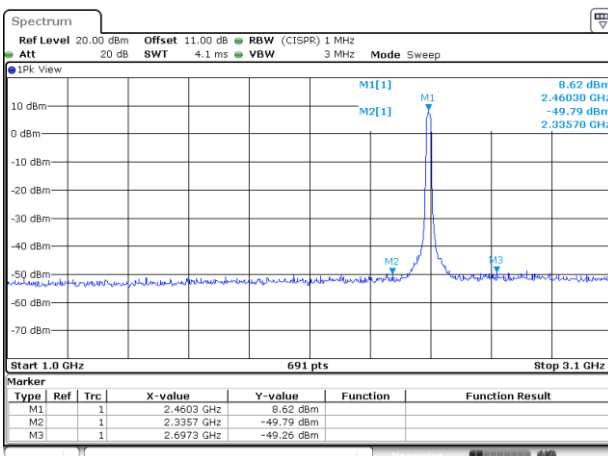

2462MHz

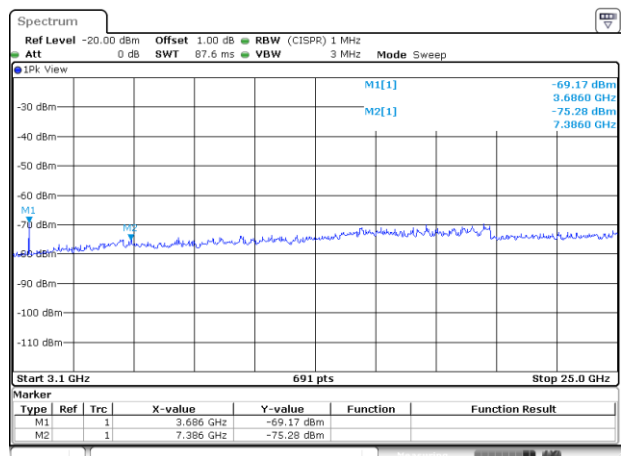

Transmitter Conducted Unwanted Emissions Results in Band Edge							
Modulation Mode		11b					
Test ch. Freq. (MHz)	Range (MHz)	Max Value chain0 (dBm)	DG (dBi)	EIRP (dBm)	E-Field Limit (dBm)	E-Field Margin (dB)	Remark
2412	2310~2390	-39.43	2.00	-37.43	-21.20	-16.23	PK
	2310~2390	-45.48	2.00	-43.48	-41.20	-2.28	AV
	2483.5~2500	-46.71	2.00	-44.71	-21.20	-23.51	PK
	2483.5~2500	-59.32	2.00	-57.32	-41.20	-16.12	AV
2437	2310~2390	-43.10	2.00	-41.10	-21.20	-19.90	PK
	2310~2390	-53.77	2.00	-51.77	-41.20	-10.57	AV
	2483.5~2500	-45.48	2.00	-43.48	-21.20	-22.28	PK
	2483.5~2500	-55.98	2.00	-53.98	-41.20	-12.78	AV
2462	2310~2390	-47.01	2.00	-45.01	-21.20	-23.81	PK
	2310~2390	-59.60	2.00	-57.60	-41.20	-16.40	AV
	2483.5~2500	-39.00	2.00	-37.00	-21.20	-15.80	PK
	2483.5~2500	-47.21	2.00	-45.21	-41.20	-4.01	AV

Note:

1. DG = Directional Gain.

Transmitter Conducted Unwanted Emissions Results in Band Edge							
Modulation Mode		11g					
Test ch. Freq. (MHz)	Range (MHz)	Max Value chain0 (dBm)	DG (dBi)	EIRP (dBm)	E-Field Limit (dBm)	E-Field Margin (dB)	Remark
2412	2310~2390	-32.28	2.00	-30.28	-21.20	-9.08	PK
	2310~2390	-44.90	2.00	-42.90	-41.20	-1.70	AV
	2483.5~2500	-45.29	2.00	-43.29	-21.20	-22.09	PK
	2483.5~2500	-58.37	2.00	-56.37	-41.20	-15.17	AV
2437	2310~2390	-44.36	2.00	-42.36	-21.20	-21.16	PK
	2310~2390	-55.42	2.00	-53.42	-41.20	-12.22	AV
	2483.5~2500	-44.77	2.00	-42.77	-21.20	-21.57	PK
	2483.5~2500	-55.37	2.00	-53.37	-41.20	-12.17	AV
2462	2310~2390	-48.11	2.00	-46.11	-21.20	-24.91	PK
	2310~2390	-61.21	2.00	-59.21	-41.20	-18.01	AV
	2483.5~2500	-29.85	2.00	-27.85	-21.20	-6.65	PK
	2483.5~2500	-47.77	2.00	-45.77	-41.20	-4.57	AV

Note:

1. DG = Directional Gain.

Transmitter Conducted Unwanted Emissions Results in Band Edge							
Modulation Mode		HT20					
Test ch. Freq. (MHz)	Range (MHz)	Max Value chain0 (dBm)	DG (dBi)	EIRP (dBm)	E-Field Limit (dBm)	E-Field Margin (dB)	Remark
2412	2310~2390	-34.37	2.00	-32.37	-21.20	-11.17	PK
	2310~2390	-48.77	2.00	-46.77	-41.20	-5.57	AV
	2483.5~2500	-47.55	2.00	-45.55	-21.20	-24.35	PK
	2483.5~2500	-58.52	2.00	-56.52	-41.20	-15.32	AV
2437	2310~2390	-44.98	2.00	-42.98	-21.20	-21.78	PK
	2310~2390	-56.03	2.00	-54.03	-41.20	-12.83	AV
	2483.5~2500	-44.39	2.00	-42.39	-21.20	-21.19	PK
	2483.5~2500	-55.76	2.00	-53.76	-41.20	-12.56	AV
2462	2310~2390	-49.50	2.00	-47.50	-21.20	-26.30	PK
	2310~2390	-61.73	2.00	-59.73	-41.20	-18.53	AV
	2483.5~2500	-34.93	2.00	-32.93	-21.20	-11.73	PK
	2483.5~2500	-50.98	2.00	-48.98	-41.20	-7.78	AV

Note:

1. DG = Directional Gain.

11b Band Edge Test Plot

2412MHz - AV

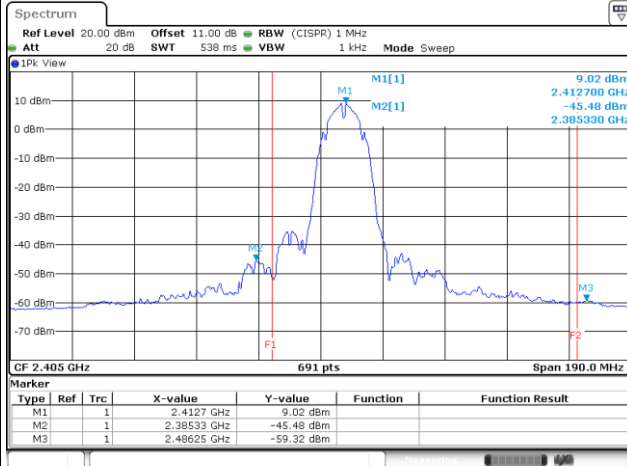

2412MHz - PK

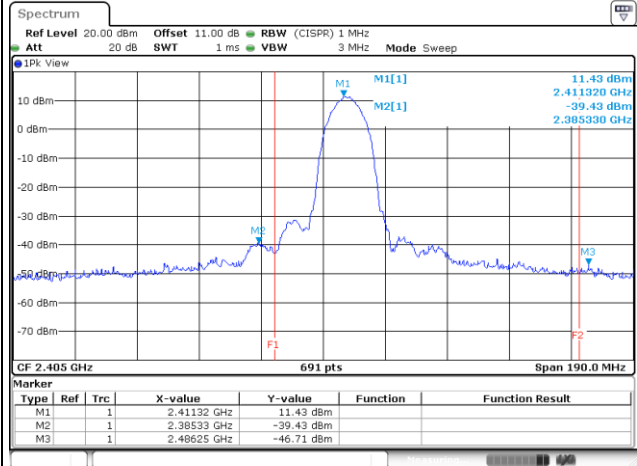

2437MHz - AV

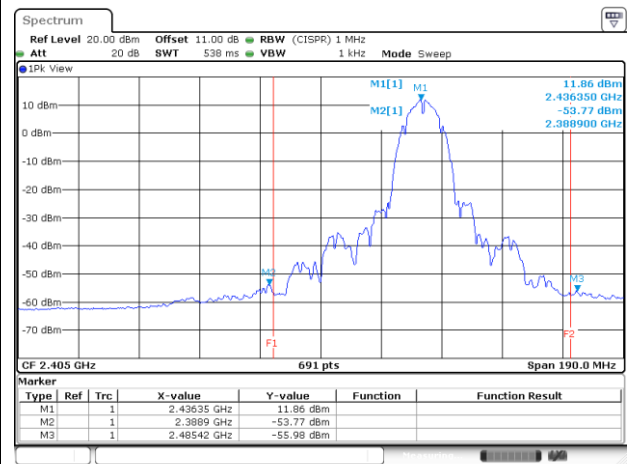

2437MHz - PK

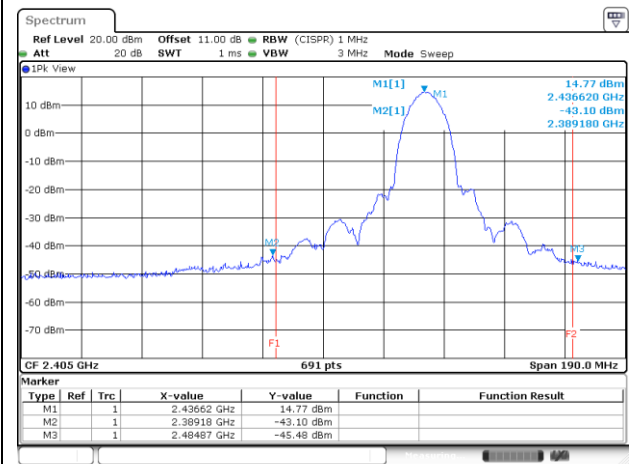

2462MHz - AV

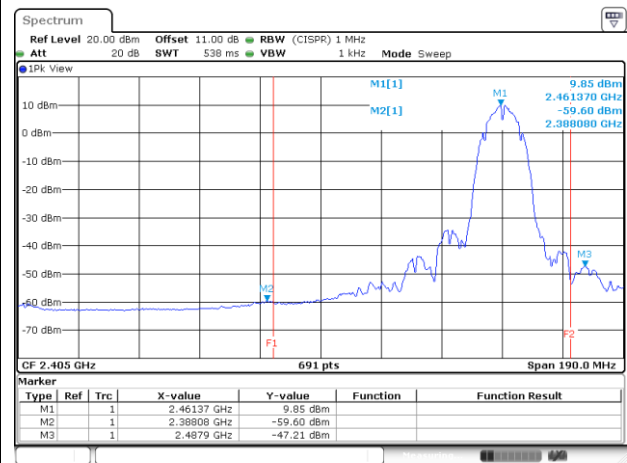

2462MHz - PK

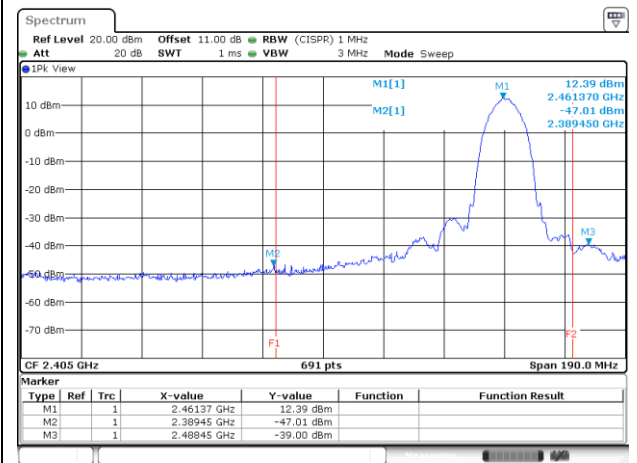

11g Band Edge Test Plot

2412MHz - AV

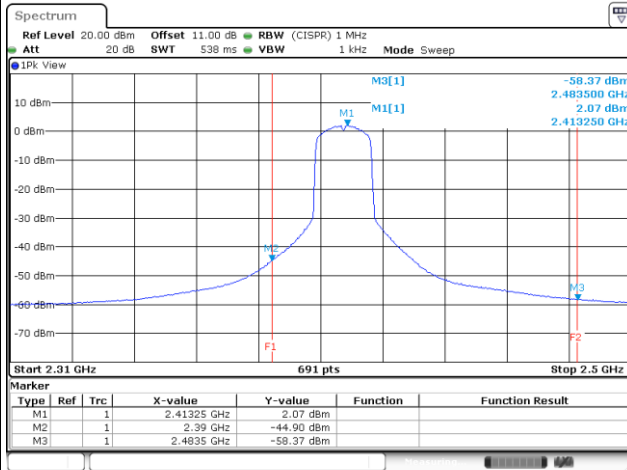

2412MHz - PK

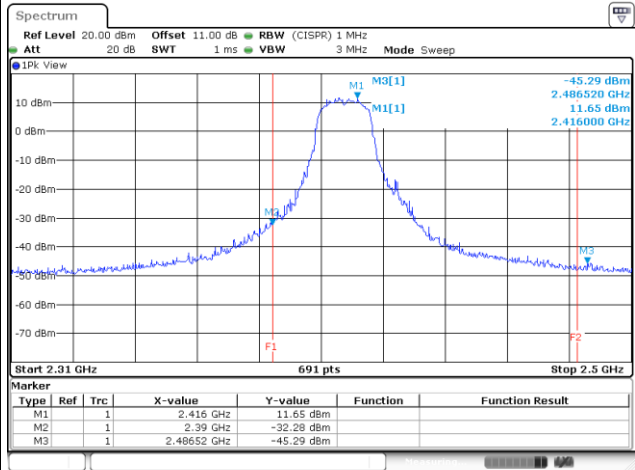

2437MHz - AV

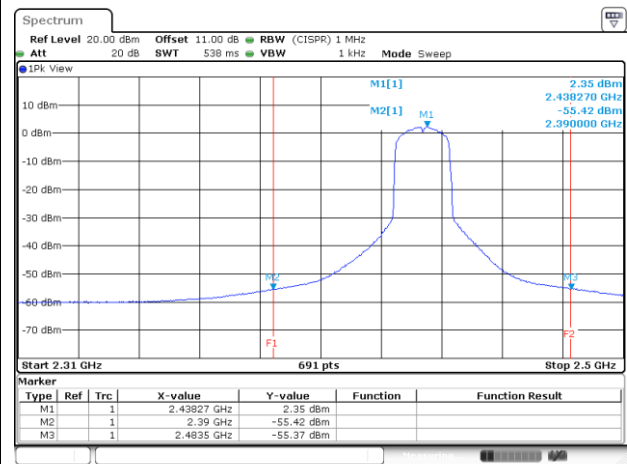

2437MHz - PK

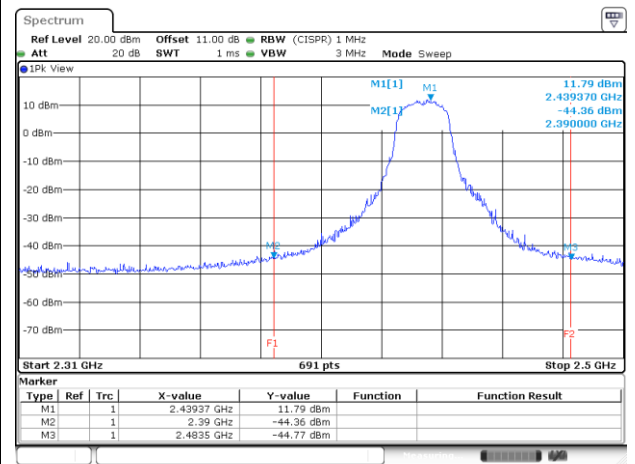

2462MHz - AV

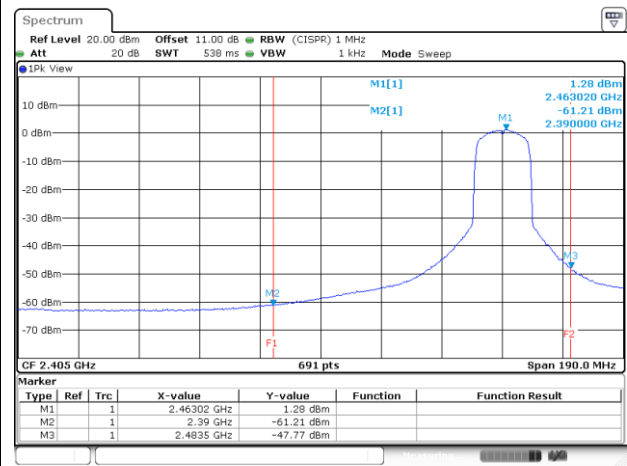

2462MHz - PK

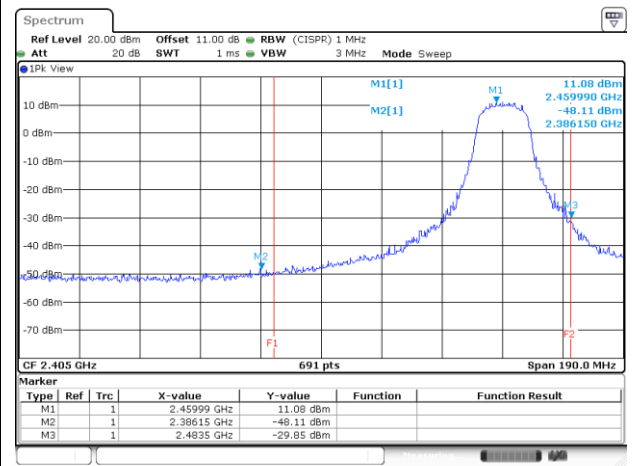

HT20 Band Edge Test Plot

2412MHz - AV

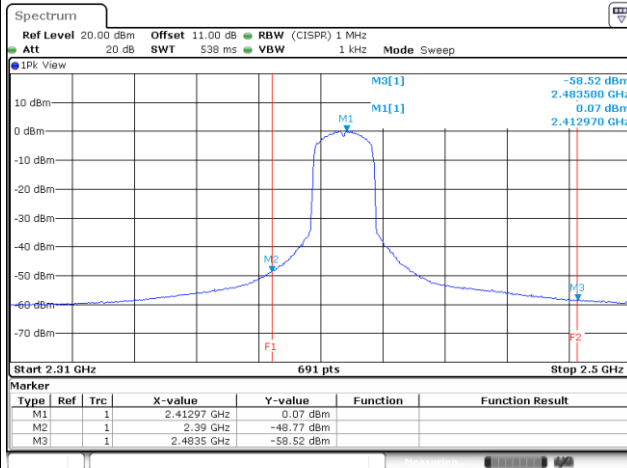

2412MHz - PK

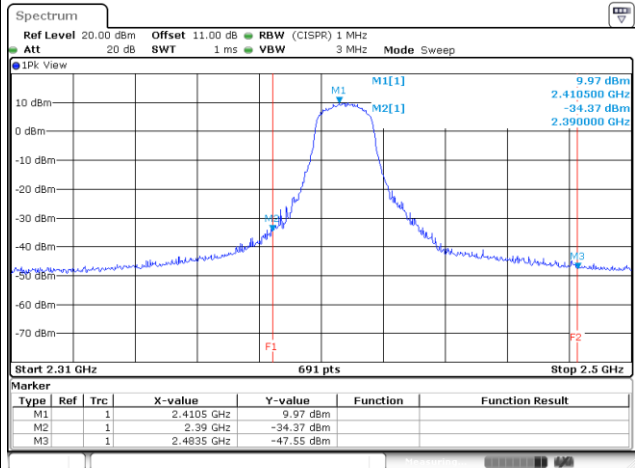

2437MHz - AV

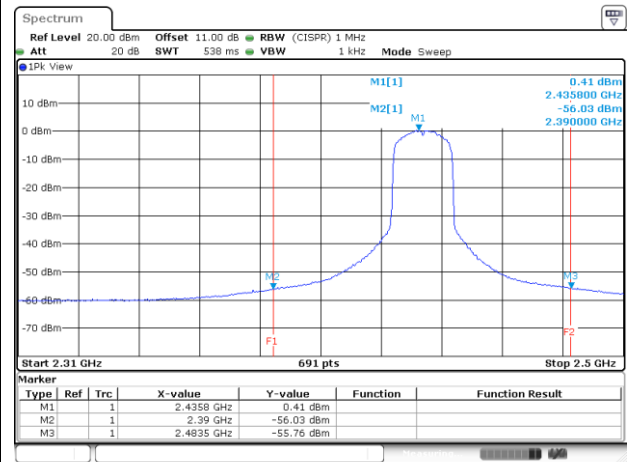

2437MHz - PK

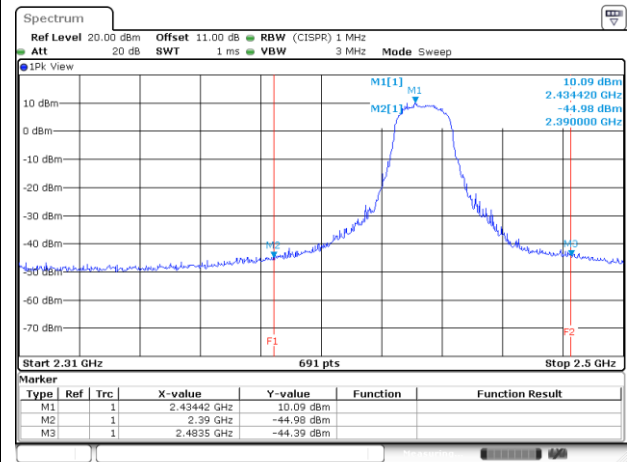

2462MHz - AV

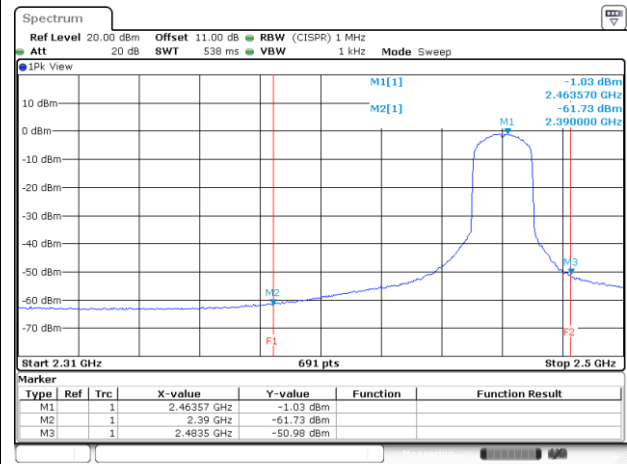

2462MHz - PK

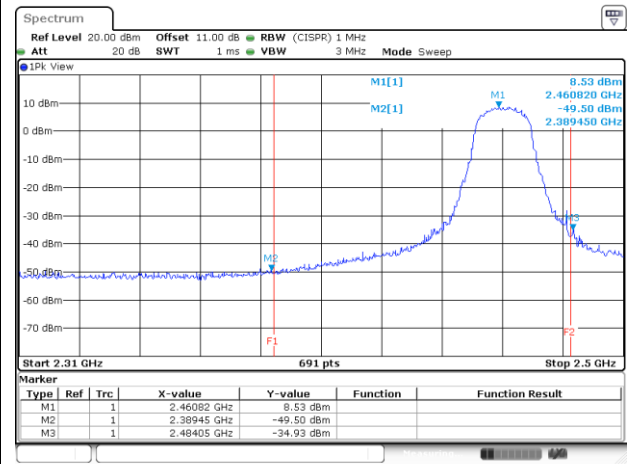

Transmitter Conducted Unwanted Emissions Results in Restricted Frequency Band						
Modulation Mode		11b		Frequency	2412MHz	
Freq. (MHz)	Remark	Max Value chain0 (dBm)	DG (dBi)	EIRP (dBm)	E-Field Limit (dBm)	E-Field Margin (dB)
3618.00	PK	-64.40	2.00	-62.40	-21.20	-41.20
3618.00	AV note1	-	2.00	-	-41.20	-
4824.00	PK	-70.17	2.00	-68.17	-21.20	-46.97
4824.00	AV note1	-	2.00	-	-41.20	-

Transmitter Conducted Unwanted Emissions Results in Restricted Frequency Band						
Modulation Mode		11b		Frequency	2437MHz	
Freq. (MHz)	Remark	Max Value chain0 (dBm)	DG (dBi)	EIRP (dBm)	E-Field Limit (dBm)	E-Field Margin (dB)
3655.50	PK	-64.83	2.00	-62.83	-21.20	-41.63
3655.50	AV note1	-	2.00	-	-41.20	-
4874.00	PK	-72.12	2.00	-70.12	-21.20	-48.92
4874.00	AV note1	-	2.00	-	-41.20	-
7311.00	PK	-60.52	2.00	-58.52	-21.20	-37.32
7311.00	AV note1	-	2.00	-	-41.20	-

Transmitter Conducted Unwanted Emissions Results in Restricted Frequency Band						
Modulation Mode		11b		Frequency	2462MHz	
Freq. (MHz)	Remark	Max Value chain0 (dBm)	DG (dBi)	EIRP (dBm)	E-Field Limit (dBm)	E-Field Margin (dB)
3693.00	PK	-66.09	2.00	-64.09	-21.20	-42.89
3693.00	AV note1	-	2.00	-	-41.20	-
4924.00	PK	-72.54	2.00	-70.54	-21.20	-49.34
4924.00	AV note1	-	2.00	-	-41.20	-
7386.00	PK	-68.08	2.00	-66.08	-21.20	-44.88
7386.00	AV	-	2.00	-	-41.20	-

Note:

1. If the PK margin greater than 20 dB, there is no need to get AVG reading.
2. DG = Directional Gain.

Transmitter Conducted Unwanted Emissions Results in Restricted Frequency Band						
Modulation Mode		11g		Frequency	2412MHz	
Freq. (MHz)	Remark	Max Value chain0 (dBm)	DG (dBi)	EIRP (dBm)	E-Field Limit (dBm)	E-Field Margin (dB)
3618.00	PK	-64.76	2.00	-62.76	-21.20	-41.56
3618.00	AV note1	-	2.00	-	-41.20	-
4824.00	PK	-74.43	2.00	-72.43	-21.20	-51.23
4824.00	AV note1	-	2.00	-	-41.20	-

Transmitter Conducted Unwanted Emissions Results in Restricted Frequency Band						
Modulation Mode		11g		Frequency	2437MHz	
Freq. (MHz)	Remark	Max Value chain0 (dBm)	DG (dBi)	EIRP (dBm)	E-Field Limit (dBm)	E-Field Margin (dB)
3655.50	PK	-66.12	2.00	-64.12	-21.20	-42.92
3655.50	AV note1	-	2.00	-	-41.20	-
4874.00	PK	-74.95	2.00	-72.95	-21.20	-51.75
4874.00	AV note1	-	2.00	-	-41.20	-
7311.00	PK	-65.29	2.00	-63.29	-21.20	-42.09
7311.00	AV note1	-	2.00	-	-41.20	-

Transmitter Conducted Unwanted Emissions Results in Restricted Frequency Band						
Modulation Mode		11g		Frequency	2462MHz	
Freq. (MHz)	Remark	Max Value chain0 (dBm)	DG (dBi)	EIRP (dBm)	E-Field Limit (dBm)	E-Field Margin (dB)
3693.00	PK	-67.02	2.00	-65.02	-21.20	-43.82
3693.00	AV note1	-	2.00	-	-41.20	-
4924.00	PK	-74.80	2.00	-72.80	-21.20	-51.60
4924.00	AV note1	-	2.00	-	-41.20	-
7386.00	PK	-71.27	2.00	-69.27	-21.20	-48.07
7386.00	AV note1	-	2.00	-	-41.20	-

Note:

1. If the PK margin greater than 20 dB, there is no need to get AVG reading.
2. DG = Directional Gain.

Transmitter Conducted Unwanted Emissions Results in Restricted Frequency Band						
Modulation Mode		HT20		Frequency	2412MHz	
Freq. (MHz)	Remark	Max Value chain0 (dBm)	DG (dBi)	EIRP (dBm)	E-Field Limit (dBm)	E-Field Margin (dB)
3618.00	PK	-65.77	2.00	-63.77	-21.20	-42.57
3618.00	AV note1	-	2.00	-	-41.20	-
4824.00	PK	-75.31	2.00	-73.31	-21.20	-52.11
4824.00	AV note1	-	2.00	-	-41.20	-

Transmitter Conducted Unwanted Emissions Results in Restricted Frequency Band						
Modulation Mode		HT20		Frequency	2437MHz	
Freq. (MHz)	Remark	Max Value chain0 (dBm)	DG (dBi)	EIRP (dBm)	E-Field Limit (dBm)	E-Field Margin (dB)
3655.50	PK	-65.96	2.00	-63.96	-21.20	-42.76
3655.50	AV note1	-	2.00	-	-41.20	-
4874.00	PK	-75.47	2.00	-73.47	-21.20	-52.27
4874.00	AV note1	-	2.00	-	-41.20	-
7311.00	PK	-66.17	2.00	-64.17	-21.20	-42.97
7311.00	AV note1	-	2.00	-	-41.20	-

Transmitter Conducted Unwanted Emissions Results in Restricted Frequency Band						
Modulation Mode		HT20		Frequency	2462MHz	
Freq. (MHz)	Remark	Max Value chain0 (dBm)	DG (dBi)	EIRP (dBm)	E-Field Limit (dBm)	E-Field Margin (dB)
3693.00	PK	-67.41	2.00	-65.41	-21.20	-44.21
3693.00	AV note1	-	2.00	-	-41.20	-
4924.00	PK	-75.10	2.00	-73.10	-21.20	-51.90
4924.00	AV note1	-	2.00	-	-41.20	-
7386.00	PK	-72.29	2.00	-70.29	-21.20	-49.09
7386.00	AV note1	-	2.00	-	-41.20	-

Note:

1. If the PK margin greater than 20 dB, there is no need to get AVG reading.
2. DG = Directional Gain.

11b-Test Plots

3618MHz - PK

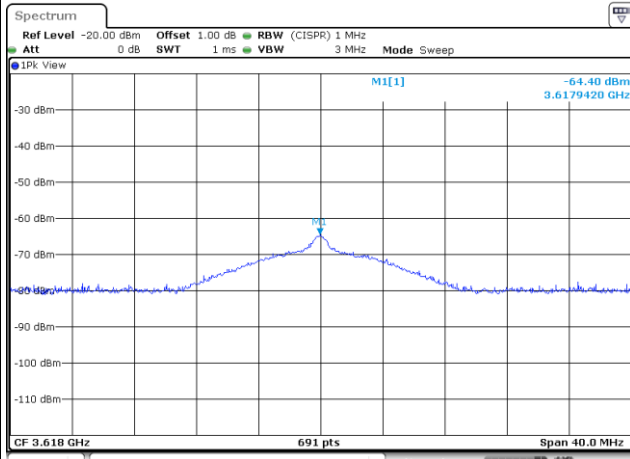

4824MHz - PK

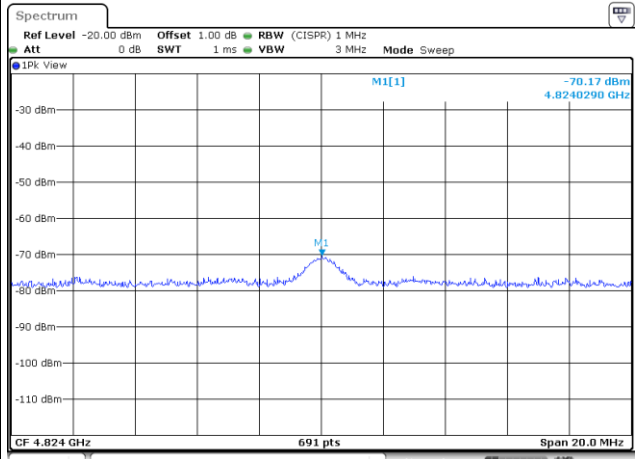

3655.5MHz - PK

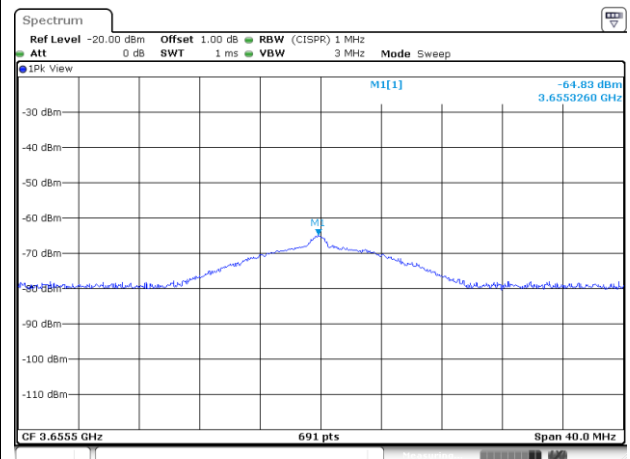

4874MHz - PK

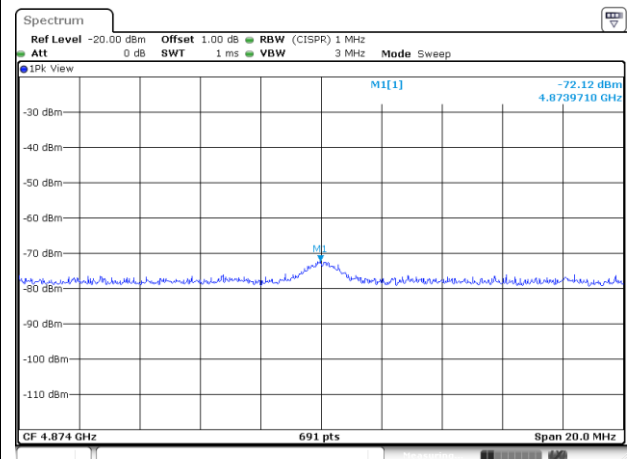

7311MHz - PK

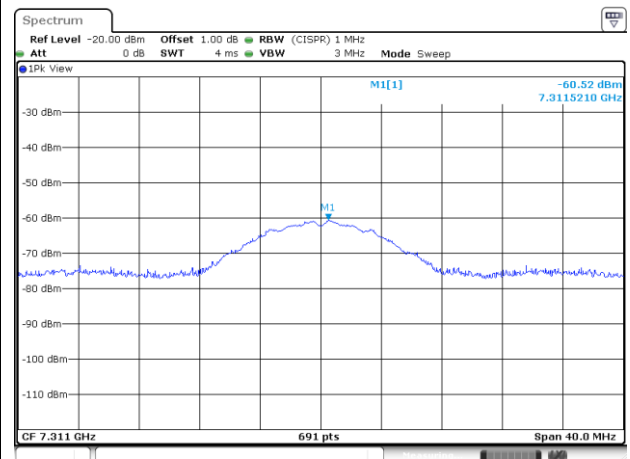

3693MHz - PK

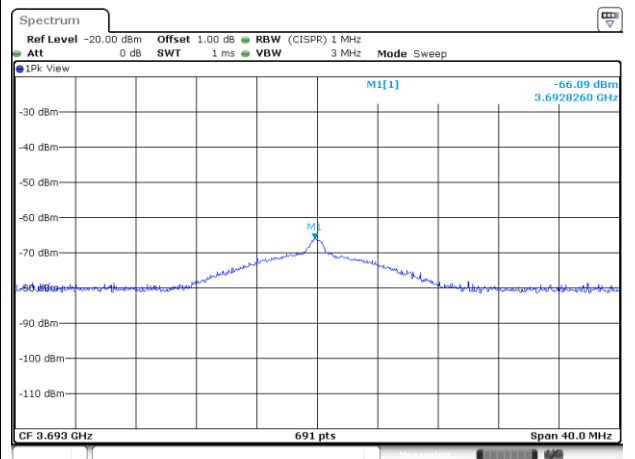

11b-Test Plots

4924MHz - PK

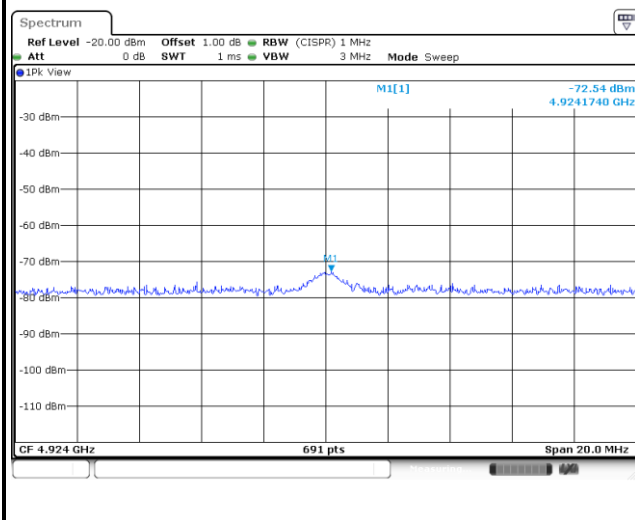

7386MHz - PK

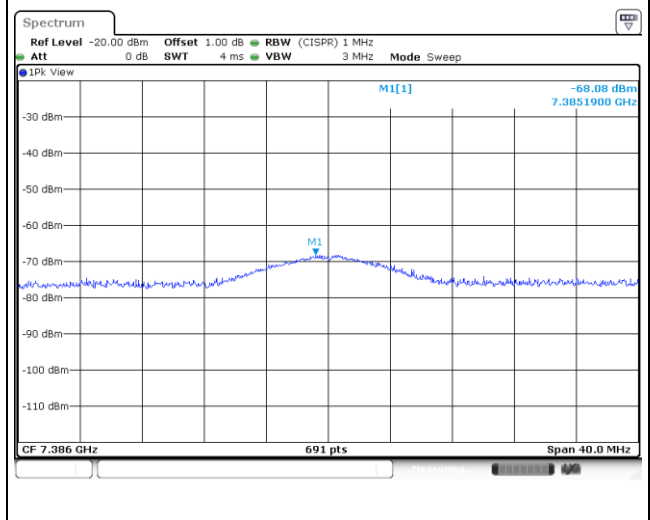

11g-Test Plots

3618MHz - PK

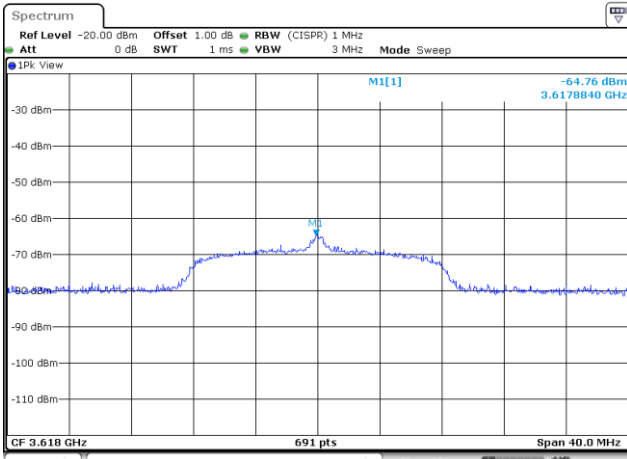

4824MHz - PK

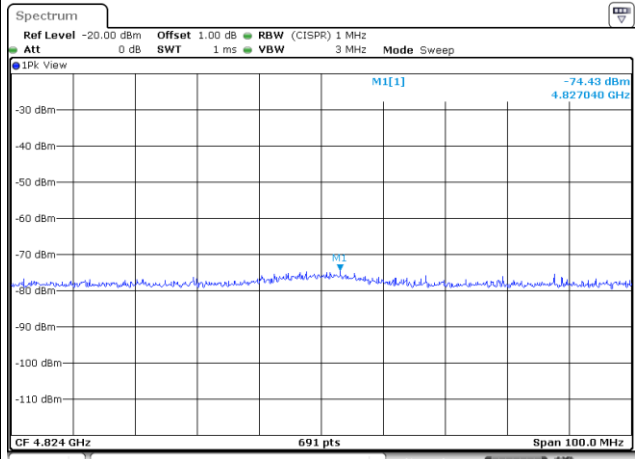

3655.5MHz - PK

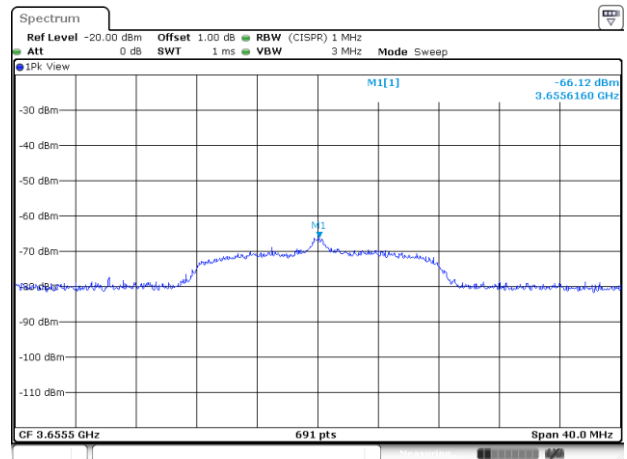

4874MHz - PK

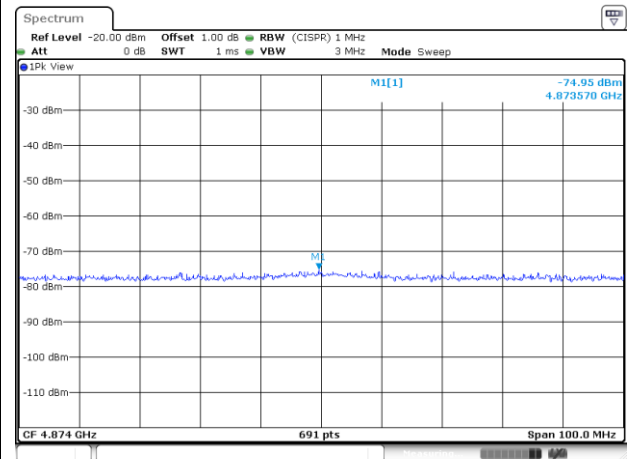

7311MHz - PK

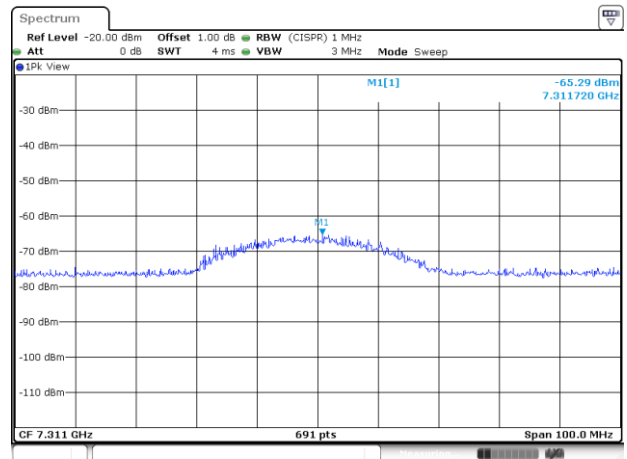

3693MHz - PK

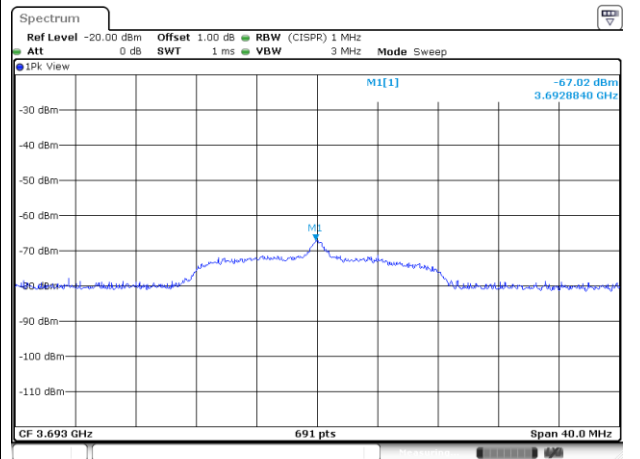

11g-Test Plots

4924MHz - PK

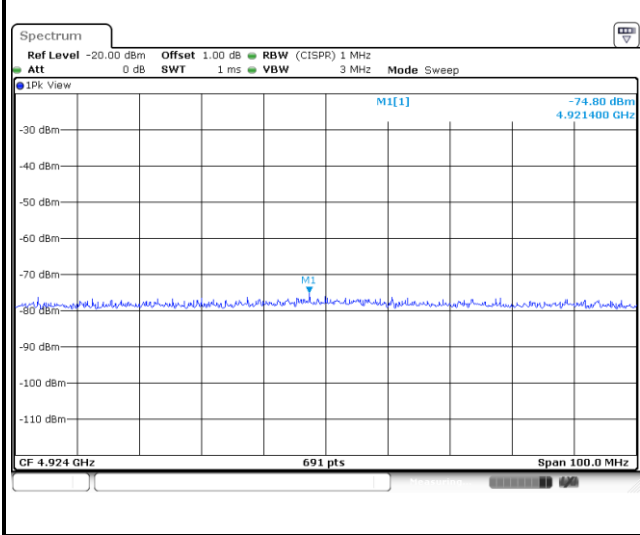

7386MHz - PK

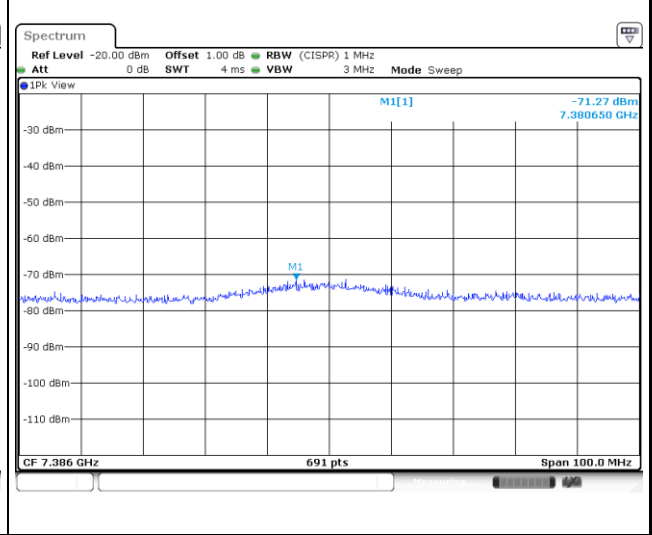

HT20-Test Plots

3618MHz - PK

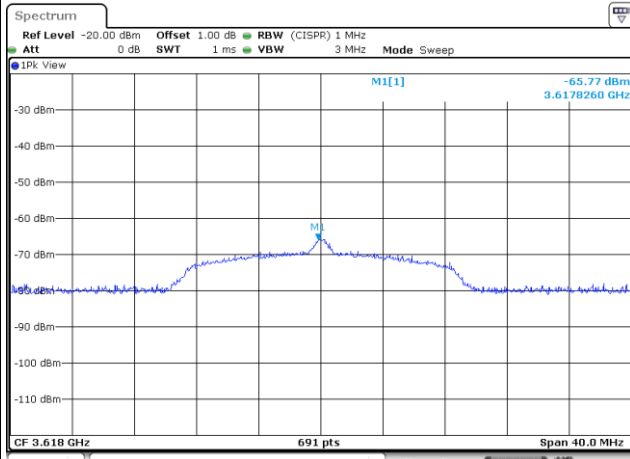

4824MHz - PK

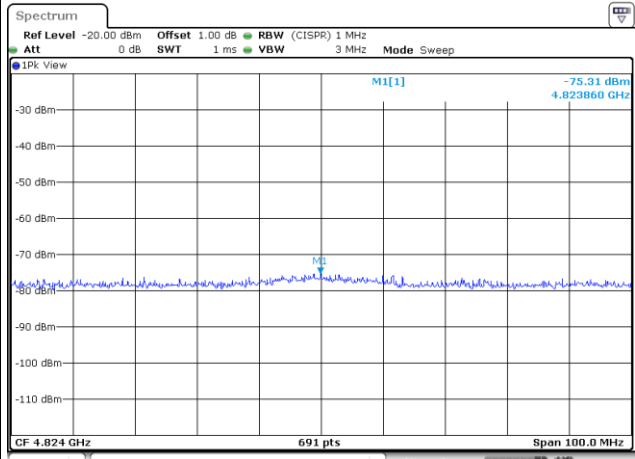

3655.5MHz - PK

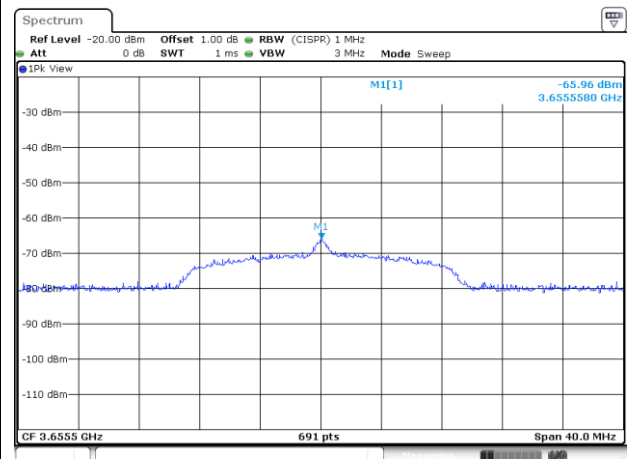

4874MHz - PK

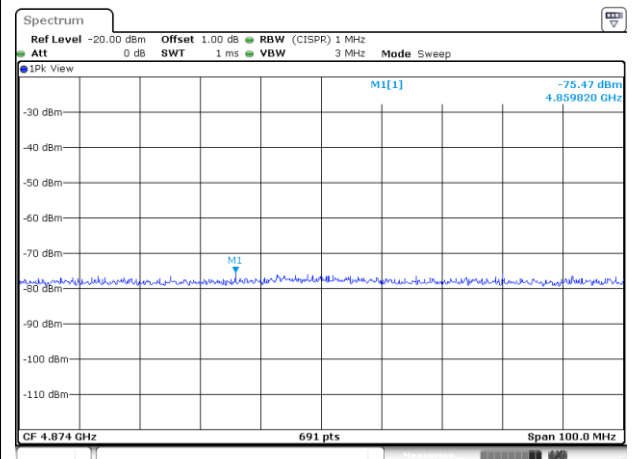

7311MHz - PK

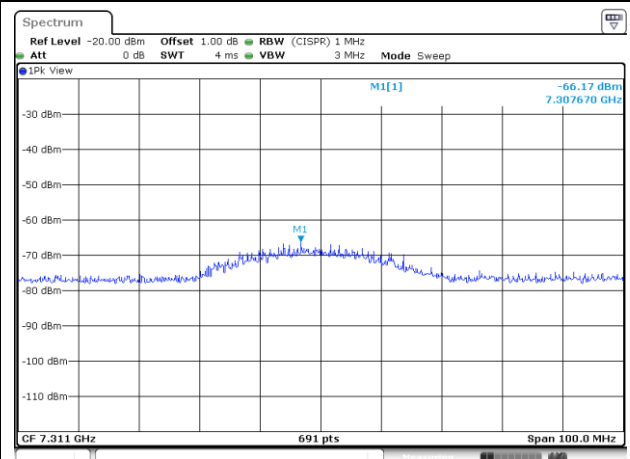

3693MHz - PK

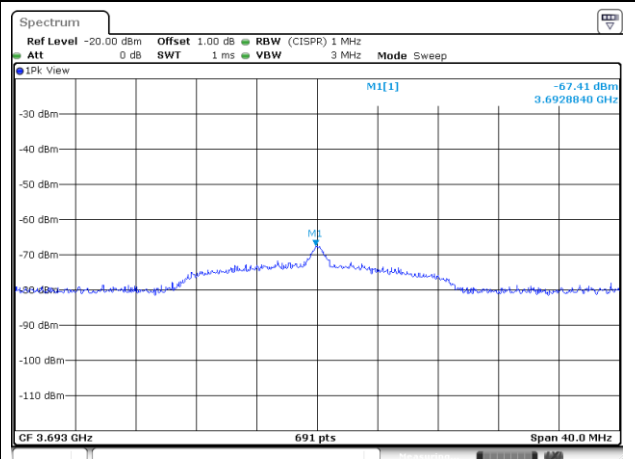

11b-Test Plots

4924MHz - PK

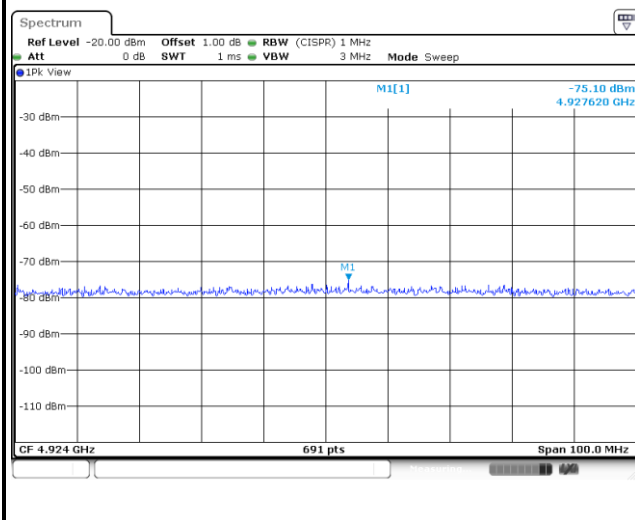

7386MHz - PK

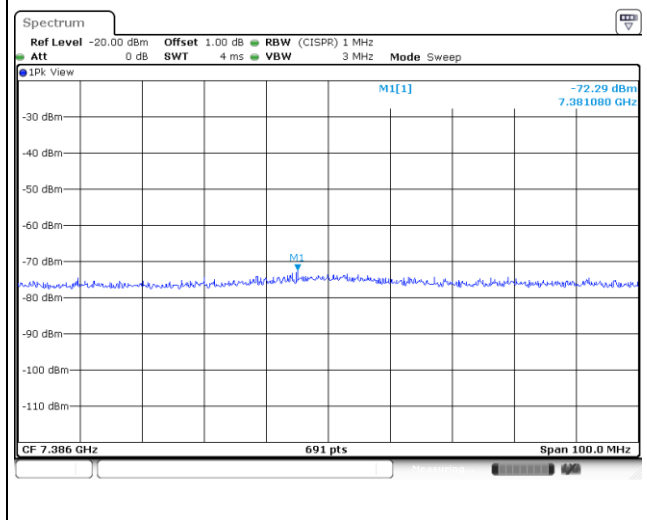

3.6 Emissions in Non-Restricted Frequency Bands

3.6.1 Emissions in Non-Restricted Frequency Bands Limit

Peak power in any 100 kHz bandwidth outside of the authorized frequency band shall be attenuated by at least 20 dB relative to the maximum in-band peak PSD level in 100 kHz.

3.6.2 Test Procedures

Reference level measurement

1. Set RBW=100kHz, VBW = 300kHz , Detector = Peak, Sweep time = Auto
2. Trace = max hold , Allow Trace to fully stabilize
3. Use the peak marker function to determine the maximum PSD level

Emission level measurement

1. Set RBW=100kHz, VBW = 300kHz , Detector = Peak, Sweep time = Auto
2. Trace = max hold , Allow Trace to fully stabilize
3. Scan Frequency range is up to 25GHz
4. Use the peak marker function to determine the maximum amplitude level

3.6.3 Test Setup

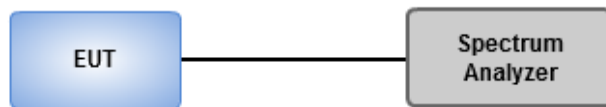

3.6.4 Unwanted Emissions into Non-Restricted Frequency Bands

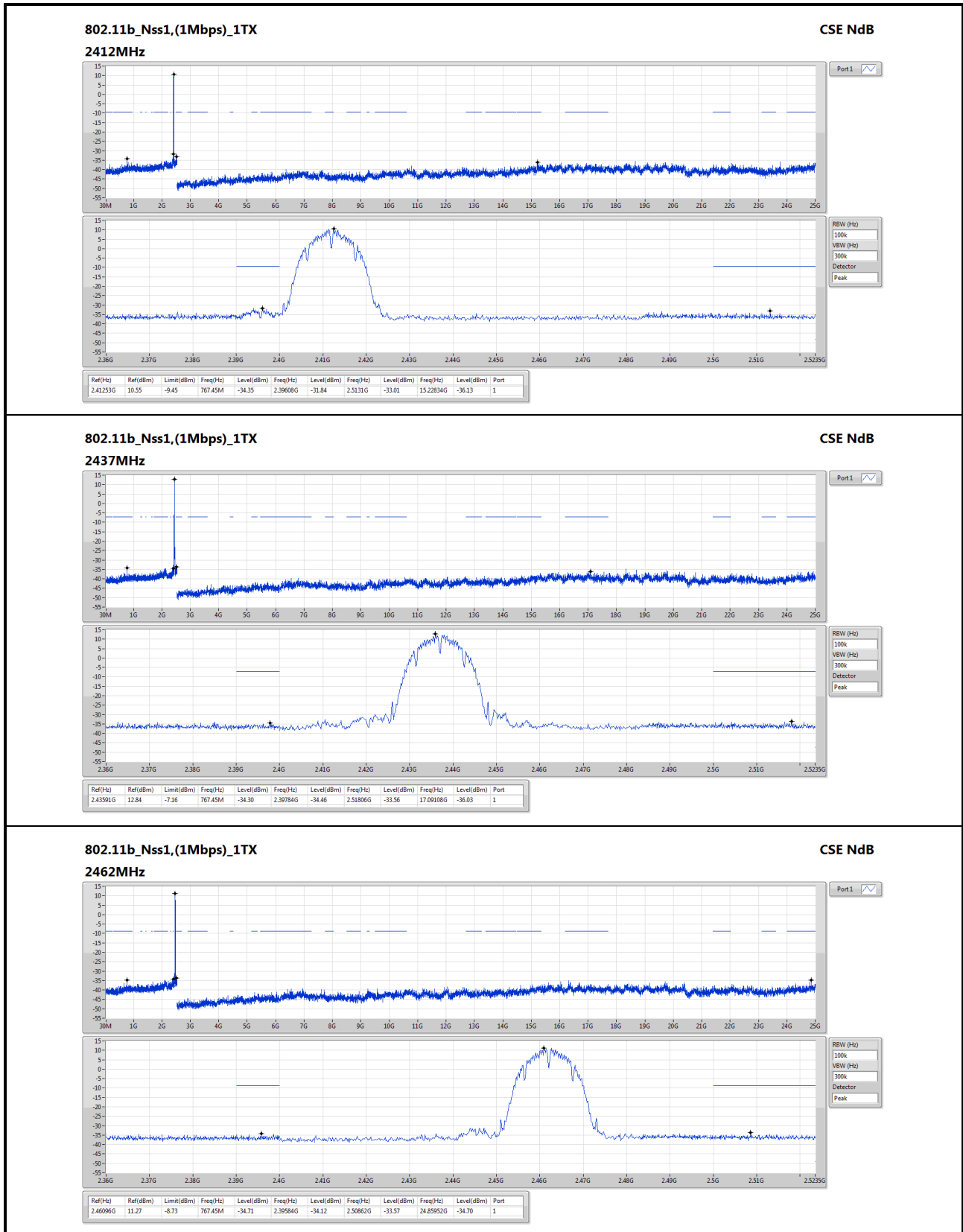

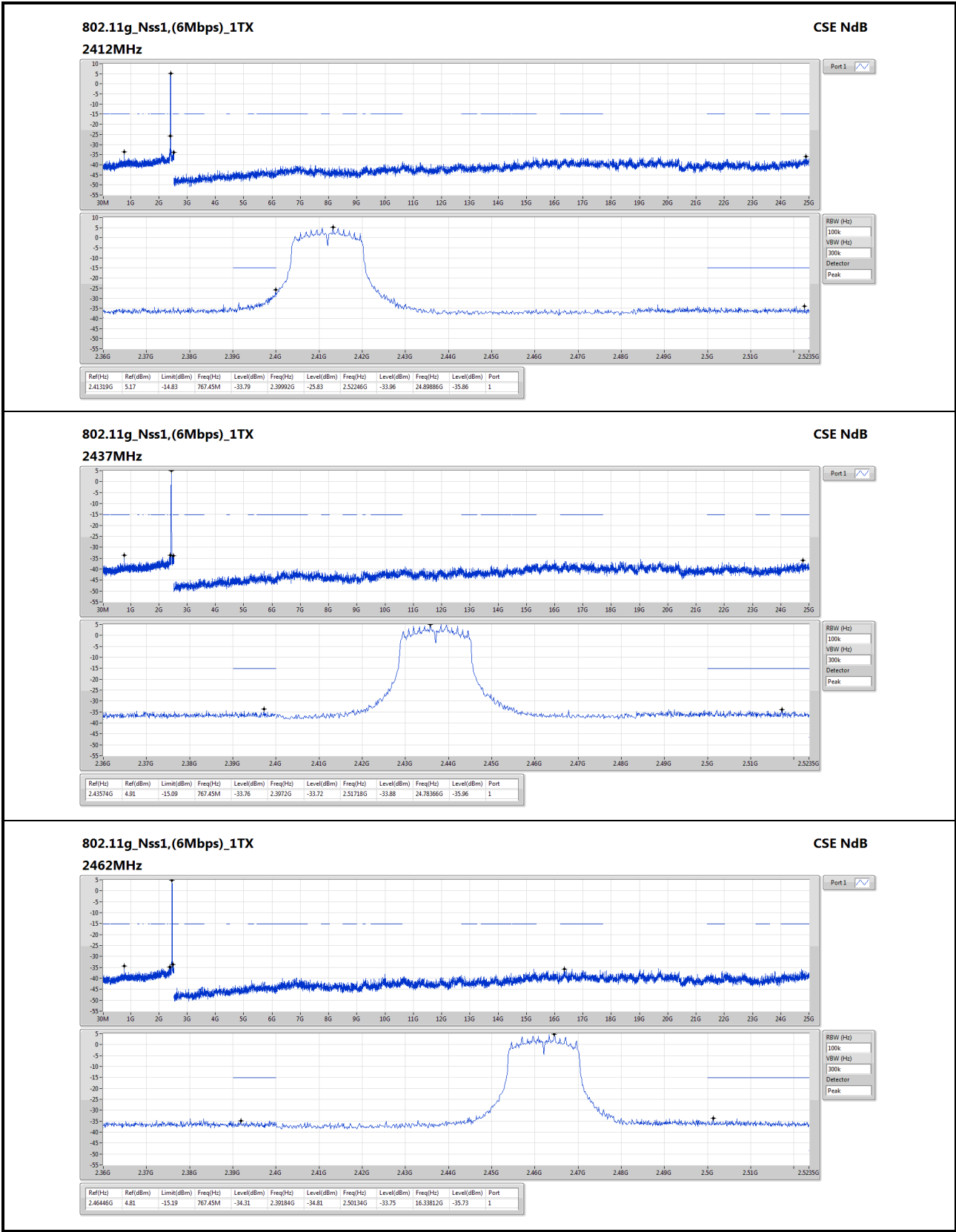

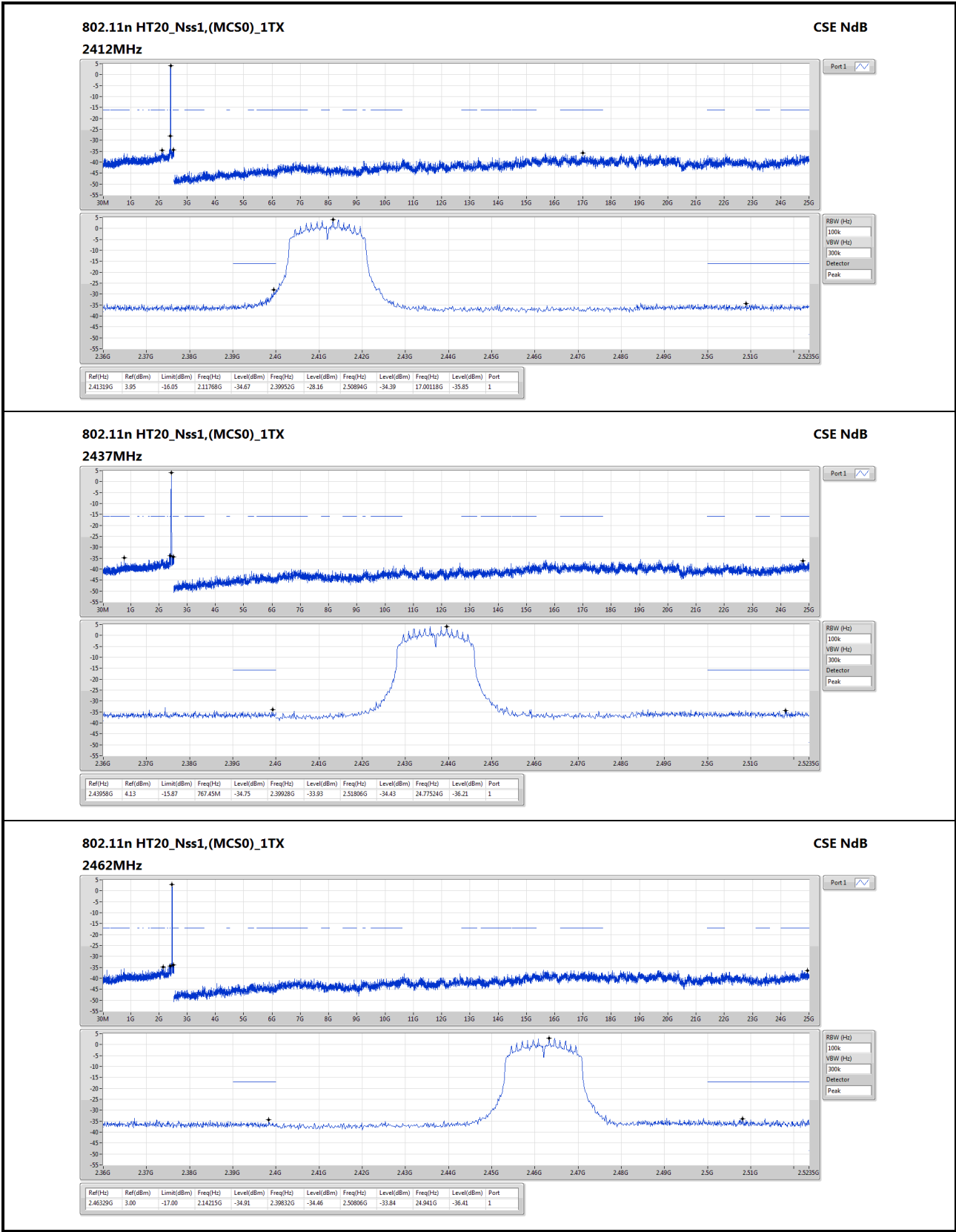

4 Test laboratory information

Established in 2012, ICC provides foremost EMC & RF Testing and advisory consultation services by our skilled engineers and technicians. Our services employ a wide variety of advanced edge test equipment and one of the widest certification extents in the business.

International Certification Corp (EMC and Wireless Communication Laboratory), it is our definitive objective is to institute long term, trust-based associations with our clients. The expectation we set up with our clients is based on outstanding service, practical expertise and devotion to a certified value structure. Our passion is to grant our clients with best EMC / RF services by oriented knowledgeable and accommodating staff.

Our Test sites are located at Linkou District and Kwei Shan District. Location map can be found on our website <http://www.icertifi.com.tw>.

Linkou

Tel: 886-2-2601-1640

No. 30-2, Ding Fwu Tsuen, Lin
Kou District, New Taipei City,
Taiwan, R.O.C.

Kwei Shan

Tel: 886-3-271-8666

No. 3-1, Lane 6, Wen San 3rd St.,
Kwei Shan District, Tao Yuan City
333, Taiwan, R.O.C.

Kwei Shan Site II

Tel: 886-3-271-8640

No. 14-1, Lane 19, Wen San 3rd
St., Kwei Shan District, Tao Yuan
City 333, Taiwan, R.O.C.

If you have any suggestion, please feel free to contact us as below information.

Tel: 886-3-271-8666

Fax: 886-3-318-0155

Email: ICC_Service@icertifi.com.tw

==END==