

FCC Test Report

FCC ID : SQG-60SIPT
Equipment : 802.11 ac/a/b/g/n + Bluetooth 4.2 module
(please refer to section 1.1.1 for more details.)
Model No. : ST60-SIPT
(please refer to section 1.1.1 for more details.)
Brand Name : Laird Technologies
Applicant : Laird Technologies
Address : W66N220 Commerce Court, Cedarburg,
Wisconsin 53012, USA
Standard : 47 CFR FCC Part 15.247
Received Date : Apr. 07, 2017
Tested Date : Apr. 12 ~ May 10, 2017

We, International Certification Corp., would like to declare that the tested sample has been evaluated and in compliance with the requirement of the above standards. The test results contained in this report refer exclusively to the product. It may be duplicated completely for legal use with the approval of the applicant. It shall not be reproduced except in full without the written approval of our laboratory.

Reviewed by:



Along Chen / Assistant Manager

Approved by:



Gary Chang / Manager



Table of Contents

1	GENERAL DESCRIPTION	5
1.1	Information.....	5
1.2	Local Support Equipment List	7
1.3	Local Support Equipment List	7
1.4	Test Setup Chart	7
1.5	Test Equipment List and Calibration Data.....	8
1.6	Test Standards	9
1.7	Measurement Uncertainty	9
2	TEST CONFIGURATION	10
2.1	Testing Condition	10
2.2	The Worst Test Modes and Channel Details	10
3	TRANSMITTER TEST RESULTS.....	11
3.1	Conducted Emissions.....	11
3.2	6dB and Occupied Bandwidth	14
3.3	RF Output Power.....	16
3.4	Power Spectral Density	18
3.5	Emissions in Restricted Frequency Bands.....	20
3.6	Emissions in non-restricted Frequency Bands.....	37
4	TEST LABORATORY INFORMATION	40

Release Record

Report No.	Version	Description	Issued Date
FR740701AE	Rev. 01	Initial issue	Jul. 13, 2017
FR740701AE	Rev. 02	Revised model name	Jul. 21, 2017

Summary of Test Results

FCC Rules	Test Items	Measured	Result
15.207	AC Power Line Conducted Emissions	[dBuV]: 4.523MHz 49.69(Margin -6.31dB) - QP	Pass
15.247(d) 15.209	Radiated Emissions	Meet the requirement of limit	Pass
15.247(b)(3)	Maximum Output Power	Power [dBm]: 10.80	Pass
15.247(a)(2)	6dB Bandwidth	Meet the requirement of limit	Pass
15.247(e)	Power Spectral Density	Meet the requirement of limit	Pass
15.203	Antenna Requirement	Meet the requirement of limit	Pass

1 General Description

1.1 Information

1.1.1 Product Details

The following models are provided to this EUT.

Brand Name	Model Name	Product Name	Description	
Laird Technologies	ST60-SIPT	802.11 ac/a/b/g/n + Bluetooth 4.2 module	SIPT only	For marketing purpose
	SU60-SIPT			
	ST60-2230C	802.11 ac/a/b/g/n M.2 2230 + Bluetooth 4.2 module	with carrier board	
	SU60-2230C			

✦ The above models, model ST60-2230C was selected as a representative one for the final test and only its data was recorded in this report.

1.1.2 Specification of the Equipment under Test (EUT)

RF General Information				
Frequency Range (MHz)	Bluetooth Mode	Ch. Freq. (MHz)	Channel Number	Data Rate
2400-2483.5	V4.2 LE	2402-2480	0-39 [40]	1 Mbps

Note 1: Bluetooth LE (Low energy) uses GFSK modulation.

1.1.3 Antenna Details

Ant. No.	Model	Type	Connector	Operating Frequencies (MHz) / Antenna Gain (dBi)				
				2400~2483.5	5150~5250	5250~5350	5470~5725	5725~5850
1	LSR/001-0009	Dipole	IPEX U.FL	2	2	2	2	2
2	Laird NanoBlade-IP04	PCB Dipole	IPEX U.FL	2	3.9	3.9	4	4
3	Laird MAF95310 Mini NanoBlade Flex	PCB Dipole	IPEX U.FL	2.79	3.38	3.38	3.38	3.38
4	LSR/FlexPIFA 001-0016	PIFA	IPEX U.FL	2.5	3	3	3	3
5	Ethertronics WLAN_1000146	Isolated Magnetic Dipole	IPEX U.FL	2.5	3.5	3.5	3.5	3.5

1.1.4 Power Supply Type of Equipment under Test (EUT)

Power Supply Type	DC 3.3V from host
--------------------------	-------------------

1.1.5 Accessories

N/A

1.1.6 Channel List

Frequency band (MHz)				2400~2483.5			
Channel	Frequency (MHz)	Channel	Frequency (MHz)	Channel	Frequency (MHz)	Channel	Frequency (MHz)
37	2402	9	2422	18	2442	28	2462
0	2404	10	2424	19	2444	29	2464
1	2406	38	2426	20	2446	30	2466
2	2408	11	2428	21	2448	31	2468
3	2410	12	2430	22	2450	32	2470
4	2412	13	2432	23	2452	33	2472
5	2414	14	2434	24	2454	34	2474
6	2416	15	2436	25	2456	35	2476
7	2418	16	2438	26	2458	36	2478
8	2420	17	2440	27	2460	39	2480

1.1.7 Test Tool and Duty Cycle

Test tool	Dut labtool, version: 1.0.0.133
Duty cycle of test signal (%)	65.12%
Duty Factor (dB)	1.86

1.1.8 Power Setting

Modulation Mode	Test Frequency (MHz)		
	2402	2440	2480
GFSK/1Mbps	10	10	10

1.2 Local Support Equipment List

1.3 Local Support Equipment List

Support Equipment List					
No.	Equipment	Brand	Model	FCC ID	Signal cable / Length (m)
1	Notebook	DELL	Latitude E5420	DoC	RJ45, 10m non-shielded
2	Notebook	Lenovo	T430	DoC	---
3	50Ω terminator	---	---	---	---
4	Fixture	---	---	---	Fixture, 0.2m non-shielded

Note: No2. & No. 4 were provided by applicant.

1.4 Test Setup Chart

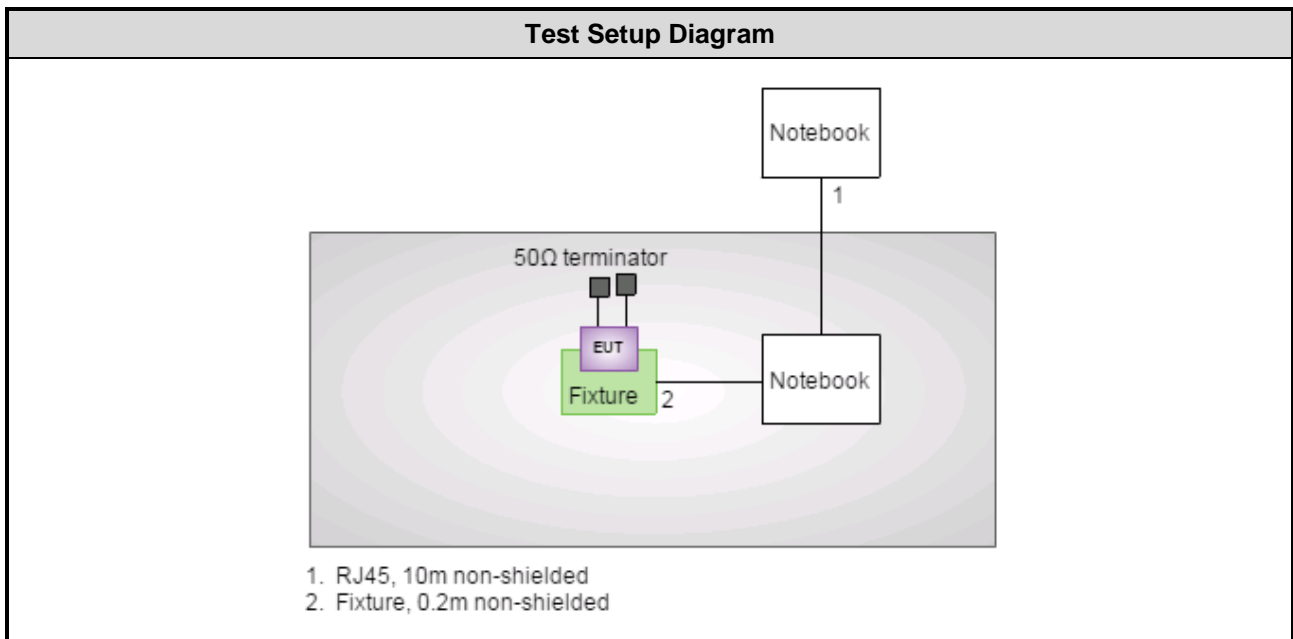

1.5 Test Equipment List and Calibration Data

Test Item	Conducted Emission				
Test Site	Conduction room 1 / (CO01-WS)				
Instrument	Manufacturer	Model No.	Serial No.	Calibration Date	Calibration Until
Receiver	R&S	ESR3	101657	Dec. 21, 2016	Dec. 20, 2017
LISN	SCHWARZBECK	Schwarzbeck 8127	8127-667	Nov. 08, 2016	Nov. 07, 2017
RF Cable-CON	EMC	EMCCFD300-BM-BM-6000	50821	Dec. 20, 2016	Dec. 19, 2017
Measurement Software	AUDIX	e3	6.120210k	NA	NA

Note: Calibration Interval of instruments listed above is one year.

Test Item	Radiated Emission				
Test Site	966 chamber 3 / (03CH03-WS)				
Instrument	Manufacturer	Model No.	Serial No.	Calibration Date	Calibration Until
Spectrum Analyzer	Agilent	N9010A	MY53400091	Sep. 09, 2016	Sep. 08, 2017
Receiver	Agilent	N9038A	MY53290044	Oct. 06, 2016	Oct. 05, 2017
Bilog Antenna	SCHWARZBECK	VULB9168	VULB9168-522	Aug. 04, 2016	Aug. 03, 2017
Horn Antenna 1G-18G	SCHWARZBECK	BBHA 9120 D	BBHA 9120 D 1206	Feb. 09, 2017	Feb. 08, 2018
Horn Antenna 18G-40G	SCHWARZBECK	BBHA 9170	BBHA 9170517	Oct. 25, 2016	Oct. 24, 2017
Loop Antenna	R&S	HFH2-Z2	100330	Nov. 10, 2016	Nov. 09, 2017
Loop Antenna Cable	KOAX KABEL	101354-BW	101354-BW	Dec. 09, 2016	Dec. 08, 2017
Preamplifier	EMC	EMC02325	980187	Sep. 08, 2016	Sep. 07, 2017
Preamplifier	Agilent	83017A	MY53270014	Aug. 22, 2016	Aug. 21, 2017
Preamplifier	EMC	EMC184045B	980192	Aug. 24, 2016	Aug. 23, 2017
RF cable-3M	HUBER+SUHNER	SUCOFLEX104	MY22620/4	Feb. 04, 2017	Feb. 03, 2018
RF cable-8M	HUBER+SUHNER	SUCOFLEX104	MY22600/4	Feb. 04, 2017	Feb. 03, 2018
RF cable-1M	HUBER+SUHNER	SUCOFLEX104	MY22624/4	Feb. 04, 2017	Feb. 03, 2018
LF cable-0.8M	EMC	EMC8D-NM-NM-800	EMC8D-NM-NM-800-001	Feb. 04, 2017	Feb. 03, 2018
LF cable-3M	EMC	EMC8D-NM-NM-3000	131103	Feb. 04, 2017	Feb. 03, 2018
LF cable-13M	EMC	EMC8D-NM-NM-13000	131104	Feb. 04, 2017	Feb. 03, 2018
Measurement Software	AUDIX	e3	6.120210g	NA	NA

Note: Calibration Interval of instruments listed above is one year.

Test Item	RF Conducted				
Test Site	(TH01-WS)				
Instrument	Manufacturer	Model No.	Serial No.	Calibration Date	Calibration Until
Spectrum Analyzer	R&S	FSV40	101063	Mar. 15, 2017	Mar. 14, 2018
Power Meter	Anritsu	ML2495A	1241002	Oct. 06, 2016	Oct. 05, 2017
Power Sensor	Anritsu	MA2411B	1207366	Oct. 06, 2016	Oct. 05, 2017
DC POWER SOURCE	GW INSTEK	GPC-6030D	EM892433	Oct. 20, 2016	Oct. 19, 2017
Measurement Software	Sporton	Sporton_1	1.3.30	NA	NA
Note: Calibration Interval of instruments listed above is one year.					

1.6 Test Standards

According to the specification of EUT, the EUT must comply with following standards and KDB documents.

47 CFR FCC Part 15.247

ANSI C63.10-2013

FCC KDB 558074 D01 DTS Meas Guidance v04

1.7 Measurement Uncertainty

ISO/IEC 17025 requires that an estimate of the measurement uncertainties associated with the emissions test results be included in the report. The measurement uncertainties given below are based on a 95% confidence level (based on a coverage factor ($k=2$))

Measurement Uncertainty	
Parameters	Uncertainty
Bandwidth	± 34.134 Hz
Conducted power	± 0.808 dB
Power density	± 0.463 dB
Conducted emission	± 2.670 dB
AC conducted emission	± 2.90 dB
Radiated emission ≤ 1 GHz	± 3.66 dB
Radiated emission > 1 GHz	± 5.37 dB

2 Test Configuration

2.1 Testing Condition

Test Item	Test Site	Ambient Condition	Tested By
AC Conduction	CO01-WS	20°C / 57%	Alex Tsai
Radiated Emissions	03CH03-WS	22-24°C / 66-67%	Aska Huang
RF Conducted	TH01-WS	22°C / 64%	Brad Wu

- FCC Designation No.: TW0009
- FCC site registration No.: 207696
- IC site registration No.: 10807C-1

2.2 The Worst Test Modes and Channel Details

Test item	Mode	Test Frequency (MHz)	Data Rate	Test Configuration
AC Power Line Conducted Emissions Radiated Emissions ≤ 1GHz	BT LE	2440	1Mbps	---
Maximum Output Power 6dB bandwidth Power spectral density Radiated Emissions > 1GHz	BT LE	2402, 2440, 2480	1Mbps	---
NOTE: The EUT was pretested with 3 orientations placed on the table for the radiated emission measurement – X, Y, and Z-plane. The Y-plane results were found as the worst case and were shown in this report.				

3 Transmitter Test Results

3.1 Conducted Emissions

3.1.1 Limit of Conducted Emissions

Conducted Emissions Limit		
Frequency Emission (MHz)	Quasi-Peak	Average
0.15-0.5	66 - 56 *	56 - 46 *
0.5-5	56	46
5-30	60	50

Note 1: * Decreases with the logarithm of the frequency.

3.1.2 Test Procedures

1. The device is placed on a test table, raised 80 cm above the reference ground plane. The vertical conducting plane is located 40 cm to the rear of the device.
2. The device is connected to line impedance stabilization network (LISN) and other accessories are connected to other LISN. Measured levels of AC power line conducted emission are across the 50 Ω LISN port.
3. AC conducted emission measurements is made over frequency range from 150 kHz to 30 MHz.
4. This measurement was performed with AC 120V/60Hz

3.1.3 Test Setup

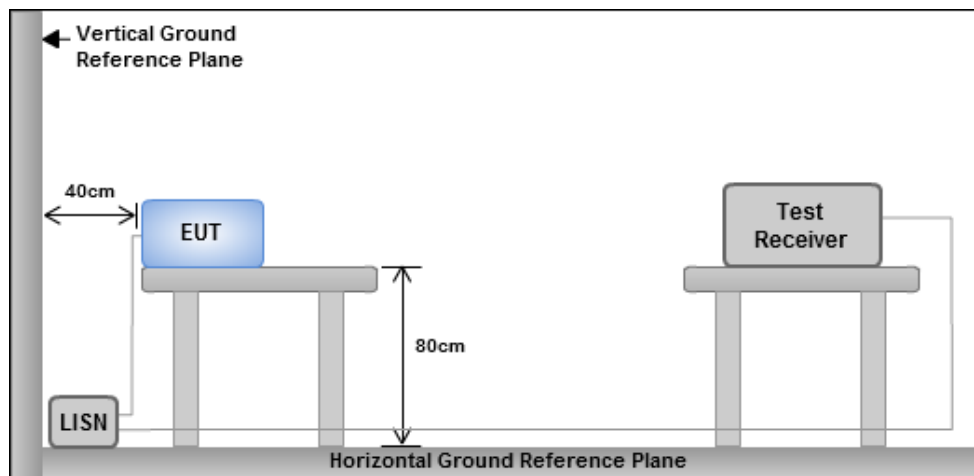

- Note: 1. Support units were connected to second LISN.
 2. Both of LISNs (AMN) are 80 cm from EUT and at least 80 cm from other units and other metal planes

3.1.4 Test Result of Conducted Emissions

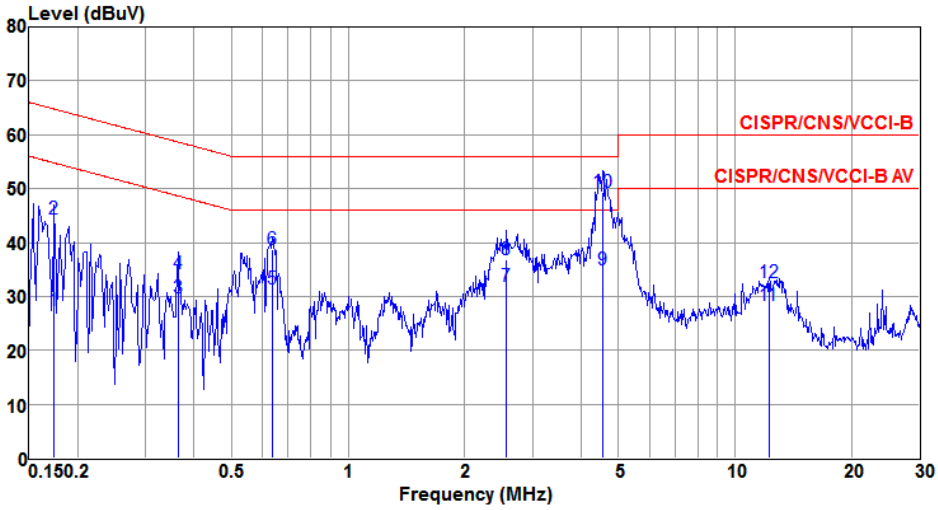
Modulation Mode	BT LE-1Mbps	Test Freq. (MHz)	2402																																																																																																																																							
Power Phase	Line																																																																																																																																									
																																																																																																																																										
<table border="1"> <thead> <tr> <th></th> <th>Freq</th> <th>Level</th> <th>Limit</th> <th>Over</th> <th>Read</th> <th>LISN</th> <th>cable</th> <th>Remark</th> </tr> <tr> <th></th> <th>MHz</th> <th>dBuV</th> <th>Line</th> <th>Limit</th> <th>Level</th> <th>factor</th> <th>loss</th> <th></th> </tr> <tr> <th></th> <th></th> <th></th> <th>dBuV</th> <th>dB</th> <th>dBuV</th> <th>dB</th> <th>dB</th> <th></th> </tr> </thead> <tbody> <tr> <td>1</td> <td>0.174</td> <td>27.40</td> <td>54.77</td> <td>-27.37</td> <td>27.27</td> <td>0.09</td> <td>0.04</td> <td>Average</td> </tr> <tr> <td>2</td> <td>0.174</td> <td>44.46</td> <td>64.77</td> <td>-20.31</td> <td>44.33</td> <td>0.09</td> <td>0.04</td> <td>QP</td> </tr> <tr> <td>3</td> <td>0.363</td> <td>29.72</td> <td>48.65</td> <td>-18.93</td> <td>29.61</td> <td>0.07</td> <td>0.04</td> <td>Average</td> </tr> <tr> <td>4</td> <td>0.363</td> <td>34.28</td> <td>58.65</td> <td>-24.37</td> <td>34.17</td> <td>0.07</td> <td>0.04</td> <td>QP</td> </tr> <tr> <td>5</td> <td>0.637</td> <td>31.33</td> <td>46.00</td> <td>-14.67</td> <td>31.22</td> <td>0.07</td> <td>0.04</td> <td>Average</td> </tr> <tr> <td>6</td> <td>0.637</td> <td>38.76</td> <td>56.00</td> <td>-17.24</td> <td>38.65</td> <td>0.07</td> <td>0.04</td> <td>QP</td> </tr> <tr> <td>7</td> <td>2.567</td> <td>31.78</td> <td>46.00</td> <td>-14.22</td> <td>31.56</td> <td>0.14</td> <td>0.08</td> <td>Average</td> </tr> <tr> <td>8</td> <td>2.567</td> <td>36.75</td> <td>56.00</td> <td>-19.25</td> <td>36.53</td> <td>0.14</td> <td>0.08</td> <td>QP</td> </tr> <tr> <td>9</td> <td>4.549</td> <td>34.96</td> <td>46.00</td> <td>-11.04</td> <td>34.62</td> <td>0.17</td> <td>0.17</td> <td>Average</td> </tr> <tr> <td>10</td> <td>4.549</td> <td>49.25</td> <td>56.00</td> <td>-6.75</td> <td>48.91</td> <td>0.17</td> <td>0.17</td> <td>QP</td> </tr> <tr> <td>11</td> <td>12.253</td> <td>28.42</td> <td>50.00</td> <td>-21.58</td> <td>27.94</td> <td>0.26</td> <td>0.22</td> <td>Average</td> </tr> <tr> <td>12</td> <td>12.253</td> <td>32.53</td> <td>60.00</td> <td>-27.47</td> <td>32.05</td> <td>0.26</td> <td>0.22</td> <td>QP</td> </tr> </tbody> </table>					Freq	Level	Limit	Over	Read	LISN	cable	Remark		MHz	dBuV	Line	Limit	Level	factor	loss					dBuV	dB	dBuV	dB	dB		1	0.174	27.40	54.77	-27.37	27.27	0.09	0.04	Average	2	0.174	44.46	64.77	-20.31	44.33	0.09	0.04	QP	3	0.363	29.72	48.65	-18.93	29.61	0.07	0.04	Average	4	0.363	34.28	58.65	-24.37	34.17	0.07	0.04	QP	5	0.637	31.33	46.00	-14.67	31.22	0.07	0.04	Average	6	0.637	38.76	56.00	-17.24	38.65	0.07	0.04	QP	7	2.567	31.78	46.00	-14.22	31.56	0.14	0.08	Average	8	2.567	36.75	56.00	-19.25	36.53	0.14	0.08	QP	9	4.549	34.96	46.00	-11.04	34.62	0.17	0.17	Average	10	4.549	49.25	56.00	-6.75	48.91	0.17	0.17	QP	11	12.253	28.42	50.00	-21.58	27.94	0.26	0.22	Average	12	12.253	32.53	60.00	-27.47	32.05	0.26	0.22	QP
	Freq	Level	Limit	Over	Read	LISN	cable	Remark																																																																																																																																		
	MHz	dBuV	Line	Limit	Level	factor	loss																																																																																																																																			
			dBuV	dB	dBuV	dB	dB																																																																																																																																			
1	0.174	27.40	54.77	-27.37	27.27	0.09	0.04	Average																																																																																																																																		
2	0.174	44.46	64.77	-20.31	44.33	0.09	0.04	QP																																																																																																																																		
3	0.363	29.72	48.65	-18.93	29.61	0.07	0.04	Average																																																																																																																																		
4	0.363	34.28	58.65	-24.37	34.17	0.07	0.04	QP																																																																																																																																		
5	0.637	31.33	46.00	-14.67	31.22	0.07	0.04	Average																																																																																																																																		
6	0.637	38.76	56.00	-17.24	38.65	0.07	0.04	QP																																																																																																																																		
7	2.567	31.78	46.00	-14.22	31.56	0.14	0.08	Average																																																																																																																																		
8	2.567	36.75	56.00	-19.25	36.53	0.14	0.08	QP																																																																																																																																		
9	4.549	34.96	46.00	-11.04	34.62	0.17	0.17	Average																																																																																																																																		
10	4.549	49.25	56.00	-6.75	48.91	0.17	0.17	QP																																																																																																																																		
11	12.253	28.42	50.00	-21.58	27.94	0.26	0.22	Average																																																																																																																																		
12	12.253	32.53	60.00	-27.47	32.05	0.26	0.22	QP																																																																																																																																		
<p>Note 1: Level (dBuV) = Read Level (dBuV) + LISN Factor (dB) + Cable Loss (dB). 2: Over Limit (dB) = Level (dBuV) – Limit Line (dBuV).</p>																																																																																																																																										

Modulation Mode	BT LE-1Mbps	Test Freq. (MHz)	2402
Power Phase	Neutral		

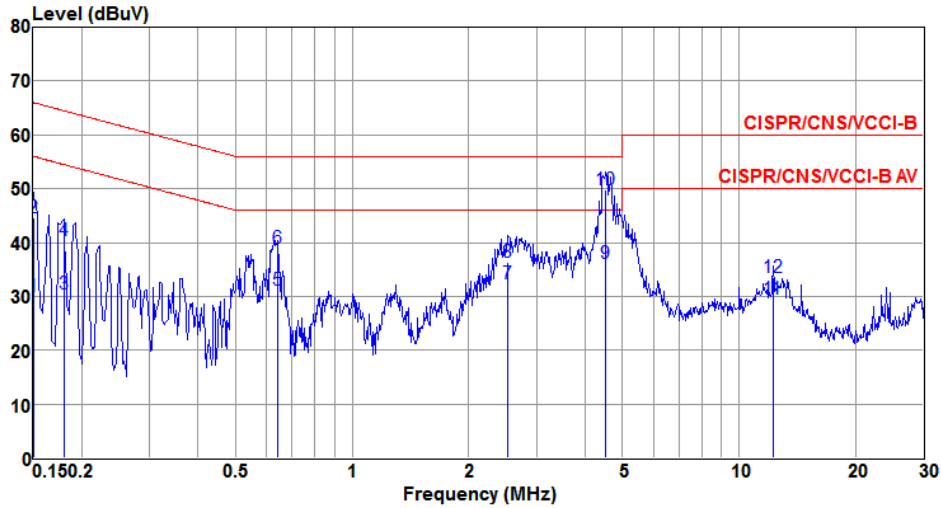

	Freq MHz	Level dBuV	Limit Line dBuV	Over Limit dB	Read Level dBuV	LISN factor dB	cable loss dB	Remark
1	0.150	29.93	56.00	-26.07	29.79	0.10	0.04	Average
2	0.150	44.64	66.00	-21.36	44.50	0.10	0.04	QP
3	0.180	30.48	54.50	-24.02	30.35	0.09	0.04	Average
4	0.180	40.37	64.50	-24.13	40.24	0.09	0.04	QP
5	0.641	31.27	46.00	-14.73	31.12	0.11	0.04	Average
6	0.641	39.04	56.00	-16.96	38.89	0.11	0.04	QP
7	2.527	32.40	46.00	-13.60	32.17	0.15	0.08	Average
8	2.527	36.46	56.00	-19.54	36.23	0.15	0.08	QP
9	4.523	36.18	46.00	-9.82	35.85	0.16	0.17	Average
10	4.523	49.69	56.00	-6.31	49.36	0.16	0.17	QP
11	12.253	29.39	50.00	-20.61	28.83	0.34	0.22	Average
12	12.253	33.42	60.00	-26.58	32.86	0.34	0.22	QP

Note 1: Level (dBuV) = Read Level (dBuV) + LISN Factor (dB) + Cable Loss (dB).
 Note 2: Over Limit (dB) = Level (dBuV) – Limit Line (dBuV).

3.2 6dB and Occupied Bandwidth

3.2.1 Limit of 6dB Bandwidth

The minimum 6dB bandwidth shall be at least 500 kHz.

3.2.2 Test Procedures

6dB Bandwidth

1. Set resolution bandwidth (RBW) = 100 kHz, Video bandwidth = 300 kHz.
2. Detector = Peak, Trace mode = max hold.
3. Sweep = auto couple, Allow the trace to stabilize.
4. Measure the maximum width of the emission that is constrained by the frequencies associated with the two outermost amplitude points (upper and lower) that are attenuated by 6dB relative to the maximum level measured in the fundamental emission.

Occupied Bandwidth

1. Set resolution bandwidth (RBW) = 30 kHz, Video bandwidth = 100 kHz.
2. Detector = Sample, Trace mode = max hold.
3. Sweep = auto couple, Allow the trace to stabilize.
4. Use the OBW measurement function of spectrum analyzer to measure the occupied bandwidth.

3.2.3 Test Setup

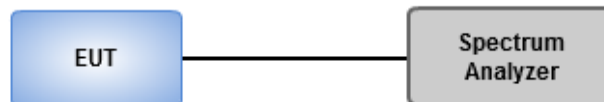

3.2.4 Test Result of 6dB and Occupied Bandwidth

Mode	Freq. (MHz)	6dB Bandwidth (MHz)	99% Occupied Bandwidth (MHz)	Limit of 6dB Bandwidth (kHz)
BT LE	2402	0.683	1.03	500
BT LE	2440	0.683	1.03	500
BT LE	2480	0.683	1.03	500

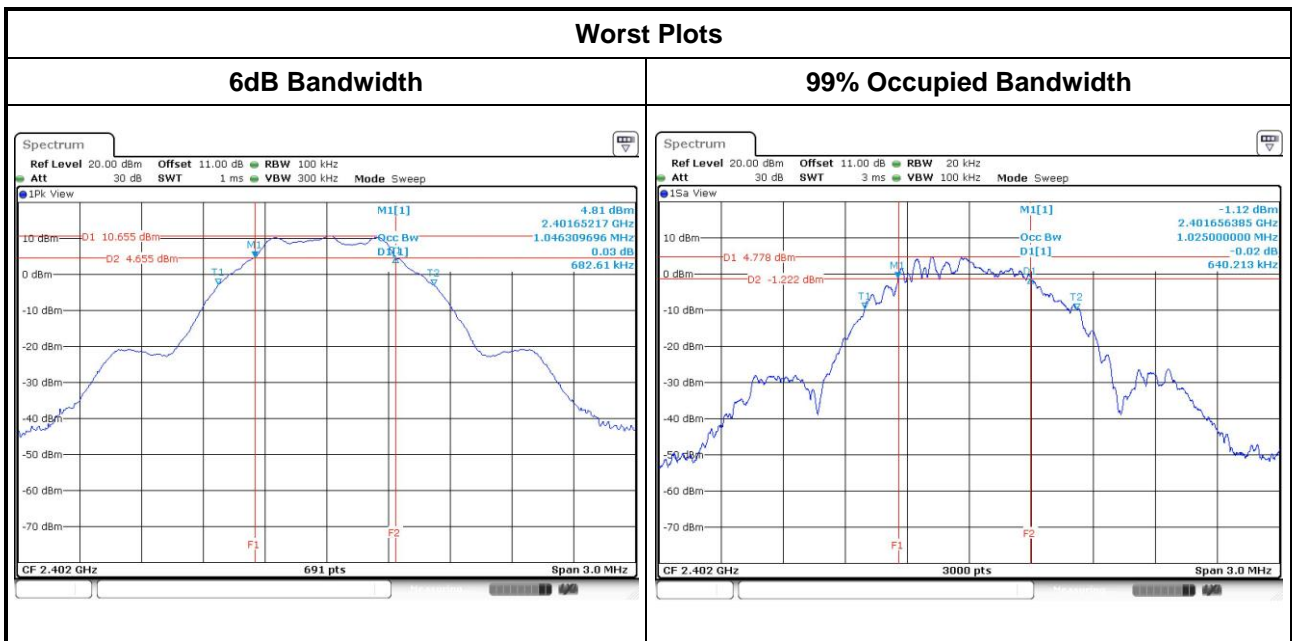

3.3 RF Output Power

3.3.1 Limit of RF Output Power

Conducted power shall not exceed 1Watt.

- Antenna gain \leq 6dBi, no any corresponding reduction is in output power limit.
- Antenna gain $>$ 6dBi
 - Non Fixed, point to point operations.
The conducted output power from the intentional radiator shall be reduced by the amount in dB that the directional gain of the antenna exceeds 6 dB
 - Fixed, point to point operations
Systems operating in the 2400–2483.5 MHz band that are used exclusively for fixed, point-to-point Operations, maximum peak output power of the intentional radiator is reduced by 1 dB for every 3 dB that the directional gain of the antenna exceeds 6 dBi.

Systems operating in the 5725–5850 MHz band that are used exclusively for fixed, point-to-point operations ,no any corresponding reduction is in transmitter peak output power

3.3.2 Test Procedures

- Maximum Peak Conducted Output Power
 - Spectrum analyzer**
 1. Set RBW = 1MHz, VBW = 3MHz, Detector = Peak.
 2. Sweep time = auto, Trace mode = max hold, Allow trace to fully stabilize.
 3. Use the spectrum analyzer channel power measurement function with the band limits set equal to the DTS bandwidth edges.
 - Power meter**
 1. A broadband Peak RF power meter is used for output power measurement. The video bandwidth of power meter is greater than DTS bandwidth of EUT. If duty cycle of test signal is not 100 %, trigger and gating function of power meter will be enabled to capture transmission burst for measuring output power.
- Maximum Conducted Average Output Power (For reference only)
 - Power meter**
 1. A broadband Average RF power meter is used for output power measurement. The video bandwidth of power meter is greater than DTS bandwidth of EUT. If duty cycle of test signal is not 100 %, trigger and gating function of power meter will be enabled to capture transmission burst for measuring output power.

3.3.3 Test Setup

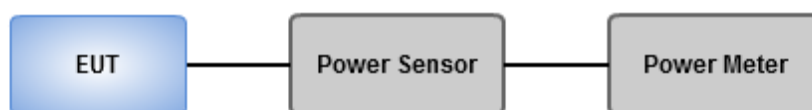

3.3.4 Test Result of Maximum Output Power

Mode	Freq. (MHz)	Peak Power			Antenna gain (dBi)	EIRP (dBm)	EIRP Limit (dBm)
		Power (mW)	Power (dBm)	Limit (dBm)			
BT LE	2402	12.02264	10.80	30	2.79	13.59	36
BT LE	2440	11.37627	10.56	30	2.79	13.35	36
BT LE	2480	10.44720	10.19	30	2.79	12.98	36

Mode	Freq. (MHz)	AV Power (mW)	AV Power (dBm)	Limit (dBm)
BT LE	2402	11.88502	10.75	---
BT LE	2440	11.22018	10.50	---
BT LE	2480	10.30386	10.13	---

Note: Average power is for reference only

3.4 Power Spectral Density

3.4.1 Limit of Power Spectral Density

Power spectral density shall not be greater than 8 dBm in any 3 kHz band.

3.4.2 Test Procedures

- Maximum peak conducted output power was used to demonstrate compliance to the fundamental output power limit.
 1. Set the RBW = 3kHz, VBW = 10kHz.
 2. Detector = Peak, Sweep time = auto couple.
 3. Trace mode = max hold, allow trace to fully stabilize.
 4. Use the peak marker function to determine the maximum amplitude level.
- Maximum (average) conducted output power was used to demonstrate compliance to the fundamental output power limit.
 1. Set the RBW = 100kHz, VBW = 300 kHz.
 2. Detector = RMS, Sweep time = auto couple.
 3. Set the sweep time to: $\geq 10 \times$ (number of measurement points in sweep) \times (maximum data rate per stream).
 4. Perform the measurement over a single sweep.
 5. Use the peak marker function to determine the maximum amplitude level.

3.4.3 Test Setup

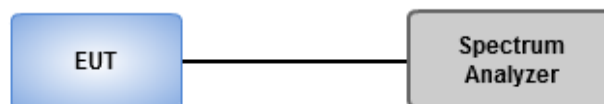

3.4.4 Test Result of Power Spectral Density

Mode	Freq. (MHz)	Total Power Spectral Density (dBm/3kHz)	Limit (dBm/3kHz)
BT LE	2402	-4.11	8
BT LE	2440	-4.37	8
BT LE	2480	-4.59	8

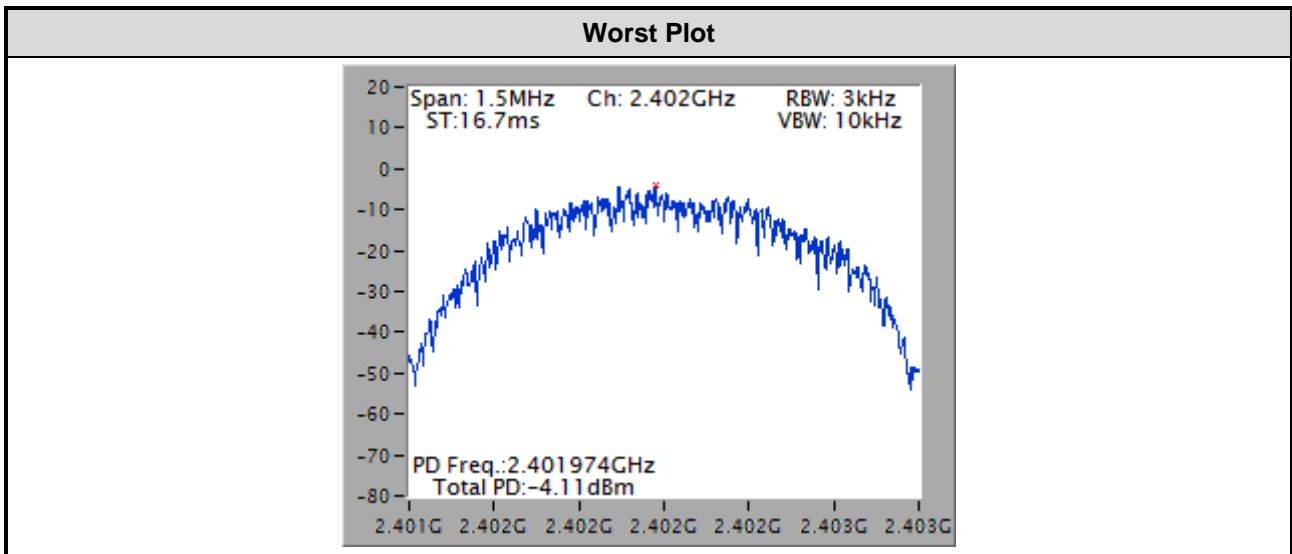

3.5 Emissions in Restricted Frequency Bands

3.5.1 Limit of Emissions in Restricted Frequency Bands

Restricted Band Emissions Limit			
Frequency Range (MHz)	Field Strength (uV/m)	Field Strength (dBuV/m)	Measure Distance (m)
0.009~0.490	2400/F(kHz)	48.5 - 13.8	300
0.490~1.705	24000/F(kHz)	33.8 - 23	30
1.705~30.0	30	29	30
30~88	100	40	3
88~216	150	43.5	3
216~960	200	46	3
Above 960	500	54	3

Note 1:
Quasi-Peak value is measured for frequency below 1GHz except for 9–90 kHz, 110–490 kHz frequency band. Peak and average value are measured for frequency above 1GHz. The limit on average radio frequency emission is as above table. The limit on peak radio frequency emissions is 20 dB above the maximum permitted average emission limit

Note 2:
Measurements may be performed at a distance other than what is specified provided. When performing measurements at a distance other than that specified, the results shall be extrapolated to the specified distance using an extrapolation factor as below, Frequency at or above 30 MHz: 20 dB/decade Frequency below 30 MHz: 40 dB/decade.

3.5.2 Test Procedures

1. Measurement is made at a semi-anechoic chamber that incorporates a turntable allowing a EUT rotation of 360°. A continuously-rotating, remotely-controlled turntable is installed at the test site to support the EUT and facilitate determination of the direction of maximum radiation for each EUT emission frequency. The EUT is placed at test table. For emissions testing at or below 1 GHz, the table height is 80 cm above the reference ground plane. For emission measurements above 1 GHz, the table height is 1.5 m
2. Measurement is made with the antenna positioned in both the horizontal and vertical planes of polarization. The measurement antenna is varied in height (1m ~ 4m) above the reference ground plane to obtain the maximum signal strength. Distance between EUT and antenna is 3 m.
3. This investigation is performed with the EUT rotated 360°, the antenna height scanned between 1 m and 4 m, and the antenna rotated to repeat the measurements for both the horizontal and vertical antenna polarizations.

Note:

1. 120kHz measurement bandwidth of test receiver and Quasi-peak detector is for radiated emission below 1GHz.
2. RBW=1MHz, VBW=3MHz and Peak detector is for peak measured value of radiated emission above 1GHz.
3. RBW=1MHz, VBW=1/T and Peak detector is for average measured value of radiated emission above 1GHz.

3.5.3 Test Setup

Radiated Emissions below 1 GHz

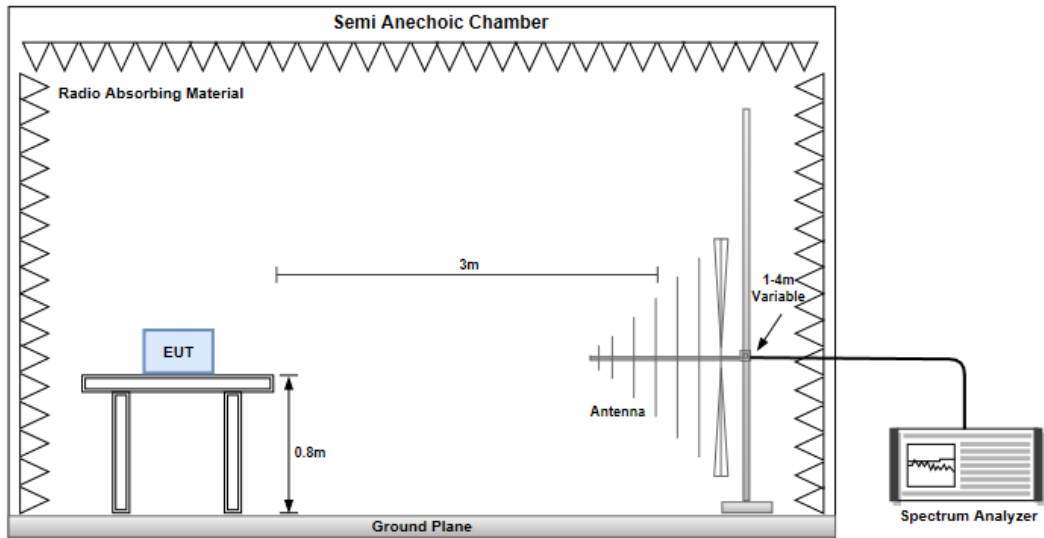

Radiated Emissions above 1 GHz

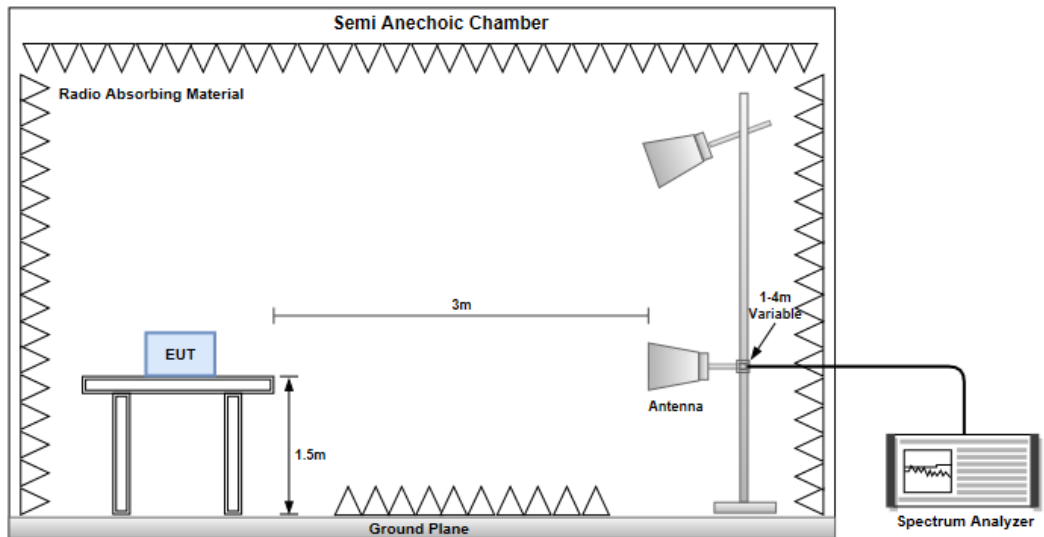

Conducted Emissions

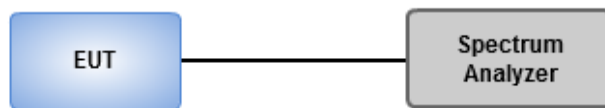

3.5.4 Transmitter Radiated Unwanted Emissions (Below 1GHz)

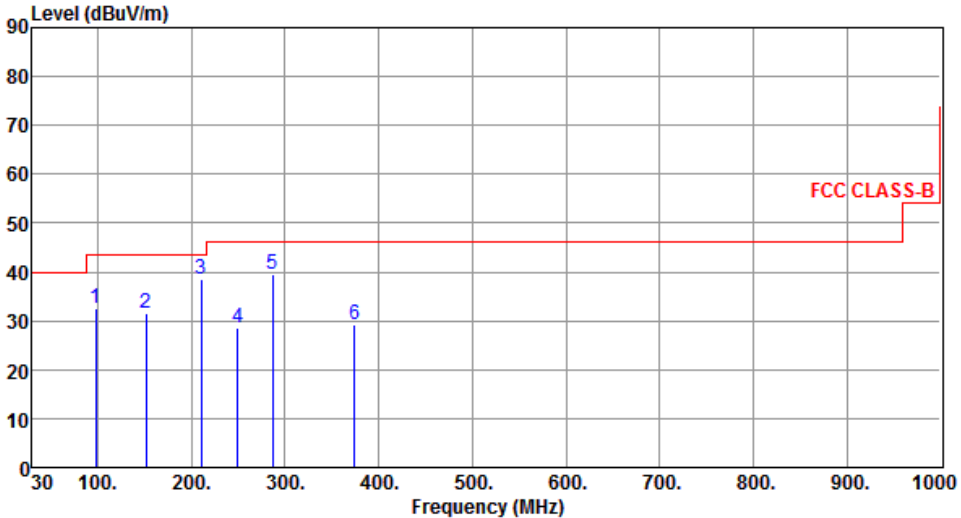
Modulation	BT LE-1Mbps	Test Freq. (MHz)	2402																																																																
Polarization	Horizontal																																																																		
																																																																			
	<table border="1"> <thead> <tr> <th>Freq. MHz</th> <th>Emission level dBuV/m</th> <th>Limit dBuV/m</th> <th>Margin dB</th> <th>SA reading dBuV</th> <th>Factor dB</th> <th>Remark</th> <th>ANT High cm</th> <th>Turn Table deg</th> </tr> </thead> <tbody> <tr> <td>1</td> <td>97.90</td> <td>32.62</td> <td>43.50</td> <td>-10.88</td> <td>46.39</td> <td>-13.77</td> <td>Peak</td> <td>---</td> </tr> <tr> <td>2</td> <td>151.25</td> <td>31.58</td> <td>43.50</td> <td>-11.92</td> <td>40.08</td> <td>-8.50</td> <td>Peak</td> <td>---</td> </tr> <tr> <td>3</td> <td>210.42</td> <td>38.47</td> <td>43.50</td> <td>-5.03</td> <td>49.75</td> <td>-11.28</td> <td>Peak</td> <td>---</td> </tr> <tr> <td>4</td> <td>249.22</td> <td>28.66</td> <td>46.00</td> <td>-17.34</td> <td>38.29</td> <td>-9.63</td> <td>Peak</td> <td>---</td> </tr> <tr> <td>5</td> <td>287.05</td> <td>39.59</td> <td>46.00</td> <td>-6.41</td> <td>47.83</td> <td>-8.24</td> <td>Peak</td> <td>---</td> </tr> <tr> <td>6</td> <td>374.35</td> <td>29.10</td> <td>46.00</td> <td>-16.90</td> <td>35.03</td> <td>-5.93</td> <td>Peak</td> <td>---</td> </tr> </tbody> </table>	Freq. MHz	Emission level dBuV/m	Limit dBuV/m	Margin dB	SA reading dBuV	Factor dB	Remark	ANT High cm	Turn Table deg	1	97.90	32.62	43.50	-10.88	46.39	-13.77	Peak	---	2	151.25	31.58	43.50	-11.92	40.08	-8.50	Peak	---	3	210.42	38.47	43.50	-5.03	49.75	-11.28	Peak	---	4	249.22	28.66	46.00	-17.34	38.29	-9.63	Peak	---	5	287.05	39.59	46.00	-6.41	47.83	-8.24	Peak	---	6	374.35	29.10	46.00	-16.90	35.03	-5.93	Peak	---			
Freq. MHz	Emission level dBuV/m	Limit dBuV/m	Margin dB	SA reading dBuV	Factor dB	Remark	ANT High cm	Turn Table deg																																																											
1	97.90	32.62	43.50	-10.88	46.39	-13.77	Peak	---																																																											
2	151.25	31.58	43.50	-11.92	40.08	-8.50	Peak	---																																																											
3	210.42	38.47	43.50	-5.03	49.75	-11.28	Peak	---																																																											
4	249.22	28.66	46.00	-17.34	38.29	-9.63	Peak	---																																																											
5	287.05	39.59	46.00	-6.41	47.83	-8.24	Peak	---																																																											
6	374.35	29.10	46.00	-16.90	35.03	-5.93	Peak	---																																																											
<p>Note 1: Emission Level (dBuV/m) = SA Reading (dBuV/m) + Factor* (dB) *Factor includes antenna factor , cable loss and amplifier gain Note 2: Margin (dB) = Emission level (dBuV/m) – Limit (dBuV/m). Note 3: All spurious emissions below 30MHz are more than 20 dB below the limit.</p>																																																																			

Modulation	BT LE-1Mbps	Test Freq. (MHz)	2402
Polarization	Vertical		

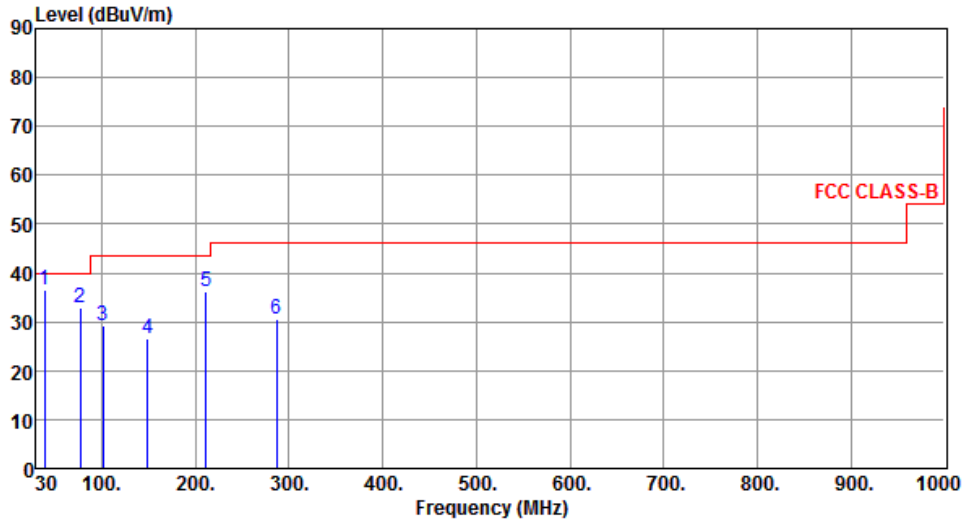

	Freq. MHz	Emission level dBuV/m	Limit dBuV/m	Margin dB	SA reading dBuV	Factor dB	Remark	ANT High cm	Turn Table deg
1	38.73	36.51	40.00	-3.49	45.36	-8.85	Peak	---	---
2	77.53	32.86	40.00	-7.14	45.50	-12.64	Peak	---	---
3	101.78	29.32	43.50	-14.18	42.55	-13.23	Peak	---	---
4	149.31	26.63	43.50	-16.87	35.17	-8.54	Peak	---	---
5	211.39	36.04	43.50	-7.46	47.31	-11.27	Peak	---	---
6	287.05	30.58	46.00	-15.42	38.82	-8.24	Peak	---	---

Note 1: Emission Level (dBuV/m) = SA Reading (dBuV/m) + Factor* (dB)

*Factor includes antenna factor, cable loss and amplifier gain

Note 2: Margin (dB) = Emission level (dBuV/m) – Limit (dBuV/m).

Note 3: All spurious emissions below 30MHz are more than 20 dB below the limit.

3.5.5 Transmitter Radiated Unwanted Emissions (Above 1GHz) for GFSK

Modulation	BT LE-1Mbps	Test Freq. (MHz)	2402
Polarization	Horizontal		

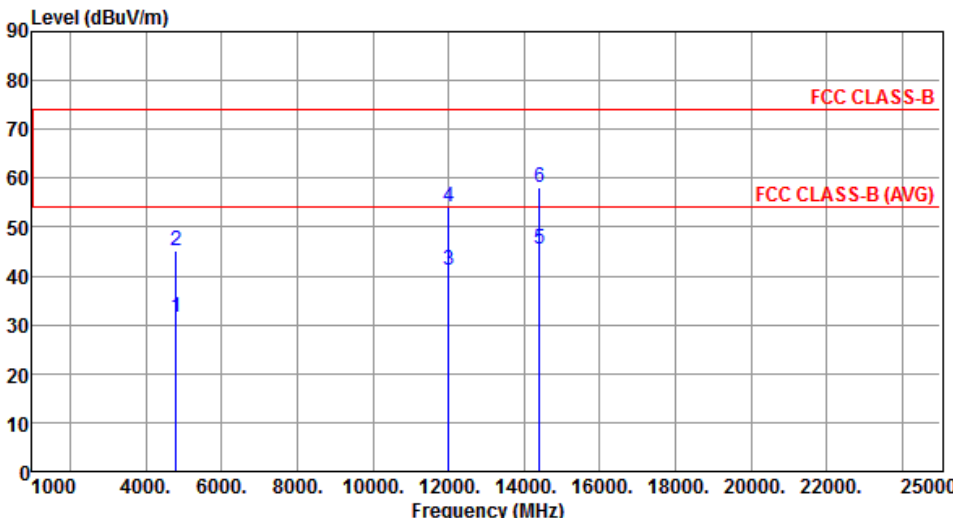

The graph plots Level (dBuV/m) on the y-axis (0 to 90) against Frequency (MHz) on the x-axis (1000 to 25000). Two horizontal red lines represent FCC limits: FCC CLASS-B at approximately 74 dBuV/m and FCC CLASS-B (AVG) at approximately 54 dBuV/m. Six data points are shown as vertical blue lines with labels 1 through 6. Points 1 and 2 are at 4804 MHz, point 3 is at 12010 MHz, and points 4, 5, and 6 are at 14412 MHz. Points 4 and 6 exceed the FCC CLASS-B (AVG) limit.

	Freq. MHz	Emission level dBuV/m	Limit dBuV/m	Margin dB	SA reading dBuV	Factor dB	Remark	ANT High cm	Turn Table deg
1	4804.00	31.45	54.00	-22.55	27.02	4.43	Average	100	128
2	4804.00	45.15	74.00	-28.85	40.72	4.43	Peak	100	128
3	12010.00	41.27	54.00	-12.73	27.53	13.74	Average	100	147
4	12010.00	54.12	74.00	-19.88	40.38	13.74	Peak	100	147
5	14412.00	45.41	54.00	-8.59	28.14	17.27	Average	100	182
6	14412.00	58.22	74.00	-15.78	40.95	17.27	Peak	100	182

Note 1: Emission Level (dBuV/m) = SA Reading (dBuV/m) + Factor* (dB)
*Factor includes antenna factor , cable loss and amplifier gain
Note 2: Margin (dB) = Emission level (dBuV/m) – Limit (dBuV/m).

Modulation	BT LE-1Mbps	Test Freq. (MHz)	2402
Polarization	Vertical		

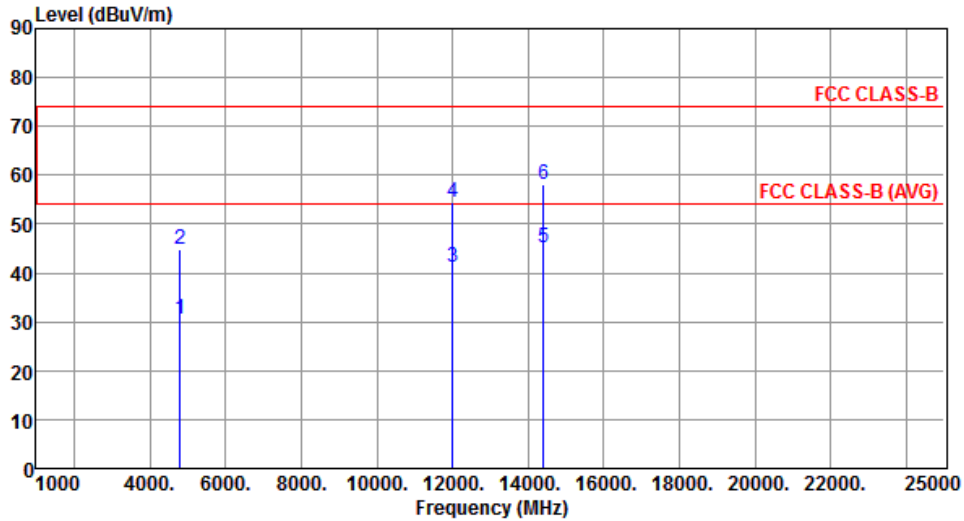

	Freq. MHz	Emission level dBuV/m	Limit dBuV/m	Margin dB	SA reading dBuV	Factor dB	Remark	ANT High cm	Turn Table deg
1	4804.00	30.55	54.00	-23.45	26.12	4.43	Average	100	212
2	4804.00	44.82	74.00	-29.18	40.39	4.43	Peak	100	212
3	12010.00	41.27	54.00	-12.73	27.53	13.74	Average	100	155
4	12010.00	54.38	74.00	-19.62	40.64	13.74	Peak	100	155
5	14412.00	45.08	54.00	-8.92	27.81	17.27	Average	100	148
6	14412.00	58.10	74.00	-15.90	40.83	17.27	Peak	100	148

Note 1: Emission Level (dBuV/m) = SA Reading (dBuV/m) + Factor* (dB)

*Factor includes antenna factor , cable loss and amplifier gain

Note 2: Margin (dB) = Emission level (dBuV/m) – Limit (dBuV/m).

Modulation	BT LE-1Mbps	Test Freq. (MHz)	2440
Polarization	Horizontal		

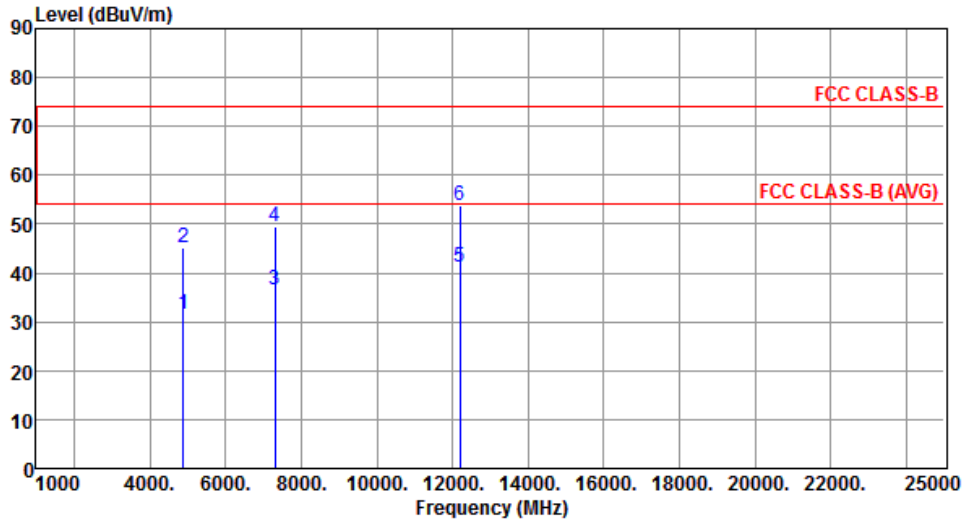

	Freq. MHz	Emission level dBuV/m	Limit dBuV/m	Margin dB	SA reading dBuV	Factor dB	Remark	ANT High cm	Turn Table deg
1	4880.00	31.47	54.00	-22.53	26.88	4.59	Average	100	330
2	4880.00	45.12	74.00	-28.88	40.53	4.59	Peak	100	330
3	7320.00	36.41	54.00	-17.59	27.25	9.16	Average	100	168
4	7320.00	49.63	74.00	-24.37	40.47	9.16	Peak	100	168
5	12200.00	41.20	54.00	-12.80	27.72	13.48	Average	100	157
6	12200.00	53.76	74.00	-20.24	40.28	13.48	Peak	100	157

Note 1: Emission Level (dBuV/m) = SA Reading (dBuV/m) + Factor* (dB)

*Factor includes antenna factor , cable loss and amplifier gain

Note 2: Margin (dB) = Emission level (dBuV/m) – Limit (dBuV/m).

Modulation	BT LE-1Mbps	Test Freq. (MHz)	2440
Polarization	Vertical		

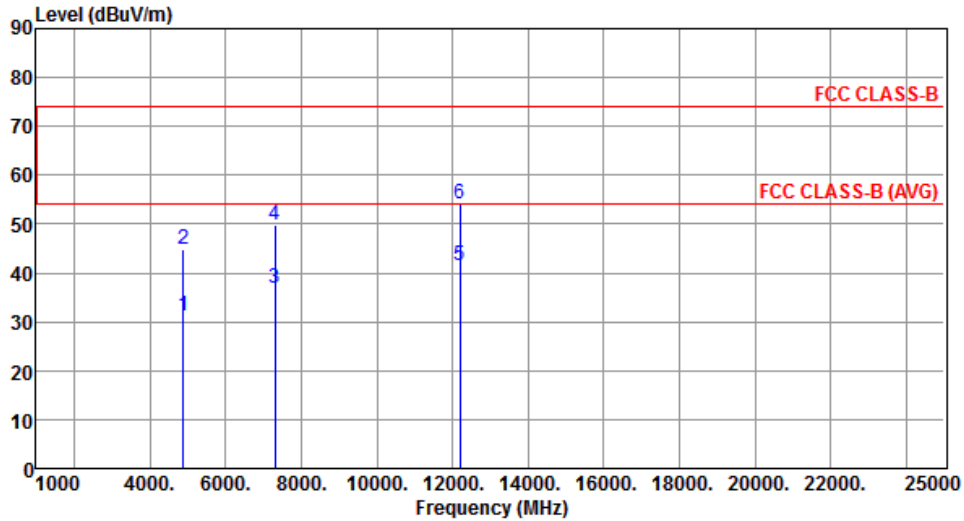

	Freq. MHz	Emission level dBuV/m	Limit dBuV/m	Margin dB	SA reading dBuV	Factor dB	Remark	ANT High cm	Turn Table deg
1	4880.00	31.18	54.00	-22.82	26.59	4.59	Average	100	156
2	4880.00	44.96	74.00	-29.04	40.37	4.59	Peak	100	156
3	7320.00	36.72	54.00	-17.28	27.56	9.16	Average	100	38
4	7320.00	49.89	74.00	-24.11	40.73	9.16	Peak	100	38
5	12200.00	41.52	54.00	-12.48	28.04	13.48	Average	100	196
6	12200.00	54.20	74.00	-19.80	40.72	13.48	Peak	100	196

Note 1: Emission Level (dBuV/m) = SA Reading (dBuV/m) + Factor* (dB)

*Factor includes antenna factor , cable loss and amplifier gain

Note 2: Margin (dB) = Emission level (dBuV/m) – Limit (dBuV/m).

Modulation	BT LE-1Mbps	Test Freq. (MHz)	2480
Polarization	Horizontal		

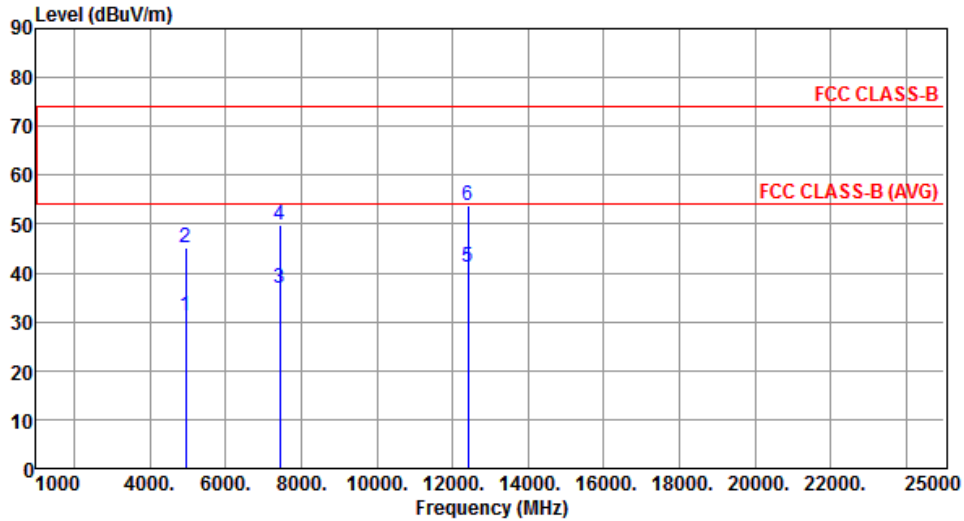

	Freq. MHz	Emission level dBuV/m	Limit dBuV/m	Margin dB	SA reading dBuV	Factor dB	Remark	ANT High cm	Turn Table deg
1	4960.00	31.07	54.00	-22.93	26.33	4.74	Average	100	145
2	4960.00	45.12	74.00	-28.88	40.38	4.74	Peak	100	145
3	7440.00	36.88	54.00	-17.12	27.38	9.50	Average	100	124
4	7440.00	49.91	74.00	-24.09	40.41	9.50	Peak	100	124
5	12400.00	41.10	54.00	-12.90	27.90	13.20	Average	100	152
6	12400.00	53.89	74.00	-20.11	40.69	13.20	Peak	100	152

Note 1: Emission Level (dBuV/m) = SA Reading (dBuV/m) + Factor* (dB)

*Factor includes antenna factor , cable loss and amplifier gain

Note 2: Margin (dB) = Emission level (dBuV/m) – Limit (dBuV/m).

Modulation	BT LE-1Mbps	Test Freq. (MHz)	2480
Polarization	Vertical		

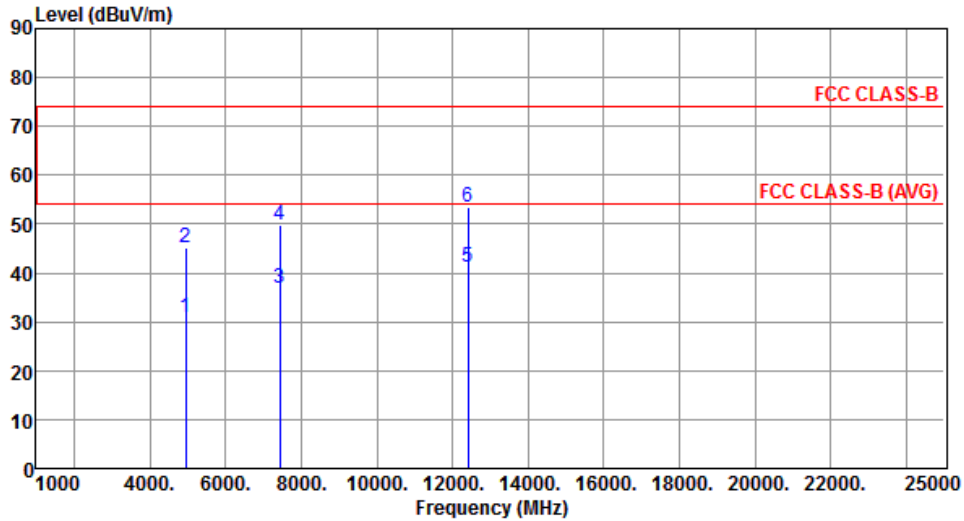

	Freq. MHz	Emission level dBuV/m	Limit dBuV/m	Margin dB	SA reading dBuV	Factor dB	Remark	ANT High cm	Turn Table deg
1	4960.00	30.97	54.00	-23.03	26.23	4.74	Average	100	183
2	4960.00	45.11	74.00	-28.89	40.37	4.74	Peak	100	183
3	7440.00	36.70	54.00	-17.30	27.20	9.50	Average	100	148
4	7440.00	49.78	74.00	-24.22	40.28	9.50	Peak	100	148
5	12400.00	41.08	54.00	-12.92	27.88	13.20	Average	100	215
6	12400.00	53.59	74.00	-20.41	40.39	13.20	Peak	100	215

Note 1: Emission Level (dBuV/m) = SA Reading (dBuV/m) + Factor* (dB)

*Factor includes antenna factor , cable loss and amplifier gain

Note 2: Margin (dB) = Emission level (dBuV/m) – Limit (dBuV/m).

3.5.6 Transmitter Conducted Unwanted Emissions (Below 1 GHz)

Modulation Mode		BT LE-1Mbps		Frequency	2402MHz	
Range (MHz)	Max Value chain0 (dBm)	DG (dBi)	GRF (dB)	EIRP (dBm)	Min E-Field Limit (dBm)	E-Field Margin (dB)
30~1000MHz	-78.29	2.79	4.70	-70.80	-55.20	-15.60

Note:

1. GRF = Ground Reflection Factor.
2. DG = Directional Gain.
3. Worst case of emission limit below 1GHz is selected to be limit.

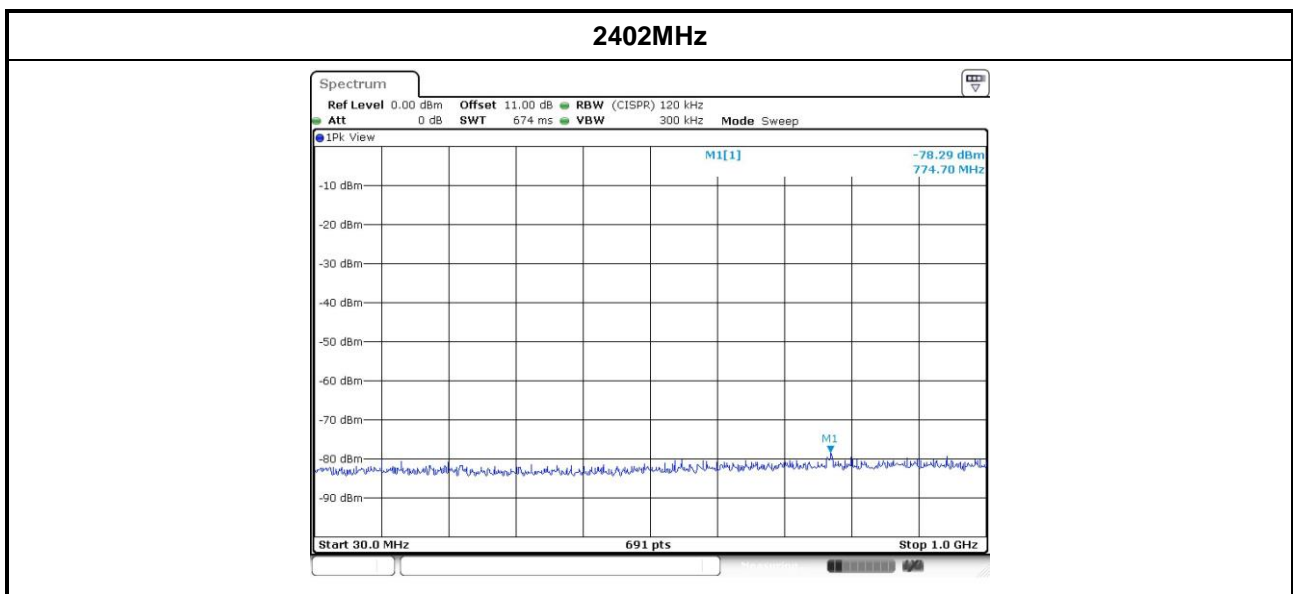

3.5.7 Transmitter Conducted Unwanted Emissions (Above 1GHz)

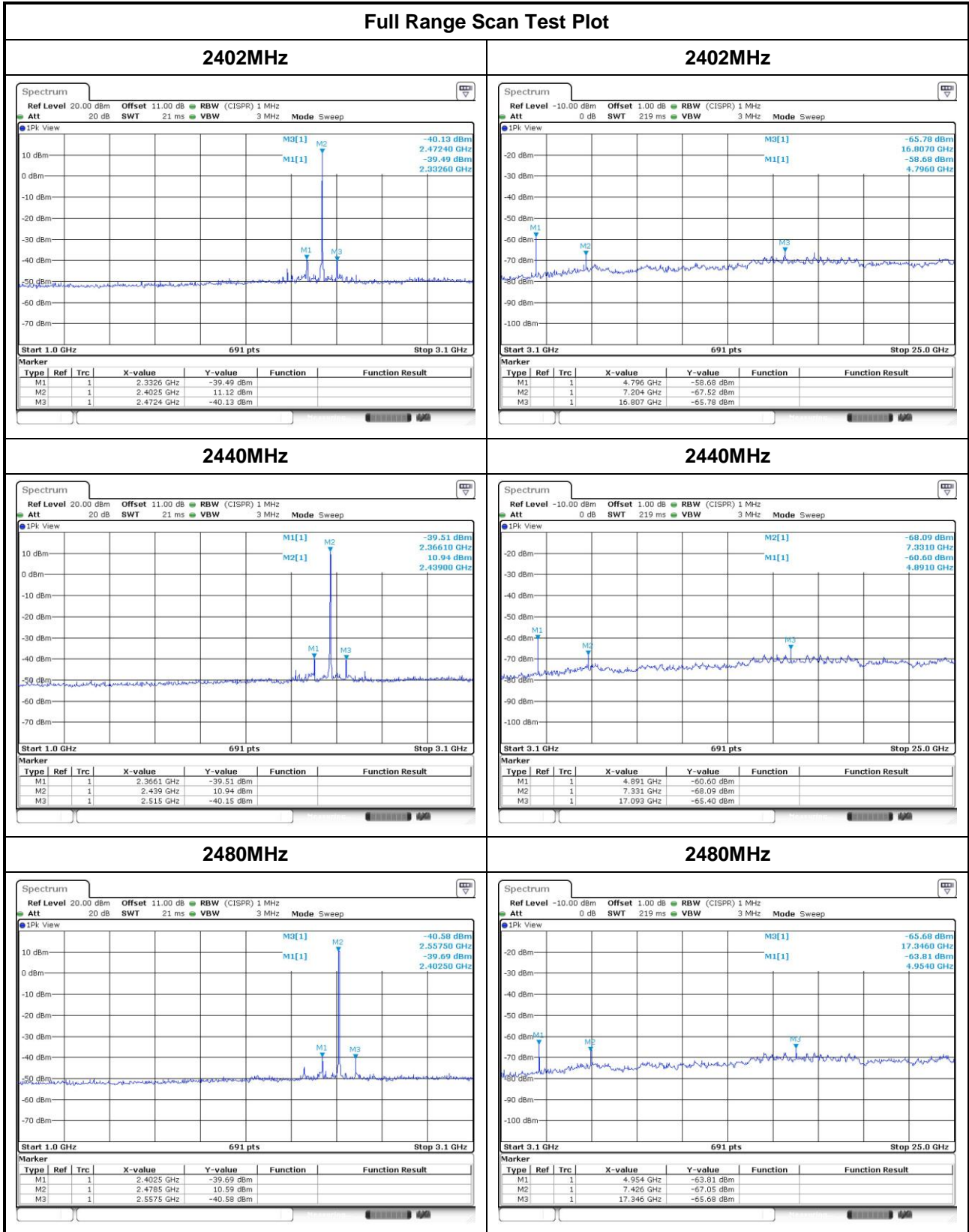

Transmitter Conducted Unwanted Emissions Results in Band Edge							
Test ch. Freq. (MHz)	Range (MHz)	Max Value chain0 (dBm)	DG (dBi)	EIRP (dBm)	E-Field Limit (dBm)	E-Field Margin (dB)	Remark
2402	2310~2390	-39.22	2.79	-36.43	-21.20	-15.23	PK
	2310~2390	-49.58	2.79	-46.79	-41.20	-5.59	AV
	2483.5~2500	-45.98	2.79	-43.19	-21.20	-21.99	PK
	2483.5~2500	-58.01	2.79	-55.22	-41.20	-14.02	AV
2440	2310~2390	-38.97	2.79	-36.18	-21.20	-14.98	PK
	2310~2390	-50.02	2.79	-47.23	-41.20	-6.03	AV
	2483.5~2500	-46.99	2.79	-44.20	-21.20	-23.00	PK
	2483.5~2500	-59.31	2.79	-56.52	-41.20	-15.32	AV
2480	2310~2390	-41.13	2.79	-38.34	-21.20	-17.14	PK
	2310~2390	-57.08	2.79	-54.29	-41.20	-13.09	AV
	2485.5~2500	-42.09	2.79	-39.30	-21.20	-18.10	PK
	2485.5~2500	-53.61	2.79	-50.82	-41.20	-9.62	AV

Band Edge Test Plot

2402MHz - AV

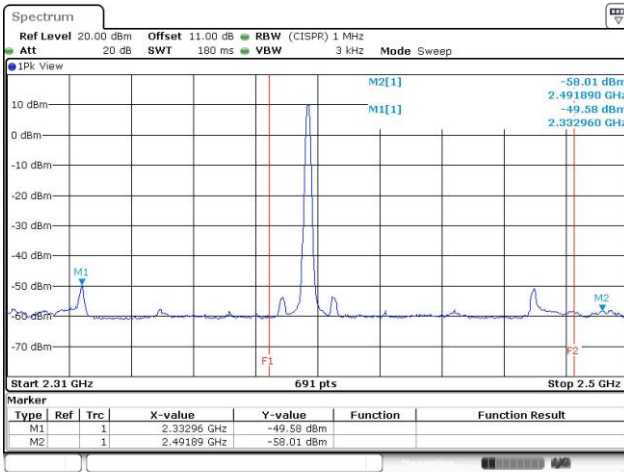

2402MHz - PK

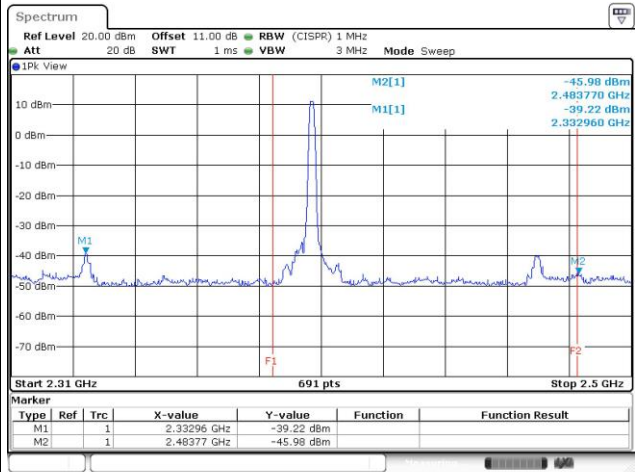

2440MHz - AV

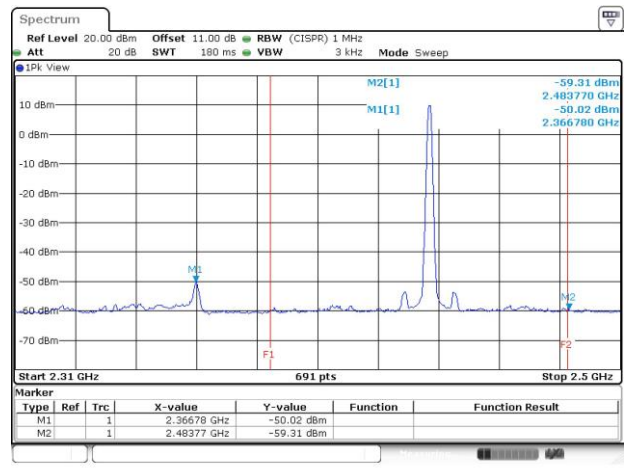

2440MHz - PK

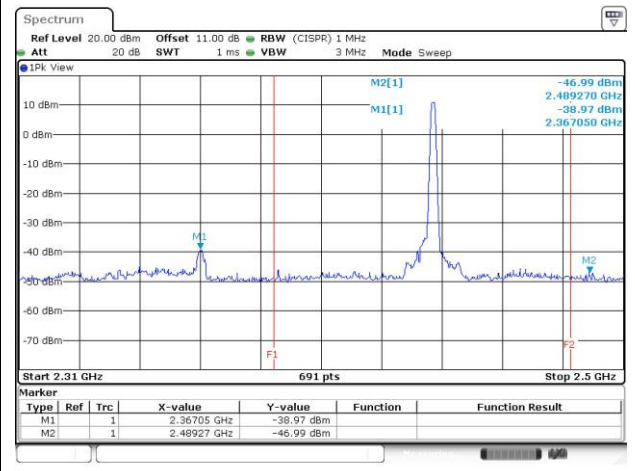

2480MHz - AV

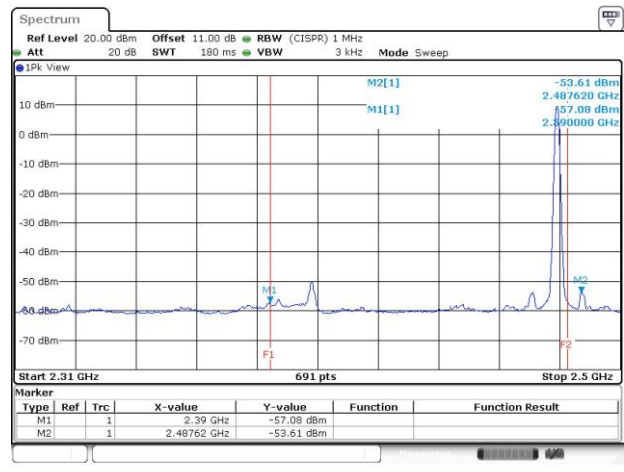

2480MHz - PK

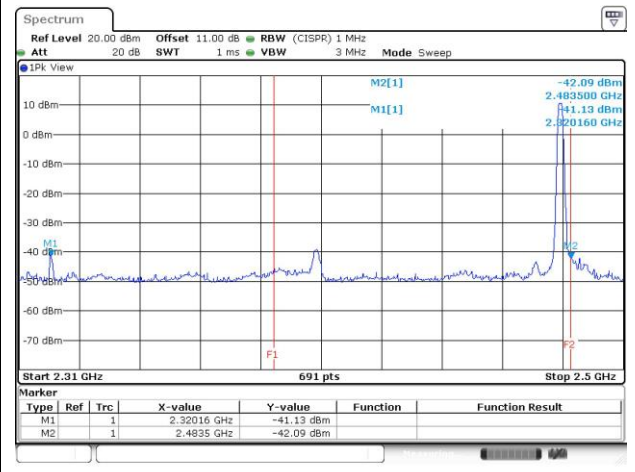

Transmitter Conducted Unwanted Emissions Results in Restricted Frequency Band						
Modulation Mode		BT LE-1Mbps		Frequency	2402MHz	
Freq. (MHz)	Remark	Max Value chain0 (dBm)	DG (dBi)	EIRP (dBm)	E-Field Limit (dBm)	E-Field Margin (dB)
4804.00	PK	-57.89	2.79	-55.10	-21.20	-33.90
4804.00	AV ^{note1}	-	-	-	-41.20	-

Transmitter Conducted Unwanted Emissions Results in Restricted Frequency Band						
Modulation Mode		BT LE-1Mbps		Frequency	2440MHz	
Freq. (MHz)	Remark	Max Value chain0 (dBm)	DG (dBi)	EIRP (dBm)	E-Field Limit (dBm)	E-Field Margin (dB)
4880.00	PK	-59.92	2.79	-57.13	-21.20	-35.93
4880.00	AV ^{note1}	-	-	-	-41.20	-
7320.00	PK	-66.54	2.79	-63.75	-21.20	-42.55
7320.00	AV ^{note1}	-	-	-	-41.20	-

Transmitter Conducted Unwanted Emissions Results in Restricted Frequency Band						
Modulation Mode		BT LE-1Mbps		Frequency	2480MHz	
Freq. (MHz)	Remark	Max Value chain0 (dBm)	DG (dBi)	EIRP (dBm)	E-Field Limit (dBm)	E-Field Margin (dB)
4960.00	PK	-62.74	2.79	-59.95	-21.20	-38.75
4960.00	AV ^{note1}	-	-	-	-41.20	-
7440.00	PK	-65.06	2.79	-62.27	-21.20	-41.07
7440.00	AV ^{note1}	-	-	-	-41.20	-

Note:

1. If the PK margin greater than 20 dB, there is no need to get AVG reading.
2. DG = Directional Gain.

Test Plots

4804MHz - PK



4880MHz - PK

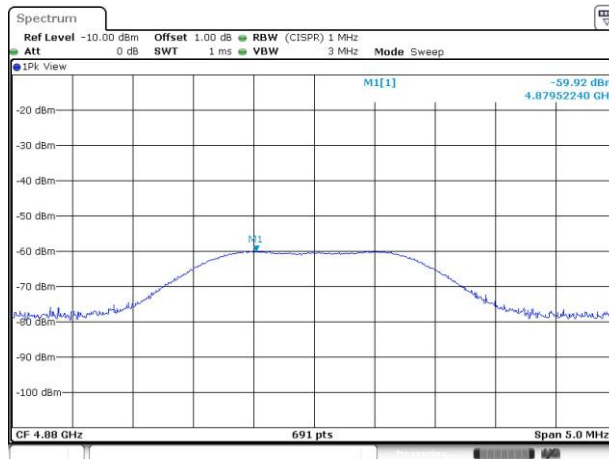

7320MHz - PK

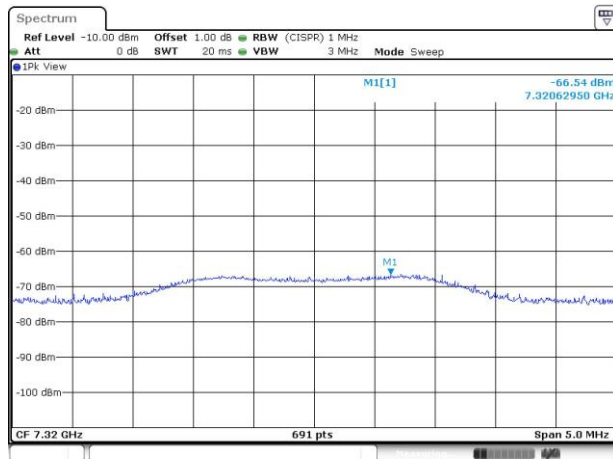

Test Plots

4960MHz - PK

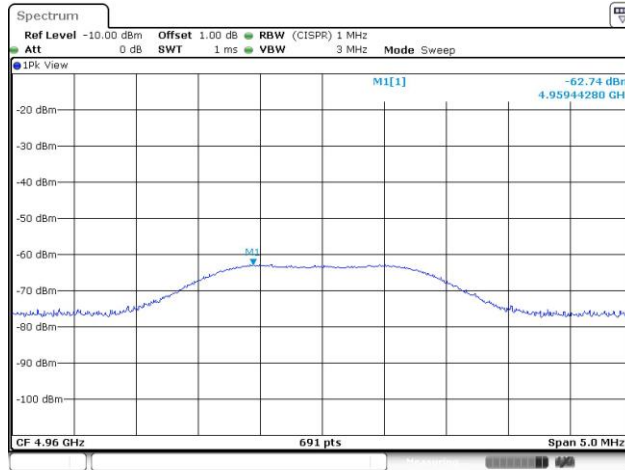

7440MHz - PK

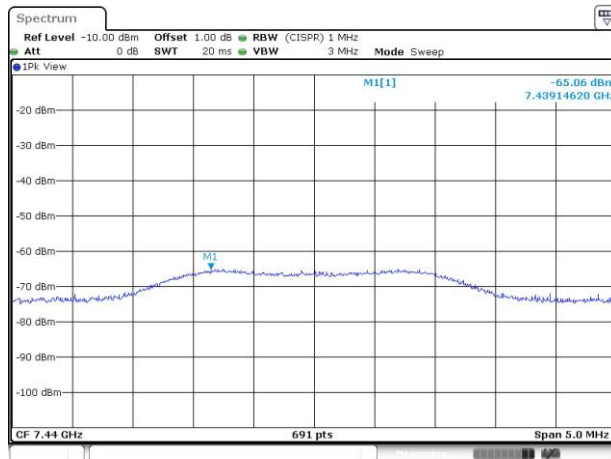

3.6 Emissions in non-restricted Frequency Bands

3.6.1 Emissions in non-restricted frequency bands limit

The peak output power measured in any 100 kHz bandwidth outside of the authorized frequency band shall be attenuated by at least 20 dB relative to the maximum in-band peak PSD level in 100 kHz.

3.6.2 Test Procedures

Reference Level Measurement

1. Set the RBW = 100 kHz, VBW = 300 kHz, Detector = peak.
2. Set Sweep time = auto couple, Trace mode = max hold.
3. Allow trace to fully stabilize.
4. Use the peak marker function to determine the maximum amplitude level.

Unwanted Emissions Level Measurement

1. Set RBW = 100 kHz, VBW = 300 kHz, Detector = peak.
2. Trace Mode = max hold, Sweep = auto couple.
3. Allow the trace to stabilize.
4. Use peak marker function to determine maximum amplitude of all unwanted emissions within any 100 kHz bandwidth.

3.6.3 Test Setup

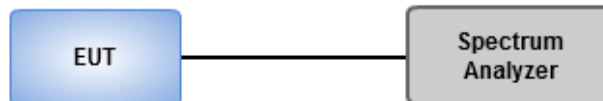

3.6.4 Test Result of Emissions in non-restricted Frequency Bands

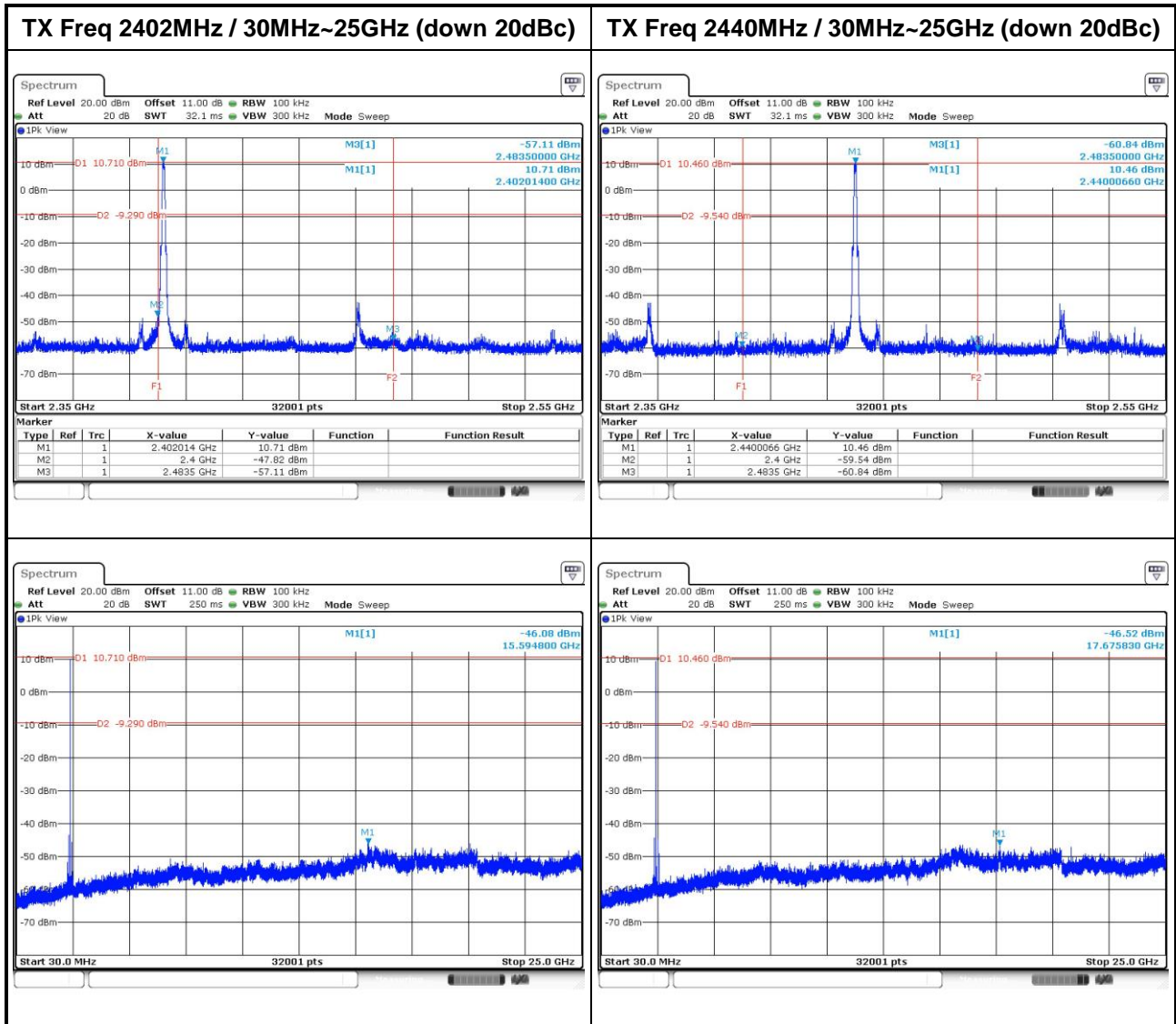

TX Freq 2480MHz / 30MHz~25GHz (down 20dBc)

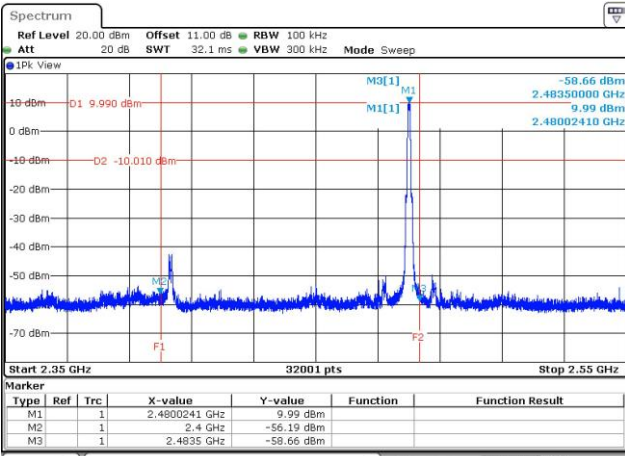

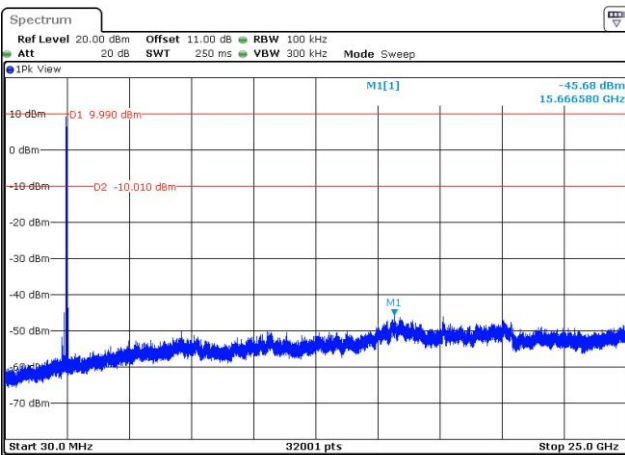

4 Test laboratory information

Established in 2012, ICC provides foremost EMC & RF Testing and advisory consultation services by our skilled engineers and technicians. Our services employ a wide variety of advanced edge test equipment and one of the widest certification extents in the business.

International Certification Corp (EMC and Wireless Communication Laboratory), it is our definitive objective is to institute long term, trust-based associations with our clients. The expectation we set up with our clients is based on outstanding service, practical expertise and devotion to a certified value structure. Our passion is to grant our clients with best EMC / RF services by oriented knowledgeable and accommodating staff.

Our Test sites are located at Linkou District and Kwei Shan District. Location map can be found on our website <http://www.icertifi.com.tw>.

Linkou

Tel: 886-2-2601-1640

No. 30-2, Ding Fwu Tsuen, Lin
Kou District, New Taipei City,
Taiwan, R.O.C.

Kwei Shan

Tel: 886-3-271-8666

No. 3-1, Lane 6, Wen San 3rd St.,
Kwei Shan District, Tao Yuan City
333, Taiwan, R.O.C.

Kwei Shan Site II

Tel: 886-3-271-8640

No. 14-1, Lane 19, Wen San 3rd
St., Kwei Shan District, Tao Yuan
City 333, Taiwan, R.O.C.

If you have any suggestion, please feel free to contact us as below information.

Tel: 886-3-271-8666

Fax: 886-3-318-0155

Email: ICC_Service@icertifi.com.tw

==END==