

FCC Test Report

FCC ID : SQG-60SIPT
Equipment : 802.11 ac/a/b/g/n + Bluetooth 4.2 module
(please refer to section 1.1.1 for more details.)
Model No. : ST60-SIPT
(please refer to section 1.1.1 for more details.)
Brand Name : Laird Technologies
Applicant : Laird Technologies
Address : W66N220 Commerce Court, Cedarburg,
Wisconsin 53012, USA
Standard : 47 CFR FCC Part 15.247
Received Date : Apr. 07, 2017
Tested Date : Apr. 12 ~ May 10, 2017

We, International Certification Corp., would like to declare that the tested sample has been evaluated and in compliance with the requirement of the above standards. The test results contained in this report refer exclusively to the product. It may be duplicated completely for legal use with the approval of the applicant. It shall not be reproduced except in full without the written approval of our laboratory.

Reviewed by:

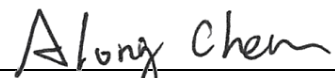

Along Chen / Assistant Manager

Approved by:



Gary Chang / Manager



Table of Contents

1	GENERAL DESCRIPTION	5
1.1	Information.....	5
1.2	Local Support Equipment List	7
1.3	Test Setup Chart	7
1.4	The Equipment List	9
1.5	Test Standards	10
1.6	Measurement Uncertainty	10
2	TEST CONFIGURATION	11
2.1	Testing Condition	11
2.2	The Worst Test Modes and Channel Details	11
3	TRANSMITTER TEST RESULTS.....	12
3.1	Conducted Emissions.....	12
3.2	Unwanted Emissions into Restricted Frequency Bands	15
3.3	Unwanted Emissions into Non-Restricted Frequency Bands	43
3.4	Conducted Output Power	48
3.5	Number of Hopping Frequency	50
3.6	20dB and Occupied Bandwidth	52
3.7	Channel Separation.....	54
3.8	Number of Dwell Time.....	56
4	TEST LABORATORY INFORMATION	59

Release Record

Report No.	Version	Description	Issued Date
FR740701AD	Rev. 01	Initial issue	Jul. 13, 2017
FR740701AD	Rev. 02	Revised model name	Jul. 21, 2017

Summary of Test Results

FCC Rules	Test Items	Measured	Result
15.207	Conducted Emissions	[dBuV]: 4.646MHz 48.88 (Margin -7.12dB) - QP	Pass
15.247(d) 15.209	Radiated Emissions	Meet the requirement of limit	Pass
15.247(d)	Band Edge	Meet the requirement of limit	Pass
15.247(b)(1)	Conducted Output Power	Power [dBm]: 10.83	Pass
15.247(a)(1)(iii)	Number of Hopping Channels	Meet the requirement of limit	Pass
15.247(a)(1)	Hopping Channel Separation	Meet the requirement of limit	Pass
15.247(a)(1)(iii)	Dwell Time	Meet the requirement of limit	Pass
15.203	Antenna Requirement	Meet the requirement of limit	Pass

1 General Description

1.1 Information

1.1.1 Product Details

The following models are provided to this EUT.

Brand Name	Model Name	Product Name	Description	
Laird Technologies	ST60-SIPT	802.11 ac/a/b/g/n + Bluetooth 4.2 module	SIPT only	For marketing purpose
	SU60-SIPT			
	ST60-2230C	802.11 ac/a/b/g/n M.2 2230 + Bluetooth 4.2 module	with carrier board	
	SU60-2230C			
<p>✦ The above models, model ST60-2230C was selected as a representative one for the final test and only its data was recorded in this report.</p>				

1.1.2 Specification of the Equipment under Test (EUT)

RF General Information				
Frequency Range (MHz)	Bluetooth Mode	Ch. Frequency (MHz)	Channel Number	Data Rate
2400-2483.5	BR	2402-2480	0-78 [79]	1 Mbps
2400-2483.5	EDR	2402-2480	0-78 [79]	2 Mbps
2400-2483.5	EDR	2402-2480	0-78 [79]	3 Mbps
<p>Note 1: RF output power specifies that Maximum Peak Conducted Output Power. Note 2: Bluetooth BR uses a GFSK. Note 3: Bluetooth EDR uses a combination of $\pi/4$-DQPSK and 8DPSK.</p>				

1.1.3 Antenna Details

Ant. No.	Model	Type	Connector	Operating Frequencies (MHz) / Antenna Gain (dBi)				
				2400~2483.5	5150~5250	5250~5350	5470~5725	5725~5850
1	LSR/001-0009	Dipole	IPEX U.FL	2	2	2	2	2
2	Laird NanoBlade-IP04	PCB Dipole	IPEX U.FL	2	3.9	3.9	4	4
3	Laird MAF95310 Mini NanoBlade Flex	PCB Dipole	IPEX U.FL	2.79	3.38	3.38	3.38	3.38
4	LSR/FlexPIFA 001-0016	PIFA	IPEX U.FL	2.5	3	3	3	3
5	Ethertronics WLAN_1000146	Isolated Magnetic Dipole	IPEX U.FL	2.5	3.5	3.5	3.5	3.5

1.1.4 Power Supply Type of Equipment under Test (EUT)

Power Supply Type	DC 3.3V from host
--------------------------	-------------------

1.1.5 Accessories

N/A

1.1.6 Channel List

Frequency band (MHz)				2400~2483.5			
Channel	Frequency (MHz)	Channel	Frequency (MHz)	Channel	Frequency (MHz)	Channel	Frequency (MHz)
0	2402	20	2422	40	2442	60	2462
1	2403	21	2423	41	2443	61	2463
2	2404	22	2424	42	2444	62	2464
3	2405	23	2425	43	2445	63	2465
4	2406	24	2426	44	2446	64	2466
5	2407	25	2427	45	2447	65	2467
6	2408	26	2428	46	2448	66	2468
7	2409	27	2429	47	2449	67	2469
8	2410	28	2430	48	2450	68	2470
9	2411	29	2431	49	2451	69	2471
10	2412	30	2432	50	2452	70	2472
11	2413	31	2433	51	2453	71	2473
12	2414	32	2434	52	2454	72	2474
13	2415	33	2435	53	2455	73	2475
14	2416	34	2436	54	2456	74	2476
15	2417	35	2437	55	2457	75	2477
16	2418	36	2438	56	2458	76	2478
17	2419	37	2439	57	2459	77	2479
18	2420	38	2440	58	2460	78	2480
19	2421	39	2441	59	2461	---	---

1.1.7 Test Tool and Duty Cycle

Test tool	Dut labtool, version: 1.0.0.133
-----------	---------------------------------

1.1.8 Power Setting

Modulation Mode	Test Frequency (MHz)		
	2402	2441	2480
GFSK/1Mbps	Default	Default	Default
$\pi/4$ -DQPSK /2Mbps	Default	Default	Default
8DPSK/3Mbps	Default	Default	Default

1.2 Local Support Equipment List

Support Equipment List					
No.	Equipment	Brand	Model	FCC ID	Signal cable / Length (m)
1	Notebook	DELL	Latitude E5420	DoC	RJ45, 10m non-shielded
2	Notebook	Lenovo	T430	DoC	---
3	50 Ω terminator	---	---	---	---
4	Fixture	---	---	---	Fixture, 0.2m non-shielded

Note: No2. & No. 4 were provided by applicant.

1.3 Test Setup Chart

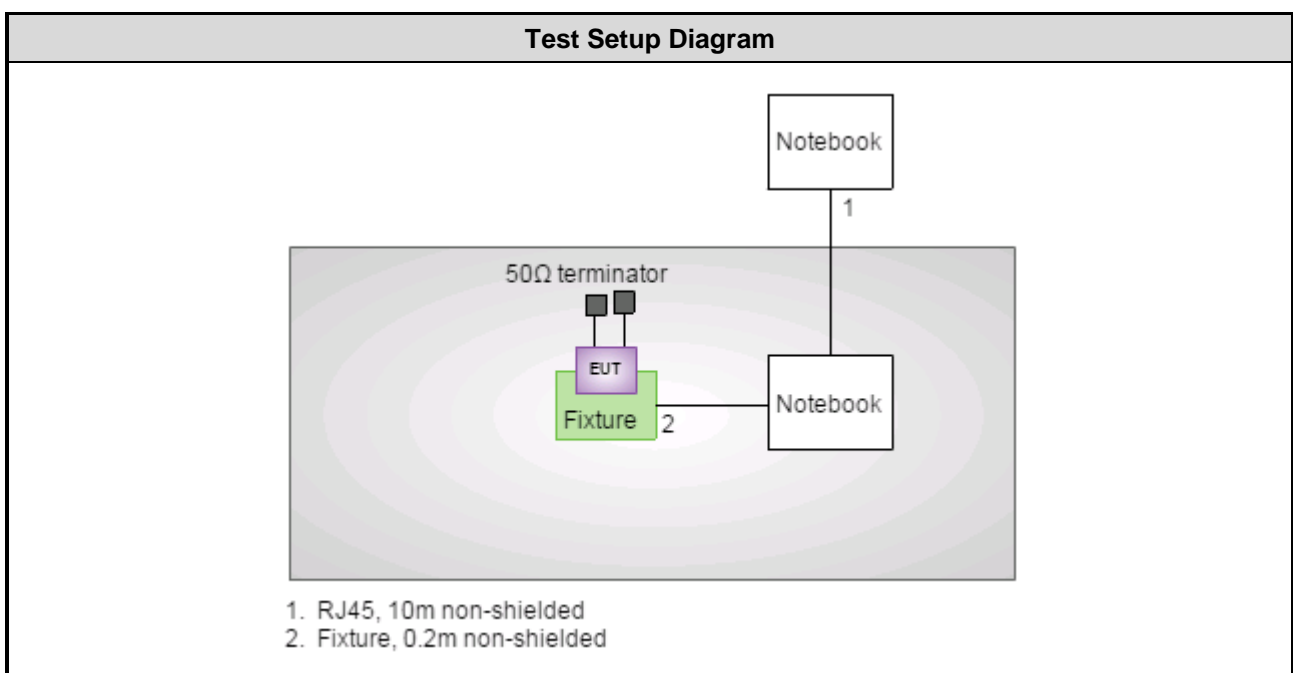

1.4 The Equipment List

Test Item	Conducted Emission				
Test Site	Conduction room 1 / (CO01-WS)				
Instrument	Manufacturer	Model No.	Serial No.	Calibration Date	Calibration Until
Receiver	R&S	ESR3	101657	Dec. 21, 2016	Dec. 20, 2017
LISN	SCHWARZBECK	Schwarzbeck 8127	8127-667	Nov. 08, 2016	Nov. 07, 2017
RF Cable-CON	EMC	EMCCFD300-BM-BM-6000	50821	Dec. 20, 2016	Dec. 19, 2017
Measurement Software	AUDIX	e3	6.120210k	NA	NA

Note: Calibration Interval of instruments listed above is one year.

Test Item	Radiated Emission				
Test Site	966 chamber 3 / (03CH03-WS)				
Instrument	Manufacturer	Model No.	Serial No.	Calibration Date	Calibration Until
Spectrum Analyzer	Agilent	N9010A	MY53400091	Sep. 09, 2016	Sep. 08, 2017
Receiver	Agilent	N9038A	MY53290044	Oct. 06, 2016	Oct. 05, 2017
Bilog Antenna	SCHWARZBECK	VULB9168	VULB9168-522	Aug. 04, 2016	Aug. 03, 2017
Horn Antenna 1G-18G	SCHWARZBECK	BBHA 9120 D	BBHA 9120 D 1206	Feb. 09, 2017	Feb. 08, 2018
Horn Antenna 18G-40G	SCHWARZBECK	BBHA 9170	BBHA 9170517	Oct. 25, 2016	Oct. 24, 2017
Loop Antenna	R&S	HFH2-Z2	100330	Nov. 10, 2016	Nov. 09, 2017
Loop Antenna Cable	KOAX KABEL	101354-BW	101354-BW	Dec. 09, 2016	Dec. 08, 2017
Preamplifier	EMC	EMC02325	980187	Sep. 08, 2016	Sep. 07, 2017
Preamplifier	Agilent	83017A	MY53270014	Aug. 22, 2016	Aug. 21, 2017
Preamplifier	EMC	EMC184045B	980192	Aug. 24, 2016	Aug. 23, 2017
RF cable-3M	HUBER+SUHNER	SUCOFLEX104	MY22620/4	Feb. 04, 2017	Feb. 03, 2018
RF cable-8M	HUBER+SUHNER	SUCOFLEX104	MY22600/4	Feb. 04, 2017	Feb. 03, 2018
RF cable-1M	HUBER+SUHNER	SUCOFLEX104	MY22624/4	Feb. 04, 2017	Feb. 03, 2018
LF cable-0.8M	EMC	EMC8D-NM-NM-800	EMC8D-NM-NM-800-001	Feb. 04, 2017	Feb. 03, 2018
LF cable-3M	EMC	EMC8D-NM-NM-3000	131103	Feb. 04, 2017	Feb. 03, 2018
LF cable-13M	EMC	EMC8D-NM-NM-13000	131104	Feb. 04, 2017	Feb. 03, 2018
Measurement Software	AUDIX	e3	6.120210g	NA	NA

Note: Calibration Interval of instruments listed above is one year.

Test Item	RF Conducted				
Test Site	(TH01-WS)				
Instrument	Manufacturer	Model No.	Serial No.	Calibration Date	Calibration Until
Spectrum Analyzer	R&S	FSV40	101063	Mar. 15, 2017	Mar. 14, 2018
Power Meter	Anritsu	ML2495A	1241002	Oct. 06, 2016	Oct. 05, 2017
Power Sensor	Anritsu	MA2411B	1207366	Oct. 06, 2016	Oct. 05, 2017
DC POWER SOURCE	GW INSTEK	GPC-6030D	EM892433	Oct. 20, 2016	Oct. 19, 2017
Measurement Software	Sporton	Sporton_1	1.3.30	NA	NA
Note: Calibration Interval of instruments listed above is one year.					

1.5 Test Standards

According to the specification of EUT, the EUT must comply with following standards and KDB documents.

47 CFR FCC Part 15.247

ANSI C63.10-2013

1.6 Measurement Uncertainty

ISO/IEC 17025 requires that an estimate of the measurement uncertainties associated with the emissions test results be included in the report. The measurement uncertainties given below are based on a 95% confidence level (based on a coverage factor ($k=2$))

Measurement Uncertainty	
Parameters	Uncertainty
Bandwidth	± 34.134 Hz
Conducted power	± 0.808 dB
Power density	± 0.463 dB
Conducted emission	± 2.670 dB
AC conducted emission	± 2.90 dB
Radiated emission ≤ 1 GHz	± 3.66 dB
Radiated emission > 1 GHz	± 5.37 dB

2 Test Configuration

2.1 Testing Condition

Test Item	Test Site	Ambient Condition	Tested By
AC Conduction	CO01-WS	20°C / 57%	Alex Tsai
Radiated Emissions	03CH03-WS	22-24°C / 66-67%	Aska Huang
RF Conducted	TH01-WS	22°C / 64%	Brad Wu

- FCC Designation No.: TW0009
- FCC site registration No.: 207696
- IC site registration No.: 10807C-1

2.2 The Worst Test Modes and Channel Details

Test item	Mode	Test Frequency (MHz)	Data Rate (Mbps)	Test Configuration
Conducted Emissions	GFSK	2402	1Mbps	---
Radiated Emissions ≤ 1GHz	GFSK	2402	1Mbps	---
Radiated Emissions > 1GHz	GFSK	2402, 2441, 2480	1Mbps	---
	8DPSK	2402, 2441, 2480	3Mbps	
Conducted Output Power	GFSK	2402, 2441, 2480	1Mbps	---
	π/4 QDPSK	2402, 2441, 2480	2Mbps	
	8DPSK	2402, 2441, 2480	3Mbps	
Number of Hopping Channels	GFSK	2402~2480	1Mbps	---
	8DPSK	2402~2480	3Mbps	
Hopping Channel Separation 20dB and Occupied bandwidth	GFSK	2402, 2441, 2480	1Mbps	---
	8DPSK	2402, 2441, 2480	3Mbps	
Dwell Time	GFSK	2402	1Mbps	---
	8DPSK	2402	3Mbps	

NOTE:

The EUT was pretested with 3 orientations placed on the table for the radiated emission measurement – X, Y, and Z-plane. The **Y-plane** results were found as the worst case and were shown in this report.

3 Transmitter Test Results

3.1 Conducted Emissions

3.1.1 Limit of Conducted Emissions

Conducted Emissions Limit		
Frequency Emission (MHz)	Quasi-Peak	Average
0.15-0.5	66 - 56 *	56 - 46 *
0.5-5	56	46
5-30	60	50

Note 1: * Decreases with the logarithm of the frequency.

3.1.2 Test Procedures

1. The device is placed on a test table, raised 80 cm above the reference ground plane. The vertical conducting plane is located 40 cm to the rear of the device.
2. The device is connected to line impedance stabilization network (LISN) and other accessories are connected to other LISN. Measured levels of AC power line conducted emission are across the 50 Ω LISN port.
3. AC conducted emission measurements is made over frequency range from 150 kHz to 30 MHz.
4. This measurement was performed with AC 120V/60Hz

3.1.3 Test Setup



- Note: 1. Support units were connected to second LISN.
 2. Both of LISNs (AMN) are 80 cm from EUT and at least 80 cm from other units and other metal planes

3.1.4 Test Result of Conducted Emissions

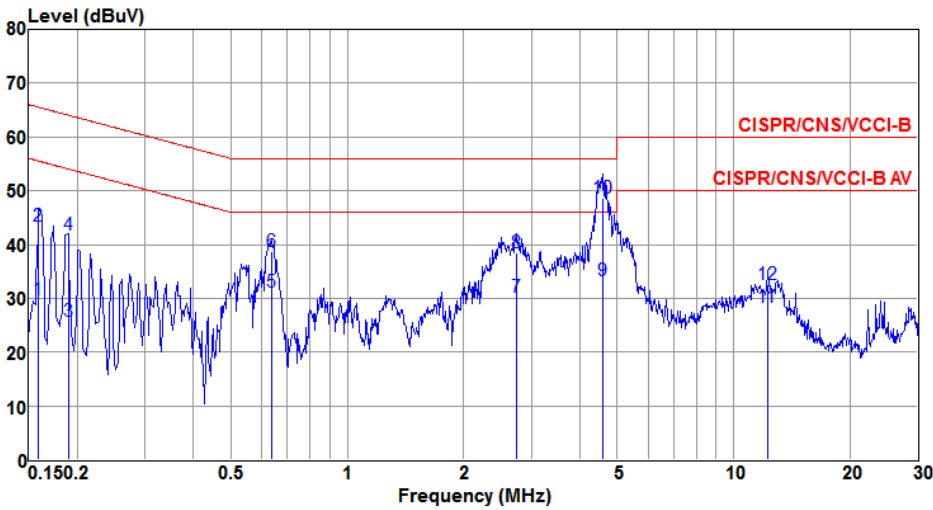
Modulation Mode	GFSK	Test Freq. (MHz)	2402																																																																																																																																							
Power Phase	Line																																																																																																																																									
																																																																																																																																										
<table border="1"> <thead> <tr> <th></th> <th>Freq</th> <th>Level</th> <th>Limit</th> <th>Over</th> <th>Read</th> <th>LISN</th> <th>cable</th> <th>Remark</th> </tr> <tr> <th></th> <th>MHz</th> <th>dBuV</th> <th>Line</th> <th>Limit</th> <th>Level</th> <th>factor</th> <th>loss</th> <th></th> </tr> <tr> <th></th> <th></th> <th></th> <th>dBuV</th> <th>dB</th> <th>dBuV</th> <th>dB</th> <th>dB</th> <th></th> </tr> </thead> <tbody> <tr><td>1</td><td>0.159</td><td>29.65</td><td>55.52</td><td>-25.87</td><td>29.53</td><td>0.08</td><td>0.04</td><td>Average</td></tr> <tr><td>2</td><td>0.159</td><td>43.53</td><td>65.52</td><td>-21.99</td><td>43.41</td><td>0.08</td><td>0.04</td><td>QP</td></tr> <tr><td>3</td><td>0.189</td><td>25.76</td><td>54.06</td><td>-28.30</td><td>25.63</td><td>0.09</td><td>0.04</td><td>Average</td></tr> <tr><td>4</td><td>0.189</td><td>41.80</td><td>64.06</td><td>-22.26</td><td>41.67</td><td>0.09</td><td>0.04</td><td>QP</td></tr> <tr><td>5</td><td>0.637</td><td>31.20</td><td>46.00</td><td>-14.80</td><td>31.09</td><td>0.07</td><td>0.04</td><td>Average</td></tr> <tr><td>6</td><td>0.637</td><td>38.81</td><td>56.00</td><td>-17.19</td><td>38.70</td><td>0.07</td><td>0.04</td><td>QP</td></tr> <tr><td>7</td><td>2.736</td><td>30.25</td><td>46.00</td><td>-15.75</td><td>30.01</td><td>0.15</td><td>0.09</td><td>Average</td></tr> <tr><td>8</td><td>2.736</td><td>38.42</td><td>56.00</td><td>-17.58</td><td>38.18</td><td>0.15</td><td>0.09</td><td>QP</td></tr> <tr><td>9</td><td>4.574</td><td>33.39</td><td>46.00</td><td>-12.61</td><td>33.05</td><td>0.17</td><td>0.17</td><td>Average</td></tr> <tr><td>10</td><td>4.574</td><td>48.73</td><td>56.00</td><td>-7.27</td><td>48.39</td><td>0.17</td><td>0.17</td><td>QP</td></tr> <tr><td>11</td><td>12.253</td><td>28.43</td><td>50.00</td><td>-21.57</td><td>27.95</td><td>0.26</td><td>0.22</td><td>Average</td></tr> <tr><td>12</td><td>12.253</td><td>32.51</td><td>60.00</td><td>-27.49</td><td>32.03</td><td>0.26</td><td>0.22</td><td>QP</td></tr> </tbody> </table>					Freq	Level	Limit	Over	Read	LISN	cable	Remark		MHz	dBuV	Line	Limit	Level	factor	loss					dBuV	dB	dBuV	dB	dB		1	0.159	29.65	55.52	-25.87	29.53	0.08	0.04	Average	2	0.159	43.53	65.52	-21.99	43.41	0.08	0.04	QP	3	0.189	25.76	54.06	-28.30	25.63	0.09	0.04	Average	4	0.189	41.80	64.06	-22.26	41.67	0.09	0.04	QP	5	0.637	31.20	46.00	-14.80	31.09	0.07	0.04	Average	6	0.637	38.81	56.00	-17.19	38.70	0.07	0.04	QP	7	2.736	30.25	46.00	-15.75	30.01	0.15	0.09	Average	8	2.736	38.42	56.00	-17.58	38.18	0.15	0.09	QP	9	4.574	33.39	46.00	-12.61	33.05	0.17	0.17	Average	10	4.574	48.73	56.00	-7.27	48.39	0.17	0.17	QP	11	12.253	28.43	50.00	-21.57	27.95	0.26	0.22	Average	12	12.253	32.51	60.00	-27.49	32.03	0.26	0.22	QP
	Freq	Level	Limit	Over	Read	LISN	cable	Remark																																																																																																																																		
	MHz	dBuV	Line	Limit	Level	factor	loss																																																																																																																																			
			dBuV	dB	dBuV	dB	dB																																																																																																																																			
1	0.159	29.65	55.52	-25.87	29.53	0.08	0.04	Average																																																																																																																																		
2	0.159	43.53	65.52	-21.99	43.41	0.08	0.04	QP																																																																																																																																		
3	0.189	25.76	54.06	-28.30	25.63	0.09	0.04	Average																																																																																																																																		
4	0.189	41.80	64.06	-22.26	41.67	0.09	0.04	QP																																																																																																																																		
5	0.637	31.20	46.00	-14.80	31.09	0.07	0.04	Average																																																																																																																																		
6	0.637	38.81	56.00	-17.19	38.70	0.07	0.04	QP																																																																																																																																		
7	2.736	30.25	46.00	-15.75	30.01	0.15	0.09	Average																																																																																																																																		
8	2.736	38.42	56.00	-17.58	38.18	0.15	0.09	QP																																																																																																																																		
9	4.574	33.39	46.00	-12.61	33.05	0.17	0.17	Average																																																																																																																																		
10	4.574	48.73	56.00	-7.27	48.39	0.17	0.17	QP																																																																																																																																		
11	12.253	28.43	50.00	-21.57	27.95	0.26	0.22	Average																																																																																																																																		
12	12.253	32.51	60.00	-27.49	32.03	0.26	0.22	QP																																																																																																																																		
<p>Note 1: Level (dBuV) = Read Level (dBuV) + LISN Factor (dB) + Cable Loss (dB). 2: Over Limit (dB) = Level (dBuV) – Limit Line (dBuV).</p>																																																																																																																																										

Modulation Mode	GFSK	Test Freq. (MHz)	2402
------------------------	------	-------------------------	------

Power Phase	Neutral
--------------------	---------

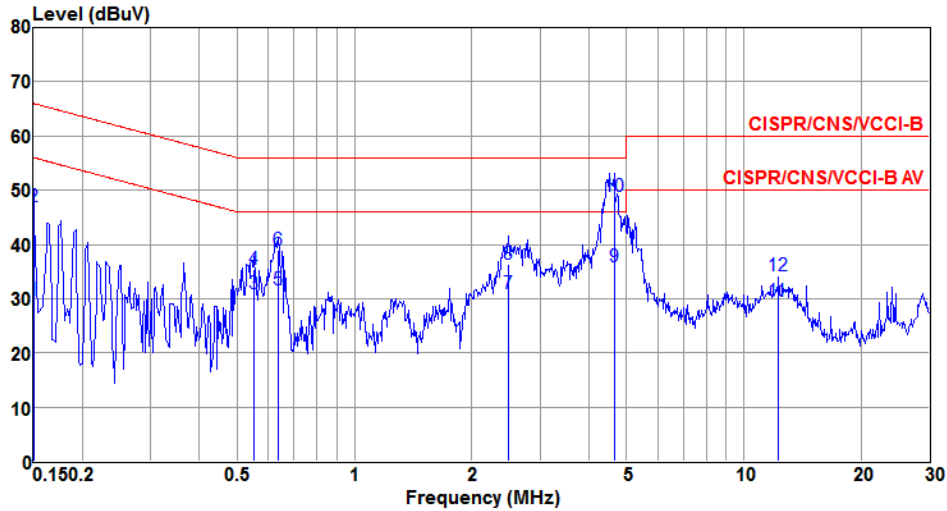

	Freq MHz	Level dBuV	Limit Line dBuV	Over Limit dB	Read Level dBuV	LISN factor dB	cable loss dB	Remark
1	0.150	29.68	56.00	-26.32	29.54	0.10	0.04	Average
2	0.150	46.94	66.00	-19.06	46.80	0.10	0.04	QP
3	0.552	30.88	46.00	-15.12	30.72	0.12	0.04	Average
4	0.552	35.33	56.00	-20.67	35.17	0.12	0.04	QP
5	0.637	31.57	46.00	-14.43	31.42	0.11	0.04	Average
6	0.637	39.05	56.00	-16.95	38.90	0.11	0.04	QP
7	2.487	30.88	46.00	-15.12	30.65	0.15	0.08	Average
8	2.487	36.44	56.00	-19.56	36.21	0.15	0.08	QP
9	4.646	35.79	46.00	-10.21	35.45	0.17	0.17	Average
10	4.646	48.88	56.00	-7.12	48.54	0.17	0.17	QP
11	12.253	29.53	50.00	-20.47	28.97	0.34	0.22	Average
12	12.253	34.32	60.00	-25.68	33.76	0.34	0.22	QP

Note 1: Level (dBuV) = Read Level (dBuV) + LISN Factor (dB) + Cable Loss (dB).
 2: Over Limit (dB) = Level (dBuV) – Limit Line (dBuV).

3.2 Unwanted Emissions into Restricted Frequency Bands

3.2.1 Limit of Unwanted Emissions into Restricted Frequency Bands

Restricted Band Emissions Limit			
Frequency Range (MHz)	Field Strength (uV/m)	Field Strength (dBuV/m)	Measure Distance (m)
0.009~0.490	2400/F(kHz)	48.5 - 13.8	300
0.490~1.705	24000/F(kHz)	33.8 - 23	30
1.705~30.0	30	29	30
30~88	100	40	3
88~216	150	43.5	3
216~960	200	46	3
Above 960	500	54	3

Note 1:
Qusai-Peak value is measured for frequency below 1GHz except for 9–90 kHz, 110–490 kHz frequency band. Peak and average value are measured for frequency above 1GHz. The limit on average radio frequency emission is as above table. The limit on peak radio frequency emissions is 20 dB above the maximum permitted average emission limit

Note 2:
Measurements may be performed at a distance other than what is specified provided. When performing measurements at a distance other than that specified, the results shall be extrapolated to the specified distance using an extrapolation factor as below, Frequency at or above 30 MHz: 20 dB/decade Frequency below 30 MHz: 40 dB/decade.

3.2.2 Test Procedures

1. Measurement is made at a semi-anechoic chamber that incorporates a turntable allowing a EUT rotation of 360°. A continuously-rotating, remotely-controlled turntable is installed at the test site to support the EUT and facilitate determination of the direction of maximum radiation for each EUT emission frequency. The EUT is placed at test table. For emissions testing at or below 1 GHz, the table height is 80 cm above the reference ground plane. For emission measurements above 1 GHz, the table height is 1.5 m
2. Measurement is made with the antenna positioned in both the horizontal and vertical planes of polarization. The measurement antenna is varied in height (1m ~ 4m) above the reference ground plane to obtain the maximum signal strength. Distance between EUT and antenna is 3 m.
3. This investigation is performed with the EUT rotated 360°, the antenna height scanned between 1 m and 4 m, and the antenna rotated to repeat the measurements for both the horizontal and vertical antenna polarizations.

Note:

1. 120kHz measurement bandwidth of test receiver and Quasi-peak detector is for radiated emission below 1GHz.
2. Radiated emission above 1GHz / Peak value
RBW=1MHz, VBW=3MHz and Peak detector
Radiated emission above 1GHz / Average value for harmonics
The average value is: Average = Peak value + 20log(Duty cycle) Where the duty factor is calculated from following formula for DH5 packet type which has worst duty factor:
3.
$$20\log (\text{Duty cycle}) = 20\log \frac{1\text{s} / 1600 * 5}{100 \text{ ms}} = -30.1\text{dB}$$
4. Radiated emission above 1GHz / Average value for other emissions
RBW=1MHz, VBW=1/T and Peak detector

3.2.3 Test Setup

Radiated Emissions below 1 GHz

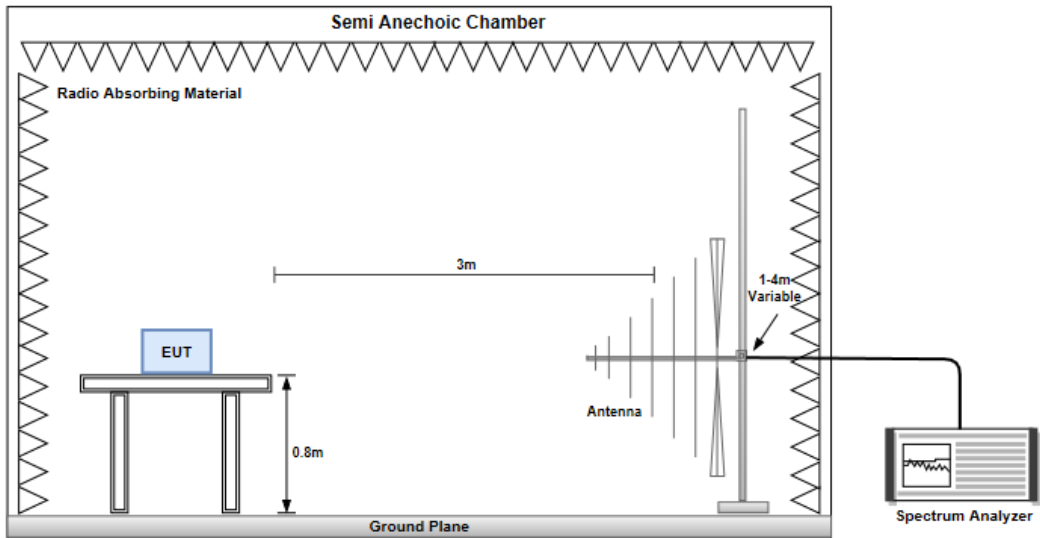

Radiated Emissions above 1 GHz

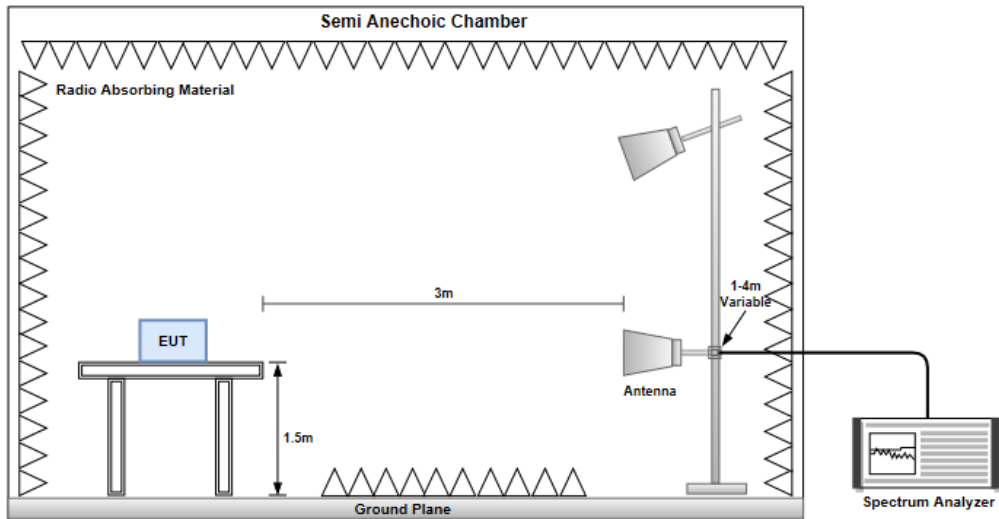

Conducted Emissions

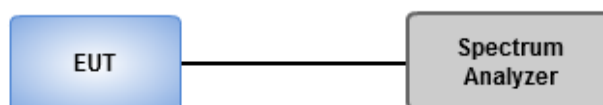

3.2.4 Transmitter Radiated Unwanted Emissions (Below 1GHz)

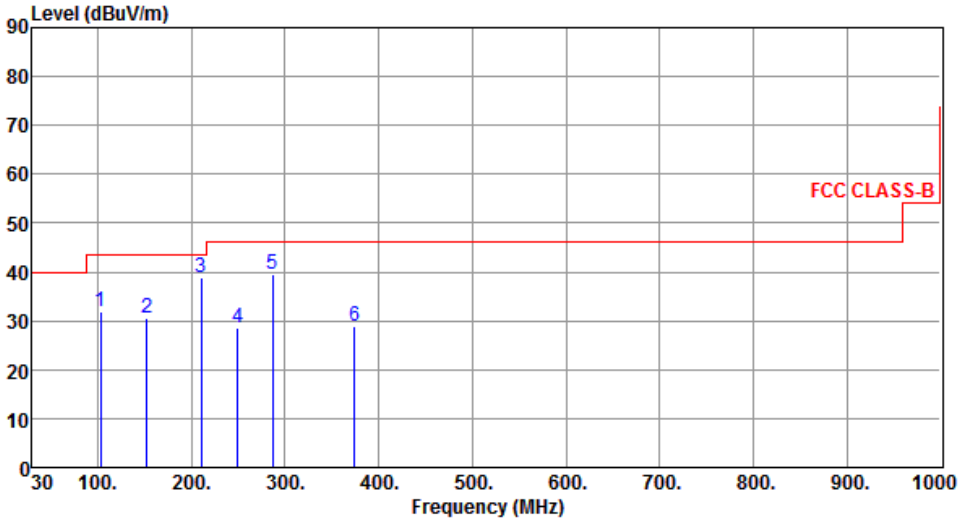
Modulation	GFSK	Test Freq. (MHz)	2441						
Polarization	Horizontal								
									
	Freq.	Emission level	Limit	Margin	SA reading	Factor	Remark	ANT High	Turn Table
	MHz	dBuV/m	dBuV/m	dB	dBuV	dB		cm	deg
1	102.75	31.89	43.50	-11.61	44.96	-13.07	Peak	---	---
2	152.22	30.64	43.50	-12.86	39.13	-8.49	Peak	---	---
3	210.42	38.70	43.50	-4.80	49.98	-11.28	Peak	---	---
4	249.22	28.55	46.00	-17.45	38.18	-9.63	Peak	---	---
5	287.05	39.55	46.00	-6.45	47.79	-8.24	Peak	---	---
6	374.35	29.00	46.00	-17.00	34.93	-5.93	Peak	---	---
<p>Note 1: Emission Level (dBuV/m) = SA Reading (dBuV/m) + Factor* (dB) *Factor includes antenna factor , cable loss and amplifier gain Note 2: Margin (dB) = Emission level (dBuV/m) – Limit (dBuV/m). Note 3: All spurious emissions below 30MHz are more than 20 dB below the limit.</p>									

Modulation	GFSK	Test Freq. (MHz)	2441
Polarization	Vertical		

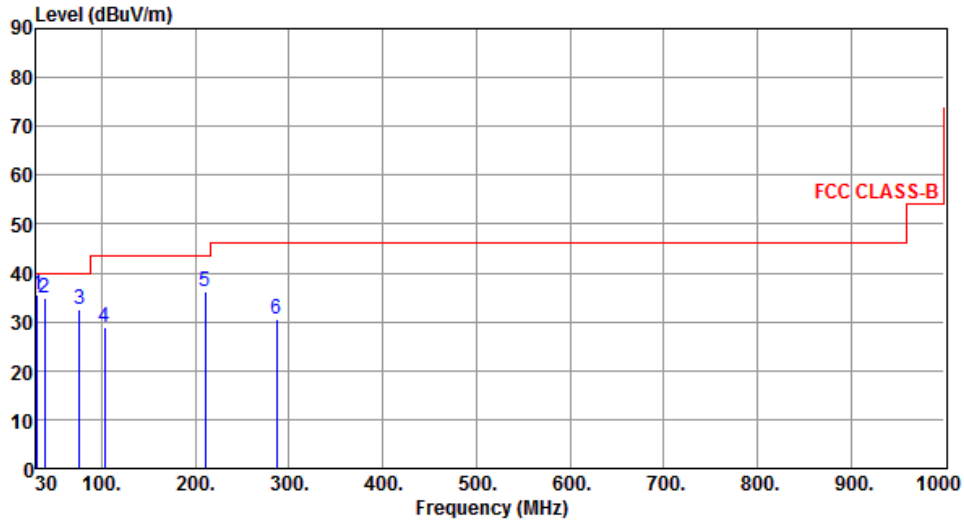

	Freq. MHz	Emission level dBuV/m	Limit dBuV/m	Margin dB	SA reading dBuV	Factor dB	Remark	ANT High cm	Turn Table deg
1	30.97	35.60	40.00	-4.40	44.94	-9.34	Peak	---	---
2	38.73	34.91	40.00	-5.09	43.76	-8.85	Peak	---	---
3	76.56	32.63	40.00	-7.37	45.07	-12.44	Peak	---	---
4	102.75	28.99	43.50	-14.51	42.06	-13.07	Peak	---	---
5	210.42	36.25	43.50	-7.25	47.53	-11.28	Peak	---	---
6	287.05	30.45	46.00	-15.55	38.69	-8.24	Peak	---	---

Note 1: Emission Level (dBuV/m) = SA Reading (dBuV/m) + Factor* (dB)

*Factor includes antenna factor , cable loss and amplifier gain

Note 2: Margin (dB) = Emission level (dBuV/m) – Limit (dBuV/m).

Note 3: All spurious emissions below 30MHz are more than 20 dB below the limit.

3.2.5 Transmitter Radiated Unwanted Emissions (Above 1GHz) for GFSK

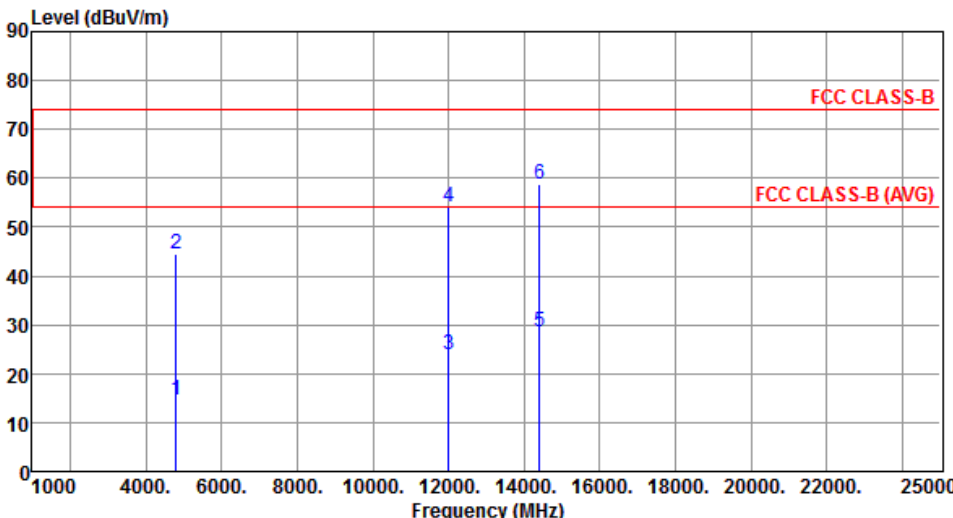
Modulation	GFSK	Test Freq. (MHz)	2402						
Polarization	Horizontal								
									
	Freq.	Emission level	Limit	Margin	SA reading	Factor	Remark	ANT High	Turn Table
	MHz	dBuV/m	dBuV/m	dB	dBuV	dB		cm	deg
1	4804.00	14.49	54.00	-39.51	10.06	4.43	Average	100	147
2	4804.00	44.59	74.00	-29.41	40.16	4.43	Peak	100	147
3	12010.00	23.89	54.00	-30.11	10.15	13.74	Average	100	151
4	12010.00	53.99	74.00	-20.01	40.25	13.74	Peak	100	151
5	14412.00	28.67	54.00	-25.33	11.40	17.27	Average	100	213
6	14412.00	58.77	74.00	-15.23	41.50	17.27	Peak	100	213

Note 1: Emission Level (dBuV/m) = SA Reading (dBuV/m) + Factor* (dB)
*Factor includes antenna factor , cable loss and amplifier gain
Note 2: Margin (dB) = Emission level (dBuV/m) – Limit (dBuV/m).

Modulation	GFSK	Test Freq. (MHz)	2402
Polarization	Vertical		

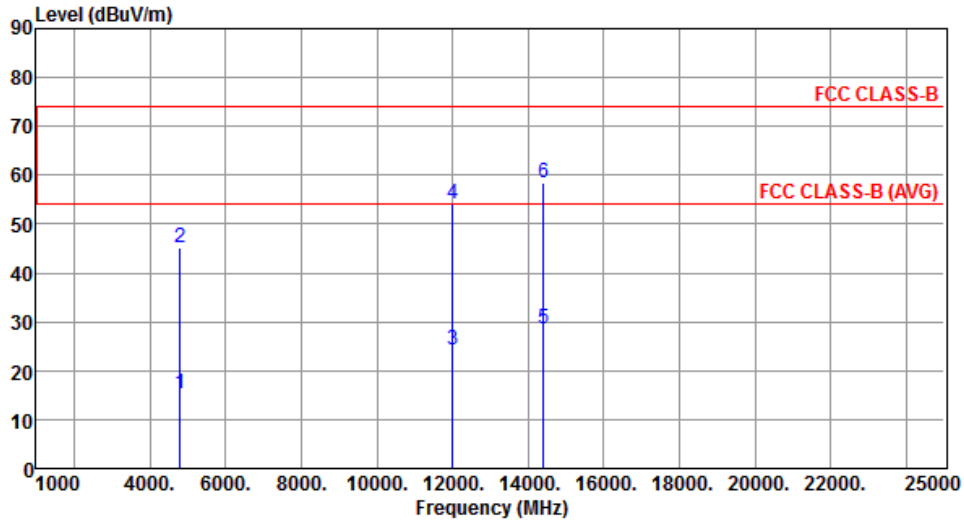

	Freq. MHz	Emission level dBuV/m	Limit dBuV/m	Margin dB	SA reading dBuV	Factor dB	Remark	ANT High cm	Turn Table deg
1	4804.00	15.16	54.00	-38.84	10.73	4.43	Average	100	147
2	4804.00	45.26	74.00	-28.74	40.83	4.43	Peak	100	147
3	12010.00	24.08	54.00	-29.92	10.34	13.74	Average	100	183
4	12010.00	54.18	74.00	-19.82	40.44	13.74	Peak	100	183
5	14412.00	28.51	54.00	-25.49	11.24	17.27	Average	100	168
6	14412.00	58.61	74.00	-15.39	41.34	17.27	Peak	100	168

Note 1: Emission Level (dBuV/m) = SA Reading (dBuV/m) + Factor* (dB)

*Factor includes antenna factor , cable loss and amplifier gain

Note 2: Margin (dB) = Emission level (dBuV/m) – Limit (dBuV/m).

Modulation	GFSK	Test Freq. (MHz)	2441
Polarization	Horizontal		

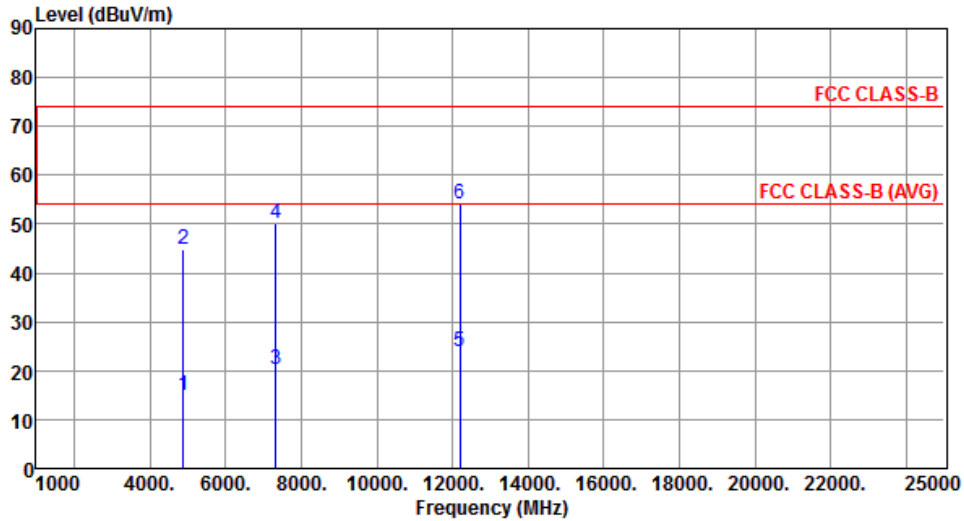

	Freq. MHz	Emission level dBuV/m	Limit dBuV/m	Margin dB	SA reading dBuV	Factor dB	Remark	ANT High cm	Turn Table deg
1	4882.00	14.84	54.00	-39.16	10.25	4.59	Average	100	155
2	4882.00	44.94	74.00	-29.06	40.35	4.59	Peak	100	155
3	7323.00	20.15	54.00	-33.85	10.97	9.18	Average	100	132
4	7323.00	50.25	74.00	-23.75	41.07	9.18	Peak	100	132
5	12205.00	24.07	54.00	-29.93	10.61	13.46	Average	100	196
6	12205.00	54.17	74.00	-19.83	40.71	13.46	Peak	100	196

Note 1: Emission Level (dBuV/m) = SA Reading (dBuV/m) + Factor* (dB)

*Factor includes antenna factor , cable loss and amplifier gain

Note 2: Margin (dB) = Emission level (dBuV/m) – Limit (dBuV/m).

Modulation	GFSK	Test Freq. (MHz)	2441
Polarization	Vertical		

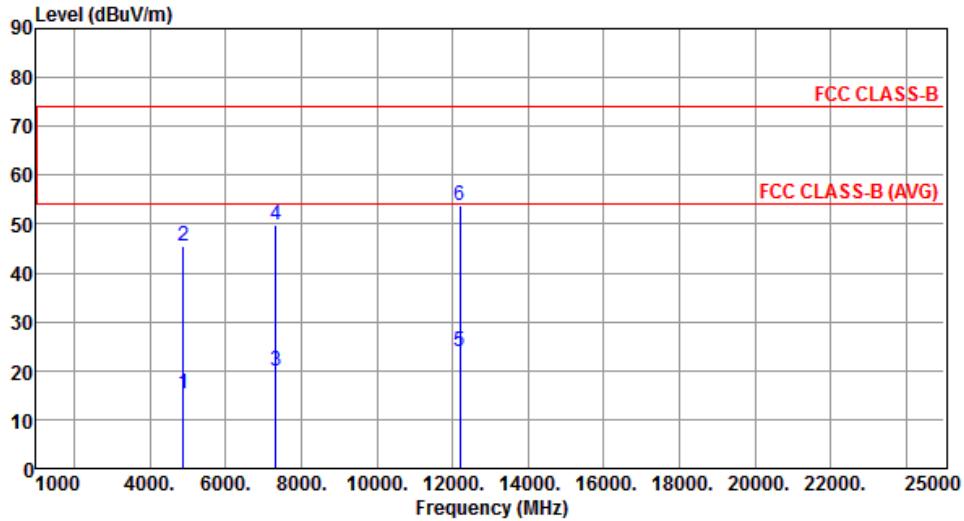

	Freq. MHz	Emission level dBuV/m	Limit dBuV/m	Margin dB	SA reading dBuV	Factor dB	Remark	ANT High cm	Turn Table deg
1	4882.00	15.24	54.00	-38.76	10.65	4.59	Average	100	191
2	4882.00	45.34	74.00	-28.66	40.75	4.59	Peak	100	191
3	7323.00	19.86	54.00	-34.14	10.68	9.18	Average	100	152
4	7323.00	49.96	74.00	-24.04	40.78	9.18	Peak	100	152
5	12205.00	23.84	54.00	-30.16	10.38	13.46	Average	100	166
6	12205.00	53.94	74.00	-20.06	40.48	13.46	Peak	100	166

Note 1: Emission Level (dBuV/m) = SA Reading (dBuV/m) + Factor* (dB)

*Factor includes antenna factor , cable loss and amplifier gain

Note 2: Margin (dB) = Emission level (dBuV/m) – Limit (dBuV/m).

Modulation	GFSK	Test Freq. (MHz)	2480
Polarization	Horizontal		

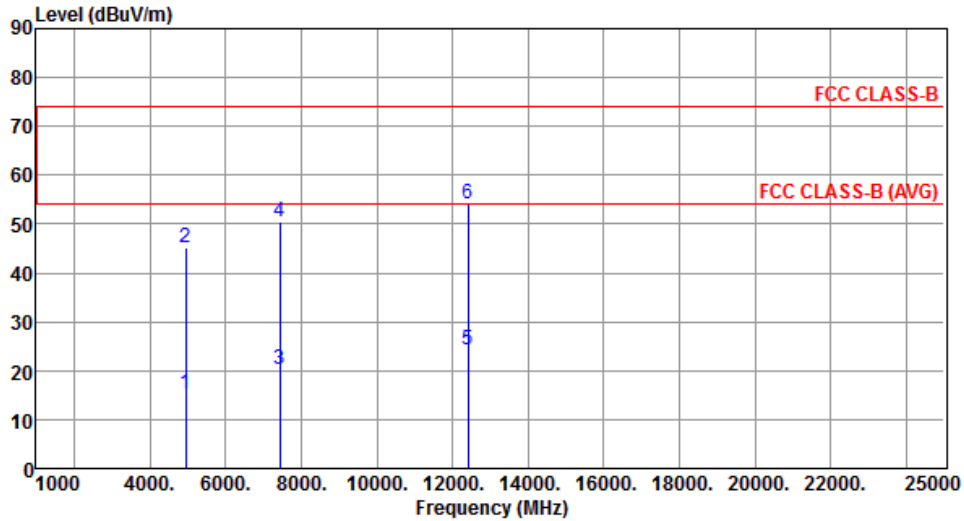

	Freq. MHz	Emission level dBuV/m	Limit dBuV/m	Margin dB	SA reading dBuV	Factor dB	Remark	ANT High cm	Turn Table deg
1	4960.00	15.17	54.00	-38.83	10.43	4.74	Average	100	151
2	4960.00	45.27	74.00	-28.73	40.53	4.74	Peak	100	151
3	7440.00	20.38	54.00	-33.62	10.88	9.50	Average	100	162
4	7440.00	50.48	74.00	-23.52	40.98	9.50	Peak	100	162
5	12400.00	24.12	54.00	-29.88	10.92	13.20	Average	100	138
6	12400.00	54.22	74.00	-19.78	41.02	13.20	Peak	100	138

Note 1: Emission Level (dBuV/m) = SA Reading (dBuV/m) + Factor* (dB)

*Factor includes antenna factor , cable loss and amplifier gain

Note 2: Margin (dB) = Emission level (dBuV/m) – Limit (dBuV/m).

Modulation	GFSK	Test Freq. (MHz)	2480
Polarization	Vertical		

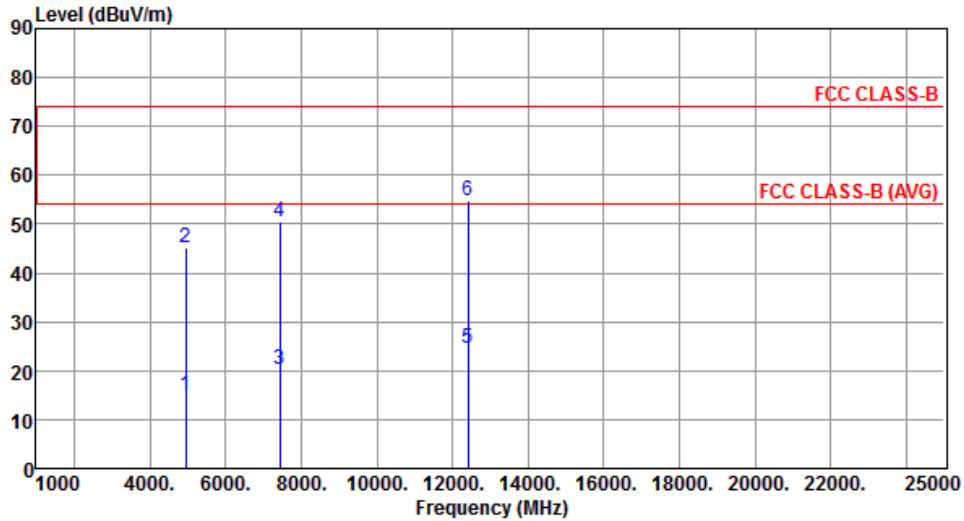

	Freq. MHz	Emission level dBuV/m	Limit dBuV/m	Margin dB	SA reading dBuV	Factor dB	Remark	ANT High cm	Turn Table deg
1	4960.00	15.05	54.00	-38.95	10.31	4.74	Average	100	145
2	4960.00	45.15	74.00	-28.85	40.41	4.74	Peak	100	145
3	7440.00	20.23	54.00	-33.77	10.73	9.50	Average	100	128
4	7440.00	50.33	74.00	-23.67	40.83	9.50	Peak	100	128
5	12400.00	24.67	54.00	-29.33	11.47	13.20	Average	100	154
6	12400.00	54.77	74.00	-19.23	41.57	13.20	Peak	100	154

Note 1: Emission Level (dBuV/m) = SA Reading (dBuV/m) + Factor* (dB)

*Factor includes antenna factor , cable loss and amplifier gain

Note 2: Margin (dB) = Emission level (dBuV/m) – Limit (dBuV/m).

3.2.6 Transmitter Radiated Unwanted Emissions (Above 1GHz) for 8DPSK

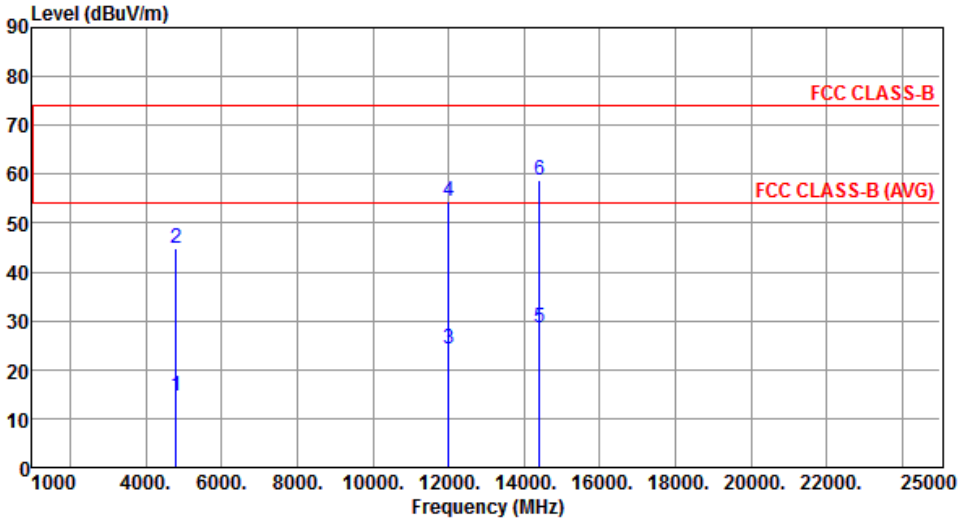
Modulation	8DPSK	Test Freq. (MHz)	2402						
Polarization	Horizontal								
									
	Freq.	Emission level	Limit	Margin	SA reading	Factor	Remark	ANT High	Turn Table
	MHz	dBuV/m	dBuV/m	dB	dBuV	dB		cm	deg
1	4804.00	14.59	54.00	-39.41	10.16	4.43	Average	100	147
2	4804.00	44.69	74.00	-29.31	40.26	4.43	Peak	100	147
3	12010.00	24.37	54.00	-29.63	10.63	13.74	Average	100	156
4	12010.00	54.47	74.00	-19.53	40.73	13.74	Peak	100	156
5	14412.00	28.54	54.00	-25.46	11.27	17.27	Average	100	213
6	14412.00	58.64	74.00	-15.36	41.37	17.27	Peak	100	210
<p>Note 1: Emission Level (dBuV/m) = SA Reading (dBuV/m) + Factor* (dB) *Factor includes antenna factor , cable loss and amplifier gain Note 2: Margin (dB) = Emission level (dBuV/m) – Limit (dBuV/m).</p>									

Modulation	8DPSK	Test Freq. (MHz)	2402
Polarization	Vertical		

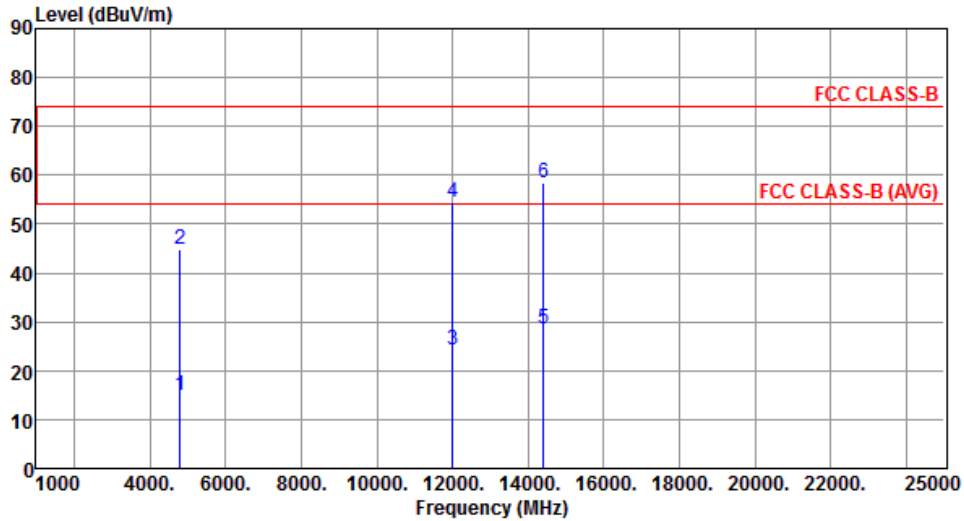

	Freq. MHz	Emission level dBuV/m	Limit dBuV/m	Margin dB	SA reading dBuV	Factor dB	Remark	ANT High cm	Turn Table deg
1	4804.00	14.85	54.00	-39.15	10.42	4.43	Average	100	142
2	4804.00	44.95	74.00	-29.05	40.52	4.43	Peak	100	142
3	12010.00	24.25	54.00	-29.75	10.51	13.74	Average	100	173
4	12010.00	54.35	74.00	-19.65	40.61	13.74	Peak	100	173
5	14412.00	28.41	54.00	-25.59	11.14	17.27	Average	100	162
6	14412.00	58.51	74.00	-15.49	41.24	17.27	Peak	100	162

Note 1: Emission Level (dBuV/m) = SA Reading (dBuV/m) + Factor* (dB)

*Factor includes antenna factor , cable loss and amplifier gain

Note 2: Margin (dB) = Emission level (dBuV/m) – Limit (dBuV/m).

Modulation	8DPSK	Test Freq. (MHz)	2441
Polarization	Horizontal		

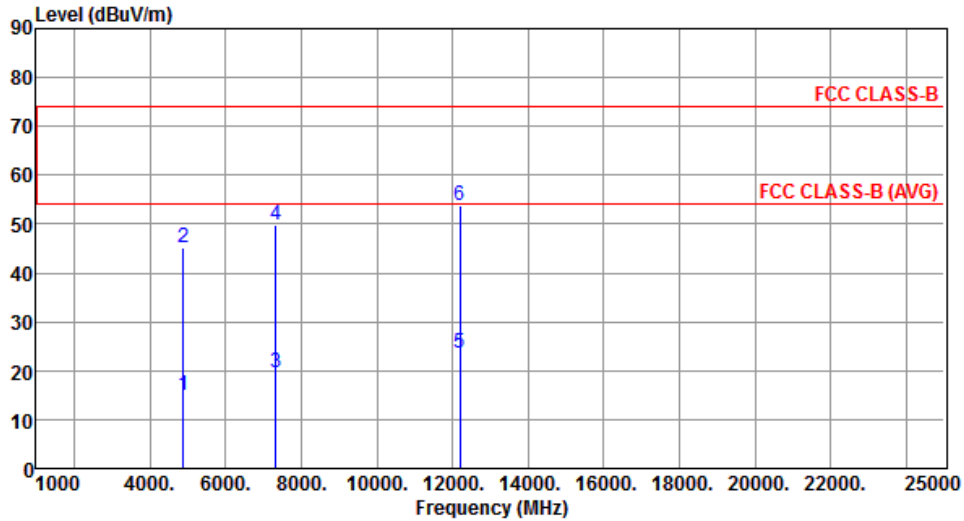

	Freq. MHz	Emission level dBuV/m	Limit dBuV/m	Margin dB	SA reading dBuV	Factor dB	Remark	ANT High cm	Turn Table deg
1	4882.00	14.97	54.00	-39.03	10.38	4.59	Average	100	155
2	4882.00	45.07	74.00	-28.93	40.48	4.59	Peak	100	152
3	7323.00	19.74	54.00	-34.26	10.56	9.18	Average	100	132
4	7323.00	49.84	74.00	-24.16	40.66	9.18	Peak	100	128
5	12205.00	23.74	54.00	-30.26	10.28	13.46	Average	100	177
6	12205.00	53.84	74.00	-20.16	40.38	13.46	Peak	100	177

Note 1: Emission Level (dBuV/m) = SA Reading (dBuV/m) + Factor* (dB)

*Factor includes antenna factor , cable loss and amplifier gain

Note 2: Margin (dB) = Emission level (dBuV/m) – Limit (dBuV/m).

Modulation	8DPSK	Test Freq. (MHz)	2441
Polarization	Vertical		

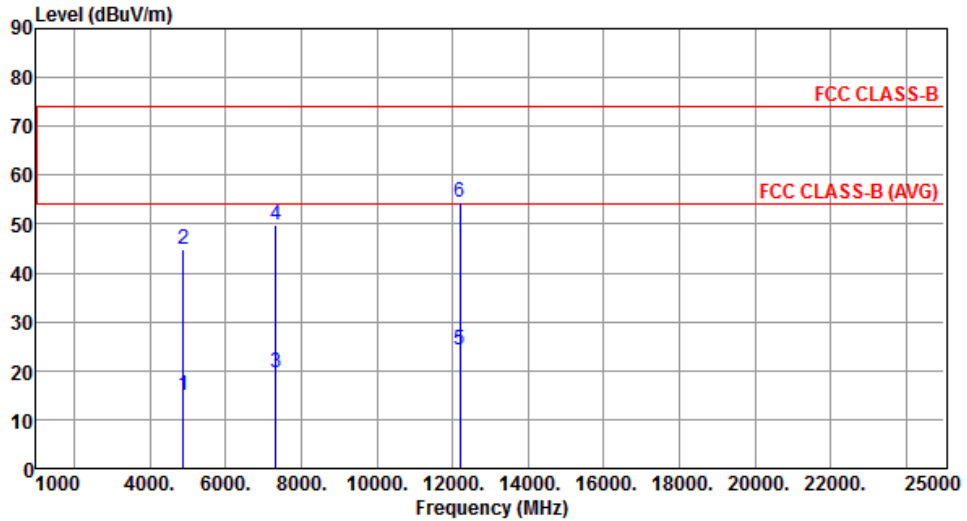

	Freq. MHz	Emission level dBuV/m	Limit dBuV/m	Margin dB	SA reading dBuV	Factor dB	Remark	ANT High cm	Turn Table deg
1	4882.00	14.86	54.00	-39.14	10.27	4.59	Average	100	188
2	4882.00	44.96	74.00	-29.04	40.37	4.59	Peak	100	188
3	7323.00	19.75	54.00	-34.25	10.57	9.18	Average	100	148
4	7323.00	49.85	74.00	-24.15	40.67	9.18	Peak	100	148
5	12205.00	24.20	54.00	-29.80	10.74	13.46	Average	100	156
6	12205.00	54.30	74.00	-19.70	40.84	13.46	Peak	100	156

Note 1: Emission Level (dBuV/m) = SA Reading (dBuV/m) + Factor* (dB)

*Factor includes antenna factor , cable loss and amplifier gain

Note 2: Margin (dB) = Emission level (dBuV/m) – Limit (dBuV/m).

Modulation	8DPSK	Test Freq. (MHz)	2480
Polarization	Horizontal		

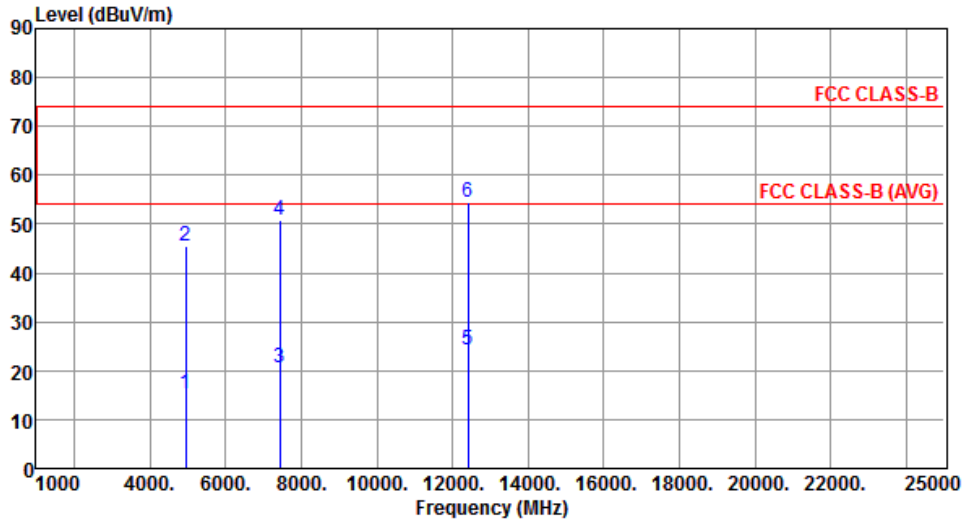

	Freq. MHz	Emission level dBuV/m	Limit dBuV/m	Margin dB	SA reading dBuV	Factor dB	Remark	ANT High cm	Turn Table deg
1	4960.00	15.36	54.00	-38.64	10.62	4.74	Average	100	162
2	4960.00	45.46	74.00	-28.54	40.72	4.74	Peak	100	162
3	7440.00	20.71	54.00	-33.29	11.21	9.50	Average	100	157
4	7440.00	50.81	74.00	-23.19	41.31	9.50	Peak	100	157
5	12400.00	24.39	54.00	-29.61	11.19	13.20	Average	100	125
6	12400.00	54.49	74.00	-19.51	41.29	13.20	Peak	100	125

Note 1: Emission Level (dBuV/m) = SA Reading (dBuV/m) + Factor* (dB)

*Factor includes antenna factor , cable loss and amplifier gain

Note 2: Margin (dB) = Emission level (dBuV/m) – Limit (dBuV/m).

Modulation	8DPSK	Test Freq. (MHz)	2480
Polarization	Vertical		

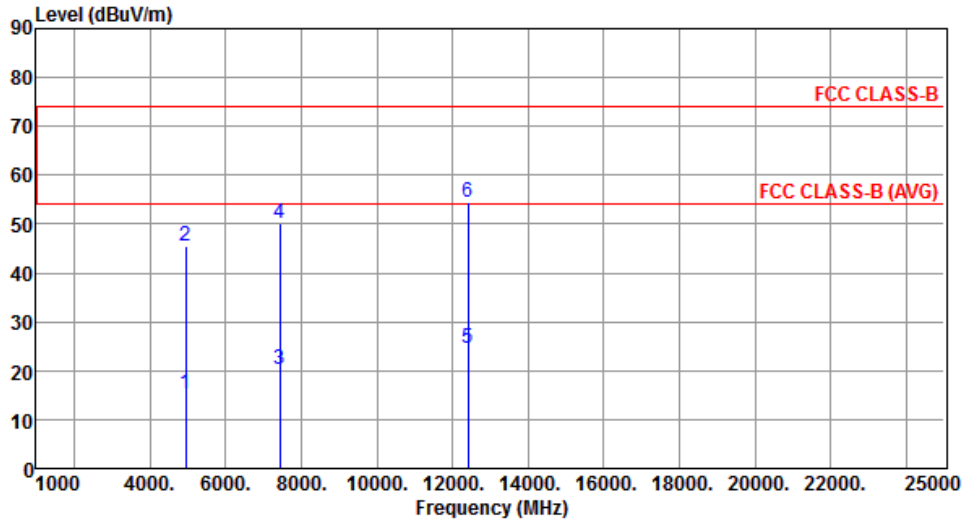

	Freq. MHz	Emission level dBuV/m	Limit dBuV/m	Margin dB	SA reading dBuV	Factor dB	Remark	ANT High cm	Turn Table deg
1	4960.00	15.32	54.00	-38.68	10.58	4.74	Average	100	152
2	4960.00	45.42	74.00	-28.58	40.68	4.74	Peak	100	152
3	7440.00	20.16	54.00	-33.84	10.66	9.50	Average	100	127
4	7440.00	50.26	74.00	-23.74	40.76	9.50	Peak	100	127
5	12400.00	24.45	54.00	-29.55	11.25	13.20	Average	100	151
6	12400.00	54.55	74.00	-19.45	41.35	13.20	Peak	100	151

Note 1: Emission Level (dBuV/m) = SA Reading (dBuV/m) + Factor* (dB)

*Factor includes antenna factor , cable loss and amplifier gain

Note 2: Margin (dB) = Emission level (dBuV/m) – Limit (dBuV/m).

3.2.7 Transmitter Conducted Unwanted Emissions (Below 1 GHz)

Modulation Mode		GFSK		Frequency	2402MHz	
Range (MHz)	Max Value chain0 (dBm)	DG (dBi)	GRF (dB)	EIRP (dBm)	Min E-Field Limit (dBm)	E-Field Margin (dB)
30~1000MHz	-78.49	2.79	4.70	-71.00	-55.20	-15.80

Note:

1. GRF = Ground Reflection Factor.
2. DG = Directional Gain.
3. Worst case of emission limit below 1GHz is selected to be limit.

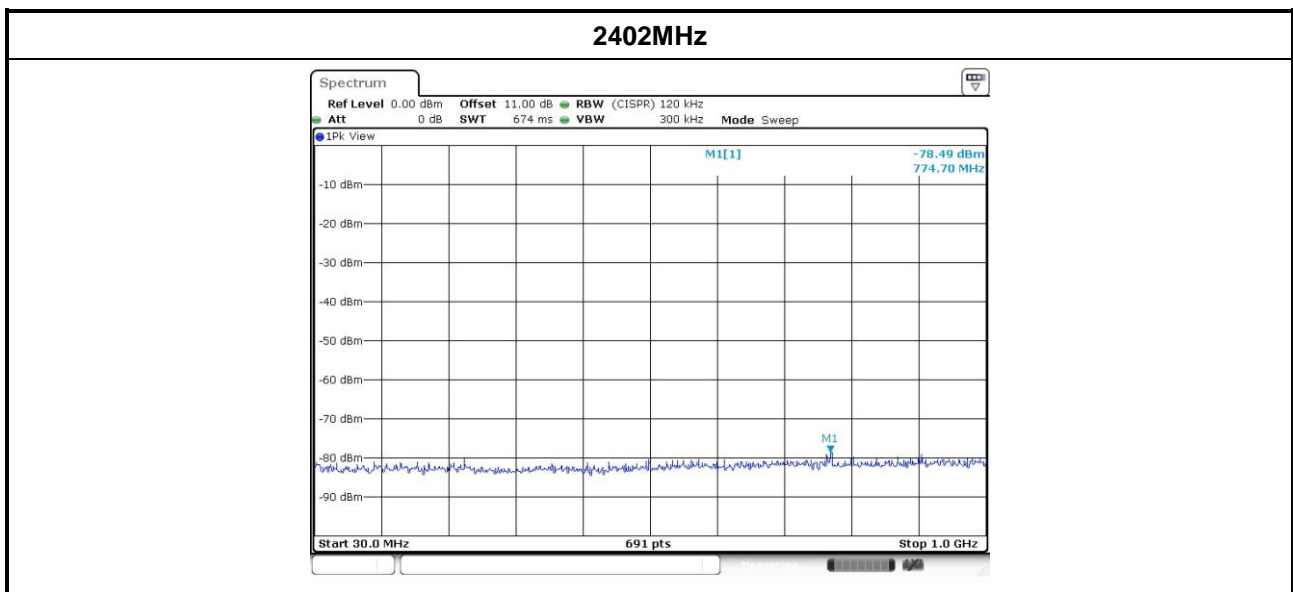

3.2.8 Transmitter Conducted Unwanted Emissions (Above 1GHz)

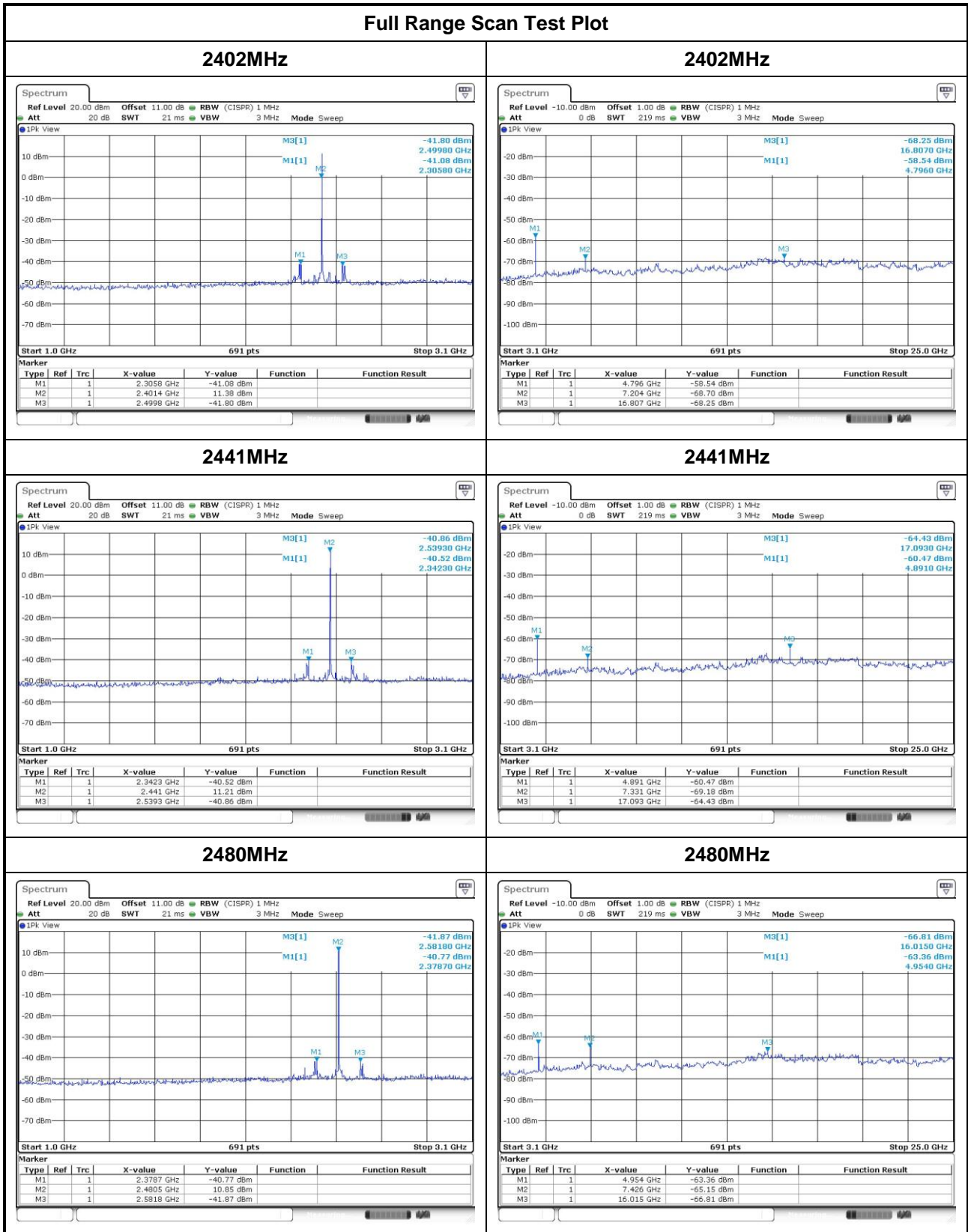

GFSK

Transmitter Conducted Unwanted Emissions Results in Band Edge							
Test ch. Freq. (MHz)	Range (MHz)	Max Value chain0 (dBm)	DG (dBi)	EIRP (dBm)	E-Field Limit (dBm)	E-Field Margin (dB)	Remark
2402	2310~2390	-45.41	2.79	-42.62	-21.20	-21.42	PK
	2310~2390	-56.43	2.79	-53.64	-41.20	-12.44	AV
	2483.5~2500	-41.12	2.79	-38.33	-21.20	-17.13	PK
	2483.5~2500	-52.79	2.79	-50.00	-41.20	-8.80	AV
2441	2310~2390	-40.63	2.79	-37.84	-21.20	-16.64	PK
	2310~2390	-51.69	2.79	-48.90	-41.20	-7.70	AV
	2483.5~2500	-47.58	2.79	-44.79	-21.20	-23.59	PK
	2483.5~2500	-58.76	2.79	-55.97	-41.20	-14.77	AV
2480	2310~2390	-40.50	2.79	-37.71	-21.20	-16.51	PK
	2310~2390	-51.60	2.79	-48.81	-41.20	-7.61	AV
	2483.5~2500	-40.21	2.79	-37.42	-21.20	-16.22	PK
	2483.5~2500	-55.23	2.79	-52.44	-41.20	-11.24	AV

8DPSK

Transmitter Conducted Unwanted Emissions Results in Band Edge							
Test ch. Freq. (MHz)	Range (MHz)	Max Value chain0 (dBm)	DG (dBi)	EIRP (dBm)	E-Field Limit (dBm)	E-Field Margin (dB)	Remark
2402	2310~2390	-47.03	2.79	-44.24	-21.20	-23.04	PK
	2310~2390	-58.85	2.79	-56.06	-41.20	-14.86	AV
	2483.5~2500	-45.07	2.79	-42.28	-21.20	-21.08	PK
	2483.5~2500	-58.58	2.79	-55.79	-41.20	-14.59	AV
2440	2310~2390	-45.55	2.79	-42.76	-21.20	-21.56	PK
	2310~2390	-57.99	2.79	-55.20	-41.20	-14.00	AV
	2483.5~2500	-47.97	2.79	-45.18	-21.20	-23.98	PK
	2483.5~2500	-59.49	2.79	-56.70	-41.20	-15.50	AV
2480	2310~2390	-44.11	2.79	-41.32	-21.20	-20.12	PK
	2310~2390	-58.22	2.79	-55.43	-41.20	-14.23	AV
	2483.5~2500	-40.07	2.79	-37.28	-21.20	-16.08	PK
	2483.5~2500	-56.06	2.79	-53.27	-41.20	-12.07	AV

GFSK

Band Edge Test Plot

2402MHz - AV

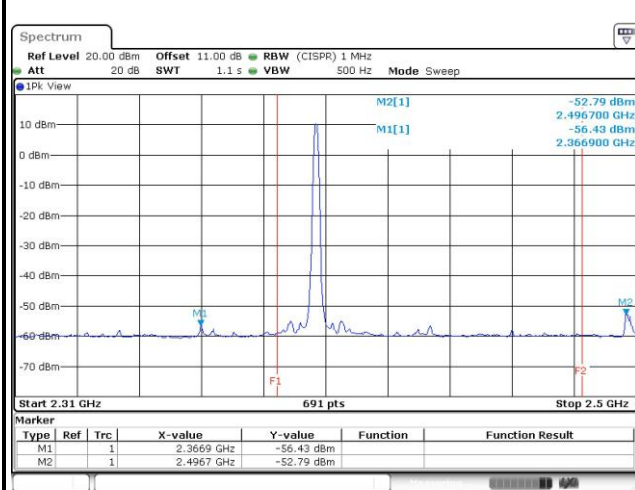

2402MHz - PK

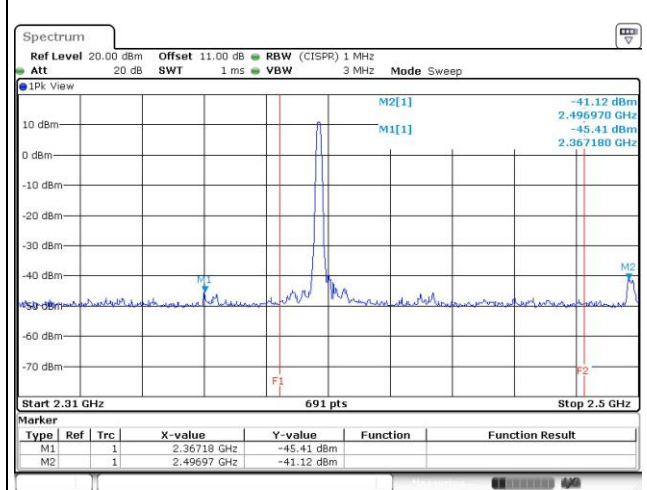

2441MHz - AV

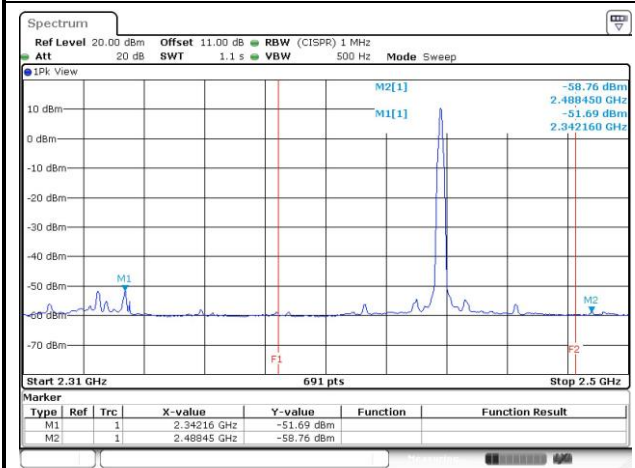

2441MHz - PK

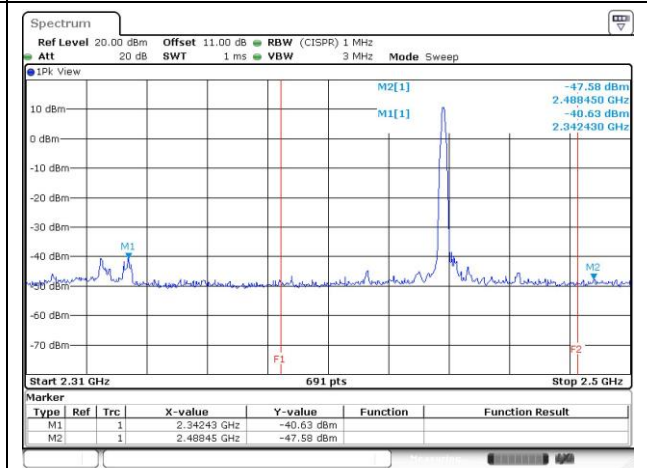

2480MHz - AV

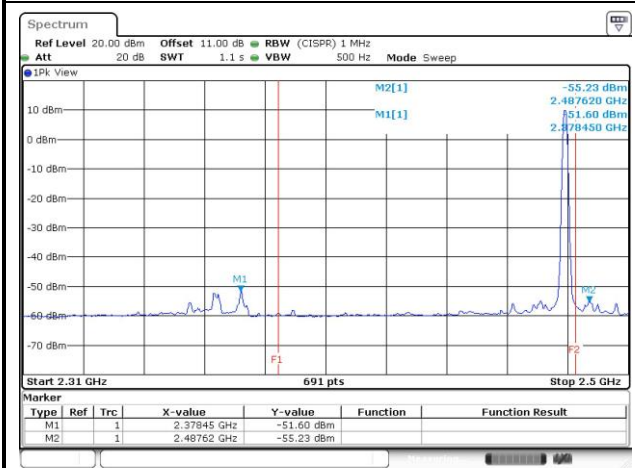

2480MHz - PK

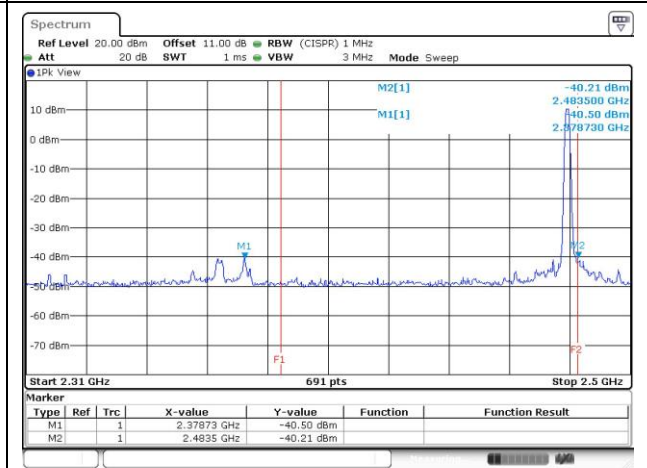

8DPSK

Band Edge Test Plot

2402MHz - AV

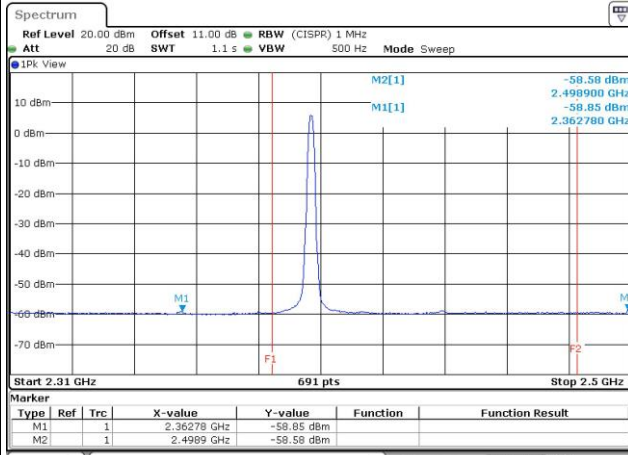

2402MHz - PK

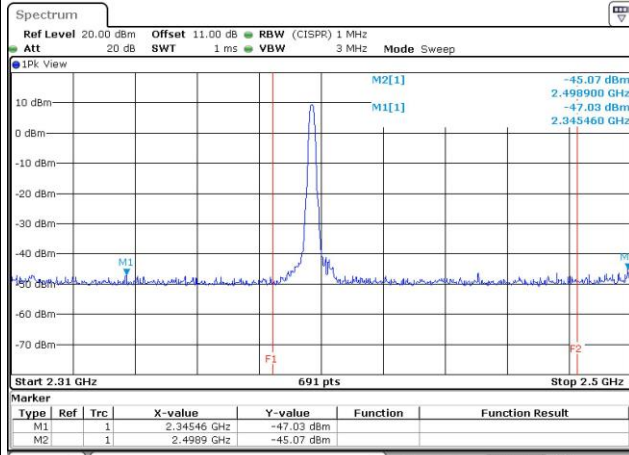

2441MHz - AV

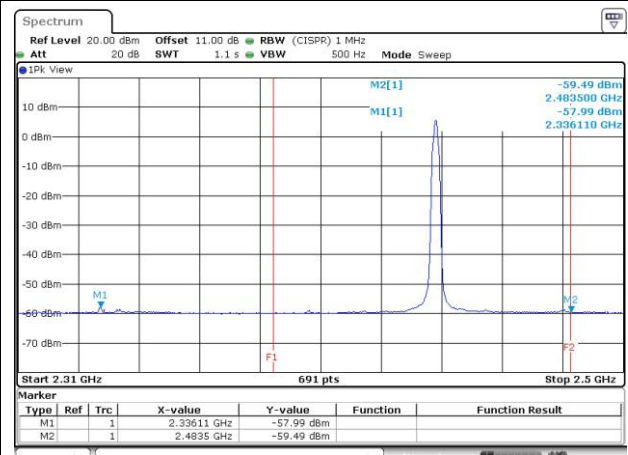

2441MHz - PK

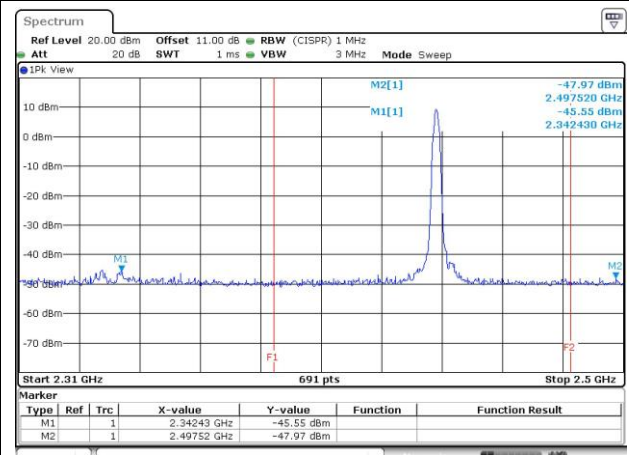

2480MHz - AV

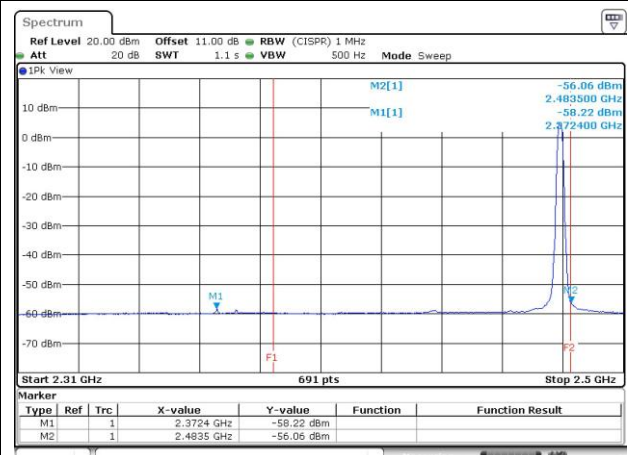

2480MHz - PK

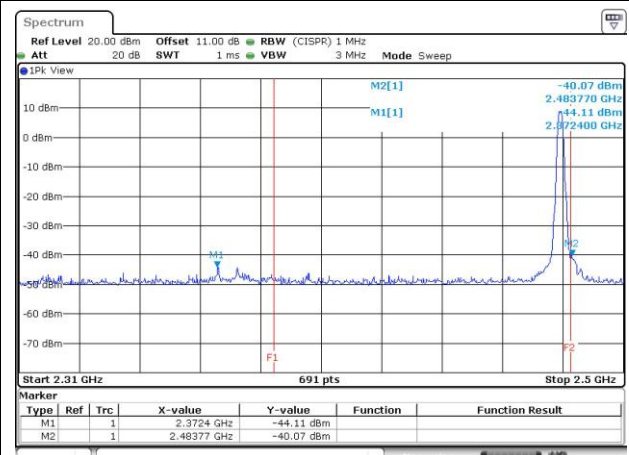

Transmitter Conducted Unwanted Emissions Results in Restricted Frequency Band						
Modulation Mode		GFSK		Frequency	2402MHz	
Freq. (MHz)	Remark	Max Value chain0 (dBm)	DG (dBi)	EIRP (dBm)	E-Field Limit (dBm)	E-Field Margin (dB)
4804.00	PK	-58.05	2.79	-55.26	-21.20	-34.06
4804.00	AV ^{note1}	-	-	-	-41.20	-

Transmitter Conducted Unwanted Emissions Results in Restricted Frequency Band						
Modulation Mode		GFSK		Frequency	2441MHz	
Freq. (MHz)	Remark	Max Value chain0 (dBm)	DG (dBi)	EIRP (dBm)	E-Field Limit (dBm)	E-Field Margin (dB)
4882.00	PK	-59.65	2.79	-56.86	-21.20	-35.66
4882.00	AV ^{note1}	-	-	-	-41.20	-
7323.00	PK	-66.82	2.79	-64.03	-21.20	-42.83
7323.00	AV ^{note1}	-	-	-	-41.20	-

Transmitter Conducted Unwanted Emissions Results in Restricted Frequency Band						
Modulation Mode		GFSK		Frequency	2480MHz	
Freq. (MHz)	Remark	Max Value chain0 (dBm)	DG (dBi)	EIRP (dBm)	E-Field Limit (dBm)	E-Field Margin (dB)
4960.00	PK	-62.71	2.79	-59.92	-21.20	-38.72
4960.00	AV ^{note1}	-	-	-	-41.20	-
7440.00	PK	-64.75	2.79	-61.96	-21.20	-40.76
7440.00	AV ^{note1}	-	-	-	-41.20	-
16006.00	PK	-66.61	2.79	-63.82	-21.20	-42.62
16006.00	AV ^{note1}	-	-	-	-41.20	-

Transmitter Conducted Unwanted Emissions Results in Restricted Frequency Band						
Modulation Mode		8DPSK		Frequency	2402MHz	
Freq. (MHz)	Remark	Max Value chain0 (dBm)	DG (dBi)	EIRP (dBm)	E-Field Limit (dBm)	E-Field Margin (dB)
4804.00	PK	-59.71	2.79	-56.92	-21.20	-35.72
4804.00	AV ^{note1}	-	-	-	-41.20	-
15587.35	PK	-66.71	2.79	-63.92	-21.20	-42.72
15587.35	AV ^{note1}	-	-	-	-41.20	-

Transmitter Conducted Unwanted Emissions Results in Restricted Frequency Band						
Modulation Mode		8DPSK		Frequency	2441MHz	
Freq. (MHz)	Remark	Max Value chain0 (dBm)	DG (dBi)	EIRP (dBm)	E-Field Limit (dBm)	E-Field Margin (dB)
4882.00	PK	-61.23	2.79	-58.44	-21.20	-37.24
4882.00	AV ^{note1}	-	-	-	-41.20	-
7323.00	PK	-68.51	2.79	-65.72	-21.20	-44.52
7323.00	AV ^{note1}	-	-	-	-41.20	-

Transmitter Conducted Unwanted Emissions Results in Restricted Frequency Band						
Modulation Mode		8DPSK		Frequency	2480MHz	
Freq. (MHz)	Remark	Max Value chain0 (dBm)	DG (dBi)	EIRP (dBm)	E-Field Limit (dBm)	E-Field Margin (dB)
4960.00	PK	-63.63	2.79	-60.84	-21.20	-39.64
4960.00	AV ^{note1}	-	-	-	-41.20	-
7440.00	PK	-66.45	2.79	-63.66	-21.20	-42.46
7440.00	AV ^{note1}	-	-	-	-41.20	-
15579.00	PK	-66.52	2.79	-63.73	-21.20	-42.53
15579.00	AV ^{note1}	-	-	-	-41.20	-

Note:

1. If the PK margin greater than 20 dB, there is no need to get AVG reading.
2. DG = Directional Gain.

GFSK

Test Plots

4804 MHz - PK

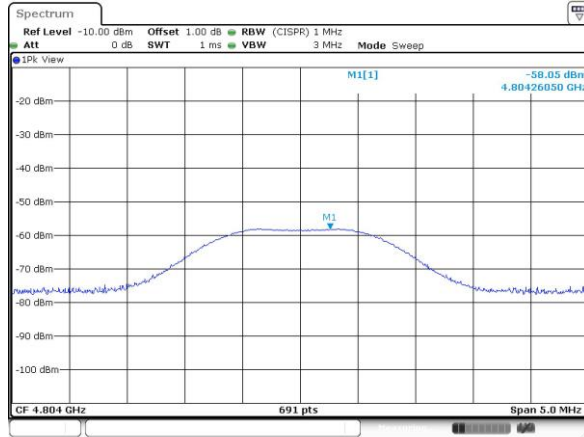

4882 MHz - PK

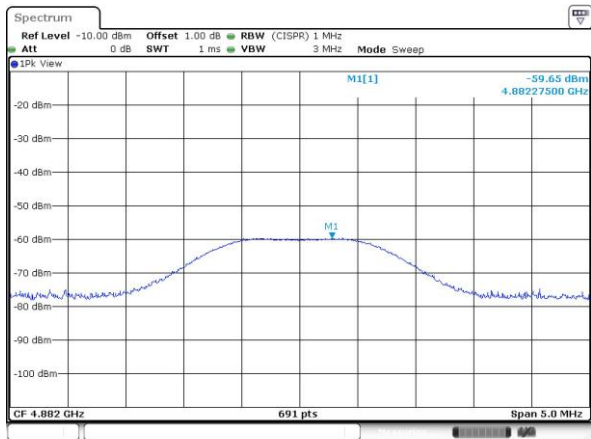

7323 MHz - PK

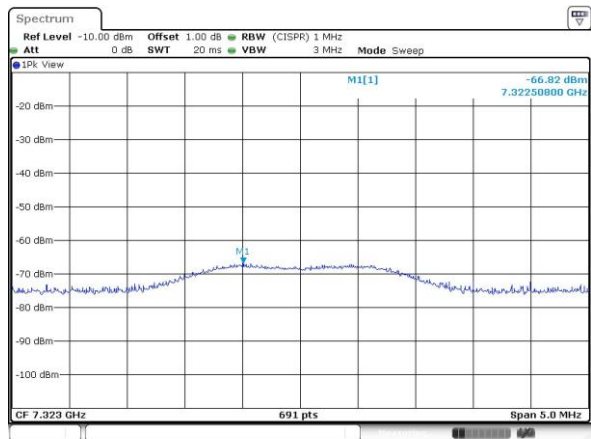

GFSK

Test Plots

4960 MHz - PK

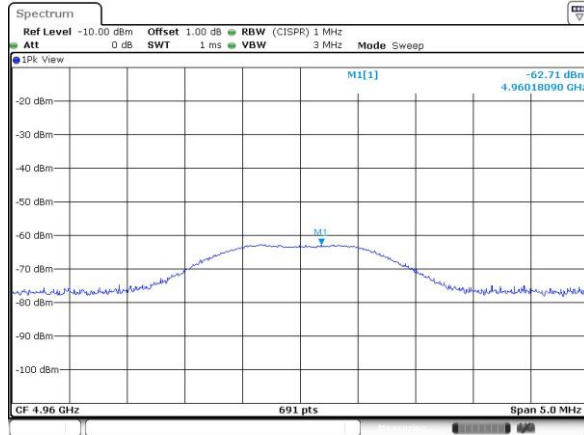

7440 MHz - PK

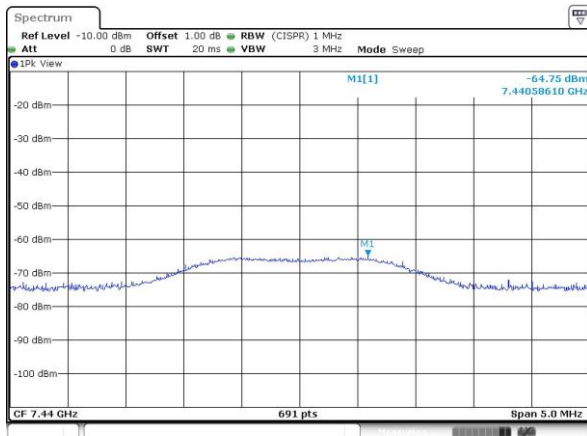

16015 MHz - PK

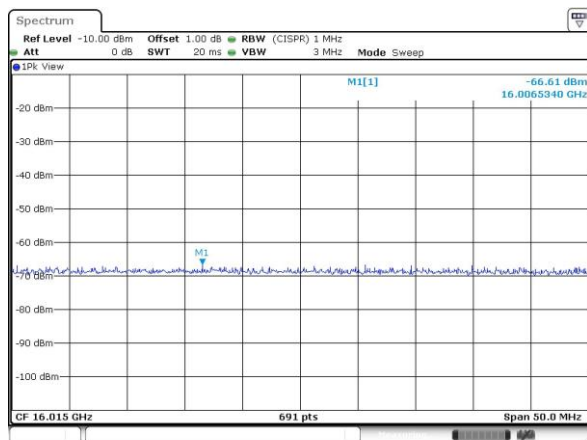

8DPSK

Test Plots

4804 MHz - PK

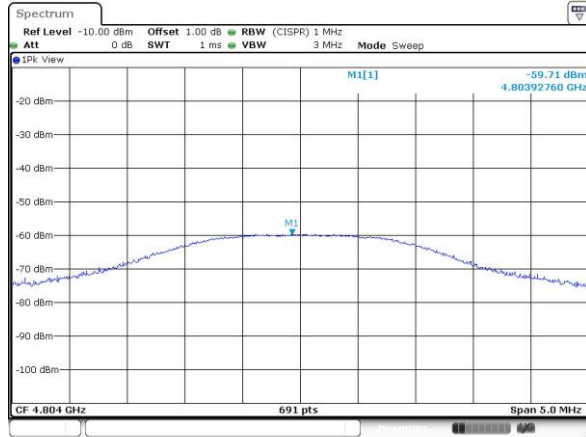

15587 MHz - PK

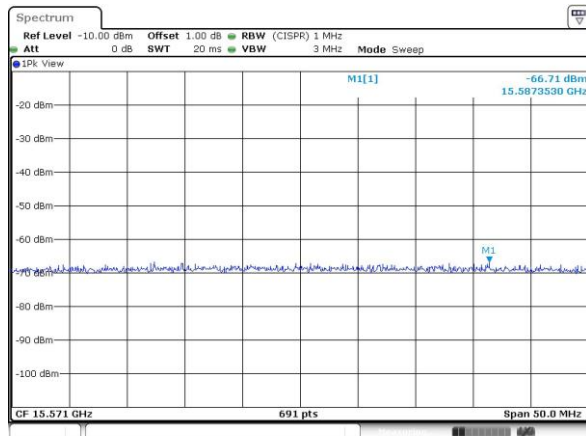

4882 MHz - PK

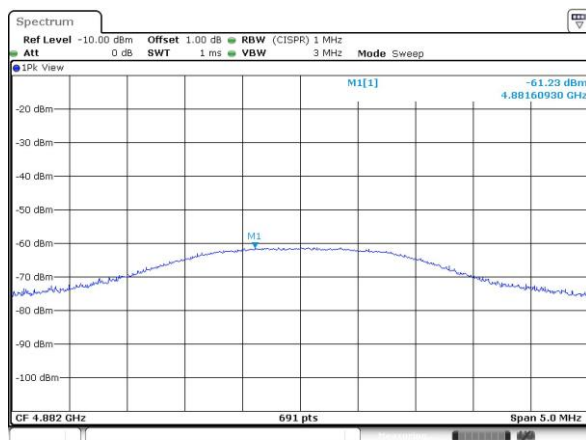

8DPSK

Test Plots

7323 MHz - PK

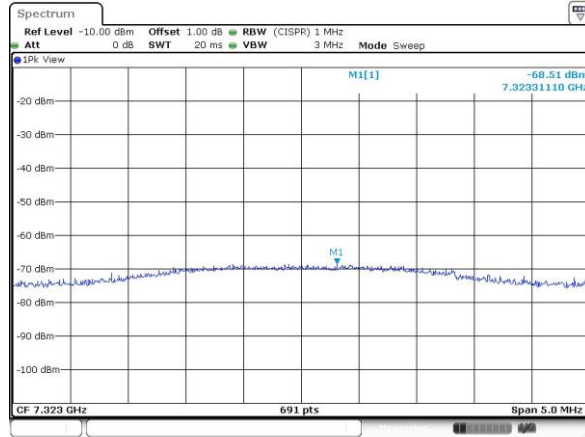

4960 MHz - PK

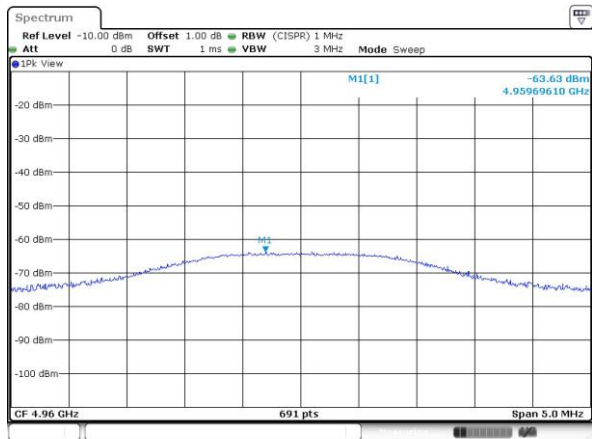

7440 MHz - PK

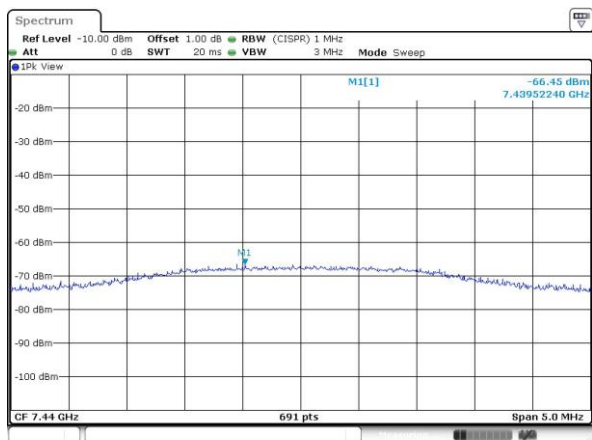

8DPSK

Test Plot

15579 MHz - PK

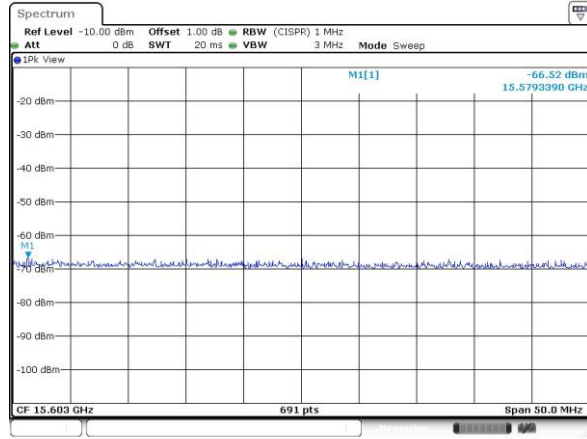

3.3 Unwanted Emissions into Non-Restricted Frequency Bands

3.3.1 Limit of Unwanted Emissions into Non-Restricted Frequency Bands

The peak output power measured in any 100 kHz bandwidth outside of the authorized frequency band shall be attenuated by at least 20 dB relative to the maximum in-band peak PSD level in 100 kHz.

3.3.2 Test Procedures

Reference Level Measurement

1. Set the RBW = 100 kHz, VBW = 300 kHz, Detector = peak.
2. Set Sweep time = auto couple, Trace mode = max hold.
3. Allow trace to fully stabilize.
4. Use the peak marker function to determine the maximum amplitude level.

Unwanted Emissions Level Measurement

1. Set RBW = 100 kHz, VBW = 300 kHz, Detector = peak.
2. Trace Mode = max hold, Sweep = auto couple.
3. Allow the trace to stabilize.
4. Use peak marker function to determine maximum amplitude of all unwanted emissions within any 100 kHz bandwidth.

3.3.3 Test Setup

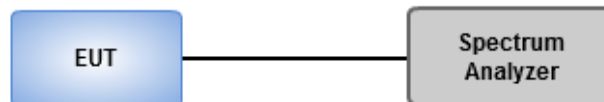

3.3.4 Unwanted Emissions into Non-Restricted Frequency Bands

GFSK

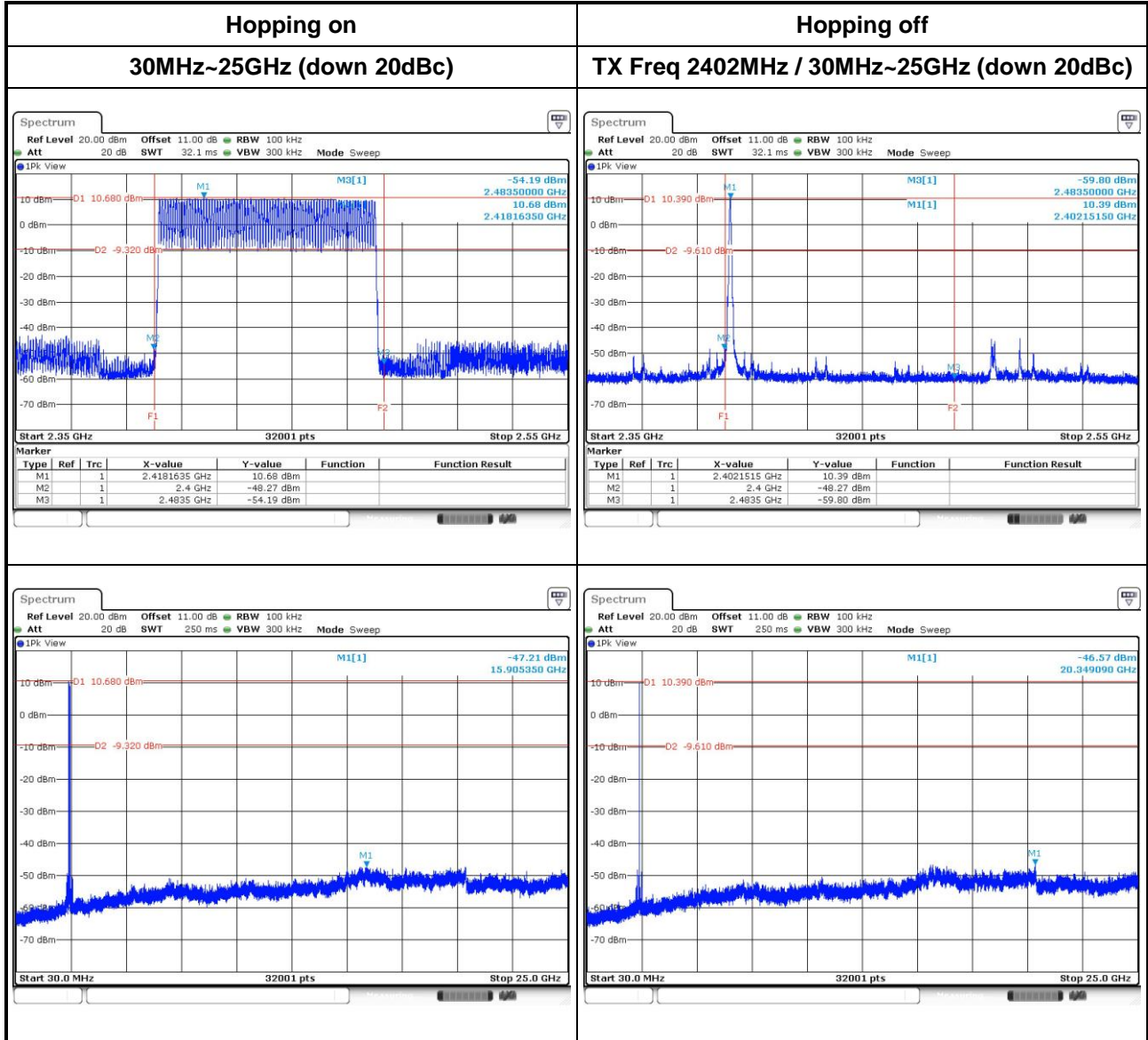

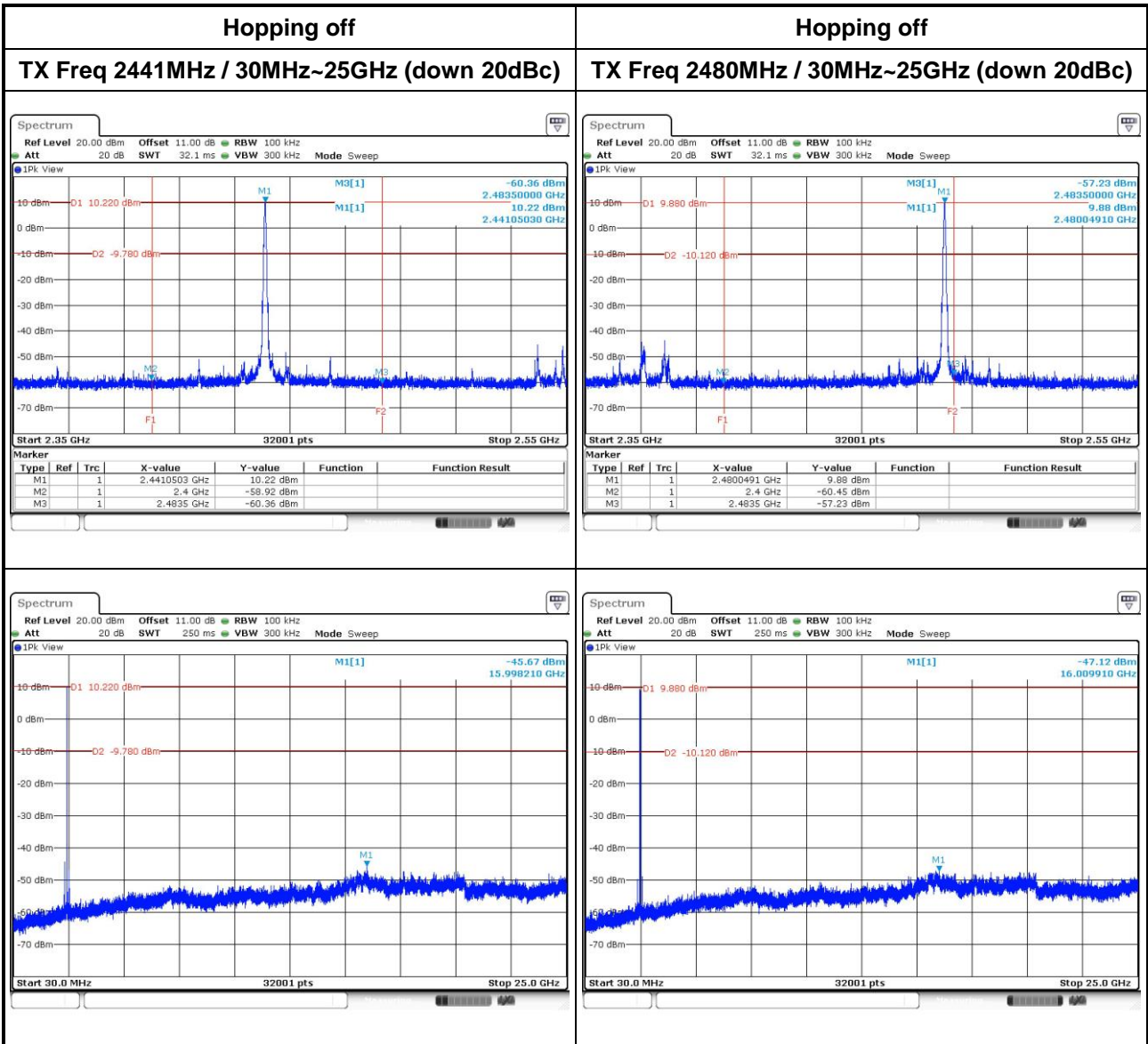

8DPSK

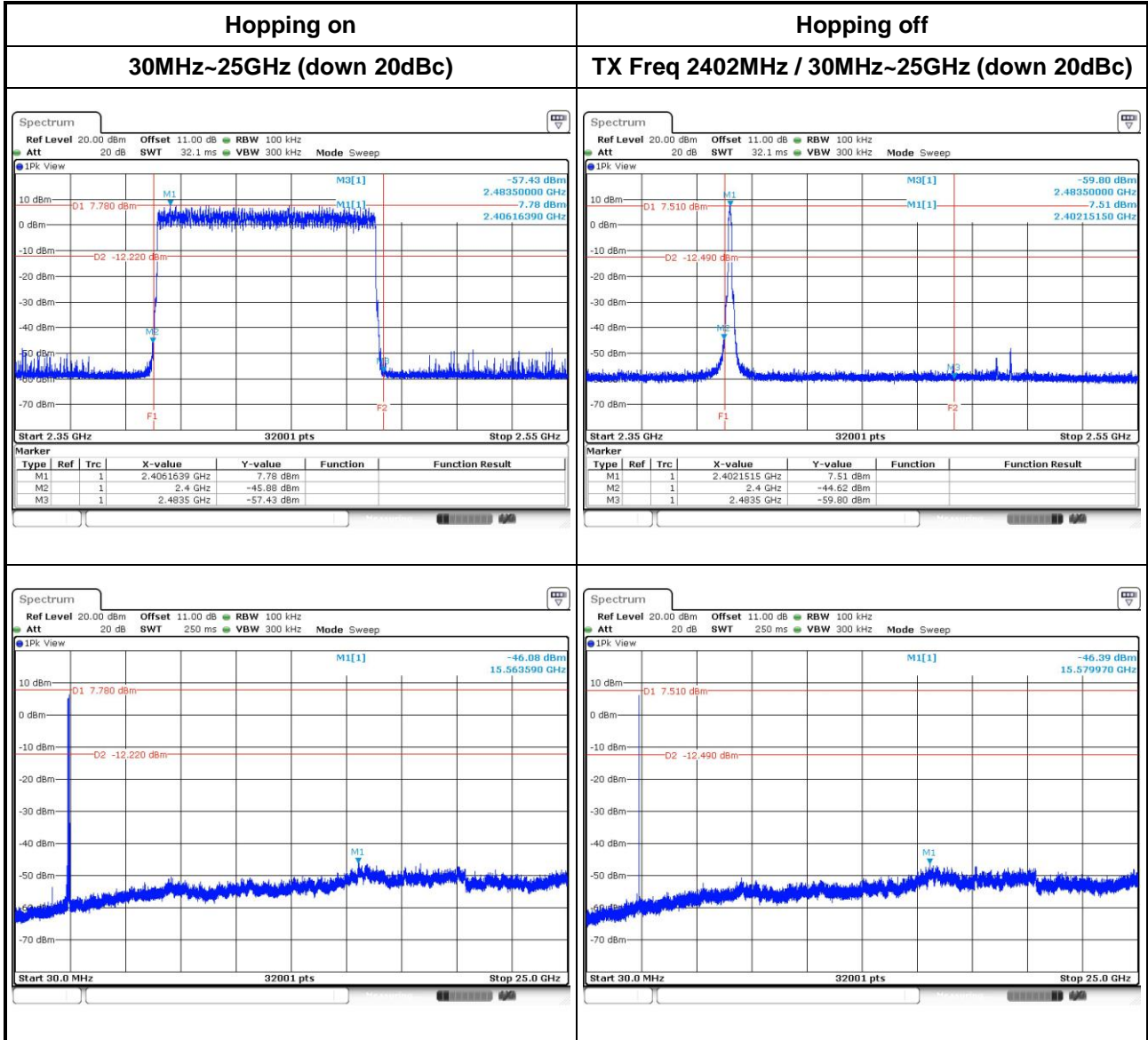

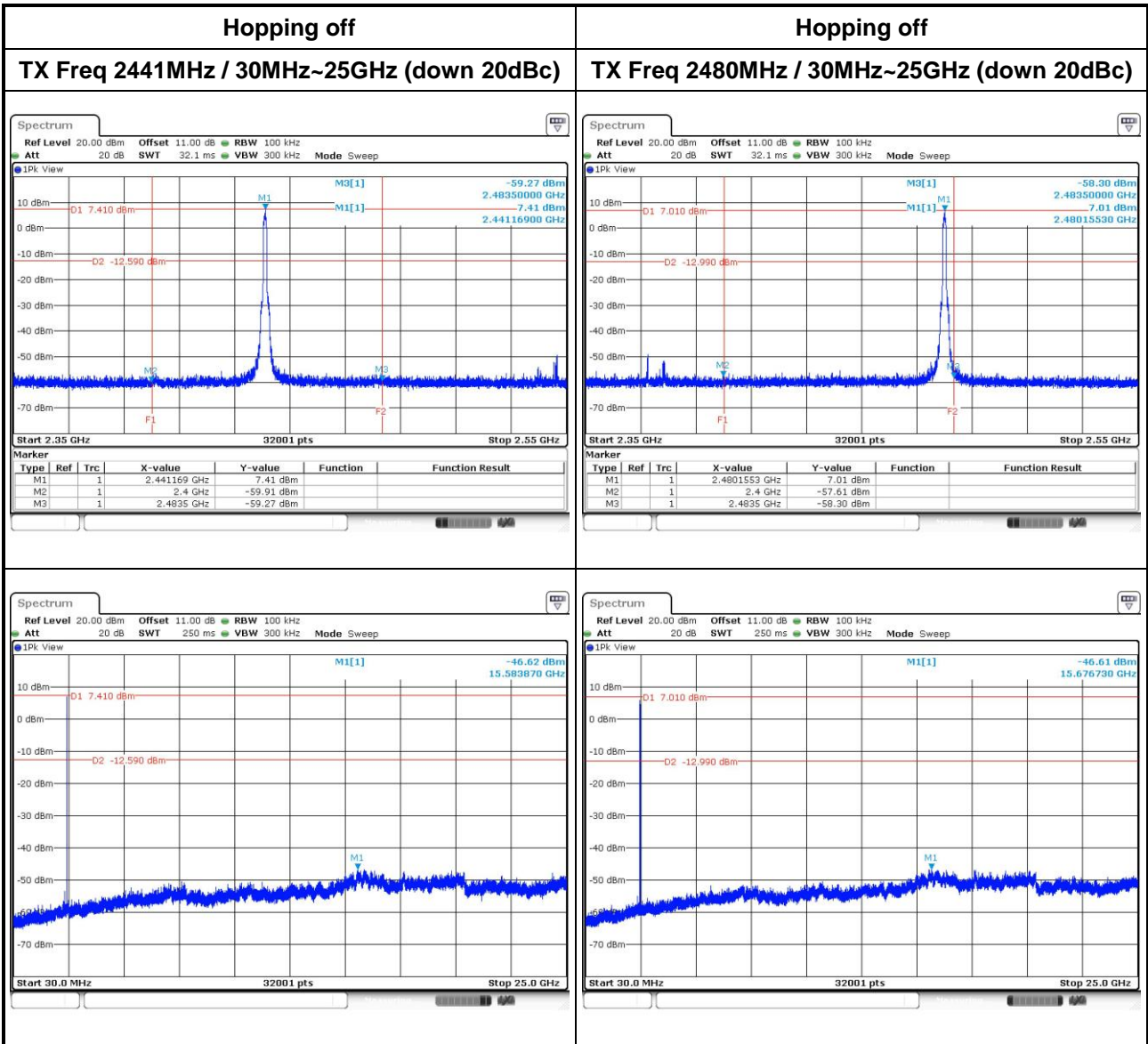

3.4 Conducted Output Power

3.4.1 Limit of Conducted Output Power

- 1 Watt
For frequency hopping systems operating in the 2400–2483.5 MHz band employing at least 75 non overlapping hopping channels, and all frequency hopping systems in the 5725–5850 MHz band.
- 0.125 Watt
For all other frequency hopping systems in the 2400–2483.5 MHz band.
- 0.125 Watt
For Frequency hopping systems operating in the 2400–2483.5 MHz band have hopping channel carrier frequencies that are separated by two-thirds of the 20 dB bandwidth of the hopping channel.

3.4.2 Test Procedures

1. A wideband power meter is used for power measurement. Bandwidth of power sensor and meter is 50MHz
2. If duty cycle of test signal is not 100 %, trigger and gating function of power meter will be enabled to capture transmission burst for measuring output power

3.4.3 Test Setup

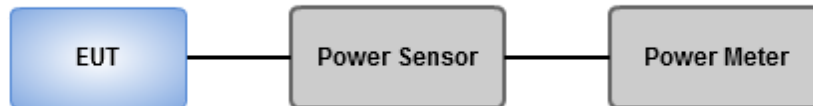

3.4.4 Test Result of Conducted Output Power

Modulation Mode	Freq. (MHz)	Output Power (mW)	Output Power (dBm)	Limit (mW)
GFSK	2402	12.11	10.83	125
GFSK	2441	11.48	10.60	125
GFSK	2480	10.35	10.15	125
π/4 DQPSK	2402	10.35	10.15	125
π/4 DQPSK	2441	9.35	9.71	125
π/4 DQPSK	2480	8.36	9.22	125
8DPSK	2402	11.09	10.45	125
8DPSK	2441	9.93	9.97	125
8DPSK	2480	8.95	9.52	125

Modulation Mode	Freq. (MHz)	AV Output Power (mW)	AV Output Power (dBm)
GFSK	2402	11.99	10.79
GFSK	2441	11.35	10.55
GFSK	2480	10.26	10.11
π/4 DQPSK	2402	5.96	7.75
π/4 DQPSK	2441	5.35	7.28
π/4 DQPSK	2480	4.76	6.78
8DPSK	2402	5.92	7.72
8DPSK	2441	5.31	7.25
8DPSK	2480	4.74	6.76

Note: Average power is for reference only.

3.5 Number of Hopping Frequency

3.5.1 Limit of Number of Hopping Frequency

Frequency hopping systems in the 2400–2483.5 MHz band shall use at least 15 channels.

3.5.2 Test Procedures

1. Set RBW = 100kHz, VBW = 300kHz, Sweep time = Auto, Detector = Peak Trace max hold.
2. Allow trace to stabilize.

3.5.3 Test Setup

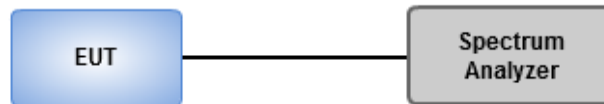

3.5.4 Test Result of Number of Hopping Frequency

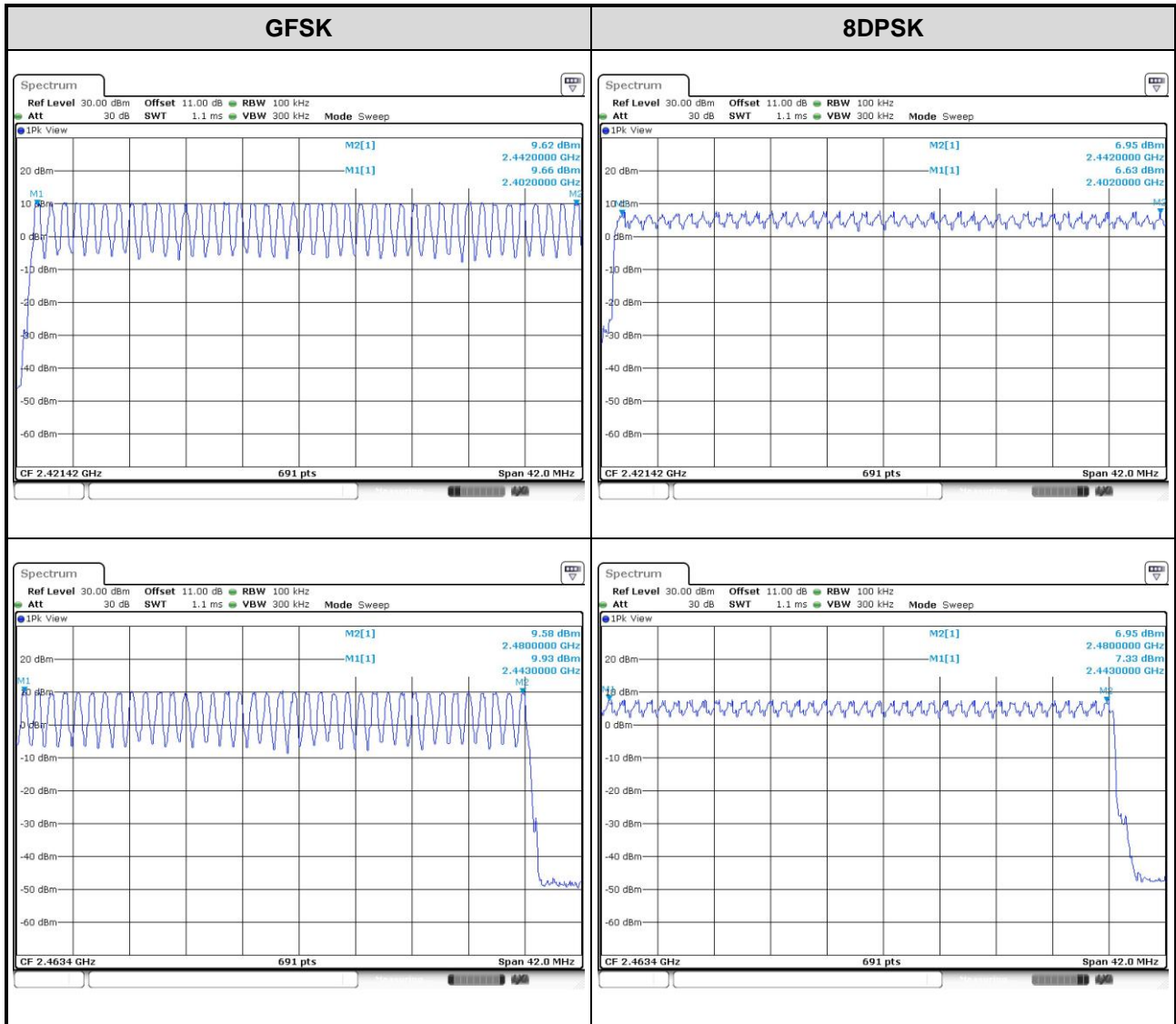

3.6 20dB and Occupied Bandwidth

3.6.1 Test Procedures

20dB Bandwidth

1. Set RBW=30kHz, VBW=100kHz, Sweep time = Auto, Detector=Peak, Trace max hold
2. Allow trace to stabilize
3. Measure the maximum width of the emission that is constrained by the frequencies associated with the two outermost amplitude points (upper and lower) that are attenuated by 20 dB relative to the maximum level measured in the fundamental emission.

Occupied Bandwidth

1. Set RBW=30kHz, VBW=100kHz, Sweep time = Auto, Detector=Sample, Trace max hold
2. Allow trace to stabilize
3. Use Occupied bandwidth function of spectrum analyzer to measuring 99% occupied bandwidth

3.6.2 Test Setup

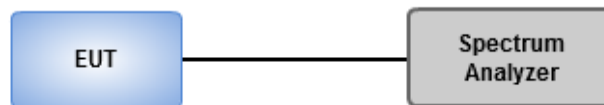

3.6.3 Test result of 20dB and Occupied Bandwidth

Modulation Mode	Freq. (MHz)	20dB Bandwidth (MHz)	Occupied Bandwidth (MHz)
GFSK	2402	0.957	0.872
GFSK	2441	0.957	0.873
GFSK	2480	0.957	0.874
8DPSK	2402	1.300	1.175
8DPSK	2441	1.300	1.174
8DPSK	2480	1.296	1.174

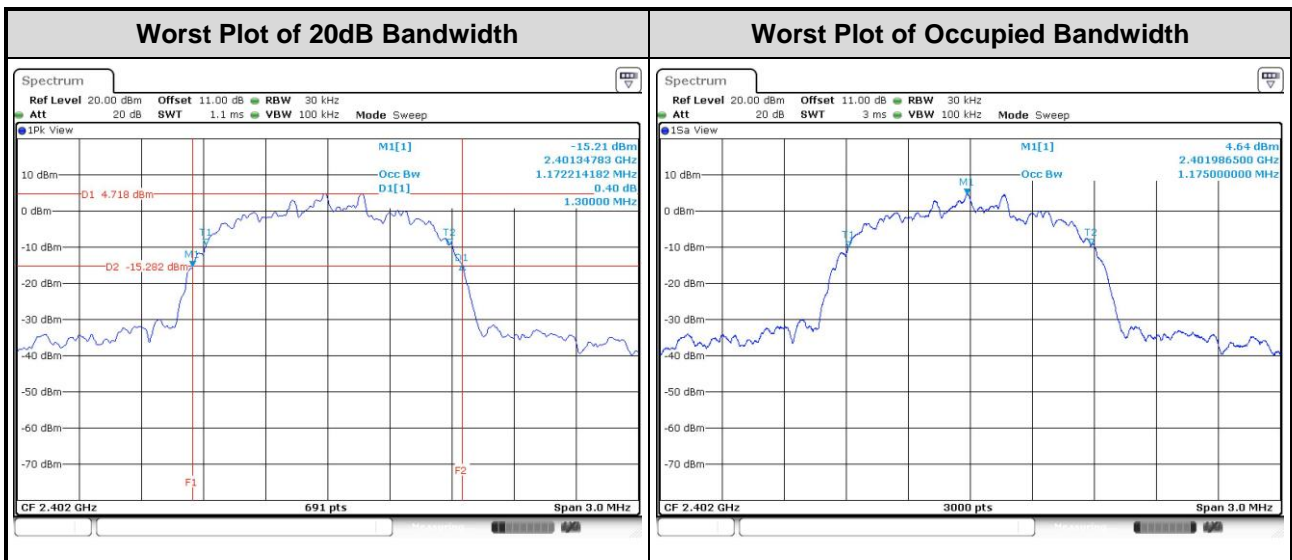

3.7 Channel Separation

3.7.1 Limit of Channel Separation

- Frequency hopping systems shall have hopping channel carrier frequencies separated by a minimum of 25 kHz or the 20 dB bandwidth of the hopping channel, whichever is greater.
- Frequency hopping systems operating in the 2400–2483.5 MHz band may have hopping channel carrier frequencies that are separated by 25 kHz or two-thirds of the 20 dB bandwidth of the hopping channel, whichever is greater.

3.7.2 Test Procedures

1. Set RBW=100kHz, VBW=300kHz, Sweep time = Auto, Detector=Peak Trace max hold
2. Allow trace to stabilize
3. Use the marker-delta function to determine the separation between the peaks of the adjacent channels. The EUT shall show compliance with the appropriate regulatory limit

3.7.3 Test Setup

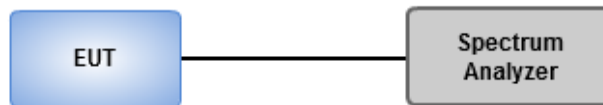

3.7.4 Test result of Channel Separation

Modulation Mode	Freq. (MHz)	Channel Separation (MHz)	20dB Bandwidth (MHz)	Minimum Limit (MHz)
GFSK	2402	1.003	0.957	0.638
GFSK	2441	1.003	0.957	0.638
GFSK	2480	1.003	0.957	0.638
8DPSK	2402	1.003	1.300	0.867
8DPSK	2441	1.003	1.300	0.867
8DPSK	2480	1.003	1.296	0.864

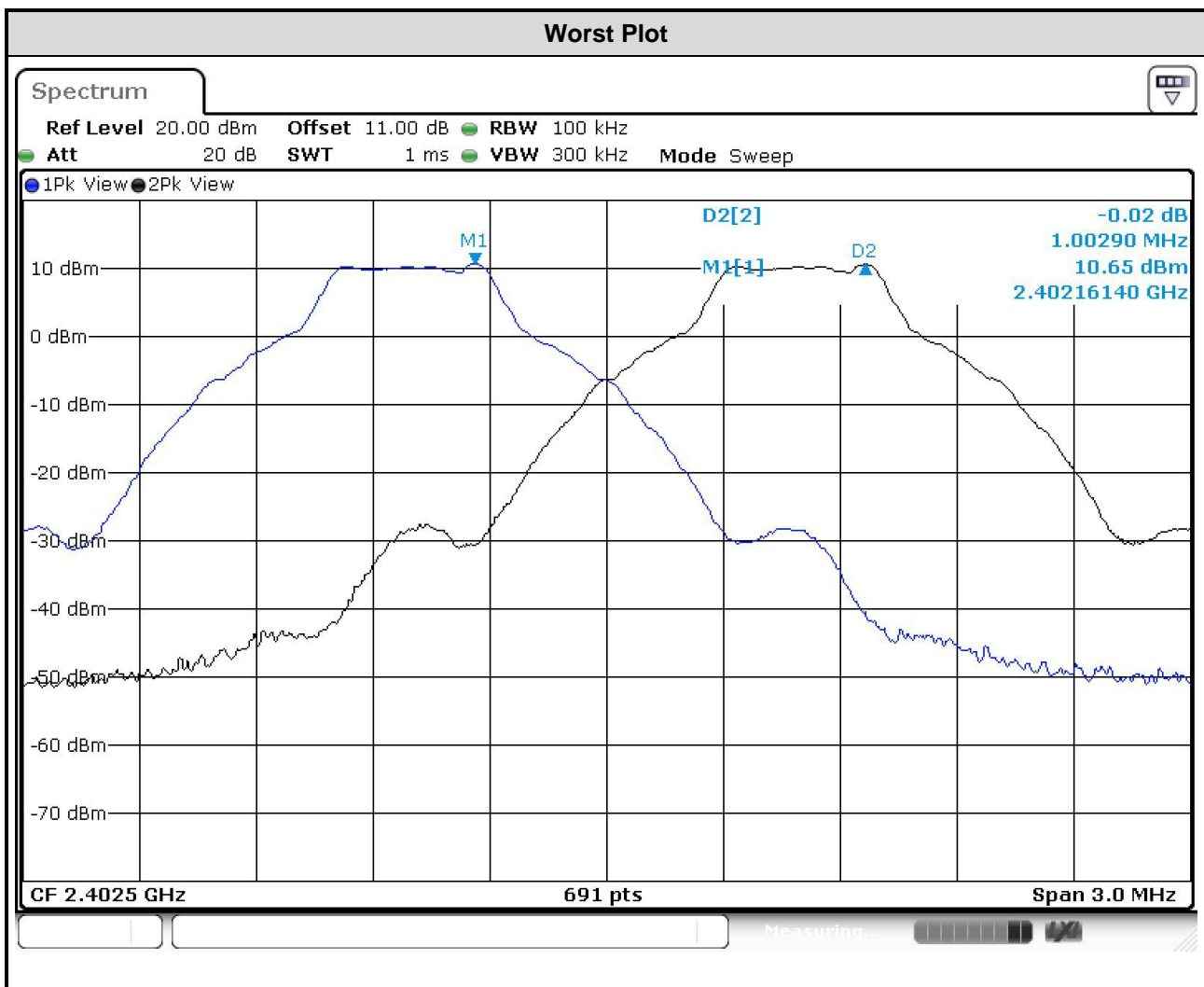

3.8 Number of Dwell Time

3.8.1 Limit of Dwell time

The average time of occupancy on any channel shall not be greater than 0.4 seconds within a period of 0.4 seconds multiplied by the number of hopping channels employed.

3.8.2 Test Procedures

1. Set RBW=100kHz,VBW=300kHz,Sweep time = 500us(DH1),2ms(DH3),4ms(DH5), Detector=Peak, Span=0Hz,Trace max hold
2. Enable gating and trigger function of spectrum analyzer to measure burst on time.
3. The DH1 packet can cover a single time slot. A maximum length packet has duration of 1 time slots. The hopping rate is 1600 hops/second so the maximum dwell time is 1/1600 seconds, or 0.625ms. DH1 Packet permit maximum $1600 / 79 / 2 = 10.12$ hops per second in each channel (1 time slot TX, 1 time slot RX). So, the dwell time is the time duration of the pulse times $10.12 \times 31.6 = 320$ within 31.6 seconds.
4. The DH3 packet can cover up to 3 time slots. A maximum length packet has duration of 3 time slots. The hopping rate is 1600 hops/second so the maximum dwell time is 3/1600 seconds, or 1.875ms. DH3 Packet permit maximum $1600 / 79 / 4 = 5.06$ hops per second in each channel (3 time slots TX, 1 time slot RX). So, the dwell time is the time duration of the pulse times $5.06 \times 31.6 = 160$ within 31.6 seconds.
5. The DH5 packet can cover up to 5 time slots. Operate DH5 at maximum dwell time and maximum duty cycle. A maximum length packet has duration of 5 time slots. The hopping rate is 1600 hops/second so the maximum dwell time is 5/1600 seconds, or 3.125ms. DH5 Packet permit maximum $1600 / 79 / 6 = 3.37$ hops per second in each channel (5 time slots TX, 1 time slot RX). So, the dwell time is the time duration of the pulse times $3.37 \times 31.6 = 106.6$ within 31.6 seconds

3.8.3 Test Setup

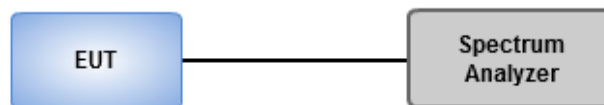

3.8.4 Test Result of Dwell Time

Modulation Mode	Freq. (MHz)	Length of Transmission Time (msec)	Number of Transmission in a 31.6 (79 Hopping*0.4)	Result (s)	Limit (s)
GFSK-DH1	2402	0.45362	320	0.145	0.4
GFSK-DH3	2402	1.69130	160	0.271	0.4
GFSK-DH5	2402	2.96087	106.6	0.316	0.4
8DPSK-DH1	2402	0.43623	320	0.140	0.4
8DPSK-DH3	2402	1.69710	160	0.272	0.4
8DPSK-DH5	2402	2.93913	106.6	0.313	0.4

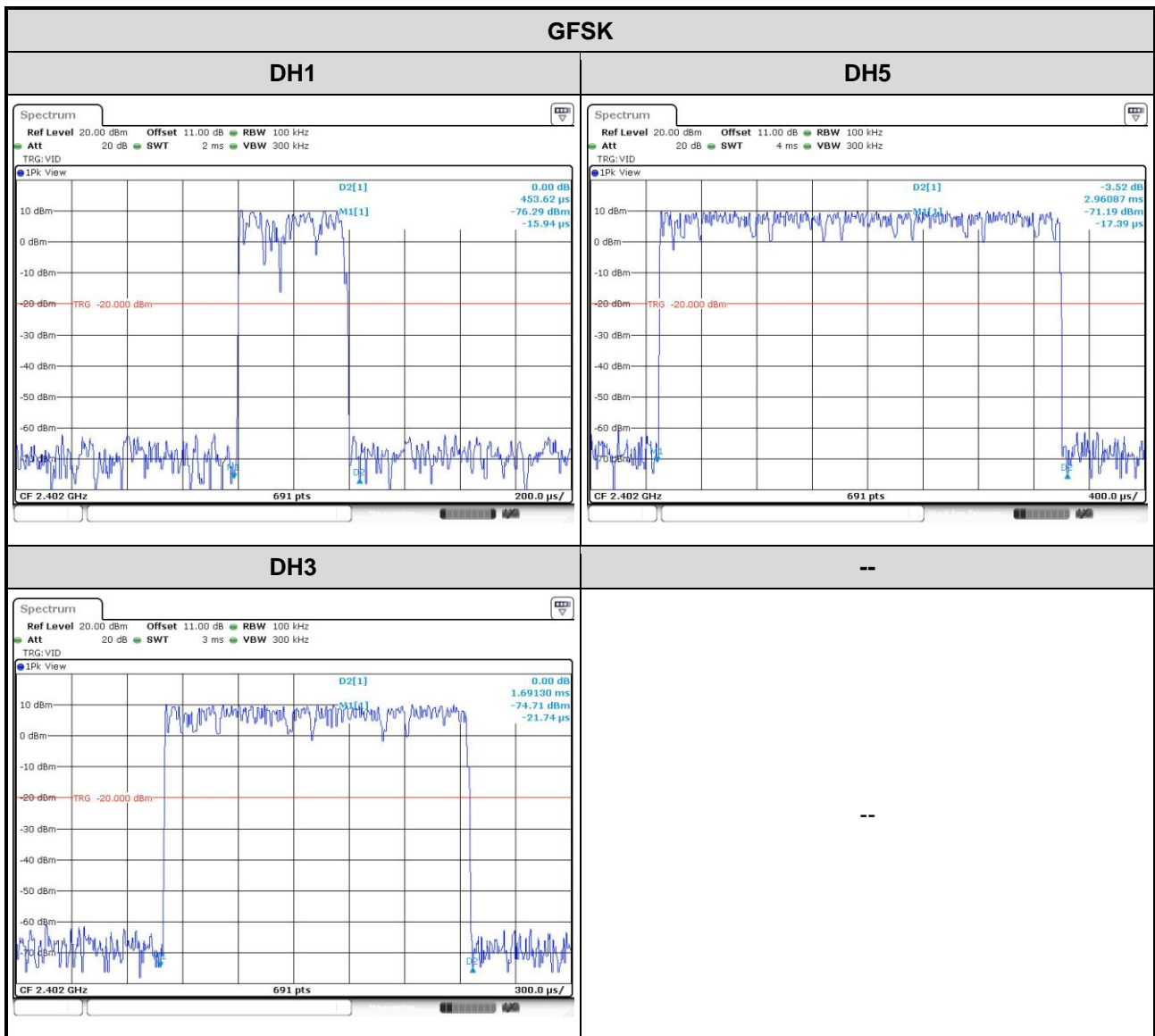

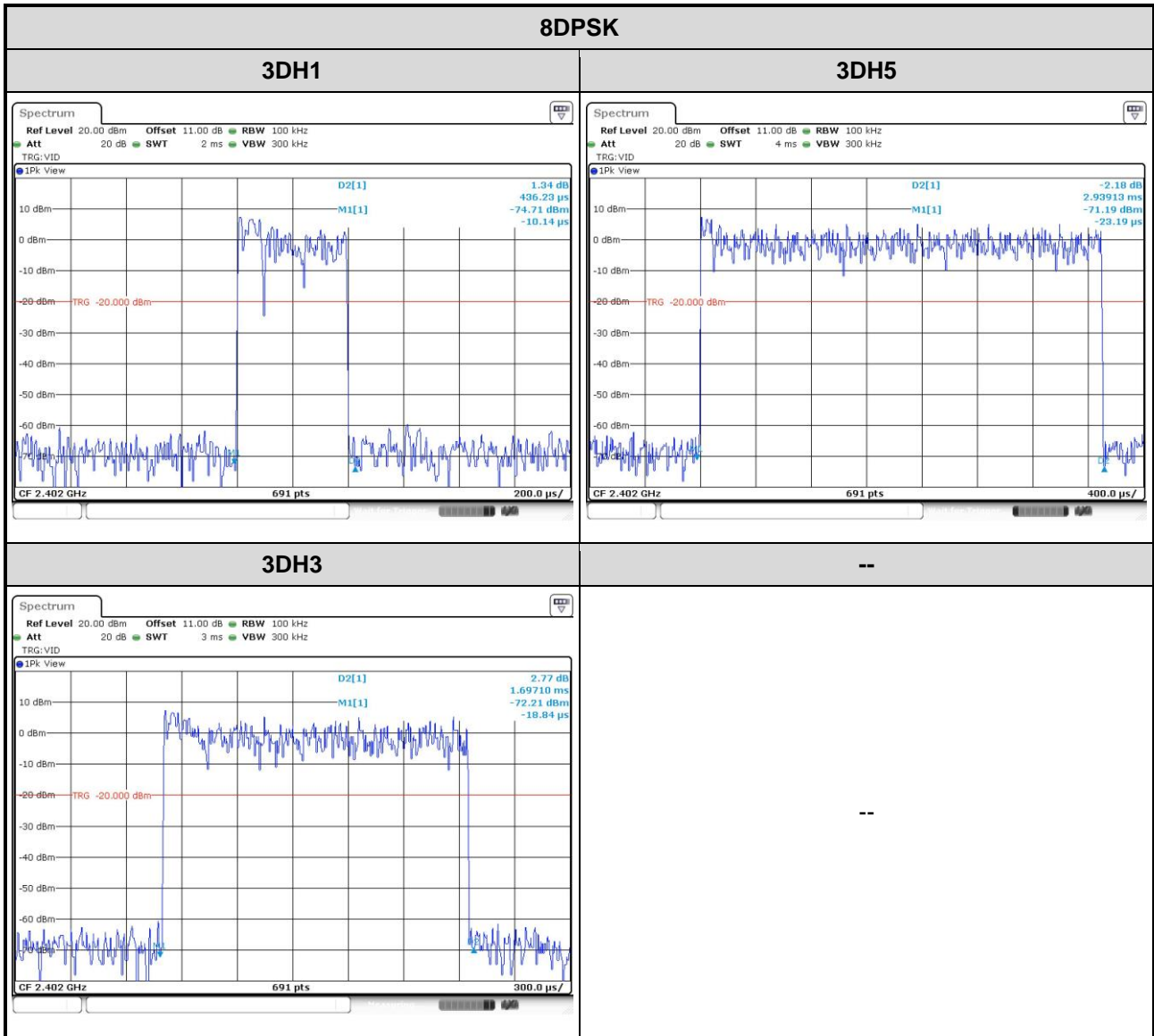

4 Test laboratory information

Established in 2012, ICC provides foremost EMC & RF Testing and advisory consultation services by our skilled engineers and technicians. Our services employ a wide variety of advanced edge test equipment and one of the widest certification extents in the business.

International Certification Corp (EMC and Wireless Communication Laboratory), it is our definitive objective is to institute long term, trust-based associations with our clients. The expectation we set up with our clients is based on outstanding service, practical expertise and devotion to a certified value structure. Our passion is to grant our clients with best EMC / RF services by oriented knowledgeable and accommodating staff.

Our Test sites are located at Linkou District and Kwei Shan District. Location map can be found on our website <http://www.icertifi.com.tw>.

Linkou

Tel: 886-2-2601-1640

No. 30-2, Ding Fwu Tsuen, Lin
Kou District, New Taipei City,
Taiwan, R.O.C.

Kwei Shan

Tel: 886-3-271-8666

No. 3-1, Lane 6, Wen San 3rd St.,
Kwei Shan District, Tao Yuan City
333, Taiwan, R.O.C.

Kwei Shan Site II

Tel: 886-3-271-8640

No. 14-1, Lane 19, Wen San 3rd
St., Kwei Shan District, Tao Yuan
City 333, Taiwan, R.O.C.

If you have any suggestion, please feel free to contact us as below information.

Tel: 886-3-271-8666

Fax: 886-3-318-0155

Email: ICC_Service@icertifi.com.tw

==END==