

FCC ID: SQ9XKT1100
IC: 5768A-XKT1100

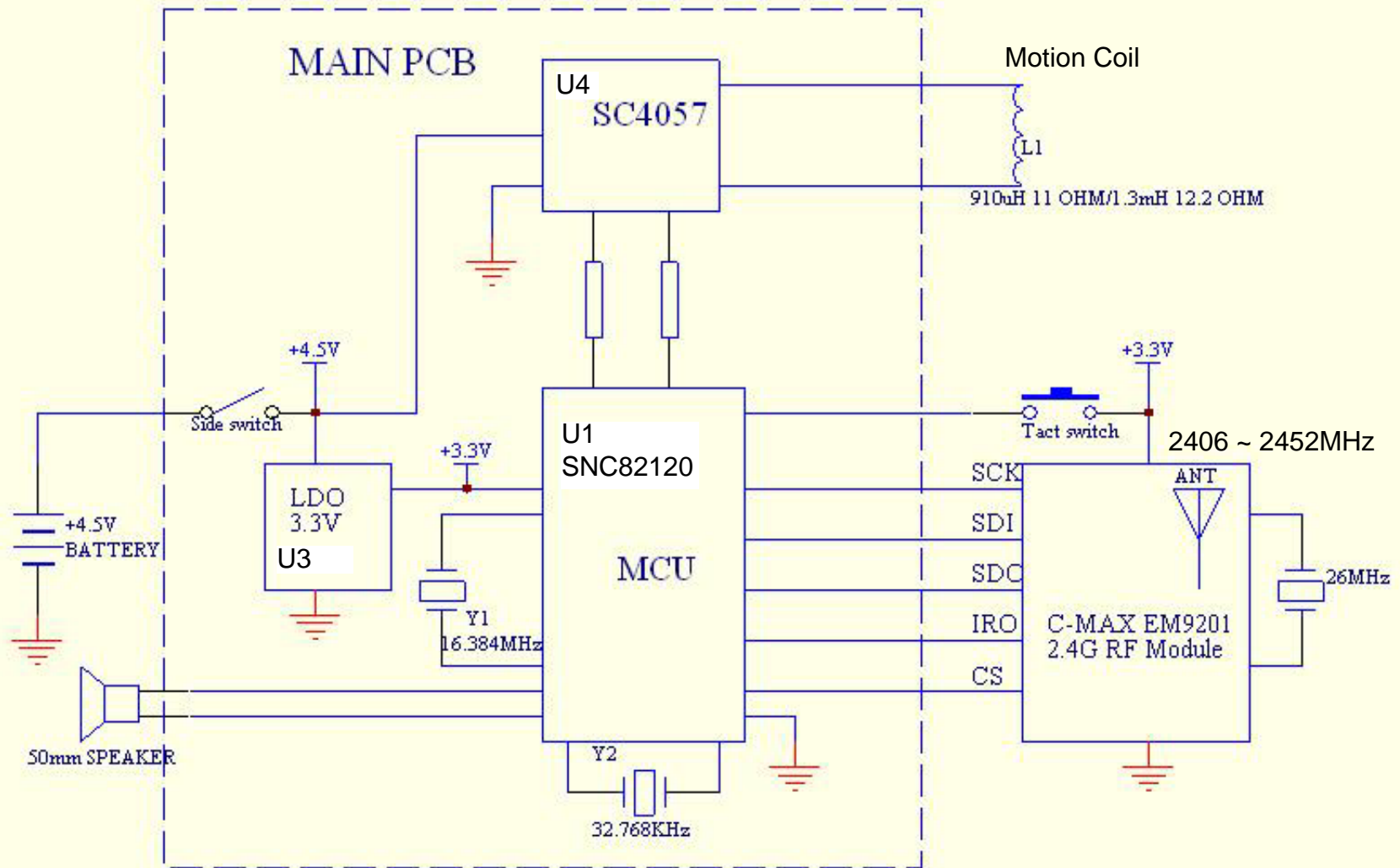

Block Diagram of the RF module

1.1 Block diagram

