

FCC ID: SQ9XKT1003  
IC: 5768A-XKT1003

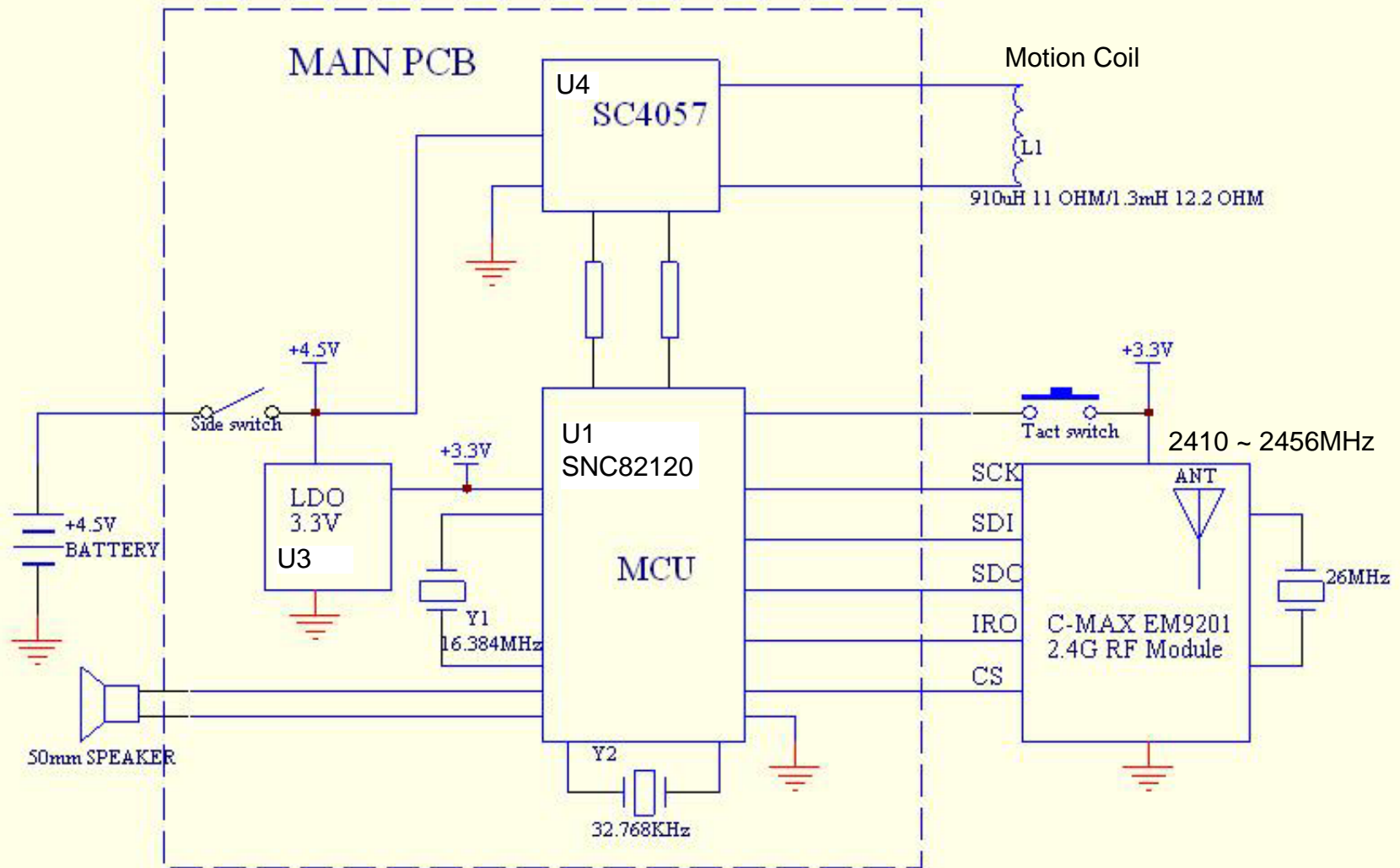

# Block Diagram of the RF module

1.1 Block diagram

