

FCC ID: SQ9XKT1000
IC: 5768A-XKT1000

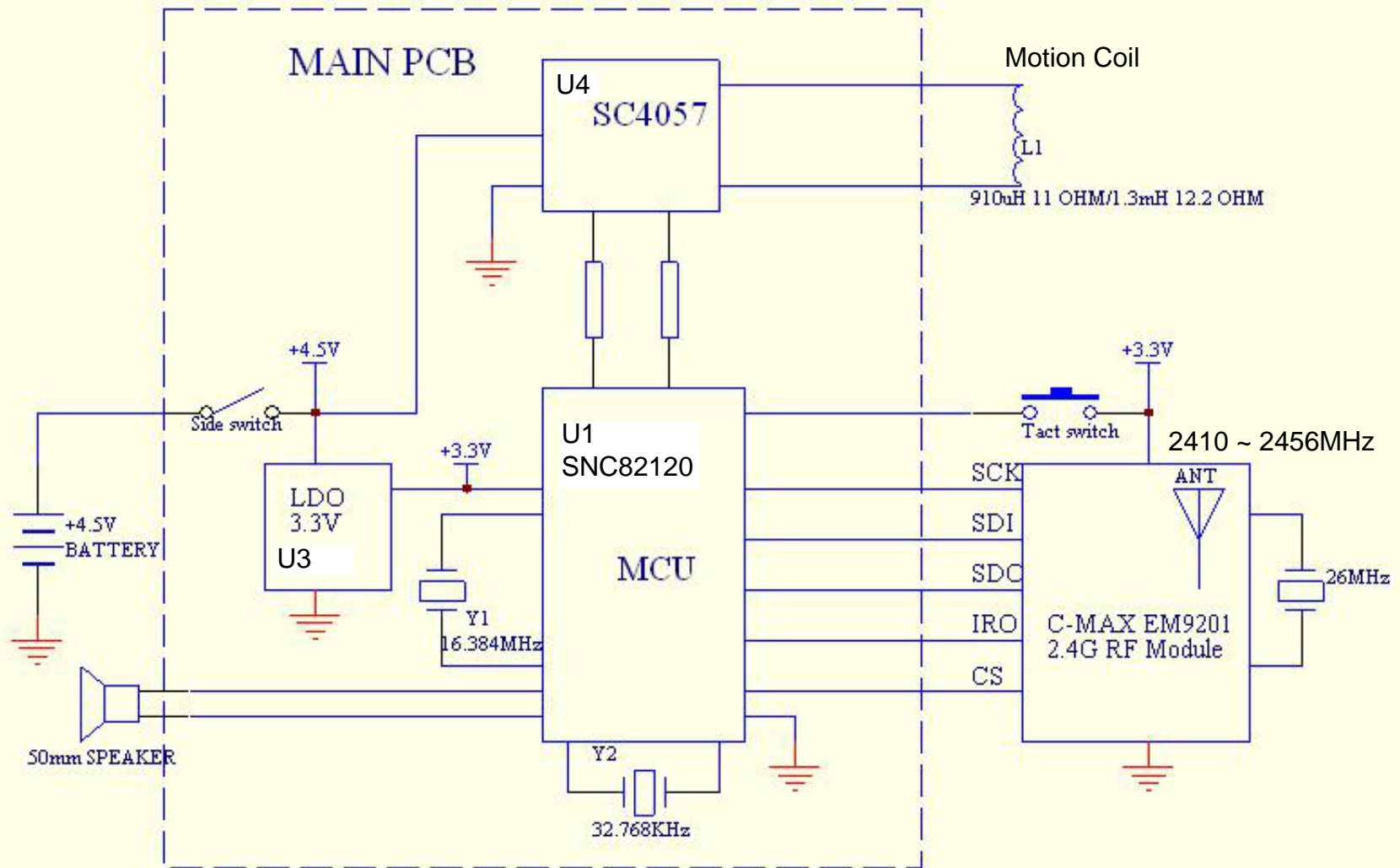

Block Diagram of the RF module

1.1 Block diagram

