

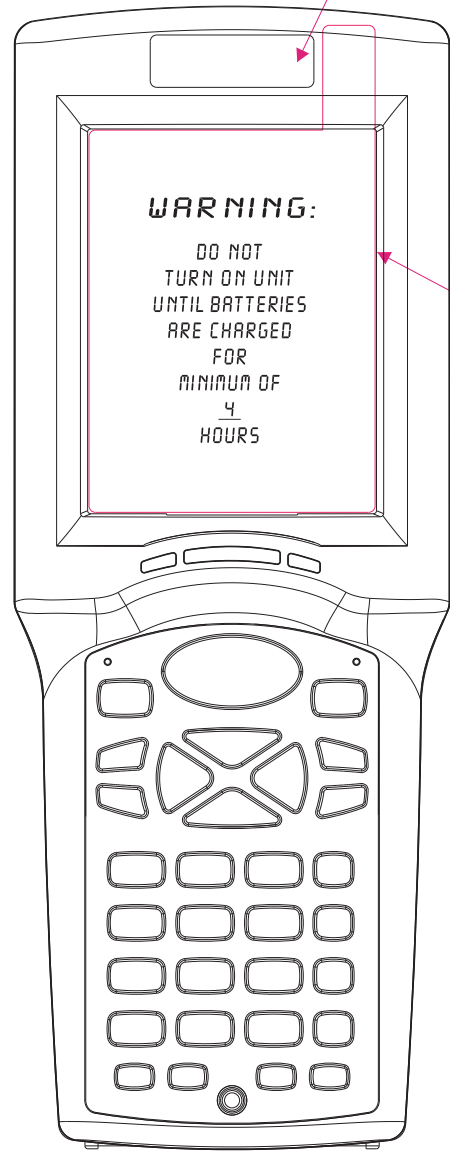

IT8000 Label List

REV	DATE	DESCRIPTION	DESIGN	APP'D



1 LOGO Label

2 Display Protect film

6 Win CE label

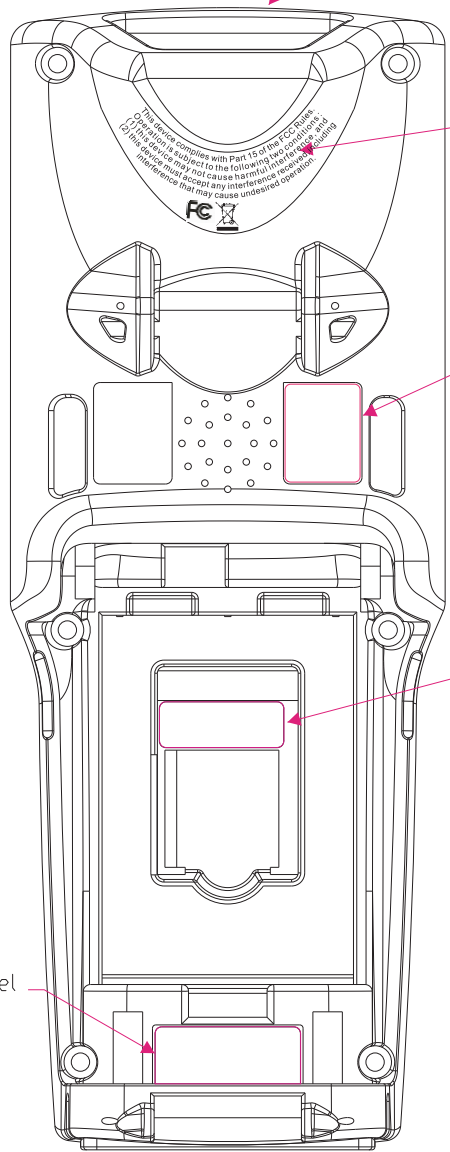



3 Laser Warning Label

刻字

4 System Label

5 Serial Number Label

 銀鐸科技股份有限公司				
SCALE:	UNIT:	MODEL:	IT8000	
FINISH:	MATERIAL:			
DESIGN:	TITLE:		IT8000 Label List	
CHK:	PIN:			
APP'D:	FILENAME:		REV 1.0	
A4				



Display Protect film

REV	DATE	DESCRIPTION	DESIGN	APP'D

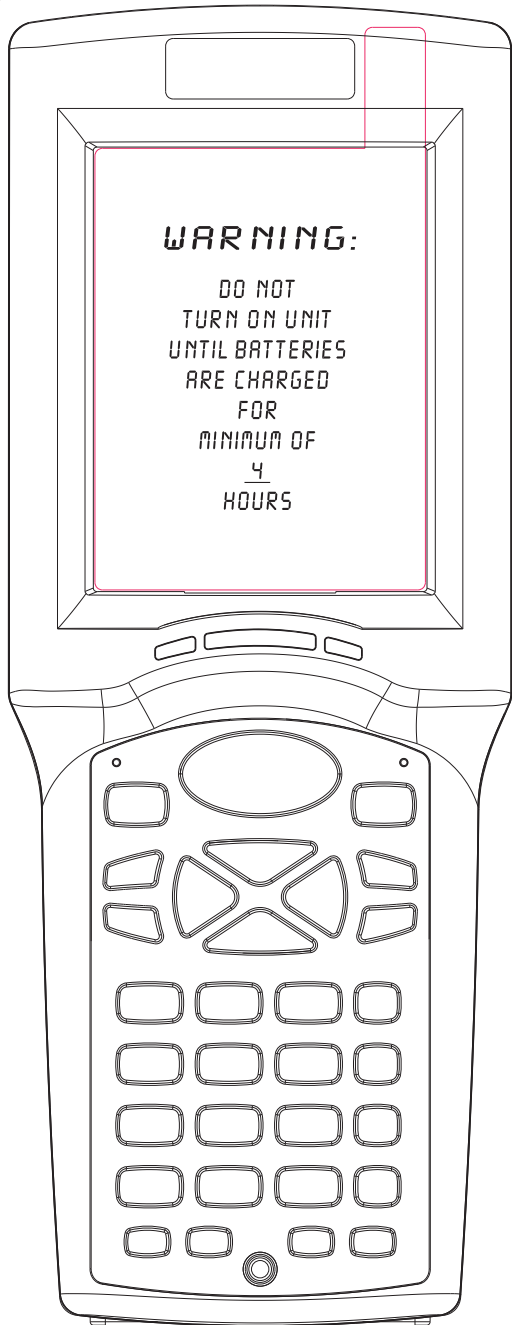

WARNING:

DO NOT
TURN ON UNIT
UNTIL BATTERIES
ARE CHARGED
FOR
MINIMUM OF
4
HOURS

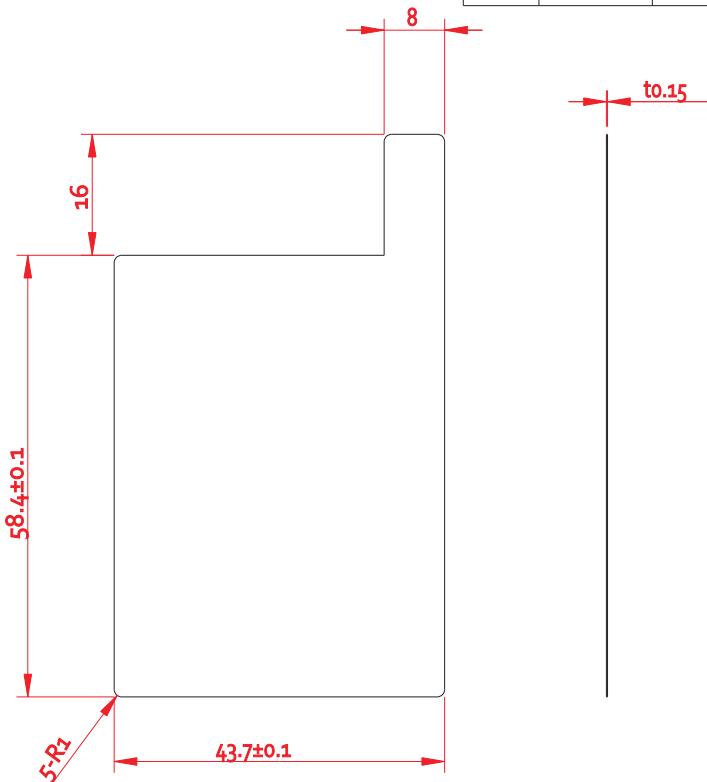



100% Size
Print Reference

WARNING:

DO NOT
TURN ON UNIT
UNTIL BATTERIES
ARE CHARGED
FOR
MINIMUM OF
4
HOURS

 - **WHITE**

Bit 銀鑽科技股份有限公司

SCALE: 1:1	UNIT: mm	MODEL: IT8000
FINISH: PET	MATERIAL:	
DESIGN: Vicki-lin	TITLE: Display Protect film	
CHK:	APP'D:	
	P/N: 4G55-ZZ001701	
A4	 	REV 1.0



LASER WARNING LABEL

REV	DATE	DESCRIPTION	DESIGN	APP'D

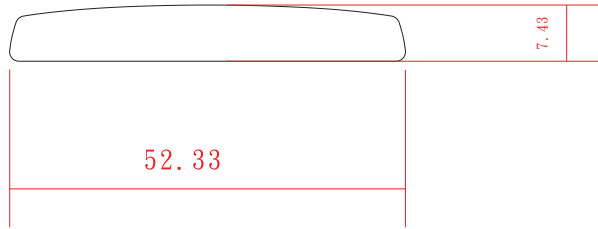

100% Size
Print Reference

1:1



2:1

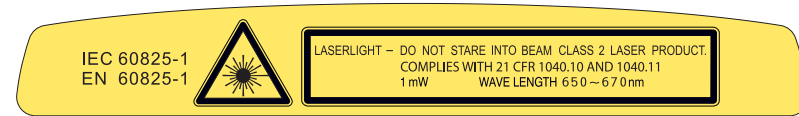

- - BACKGROUND COLOR PANTONE BLACK 6C
 - - BLACK CHARACTERS SWS721 PANTONE BLACK 6C
 - - YELLOW PANTONE 114C
- MATER. 3M 3690

銀鑽科技股份有限公司			
SCALE: 1:1	UNIT: mm	MODEL: IT8000	
FINISH:		MATERIAL:	
DESIGN: Vicki-lin	TITLE: LASER WARNING LABEL		
CHK:	P/N: 4G55-ZZ000301		
APP'D:	REWME:		REV 1.0
A4			



LASER WARNING LABEL (簡體)

REV	DATE	DESCRIPTION	DESIGN	APP'D

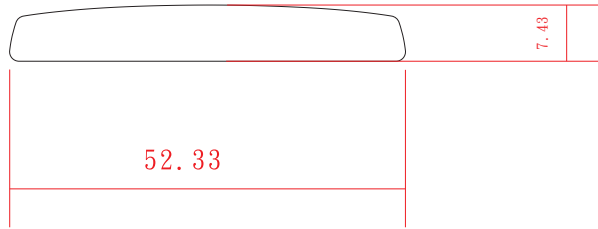

100% Size
Print Reference

1:1



2:1



- - BACKGROUND COLOR PANTONE BLACK 6C
- - BLACK CHARACTERS SWS721 PANTONE BLACK 6C
- - YELLOW PANTONE 114C
MATER. 3M 3690

銀鑽科技股份有限公司			
SCALE: 1:1	UNIT: mm	MODEL: IT8000	
FINISH:		MATERIAL:	
DESIGN: Vicki-lin	TITLE: LASER WARNING LABEL (簡體)		
CHK:	P/N: 4G55-ZZ002201		
APP'D:	REWME:		REV 1.0

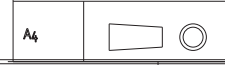



LASER WARNING LABEL (繁體)

REV	DATE	DESCRIPTION	DESIGN	APP'D

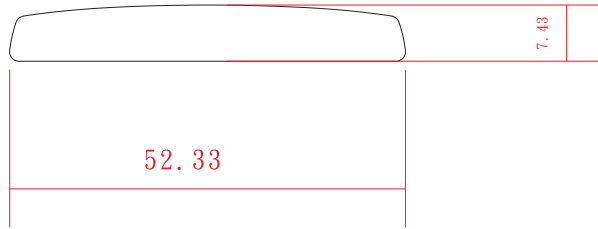

100% Size
Print Reference

1:1



2:1



- - BACKGROUND COLOR PANTONE BLACK 6C
 - - BLACK CHARACTERS SWS721 PANTONE BLACK 6C
 - - YELLOW PANTONE 114C
- MATER. 3M 3690

銀鑽科技股份有限公司			
SCALE:	1:1	UNIT:	mm
MODEL:	IT8000		
FINISH:	DESIGN:		MATERIAL:
	Vicki-lin		
CHK:	TITLE:		LASER WARNING LABEL (繁體)
APP'D:	P/N:		4G55-ZZ002101
A4		REV	1.0



System Label For 1D+WiFi+BT

REV	DATE	DESCRIPTION	DESIGN	APP'D

1:1

繁體

簡體

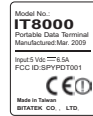
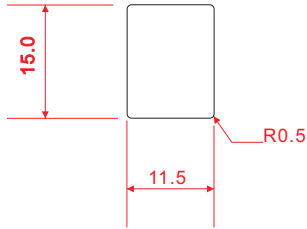

2:1

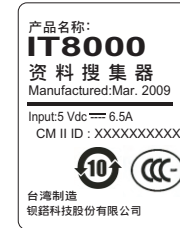
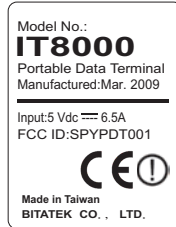

Bita 銀鐸科技股份有限公司

SCALE: 1:1	UNIT: mm	MODEL: IT8000
FINISH:	MATERIAL:	
DESIGN: Vicki-lin	TITLE: System Label For 1D+WLAN+BT	
CHK:	P/N: 4G55-BB000201	
APP'D:	RENME:	REV 1.0

A4





Serial Number Label

REV	DATE	DESCRIPTION	DESIGN	APP'D

1:1

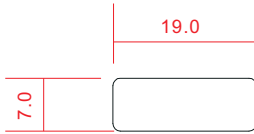

2:1



SCALE: 1:1	UNIT: mm	MODEL: IT8000
FINISH:	MATERIAL:	
DESIGN: Vicki-lin	TITLE: Serial Number Label	
CHK:	P/N: 4G55-BB000201	
APP'D:	RENAME:	REV 1.0

A4





Packaging label For 1D+WiFi+BT

REV	DATE	DESCRIPTION	DESIGN	APP'D

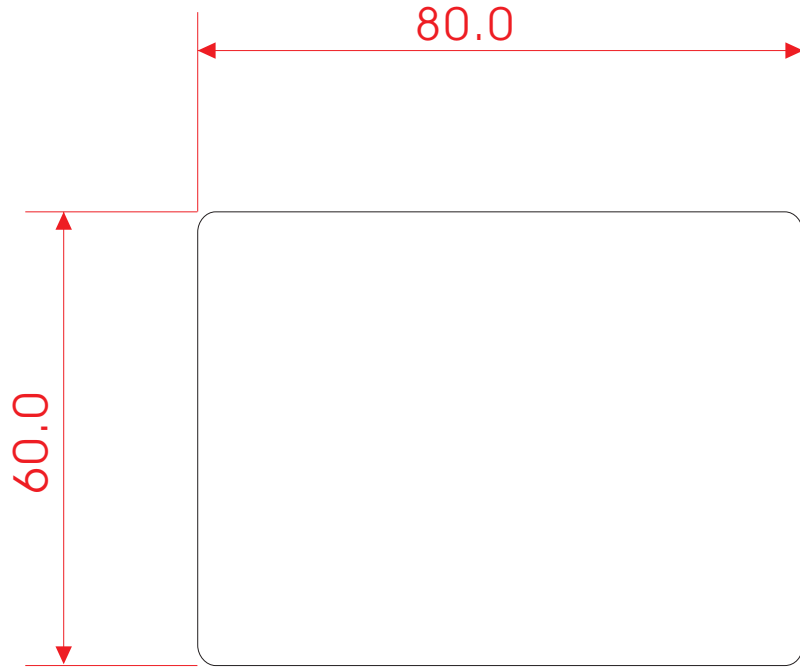



1:1

Model No.: IT8000

P/N 
8T55-XXXX-XXX

S/N 
XXXXXXXXXXXXXX

Made in Taiwan 31 July 2008

R2.5

Bit 銀鑽科技股份有限公司

SCALE: 1:1	UNIT: mm	MODEL: IT8000
FINISH:	MATERIAL:	
DESIGN: Vicki-lin	TITLE: Packaging label For 1D+WiFi+BT	
CHK:	P/N: 4G60-BB000801	
APP'D:	RENAME:	REV 1.0

A4







external package label For 1D+WiFi+BT

110.0

85.0

P/O	Item Code	Q'TY:	P/O	Item Code	Q'TY:
XXXXXXXX	 8T55-XXXX-XXX	12/pcs			

Carton No: 1/10

P/O	Item Code	Q'TY:	P/O	Item Code	Q'TY:
XXXXXXXX	 8T55-XXXX-XXX	12/pcs			

Carton No: 1/10

100% Size
Print Reference



SCALE: 1:1	UNIT: mm	MODEL: IT8000
FINISH:	MATERIAL:	
DESIGN: Vicki-lin	TITLE: external package label For 1D+WiFi+BT	
CHK:	P/N: 4G52-BB001801	
APP'D:	REWME:	REV 1.0

A4

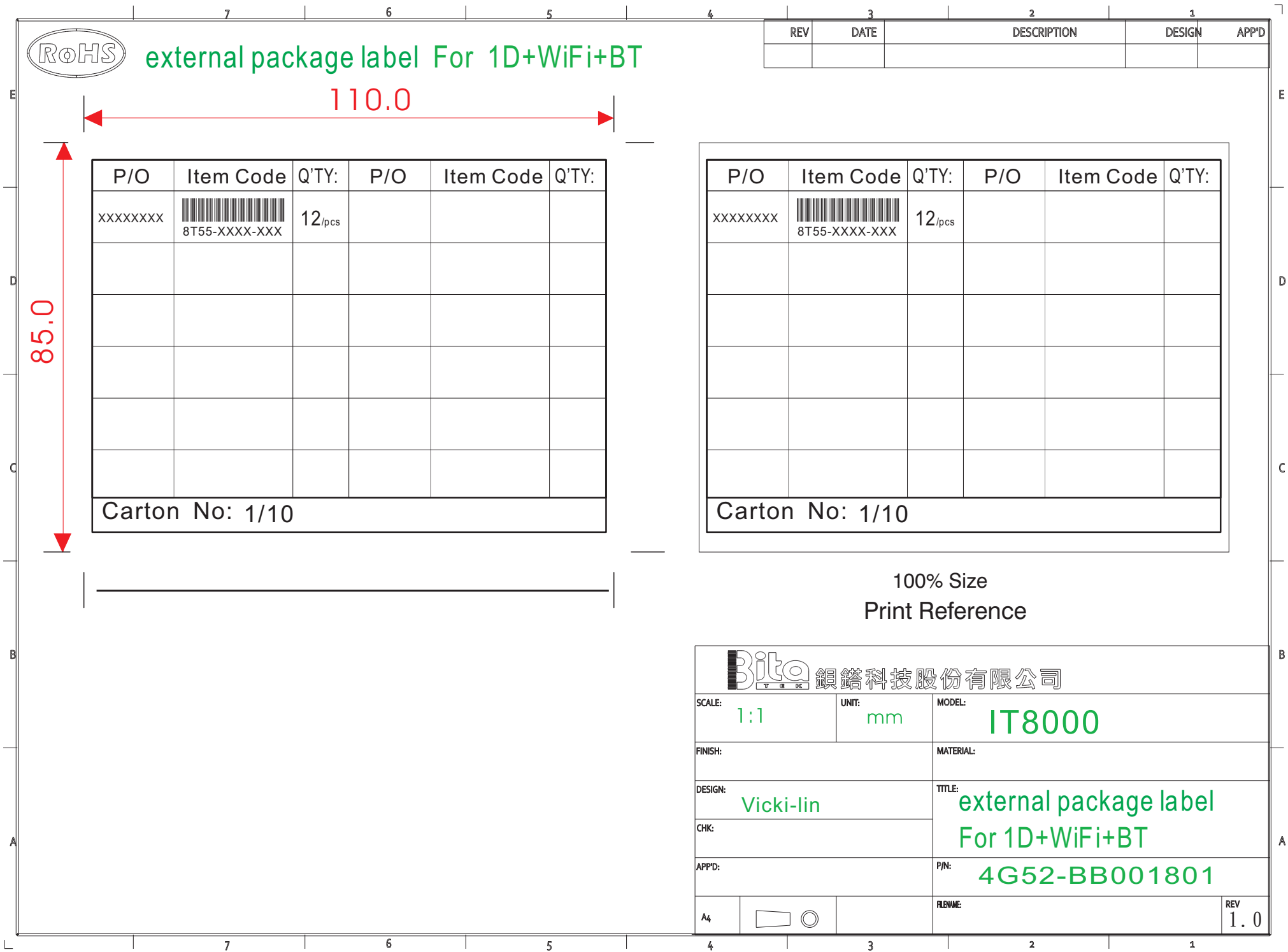



BATTERY CAUTION LABEL

120.0

CAUTION!



IF DAMAGED

Lithium ion battery

**DO NOT LOAD OR TRANSPORT
PACKAGE IF DAMAGED**

For more information, call 886 2 2680 1603

1:1

110.0

REV	DATE	DESCRIPTION	DESIGN	APP'D

CAUTION!

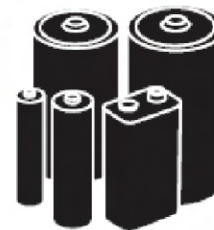

IF DAMAGED

Lithium ion battery

**DO NOT LOAD OR TRANSPORT
PACKAGE IF DAMAGED**

For more information, call 886 2 2680 1603

100% Size

Print Reference

Bito 銀鎔科技股份有限公司

SCALE: 1:1	UNIT: mm	MODEL: IT8000
FINISH:	MATERIAL:	
DESIGN: Vicki-lin	TITLE: BATTERY CAUTION LABEL	
CHK:	P/N: 4G55-BB000601	
APP'D:	FLB/WE:	REV 1.0

A4





IT8000 Outer Box & Carton Lable List

REV	DATE	DESCRIPTION	DESIGN	APPD

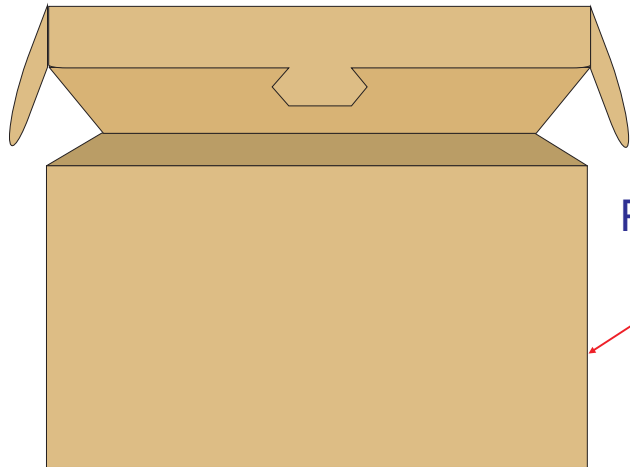

Packaging label

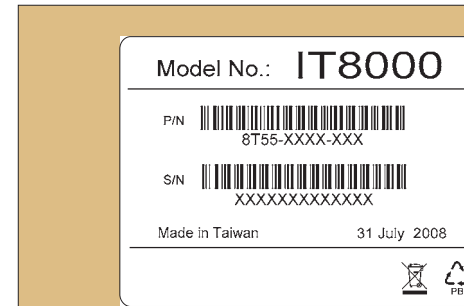

Right side view

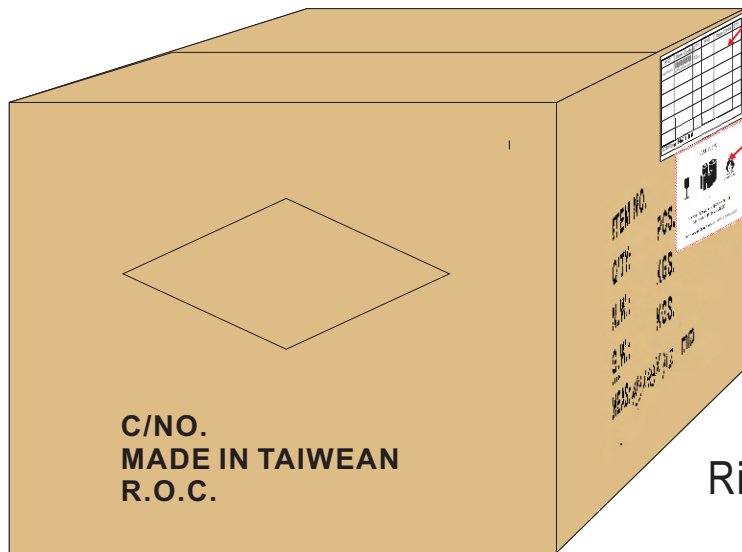

External package label

BATTERY CAUTION LABEL

Right side view

Bit 銀鑽科技股份有限公司				
SCALE:	1:1	UNIT:	mm	MODEL:
			IT8000 SINGLE CRADLE	
FINISH:			MATERIAL:	
DESIGN:	Vicki-lin		TITLE:	
			Outer Box & Carton Lable List	
CHK:			P/N:	
APP'D:			RENAME:	
A4			REV	
			1.0	