

FCC Test Report

Report No.: RF190506C14-3

FCC ID: SPYGLIDERXS

Test Model: Frey Glider XS

Received Date: May 06, 2019

Test Date: May 16, 2019 ~ May 31, 2019

Issued Date: Jun. 06, 2019

Applicant: Bitatek Co., Ltd.

Address: 6F., No. 288, Sec. 6, Civic Blvd., Xinyi Dist., Taipei City 110, Taiwan

Issued By: Bureau Veritas Consumer Products Services (H.K.) Ltd., Taoyuan Branch

Lab Address: No. 47-2, 14th Ling, Chia Pau Vil., Lin Kou Dist., New Taipei City, Taiwan
(R.O.C)

Test Location (1): No. 19, Hwa Ya 2nd Rd, Wen Hwa Tsuen, Kwei Shan Hsiang, Taoyuan
Hsien 333, Taiwan, R.O.C.

Test Location (2): B2F., No.215, Sec. 3, Beixin Rd., Xindian Dist., New Taipei City 231,
Taiwan, R.O.C

**FCC Registration /
Designation Number:** 427177 / TW0011



This report is for your exclusive use. Any copying or replication of this report to or for any other person or entity, or use of our name or trademark, is permitted only with our prior written permission. This report sets forth our findings solely with respect to the test samples identified herein. The results set forth in this report are not indicative or representative of the quality or characteristics of the lot from which a test sample was taken or any similar or identical product unless specifically and expressly noted. Our report includes all of the tests requested by you and the results thereof based upon the information that you provided to us. You have 60 days from date of issuance of this report to notify us of any material error or omission caused by our negligence, provided, however, that such notice shall be in writing and shall specifically address the issue you wish to raise. A failure to raise such issue within the prescribed time shall constitute your unqualified acceptance of the completeness of this report, the tests conducted and the correctness of the report contents. Unless specific mention, the uncertainty of measurement has been explicitly taken into account to declare the compliance or non-compliance to the specification. The report must not be used by the client to claim product certification, approval, or endorsement by TAF or any government agencies.

Table of Contents

Release Control Record	4
1 Certificate of Conformity	5
2 Summary of Test Results	6
2.1 Measurement Uncertainty	6
2.2 Modification Record.....	6
3 General Information	7
3.1 General Description of EUT	7
3.2 Description of Test Modes	8
3.2.1 Test Mode Applicability and Tested Channel Detail	9
3.3 Description of Support Units.....	11
3.3.1 Configuration of System under Test.....	11
3.4 General Description of Applied Standards.....	11
4 Test Types and Results	12
4.1 Radiated Emission and Bandedge Measurement	12
4.1.1 Limits of Radiated Emission and Bandedge Measurement.....	12
4.1.2 Test Instruments	13
4.1.3 Test Procedures.....	14
4.1.4 Deviation from Test Standard.....	14
4.1.5 Test Set Up	15
4.1.6 EUT Operating Conditions	16
4.1.7 Test Results	17
4.2 Conducted Emission Measurement	25
4.2.1 Limits of Conducted Emission Measurement	25
4.2.2 Test Instruments	25
4.2.3 Test Procedures.....	26
4.2.4 Deviation from Test Standard.....	26
4.2.5 Test Setup.....	26
4.2.6 EUT Operating Condition	26
4.2.7 Test Results	27
4.3 Number of Hopping Frequency Used	29
4.3.1 Limits of Hopping Frequency Used Measurement	29
4.3.2 Test Setup.....	29
4.3.3 Test Instruments	29
4.3.4 Test Procedure	29
4.3.5 Deviation from Test Standard.....	29
4.3.6 Test Results	30
4.4 Dwell Time on Each Channel	31
4.4.1 Limits of Dwell Time on Each Channel Measurement	31
4.4.2 Test Setup.....	31
4.4.3 Test Instruments	31
4.4.4 Test Procedures.....	31
4.4.5 Deviation from Test Standard.....	31
4.4.6 Test Results	32
4.5 Channel Bandwidth	34
4.5.1 Limits of Channel Bandwidth Measurement	34
4.5.2 Test Setup.....	34
4.5.3 Test Instruments	34
4.5.4 Test Procedure	34
4.5.5 Deviation from Test Standard.....	34
4.5.6 EUT Operating Condition	34
4.5.7 Test Results	35
4.6 Occupied Bandwidth Measurement	36
4.6.1 Test Setup.....	36

4.6.2	Test Instruments	36
4.6.3	Test Procedure	36
4.6.4	Deviation from Test Standard	36
4.6.5	EUT Operating Conditions	36
4.6.6	Test Results	37
4.7	Hopping Channel Separation	38
4.7.1	Limits of Hopping Channel Separation Measurement	38
4.7.2	Test Setup	38
4.7.3	Test Instruments	38
4.7.4	Test Procedure	38
4.7.5	Deviation from Test Standard	38
4.7.6	Test Results	39
4.8	Maximum Output Power	40
4.8.1	Limits of Maximum Output Power Measurement	40
4.8.2	Test Setup	40
4.8.3	Test Instruments	40
4.8.4	Test Procedure	40
4.8.5	Deviation from Test Standard	40
4.8.6	EUT Operating Condition	40
4.8.7	Test Results	41
4.9	Conducted Out of Band Emission Measurement	42
4.9.1	Limits Of Conducted Out of Band Emission Measurement	42
4.9.2	Test Instruments	42
4.9.3	Test Procedure	42
4.9.4	Deviation from Test Standard	42
4.9.5	EUT Operating Condition	42
4.9.6	Test Results	42
5	Pictures of Test Arrangements	47
	Appendix – Information of the Testing Laboratories	48

Release Control Record

Issue No.	Description	Date Issued
RF190506C14-3	Original Release	Jun. 06, 2019

1 Certificate of Conformity

Product: Rugged Mobile Computer

Brand: Bitatek

Test Model: Frey Glider XS

Sample Status: Engineering Sample

Applicant: Bitatek Co., Ltd.

Test Date: May 16, 2019 ~ May 31, 2019

Standards: 47 CFR FCC Part 15, Subpart C (Section 15.247)
ANSI C63.10:2013

The above equipment has been tested by **Bureau Veritas Consumer Products Services (H.K.) Ltd., Taoyuan Branch**, and found compliance with the requirement of the above standards. The test record, data evaluation & Equipment Under Test (EUT) configurations represented herein are true and accurate accounts of the measurements of the sample's RF characteristics under the conditions specified in this report.

Prepared by : Rona Chen , **Date:** Jun. 06, 2019
Rona Chen / Specialist

Approved by : Dylan Chiou , **Date:** Jun. 06, 2019
Dylan Chiou / Project Engineer

2 Summary of Test Results

47 CFR FCC Part 15, Subpart C (Section 15.247)			
FCC Clause	Test Item	Result	Remarks
15.207	AC Power Conducted Emission	Pass	Meet the requirement of limit. Minimum passing margin is -19.26 dB at 0.17737 MHz.
15.247(a)(1)(iii)	Number of Hopping Frequency Used	Pass	Meet the requirement of limit.
15.247(a)(1)(iii)	Dwell Time on Each Channel	Pass	Meet the requirement of limit.
15.247(a)(1)	1. Hopping Channel Separation 2. Spectrum Bandwidth of a Frequency Hopping Sequence Spread Spectrum System	Pass	Meet the requirement of limit.
15.247(a)(1)	Maximum Peak Output Power	Pass	Meet the requirement of limit.
---	Occupied Bandwidth Measurement	Pass	Reference only
15.205 & 209	Radiated Emissions	Pass	Meet the requirement of limit. Minimum passing margin is -2.23 dB at 9608 MHz.
15.247(d)	Band Edge Measurement	Pass	Meet the requirement of limit.
15.247(d)	Antenna Port Emission	Pass	Meet the requirement of limit.
15.203	Antenna Requirement	Pass	No antenna connector is used.

Note:

1. If the Frequency Hopping System operating in 2400-2483.5 MHz band and the output power less than 125 mW. The hopping channel carrier frequencies separated by a minimum of 25 kHz or two-thirds of the 20 dB bandwidth of hopping channel whichever is greater.
2. Determining compliance based on the results of the compliance measurement, not taking into account measurement instrumentation uncertainty.

2.1 Measurement Uncertainty

Where relevant, the following measurement uncertainty levels have been estimated for tests performed on the EUT as specified in CISPR 16-4-2:

Measurement	Frequency	Expanded Uncertainty (k=2) (±)
Conducted Emissions at mains ports	150 kHz ~ 30 MHz	2.44 dB
Radiated Emissions up to 1 GHz	9 kHz ~ 30 MHz	3.04 dB
	30 MHz ~ 200 MHz	2.0153 dB
	200 MHz ~ 1000 MHz	2.0224 dB
Radiated Emissions above 1 GHz	1 GHz ~ 18 GHz	1.0121 dB
	18 GHz ~ 40 GHz	1.1508 dB

2.2 Modification Record

There were no modifications required for compliance.

3 General Information

3.1 General Description of EUT

Product	Rugged Mobile Computer
Brand	Bitatek
Test Model	Frey Glider XS
Status of EUT	Engineering Sample
Power Supply Rating	5 Vdc / 9Vdc / 12Vdc (Adapter) 3.85 Vdc (Battery)
Modulation Type	GFSK, $\pi/4$ -DQPSK, 8DPSK
Transfer Rate	1/2/3 Mbps
Operating Frequency	2402 ~ 2480 MHz
Number of Channel	79
Output Power	1.225 mW
Antenna Type	PIFA antenna with gain 1.76 dBi
Antenna Connector	N/A
Accessory Device	Refer to Note as below
Data Cable Supplied	Refer to Note as below

Note:

1. The EUT contains following accessory devices.

Product	Brand	Model	Description
Adapter	TEN PAO	S018BYU1200150	I/P: 100-240 Vac, 50-60 Hz, 600 mA O/P: 5 Vdc, 3 A / 9 Vdc, 2 A / 12 Vdc, 1.5 A
Battery	TWS	MAXELL_ICP616180AWR	3.85 Vdc, 4000 mAh, 15.4Wh
USB Cable	Conntek	A36-A033-V149	0.95 m shielded cable w/o core
eMMC 1	Hynix	H9HP52ACPMMDAR-KMM	64GB
eMMC 2	Samsung	KMDD60018M-B320	32GB

2. The above EUT information is declared by manufacturer and for more detailed features description, please refers to the manufacturer's specifications or User's Manual.

3.2 Description of Test Modes

79 channels are provided to this EUT:

Channel	Freq. (MHz)	Channel	Freq. (MHz)	Channel	Freq. (MHz)	Channel	Freq. (MHz)
0	2402	20	2422	40	2442	60	2462
1	2403	21	2423	41	2443	61	2463
2	2404	22	2424	42	2444	62	2464
3	2405	23	2425	43	2445	63	2465
4	2406	24	2426	44	2446	64	2466
5	2407	25	2427	45	2447	65	2467
6	2408	26	2428	46	2448	66	2468
7	2409	27	2429	47	2449	67	2469
8	2410	28	2430	48	2450	68	2470
9	2411	29	2431	49	2451	69	2471
10	2412	30	2432	50	2452	70	2472
11	2413	31	2433	51	2453	71	2473
12	2414	32	2434	52	2454	72	2474
13	2415	33	2435	53	2455	73	2475
14	2416	34	2436	54	2456	74	2476
15	2417	35	2437	55	2457	75	2477
16	2418	36	2438	56	2458	76	2478
17	2419	37	2439	57	2459	77	2479
18	2420	38	2440	58	2460	78	2480
19	2421	39	2441	59	2461		

3.2.1 Test Mode Applicability and Tested Channel Detail

EUT Configure Mode	Applicable To				Description
	RE \geq 1G	RE<1G	PLC	APCM	
-	√	√	√	√	-

Where **RE \geq 1G**: Radiated Emission above 1 GHz **RE<1G**: Radiated Emission below 1 GHz
PLC: Power Line Conducted Emission **APCM**: Antenna Port Conducted Measurement

Note:

1. The EUT had been pre-tested on the positioned of each 3 axis. The worst case was found when positioned on **Z-plane**.
2. "-" means no effect.

Radiated Emission Test (Above 1 GHz):

- Pre-Scan has been conducted to determine the worst-case mode from all possible combinations between available modulations, data rates and antenna ports (if EUT with antenna diversity architecture).
- Following channel(s) was (were) selected for the final test as listed below.

EUT Configure Mode	Available Channel	Tested Channel	Modulation Technology	Modulation Type	Packet Type
-	0 to 78	0, 39, 78	FHSS	GFSK	DH5
	0 to 78	0, 39, 78	FHSS	8DPSK	3DH5

Radiated Emission Test (Below 1 GHz):

- Pre-Scan has been conducted to determine the worst-case mode from all possible combinations between available modulations, data rates and antenna ports (if EUT with antenna diversity architecture).
- Following channel(s) was (were) selected for the final test as listed below.

EUT Configure Mode	Available Channel	Tested Channel	Modulation Technology	Modulation Type	Packet Type
-	0 to 78	0	FHSS	GFSK	DH5

Power Line Conducted Emission Test:

- Pre-Scan has been conducted to determine the worst-case mode from all possible combinations between available modulations, data rates and antenna ports (if EUT with antenna diversity architecture).
- Following channel(s) was (were) selected for the final test as listed below.

EUT Configure Mode	Available Channel	Tested Channel	Modulation Technology	Modulation Type	Packet Type
-	0 to 78	0	FHSS	GFSK	DH5

Antenna Port Conducted Measurement:

- This item includes all test value of each mode, but only includes spectrum plot of worst value of each mode.
- Pre-Scan has been conducted to determine the worst-case mode from all possible combinations between available modulations, data rates and antenna ports (if EUT with antenna diversity architecture).
- Following channel(s) was (were) selected for the final test as listed below.

EUT Configure Mode	Available Channel	Tested Channel	Modulation Technology	Modulation Type	Packet Type
-	0 to 78	0, 39, 78	FHSS	GFSK	DH5
-	0 to 78	0, 39, 78	FHSS	8DPSK	3DH5

Test Condition:

Applicable To	Environmental Conditions	Input Power	Tested by
RE \geq 1G	25 deg. C, 65 % RH	120 Vac, 60 Hz	Charles Hsiao
RE<1G	25 deg. C, 65 % RH	120 Vac, 60 Hz	Charles Hsiao
PLC	25 deg. C, 65 % RH	120 Vac, 60 Hz	Thomas Wei
APCM	25 deg. C, 65 % RH	3.85 Vdc	Gavin Wu

3.3 Description of Support Units

The EUT has been tested as an independent unit together with other necessary accessories or support units. The following support units or accessories were used to form a representative test configuration during the tests.

No.	Product	Brand	Model No.	Serial No.	FCC ID
1.	Bluetooth Tester	R&S	CBT	100980	N/A

No.	Signal Cable Description Of The Above Support Units
1.	N/A

Note:

1. All power cords of the above support units are non-shielded (1.8m).
2. Items 1 acted as communication partners to transfer data.

3.3.1 Configuration of System under Test

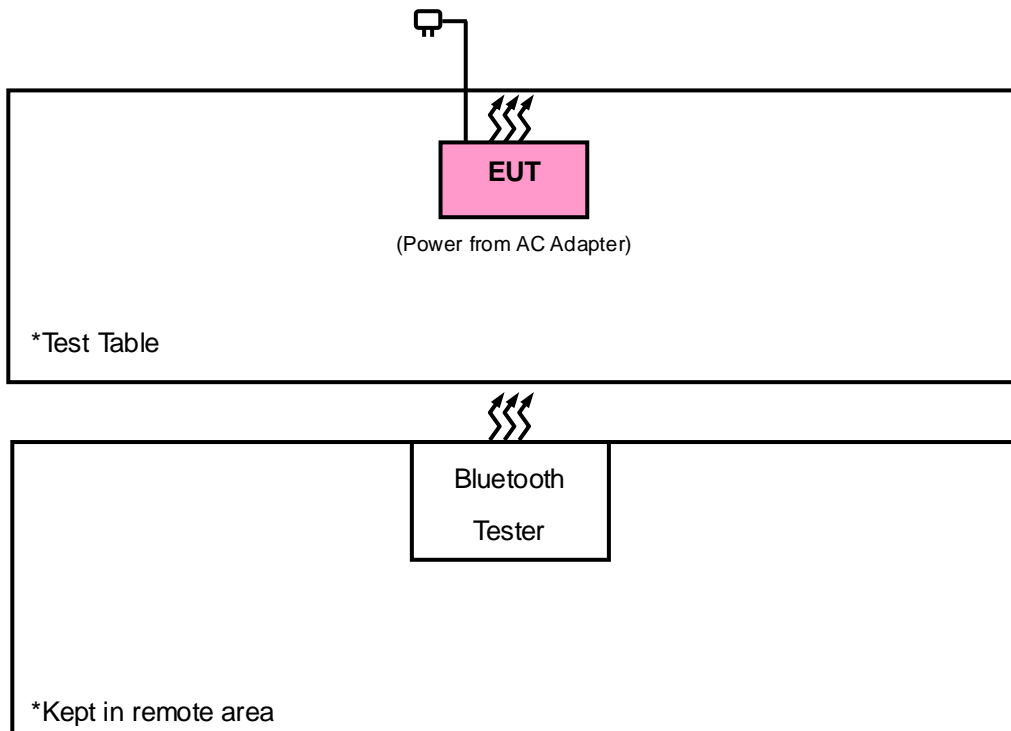

3.4 General Description of Applied Standards

The EUT is a RF Product. According to the specifications of the manufacturer, it must comply with the requirements of the following standards:

FCC Part 15, Subpart C (15.247)

KDB 558074 D01 15.247 Meas Guidance v05r02

ANSI C63.10-2013

All test items have been performed and recorded as per the above standards.

4 Test Types and Results

4.1 Radiated Emission and Bandedge Measurement

4.1.1 Limits of Radiated Emission and Bandedge Measurement

Radiated emissions which fall in the restricted bands must comply with the radiated emission limits specified as below table. Other emissions shall be at least 20 dB below the highest level of the desired power:

Frequencies (MHz)	Field Strength (microvolts/meter)	Measurement Distance (meters)
0.009 ~ 0.490	2400/F (kHz)	300
0.490 ~ 1.705	24000/F (kHz)	30
1.705 ~ 30.0	30	30
30 ~ 88	100	3
88 ~ 216	150	3
216 ~ 960	200	3
Above 960	500	3

Note:

- a. The lower limit shall apply at the transition frequencies.
- b. Emission level (dBuV/m) = 20 log Emission level (uV/m).
- c. For frequencies above 1000 MHz, the field strength limits are based on average detector, however, the peak field strength of any emission shall not exceed the maximum permitted average limits, specified above by more than 20 dB under any condition of modulation.

4.1.2 Test Instruments

Description & Manufacturer	Model No.	Serial No.	Date of Calibration	Due Date of Calibration
Test Receiver Agilent Technologies	N9038A	MY52260177	Aug. 20, 2018	Aug. 19, 2019
Spectrum Analyzer ROHDE & SCHWARZ	FSU43	101261	Apr. 15, 2019	Apr. 14, 2020
HORN Antenna ETS-Lindgren	3117	00143293	Nov. 25, 2018	Nov. 24, 2019
BILOG Antenna SCHWARZBECK	VULB 9168	9168-616	Nov. 27, 2018	Nov. 26, 2019
HORN Antenna SCHWARZBECK	BBHA 9170	9170-480	Nov. 25, 2018	Nov. 24, 2019
Fixed Attenuator Mini-Circuits	MDCS18N-10	MDCS18N-10-01	Apr. 15, 2019	Apr. 14, 2020
Bluetooth Tester	CBT	100980	Jun. 28, 2017	Jun. 27, 2019
Loop Antenna	EM-6879	269	Sep. 07, 2018	Sep. 06, 2019
Preamplifier Agilent	310N	187226	Jun. 19, 2018	Jun. 18, 2019
Preamplifier Agilent	83017A	MY39501357	Jun. 19, 2018	Jun. 18, 2019
Preamplifier EMCI	EMC 184045	980116	Oct. 12, 2018	Oct. 11, 2019
Power Meter Anritsu	ML2495A	1232002	Dec. 17, 2018	Dec. 16, 2019
Power Sensor Anritsu	MA2411B	1207325	Dec. 17, 2018	Dec. 16, 2019
RF signal cable ETS-LINDGREN	5D-FB	Cable-CH1-01(RFC -SMS-100-SMS-12 0+RFC-SMS-100-S MS-400)	Jun. 19, 2018	Jun. 18, 2019
RF signal cable ETS-LINDGREN	8D-FB	Cable-CH1-02(RFC -SMS-100-SMS-24)	Jun. 19, 2018	Jun. 18, 2019
Boresight Antenna Fixture	FBA-01	FBA-SIP01	NA	NA
Software BV ADT	E3 8.130425b	NA	NA	NA
Antenna Tower MF	NA	NA	NA	NA
Turn Table MF	NA	NA	NA	NA
Antenna Tower & Turn Table Controller MF	MF-7802	NA	NA	NA

Note: 1. The calibration interval of the above test instruments is 12 / 24 months and the calibrations are traceable to NML/ROC and NIST/USA.

2. The test was performed in HsinTien Chamber 1.

4.1.3 Test Procedures

For Radiated Emission below 30 MHz

- a. The EUT was placed on the top of a rotating table 0.8 meters above the ground at a 3 meter chamber room. The table was rotated 360 degrees to determine the position of the highest radiation.
- b. The EUT was set 3 meters away from the interference-receiving antenna, which was mounted on the top of a variable-height antenna tower.
- c. Both Parallel, perpendicular, and ground-parallel orientations of the antenna are set to make the measurement.
- d. For each suspected emission, the EUT was arranged to its worst case and the rotatable table was turned from 0 degrees to 360 degrees to find the maximum reading.
- e. The test-receiver system was set to Quasi-Peak Detect Function and Specified Bandwidth with Maximum Hold Mode.

Note:

1. The resolution bandwidth and video bandwidth of test receiver/spectrum analyzer is 9 kHz at frequency below 30 MHz.

For Radiated Emission above 30 MHz

- a. The EUT was placed on the top of a rotating table 0.8 meters (for 30 MHz ~ 1 GHz) / 1.5 meters (for above 1 GHz) above the ground at 3 meter chamber room for test. The table was rotated 360 degrees to determine the position of the highest radiation.
- b. The EUT was set 3 meters away from the interference-receiving antenna, which was mounted on the top of a variable-height antenna tower.
- c. The height of antenna is varied from one meter to four meters above the ground to determine the maximum value of the field strength. Both horizontal and vertical polarizations of the antenna are set to make the measurement.
- d. For each suspected emission, the EUT was arranged to its worst case and then the antenna was tuned to heights from 1 meter to 4 meters and the rotatable table was turned from 0 degrees to 360 degrees to find the maximum reading.
- e. The test-receiver system was set to quasi-peak detect function and specified bandwidth with maximum hold mode when the test frequency is below 1 GHz.
- f. The test-receiver system was set to peak and average detected function and specified bandwidth with maximum hold mode when the test frequency is above 1 GHz. If the peak reading value also meets average limit, measurement with the average detector is unnecessary.

Note:

1. The resolution bandwidth and video bandwidth of test receiver/spectrum analyzer is 120 kHz for Quasi-peak detection (QP) or Peak detection (PK) at frequency below 1 GHz.
2. The resolution bandwidth of test receiver/spectrum analyzer is 1 MHz and the video bandwidth is 3 MHz for Peak detection (PK) at frequency above 1 GHz.
3. The resolution bandwidth of test receiver/spectrum analyzer is 1 MHz and the video bandwidth is $\geq 1/T$ (Duty cycle < 98 %) or 10 Hz (Duty cycle ≥ 98 %) for Average detection (AV) at frequency above 1 GHz. (RBW = 1 MHz, VBW = 100 Hz)
4. All modes of operation were investigated and the worst-case emissions are reported.

4.1.4 Deviation from Test Standard

No deviation.

4.1.5 Test Set Up

<Radiated Emission below 30 MHz>

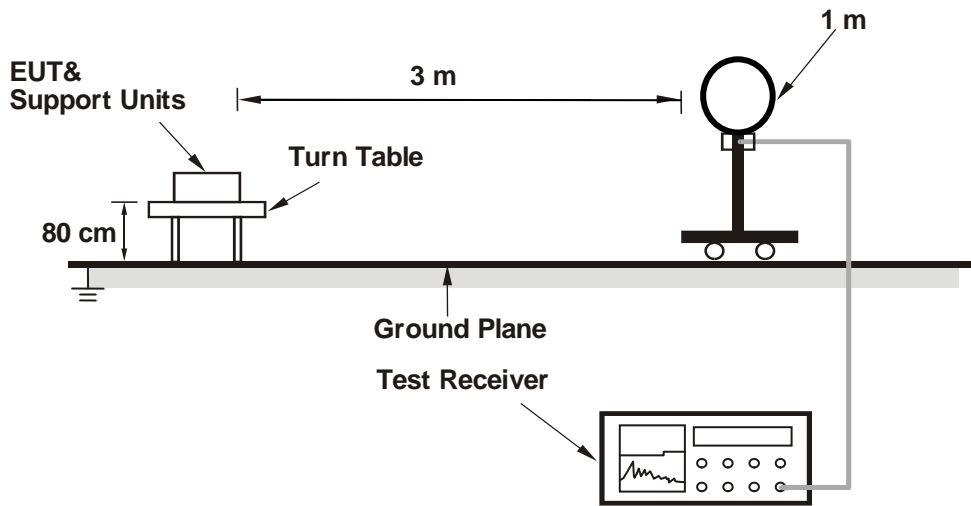

<Radiated Emission 30 MHz to 1 GHz>

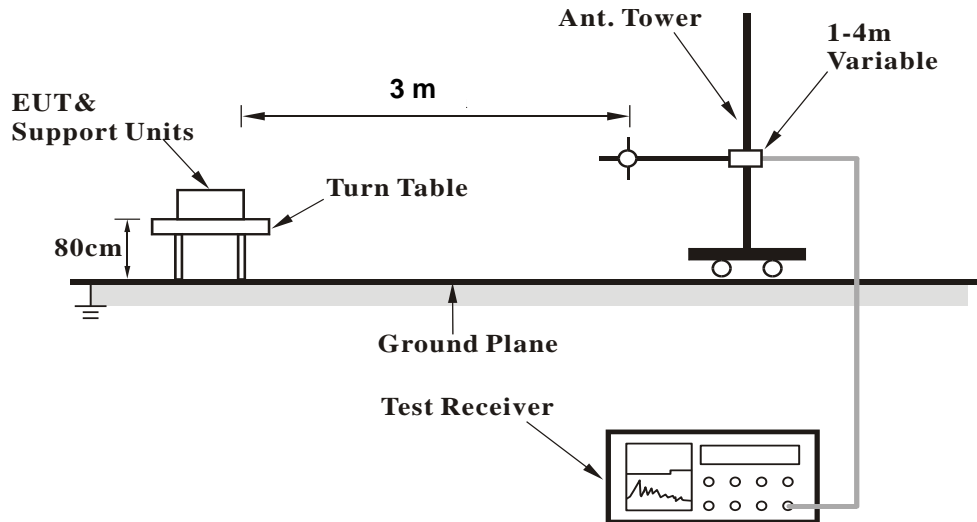

<Radiated Emission above 1 GHz>

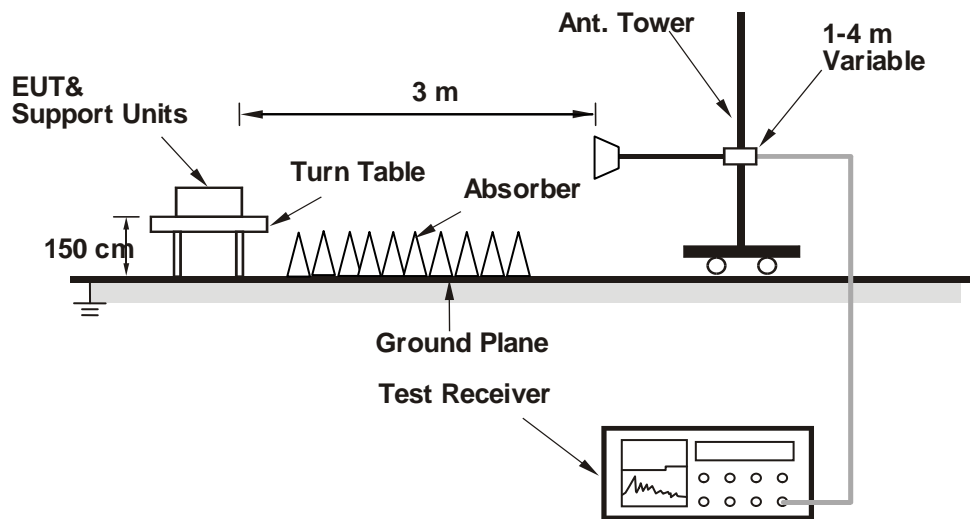

For the actual test configuration, please refer to the attached file (Test Setup Photo).

4.1.6 EUT Operating Conditions

Set the EUT under transmission condition continuously at specific channel frequency.

4.1.7 Test Results

 Above 1 GHz Data:
 GFSK

EUT Test Condition		Measurement Detail	
Channel	Channel 0	Frequency Range	1 GHz ~ 25 GHz
Input Power	120 Vac, 60 Hz	Detector Function	Peak (PK) Average (AV)
Environmental Conditions	25 deg. C, 65 % RH	Tested By	Charles Hsiao

Antenna Polarity & Test Distance: Horizontal at 3 m								
Frequency (MHz)	Emission Level (dBuV/m)	Read Level (dBuV)	Factor (dB/m)	Limit (dBuV/m)	Margin (dB)	Antenna Height (cm)	Table Angle (Degree)	Remark
2389.83	40.64	38.91	1.73	54	-13.36	234	232	Average
2389.83	52.87	51.14	1.73	74	-21.13	234	232	Peak
2402	105.1	103.37	1.73			234	232	Average
2402	107.18	105.45	1.73			234	232	Peak
9608	51.77	38.59	13.18	54	-2.23	100	72	Average
9608	59.38	46.2	13.18	74	-14.62	100	72	Peak

Antenna Polarity & Test Distance: Vertical at 3 m								
Frequency (MHz)	Emission Level (dBuV/m)	Read Level (dBuV)	Factor (dB/m)	Limit (dBuV/m)	Margin (dB)	Antenna Height (cm)	Table Angle (Degree)	Remark
2367.96	40.67	39.03	1.64	54	-13.33	117	68	Average
2367.96	51.84	50.2	1.64	74	-22.16	117	68	Peak
2402	104.52	102.79	1.73			117	68	Average
2402	106.69	104.96	1.73			117	68	Peak
9608	50.44	37.26	13.18	54	-3.56	101	100	Average
9608	58.35	45.17	13.18	74	-15.65	101	100	Peak

Remarks:

- Emission Level = Read Level + Factor
Margin value = Emission level – Limit value
- 2402 MHz: Fundamental frequency.
- The emission levels of other frequencies were very low against the limit.

EUT Test Condition		Measurement Detail	
Channel	Channel 39	Frequency Range	1 GHz ~ 25 GHz
Input Power	120 Vac, 60 Hz	Detector Function	Peak (PK) Average (AV)
Environmental Conditions	25 deg. C, 65 % RH	Tested By	Charles Hsiao

Antenna Polarity & Test Distance: Horizontal at 3 m								
Frequency (MHz)	Emission Level (dBuV/m)	Read Level (dBuV)	Factor (dB/m)	Limit (dBuV/m)	Margin (dB)	Antenna Height (cm)	Table Angle (Degree)	Remark
2385.6	40.46	38.75	1.71	54	-13.54	234	232	Average
2385.6	52.27	50.56	1.71	74	-21.73	234	232	Peak
2441	105.54	103.67	1.87			234	232	Average
2441	107.65	105.78	1.87			234	232	Peak
2498.44	41.16	39.14	2.02	54	-12.84	234	232	Average
2498.44	51.92	49.9	2.02	74	-22.08	234	232	Peak
4882	39.76	31.57	8.19	54	-14.24	140	185	Average
4882	46.6	38.41	8.19	74	-27.4	140	185	Peak

Antenna Polarity & Test Distance: Vertical at 3 m								
Frequency (MHz)	Emission Level (dBuV/m)	Read Level (dBuV)	Factor (dB/m)	Limit (dBuV/m)	Margin (dB)	Antenna Height (cm)	Table Angle (Degree)	Remark
2389.02	40.56	38.85	1.71	54	-13.44	117	68	Average
2389.02	52.6	50.89	1.71	74	-21.4	117	68	Peak
2441	103.24	101.37	1.87			117	68	Average
2441	105.53	103.66	1.87			117	68	Peak
2483.52	41.12	39.16	1.96	54	-12.88	117	68	Average
2483.52	52.42	50.46	1.96	74	-21.58	117	68	Peak
4882	39.86	31.67	8.19	54	-14.14	135	286	Average
4882	46.06	37.87	8.19	74	-27.94	135	286	Peak

Remarks:

- Emission Level = Read Level + Factor
Margin value = Emission level – Limit value
- 2441 MHz: Fundamental frequency.
- The emission levels of other frequencies were very low against the limit.

EUT Test Condition		Measurement Detail	
Channel	Channel 78	Frequency Range	1 GHz ~ 25 GHz
Input Power	120 Vac, 60 Hz	Detector Function	Peak (PK) Average (AV)
Environmental Conditions	25 deg. C, 65 % RH	Tested By	Charles Hsiao

Antenna Polarity & Test Distance: Horizontal at 3 m								
Frequency (MHz)	Emission Level (dBuV/m)	Read Level (dBuV)	Factor (dB/m)	Limit (dBuV/m)	Margin (dB)	Antenna Height (cm)	Table Angle (Degree)	Remark
2480	105.36	103.4	1.96			234	232	Average
2480	107.77	105.81	1.96			234	232	Peak
2483.64	41.51	39.55	1.96	54	-12.49	234	232	Average
2483.64	55.22	53.26	1.96	74	-18.78	234	232	Peak
4960	40.28	32.01	8.27	54	-13.72	103	28	Average
4960	46.03	37.76	8.27	74	-27.97	103	28	Peak
Antenna Polarity & Test Distance: Vertical at 3 m								
Frequency (MHz)	Emission Level (dBuV/m)	Read Level (dBuV)	Factor (dB/m)	Limit (dBuV/m)	Margin (dB)	Antenna Height (cm)	Table Angle (Degree)	Remark
2480	103.55	101.59	1.96			117	68	Average
2480	105.98	104.02	1.96			117	68	Peak
2490	41.22	39.21	2.01	54	-12.78	117	68	Average
2490	51.7	49.69	2.01	74	-22.3	117	68	Peak
4960	39.96	31.69	8.27	54	-14.04	122	299	Average
4960	46.82	38.55	8.27	74	-27.18	122	299	Peak

Remarks:

- Emission Level = Read Level + Factor
Margin value = Emission level – Limit value
- 2480 MHz: Fundamental frequency.
- The emission levels of other frequencies were very low against the limit.

8DPSK

EUT Test Condition		Measurement Detail	
Channel	Channel 0	Frequency Range	1 GHz ~ 25 GHz
Input Power	120 Vac, 60 Hz	Detector Function	Peak (PK) Average (AV)
Environmental Conditions	25 deg. C, 65 % RH	Tested By	Charles Hsiao

Antenna Polarity & Test Distance: Horizontal at 3 m								
Frequency (MHz)	Emission Level (dBuV/m)	Read Level (dBuV)	Factor (dB/m)	Limit (dBuV/m)	Margin (dB)	Antenna Height (cm)	Table Angle (Degree)	Remark
2387.31	40.67	38.96	1.71	54	-13.33	234	232	Average
2387.31	52.09	50.38	1.71	74	-21.91	234	232	Peak
2402	101.37	99.64	1.73			234	232	Average
2402	106.34	104.61	1.73			234	232	Peak
9608	46.19	33.01	13.18	54	-7.81	100	72	Average
9608	55.62	42.44	13.18	74	-18.38	100	72	Peak
Antenna Polarity & Test Distance: Vertical at 3 m								
Frequency (MHz)	Emission Level (dBuV/m)	Read Level (dBuV)	Factor (dB/m)	Limit (dBuV/m)	Margin (dB)	Antenna Height (cm)	Table Angle (Degree)	Remark
2387.22	40.81	39.1	1.71	54	-13.19	117	68	Average
2387.22	51.73	50.02	1.71	74	-22.27	117	68	Peak
2402	99.27	97.54	1.73			117	68	Average
2402	104.52	102.79	1.73			117	68	Peak
4804	39.35	31.26	8.09	54	-14.65	135	255	Average
4804	45.45	37.36	8.09	74	-28.55	135	255	Peak

Remarks:

- Emission Level = Read Level + Factor
Margin value = Emission level – Limit value
- 2402 MHz: Fundamental frequency.
- The emission levels of other frequencies were very low against the limit.

EUT Test Condition		Measurement Detail	
Channel	Channel 39	Frequency Range	1 GHz ~ 25 GHz
Input Power	120 Vac, 60 Hz	Detector Function	Peak (PK) Average (AV)
Environmental Conditions	25 deg. C, 65 % RH	Tested By	Charles Hsiao

Antenna Polarity & Test Distance: Horizontal at 3 m								
Frequency (MHz)	Emission Level (dBuV/m)	Read Level (dBuV)	Factor (dB/m)	Limit (dBuV/m)	Margin (dB)	Antenna Height (cm)	Table Angle (Degree)	Remark
2386.77	40.6	38.89	1.71	54	-13.4	234	232	Average
2386.77	51.95	50.24	1.71	74	-22.05	234	232	Peak
2441	101.86	99.99	1.87			234	232	Average
2441	106.71	104.84	1.87			234	232	Peak
2485.04	41.18	39.19	1.99	54	-12.82	234	232	Average
2485.04	52.76	50.77	1.99	74	-21.24	234	232	Peak
4882	39.73	31.54	8.19	54	-14.27	159	88	Average
4882	45.66	37.47	8.19	74	-28.34	159	88	Peak

Antenna Polarity & Test Distance: Vertical at 3 m								
Frequency (MHz)	Emission Level (dBuV/m)	Read Level (dBuV)	Factor (dB/m)	Limit (dBuV/m)	Margin (dB)	Antenna Height (cm)	Table Angle (Degree)	Remark
2366.34	40.56	38.92	1.64	54	-13.44	117	68	Average
2366.34	51.86	50.22	1.64	74	-22.14	117	68	Peak
2441	99.14	97.27	1.87			117	68	Average
2441	104.57	102.7	1.87			117	68	Peak
2486.16	41.2	39.21	1.99	54	-12.8	117	68	Average
2486.16	52.11	50.12	1.99	74	-21.89	117	68	Peak
4882	39.77	31.58	8.19	54	-14.23	154	202	Average
4882	45.02	36.83	8.19	74	-28.98	154	202	Peak

Remarks:

- Emission Level = Read Level + Factor
Margin value = Emission level – Limit value
- 2441 MHz: Fundamental frequency.
- The emission levels of other frequencies were very low against the limit.

EUT Test Condition		Measurement Detail	
Channel	Channel 78	Frequency Range	1 GHz ~ 25 GHz
Input Power	120 Vac, 60 Hz	Detector Function	Peak (PK) Average (AV)
Environmental Conditions	25 deg. C, 65 % RH	Tested By	Charles Hsiao

Antenna Polarity & Test Distance: Horizontal at 3 m								
Frequency (MHz)	Emission Level (dBuV/m)	Read Level (dBuV)	Factor (dB/m)	Limit (dBuV/m)	Margin (dB)	Antenna Height (cm)	Table Angle (Degree)	Remark
2480	101.78	64.4	37.38			234	232	Average
2480	106.68	69.3	37.38			234	232	Peak
2484.32	41.52	39.53	1.99	54	-12.48	234	232	Average
2484.32	52.42	50.43	1.99	74	-21.58	234	232	Peak
4960	39.28	31.01	8.27	54	-14.72	188	27	Average
4960	45.88	37.61	8.27	74	-28.12	188	27	Peak
Antenna Polarity & Test Distance: Vertical at 3 m								
Frequency (MHz)	Emission Level (dBuV/m)	Read Level (dBuV)	Factor (dB/m)	Limit (dBuV/m)	Margin (dB)	Antenna Height (cm)	Table Angle (Degree)	Remark
2480	99.85	97.89	1.96			117	68	Average
2480	104.55	102.59	1.96			117	68	Peak
2483.6	41.16	39.2	1.96	54	-12.84	117	68	Average
2483.6	52.1	50.14	1.96	74	-21.9	117	68	Peak
4960	39.53	31.26	8.27	54	-14.47	132	22	Average
4960	46.73	38.46	8.27	74	-27.27	132	22	Peak

Remarks:

- Emission Level = Read Level + Factor
Margin value = Emission level – Limit value
- 2480 MHz: Fundamental frequency.
- The emission levels of other frequencies were very low against the limit.

9 kHz ~ 30 MHz Data:

The amplitude of spurious emissions attenuated more than 20 dB below the permissible value is not required to be report.

30 MHz ~ 1 GHz Worst-Case Data:

EUT Test Condition		Measurement Detail	
Channel	Channel 0	Frequency Range	30 MHz ~ 1 GHz
Input Power	120 Vac, 60 Hz	Detector Function	Peak (PK) Quasi-peak (QP)
Environmental Conditions	25 deg. C, 65 % RH	Tested By	Charles Hsiao

Horizontal

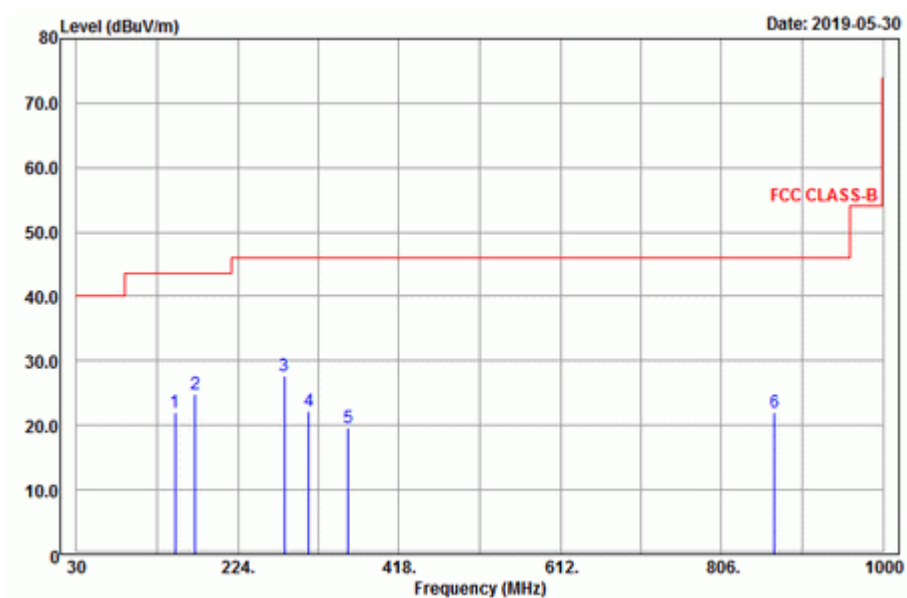

Vertical

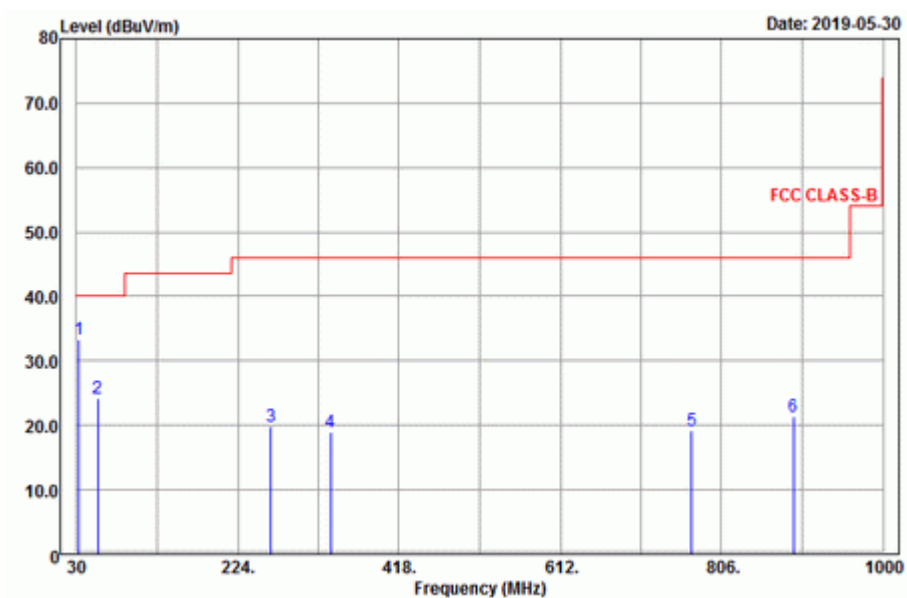

Antenna Polarity & Test Distance: Horizontal at 3 m

Frequency (MHz)	Emission Level (dBuV/m)	Read Level (dBuV)	Factor (dB/m)	Limit (dBuV/m)	Margin (dB)	Antenna Height (cm)	Table Angle (Degree)	Remark
148.53	21.92	44.28	-22.36	43.5	-21.58	148	153	Peak
172.56	24.92	46.38	-21.46	43.5	-18.58	105	163	Peak
280.02	27.67	45.02	-17.35	46	-18.33	127	176	Peak
309.8	22.23	38.97	-16.74	46	-23.77	124	309	Peak
356.7	19.69	35.21	-15.52	46	-26.31	143	19	Peak
869.8	22.02	29.01	-6.99	46	-23.98	186	298	Peak

Antenna Polarity & Test Distance: Vertical at 3 m

Frequency (MHz)	Emission Level (dBuV/m)	Read Level (dBuV)	Factor (dB/m)	Limit (dBuV/m)	Margin (dB)	Antenna Height (cm)	Table Angle (Degree)	Remark
33.24	33.4	53.17	-19.77	40	-6.6	124	177	Peak
55.92	24.21	41.55	-17.34	40	-15.79	136	285	Peak
264.36	19.81	37.42	-17.61	46	-26.19	110	27	Peak
335.7	18.93	34.89	-15.96	46	-27.07	199	205	Peak
770.4	19.16	27.98	-8.82	46	-26.84	104	177	Peak
892.2	21.46	28.09	-6.63	46	-24.54	136	163	Peak

Remarks:

- Emission Level = Read Level + Factor
Margin value = Emission level – Limit value
- The emission levels of other frequencies were very low against the limit.

4.2 Conducted Emission Measurement

4.2.1 Limits of Conducted Emission Measurement

Frequency (MHz)	Conducted Limit (dBuV)	
	Quasi-Peak	Average
0.15 - 0.5	66 - 56	56 - 46
0.50 - 5.0	56	46
5.0 - 30.0	60	50

- Note: 1. The lower limit shall apply at the transition frequencies.
 2. The limit decreases in line with the logarithm of the frequency in the range of 0.15 to 0.50 MHz.

4.2.2 Test Instruments

Description & Manufacturer	Model No.	Serial No.	Date of Calibration	Due Date of Calibration
Test Receiver ROHDE & SCHWARZ	ESCI	100613	Dec. 10, 2018	Dec. 09, 2019
RF signal cable Woken	5D-FB	Cable-cond1-01	Sep. 05, 2018	Sep. 04, 2019
LISN/AMN ROHDE & SCHWARZ (EUT)	ENV216	101826	Feb. 21, 2019	Feb. 20, 2020
LISN/AMN ROHDE & SCHWARZ (Peripheral)	ESH3-Z5	100311	Aug. 19, 2018	Aug. 18, 2019
Software ADT	BV ADT_Cond_ V7.3.7.4	NA	NA	NA

- Note: 1. The calibration interval of the above test instruments is 12 months and the calibrations are traceable to NML/ROC and NIST/USA.
 2. The test was performed in HwaYa Shielded Room 1.
 3. The VCCI Site Registration No. is C-12040.

4.2.3 Test Procedures

- a. The EUT was placed 0.4 meters from the conducting wall of the shielded room with EUT being connected to the power mains through a line impedance stabilization network (LISN). Other support units were connected to the power mains through another LISN. The two LISNs provide 50 ohm/ 50 uH of coupling impedance for the measuring instrument.
- b. Both lines of the power mains connected to the EUT were checked for maximum conducted interference.
- c. The frequency range from 150 kHz to 30 MHz was searched. Emission levels under (Limit – 20 dB) was not recorded.

Note: The resolution bandwidth and video bandwidth of test receiver is 9 kHz for quasi-peak detection (QP) and average detection (AV) at frequency 0.15 MHz - 30 MHz.

4.2.4 Deviation from Test Standard

No deviation.

4.2.5 Test Setup

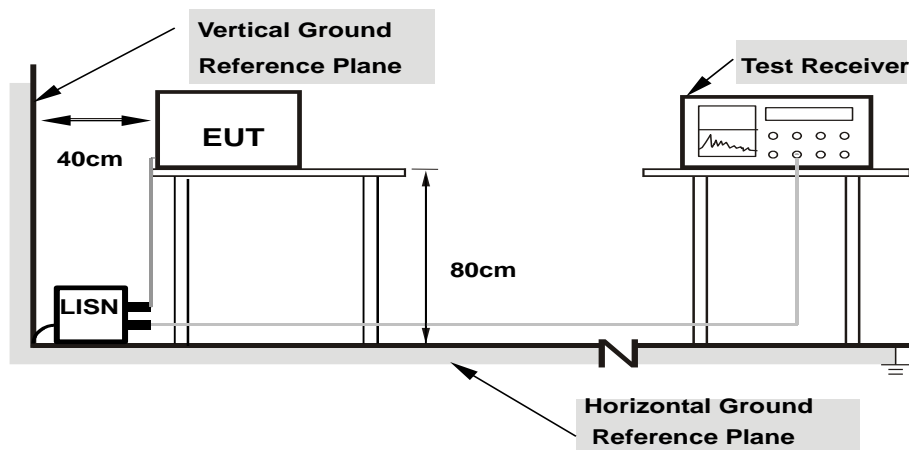

- Note:**
1. Support units were connected to second LISN.
 2. Both of LISNs (AMN) are 80 cm from EUT and at least 80 cm from other units and other metal planes

For the actual test configuration, please refer to the attached file (Test Setup Photo).

4.2.6 EUT Operating Condition

Set the EUT under transmission condition continuously at specific channel frequency.

4.2.7 Test Results

CONDUCTED WORST-CASE DATA : GFSK

Frequency Range	150kHz ~ 30MHz	Detector Function & Resolution Bandwidth	Quasi-Peak (QP) / Average (AV), 9kHz
Input Power	120Vac, 60Hz	Environmental Conditions	25°C, 65%RH
Tested by	Thomas Wei	Test Date	2019/5/25

Phase Of Power : Line (L)										
No	Frequency (MHz)	Correction Factor (dB)	Reading Value (dBuV)		Emission Level (dBuV)		Limit (dBuV)		Margin (dB)	
			Q.P.	AV.	Q.P.	AV.	Q.P.	AV.	Q.P.	AV.
1	0.15391	9.84	34.81	21.11	44.65	30.95	65.79	55.79	-21.14	-24.84
2	0.17737	9.85	35.50	17.73	45.35	27.58	64.61	54.61	-19.26	-27.03
3	0.21282	9.85	31.40	13.42	41.25	23.27	63.09	53.09	-21.84	-29.82
4	0.31813	9.87	26.01	10.12	35.88	19.99	59.76	49.76	-23.88	-29.77
5	0.66605	9.90	22.53	11.89	32.43	21.79	56.00	46.00	-23.57	-24.21
6	17.39701	10.23	16.33	5.16	26.56	15.39	60.00	50.00	-33.44	-34.61

Remarks:

1. Q.P. and AV. are abbreviations of quasi-peak and average individually.
2. The emission levels of other frequencies were very low against the limit.
3. Margin value = Emission level – Limit value
4. Correction factor = Insertion loss + Cable loss
5. Emission Level = Correction Factor + Reading Value

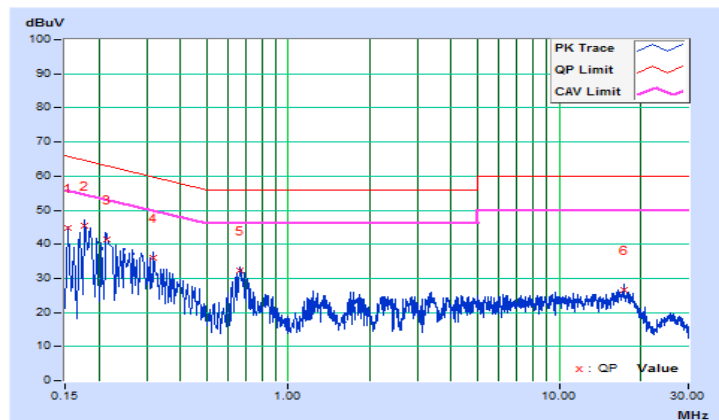

Frequency Range	150kHz ~ 30MHz	Detector Function & Resolution Bandwidth	Quasi-Peak (QP) / Average (AV), 9kHz
Input Power	120Vac, 60Hz	Environmental Conditions	25°C, 65%RH
Tested by	Thomas Wei	Test Date	2019/5/25

Phase Of Power : Neutral (N)										
No	Frequency (MHz)	Correction Factor (dB)	Reading Value (dBuV)		Emission Level (dBuV)		Limit (dBuV)		Margin (dB)	
			Q.P.	AV.	Q.P.	AV.	Q.P.	AV.	Q.P.	AV.
1	0.17374	9.83	31.33	14.58	41.16	24.41	64.78	54.78	-23.62	-30.37
2	0.21282	9.84	27.85	12.01	37.69	21.85	63.09	53.09	-25.40	-31.24
3	0.24407	9.85	26.37	8.29	36.22	18.14	61.96	51.96	-25.74	-33.82
4	0.29858	9.85	23.23	8.15	33.08	18.00	60.28	50.28	-27.20	-32.28
5	0.36048	9.86	20.31	6.37	30.17	16.23	58.72	48.72	-28.55	-32.49
6	0.66612	9.87	19.84	5.63	29.71	15.50	56.00	46.00	-26.29	-30.50

Remarks:

1. Q.P. and AV. are abbreviations of quasi-peak and average individually.
2. The emission levels of other frequencies were very low against the limit.
3. Margin value = Emission level – Limit value
4. Correction factor = Insertion loss + Cable loss
5. Emission Level = Correction Factor + Reading Value

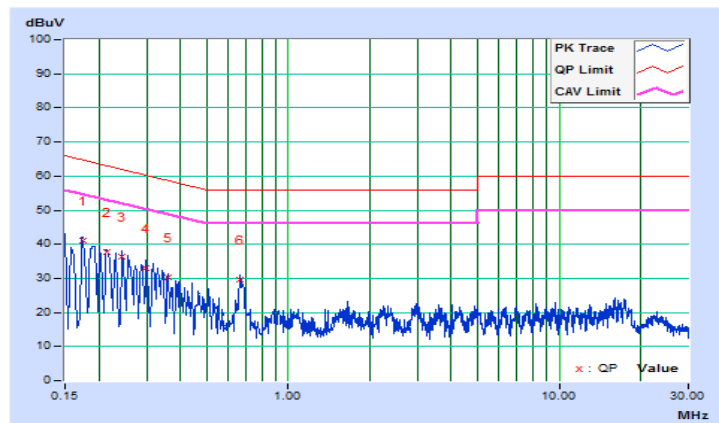

4.3 Number of Hopping Frequency Used

4.3.1 Limits of Hopping Frequency Used Measurement

At least 15 channels frequencies, and should be equally spaced.

4.3.2 Test Setup

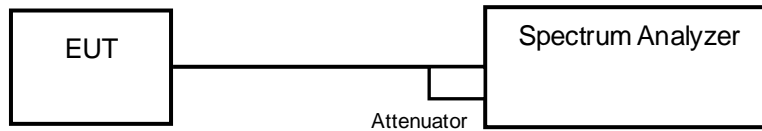

4.3.3 Test Instruments

Refer to section 4.1.2 to get information of above instrument.

4.3.4 Test Procedure

- a. Check the calibration of the measuring instrument (SA) using either an internal calibrator or a known signal from an external generator.
- b. Turn on the EUT and connect its antenna terminal to measurement via a low loss cable. Then set it to any one measured frequency within its operating range and make sure the instrument is operated in its linear range.
- c. Set the SA on MaxHold Mode, and then keep the EUT in hopping mode. Record all the signals from each channel until each one has been recorded.
- d. Set the SA on View mode and then plot the result on SA screen.
- e. Repeat above procedures until all frequencies measured were complete.

4.3.5 Deviation from Test Standard

No deviation.

4.3.6 Test Results

There are 79 hopping frequencies in the hopping mode. Please refer to next page for the test result. On the plots, it shows that the hopping frequencies are equally spaced.

<GFSK>

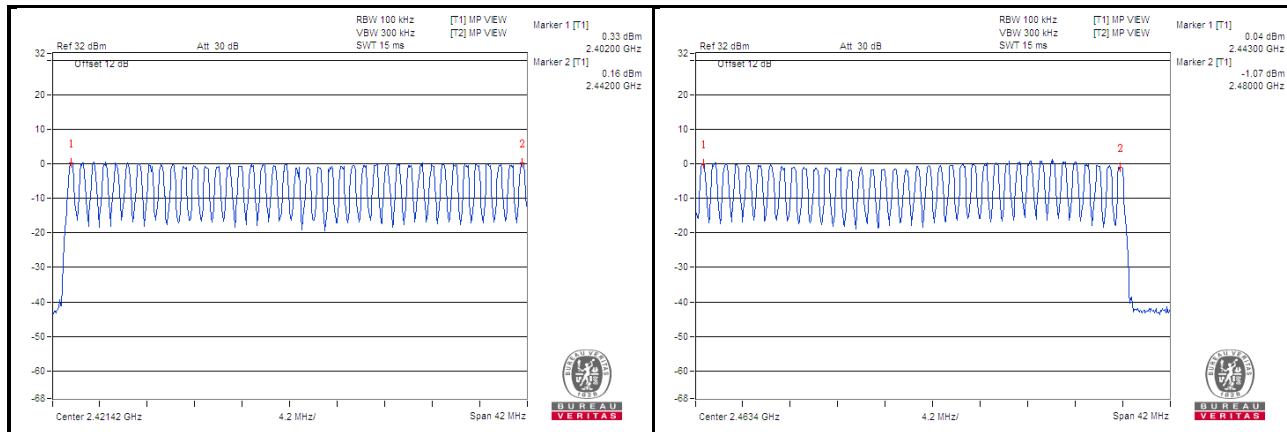

<8DPSK>

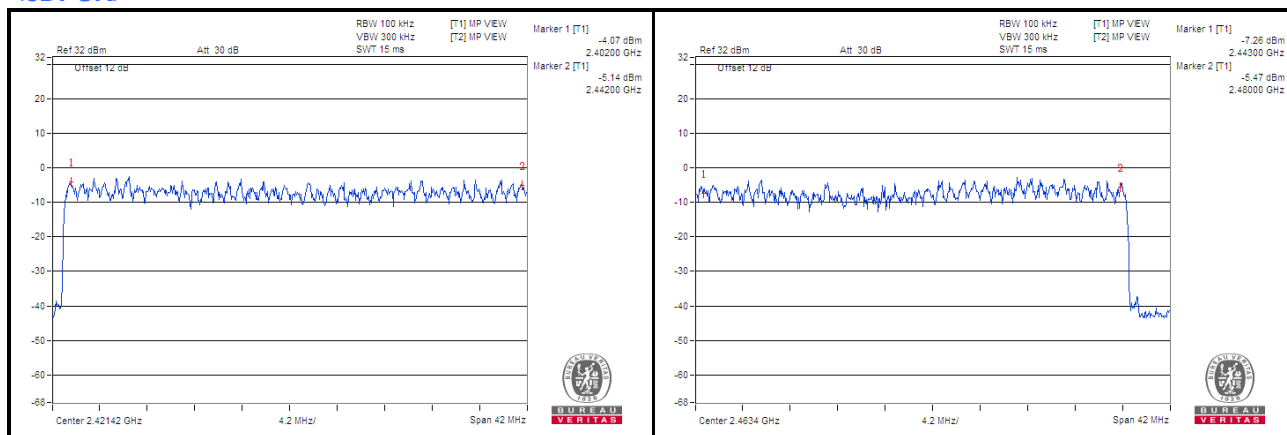

4.4 Dwell Time on Each Channel

4.4.1 Limits of Dwell Time on Each Channel Measurement

The average time of occupancy on any channel shall not be greater than 0.4 seconds within a period of 0.4 seconds multiplied by the number of hopping channels employed.

4.4.2 Test Setup

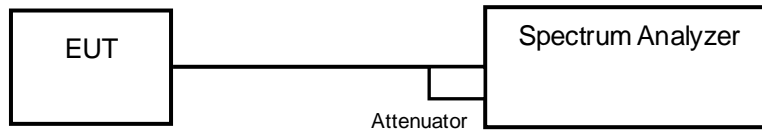

4.4.3 Test Instruments

Refer to section 4.1.2 to get information of above instrument.

4.4.4 Test Procedures

- a. Check the calibration of the measuring instrument (SA) using either an internal calibrator or a known signal from an external generator.
- b. Turn on the EUT and connect its antenna terminal to measurement via a low loss cable. Then set it to any one measured frequency within its operating range and make sure the instrument is operated in its linear range.
- c. Adjust the center frequency of SA on any frequency be measured and set SA to zero span mode. And then, set RBW and VBW of spectrum analyzer to proper value.
- d. Measure the time duration of one transmission on the measured frequency. And then plot the result with time difference of this time duration.
- e. Repeat above procedures until all different time-slot modes have been completed.

4.4.5 Deviation from Test Standard

No deviation.

4.4.6 Test Results

GFSK

Mode	Number of Transmission in a 31.6 (79 Hopping*0.4)	Length of Transmission Time (msec)	Result (msec)	Limit (msec)
DH1	50 (times / 5 sec) * 6.32 = 316 times	0.438	138.4	400
DH3	27 (times / 5 sec) * 6.32 = 170.64 times	1.698	289.7	400
DH5	17 (times / 5 sec) * 6.32 = 107.44 times	2.924	314.2	400

Note: Test plots of the transmitting time slot are shown as below.



8DPSK

Mode	Number of Transmission in a 31.6 (79 Hopping*0.4)	Length of Transmission Time (msec)	Result (msec)	Limit (msec)
3DH1	50 (times / 5 sec) * 6.32 = 316 times	0.426	134.6	400
3DH3	26 (times / 5 sec) * 6.32 = 164.32 times	1.78	292.5	400
3DH5	18 (times / 5 sec) * 6.32 = 113.76 times	2.97	337.9	400

Note: Test plots of the transmitting time slot are shown as below.

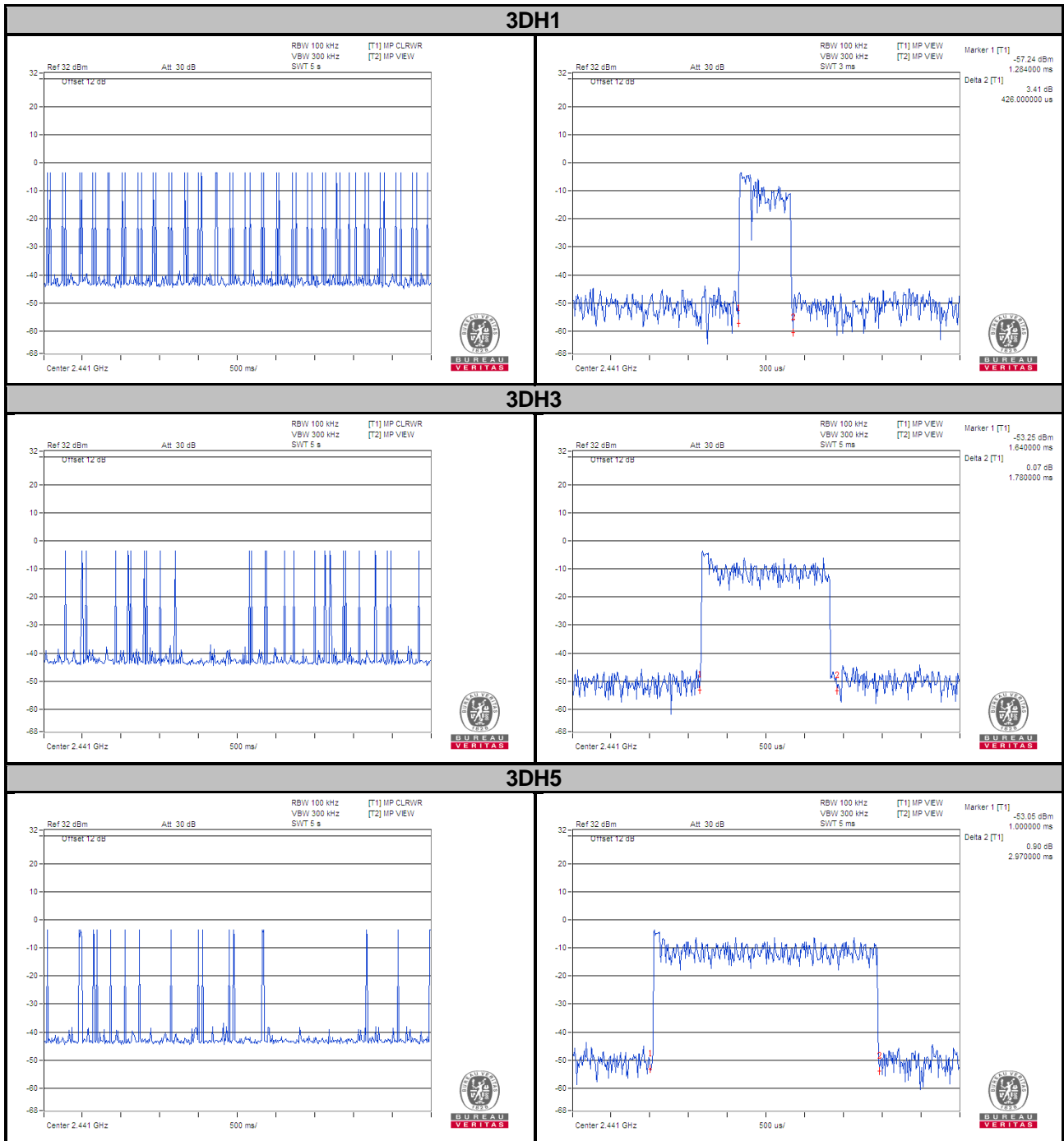

4.5 Channel Bandwidth

4.5.1 Limits of Channel Bandwidth Measurement

For frequency hopping system operating in the 2400-2483.5 MHz, if the 20 dB bandwidth of hopping channel is greater than 25 kHz, two-thirds 20 dB bandwidth of hopping channel shall be a minimum limit for the hopping channel separation.

4.5.2 Test Setup

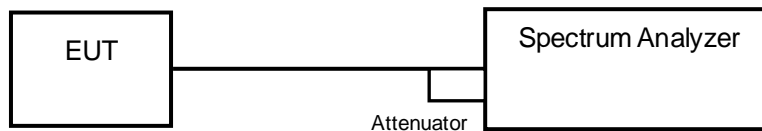

4.5.3 Test Instruments

Refer to section 4.1.2 to get information of above instrument.

4.5.4 Test Procedure

- Check the calibration of the measuring instrument using either an internal calibrator or a known signal from an external generator.
- Turn on the EUT and connect it to measurement instrument. Then set it to any one convenient frequency within its operating range. Set a reference level on the measuring instrument equal to the highest peak value.
- Measure the frequency difference of two frequencies that were attenuated 20 dB from the reference level. Record the frequency difference as the emission bandwidth.
- Repeat above procedures until all frequencies measured were complete.

4.5.5 Deviation from Test Standard

No deviation.

4.5.6 EUT Operating Condition

The software provided by client enabled the EUT to transmit and receive data at lowest, middle and highest channel frequencies individually.

4.5.7 Test Results

Channel	Frequency (MHz)	20 dB Bandwidth (MHz)	
		GFSK	8DPSK
0	2402	0.94	1.29
39	2441	0.95	1.29
78	2480	0.95	1.29

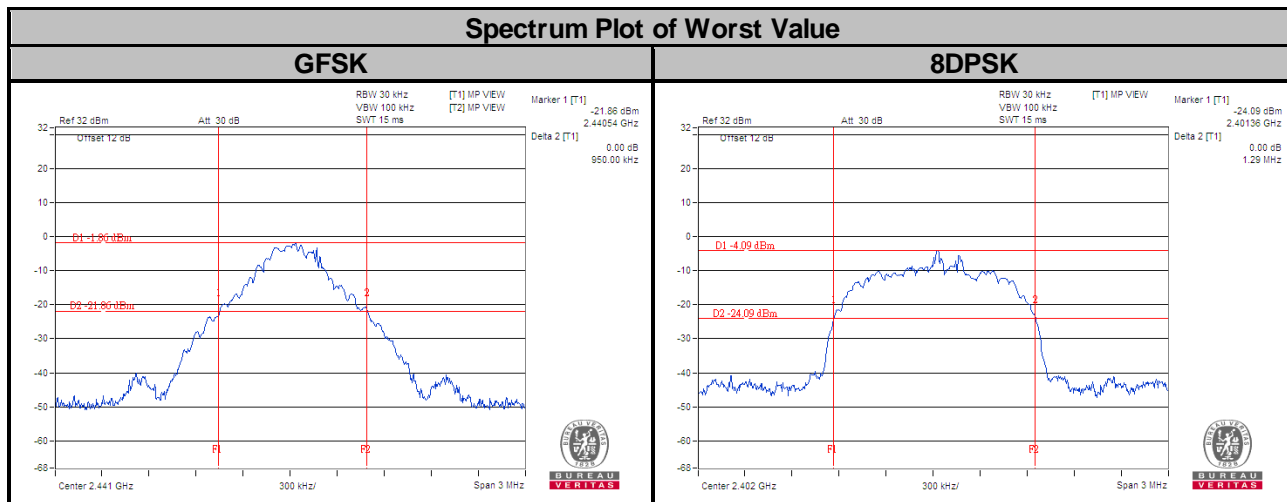

4.6 Occupied Bandwidth Measurement

4.6.1 Test Setup

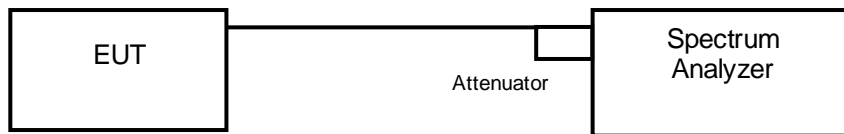

4.6.2 Test Instruments

Refer to section 4.1.2 to get information of above instrument

4.6.3 Test Procedure

The transmitter output was connected to the spectrum analyzer through an attenuator. The bandwidth of the fundamental frequency was measured by spectrum analyzer with resolution bandwidth in the range of 1 % to 5 % of the anticipated emission bandwidth, and a video bandwidth at least 3x the resolution bandwidth and set the detector to PEAK. The width of a frequency band such that, below the lower and above the upper frequency limits, the mean powers emitted are each equal to a specified percentage 0.5 % of the total mean power of a given emission.

4.6.4 Deviation from Test Standard

No deviation.

4.6.5 EUT Operating Conditions

The software provided by client to enable the EUT under transmission condition continuously at lowest, middle and highest channel frequencies individually.

4.6.6 Test Results

Channel	Frequency (MHz)	Occupied Bandwidth (MHz)	
		GFSK	8DPSK
0	2402	0.85	1.19
39	2441	0.86	1.18
78	2480	0.85	1.18

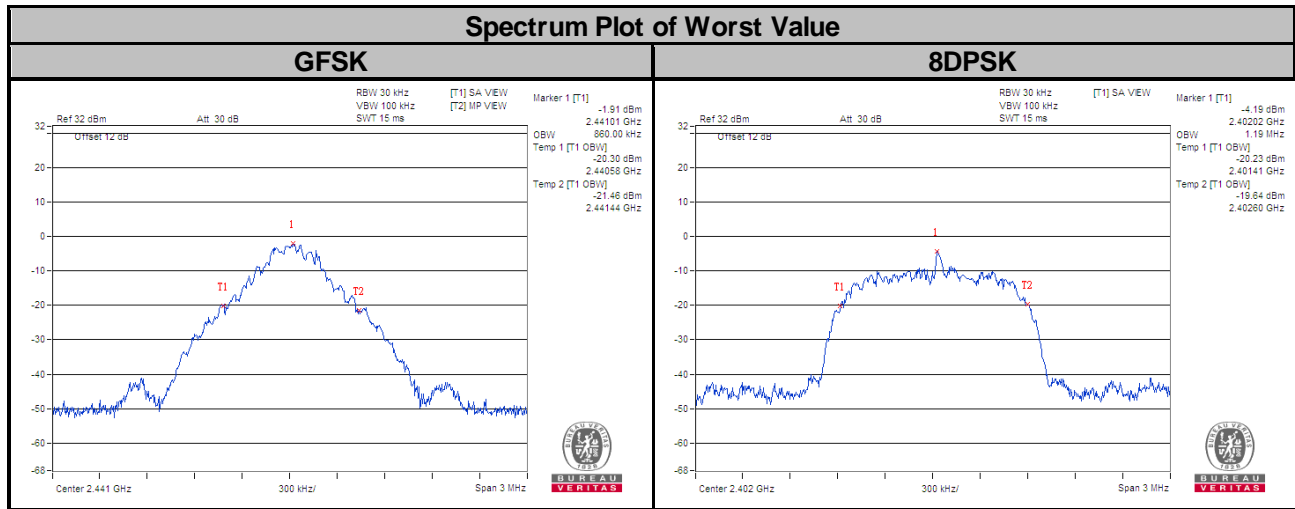

4.7 Hopping Channel Separation

4.7.1 Limits of Hopping Channel Separation Measurement

At least 25 kHz or two-third of 20 dB hopping channel bandwidth (whichever is greater).

4.7.2 Test Setup

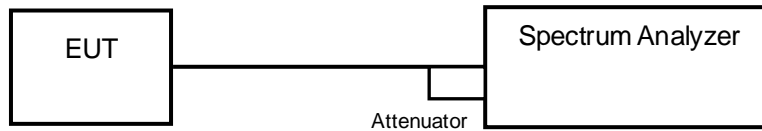

4.7.3 Test Instruments

Refer to section 4.1.2 to get information of above instrument.

4.7.4 Test Procedure

Measurement Procedure REF

- Check the calibration of the measuring instrument using either an internal calibrator or a known signal from an external generator.
- Turn on the EUT and connect it to measurement instrument. Then set it to any one convenient frequency within its operating range.
- By using the MaxHold function record the separation of two adjacent channels.
- Measure the frequency difference of these two adjacent channels by SA MARK function. And then plot the result on SA screen.
- Repeat above procedures until all frequencies measured were complete.

4.7.5 Deviation from Test Standard

No deviation.

4.7.6 Test Results

Channel	Freq. (MHz)	Adjacent Channel Separation (MHz)		20 dB Bandwidth (MHz)		Minimum Limit (MHz)		Pass / Fail
		GFSK	8DPSK	GFSK	8DPSK	GFSK	8DPSK	
0	2402	1.00	1.00	0.94	1.29	0.63	0.86	Pass
39	2441	1.00	1.00	0.95	1.29	0.64	0.86	Pass
78	2480	1.00	1.00	0.95	1.29	0.64	0.86	Pass

Note:

- The minimum limit is two-third 20 dB bandwidth.

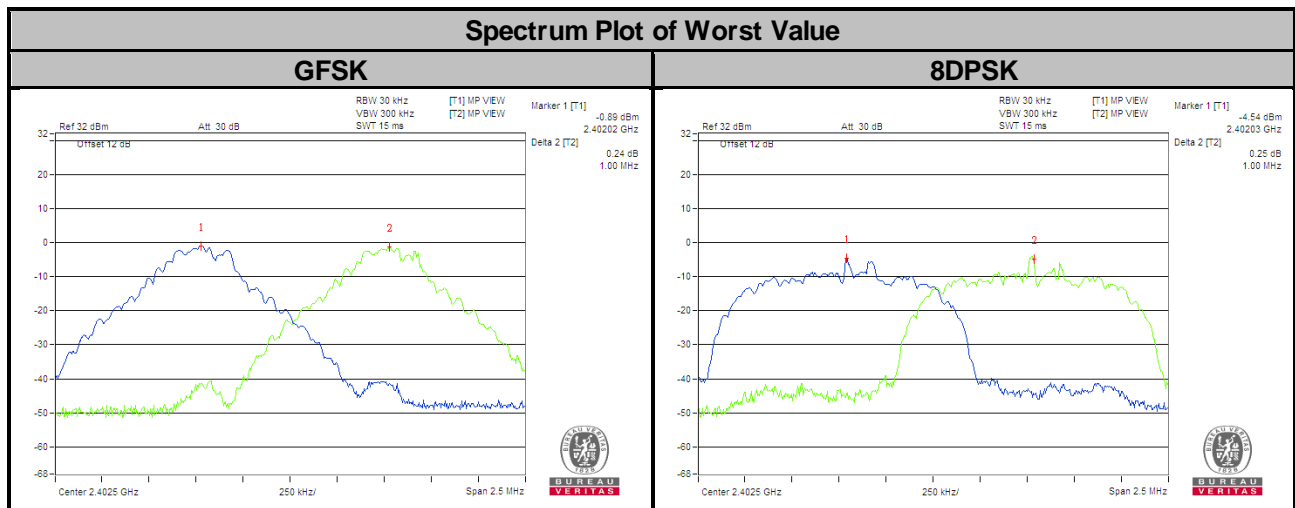

4.8 Maximum Output Power

4.8.1 Limits of Maximum Output Power Measurement

Refer to Regulation 15.247 (a)(1), the Maximum Output Power Measurement is 125 mW.

4.8.2 Test Setup

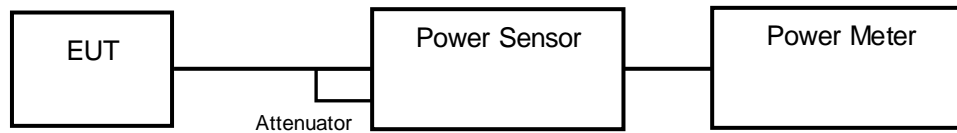

4.8.3 Test Instruments

Refer to section 4.1.2 to get information of above instrument.

4.8.4 Test Procedure

A peak power sensor was used on the output port of the EUT. A power meter was used to read the response of the peak power sensor. Record the power level.

4.8.5 Deviation from Test Standard

No deviation.

4.8.6 EUT Operating Condition

The software provided by client enabled the EUT to transmit and receive data at lowest, middle and highest channel frequencies individually.

4.8.7 Test Results

<GFSK>

Channel	Freq. (MHz)	Peak Power (mW)	Peak Power (dBm)	Power Limit (mW)	Pass / Fail
0	2402	1.225	0.88	125	Pass
39	2441	1.009	0.04	125	Pass
78	2480	0.8892	-0.51	125	Pass

<8DPSK>

Channel	Freq. (MHz)	Peak Power (mW)	Peak Power (dBm)	Power Limit (mW)	Pass / Fail
0	2402	1.112	0.46	125	Pass
39	2441	0.8851	-0.53	125	Pass
78	2480	0.7889	-1.03	125	Pass

4.9 Conducted Out of Band Emission Measurement

4.9.1 Limits Of Conducted Out of Band Emission Measurement

Below -20 dB of the highest emission level of operating band (in 100 kHz RBW).

4.9.2 Test Instruments

Refer to section 4.1.2 to get information of above instrument.

4.9.3 Test Procedure

The transmitter output was connected to the spectrum analyzer via a low lose cable. Set both RBW and VBW of spectrum analyzer to 100 kHz and 300 kHz with suitable frequency span including 100 MHz bandwidth from band edge. The band edges was measured and recorded.

4.9.4 Deviation from Test Standard

No deviation.

4.9.5 EUT Operating Condition

The software provided by client enabled the EUT to transmit and receive data at lowest, middle and highest channel frequencies individually.

4.9.6 Test Results

The spectrum plots are attached on the following images. D1 line indicates the highest level, D2 line indicates the 20 dB offset below D1. It shows compliance with the requirement.

GFSK

Hopping Disabled_Low Channel

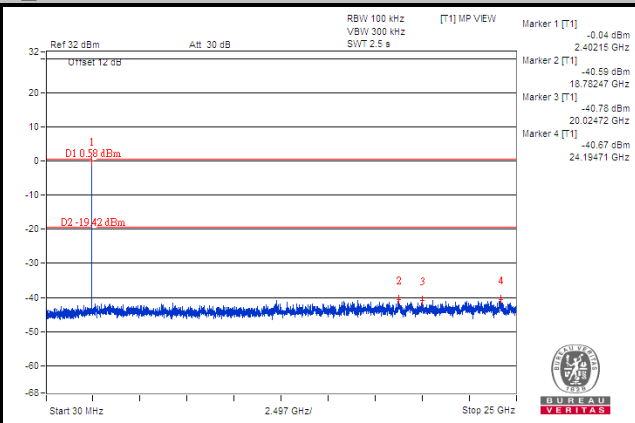
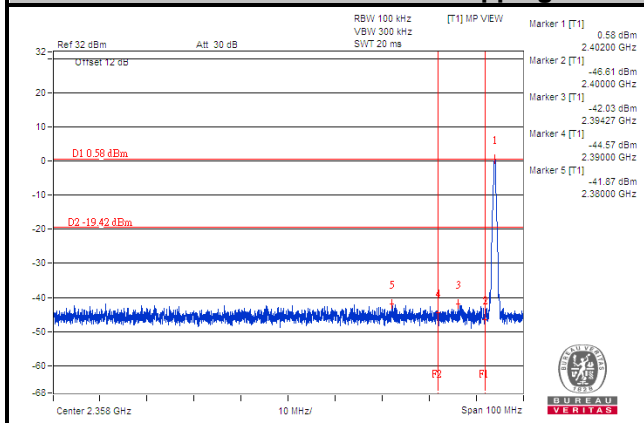

Hopping Disabled_Middle Channel

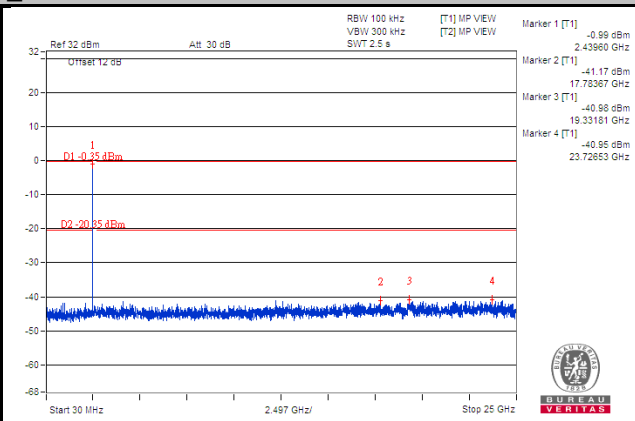
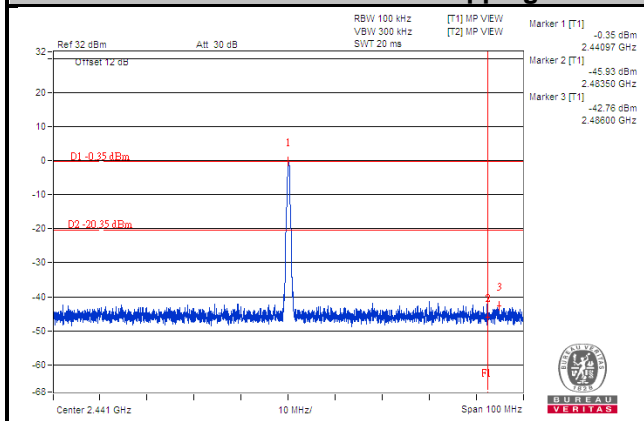

Hopping Disabled_High Channel

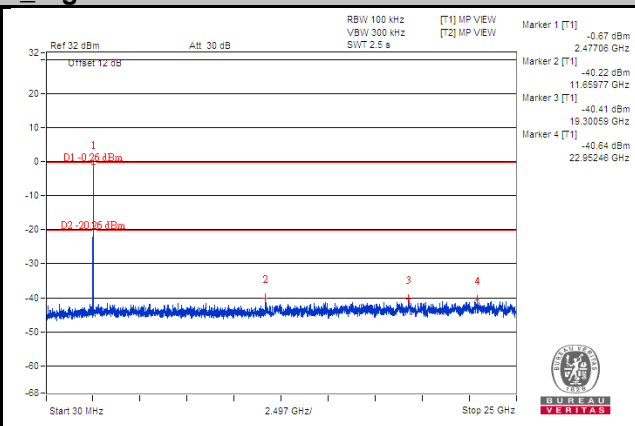
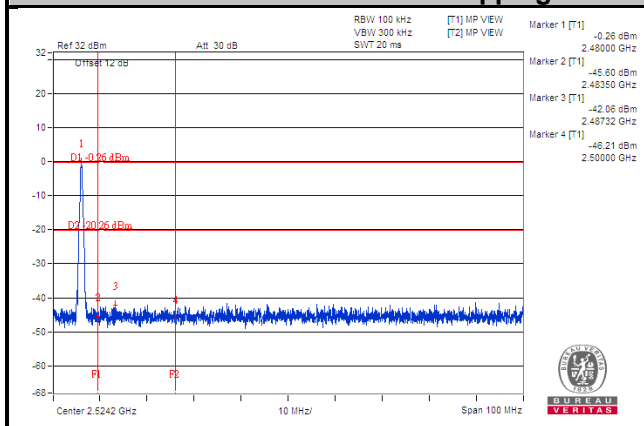

Hopping Enabled_Low Channel

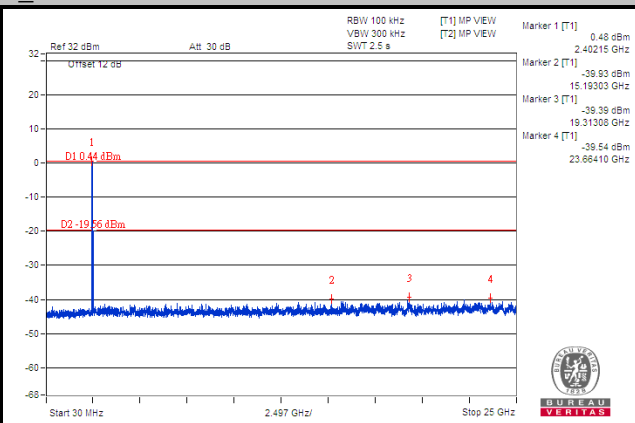
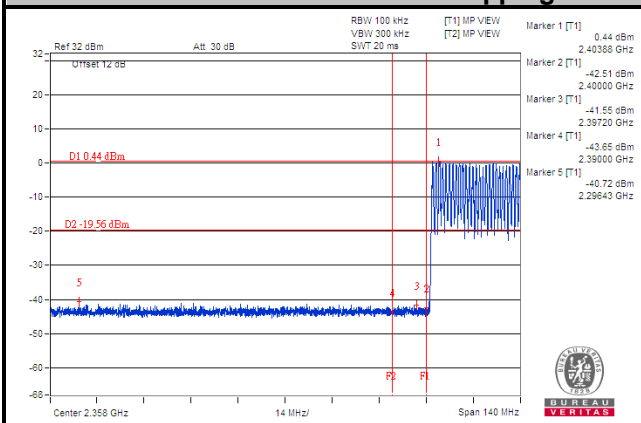

Hopping Enabled_High Channel

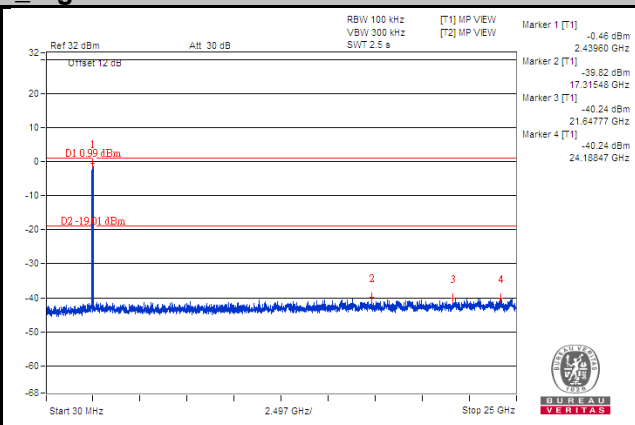
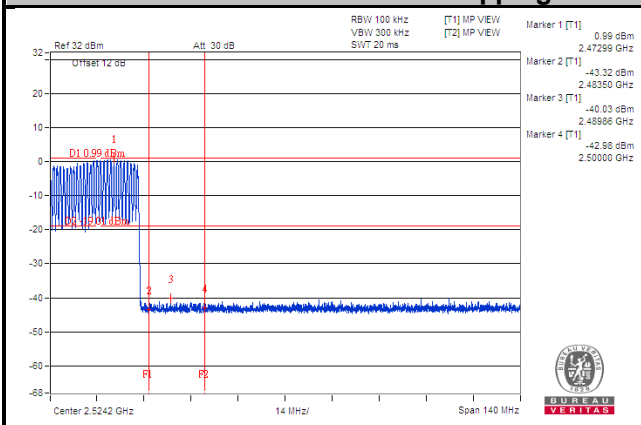

8DPSK

Hopping Disabled_Low Channel

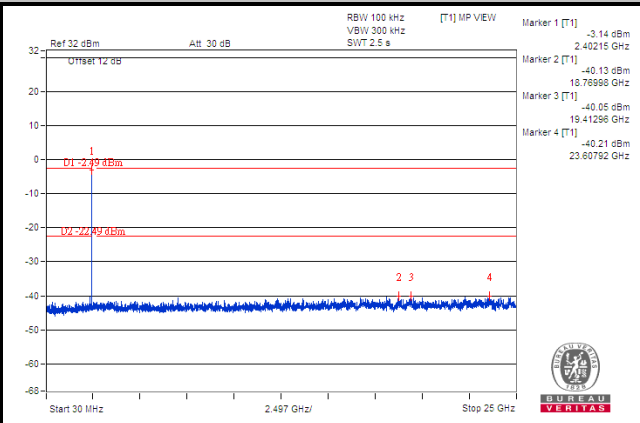
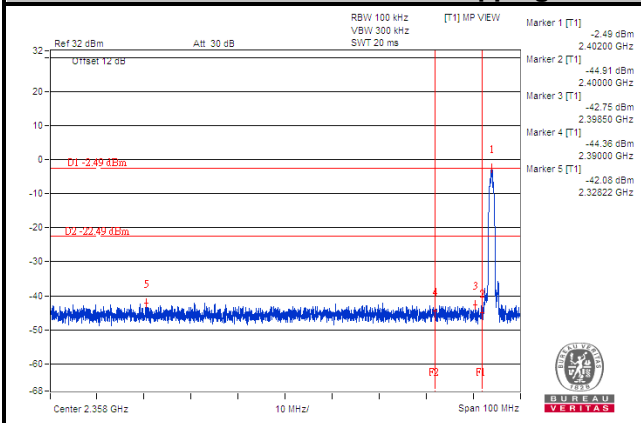

Hopping Disabled_Middle Channel

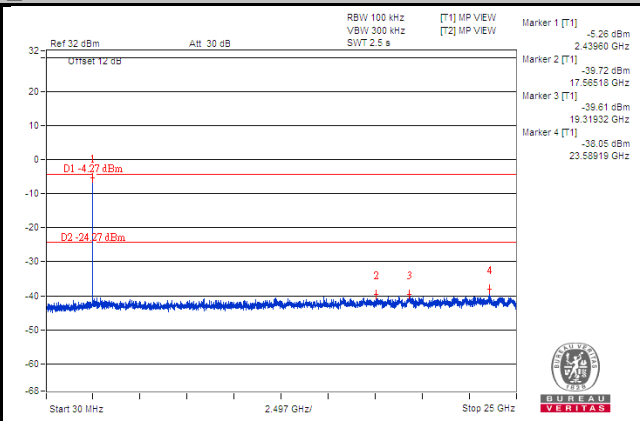
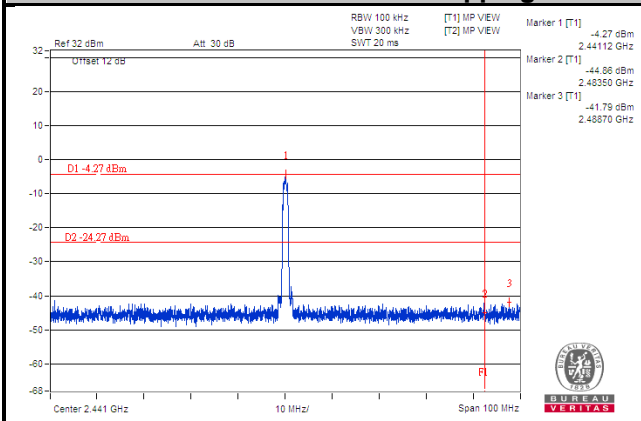

Hopping Disabled_High Channel

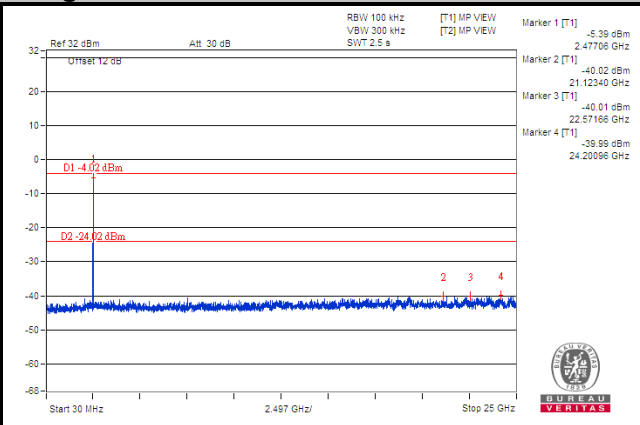
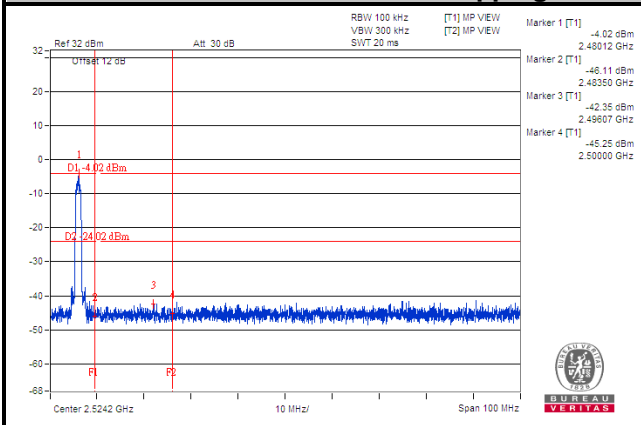

Hopping Enabled_Low Channel

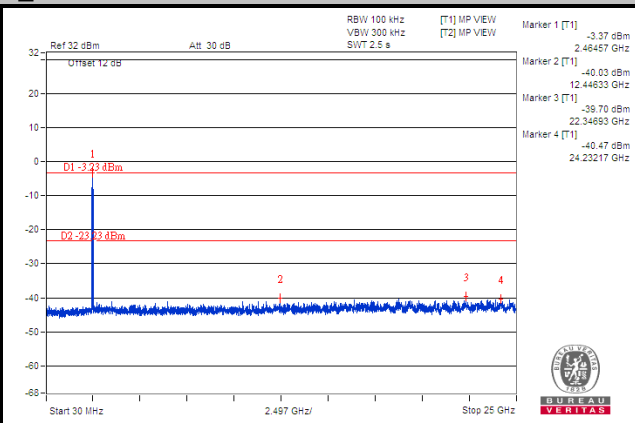
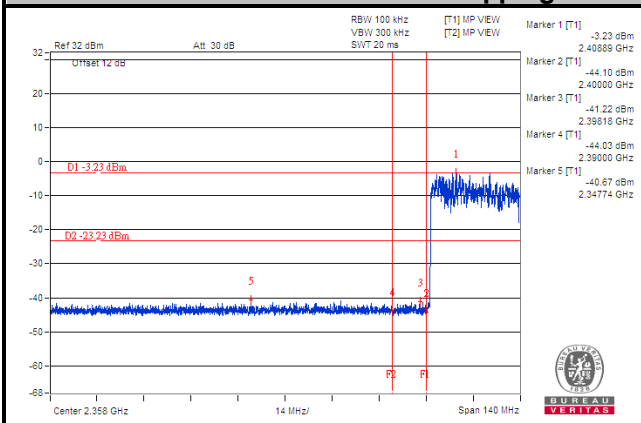

Hopping Enabled_High Channel

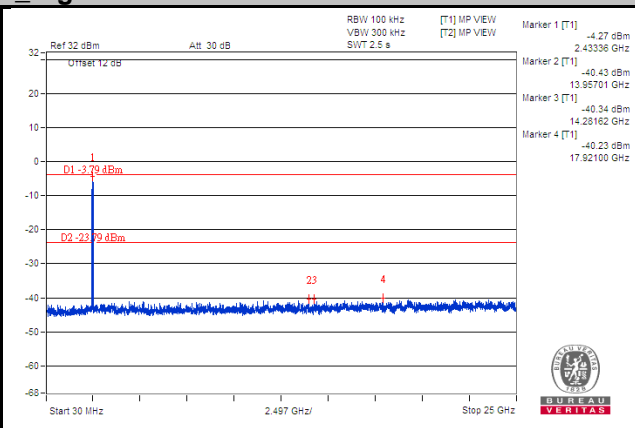
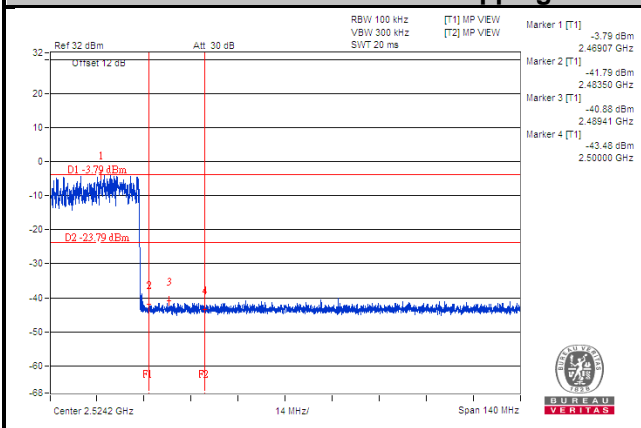

5 Pictures of Test Arrangements

Please refer to the attached file (Test Setup Photo).

Appendix – Information of the Testing Laboratories

We, Bureau Veritas Consumer Products Services (H.K.) Ltd., Taoyuan Branch, were founded in 1988 to provide our best service in EMC, Radio, Telecom and Safety consultation. Our laboratories are FCC recognized accredited test firms and accredited according to ISO/IEC 17025.

If you have any comments, please feel free to contact us at the following:

Lin Kou EMC/RF Lab

Tel: 886-2-26052180

Fax: 886-2-26051924

Hsin Chu EMC/RF/Telecom Lab

Tel: 886-3-6668565

Fax: 886-3-6668323

Hwa Ya EMC/RF/Safety Lab

Tel: 886-3-3183232

Fax: 886-3-3270892

Email: service.adt@tw.bureauveritas.com

Web Site: www.bureauveritas-adt.com

The address and road map of all our labs can be found in our web site also.

--- END ---