

# MINI H2O 3

RUGGED BLUETOOTH SPEAKER

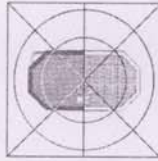

## Quick Start Guide

Item # IMW258



### 1. What's Included

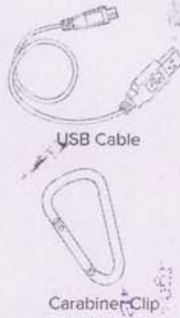
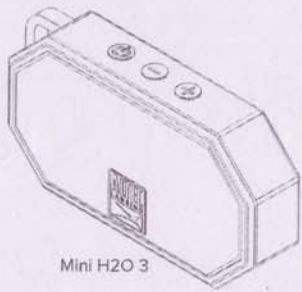

### 2. A Closer Look

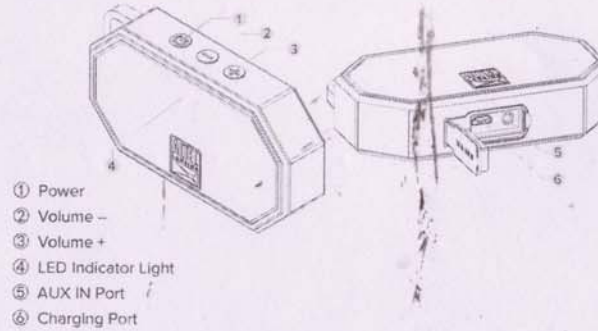

### 3. Charging

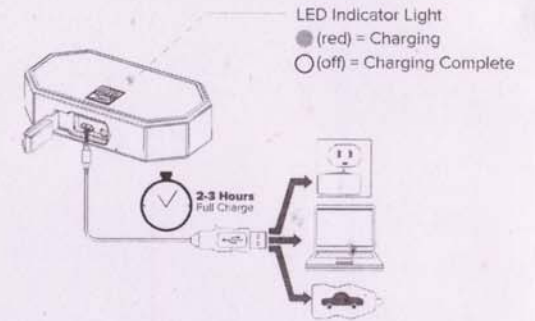

### 4. Bluetooth Pairing

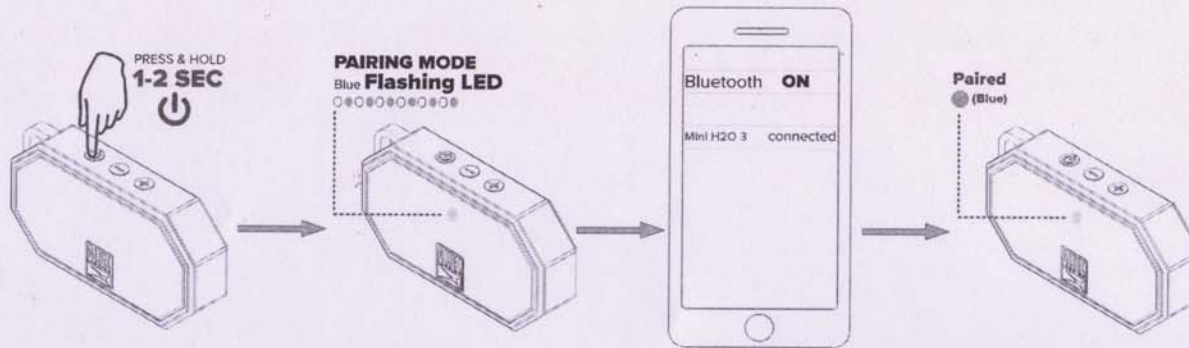

### 5. Listening to Music

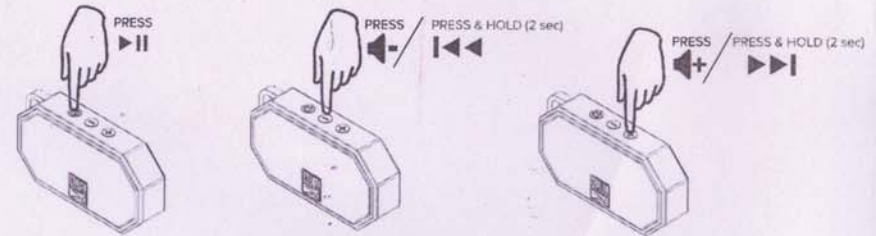

### 6. True Wireless Pairing : Party Mode & Stereo Mode

Any two speakers that have the True Wireless Pairing feature can be paired together for a bigger, more powerful sound with Party Mode. Once you have two speakers paired together, you can then switch to Stereo Mode, where one speaker acts as a left channel and the other acts as a right channel.

#### Step 1

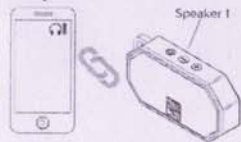

Pair your first speaker (Speaker 1) with a Bluetooth phone.

#### Step 2



Power on your second speaker (Speaker 2).

#### Step 3



Enter True Wireless Mode on your second speaker (Speaker 2).

#### Step 4

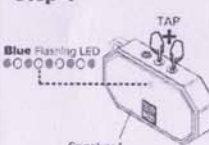

Enter True Wireless Mode on your first speaker (Speaker 1).

#### Step 5



Once both speakers are in True Wireless Mode, wait for up to 60 seconds and then both speakers will be paired to your phone.

#### Step 6



Simultaneously tap the + and - buttons on either speaker to switch to Party Mode.

#### Step 7

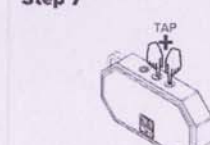

Once in Party Mode, simultaneously tap the + and - buttons on either speaker to switch back to Stereo Mode. To exit Stereo Mode and Party Mode, power off either speaker.



# MINI H2O 3

## RUGGED BLUETOOTH SPEAKER

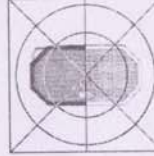

### Quick Start Guide

Item # IMW258



### 7. Making Phone Calls

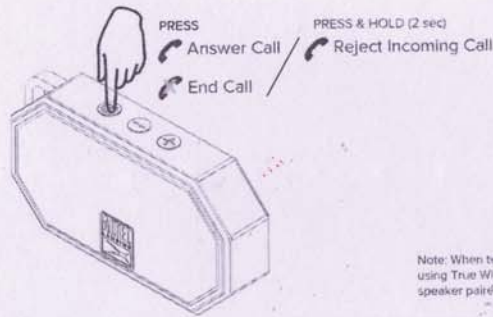

Note: When two speakers are connected using True Wireless Pairing, only the first speaker paired will receive phone calls.

### 8. Wired External Audio Input

You can also use a 3.5mm Auxiliary Cable (sold separately) to connect audio devices through the AUX In port on your speaker.

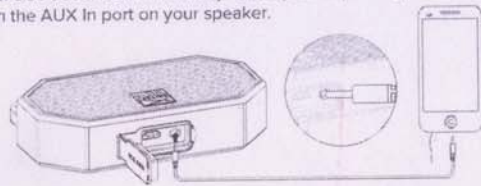

### Important Safety Precautions & Battery Information

1. Do not allow children or the infirm to play with your speaker without adult supervision.
2. Do not expose your speaker to excessive heat, flames or fire.
3. Always press all buttons carefully. Do not mishandle your speaker.
4. Do not use in extremely dry environments, as this can lead to static discharge during usage.
5. Do not expose your speaker to temperatures above 40°C. Keep out of direct sunlight.
6. Do not attempt to repair this product yourself. Contact a qualified service center if your speaker is in need of service.
7. Do not drop, puncture or expose your speaker to excessive trauma.
8. Your speaker is not intended for commercial use.
9. Do not place near objects that generate a strong magnetic field.
10. Unplug this device when not in use for long periods of time or during lightning storms.
11. The device is equipped with an integrated lithium-polymer battery. The battery cannot be replaced. Do not attempt to remove the battery from the device.
12. The battery used in this device may present a risk of fire or chemical burn if mistreated.
13. Please recycle or dispose of your speaker properly based on the laws and rules of your municipality.



IP67  
WATERPROOF  
SANDPROOF  
EVERYTHING PROOF

6  
GHRS  
BATTERY  
LIFE  
(MUSIC)

FLOATS  
IN  
WATER

HANDS  
FREE  
SPEAKERPHONE

### Having Trouble? We're here to help!

Call us 24/7 at 1-855-292-4087

E-Mail us at [altec@sakar.com](mailto:altec@sakar.com) or visit us at [altec Lansing.com](http://altec Lansing.com)

### Altec Lansing One Year Warranty Card

This warranty covers the original consumer purchaser only and is not transferable.

This warranty covers products that fail to function properly UNDER NORMAL USAGE, due to defects in material or workmanship. Your product will be repaired or replaced at no charge for parts or labor for a period of one year.

### What Is Not Covered by Warranty

Damages or malfunctions not resulting from defects in material or workmanship and damages or malfunctions from other than normal use, including but limited to, repair by unauthorized parties, tampering, modification or accident.

### To Obtain Warranty Service and Troubleshooting information:

Call 1-855-292-4087 or Visit our website at [www.alteclansing.com](http://www.alteclansing.com).

To receive Warranty service along with the name and address of an authorized product service center, the original consumer purchaser must contact us for problem determination and service procedures. Proof of purchase in the form of a bill of sale or receipted invoice, evidencing that the Product is within the applicable Warranty period(s), MUST be presented in order to obtain the requested service. It is your responsibility to properly package and send any defective products along with a dated copy of proof of purchase, a written explanation of the problem, and a valid return address to the authorized service center at your expense. Do not include any other items or accessories with the defective product. Any products received by the authorized service center that are not covered by warranty will be returned unrepaid.

**NO WARRANTIES, WHETHER EXPRESS OR IMPLIED, INCLUDING, BUT NOT LIMITED TO, ANY IMPLIED WARRANTIES OF MERCHANTABILITY OR FITNESS FOR A PARTICULAR PURPOSE, OTHER THAN THOSE EXPRESSLY DESCRIBED ABOVE SHALL APPLY. DISTRIBUTOR FURTHER DISCLAIMS ALL WARRANTIES AFTER THE EXPRESS WARRANTY PERIOD STATED ABOVE. NO OTHER EXPRESS WARRANTY OR GUARANTEE GIVEN BY ANY PERSON, FIRM OR ENTITY WITH RESPECT TO THE PRODUCT SHALL BE BINDING ON DISTRIBUTOR. REPAIR, REPLACEMENT, OR REFUND OF THE ORIGINAL PURCHASE PRICE - AT DISTRIBUTOR'S SOLE DISCRETION - ARE THE EXCLUSIVE REMEDIES OF THE CONSUMER. IN NO EVENT WILL DISTRIBUTOR, ITS MANUFACTURERS, OR SAKAR INT. BE LIABLE FOR ANY INCIDENTAL, DIRECT, INDIRECT, SPECIAL, PUNITIVE OR CONSEQUENTIAL DAMAGES (SUCH AS, BUT NOT LIMITED TO, DAMAGES FOR LOSS OF PROFITS, BUSINESS, SAVINGS, DATA OR RECORDS) CAUSED BY THE USE, MISUSE OR INABILITY TO USE THE PRODUCT. EXCEPT AS STATED HEREIN, NO OTHER WARRANTIES SHALL APPLY. NOTWITHSTANDING THE FOREGOING, CONSUMER'S RECOVERY AGAINST DISTRIBUTOR SHALL NOT EXCEED THE PURCHASE PRICE OF THE PRODUCT SOLD BY DISTRIBUTOR. THIS WARRANTY SHALL NOT EXTEND TO ANYONE OTHER THAN THE ORIGINAL CONSUMER WHO PURCHASED THE PRODUCT AND IS NOT TRANSFERABLE.**

Some countries, states or provinces do not allow the exclusion or limitation of incidental or consequential damages or allow limitations on warranties, so limitation or exclusions may not apply to you. This warranty gives you specific legal rights, and you may have other rights that vary from state to state or province to province. Contact your authorized retailer to determine if another warranty applies. This product is manufactured, distributed and sold by SAKAR International, Inc. All other trademarks are the property of the respective owner, who has not sponsored, endorsed or approved this product.

This device complies with part 15 of the FCC rules. Operation is subject to the following two conditions: (1) this device may not cause harmful interference, and (2) this device must accept any interference received, including interference that may cause undesired operation.

Caution: changes or modifications not expressly approved by the party responsible for compliance could void the user's authority to operate the equipment.

NOTE: This equipment has been tested and found to comply with the limits for a Class B digital device, pursuant to Part 15 of the FCC Rules. These limits are designed to provide reasonable protection against harmful interference in a residential installation. This equipment generates, uses and can radiate radio frequency energy and, if not installed and used in accordance with instructions, may cause harmful interference to radio or television reception, which can be determined by turning the equipment off and on, the user is encouraged to try to correct the interference by one or more of the following measures:

- Reorient or relocate the receiving antenna.
- Increase the separation between the equipment and receiver.
- Connect the equipment into an outlet on a circuit different from that to which the receiver is connected.
- Consult the dealer or experienced radio/TV technician for help.

### FCC Radiation Exposure Statement:

This equipment complies with FCC radiation exposure limits set forth for an uncontrolled environment.

This transmitter must not be co-located or operating in conjunction with any other antenna or transmitter.

BC