

FCC TEST REPORT

CATEGORY : Fixed
PRODUCT NAME : Hawking Booster + PCI Card
FCC ID. : SOYHSB1-PCI
FILING TYPE : Certification
BRAND NAME : Hawking
MODEL NAME : HSB1-PCI

APPLICANT : **Hawking Technologies, Inc.**
15281A Barranca Parkway, Irvine, CA 92618 USA

MANUFACTURER : **EDIMAX TECHNOLOGY CO., LTD.**
No. 3, Wu Chuan 3rd Road, Wu-Ku Industrial Park, Taipei
Hsien, Taiwan

ISSUED BY : **SPORTON INTERNATIONAL INC.**
6F, No. 106, Sec. 1, Hsin Tai Wu Rd., His Chih, Taipei Hsien,
Taiwan, R.O.C.

Statements:

The test result in this report refers exclusively to the presented test model / sample.
Without written approval of SPORTON International Inc., the test report shall not be reproduced except in full.

Certificate or Test Report could not be used by the applicant to claim the product endorsement by CNLA and any agency of U.S. government.

The test equipment used to perform the test is calibrated and traceable to NML/ROC or NIST/USA.



1190
ILAC MRA



Table of Contents

HISTORY OF THIS TEST REPORT.....	II
CERTIFICATE OF COMPLIANCE.....	III
1. GENERAL DESCRIPTION OF EQUIPMENT UNDER TEST	1
1.1. Applicant	1
1.2. Manufacturer	1
1.3. Basic Description of Equipment under Test.....	1
1.4. Features of Equipment under Test	1
1.5. Antenna Description.....	2
1.6. Table for Carrier Frequencies.....	2
2. TEST CONFIGURATION OF THE EQUIPMENT UNDER TEST.....	3
2.1. Connection Diagram of Test System	3
2.2. The Test Mode Description.....	4
2.3. Description of Test Supporting Units	4
3. GENERAL INFORMATION OF TEST	5
3.1. Test Facility	5
3.2. Standards for Methods of Measurement.....	5
3.3. DoC Statement	5
3.4. Frequency Range Investigated	5
3.5. Test Distance	5
3.6. Test Software.....	5
4. LIST OF MEASUREMENTS	7
4.1. Summary of the Test Results.....	7
5. TEST RESULT	8
5.1. Test of 6dB Spectrum Bandwidth	8
5.2. Test of Maximum Peak Conducted Output Power	13
5.3. Test of Peak Power Spectral Density	15
5.4. Test of Band Edges Emission.....	20
5.5. Test of AC Power Line Conducted Emission.....	25
5.6. Test of Spurious Radiated Emission.....	33
5.7. Antenna Requirements	52
5.8. RF Exposure	53
6. LIST OF MEASURING EQUIPMENTS USED.....	55
7. COMPANY PROFILE	57
7.1. Certificate of Accreditation	57
7.2. Test Location	57
8. CNLA CERTIFICATE OF ACCREDITATION	58
APPENDIX A. PHOTOGRAPHS OF EUT	A1 ~ A24



CERTIFICATE OF COMPLIANCE

with

47 CFR FCC Part 15 Subpart C

PRODUCT NAME : Hawking Booster + PCI Card

BRAND NAME : Hawking

MODEL NAME : HSB1-PCI

APPLICANT : **Hawking Technologies, Inc.**

15281A Barranca Parkway, Irvine, CA 92618 USA

MANUFACTURER : **EDIMAX TECHNOLOGY CO., LTD.**

No. 3, Wu Chuan 3rd Road, Wu-Ku Industrial Park, Taipei
Hsien, Taiwan

I **HEREBY** CERTIFY THAT:

The measurements shown in this test report were made in accordance with the procedures given in ANSI C63.4-2003 and all test are performed according to 47 CFR FCC Part 15 Subpart C. Testing was carried out on Mar. 14, 2005 at SPORTON International Inc. LAB.

A handwritten signature in blue ink, appearing to read 'Alan Lane', is written over a horizontal line.

Dr. Alan Lane

Vice General Manager
Sporton International Inc.

1. General Description of Equipment under Test

1.1. Applicant

Hawking Technologies, Inc.
 15281A Barranca Parkway, Irvine, CA 92618 USA

1.2. Manufacturer

EDIMAX TECHNOLOGY CO., LTD.
 No. 3, Wu Chuan 3rd Road, Wu-Ku Industrial Park, Taipei Hsien, Taiwan

1.3. Basic Description of Equipment under Test

This product is a Wireless PCI card with 802.11b/g wireless solution. The technical data has been listed on section " Features of Equipment under Test ".

1.4. Features of Equipment under Test

Items	Description
Type of Modulation	DSSS (CCK / DQPSK / DBPSK) OFDM (64QAM / 16QAM / DQPSK / DBPSK)
Number of Channels	11
Frequency Band	2412MHz ~ 2462 MHz
Carrier Frequency	See section 1.6 for details
Data Rate	1, 2, 5.5, 11 Mbps – DSSS 6, 12, 18, 24, 36, 48, 54 Mbps - OFDM
Channel Bandwidth	15 MHz (DSSS), 18 MHz (802.11g)
Max. Conducted Output Power	DSSS : 22.23 dBm ; OFDM : 20.75 dBm
Antenna Type	See section 1.5 for details
Communication Type	Half-Duplex
Testing Duty Cycle	100.00%
Test Power Source	110.00V AC from Adaptor (Booster); 5V DC from PC (PCI Card)
Temperature Range (Operating)	0 ~ 55 °C



1.5. Antenna Description

No.	Antenna Type	Gain (dBi)
1	Dipole Antenna	2.00

1.6. Table for Carrier Frequencies

Channel	Frequency	Channel	Frequency	Channel	Frequency	Channel	Frequency
01	2412 MHz	05	2432 MHz	09	2452 MHz	-	-
02	2417 MHz	06	2437 MHz	10	2457 MHz	-	-
03	2422 MHz	07	2442 MHz	11	2462 MHz	-	-
04	2427 MHz	08	2447 MHz	-	-	-	-

2. Test Configuration of the Equipment under Test

2.1. Connection Diagram of Test System

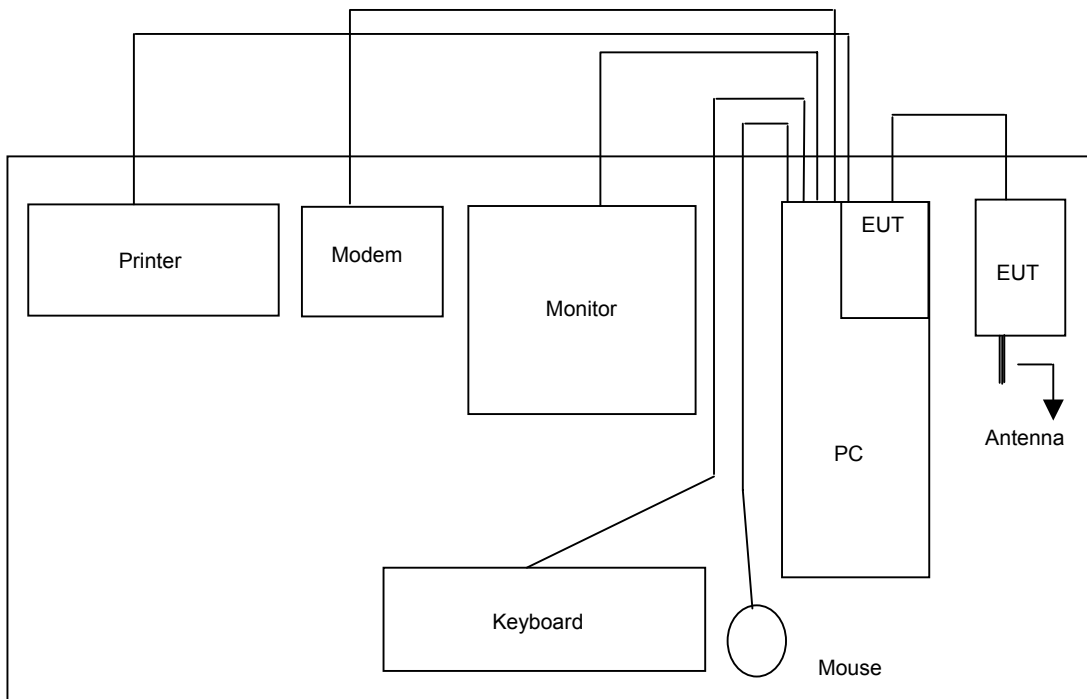

2.2. The Test Mode Description

1. For DSSS modulation, CCK (11 Mbps) is the worst case on all test items.
2. For OFDM modulation, BPSK (6 Mbps) is the worst case on all test items.
3. According to ANSI C63.4-2003: Frequency range of EUT is more than 10 MHz, we have to test the lowest, middle and highest channels of EUT.
4. Spurious emission below 1GHz is independent of channel selection and modulation types and types of antenna. So only channel 11 with OFDM modulation was tested.
5. AC conduction emission is independent of channel selection, modulation types and types of antennas. So only channel 11 with OFDM modulation was tested.
6. The following test modes were performed for AC power conduction test:
 - Mode 1: PCI Mode (for power of system)
 - Mode 2: PCI+booster Mode (for power of booster)

2.3. Description of Test Supporting Units

Support unit	Brand	Model No.	Serial No.	FCC ID	Data cable (m)
PC	HP	DTPC-16	SP0002	DoC	-
Monitor	VIEWSONIC	VCDTS21553-3P	SP0007	DoC	1.7
(PS2) Keyboard	LOGITECH	Y-SJ17	SP0010	DoC	1.7
(PS2) Mouse	LOGITECH	M-S34	SP0014	DoC	1.7
Printer	EPSON	STYLUS COLOR 680	SP0016	DoC	1.35
Modem	ACEEX	DM141	SP0019	IFAXDM141	1.15



3. General Information of Test

3.1. Test Facility

Test Site Location : No. 52, Hwa Ya 1st Rd., Hwa Ya Technology Park, Kwei-Shan Hsiag, Tao Yuan Hsien, Taiwan, R.O.C.
: TEL 886-3-327-3456
: FAX 886-3-318-0055

Test Site No : 03CH03-HY / TH01-HY / CO04-HY

3.2. Standards for Methods of Measurement

Here is the list of the standards followed in this test report.

ANSI C63.4-2003
47 CFR FCC Part 15 Subpart C

3.3. DoC Statement

This EUT is also classified as a device of computer peripheral Class B which DoC has to be followed. It has been verified according to the rule of 47 CFR part 15 Subpart B, and found that all the requirements has been fulfilled.

3.4. Frequency Range Investigated

Radiated emission test: from 30 MHz to 10th carrier harmonic

3.5. Test Distance

The test distance of radiated emission (30MHz~1GHz) test from antenna to EUT is 3 M.
The test distance of radiated emission (1GHz~10th carrier harmonic) test from antenna to EUT is 3 M.

3.6. Test Software

During testing, Channel & Power Controlling Software: This was provided by the manufacturer and is able to let the test engineer select the operating channel as well as the RF output power. The parameters for channel selection is trying to offer the test engineer the ability to fix the operating channel for testing, both normal data and continuously transmitting modes are allowed, and that for RF output power selection is for the setting of RF output power expected by the customer and is going to be fixed on the firmware of the final end product.



Power Parameter Table

Test Software	REALTEK PTL8185 WLAN NIC
Power Set CH 01 / CCK	1A / TX Power
Power Set CH 06 / CCK	1A / TX Power
Power Set CH 11 / CCK	1A / TX Power
Power Set CH 01 / OFDM	1A / TX Power
Power Set CH 06 / OFDM	1A / TX Power
Power Set CH 11 / OFDM	1A / TX Power



4. List of Measurements

4.1. Summary of the Test Results

Applied Standard: 47 CFR FCC Part 15 Subpart C			
Paragraph	FCC Section	Description of Test	Result
5.1	15.247(a)(2)	6dB Spectrum Bandwidth	Pass
5.2	15.247(b)(3)	Maximum Peak Conducted Output Power	Pass
5.3	15.247(e)	Peak Power Spectral Density	Pass
5.4	15.247(d)	Band Edges Emission	Pass
5.5	15.207	AC Power Line Conducted Emission	Pass
5.6	15.247(d)	Spurious Radiated Emission	Pass
5.7	15.203/15.247(b)/(c)	Antenna Requirement	Pass
5.8	2.1091	Maximum Permissible Exposure	Pass

5. Test Result

5.1. Test of 6dB Spectrum Bandwidth

5.1.1. Applicable Standard

Section 15.247(a)(2): For digital modulation systems, the minimum 6 dB bandwidth shall be at least 500 kHz.

5.1.2. Measuring Instruments

Item 18 of the table is on section 6.

5.1.3. Description of Major Test Instruments Setting

- Spectrum Analyzer : R&S FSP30
- Attenuation : Auto
- Center Frequency : 2412 MHz / 2437 MHz / 2462 MHz
- Span Frequency : > 6dB Bandwidth
- RB : 100 kHz
- VB : 100 kHz
- Detector : Peak
- Trace : Max Hold
- Sweep Time : Auto

5.1.4. Test Procedures

1. The transmitter output was connected to the spectrum analyzer through an attenuator.
2. Set RBW of spectrum analyzer to 100KHz and VBW to 100KHz. Trace to Max hold and Detector PK.
3. The spectrum width with level higher than 6dB below the peak level.
4. Repeat above 1~3 points for the middle and highest channel of the EUT.

5.1.5. Test Setup Layout

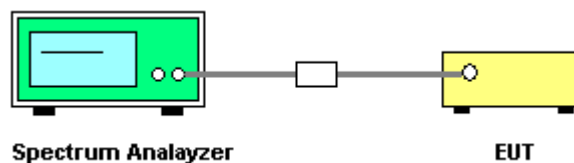

5.1.6. Test Criteria

All test results complied with the requirements of 15.247(a)(2). Measurement Uncertainty is 1×10^{-5} .



5.1.7. Test Result

- Temperature: 24°C
- Relative Humidity: 55%
- Duty Cycle of the Equipment During the Test: 100.00%
- Test Engineer: Sam Lee

Modulation Type	Channel No.	Frequency (MHz)	6dB Bandwidth (MHz)	Min. Limit (MHz)
DSSS	01	2412 MHz	11.96	0.5
DSSS	06	2437 MHz	11.72	0.5
DSSS	11	2462 MHz	11.96	0.5
OFDM	01	2412 MHz	16.56	0.5
OFDM	06	2437 MHz	16.48	0.5
OFDM	11	2462 MHz	16.52	0.5



Modulation Type: DSSS (Channel 01) :

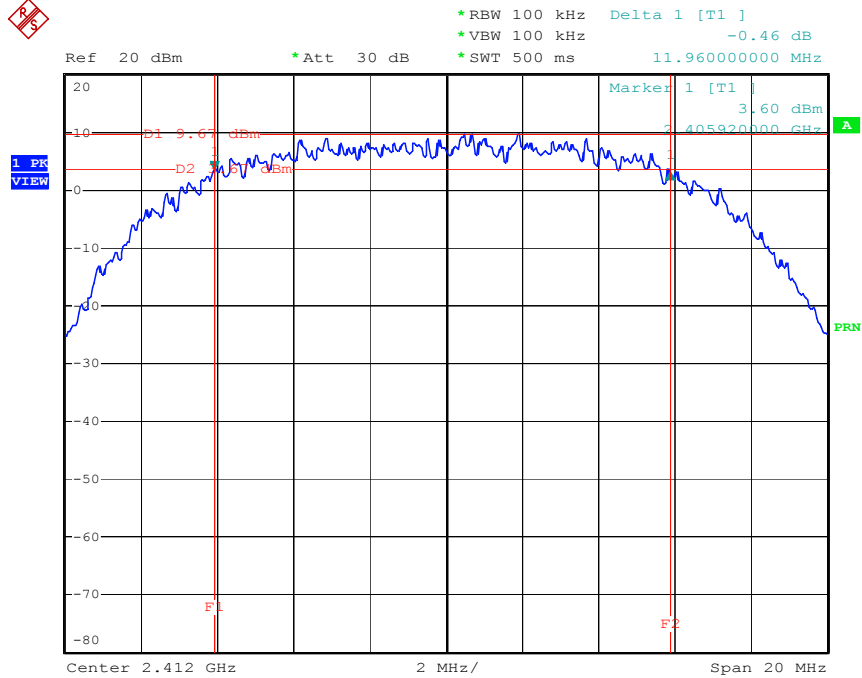

Date: 11.MAR.2005 16:36:43

Modulation Type: DSSS (Channel 06) :

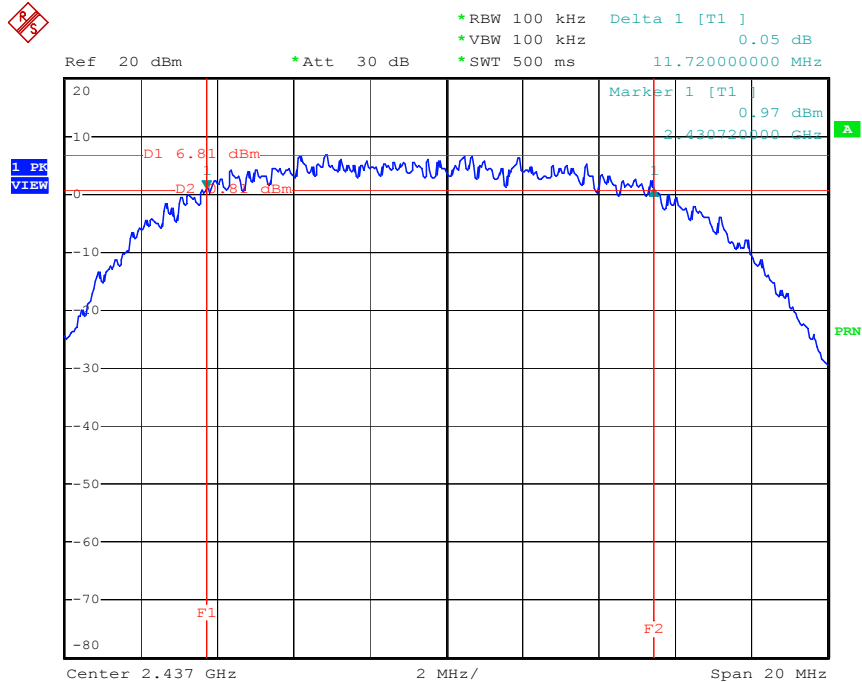

Date: 11.MAR.2005 16:46:50



Modulation Type: DSSS (Channel 11) :

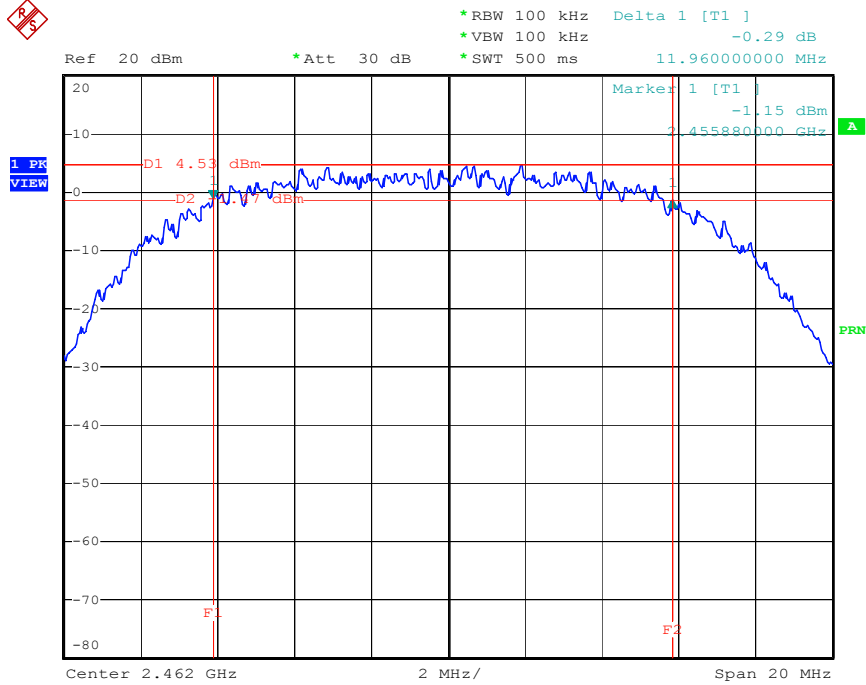

Date: 11.MAR.2005 16:48:33

Modulation Type: OFDM (Channel 01) :

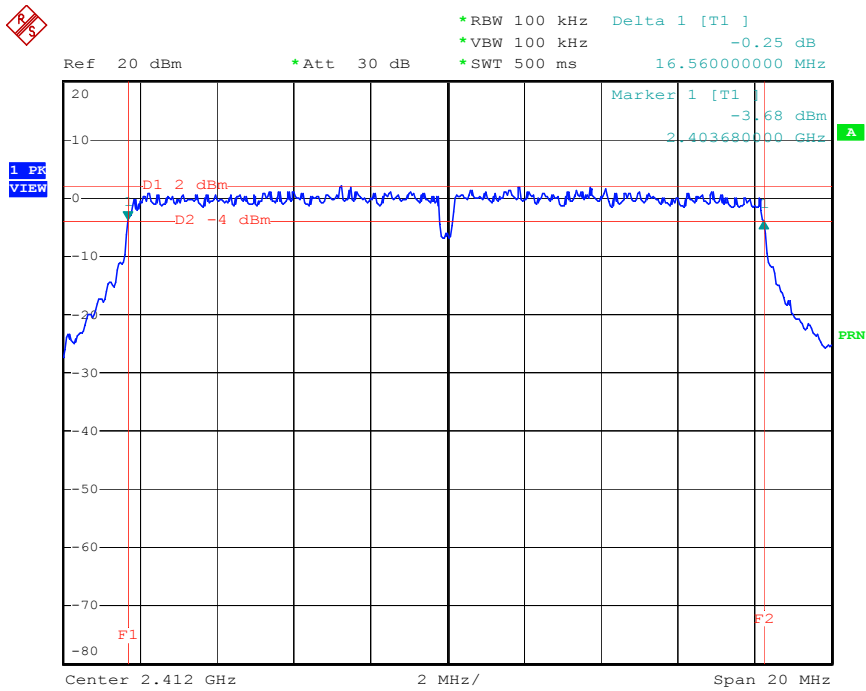

Date: 11.MAR.2005 16:57:39



Modulation Type: OFDM (Channel 06) :

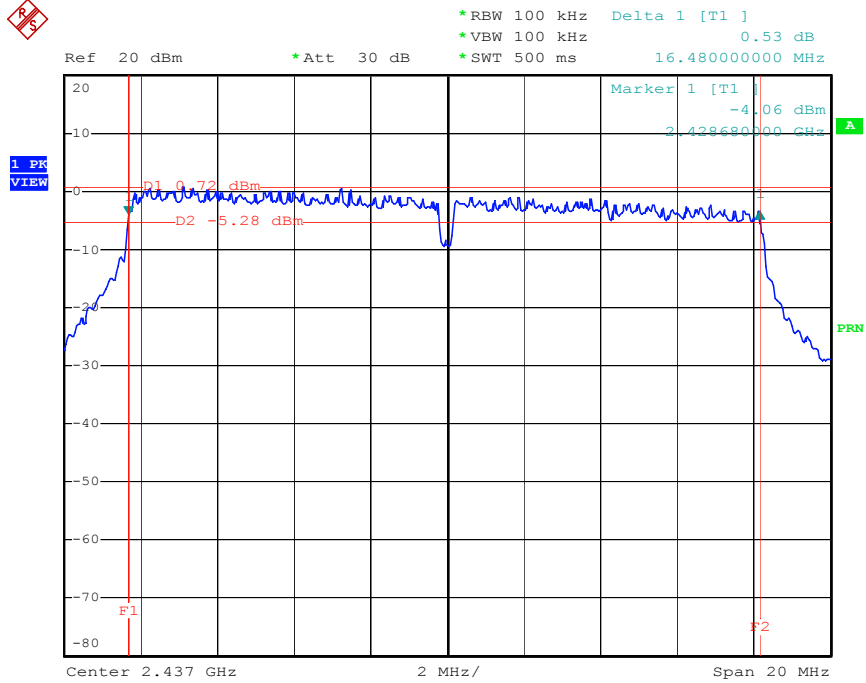

Date: 11.MAR.2005 17:04:14

Modulation Type: OFDM (Channel 11) :

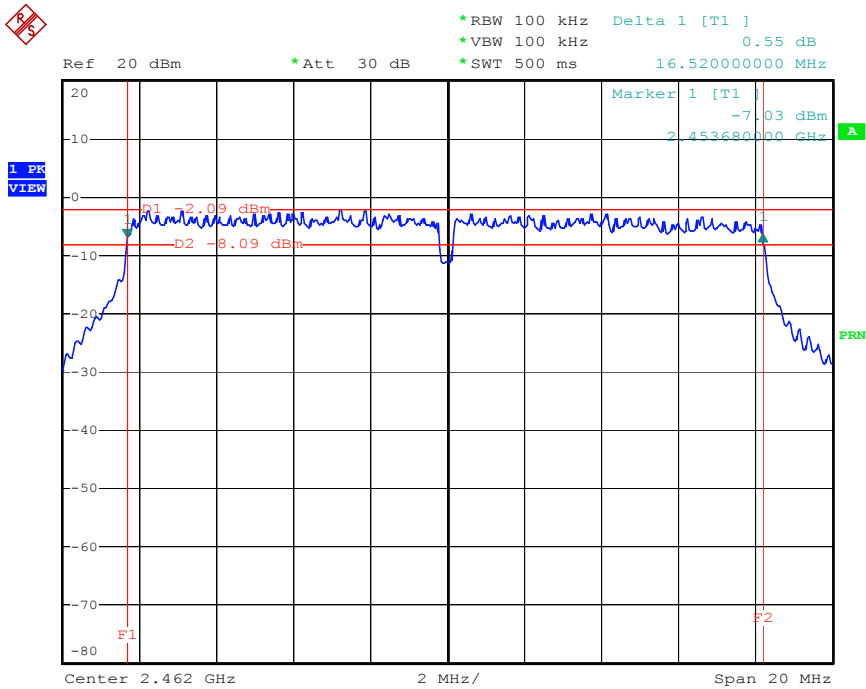

Date: 11.MAR.2005 17:09:02

5.2. Test of Maximum Peak Conducted Output Power

5.2.1. Applicable Standard

Section 15.247(b)(3): The maximum peak output power shall not exceed 1 watt (30dBm). Except as shown below, if transmitting antennas of directional gain greater than 6 dBi are used the peak output power from the intentional radiator shall be reduced below the above stated values by the amount in dB that the directional gain of the antenna exceeds 6 dBi.

5.2.2. Measuring Instruments

Item 19, 21 of the table are on section 6.

5.2.3. Test Procedures and Test Instruments Setting

1. The transmitter output was connected to the peak power meter through an attenuator.
2. The attenuator and the filter use the same parameter with peak power meter.
3. Repeated the 1 for the middle and highest channel of the EUT.

5.2.4. Test Setup Layout

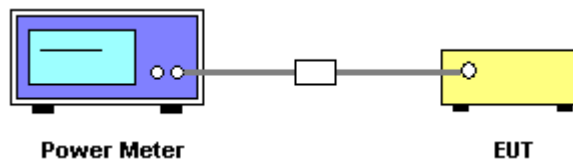

5.2.5. Test Criteria

All test results complied with the requirements of 15.247(b)(3). Measurement Uncertainty is 1.5dB.

5.2.6. Test Result of Conducted Power

- Temperature: 24°C
- Relative Humidity: 55%
- Duty Cycle of the Equipment During the Test: 100.00%
- Test Engineer: Sam Lee

Modulation Type	Channel No.	Frequency (MHz)	Output Power (dBm)	Limits (dBm)
DSSS	01	2412 MHz	22.23	30
DSSS	06	2437 MHz	19.98	30
DSSS	11	2462 MHz	17.75	30
OFDM	01	2412 MHz	20.75	30
OFDM	06	2437 MHz	18.22	30
OFDM	11	2462 MHz	15.52	30



5.2.7. Test Result of EIRP Power

- Temperature: 24°C
- Relative Humidity: 55%
- Duty Cycle of the Equipment During the Test: 100.00%
- Test Engineer: Sam Lee

Antenna No.	Gain (dBi)	Modulation Type	Channel No.	Frequency (MHz)	Power (dBm)	Limits (dBm)
1	2.00	DSSS	01	2412 MHz	24.23	36
1	2.00	DSSS	06	2437 MHz	21.98	36
1	2.00	DSSS	11	2462 MHz	19.75	36
1	2.00	OFDM	01	2412 MHz	22.75	36
1	2.00	OFDM	06	2437 MHz	20.22	36
1	2.00	OFDM	11	2462 MHz	17.52	36

5.3. Test of Peak Power Spectral Density

5.3.1. Applicable Standard

Section 15.247(e): For digital modulation systems, the peak power spectral density conducted from the intentional radiator to the antenna shall not be greater than 8 dBm in any 3 kHz band during any time interval of continuous transmission.

5.3.2. Measuring Instruments

Item 18 of the table is on section 6.

5.3.3. Description of Major Test Instruments Setting

- Spectrum Analyzer : R&S FSP30
- Attenuation : Auto
- Center Frequency : 2412 MHz / 2437 MHz / 2462 MHz
- Span Frequency : 1.5MHz
- RB : 3 kHz
- VB : 30 kHz
- Detector : Peak
- Trace : Max Hold
- Sweep Time : 500s

5.3.4. Test Procedures

1. The transmitter output is connected to the spectrum analyzer through an attenuator.
2. Set RBW of spectrum analyzer to 3kHz and VBW to 30kHz. Set Detector to Peak, Trace to Max Hold.
3. Mark the frequency with maximum peak power as the center of the display of the spectrum
4. Set the span to 1.5MHz and the sweep time to 500s and record the maximum peak value.
5. Repeated the 1~4 for the middle and highest channel of the EUT.

5.3.5. Test Setup Layout

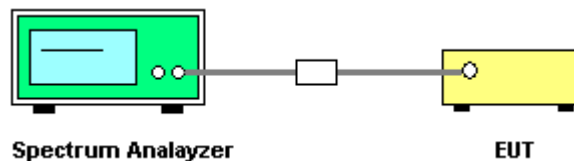

5.3.6. Test Criteria

All test results complied with the requirements of 15.247(e). Measurement Uncertainty is 1.5dB.



5.3.7. Test Result

- Temperature: 24°C
- Relative Humidity: 55%
- Duty Cycle of the Equipment During the Test: 100.00%
- Test Engineer: Sam Lee

Modulation Type	Channel No.	Frequency (MHz)	Power Density (dBm)	Limits (dBm)
DSSS	01	2412 MHz	-3.91	8
DSSS	06	2437 MHz	-5.94	8
DSSS	11	2462 MHz	-8.59	8
OFDM	01	2412 MHz	-11.51	8
OFDM	06	2437 MHz	-13.10	8
OFDM	11	2462 MHz	-16.26	8



Modulation Type: DSSS (Channel 01) :

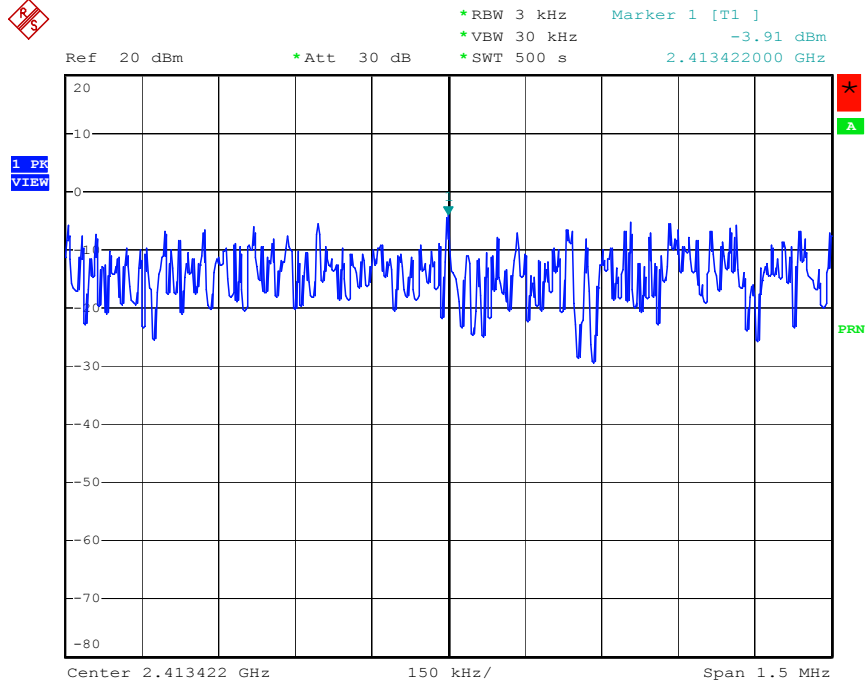

Date: 11.MAR.2005 16:40:23

Modulation Type: DSSS (Channel 06) :

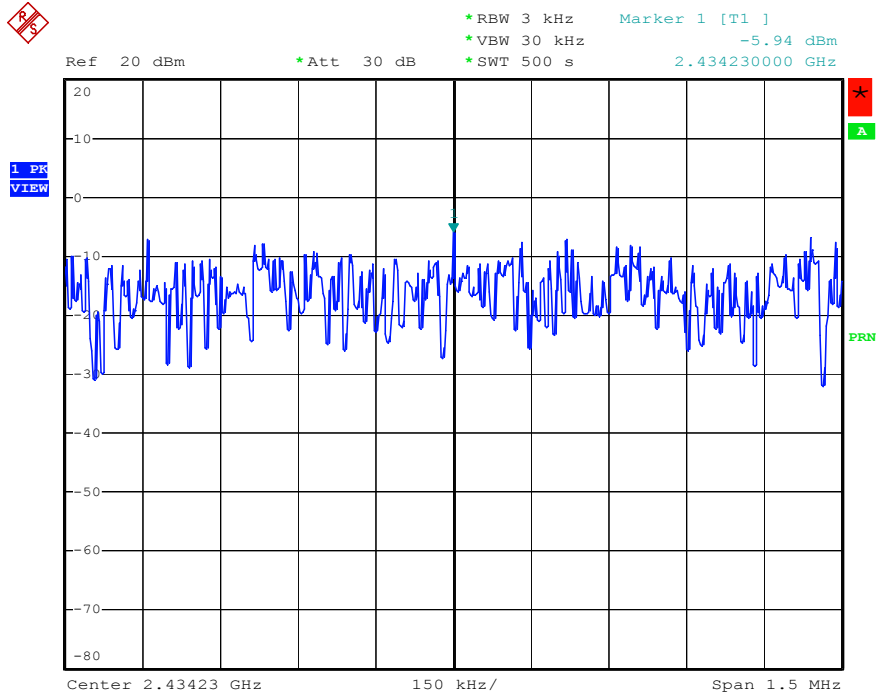

Date: 11.MAR.2005 16:43:45



Modulation Type: DSSS (Channel 11) :

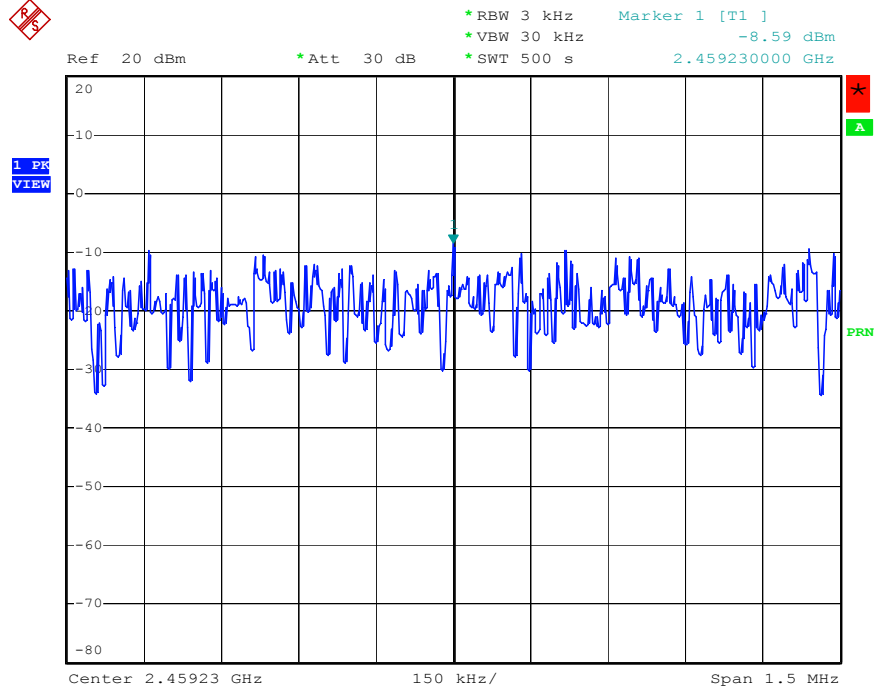

Date: 11.MAR.2005 16:52:11

Modulation Type: OFDM (Channel 01) :

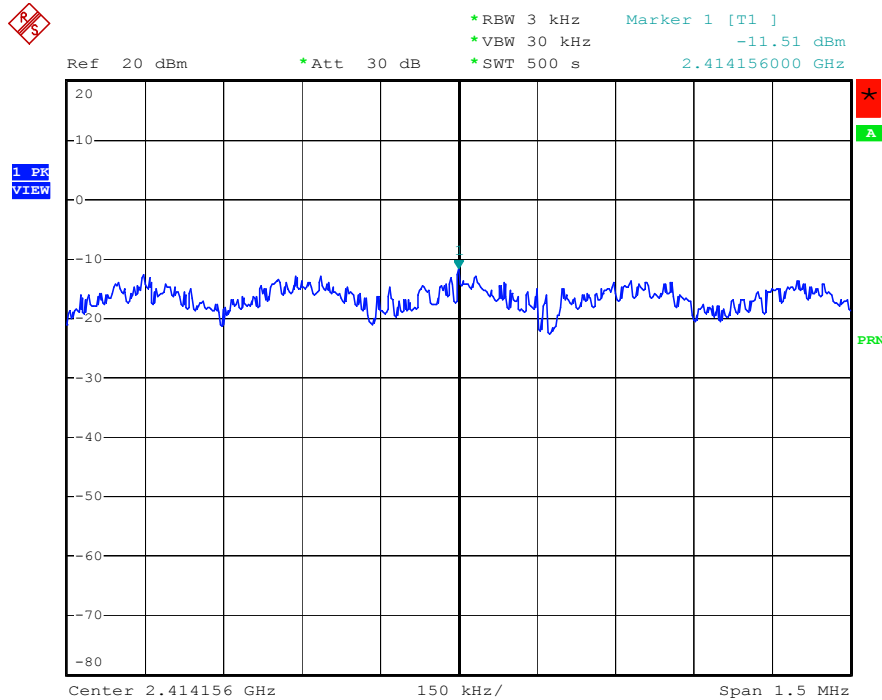

Date: 11.MAR.2005 17:00:54



Modulation Type: OFDM (Channel 06) :

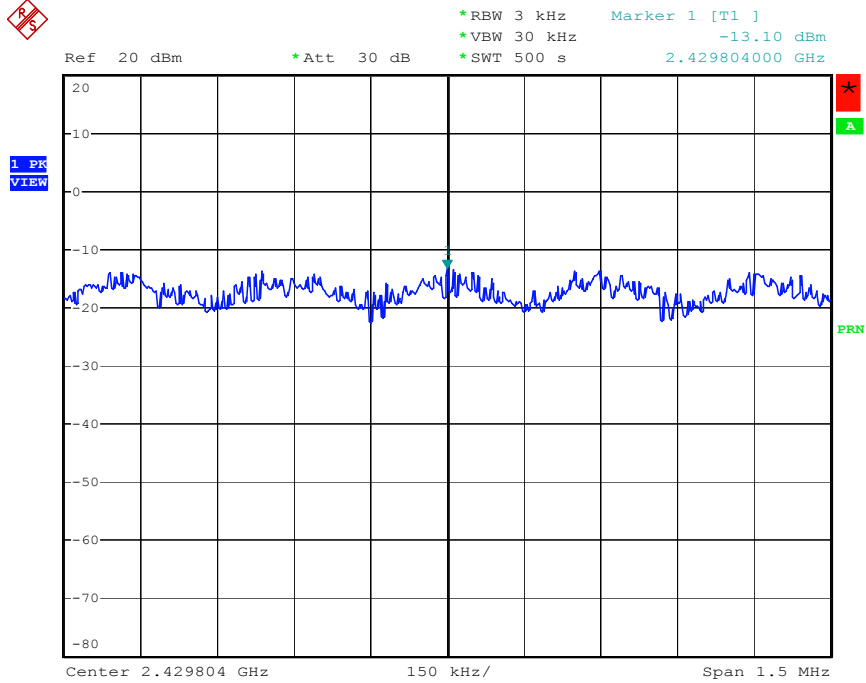

Date: 11.MAR.2005 17:02:25

Modulation Type: OFDM (Channel 11) :

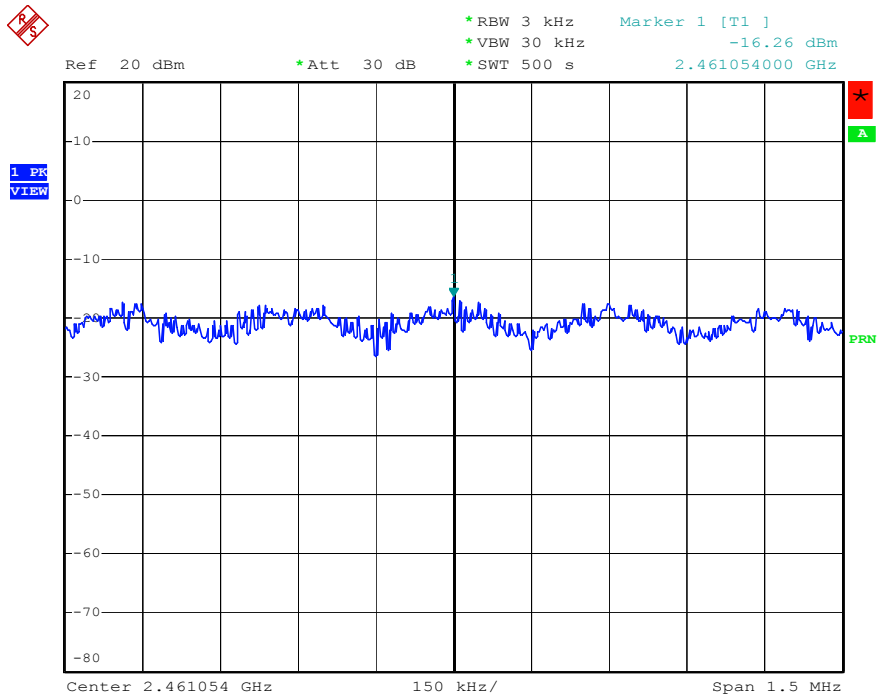

Date: 11.MAR.2005 17:10:46

5.4. Test of Band Edges Emission

5.4.1. Applicable Standard

Section 15.247(d): In any 100 kHz bandwidth outside the frequency band in which the spread spectrum or digitally modulated intentional radiator is operating, the radio frequency power that is produced by the intentional radiator shall be at least 20 dB below that in the 100 kHz bandwidth within the band that contains the highest level of the desired power, based on either an RF conducted or a radiated measurement. In addition, radiated emissions that fall in the restricted bands, as defined in Section 15.205, must also comply with the radiated emission limits specified in Section 15.209.

5.4.2. Measuring Instruments

Item 6~17 of the table is on section 6 for radiated measurement.

Item 18 of the table is on section 6 for conducted measurement.

5.4.3. Description of Major Test Instruments Setting

- Spectrum Analyzer : R&S FSP30 (Conducted Measurement)
 - Attenuation : Auto
 - Center Frequency : 2412 MHz / 2462 MHz
 - Span Frequency : 100MHz
 - RB : 100 kHz
 - VB : 100 kHz
 - Detector : Peak
 - Trace : Max Hold
 - Sweep Time : Auto

- Spectrum Analyzer : R&S FSP40 (Radiated Measurement)
 - Attenuation : Auto
 - Center Frequency : 2412 MHz / 2462 MHz
 - Span Frequency : 100MHz
 - RB : 1 MHz for PK value / 1 MHz for AV value
 - VB : 1 MHz for PK value / 10 Hz for AV value
 - Detector : Peak
 - Trace : Max Hold
 - Sweep Time : Auto

5.4.4. Test Procedures and Test Instruments Setting

Conducted Measurement

1. The transmitter is set to the lowest channel.
2. The transmitter output was connected to the spectrum analyzer via a cable and cable loss is used as the offset of the spectrum analyzer.
3. Set both RBW and VBW of spectrum analyzer to 100KHz with convenient frequency span including 100MHz bandwidth from lower band edge. Then detector set to peak and max hold this trace.
4. The lowest band edges emission was measured and recorded.
5. The transmitter set to the highest channel and repeated 2~4.

Radiated Measurement

1. Configure the EUT according to ANSI C63.4.
2. The turntable was rotated by 360 degrees to determine the position of the highest radiation.
3. The height of the broadband receiving antenna was varied between one meter and four meters above ground to find the maximum emission field strength of both horizontal and vertical polarization.
4. For band edge emission, the antenna tower was scan (from 1 M to 4 M) and then the turn table was rotated (from 0 degree to 360 degrees) to find the maximum reading.
5. For band edge emission in restriction bands, use 10Hz VBW and 1MHz RBW for reading under AV and use 1MHz VBW and 1 MHz RBW for reading under PK.

5.4.5. Test Setup

Radiated Method

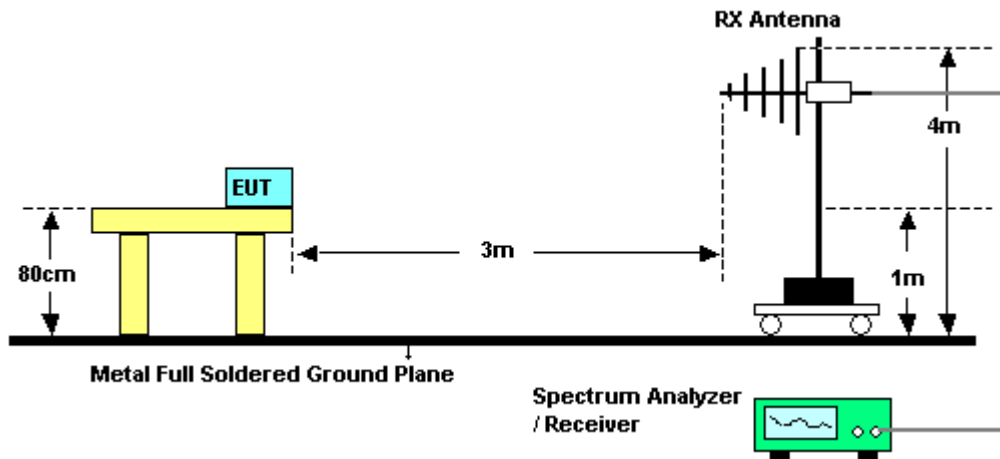

Conducted Method

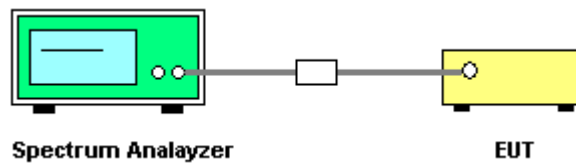

5.4.6. Test Criteria

All test results complied with the requirements of 15.247(d). Measurement Uncertainty is 1×10^{-5} .

5.4.7. Test Result of Radiated Emission

- Temperature: 24°C
- Relative Humidity: 55%
- Duty Cycle of the Equipment During the Test: 100.00%
- Test Engineer: Sam Lee

Modulation Type	Test Channel	Freq. (MHz)	Level* (dBuV/m)	Margin (dB)	Limit (dBuV/m)	Trace (PK/AV)
DSSS	01	2386.00	63.26	-10.74	74	PK
DSSS	01	2386.00	52.69	-1.31	54	AV
DSSS	11	2487.65	62.38	-11.62	74	PK
DSSS	11	2487.65	50.23	-3.77	54	AV
OFDM	01	2389.99	66.02	-7.98	74	PK
OFDM	01	2389.99	48.29	-5.71	54	AV
OFDM	11	2483.66	64.34	-9.66	74	PK
OFDM	11	2483.66	47.70	-6.30	54	AV

Level*: The max field strength in the restricted bands.

5.4.8. Test Result of Conducted Emission

- Temperature: 24°C
- Relative Humidity: 55%
- Duty Cycle of the Equipment During the Test: 100.00%
- Test Engineer: Sam Lee

Modulation Type	Test Channel	Freq. (MHz)	Level* (dBuV/m)	Margin (dB)	Limit* (dBuV/m)
DSSS	01	2398.00	-35.85	-24.97	-10.88
DSSS	11	2486.43	-44.44	-28.75	-15.69
OFDM	01	2400.00	-35.27	-17.20	-18.07
OFDM	11	2483.80	-41.26	-23.33	-17.93

Limit* : This limit is -20dBc.

Test Result of Conducted Emission

Modulation Type: DSSS (Channel 01) :

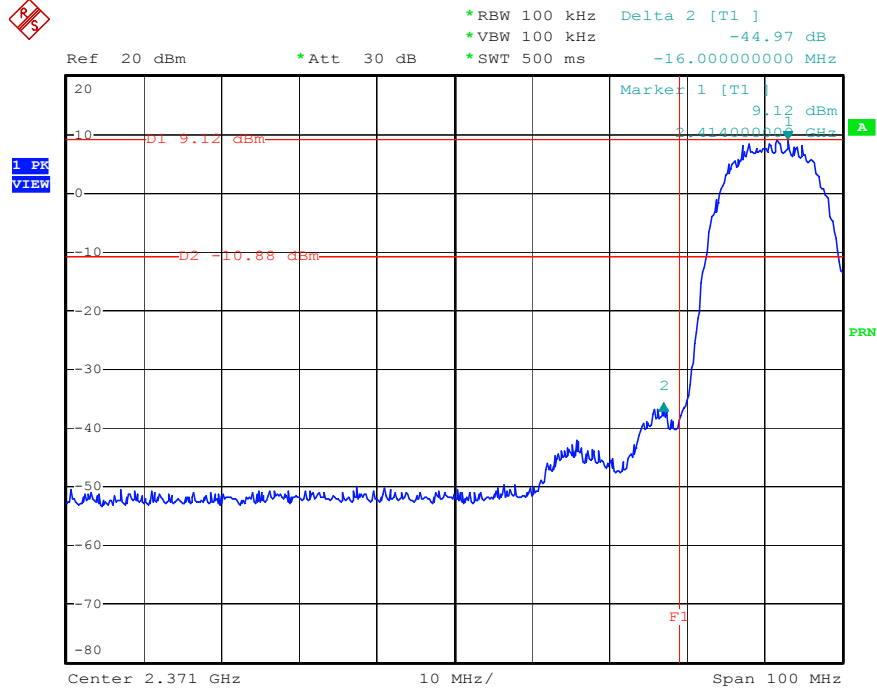

Date: 11.MAR.2005 16:38:06

5.4.9. Modulation Type: DSSS (Channel 11) :

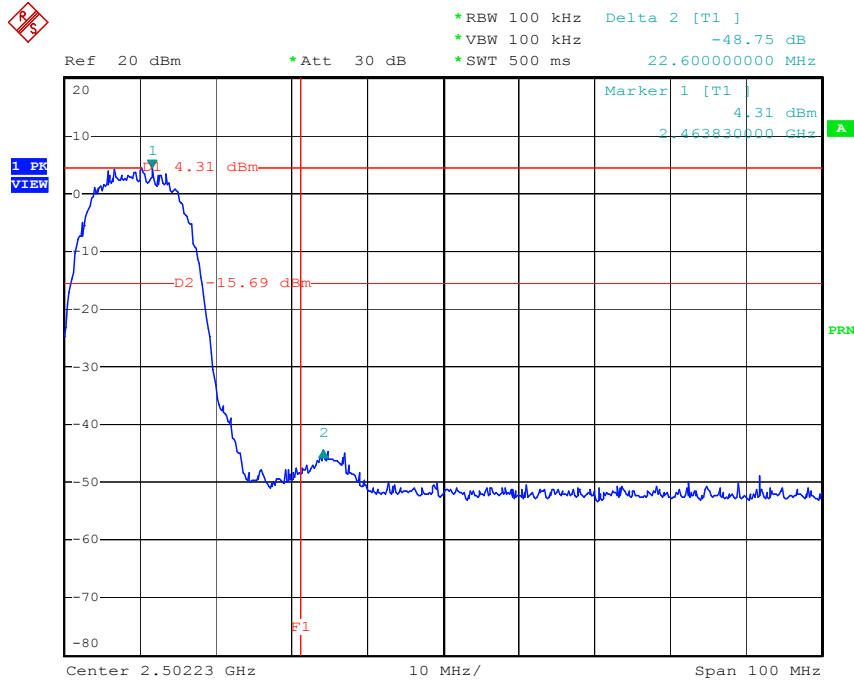

Date: 11.MAR.2005 16:53:50



Modulation Type: OFDM (Channel 01) :

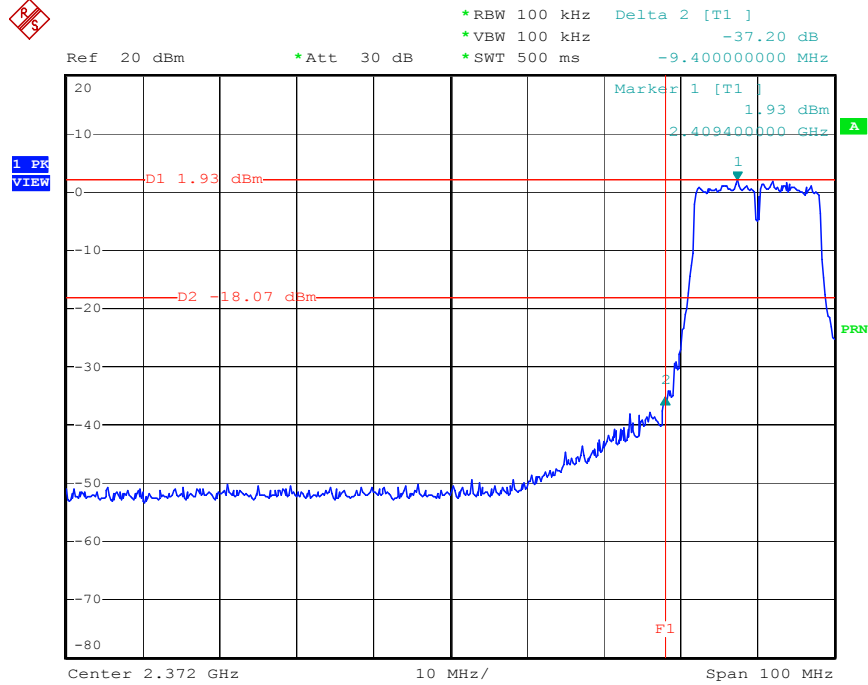

Date: 11.MAR.2005 16:59:05

Modulation Type: OFDM (Channel 11) :

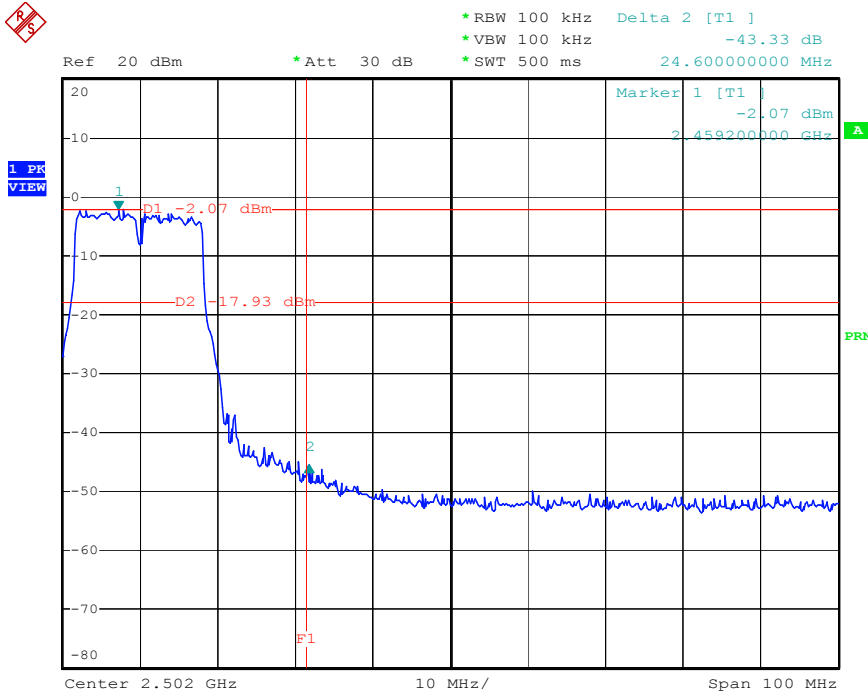

Date: 11.MAR.2005 17:07:18

5.5. Test of AC Power Line Conducted Emission

5.5.1. Applicable Standard

Section 15.207: For a Low-power Radio-frequency Device is designed to be connected to the AC power line, the radio frequency voltage that is conducted back onto the AC power line on any frequency or frequencies within the band 150 kHz to 30 MHz shall not exceed below limits table.

Frequency (MHz)	QP Limit (dBuV)	AV Limit (dBuV)
0.15~0.5	66~56	56~46
0.5~5	56	46
5~30	60	50

5.5.2. Measuring Instruments

Please reference item 1~5 in chapter 6 for the instruments used for testing.

5.5.3. Description of Major Test Instruments Setting

- Test Receiver : R&S ESCS 30
- Attenuation : 10 dB
- Start Frequency : 0.15 MHz
- Stop Frequency : 30 MHz
- IF Bandwidth : 9 KHz

5.5.4. Test Procedures

1. Configure the EUT according to ANSI C63.4.
2. The EUT has to be placed 0.4 meter far from the conducting wall of the shielding room and at least 80 centimeters from any other grounded conducting surface.
3. Connect EUT to the power mains through a line impedance stabilization network (LISN)
4. All the support units are connected to the other LISNs. The LISN should provide 50uH/ 50ohms coupling impedance.
5. The frequency range from 150 KHz to 30 MHz was searched.
6. Use the Channel & Power Controlling software to make the EUT working on selected channel and expected output power, then use the "H" Patter Generator software to make the supporting equipments stay on working condition.
7. Set the test-receiver system to Peak Detect Function and Specified Bandwidth with Maximum Hold Mode.
8. The measurement has to be done between each power line and ground at the power terminal for each RF channel. Only one RF channel has to be investigated since this test is independent with the RF channel selection.

5.5.5. Test Setup Layout

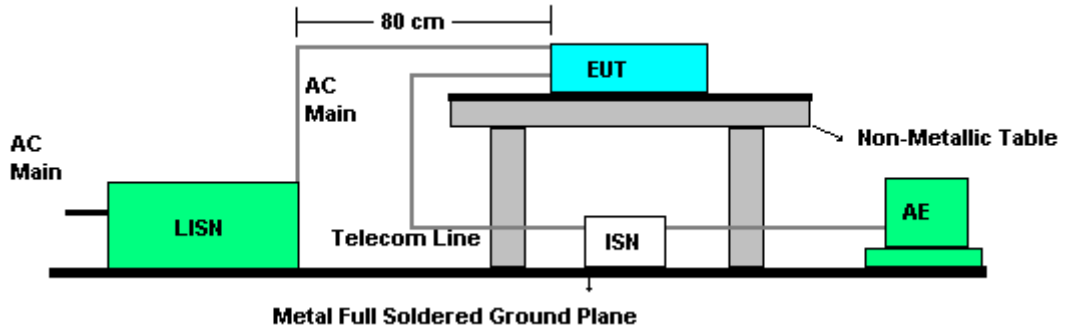

5.5.6. Test Criteria

All test results complied with the requirements of 15.207. Measurement Uncertainty is 2.54dB.

5.5.7. Test Result of Conducted Emission for CH 11 / 2462 MHz

- Mode 1
- Modulation Type: OFDM
- Temperature: 24°C
- Relative Humidity: 55%
- Test Engineer: Sky Wu

Line to Ground

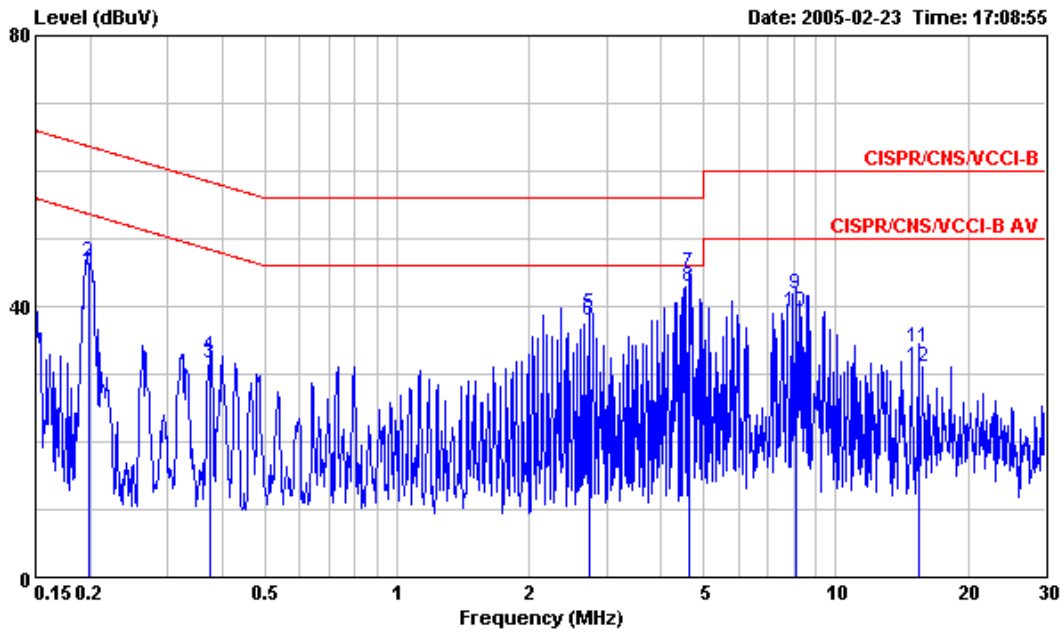

	Freq	Level	Over	Limit	Read	LISN	Cable	
	MHz	dBuV	Limit	Line	Level	Factor	Loss	Remark
			dB	dBuV	dBuV	dB	dB	
1	0.1984060	45.39	-8.29	53.68	45.12	0.06	0.21	Average
2	0.1984060	46.56	-17.12	63.68	46.29	0.06	0.21	QP
3	0.3738390	31.64	-16.78	48.42	31.29	0.06	0.29	Average
4	0.3738390	32.59	-25.83	58.42	32.24	0.06	0.29	QP
5	2.733	38.96	-17.04	56.00	38.54	0.16	0.26	QP
6	2.733	37.92	-8.08	46.00	37.50	0.16	0.26	Average
7	4.609	44.89	-11.11	56.00	44.40	0.21	0.28	QP
8	4.609	42.99	-3.01	46.00	42.50	0.21	0.28	Average
9	8.146	41.96	-18.04	60.00	41.47	0.21	0.28	QP
10	8.146	39.25	-10.75	50.00	38.76	0.21	0.28	Average
11	15.383	33.96	-26.04	60.00	32.96	0.22	0.78	QP
12	15.383	30.95	-19.05	50.00	29.95	0.22	0.78	Average



Neutral to Ground

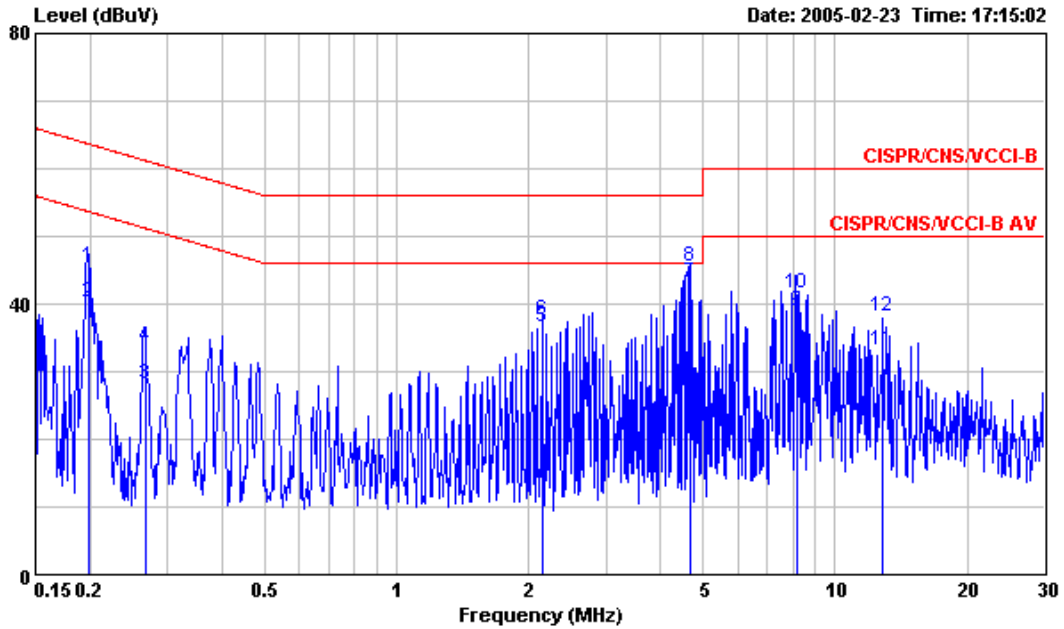

	Freq	Level	Over	Limit	Read	LISN	Cable	Remark
	MHz	dBuV	Limit	Line	Level	Factor	Loss	
			dB	dBuV	dBuV	dB	dB	
1	0.1988610	45.56	-18.10	63.66	45.24	0.11	0.21	QP
2	0.1988610	40.39	-13.27	53.66	40.07	0.11	0.21	Average
3	0.2671090	28.15	-23.06	51.21	27.75	0.11	0.29	Average
4	0.2671090	33.58	-27.63	61.21	33.18	0.11	0.29	QP
5	2.144	36.64	-9.36	46.00	36.18	0.23	0.23	Average
6	2.144	37.62	-18.38	56.00	37.16	0.23	0.23	QP
7	4.662	43.19	-2.81	46.00	42.66	0.25	0.28	Average
8	4.662	45.48	-10.52	56.00	44.95	0.25	0.28	QP
9	8.147	38.92	-11.08	50.00	38.33	0.31	0.28	Average
10	8.147	41.68	-18.32	60.00	41.09	0.31	0.28	QP
11	12.862	33.21	-16.79	50.00	31.83	0.33	1.05	Average
12	12.862	38.28	-21.72	60.00	36.90	0.33	1.05	QP

Note:

Corrected Reading: Probe (LISN / ISN) Factor + Cable Loss + Read Level = Level.



- Mode 2
- Modulation Type: OFDM
- Temperature: 24°C
- Relative Humidity: 55%
- Test Engineer: Sky Wu

Line to Ground

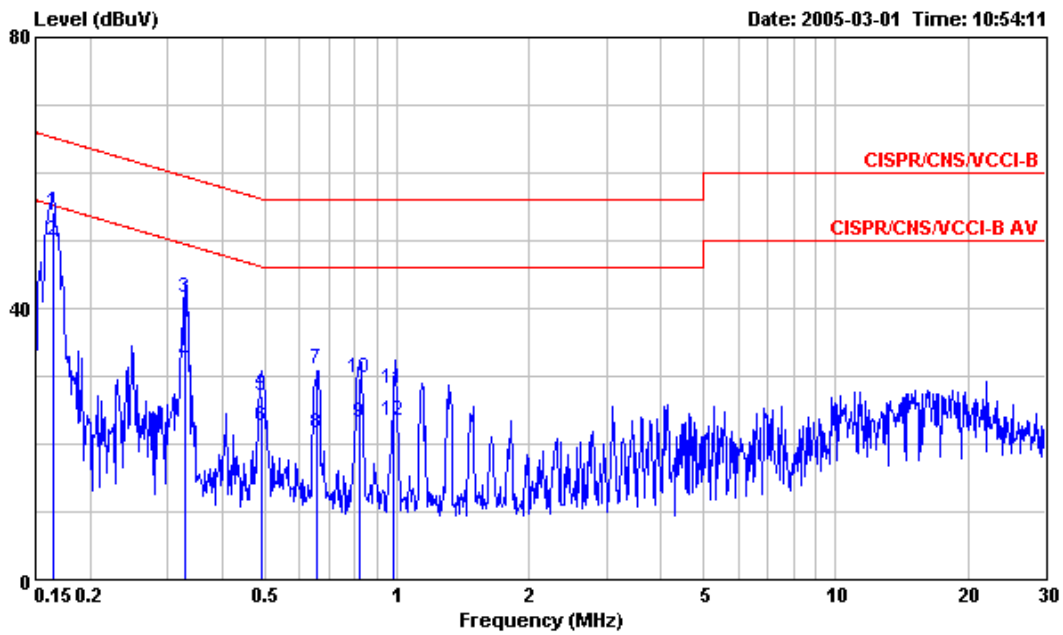

	Freq	Level	Over Limit	Limit Line	Read Level	LISN Factor	Cable Loss	Remark
	MHz	dBuV	dB	dBuV	dBuV	dB	dB	
1	0.1641380	54.11	-11.14	65.25	53.62	0.06	0.43	QP
2	0.1641380	50.06	-5.19	55.25	49.57	0.06	0.43	Average
3	0.3290680	41.53	-17.94	59.47	41.16	0.06	0.31	QP
4	0.3290680	32.07	-17.40	49.47	31.70	0.06	0.31	Average
5	0.4914980	27.10	-29.04	56.14	26.83	0.06	0.21	QP
6	0.4914980	22.72	-23.42	46.14	22.45	0.06	0.21	Average
7	0.6574510	31.12	-24.88	56.00	30.38	0.11	0.63	QP
8	0.6574510	21.69	-24.31	46.00	20.95	0.11	0.63	Average
9	0.8235320	23.18	-22.82	46.00	22.38	0.11	0.69	Average
10	0.8235320	29.67	-26.33	56.00	28.87	0.11	0.69	QP
11	0.9808100	28.16	-27.84	56.00	27.40	0.11	0.65	QP
12	0.9808100	23.49	-22.51	46.00	22.73	0.11	0.65	Average



Neutral to Ground

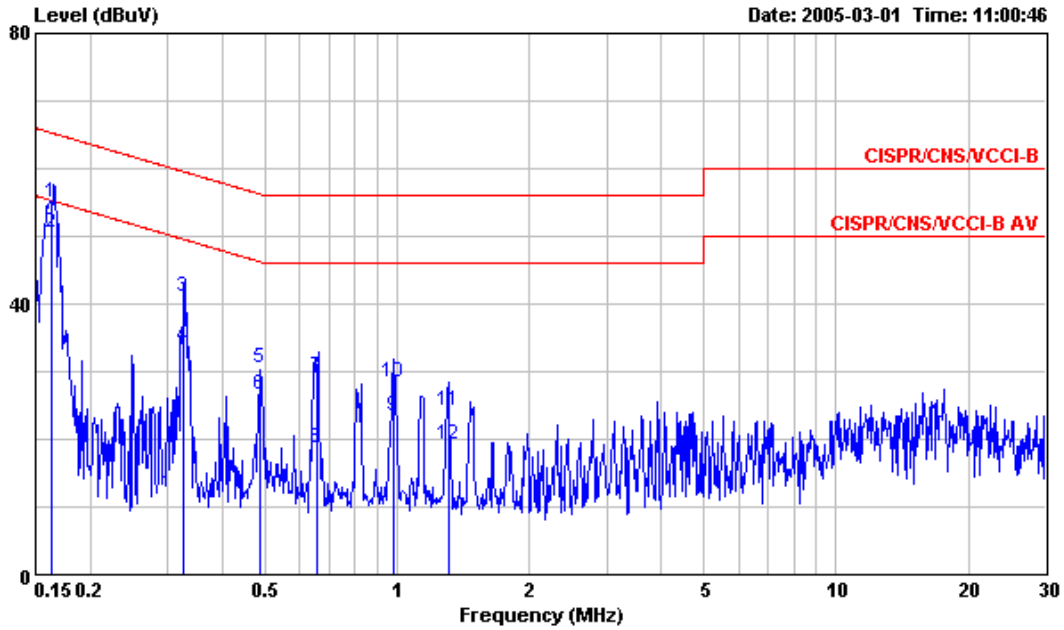

	Freq	Level	Over Limit	Limit Line	Read Level	LISN Factor	Cable Loss	Remark
	MHz	dBuV	dB	dBuV	dBuV	dB	dB	
1	0.1637300	54.94	-10.33	65.27	54.40	0.11	0.43	QP
2	0.1637300	50.58	-4.69	55.27	50.04	0.11	0.43	Average
3	0.3263580	41.01	-18.53	59.54	40.59	0.11	0.31	QP
4	0.3263580	33.77	-15.77	49.54	33.35	0.11	0.31	Average
5	0.4863180	30.44	-25.79	56.23	29.99	0.24	0.21	QP
6	0.4863180	26.56	-19.67	46.23	26.11	0.24	0.21	Average
7	0.6587210	29.17	-26.83	56.00	28.31	0.23	0.63	QP
8	0.6587210	18.74	-27.26	46.00	17.88	0.23	0.63	Average
9	0.9774440	23.52	-22.48	46.00	22.64	0.23	0.65	Average
10	0.9774440	28.51	-27.49	56.00	27.63	0.23	0.65	QP
11	1.309	24.17	-31.83	56.00	23.46	0.23	0.48	QP
12	1.309	19.15	-26.85	46.00	18.44	0.23	0.48	Average

Note:

Corrected Reading: Probe (LISN / ISN) Factor + Cable Loss + Read Level = Level.

5.5.8. Photographs of Conducted Emission Test Configuration

Mode 1

FRONT VIEW



REAR VIEW



Mode 2

FRONT VIEW



REAR VIEW

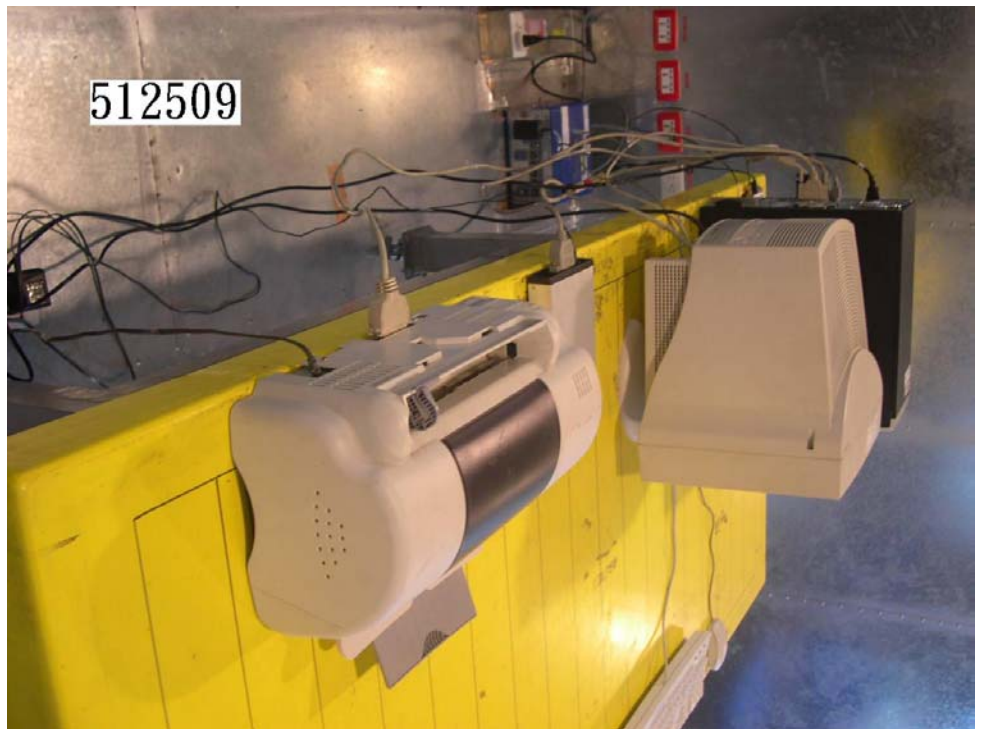

5.6. Test of Spurious Radiated Emission

5.6.1. Applicable Standard

Section 15.247(d): In any 100 kHz bandwidth outside the frequency band in which the spread spectrum or digitally modulated intentional radiator is operating, the radio frequency power that is produced by the intentional radiator shall be at least 20 dB below that in the 100 kHz bandwidth within the band that contains the highest level of the desired power, based on either an RF conducted or a radiated measurement. In addition, radiated emissions that fall in the restricted bands, as defined in Section 15.205, must also comply with the radiated emission limits specified in Section 15.209.

5.6.2. Measuring Instruments

Please reference item 1~17 in chapter 6 for the instruments used for testing.

5.6.3. Description of Major Test Instruments Setting

- Spectrum Analyzer : R&S FSP40
 - Attenuation : Auto
 - Start Frequency : 1000 MHz
 - Stop Frequency : 10th carrier harmonic
 - RB / VB : 1 MHz / 1MHz for Peak
 - RB / VB : 1 MHz / 10Hz for Average

- Test Receiver : R&S ESCS 30
 - Attenuation : Auto
 - Start Frequency : 30 MHz
 - Stop Frequency : 1000 MHz
 - RB : 120 KHz for QP or PK

5.6.4. Test Procedures

1. Configure the EUT according to ANSI C63.4.
2. The EUT was placed on the top of the turntable 0.8 meter above ground.
3. The phase center of the receiving antenna mounted on the top of a height-variable antenna tower was placed 3 meters far away from the turntable.
4. Power on the EUT and all the supporting units.
5. The turntable was rotated by 360 degrees to determine the position of the highest radiation.
6. The height of the broadband receiving antenna was varied between one meter and four meters above ground to find the maximum emission field strength of both horizontal and vertical polarization.
7. For each suspected emission, the antenna tower was scan (from 1 M to 4 M) and then the turntable was rotated (from 0 degree to 360 degrees) to find the maximum reading.
8. Set the test-receiver system to Peak or CISPR quasi-peak Detect Function with specified bandwidth under Maximum Hold Mode.
9. For emission above 1GHz, use 1MHz VBW and RBW for peak reading. Then 1MHz RBW and 10Hz VBW for average reading in spectrum analyzer.

10. If the emission level of the EUT in peak mode was 3 dB lower than the average limit specified, then testing will be stopped and peak values of EUT will be reported, otherwise, the emissions which do not have 3 dB margin will be repeated one by one using the quasi-peak method for below 1GHz and average method for above the 1GHz. the reported.
11. For testing above 1GHz, the emission level of the EUT in peak mode was 20dB higher than average limit (that means the emission level in peak mode also complies with the limit in average mode), then testing will be stopped and peak values of EUT will be reported, otherwise, the emissions will be measured in average mode again and reported.

5.6.5. Test Setup Layout

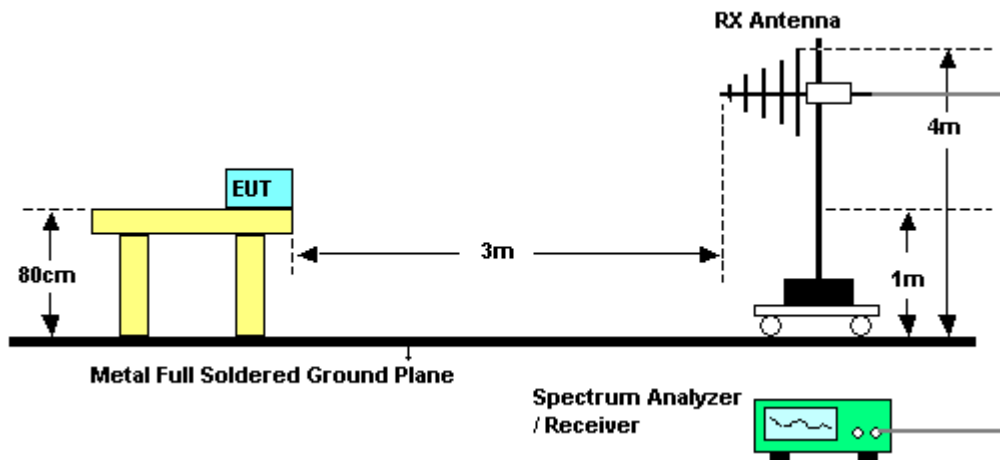

5.6.6. Test Criteria

All test results complied with the requirements of 15.247(d). Measurement Uncertainty is 2.26dB.



5.6.7. Test Results for CH 11 / 2462 MHz (for emission below 1GHz)

- Modulation Type: OFDM
- Temperature: 24°C
- Relative Humidity: 55%
- Duty Cycle of the Equipment During the Test: 100.00%
- Test Engineer: Ted Chiu

(A) Polarization: Horizontal

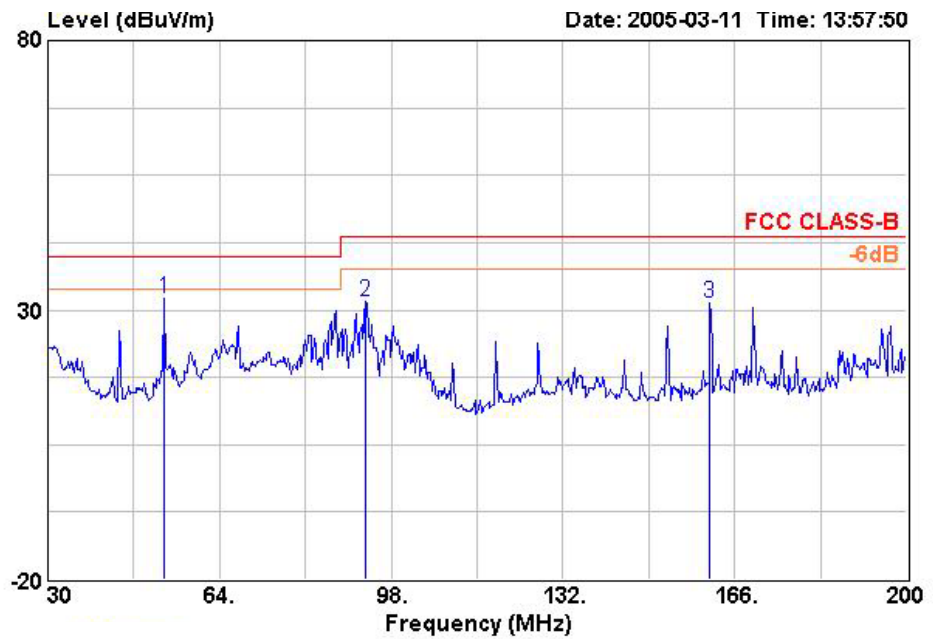

	Freq	Level	Read Level	Over Limit	Limit	Antenna Line Factor	Cable Loss	Preamp Factor	Remark
	MHz	dBUV/m	dBuV	dB	dBUV/m	dB/m	dB	dB	
1	52.950	32.15	47.49	-7.85	40.00	11.13	0.71	27.18	Peak
2	92.900	31.54	49.36	-11.96	43.50	8.65	0.92	27.39	Peak
3	161.070	31.39	43.97	-12.11	43.50	12.73	1.27	26.58	Peak

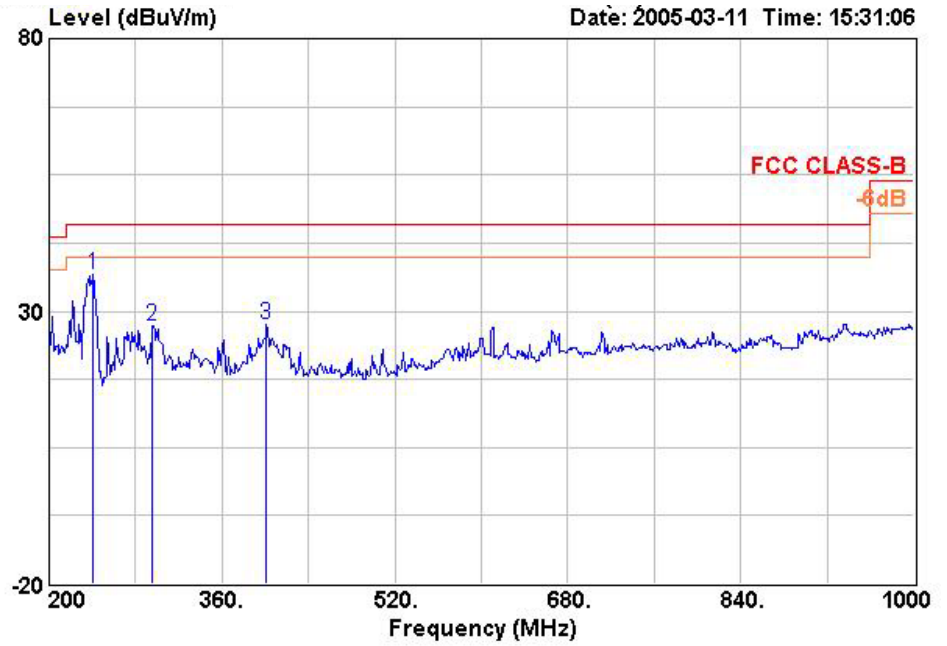

	Freq	Level	Read Level	Over Limit	LimitAntenna Line	Factor	Cable Loss	Preamp Factor	Remark
	MHz	dBuV/m	dBuV	dB	dBuV/m	dB/m	dB	dB	
1	240.800	36.65	48.50	-9.35	46.00	13.00	1.54	26.39	Peak
2	295.200	27.42	37.89	-18.58	46.00	13.65	1.68	25.81	Peak
3	400.800	27.70	35.63	-18.30	46.00	16.79	1.98	26.71	Peak



(B) Polarization: Vertical

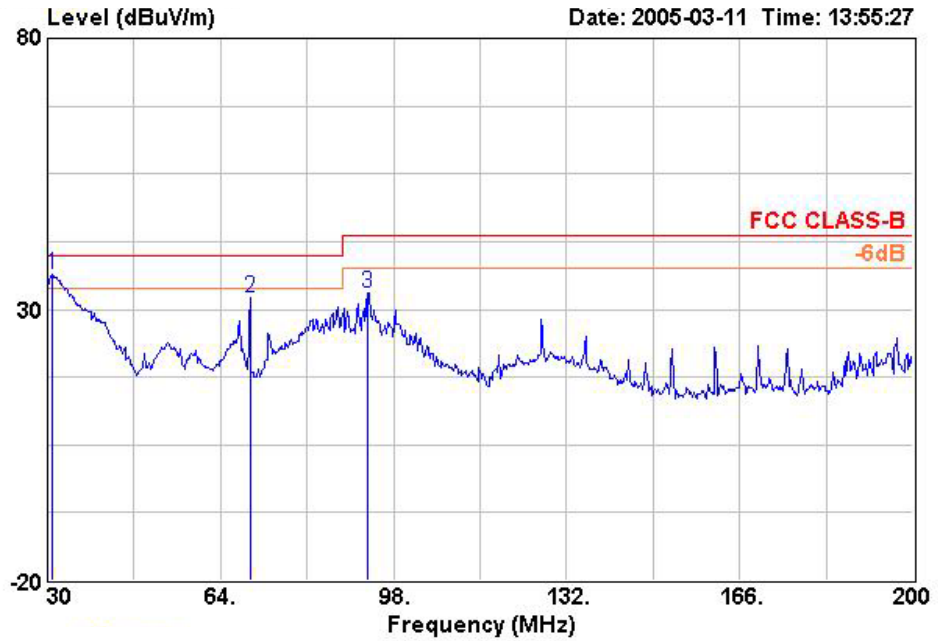

	Freq	Level	Read Level	Over Limit	Limit	Antenna Line Factor	Cable Loss	Preamp Factor	Remark
	MHz	dBuV/m	dBuV	dB	dBuV/m	dB/m	dB	dB	
1	31.020	36.48	50.30	-3.52	40.00	12.80	0.57	27.19	Peak
2	69.780	32.14	48.81	-7.86	40.00	9.81	0.82	27.31	Peak
3	92.900	33.00	50.82	-10.50	43.50	8.65	0.92	27.39	Peak

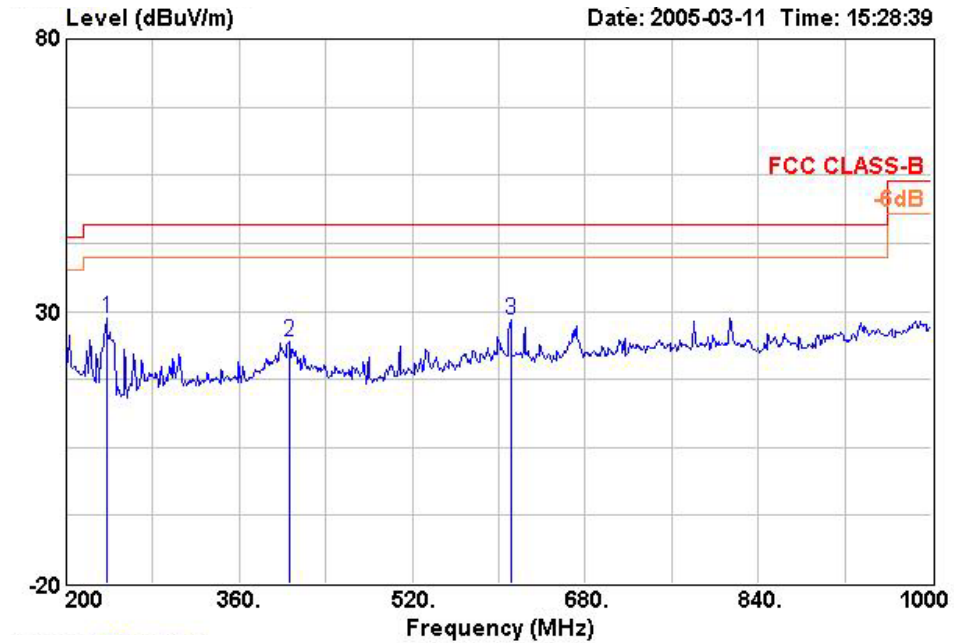

	Freq	Level	Read Level	Over Limit	Limit	Antenna Line Factor	Cable Loss	Preamp Factor	Remark
	MHz	dBuV/m	dBuV	dB	dBuV/m	dB/m	dB	dB	
1	236.800	28.66	40.01	-17.34	46.00	13.32	1.51	26.19	Peak
2	406.400	24.49	32.45	-21.51	46.00	16.75	1.97	26.68	Peak
3	611.200	28.30	32.66	-17.70	46.00	20.43	2.42	27.21	Peak

Note:

Emission level (dBUV/m) = 20 log Emission level (uV/m)

Corrected Reading: Probe Factor + Cable Loss + Read Level - Preamp Factor = Level



5.6.8. Test Results for CH 01 / 2412 MHz (for emission above 1GHz)

- Modulation Type: DSSS
- Temperature: 24°C
- Relative Humidity: 55%
- Duty Cycle of the Equipment During the Test: 100.00%
- Test Engineer: Ted Chiu

(A) Polarization: Horizontal

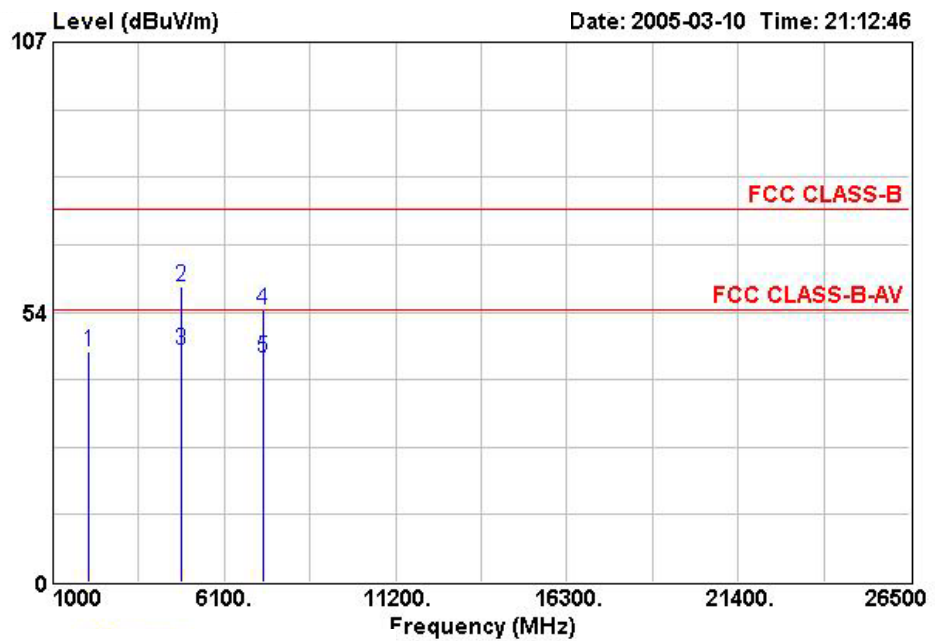

	Freq	Level	Read Level	Over Limit	Limit	Antenna Line Factor	Cable Loss	Preamp Factor	Remark
	MHz	dBuV/m	dBuV	dB	dBuV/m	dB/m	dB	dB	
1	2038.000	45.83	56.27	-28.17	74.00	27.48	1.73	39.65	Peak
2	4824.000	58.44	62.75	-15.56	74.00	32.99	2.84	40.14	Peak
3	4824.000	45.98	50.29	-8.02	54.00	32.99	2.84	40.14	Average
4	7236.000	53.96	53.99	-20.04	74.00	35.82	3.62	39.47	Peak
5	7236.000	44.37	44.40	-9.63	54.00	35.82	3.62	39.47	Average



(B) Polarization: Vertical

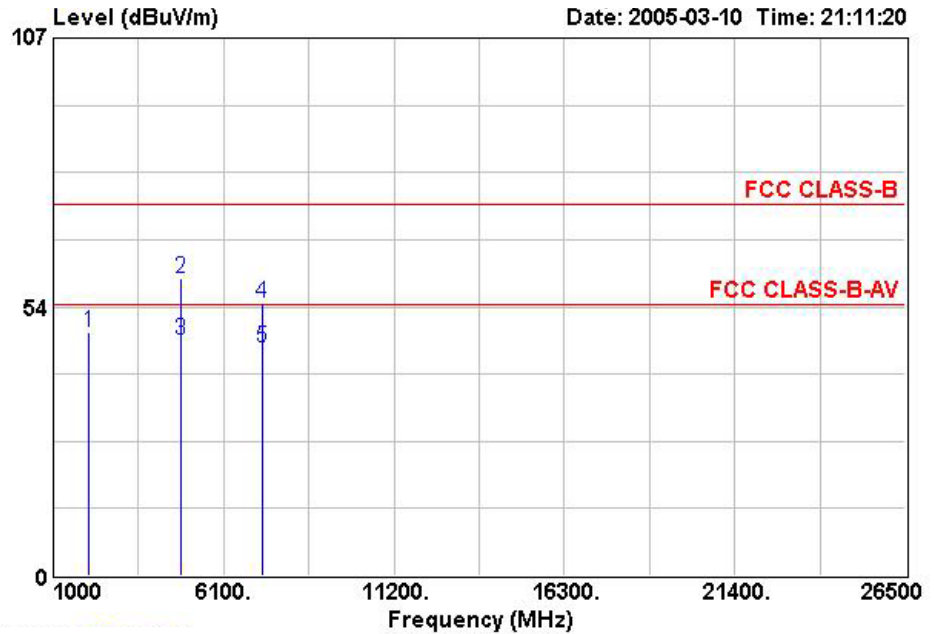

	Freq	Level	Read Level	Over Limit	Limit	Antenna Line Factor	Cable Loss	Preamp Factor	Remark
	MHz	dBUV/m	dBuV	dB	dBUV/m	dB/m	dB	dB	
1	2038.000	48.43	58.87	-25.57	74.00	27.48	1.73	39.65	Peak
2	4824.000	59.18	63.49	-14.82	74.00	32.99	2.84	40.14	Peak
3	4824.000	47.04	51.35	-6.96	54.00	32.99	2.84	40.14	Average
4	7240.000	54.15	54.18	-19.85	74.00	35.82	3.62	39.47	Peak
5	7240.000	45.30	45.33	-8.70	54.00	35.82	3.62	39.47	Average

Note:

Emission level (dBUV/m) = 20 log Emission level (uV/m)

Corrected Reading: Probe Factor + Cable Loss + Read Level - Preamp Factor = Level



- Modulation Type: OFDM
- Temperature: 24°C
- Relative Humidity: 55%
- Duty Cycle of the Equipment During the Test: 100.00%
- Test Engineer: Ted Chiu

(A) Polarization: Horizontal

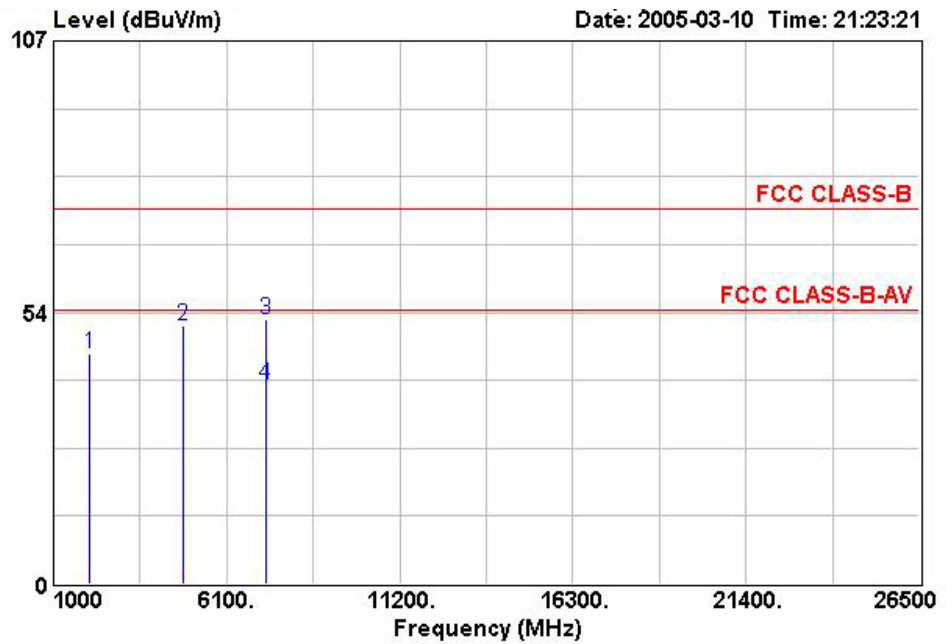

	Freq	Level	Read	Over	Limit	Antenna	Cable	Preamp	Remark
	MHz	dBuV/m	Level	Limit	dBuV/m	dB/m	Loss	Factor	
			dBuV	dB			dB	dB	
1	2038.000	45.45	55.89	-28.55	74.00	27.48	1.73	39.65	Peak
2	4824.000	50.86	55.17	-23.14	74.00	32.99	2.84	40.14	Peak
3	7236.000	52.14	52.17	-21.86	74.00	35.82	3.62	39.47	Peak
4	7236.000	39.17	39.20	-14.83	54.00	35.82	3.62	39.47	Average



(B) Polarization: Vertical

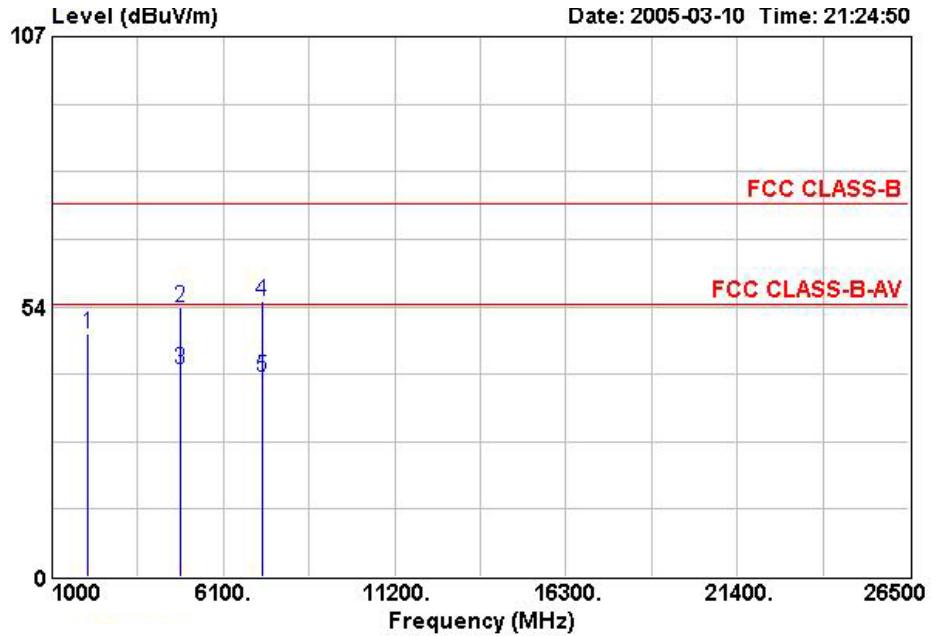

	Freq	Level	Read Level	Over Limit	Limit	Antenna Line Factor	Cable Loss	Preamp Factor	Remark
	MHz	dBuV/m	dBuV	dB	dBuV/m	dB/m	dB	dB	
1	2038.000	48.17	58.61	-25.83	74.00	27.48	1.73	39.65	Peak
2	4828.000	53.45	57.76	-20.55	74.00	32.99	2.84	40.14	Peak
3	4828.000	41.17	45.48	-12.83	54.00	32.99	2.84	40.14	Average
4	7236.000	54.65	54.68	-19.35	74.00	35.82	3.62	39.47	Peak
5	7236.000	39.48	39.51	-14.52	54.00	35.82	3.62	39.47	Average

Note:

Emission level (dBuV/m) = 20 log Emission level (uV/m)

Corrected Reading: Probe Factor + Cable Loss + Read Level - Preamp Factor = Level



5.6.9. Test Results for CH 06 / 2437 MHz (for emission above 1GHz)

- Modulation Type: DSSS
- Temperature: 24°C
- Relative Humidity: 55%
- Duty Cycle of the Equipment During the Test: 100.00%
- Test Engineer: Ted Chiu

(A) Polarization: Horizontal

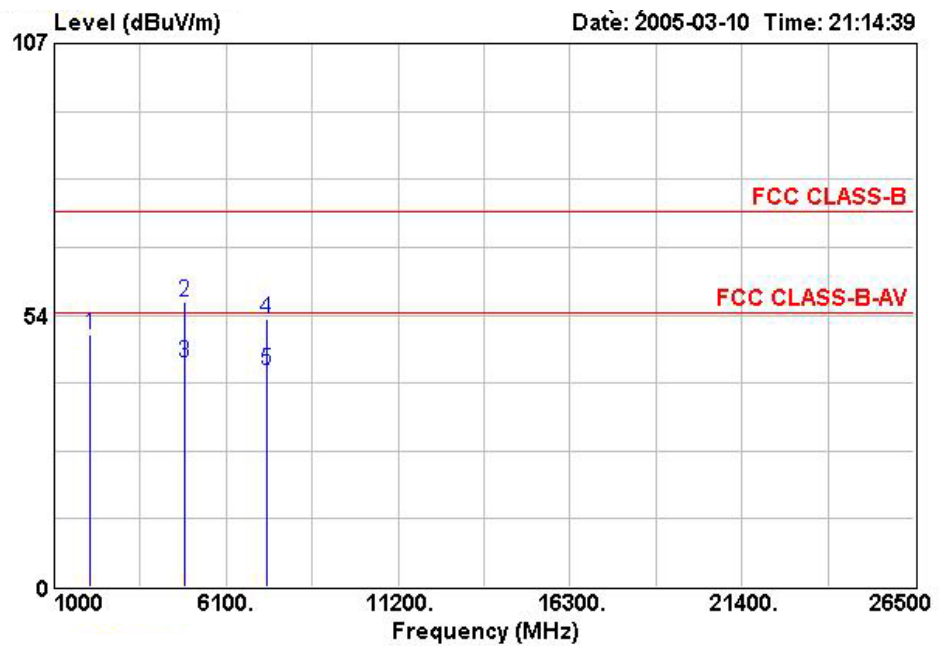

	Freq	Level	Read Level	Over Limit	Limit	Antenna Line Factor	Cable Loss Factor	Preamp Factor	Remark
	MHz	dBUV/m	dBuV	dB	dBUV/m	dB/m	dB	dB	
1	2062.000	49.69	60.07	-24.31	74.00	27.51	1.75	39.64	Peak
2	4876.000	56.17	60.36	-17.83	74.00	33.08	2.87	40.14	Peak
3	4876.000	44.24	48.43	-9.76	54.00	33.08	2.87	40.14	Average
4	7308.000	52.68	52.45	-21.32	74.00	36.03	3.65	39.45	Peak
5	7308.000	42.50	42.27	-11.50	54.00	36.03	3.65	39.45	Average



(B) Polarization: Vertical

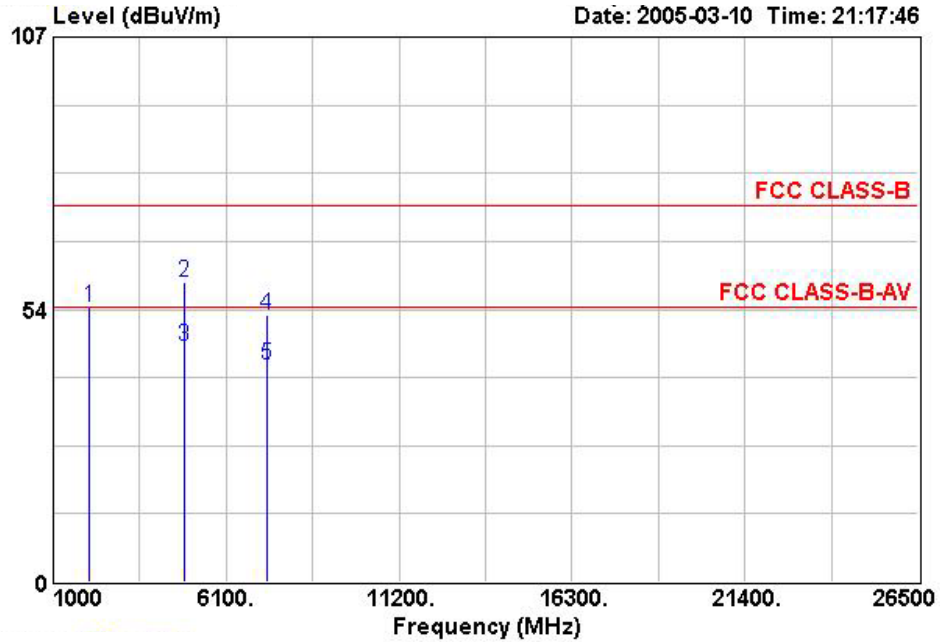

	Freq	Level	Read Level	Over Limit	Limit	Antenna Line Factor	Cable Loss	Preamp Factor	Remark
	MHz	dBUV/m	dBuV	dB	dBUV/m	dB/m	dB	dB	
1	2062.000	53.94	64.32	-20.06	74.00	27.51	1.75	39.64	Peak
2	4876.000	58.83	63.02	-15.17	74.00	33.08	2.87	40.14	Peak
3	4876.000	46.26	50.45	-7.74	54.00	33.08	2.87	40.14	Average
4	7304.000	52.47	52.24	-21.53	74.00	36.03	3.65	39.45	Peak
5	7304.000	42.53	42.30	-11.47	54.00	36.03	3.65	39.45	Average

Note:

Emission level (dBUV/m) = 20 log Emission level (uV/m)

Corrected Reading: Probe Factor + Cable Loss + Read Level - Preamp Factor = Level



- Modulation Type: OFDM
- Temperature: 24°C
- Relative Humidity: 55%
- Duty Cycle of the Equipment During the Test: 100.00%
- Test Engineer: Ted Chiu

(A) Polarization: Horizontal

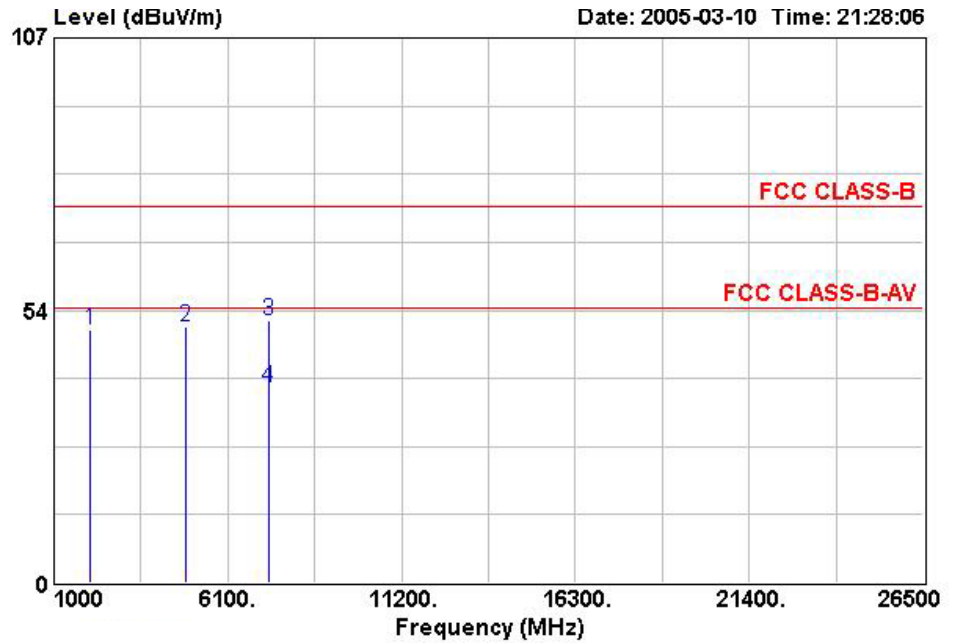

	Freq	Level	Read Level	Over Limit	Limit	Antenna Line Factor	Cable Loss	Preamp Factor	Remark
	MHz	dBUV/m	dBuV	dB	dBUV/m	dB/m	dB	dB	
1	2062.000	49.53	59.91	-24.47	74.00	27.51	1.75	39.64	Peak
2	4876.000	50.21	54.40	-23.79	74.00	33.08	2.87	40.14	Peak
3	7300.000	51.66	51.44	-22.34	74.00	36.03	3.65	39.46	Peak
4	7300.000	38.48	38.26	-15.52	54.00	36.03	3.65	39.46	Average



(B) Polarization: Vertical

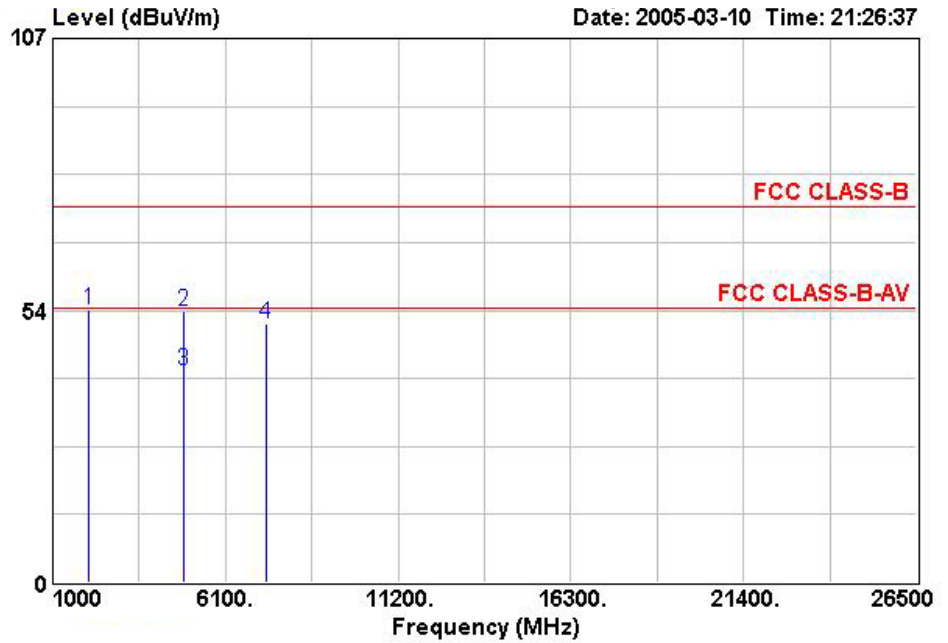

	Freq	Level	Read Level	Over Limit	Limit	Antenna Line Factor	Cable Loss	Preamp Factor	Remark
	MHz	dBuV/m	dBuV	dB	dBuV/m	dB/m	dB	dB	
1	2062.000	53.72	64.10	-20.28	74.00	27.51	1.75	39.64	Peak
2	4872.000	53.30	57.49	-20.70	74.00	33.08	2.87	40.14	Peak
3	4872.000	41.65	45.84	-12.35	54.00	33.08	2.87	40.14	Average
4	7316.000	51.00	50.72	-23.00	74.00	36.08	3.65	39.45	Peak

Note:

Emission level (dBuV/m) = 20 log Emission level (uV/m)

Corrected Reading: Probe Factor + Cable Loss + Read Level - Preamp Factor = Level



5.6.10. Test Results for CH 11 / 2462 MHz (for emission above 1GHz)

- Modulation Type: DSSS
- Temperature: 24°C
- Relative Humidity: 55%
- Duty Cycle of the Equipment During the Test: 100.00%
- Test Engineer: Ted Chiu

(A) Polarization: Horizontal

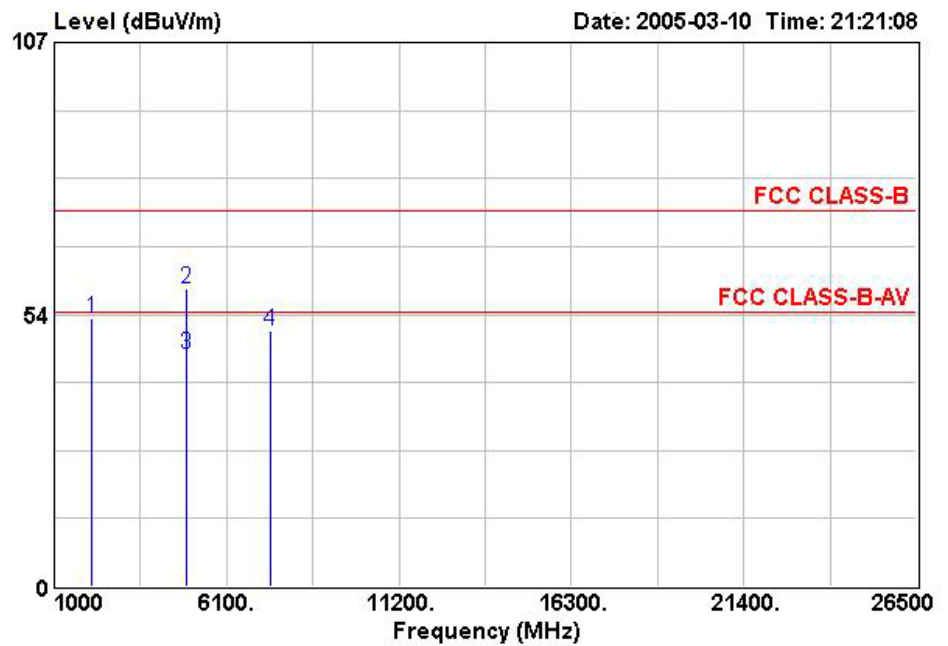

	Freq	Level	Read Level	Over Limit	Limit	Antenna Line	Cable Loss	Preamp Factor	Remark
	MHz	dBuV/m	dBuV	dB	dBuV/m	dB/m	dB	dB	
1	2086.000	52.88	63.18	-21.12	74.00	27.59	1.75	39.64	Peak
2	4924.000	58.42	62.50	-15.58	74.00	33.18	2.89	40.15	Peak
3	4924.000	45.55	49.63	-8.45	54.00	33.18	2.89	40.15	Average
4	7388.000	50.24	49.71	-23.76	74.00	36.29	3.68	39.43	Peak



(B) Polarization: Vertical

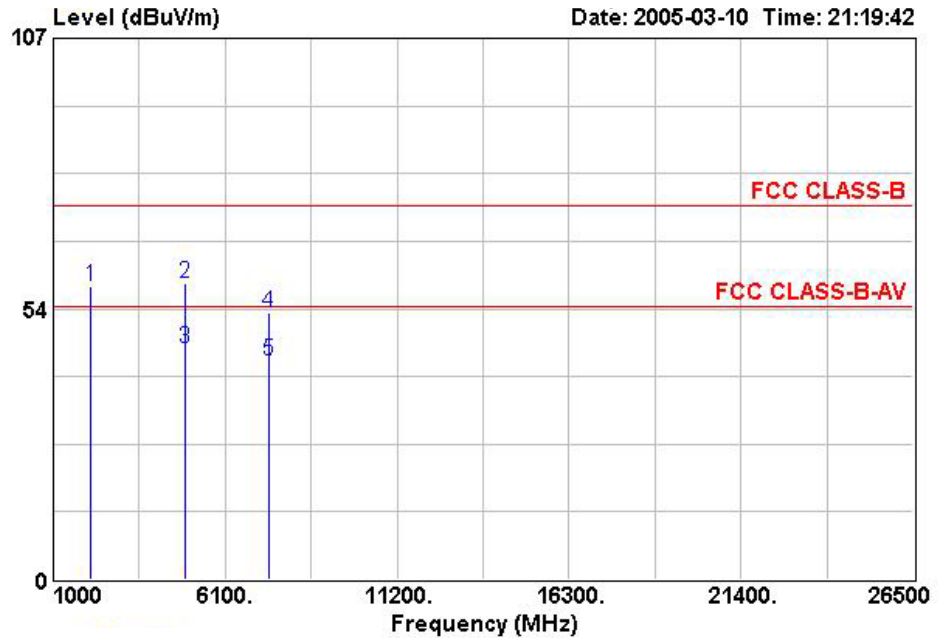

	Freq	Level	Read	Over	Limit	Antenna	Cable	Preamp	Remark
	MHz	dBUV/m	dBuV	dB	dBUV/m	dB/m	dB	dB	
1	2086.000	57.83	68.13	-16.17	74.00	27.59	1.75	39.64	Peak
2	4924.000	58.68	62.76	-15.32	74.00	33.18	2.89	40.15	Peak
3	4924.000	45.77	49.85	-8.23	54.00	33.18	2.89	40.15	Average
4	7388.000	52.73	52.20	-21.27	74.00	36.29	3.68	39.43	Peak
5	7388.000	43.11	42.58	-10.89	54.00	36.29	3.68	39.43	Average

Note:

Emission level (dBUV/m) = 20 log Emission level (uV/m)

Corrected Reading: Probe Factor + Cable Loss + Read Level - Preamp Factor = Level



- Modulation Type: OFDM
- Temperature: 24°C
- Relative Humidity: 55%
- Duty Cycle of the Equipment During the Test: 100.00%
- Test Engineer: Ted Chiu

(A) Polarization: Horizontal

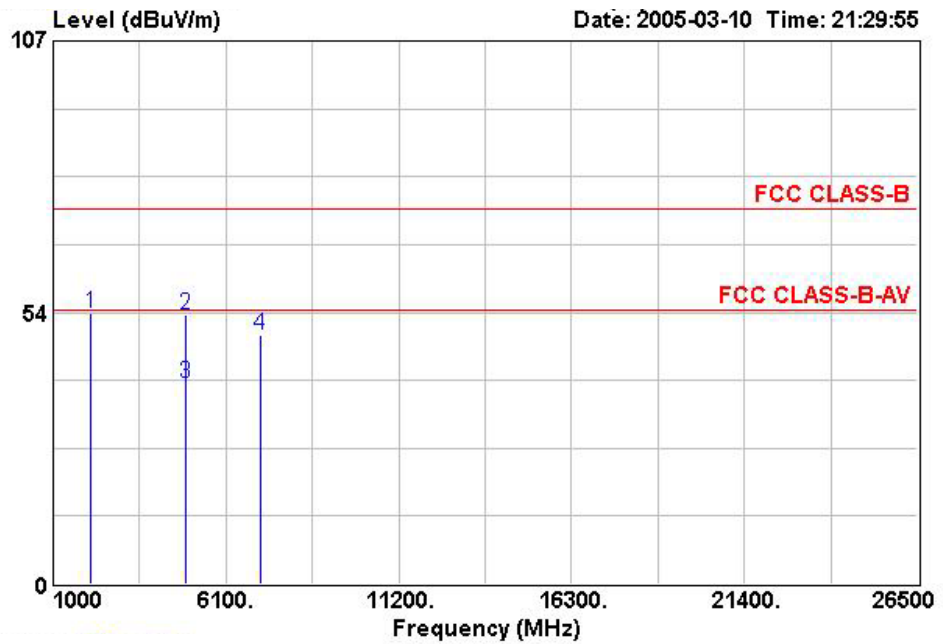

	Freq	Level	Read Level	Over Limit	Limit	Antenna Line Factor	Cable Loss	Preamp Factor	Remark
	MHz	dBuV/m	dBuV	dB	dBuV/m	dB/m	dB	dB	
1	2086.000	53.27	63.57	-20.73	74.00	27.59	1.75	39.64	Peak
2	4928.000	53.13	57.21	-20.87	74.00	33.18	2.89	40.15	Peak
3	4928.000	39.51	43.59	-14.49	54.00	33.18	2.89	40.15	Average
4	7128.000	49.10	49.57	-24.90	74.00	35.46	3.58	39.51	Peak



(B) Polarization: Vertical

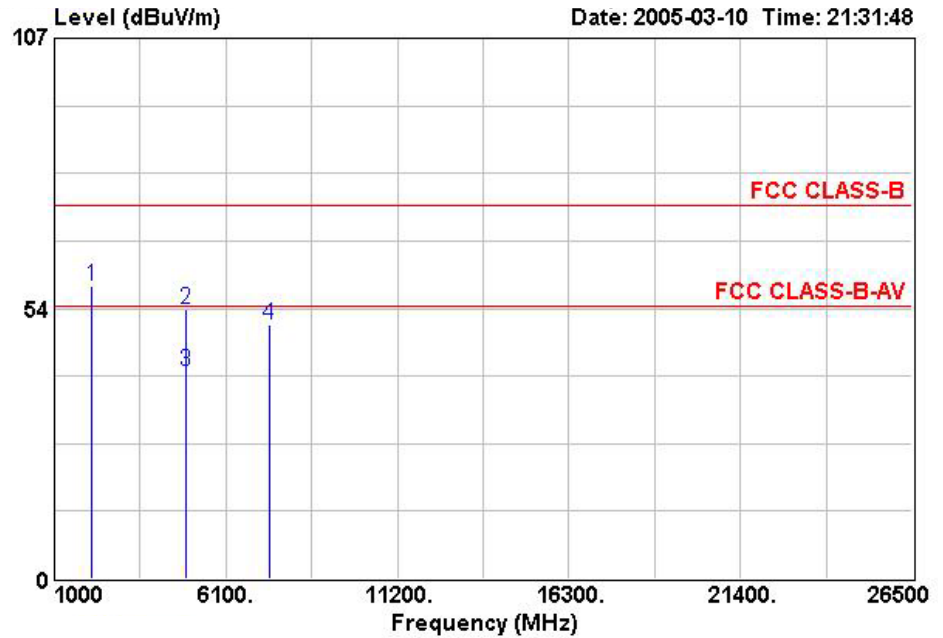

	Freq	Level	Read Level	Over Limit	Limit	Antenna Line Factor	Cable Loss	Preamp Factor	Remark
	MHz	dBuV/m	dBuV	dB	dBuV/m	dB/m	dB	dB	
1	2086.000	58.02	68.32	-15.98	74.00	27.59	1.75	39.64	Peak
2	4928.000	53.32	57.40	-20.68	74.00	33.18	2.89	40.15	Peak
3	4928.000	41.21	45.29	-12.79	54.00	33.18	2.89	40.15	Average
4	7384.000	50.26	49.73	-23.74	74.00	36.29	3.68	39.43	Peak

Note:

Emission level (dBUV/m) = 20 log Emission level (uV/m)

Corrected Reading: Probe Factor + Cable Loss + Read Level - Preamp Factor = Level

5.6.11. Photographs of Radiated Emission Test Configuration

FRONT VIEW

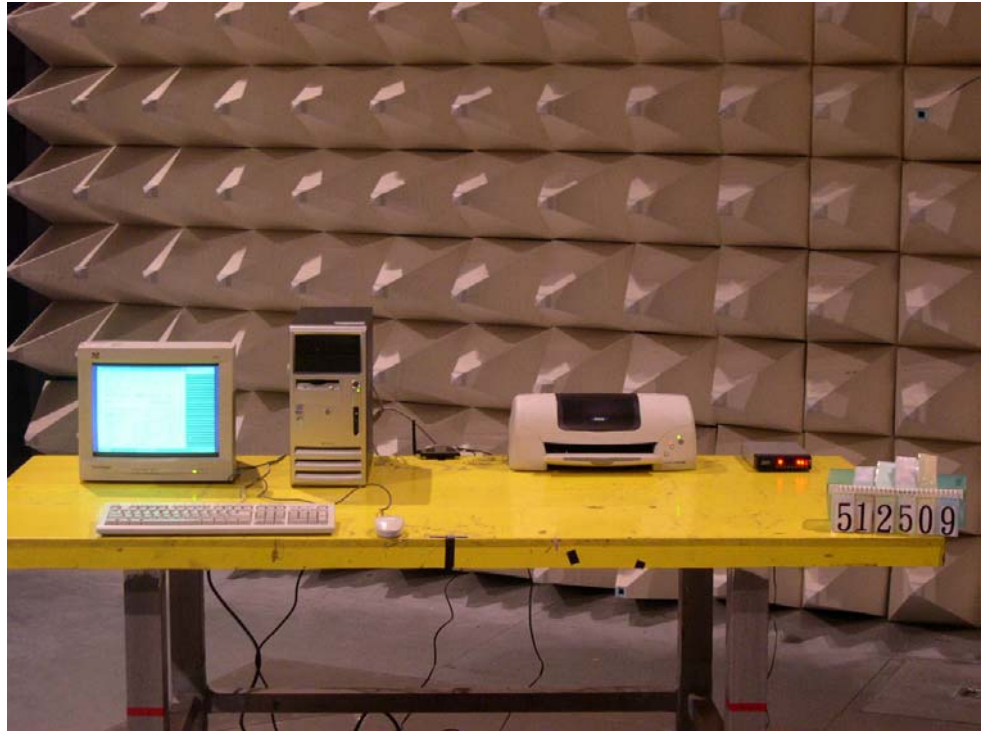

REAR VIEW





5.7. Antenna Requirements

5.7.1. Standard Applicable

Section 15.203:

An intentional radiator shall be designed to ensure that no antenna other than that furnished by the responsible party shall be used with the device. The use of a permanently attached antenna or of an antenna that uses a unique coupling to the intentional radiator shall be considered sufficient to comply with the provisions of this Section. The manufacturer may design the unit so that a broken antenna can be replaced by the user, but the use of a standard antenna jack or electrical connector is prohibited.

Section 15.247(b)/(c):

If transmitting antennas of directional gain greater than 6 dBi are used, the peak output power from the intentional radiator shall be reduced by the amount in dB that the directional gain of the antenna exceeds 6 dBi.

If the intentional radiator is used exclusively for fixed, point-to-point operations may employ transmitting antennas with directional gain greater than 6 dBi provided the maximum peak output power of the intentional radiator is reduced by 1 dB for every 3 dB that the directional gain of the antenna exceeds 6 dBi.

5.7.2. Antenna Connected Construction

The antenna connector for Dipole antenna is reverse-SMA.

All antennas gain of EUT are less than 6dBi. Therefore peak conducted power limit shall not be degraded any more. Antenna report of manufacturer will have more detail antenna gain or antenna pattern.

5.7.3. Test Criteria

All test results complied with the requirements of 15.203/15.247(b)/(c).

5.8. RF Exposure

5.8.1. Limit For Maximum Permissible Exposure (MPE)

This product can be classified as mobile device, so the 20cm separation distance warning is required. In this section, the power density at 20cm location is calculated to examine if it is lower than the limit.

(A) Limits for Occupational / Controlled Exposure

Frequency Range (MHz)	Electric Field Strength (E) (V/m)	Magnetic Field Strength (H) (A/m)	Power Density (S) (mW/ cm ²)	Averaging Time E ² , H ² or S (minutes)
0.3-3.0	614	1.63	(100)*	6
3.0-30	1842 / f	4.89 / f	(900 / f)*	6
30-300	61.4	0.163	1.0	6
300-1500			F/300	6
1500-100,000			5	6

(B) Limits for General Population / Uncontrolled Exposure

Frequency Range (MHz)	Electric Field Strength (E) (V/m)	Magnetic Field Strength (H) (A/m)	Power Density (S) (mW/cm ²)	Averaging Time E ² , H ² or S (minutes)
0.3-1.34	614	1.63	(100)*	30
1.34-30	824/f	2.19/f	(180/f)*	30
30-300	27.5	0.073	0.2	30
300-1500			F/1500	30
1500-100,000			1.0	30

F = frequency in MHz

*Plane-wave equivalent power density

5.8.2. MPE Calculation Method

$$E \text{ (V/m)} = \frac{\sqrt{30 \times P \times G}}{d} \qquad \text{Power Density: } Pd \text{ (mW/cm}^2\text{)} = \frac{E^2}{377}$$

E = Electric field (V/m)

P = Peak RF output power (mW)

G = EUT Antenna numeric gain (numeric)

d = Separation distance between radiator and human body (m)

The formula can be changed to

$$Pd = \frac{30 \times P \times G}{377 \times d^2}$$

From the peak EUT RF output power, the minimum mobile separation distance, d=20cm, as well as the gain of the used antenna, the RF power density can be obtained.



5.8.3. Calculated Result and Limit

- Modulation Type: DSSS
- Temperature: 24°C
- Relative Humidity: 55%
- Duty Cycle of the Equipment During the Test: 100.00%
- Test Engineer: Ted Chiu

Channel No.	Antenna Gain (dBi)	Antenna Gain (numeric)	Peak Output Power (dBm)	Peak Output Power (mW)	Power Density (S) (mW/cm ²)	Limit of Power Density (S) (mW/cm ²)
01	2.00	1.58	22.23	167.11	0.0526	1
06	2.00	1.58	19.98	99.54	0.0313	1
11	2.00	1.58	17.75	59.57	0.0187	1

- Modulation Type: OFDM
- Temperature: 24°C
- Relative Humidity: 55%
- Duty Cycle of the Equipment During the Test: 100.00%
- Test Engineer: Ted Chiu

Channel No.	Antenna Gain (dBi)	Antenna Gain (numeric)	Peak Output Power (dBm)	Peak Output Power (mW)	Power Density (S) (mW/cm ²)	Limit of Power Density (S) (mW/cm ²)
01	2.00	1.58	20.75	118.85	0.0374	1
06	2.00	1.58	18.22	66.37	0.0209	1
11	2.00	1.58	15.52	35.65	0.0112	1

6. List of Measuring Equipments Used

Items	Instrument	Manufacturer	Model No.	Serial No.	Characteristics	Calibration Date	Remark
1	EMC Receiver	R&S	ESCS 30	100174	9 KHz – 2.75 GHz	Feb. 15, 2005	Conduction (CO04-HY)
2	LISN	MessTec	NNB-2/16Z	2001/004	9 KHz – 30 MHz	Jun. 09, 2004	Conduction (CO04-HY)
3	LISN (Support Unit)	MessTec	NNB-2/16Z	99041	9 KHz – 30 MHz	Apr. 27, 2004	Conduction (CO04-HY)
4	EMI Filter	LINDGREN	LRE-2030	2651	< 450 Hz	N/A	Conduction (CO04-HY)
5	RF Cable-CON	UTIFLEX	3102-26886-4	CB044	9KHz~30MHz	Apr. 21, 2004	Conduction (CO04-HY)
6	3m Semi Anechoic Chamber	SIDT FRANKONIA	SAC-3M	03CH03-HY	30MHz~1GHz 3m	Jun. 21, 2004	Radiation (03CH03-HY)
7	Spectrum analyzer	R&S	FSP40	100004	9KHZ~40GHz	Aug. 31, 2004	Radiation (03CH03-HY)
8	Amplifier	SCHAFFNER	CPA9231A	18667	9KHz – 2GHz	Jan. 10, 2005	Radiation (03CH03-HY)
9	Biconical Antenna	SCHWARZBECK	VHBB 9124	301	30MHz – 200MHz	Jul. 28, 2004	Radiation (03CH03-HY)
10	Log Antenna	SCHWARZBECK	VUSLP 9111	221	200MHz -1GHz	Jul. 28, 2004	Radiation (03CH03-HY)
11	RF Cable-R03m	Jye Bao	RG142	CB021	30MHz~1GHz	Feb. 22, 2005	Radiation (03CH03-HY)
12	Amplifier	MITEQ	AFS44	849984	100MHz~26.5GHz	Mar. 26, 2004	Radiation (03CH03-HY)
13	Horn Antenna	EMCO	3115	6741	1GHz – 18GHz	Apr. 07, 2004	Radiation (03CH03-HY)
14	Turn Table	HD	DS 420	420/650/00	0 ~ 360 degree	N/A	Radiation (03CH03-HY)
15	Antenna Mast	HD	MA 240	240/560/00	1 m - 4 m	N/A	Radiation (03CH03-HY)
16	Horn Antenna	Schwarzbeck	BBHA9170	154	18GHz~40GHz	Jun. 09, 2004	Radiation (03CH03-HY)
17	RF Cable-HIGH	Jye Bao	RG142	CB030-HIGH	1GHz~29.5GHz	Dec.01, 2004	Radiation (03CH03-HY)

※ Calibration Interval of instruments listed above is one year.



Items	Instrument	Manufacturer	Model No.	Serial No.	Characteristics	Calibration Date	Remark
18	Spectrum analyzer	R&S	FSP30	100023	9KHZ~30GHZ	Aug. 02, 2004	Conducted (TH01-HY)
19	Power meter	R&S	NRVS	100444	DC~40GHz	Jun. 15, 2004	Conducted (TH01-HY)
20	Power sensor	R&S	NRV-Z55	100049	DC~40GHz	Jun. 15, 2004	Conducted (TH01-HY)
21	Power Sensor	R&S	NRV-Z32	100057	30MHz-6GHz	Jun. 15, 2004	Conducted (TH01-HY)
22	AC power source	HPC	HPA-500W	HPA-9100024	AC 0~300V	Jun. 16, 2004	Conducted (TH01-HY)
23	AC power source	G.W.	GPC-6030D	C671845	DC 1V~60V	Nov. 05, 2004	Conducted (TH01-HY)
24	Temp. and Humidity Chamber	KSON	THS-C3L	612	N/A	Oct. 01, 2004	Conducted (TH01-HY)
25	RF CABLE-1m	Jye Bao	RG142	CB034-1m	20MHz~7GHz	Jan. 01, 2005	Conducted (TH01-HY)
26	RF CABLE-2m	Jye Bao	RG142	CB035-2m	20MHz~1GHz	Jan. 01, 2005	Conducted (TH01-HY)

※ Calibration Interval of instruments listed above is one year.

7. Company Profile

SPORTON Lab. was established in 1986 with one shielded room: the first private EMI test facility, offering local manufacturers an alternative EMI test facility apart from ERSO. In 1988, one 3M and 10M/3M open area test site were setup and also obtained official accreditation from FCC, VCCI and NEMKO. In 1993, a Safety laboratory was founded and obtained accreditation from UL of USA, CSA of Canada and TUV (Rhineland & PS) of Germany. In 1995, one EMC lab, including EMI and EMS test facilities was setup. In 1997, SPORTON Group has provided financial expense to relocate the headquarter to Orient Scientific Park in Taipei Hsien to offer more comprehensive, more qualified and better service to local suppliers and manufactures. In 1999, Safety Group and Component Group were setup. In 2001, SPORTON has established 3M/10M chamber in Hwa Ya Technology Park.

7.1. Certificate of Accreditation

Taiwan	BSMI, CNLA, DGT
USA	FCC, NVLAP, UL
EU	Nemko, TUV
Japan	VCCI
Canada	Industry Canada

7.2. Test Location

SHIJR	ADD : 6Fl., No. 106, Sec. 1, Shintai 5th Rd., Shijr City, Taipei, Taiwan 221, R.O.C. TEL : 02-2696-2468 FAX : 02-2696-2255
HWA YA	ADD : No. 52, Hwa Ya 1st Rd., Hwa Ya Technology Park, Kwei-Shan Hsiang, Tao Yuan Hsien, Taiwan, R.O.C. TEL : 03-327-3456 FAX : 03-318-0055
LINKOU	ADD : No. 30-2, Dingfu Tsuen, Linkou Shiang, Taipei, Taiwan 244, R.O.C TEL : 02-2601-1640 FAX : 02-2601-1695
DUNGHU	ADD : No. 3, Lane 238, Kangle St., Neihu Chiu, Taipei, Taiwan 114, R.O.C. TEL : 02-2631-4739 FAX : 02-2631-9740
JUNGHE	ADD : 7Fl., No. 758, Jungjeng Rd., Junghe City, Taipei, Taiwan 235, R.O.C. TEL : 02-8227-2020 FAX : 02-8227-2626
NEIHU	ADD : 4Fl., No. 339, Hsin Hu 2 nd Rd., Taipei 114, Taiwan, R.O.C. TEL : 02-2794-8886 FAX : 02-2794-9777

8. CNLA Certificate of Accreditation

Test Lab. : Sporton International Inc.
Accreditation Number : 1190
Originally Accredited : 2003/12/15
Effective Period : 2003/12/15~2006/12/14
Accredited Scope : 47 CFR FCC Part 15 Subpart C (9kHz~40GHz)



Taiwan Accreditation Foundation
Chinese National Laboratory Accreditation
Certificate of Accreditation

Accreditation Criteria: ISO 17025
Accreditation Number: 1190
Organization/Laboratory: EMC & Wireless Communications Laboratory, Sporton International Inc.
Originally Accredited: December 15, 2003
Effective Period: December 15, 2003 To December 14, 2006
Accredited Scope: Electrical Testing Field, 7 items, details shown in the following pages.
Specific Accreditation Program: Recognition and Approval of Designated Laboratory for Commodities Inspection

President, Taiwan Accreditation Foundation
Date: July 19, 2004

(This document is invalid unless accompanied by all 4 pages)

CNLA-ZL03191E Page 1 of 4