

FCC RADIO TEST REPORT

according to

47 CFR FCC Part 15 Subpart C § 15.247

Equipment : HW2R1 Hi-Gain Wireless-N Dual Radio Smart Repeater
Model No. : HW2R1
Brand Name : HAWKING
Filing Type : New Application
Applicant : Hawking Technologies, Inc.
35 Hammond, Suite 150, Irvine, CA 92618, USA
FCC ID : SOY-HW2R1
Manufacturer : Hawking Technologies, Inc.
35 Hammond, Suite 150, Irvine, CA 92618, USA
Received Date : Dec. 04, 2008
Final Test Date : Jan. 05, 2010

Statement

Test result included is only for the 802.11b/g part of the product.

The test result in this report refers exclusively to the presented test model / sample.

Without written approval of SPORTON International Inc., the test report shall not be reproduced except in full.

The measurements and test results shown in this test report were made in accordance with the procedures and found in compliance with the limit given in **ANSI C63.4-2003** and **47 CFR FCC Part 15 Subpart C**.

The test equipment used to perform the test is calibrated and traceable to NML/ROC.



SPORTON International Inc.

6F, No. 106, Sec. 1, Hsin Tai Wu Rd., Hsi Chih, Taipei Hsien, Taiwan, R.O.C.

Table of Contents

1 SUMMARY OF THE TEST RESULT 2

2 GENERAL INFORMATION..... 3

2.1 Product Details 3

2.2 Accessories 3

2.3 Table for Filed Antenna 3

2.4 Table for Carrier Frequencies 4

2.5 Table for Test Modes 4

2.6 Table for Testing Locations 4

2.7 Table for Supporting Units..... 5

2.8 Table for Parameters of Test Software Setting 5

2.9 EUT Operation during Test 5

2.10 Test Configuration 6

3 TEST RESULT 8

3.1 AC Power Line Conducted Emissions Measurement..... 8

3.2 Maximum Conducted Output Power Measurement 12

3.3 Power Spectral Density Measurement 15

3.4 6dB Spectrum Bandwidth Measurement..... 26

3.5 Radiated Emissions Measurement..... 37

3.6 Band Edge and Fundamental Emissions Measurement 67

3.7 Antenna Requirements..... 76

4 LIST OF MEASURING EQUIPMENTS 77

5 TEST LOCATION..... 80

6 TAF CERTIFICATE OF ACCREDITATION 81

APPENDIX A. MAXIMUM PERMISSIBLE EXPOSURE..... A1 ~ A3

APPENDIX B. TEST PHOTOS B1 ~ B6

APPENDIX C. PHOTOGRAPHS OF EUT C1 ~ C15

CERTIFICATE OF COMPLIANCE

according to

47 CFR FCC Part 15 Subpart C § 15.247

Equipment : HW2R1 Hi-Gain Wireless-N Dual Radio Smart Repeater
Model No. : HW2R1
Brand Name : HAWKING
Applicant : Hawking Technologies, Inc.
35 Hammond, Suite 150, Irvine, CA 92618, USA

Sporton International as requested by the applicant to evaluate the EMC performance of the product sample received on Dec. 04, 2008 would like to declare that the tested sample has been evaluated and found to be in compliance with the tested rule parts. The data recorded as well as the test configuration specified is true and accurate for showing the sample's EMC nature.



Wayne Hsu

SPORTON International Inc.

6F, No.106, Sec. 1, Hsin Tai Wu Rd., Hsi Chih, Taipei Hsien, Taiwan, R.O.C.

1 SUMMARY OF THE TEST RESULT

Applied Standard: 47 CFR FCC Part 15 Subpart C				
Part	Rule Section	Description of Test	Result	Under Limit
3.1	15.207	AC Power Line Conducted Emissions	Complies	6.44 dB
3.2	15.247(b)(3)	Maximum Conducted Output Power	Complies	12.80 dB
3.3	15.247(e)	Power Spectral Density	Complies	15.41 dB
3.4	15.247(a)(2)	6dB Spectrum Bandwidth	Complies	-
3.5	15.247(d)	Radiated Emissions	Complies	3.74 dB
3.6	15.247(d)	Band Edge Emissions	Complies	6.17 dB
3.7	15.203	Antenna Requirements	Complies	-

Test Items	Uncertainty	Remark
AC Power Line Conducted Emissions	±2.3dB	Confidence levels of 95%
Maximum Peak Conducted Output Power	±0.8dB	Confidence levels of 95%
Power Spectral Density	±0.5dB	Confidence levels of 95%
6dB Spectrum Bandwidth	±8.5×10 ⁻⁸	Confidence levels of 95%
Radiated Emissions (9kHz~30MHz)	±0.8dB	Confidence levels of 95%
Radiated Emissions (30MHz~1000MHz)	±1.9dB	Confidence levels of 95%
Radiated / Band Edge Emissions (1GHz~18GHz)	±1.9dB	Confidence levels of 95%
Radiated Emissions (18GHz~40GHz)	±1.9dB	Confidence levels of 95%
Temperature	±0.7	Confidence levels of 95%
Humidity	±3.2%	Confidence levels of 95%
DC / AC Power Source	±1.4%	Confidence levels of 95%

2 GENERAL INFORMATION

2.1 Product Details

Only the radio detail of IEEE 802.11b/g is shown in the table below. For more detailed features description, please refer to the manufacturer’s specifications or user’s manual.

Items	Description
Power Type	12V from adapter
Modulation	DSSS for IEEE 802.11b ; OFDM for IEEE 802.11g
Data Modulation	DSSS (DBPSK / DQPSK / CCK) ; OFDM (BPSK / QPSK / 16QAM / 64QAM)
Data Rate (Mbps)	DSSS (1/ 2/ 5.5/11) ; OFDM (6/9/12/18/24/36/48/54)
Frequency Range	2400 ~ 2483.5MHz
Channel Number	11b/g: 11
Channel Band Width (99%)	For router : 11b: 14.71 MHz ; 11g: 16.35 MHz For dongle : 11b: 14.37 MHz ; 11g: 16.43 MHz
Conducted Output Power	For router : 11b: 17.20 dBm ; 11g: 15.22 dBm For dongle : 11b: 17.24 dBm ; 11g: 14.18 dBm

2.2 Accessories

Power	Brand	Model	Rating
Switching power supply	DVE	PSA12A-120	INPUT : 100-240V~ 0.5A 50-60Hz OUTPUT : 12V 1.0A

2.3 Table for Filed Antenna

For router module used :

Ant.	Antenna Type	Connector	Gain (dBi)	Remark
A	Dipole Antenna	Reversed-SMA	3.00	TX / RX
B	Dipole Antenna	Reversed-SMA	3.00	TX / RX

Note:

For 802.11b/g used with antenna 1 or antenna 2 for transceiving. The worst case is antenna 1 that was tested in this report.

For dongle module used :

Ant.	Antenna Type	Connector	Gain (dBi)	Remark
A	Dipole Antenna	Reversed-SMA	3.00	TX / RX

2.4 Table for Carrier Frequencies

Frequency Allocation for 802.11b/g

Frequency Band	Channel No.	Frequency	Channel No.	Frequency
2400~2483.5MHz	1	2412 MHz	7	2442 MHz
	2	2417 MHz	8	2447 MHz
	3	2422 MHz	9	2452 MHz
	4	2427 MHz	10	2457 MHz
	5	2432 MHz	11	2462 MHz
	6	2437 MHz	-	-

2.5 Table for Test Modes

Preliminary tests were performed in different data rate to find the worst radiated emission. The data rate shown in the table below is the worst-case rate with respect to the specific test item. Investigation has been done on the entire possible configuration for searching the worst cases. The following table is a list of the test modes shown in this test report.

Test Items	Mode	Data Rate	Channel
AC Power Line Conducted Emissions	Normal Mode	Auto	-
Maximum Conducted Output Power	Mode 1 / Mode 2	11 Mbps	1/6/11
Power Spectral Density	11b/CCK		
6dB Spectrum Bandwidth	Mode 1 / Mode 2	6 Mbps	1/6/11
Radiated Emissions Above 1GHz	11g/BPSK		
Band Edge Emissions			
Radiated Emissions Below 1GHz	Normal Mode	Auto	-

Note: The following modes were tested:

- Mode 1. For router module test mode.
- Mode 2. For dongle module test mode.

2.6 Table for Testing Locations

Test Site No.	Site Category	Location
CO04-HY	Conduction	Hwa Ya
TH01-HY	OVEN Room	Hwa Ya
03CH03-HY	SAC	Hwa Ya
03CH02-HY	SAC	Hwa Ya

Semi Anechoic Chamber (SAC).

2.7 Table for Supporting Units

Support Unit	Brand	Model	FCC ID	Remark
Notebook (Remote Workstation)	DELL	D505	N/A	Conducted
Notebook	DELL	D505	N/A	Radiated

2.8 Table for Parameters of Test Software Setting

During testing, Channel & Power Controlling Software provided by the customer was used to control the operating channel as well as the output power level. The RF output power selection is for the setting of RF output power expected by the customer and is going to be fixed on the firmware of the final end product.

Mode 1

Power Parameters of IEEE 802.11b/g

Test Software Version	RT3052		
Frequency	2412 MHz	2437 MHz	2462 MHz
IEEE 802.11b	0F	10	12
IEEE 802.11g	12	14	16

Mode 2

Power Parameters of IEEE 802.11b/g

Test Software Version	RT3070		
Frequency	2412 MHz	2437 MHz	2462 MHz
IEEE 802.11b	18	18	19
IEEE 802.11g	11	11	11

2.9 EUT Operation during Test

An executive program, EMCTEST.EXE under WIN XP, which generates a complete line of continuously repeating “H” pattern was used as the test software.

The NB sends “H” messages to the panel, and the panel displays “H” patterns on the screen.

Executed "ping.exe" to link with the remote workstation to receive and transmit data by LAN and WLAN.

Executed “RT3052” to keep transmitting signals at fixed frequency.

Executed “RT3070” to keep transmitting signals at fixed frequency.

2.10 Test Configuration

2.10.1 Radiation Emissions Test Configuration

For radiated emissions 9kHz~1GHz

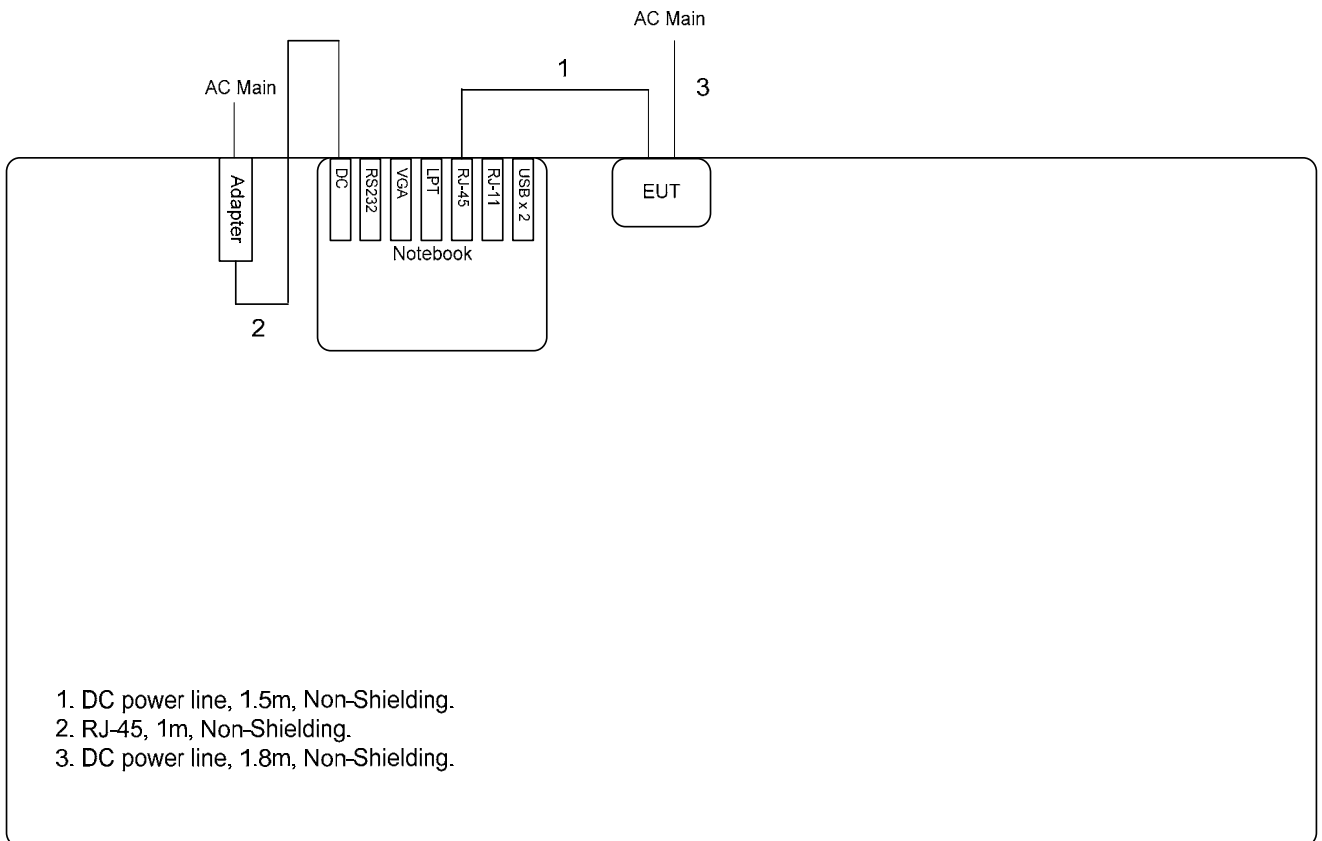

For radiated emissions above 1GHz

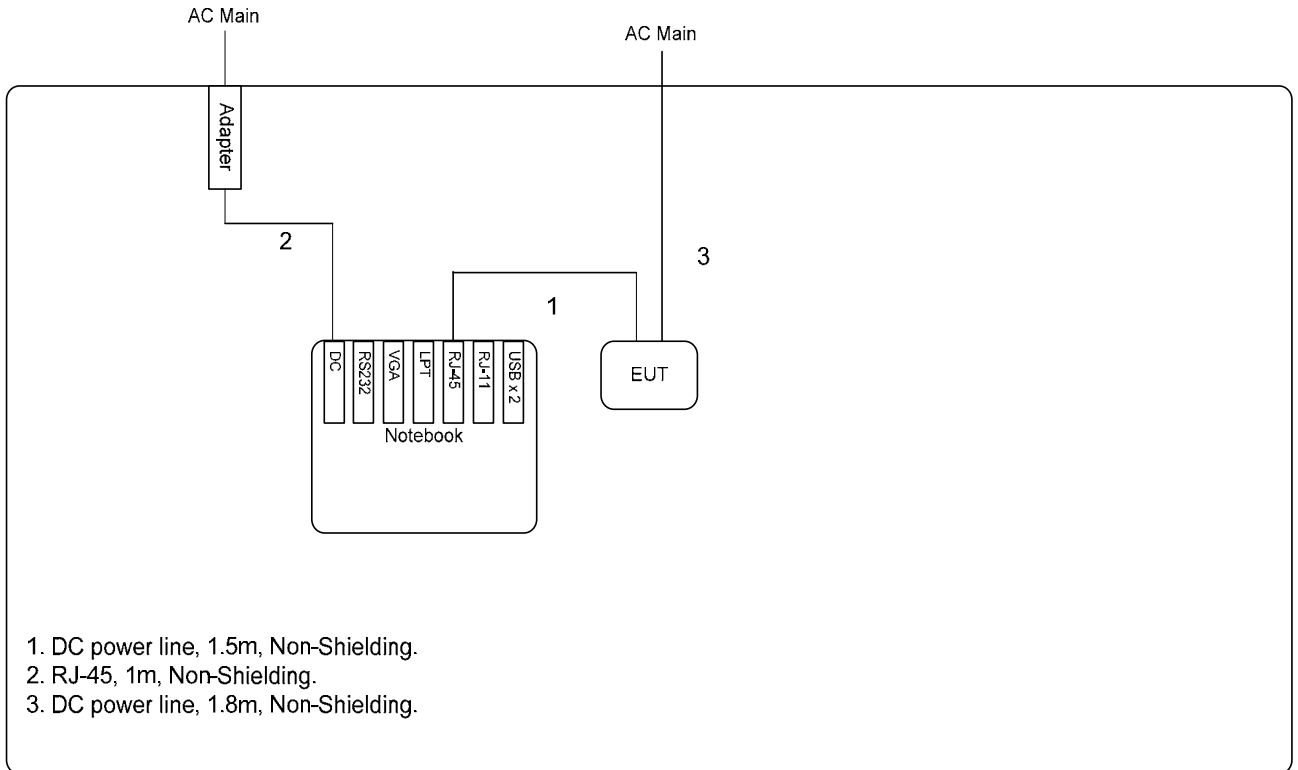

3 TEST RESULT

3.1 AC Power Line Conducted Emissions Measurement

3.1.1 Limit

For this product which is designed to be connected to the AC power line, the radio frequency voltage that is conducted back onto the AC power line on any frequency or frequencies within the band 150 kHz to 30 MHz shall not exceed below limits table.

Class B

Frequency (MHz)	QP Limit (dBuV)	AV Limit (dBuV)
0.15~0.5	66~56	56~46
0.5~5	56	46
5~30	60	50

3.1.2 Measuring Instruments and Setting

Please refer to section 4 of equipments list in this report. The following table is the setting of the receiver.

Receiver Parameters	Setting
Attenuation	10 dB
Start Frequency	0.15 MHz
Stop Frequency	30 MHz
IF Bandwidth	9 KHz

3.1.3 Test Procedures

1. The EUT warm up about 15 minutes then start test.
2. Configure the EUT according to ANSI C63.4. The EUT or host of EUT has to be placed 0.4 meter far from the conducting wall of the shielding room and at least 80 centimeters from any other grounded conducting surface.
3. Connect EUT or host of EUT to the power mains through a line impedance stabilization network (LISN).
4. All the support units are connected to the other LISNs. The LISN should provide 50uH/50ohms coupling impedance.
5. The frequency range from 150 KHz to 30 MHz was searched.
6. Set the test-receiver system to Peak Detect Function and Specified Bandwidth with Maximum Hold Mode.
7. The measurement has to be done between each power line and ground at the power terminal.

3.1.4 Test Setup Layout

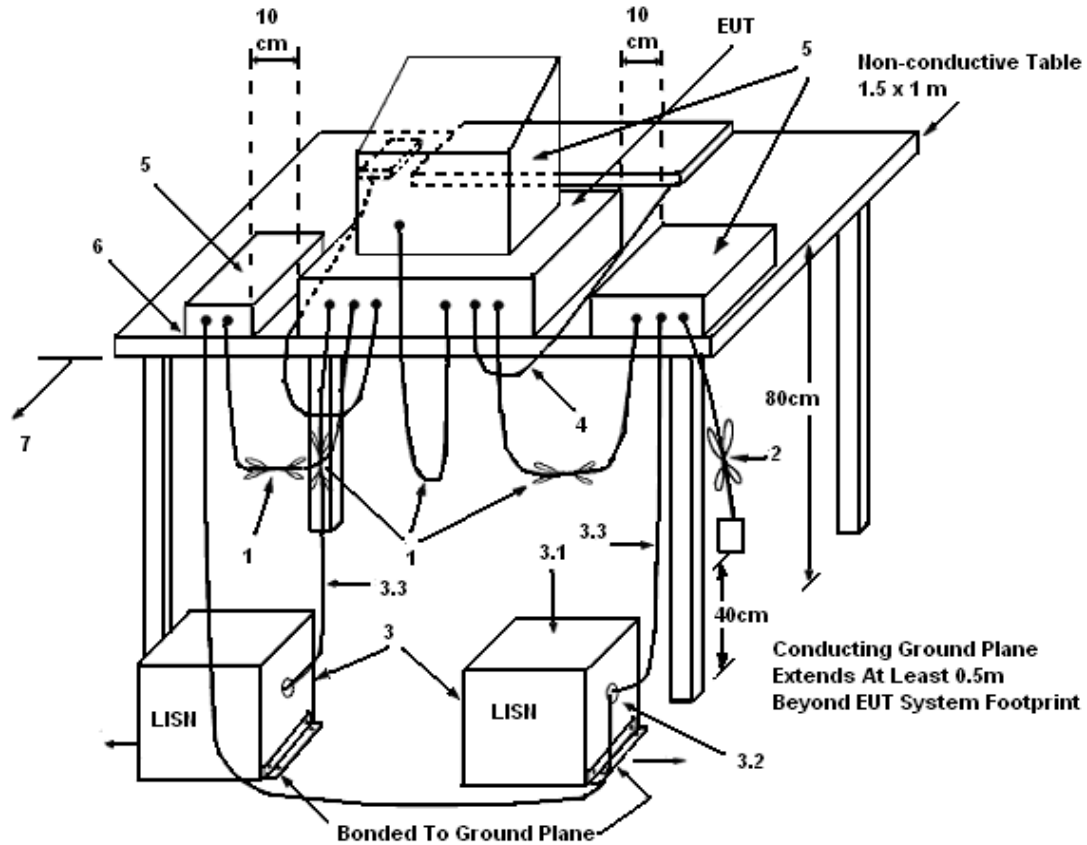

LEGEND:

- (1) Interconnecting cables that hang closer than 40 cm to the ground plane shall be folded back and forth in the center forming a bundle 30 to 40 cm long.
- (2) I/O cables that are not connected to a peripheral shall be bundled in the center. The end of the cable may be terminated, if required, using the correct terminating impedance. The overall length shall not exceed 1 m.
- (3) EUT connected to one LISN. Unused LISN measuring port connectors shall be terminated in 50 Ω. LISN can be placed on top of, or immediately beneath, reference ground plane.
- (3.1) All other equipment powered from additional LISN(s).
- (3.2) Multiple outlet strip can be used for multiple power cords of non-EUT equipment.
- (3.3) LISN at least 80 cm from nearest part of EUT chassis.
- (4) Cables of hand-operated devices, such as keyboards, mice, etc., shall be placed as for normal use.
- (5) Non-EUT components of EUT system being tested.
- (6) Rear of EUT, including peripherals, shall all be aligned and flush with rear of tabletop.
- (7) Rear of tabletop shall be 40 cm removed from a vertical conducting plane that is bonded to the ground plane.

3.1.5 Test Deviation

There is no deviation with the original standard.

3.1.6 EUT Operation during Test

The EUT was placed on the test table and programmed in normal function.

3.1.7 Results of AC Power Line Conducted Emissions Measurement

Final Test Date	Dec. 17, 2009	Test Site No.	CO04-HY
Temperature	20	Humidity	50%
Test Engineer	Steven	Configuration	Normal Mode

Line

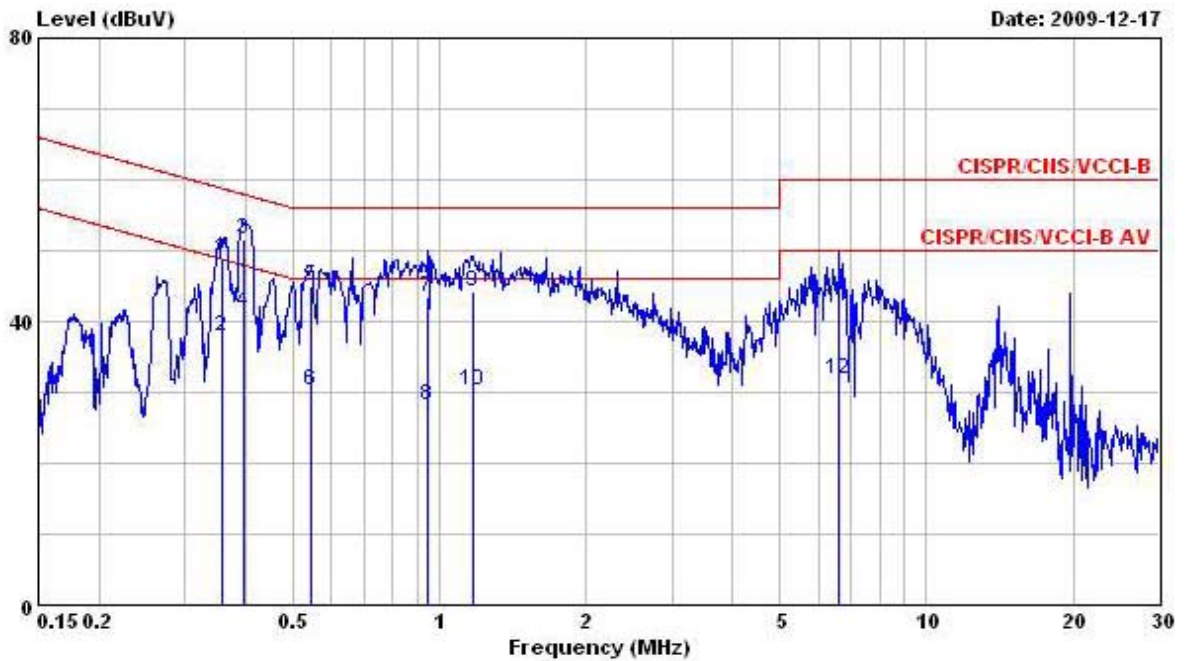

	Freq	Level	Over Limit	Limit Line	Read Level	LISN Factor	Cable Loss	Remark
	MHz	dBuV	dB	dBuV	dBuV	dB	dB	
1	0.3588720	48.92	-9.83	58.75	48.76	0.09	0.07	QP
2	0.3588720	37.97	-10.78	48.75	37.81	0.09	0.07	Average
3	@0.3957700	51.50	-6.44	57.94	51.33	0.09	0.08	QP
4	@0.3957700	41.21	-6.73	47.94	41.04	0.09	0.08	Average
5	0.5464400	44.93	-11.07	56.00	44.75	0.10	0.08	QP
6	0.5464400	30.37	-15.63	46.00	30.19	0.10	0.08	Average
7	0.9480900	43.42	-12.58	56.00	43.22	0.11	0.09	QP
8	0.9480900	28.16	-17.84	46.00	27.96	0.11	0.09	Average
9	1.170	44.29	-11.71	56.00	44.07	0.11	0.11	QP
10	1.170	30.33	-15.67	46.00	30.11	0.11	0.11	Average
11	6.630	42.11	-17.89	60.00	41.60	0.22	0.29	QP
12	6.630	31.90	-18.10	50.00	31.39	0.22	0.29	Average

Neutral

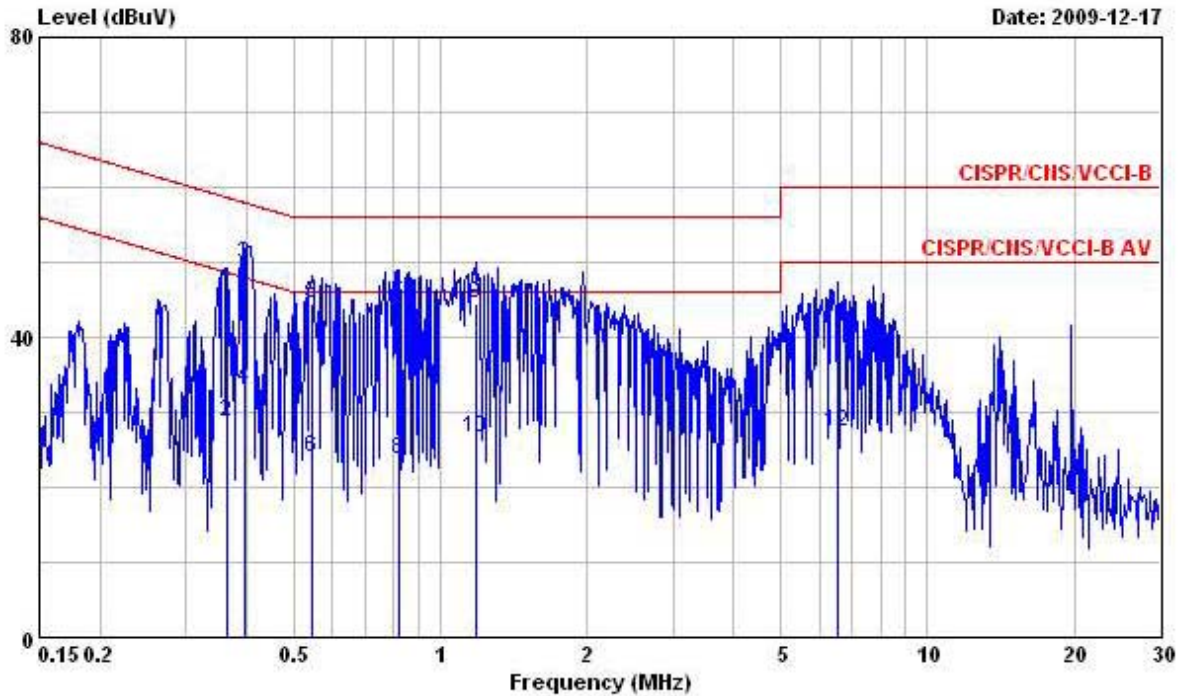

	Freq	Level	Over Limit	Limit Line	Read Level	LISN Factor	Cable Loss	Remark
	MHz	dBuV	dB	dBuV	dBuV	dB	dB	
1	0.3627520	46.36	-12.31	58.67	46.21	0.08	0.07	QP
2	0.3627520	28.78	-19.89	48.67	28.63	0.08	0.07	Average
3	0.3947200	49.76	-8.20	57.96	49.60	0.08	0.08	QP
4	0.3947200	33.06	-14.90	47.96	32.90	0.08	0.08	Average
5	0.5464400	44.42	-11.58	56.00	44.25	0.09	0.08	QP
6	0.5464400	23.90	-22.10	46.00	23.73	0.09	0.08	Average
7	0.8217160	44.34	-11.66	56.00	44.15	0.10	0.09	QP
8	0.8217160	23.56	-22.44	46.00	23.37	0.10	0.09	Average
9	1.180	44.36	-11.64	56.00	44.15	0.10	0.11	QP
10	1.180	26.69	-19.31	46.00	26.48	0.10	0.11	Average
11	6.560	41.43	-18.57	60.00	40.94	0.21	0.28	QP
12	6.560	27.27	-22.73	50.00	26.78	0.21	0.28	Average

Note:

Level = Read Level + LISN Factor + Cable Loss.

3.2 Maximum Conducted Output Power Measurement

3.2.1 Limit

For systems using digital modulation in the 2400-2483.5MHz, the limit for peak output power is 30dBm. The limited has to be reduced by the amount in dB that the gain of the antenna exceed 6dBi. In case of point-to-point operation, the limit has to be reduced by 1dB for every 3dB that the directional gain of the antenna exceeds 6dBi.

3.2.2 Measuring Instruments and Setting

Please refer to section 4 of equipments list in this report. The following table is the setting of the spectrum analyzer.

Power Meter Parameter	Setting
Attenuation	Auto
Span Frequency	Encompass the entire emissions bandwidth (EBW) of the signal
RB	1000 kHz
VB	3000 kHz
Detector	rms
Trace	Max Hold
Sweep Time	Auto

3.2.3 Test Procedures

1. The transmitter output (antenna port) was connected to the spectrum analyzer.
2. Test was performed in accordance with Measurement of Digital Transmission Systems Operating under Section 15.247.

3.2.4 Test Setup Layout

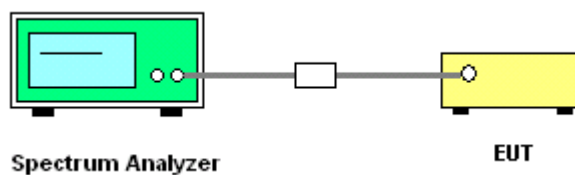

3.2.5 Test Deviation

There is no deviation with the original standard.

3.2.6 EUT Operation during Test

The EUT was programmed to be in continuously transmitting mode.

3.2.7 Test Result of Maximum Conducted Output Power

Final Test Date	Dec. 04, 2008	Test Site No.	TH01-HY
Temperature	28	Humidity	58%
Test Engineer	Tom	Configuration	Mode 1

Configuration IEEE 802.11b

Channel	Frequency	Conducted Power (dBm)	Max. Limit (dBm)	Result
1	2412 MHz	17.20	30.00	Complies
6	2437 MHz	17.02	30.00	Complies
11	2462 MHz	17.18	30.00	Complies

Configuration IEEE 802.11g

Channel	Frequency	Conducted Power (dBm)	Max. Limit (dBm)	Result
1	2412 MHz	15.20	30.00	Complies
6	2437 MHz	15.22	30.00	Complies
11	2462 MHz	15.13	30.00	Complies

Final Test Date	Apr. 14, 2009	Test Site No.	TH01-HY
Temperature	25	Humidity	55%
Test Engineer	Duncan	Configuration	Mode 2

Configuration IEEE 802.11b

Channel	Frequency	Conducted Power (dBm)	Max. Limit (dBm)	Result
1	2412 MHz	17.24	30.00	Complies
6	2437 MHz	16.86	30.00	Complies
11	2462 MHz	17.13	30.00	Complies

Configuration IEEE 802.11g

Channel	Frequency	Conducted Power (dBm)	Max. Limit (dBm)	Result
1	2412 MHz	14.18	30.00	Complies
6	2437 MHz	14.11	30.00	Complies
11	2462 MHz	14.15	30.00	Complies

3.3 Power Spectral Density Measurement

3.3.1 Limit

For digitally modulated systems, the power spectral density conducted from the intentional radiator to the antenna shall not be greater than 8 dBm in any 3 kHz band during any time interval of continuous transmission.

3.3.2 Measuring Instruments and Setting

Please refer to section 4 of equipments list in this report. The following table is the setting of the spectrum analyzer.

Spectrum Parameter	Setting
Attenuation	Auto
Span Frequency	1.5MHz
RB	3 kHz
VB	30 kHz
Detector	Peak
Trace	Max Hold
Sweep Time	500s

3.3.3 Test Procedures

1. The transmitter output (antenna port) was connected to the spectrum analyzer.
2. Set RBW of spectrum analyzer to 3 kHz and VBW to 30 kHz. Set Detector to Peak, Trace to Max Hold.
3. Mark the frequency with maximum peak power as the center of the display of the spectrum.
4. Set the span to 1.5MHz and the sweep time to 500s and record the maximum peak value.

3.3.4 Test Setup Layout

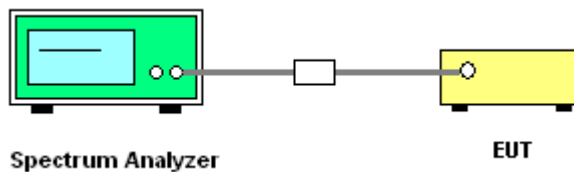

3.3.5 Test Deviation

There is no deviation with the original standard.

3.3.6 EUT Operation during Test

The EUT was programmed to be in continuously transmitting mode.

3.3.7 Test Result of Power Spectral Density

Final Test Date	Dec. 04, 2008	Test Site No.	TH01-HY
Temperature	28	Humidity	58%
Test Engineer	Tom	Configuration	Mode 1

Configuration IEEE 802.11b

Channel	Frequency	Power Density (dBm)	Max. Limit (dBm)	Result
1	2412 MHz	-4.13	8.00	Complies
6	2437 MHz	-3.82	8.00	Complies
11	2462 MHz	-4.71	8.00	Complies

Configuration IEEE 802.11g

Channel	Frequency	Power Density (dBm)	Max. Limit (dBm)	Result
1	2412 MHz	-4.99	8.00	Complies
6	2437 MHz	-4.50	8.00	Complies
11	2462 MHz	-5.04	8.00	Complies

Power Density Plot on Configuration IEEE 802.11b / 2412 MHz

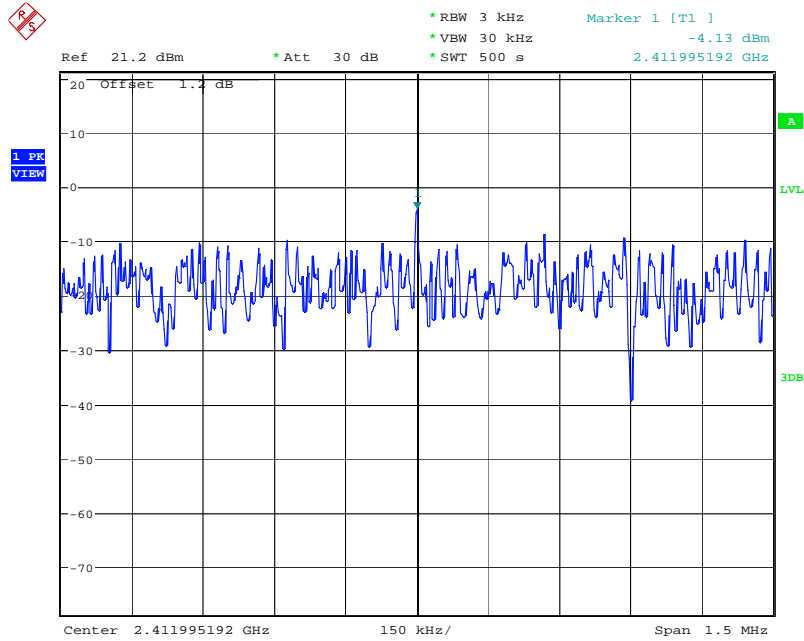

Date: 4.DEC.2008 05:56:27

Power Density Plot on Configuration IEEE 802.11b / 2437 MHz

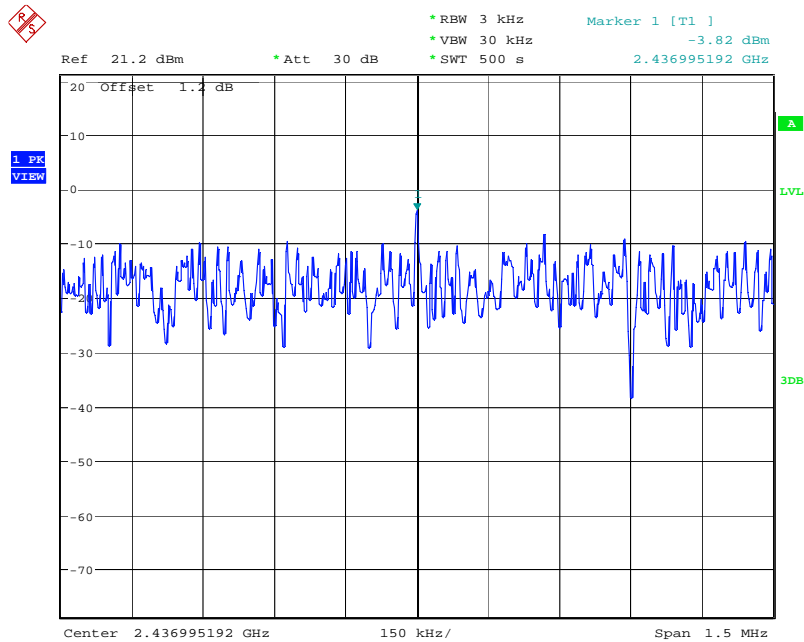

Date: 4.DEC.2008 06:14:11

Power Density Plot on Configuration IEEE 802.11b / 2462 MHz

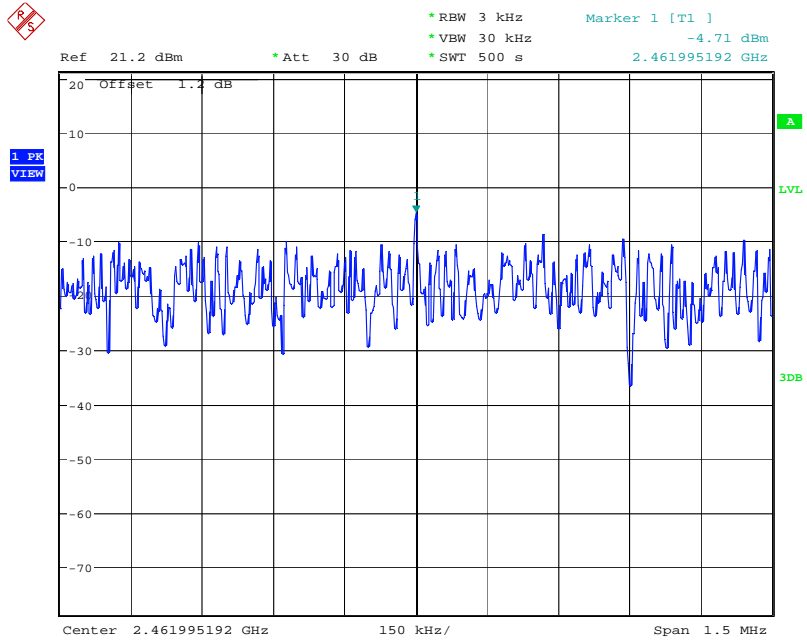

Date: 4.DEC.2008 06:12:45

Power Density Plot on Configuration IEEE 802.11g / 2412 MHz

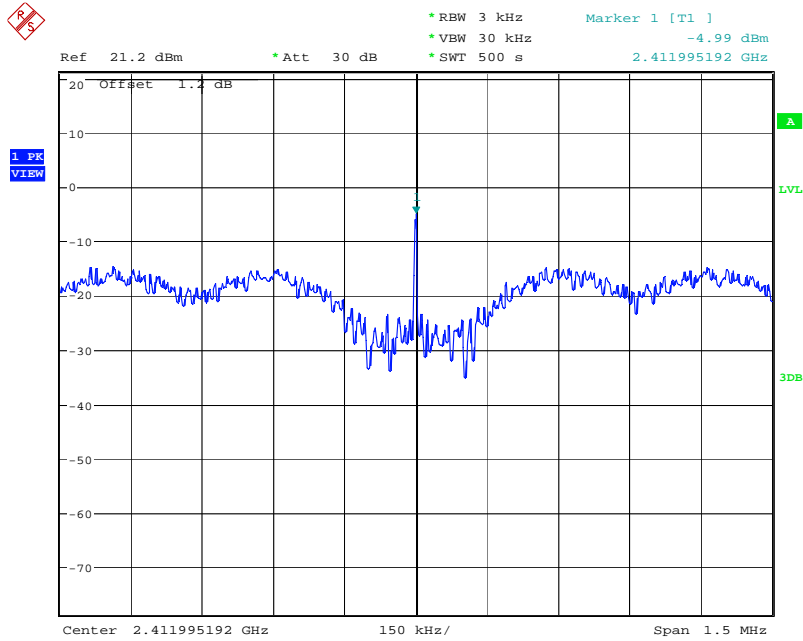

Date: 4.DEC.2008 06:31:47

Power Density Plot on Configuration IEEE 802.11g / 2437 MHz

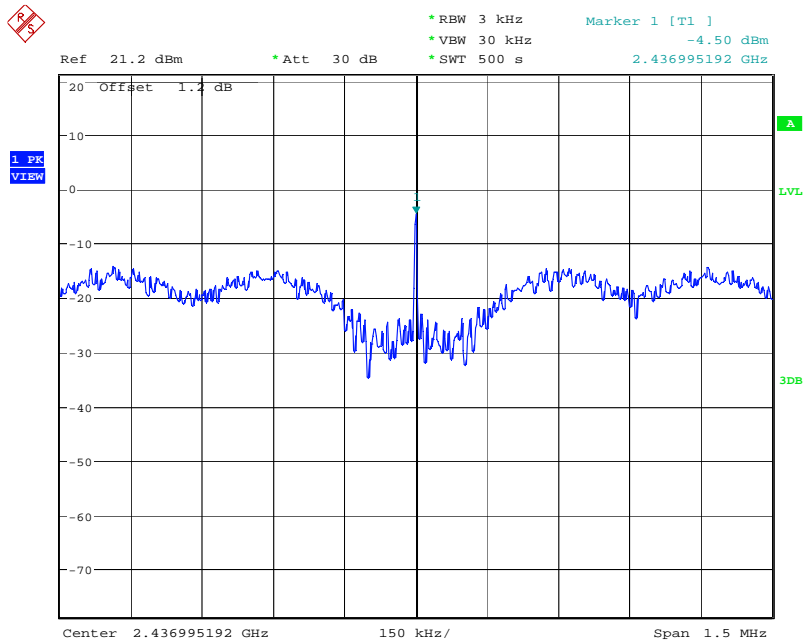

Date: 4.DEC.2008 06:37:48

Power Density Plot on Configuration IEEE 802.11g / 2462 MHz

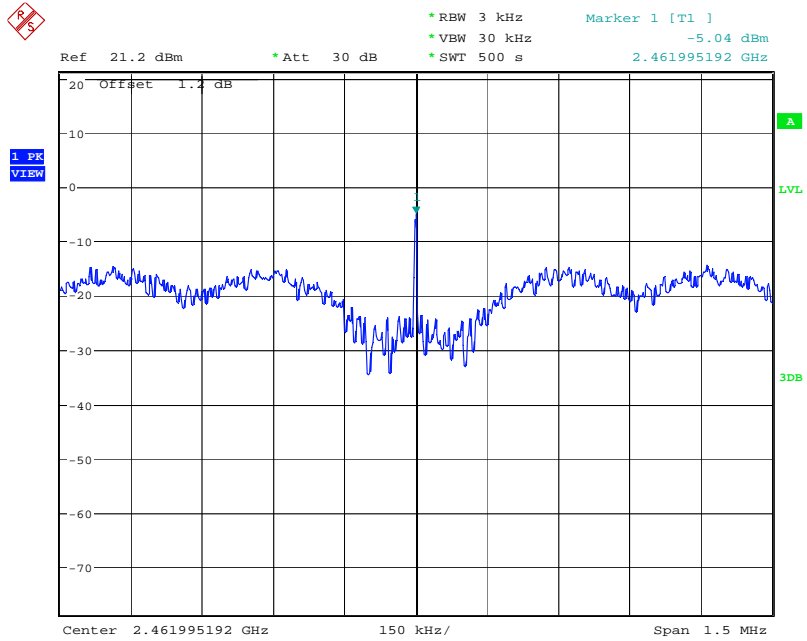

Date: 4.DEC.2008 06:43:44

Final Test Date	Apr. 14, 2009	Test Site No.	TH01-HY
Temperature	25	Humidity	55%
Test Engineer	Duncan	Configuration	Mode 2

Configuration IEEE 802.11b

Channel	Frequency	Power Density (dBm)	Max. Limit (dBm)	Result
1	2412 MHz	-7.41	8.00	Complies
6	2437 MHz	-7.63	8.00	Complies
11	2462 MHz	-7.50	8.00	Complies

Configuration IEEE 802.11g

Channel	Frequency	Power Density (dBm)	Max. Limit (dBm)	Result
1	2412 MHz	-14.64	8.00	Complies
6	2437 MHz	-15.19	8.00	Complies
11	2462 MHz	-15.26	8.00	Complies

Power Density Plot on Configuration IEEE 802.11b / 2412 MHz

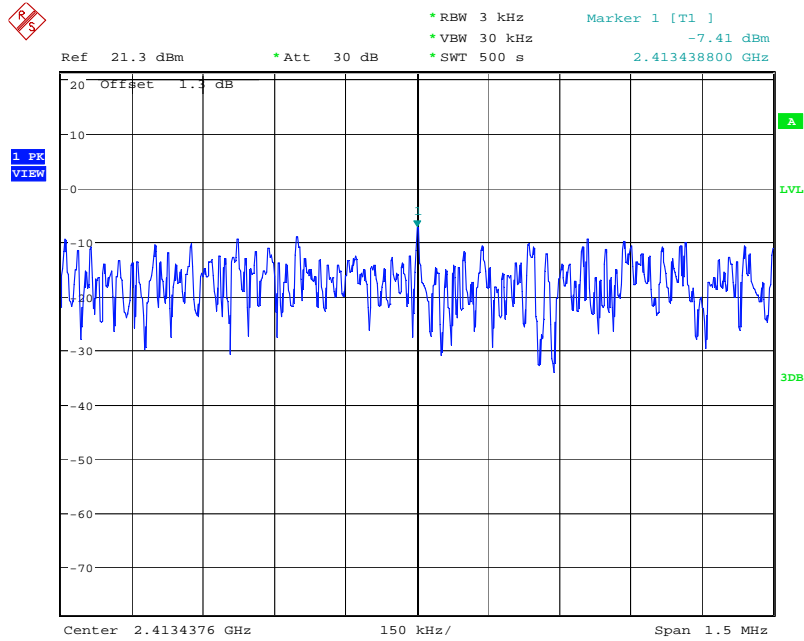

Date: 13.APR.2009 17:30:55

Power Density Plot on Configuration IEEE 802.11b / 2437 MHz

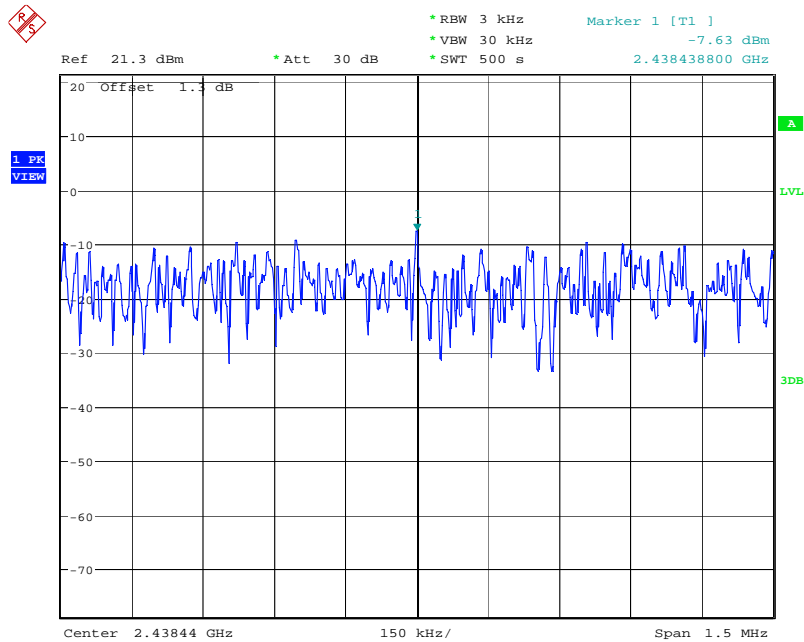

Date: 13.APR.2009 17:32:33

Power Density Plot on Configuration IEEE 802.11b / 2462 MHz

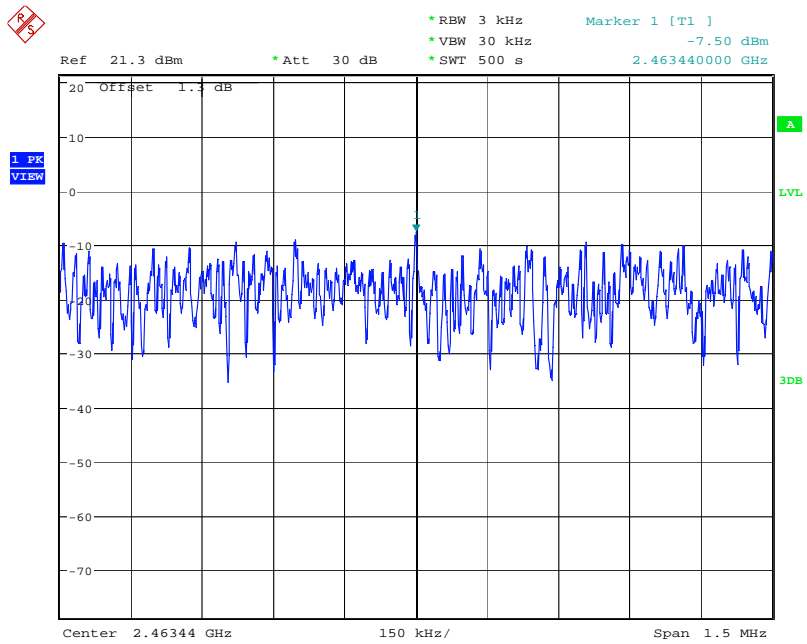

Date: 13.APR.2009 17:34:49

Power Density Plot on Configuration IEEE 802.11g / 2412 MHz

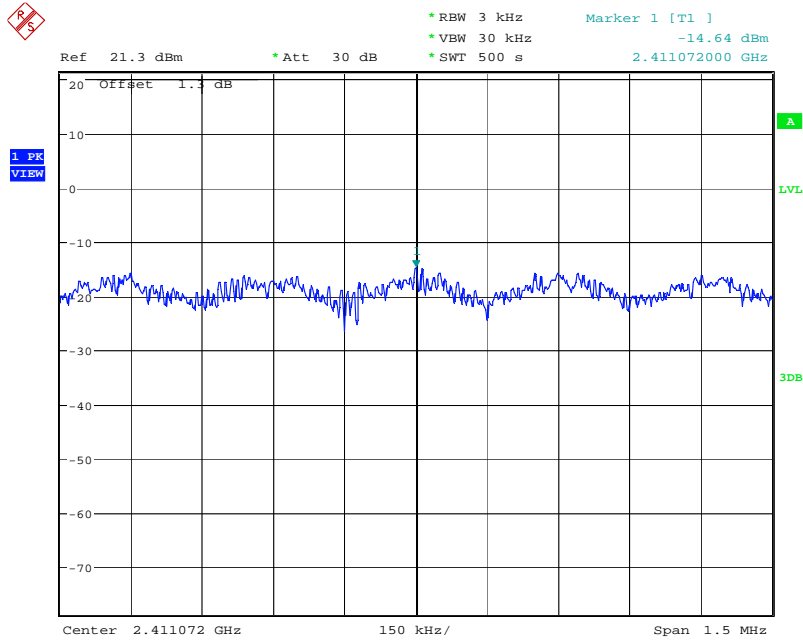

Date: 13.APR.2009 17:38:54

Power Density Plot on Configuration IEEE 802.11g / 2437 MHz

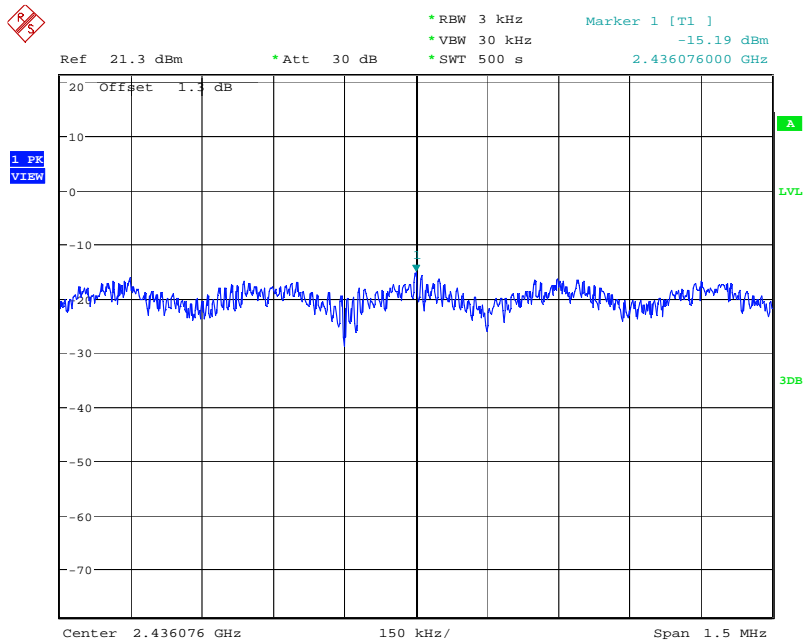

Date: 13.APR.2009 17:40:57

Power Density Plot on Configuration IEEE 802.11g / 2462 MHz

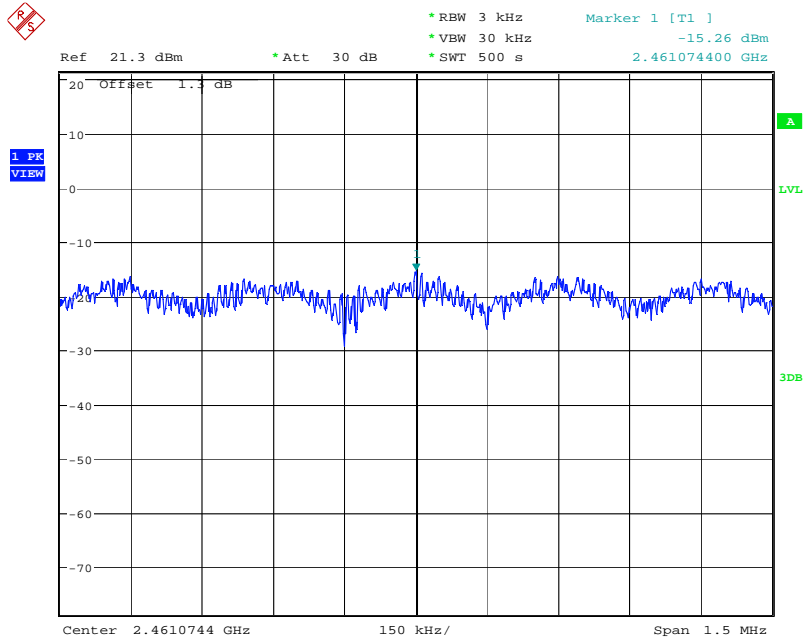

Date: 13.APR.2009 17:42:56

3.4 6dB Spectrum Bandwidth Measurement

3.4.1 Limit

For digital modulation systems, the minimum 6dB bandwidth shall be at least 500 kHz.

3.4.2 Measuring Instruments and Setting

Please refer to section 4 of equipments list in this report. The following table is the setting of the spectrum analyzer.

Spectrum Parameters	Setting
Attenuation	Auto
Span Frequency	> 6dB Bandwidth
RB	100 kHz
VB	100 kHz
Detector	Peak
Trace	Max Hold
Sweep Time	Auto

3.4.3 Test Procedures

1. The transmitter output (antenna port) was connected to the spectrum analyzer in peak hold mode.
2. The resolution bandwidth of 100 kHz and the video bandwidth of 100 kHz were used.
3. Measured the spectrum width with power higher than 6dB below carrier.

3.4.4 Test Setup Layout

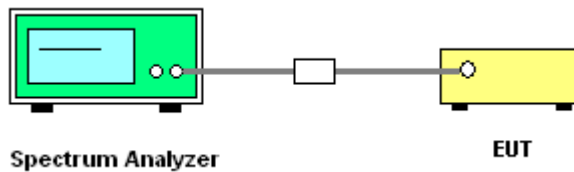

3.4.5 Test Deviation

There is no deviation with the original standard.

3.4.6 EUT Operation during Test

The EUT was programmed to be in continuously transmitting mode.

3.4.7 Test Result of 6dB Spectrum Bandwidth

Final Test Date	Dec. 04, 2008	Test Site No.	TH01-HY
Temperature	28	Humidity	58%
Test Engineer	Tom	Configuration	Mode 1

Configuration IEEE 802.11b

Channel	Frequency	6dB Bandwidth (MHz)	99% Occupied Bandwidth (MHz)	Min. Limit (kHz)	Test Result
1	2412 MHz	11.54	14.71	500	Complies
6	2437 MHz	11.73	14.68	500	Complies
11	2462 MHz	11.89	14.71	500	Complies

Configuration IEEE 802.11g

Channel	Frequency	6dB Bandwidth (MHz)	99% Occupied Bandwidth (MHz)	Min. Limit (kHz)	Test Result
1	2412 MHz	16.41	16.35	500	Complies
6	2437 MHz	16.38	16.31	500	Complies
11	2462 MHz	16.38	16.35	500	Complies

6 dB Bandwidth Plot on Configuration IEEE 802.11b / 2412 MHz

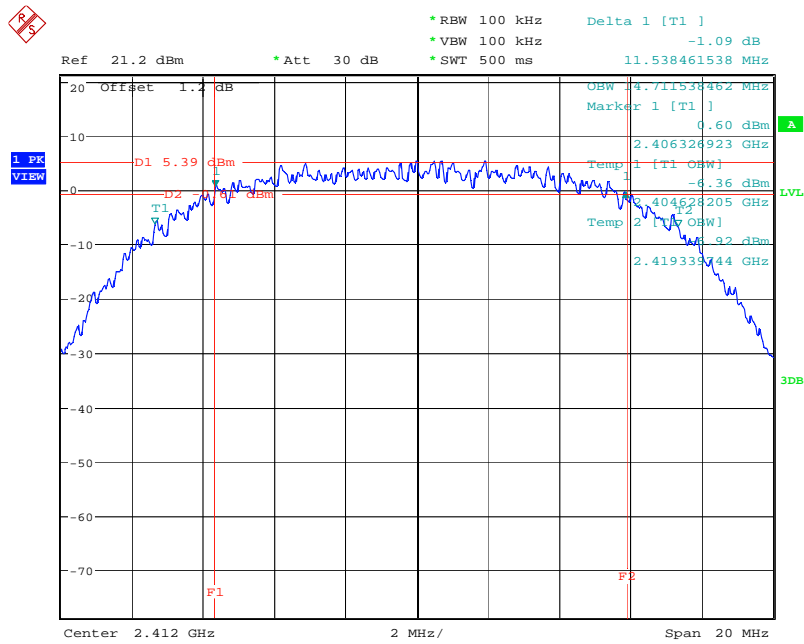

Date: 4.DEC.2008 05:53:33

6 dB Bandwidth Plot on Configuration IEEE 802.11b / 2437 MHz

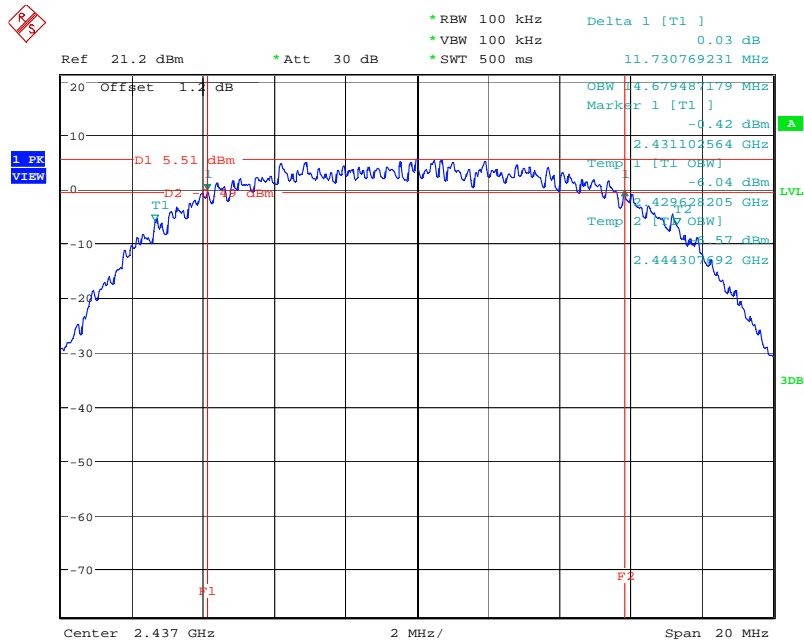

Date: 4.DEC.2008 06:00:34

6 dB Bandwidth Plot on Configuration IEEE 802.11b / 2462 MHz

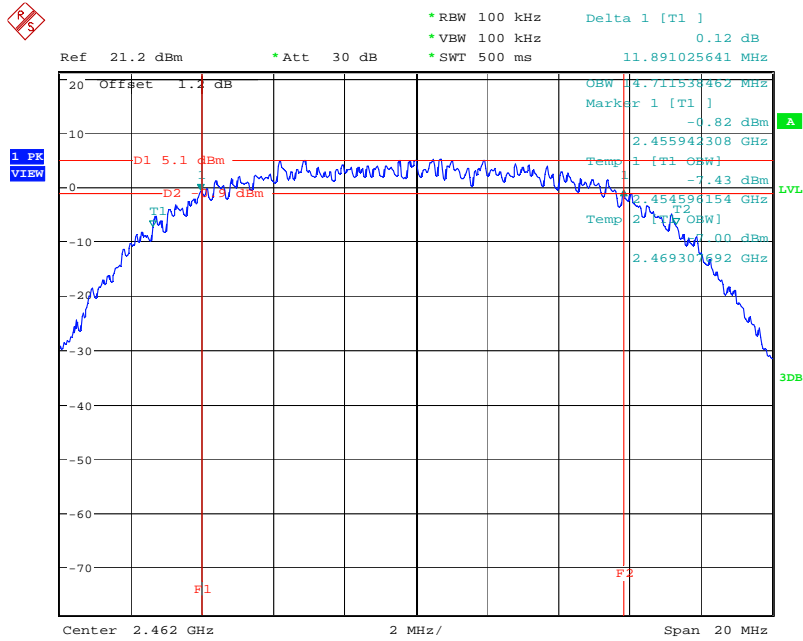

Date: 4.DEC.2008 06:06:45

6 dB Bandwidth Plot on Configuration IEEE 802.11g / 2412 MHz

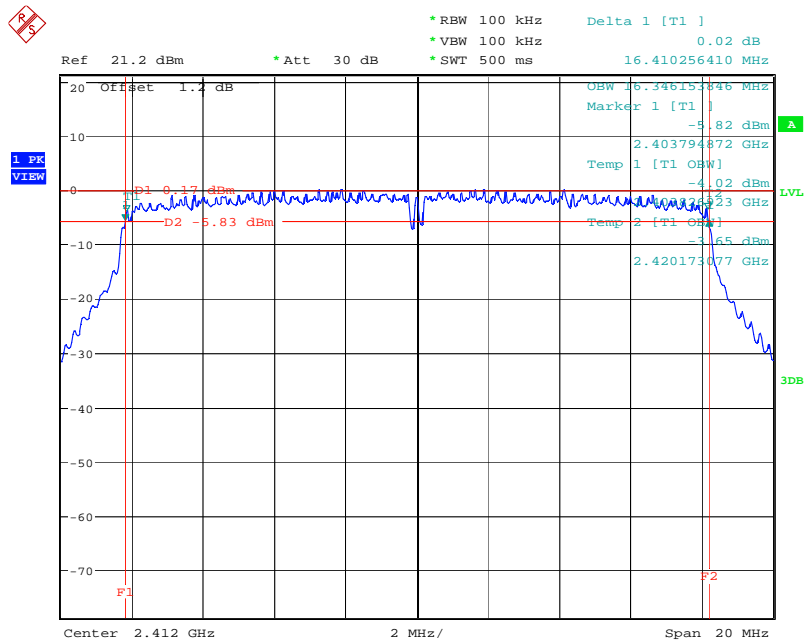

Date: 4.DEC.2008 06:29:04

6 dB Bandwidth Plot on Configuration IEEE 802.11g / 2437 MHz

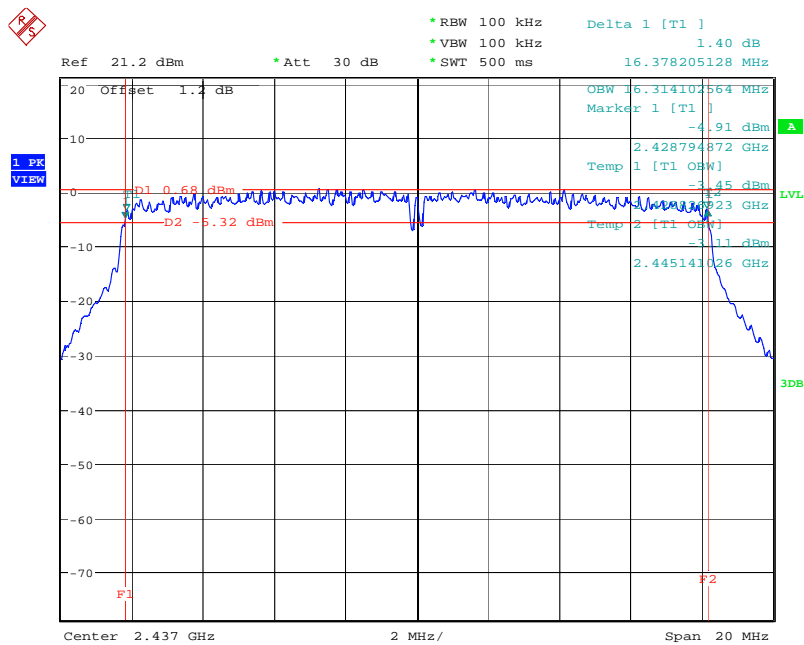

Date: 4.DEC.2008 06:36:28

6 dB Bandwidth Plot on Configuration IEEE 802.11g / 2462 MHz

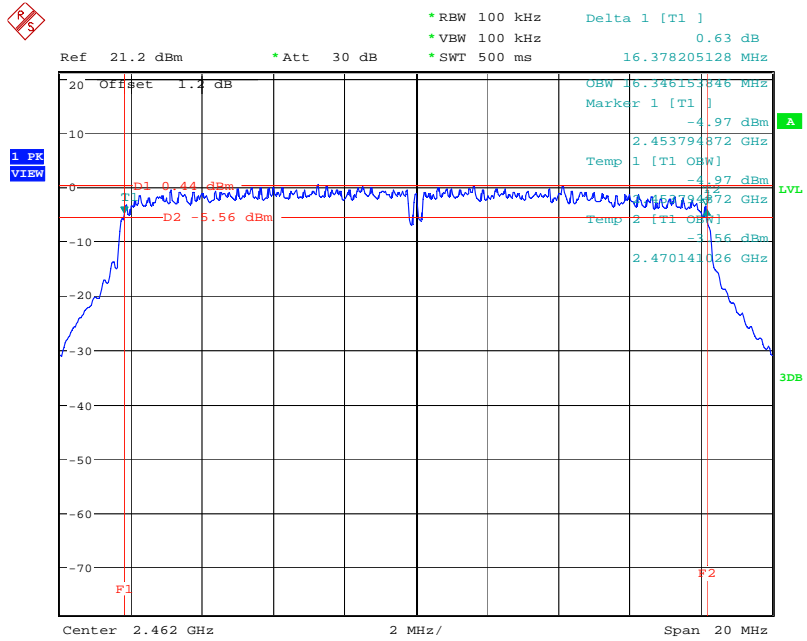

Date: 4.DEC.2008 06:41:03

Final Test Date	Apr. 13, 2009	Test Site No.	TH01-HY
Temperature	25	Humidity	55%
Test Engineer	Duncan	Configuration	Mode 2

Configuration IEEE 802.11b

Channel	Frequency	6dB Bandwidth (MHz)	99% Occupied Bandwidth (MHz)	Min. Limit (kHz)	Test Result
1	2412 MHz	11.51	14.35	500	Complies
6	2437 MHz	11.28	14.35	500	Complies
11	2462 MHz	11.28	14.37	500	Complies

Configuration IEEE 802.11g

Channel	Frequency	6dB Bandwidth (MHz)	99% Occupied Bandwidth (MHz)	Min. Limit (kHz)	Test Result
1	2412 MHz	16.54	16.43	500	Complies
6	2437 MHz	16.54	16.43	500	Complies
11	2462 MHz	16.54	16.43	500	Complies

6 dB Bandwidth Plot on Configuration IEEE 802.11b / 2412 MHz

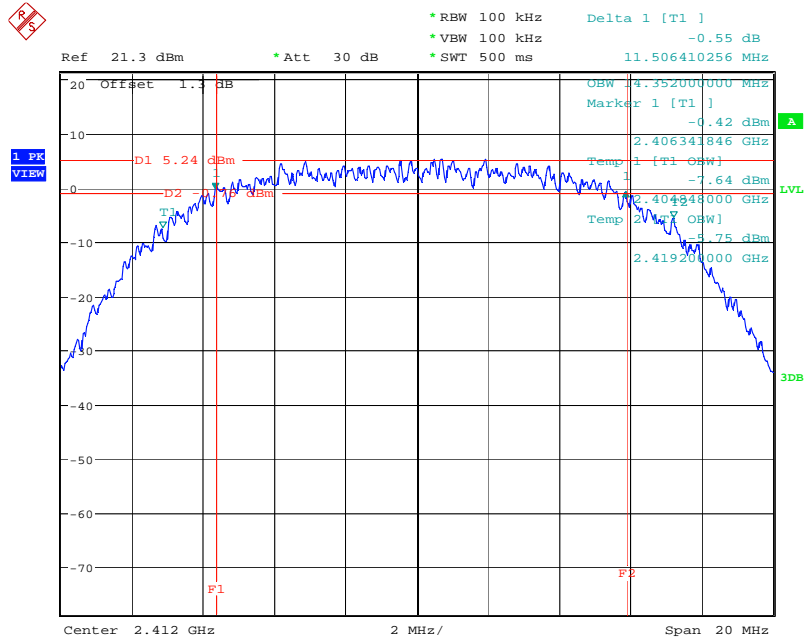

Date: 13.APR.2009 18:08:11

6 dB Bandwidth Plot on Configuration IEEE 802.11b / 2437 MHz

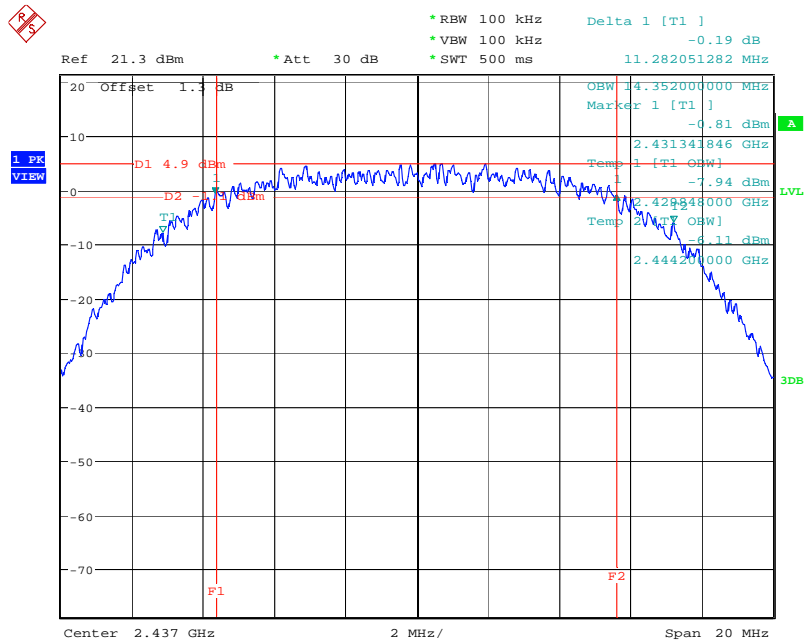

Date: 13.APR.2009 18:11:09

6 dB Bandwidth Plot on Configuration IEEE 802.11b / 2462 MHz

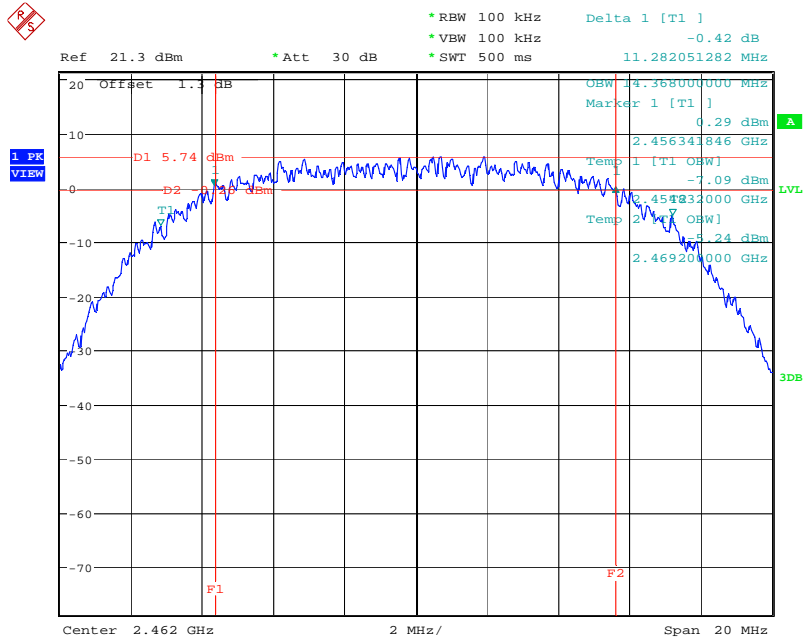

Date: 13.APR.2009 18:30:03

6 dB Bandwidth Plot on Configuration IEEE 802.11g / 2412 MHz

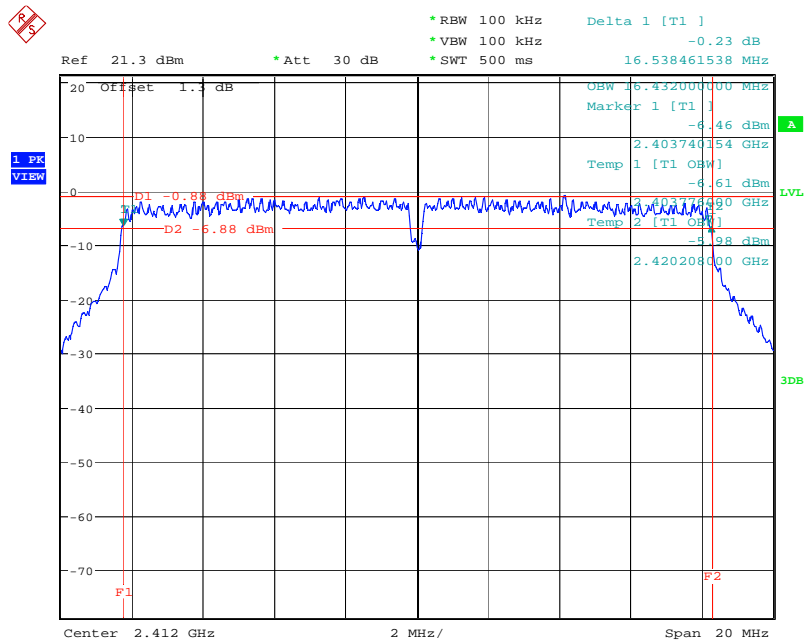

Date: 13.APR.2009 18:38:58

6 dB Bandwidth Plot on Configuration IEEE 802.11g / 2437 MHz

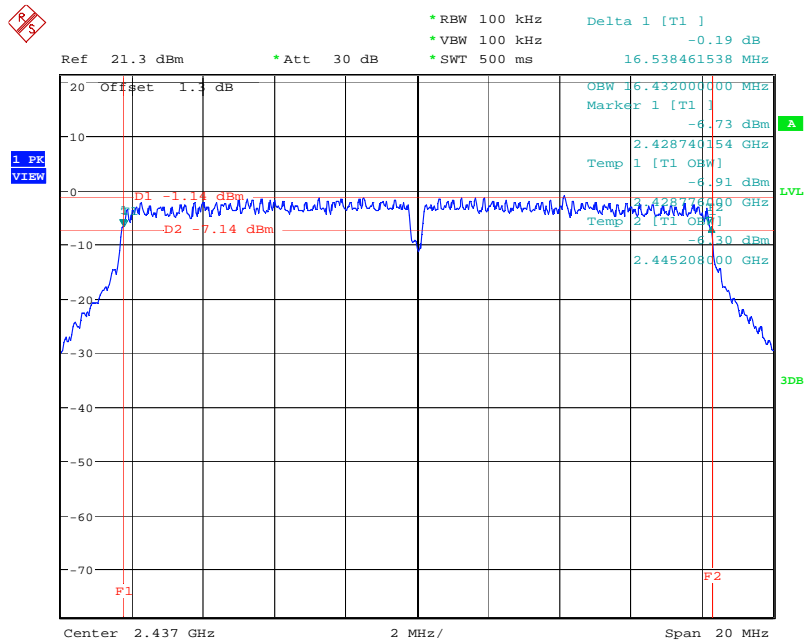

Date: 13.APR.2009 18:37:19

6 dB Bandwidth Plot on Configuration IEEE 802.11g / 2462 MHz

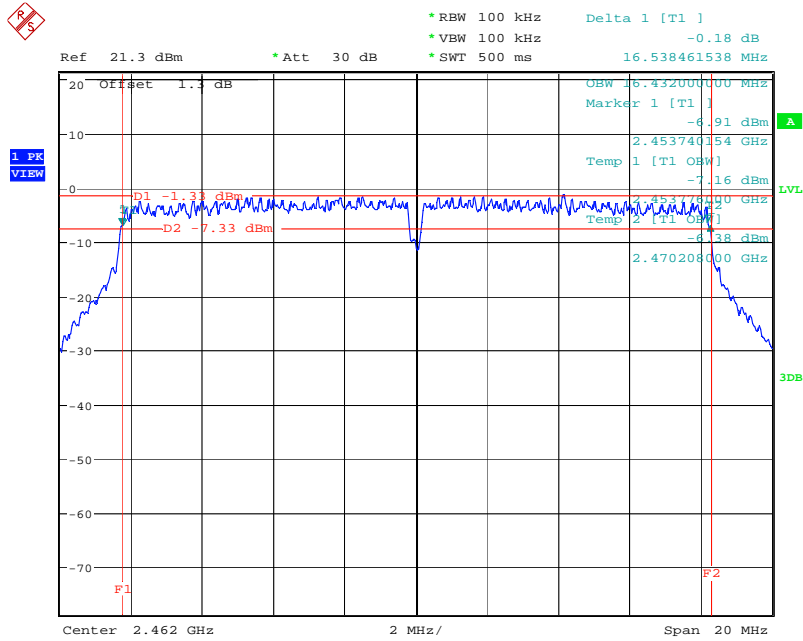

Date: 13.APR.2009 18:35:31

3.5 Radiated Emissions Measurement

3.5.1 Limit

20dBc in any 100 kHz bandwidth outside the operating frequency band. In case the emission fall within the restricted band specified on 15.205(a), then the 15.209(a) limit in the table below has to be followed.

Frequencies (MHz)	Field Strength (microvolt/meter)	Measurement Distance (meters)
0.009~0.490	2400/F(KHz)	300
0.490~1.705	24000/F(KHz)	30
1.705~30.0	30	30
30~88	100	3
88~216	150	3
216~960	200	3
Above 960	500	3

3.5.2 Measuring Instruments and Setting

Please refer to section 4 of equipments list in this report. The following table is the setting of spectrum analyzer and receiver.

Spectrum Parameter	Setting
Attenuation	Auto
Start Frequency	1000 MHz
Stop Frequency	10th carrier harmonic
RB / VB (Emission in restricted band)	1MHz / 1MHz for Peak, 1 MHz / 10Hz for Average
RB / VB (Emission in non-restricted band)	1MHz / 1MHz for peak

Receiver Parameter	Setting
Attenuation	Auto
Start ~ Stop Frequency	9kHz~150kHz / RB 200Hz for QP
Start ~ Stop Frequency	150kHz~30MHz / RB 9kHz for QP
Start ~ Stop Frequency	30MHz~1000MHz / RB 120kHz for QP

3.5.3 Test Procedures

1. Configure the EUT according to ANSI C63.4. The EUT was placed on the top of the turntable 0.8 meter above ground. The phase center of the receiving antenna mounted on the top of a height-variable antenna tower was placed 3 meters far away from the turntable.
2. Power on the EUT and all the supporting units. The turntable was rotated by 360 degrees to determine the position of the highest radiation.
3. The height of the broadband receiving antenna was varied between one meter and four meters above ground to find the maximum emissions field strength of both horizontal and vertical polarization.
4. For each suspected emissions, the antenna tower was scan (from 1 M to 4 M) and then the turntable was rotated (from 0 degree to 360 degrees) to find the maximum reading.
5. Set the test-receiver system to Peak or CISPR quasi-peak Detect Function with specified bandwidth under Maximum Hold Mode.
6. For emissions above 1GHz, use 1MHz VBW and RBW for peak reading. Then 1MHz RBW and 10Hz VBW for average reading in spectrum analyzer.
7. When the radiated emissions limits are expressed in terms of the average value of the emissions, and pulsed operation is employed, the measurement field strength shall be determined by averaging over one complete pulse train, including blanking intervals, as long as the pulse train does not exceed 0.1 seconds. As an alternative (provided the transmitter operates for longer than 0.1 seconds) or in cases where the pulse train exceeds 0.1 seconds, the measured field strength shall be determined from the average absolute voltage during a 0.1 second interval during which the field strength is at its maximum value.
8. If the emissions level of the EUT in peak mode was 3 dB lower than the average limit specified, then testing will be stopped and peak values of EUT will be reported, otherwise, the emissions which do not have 3 dB margin will be repeated one by one using the quasi-peak method for below 1GHz.
9. For testing above 1GHz, the emissions level of the EUT in peak mode was lower than average limit (that means the emissions level in peak mode also complies with the limit in average mode), then testing will be stopped and peak values of EUT will be reported, otherwise, the emissions will be measured in average mode again and reported.
10. In case the emission is lower than 30MHz, loop antenna has to be used for measurement and the recorded data should be QP measured by receiver. High – Low scan is not required in this case.

3.5.4 Test Setup Layout

For radiated emissions below 30MHz

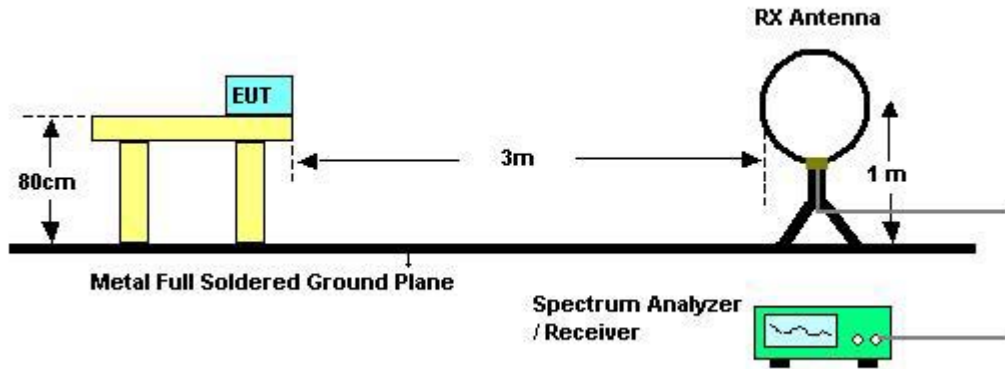

For radiated emissions above 30MHz

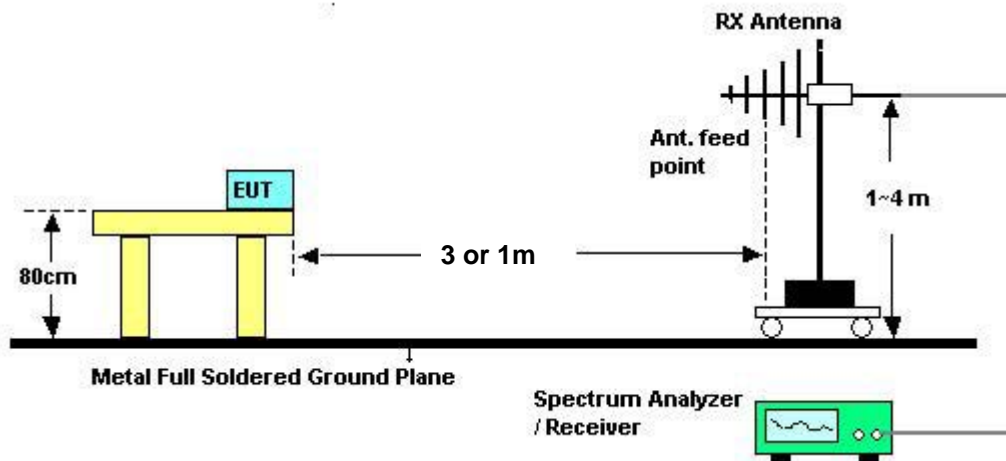

Above 10 GHz shall be extrapolated to the specified distance using an extrapolation factor of 20 dB/decade from 3m to 1m.

Distance extrapolation factor = $20 \log (\text{specific distance [3m]} / \text{test distance [1m]})$ (dB);

Limit line = specific limits (dBuV) + distance extrapolation factor [9.54 dB].

3.5.5 Test Deviation

There is no deviation with the original standard.

3.5.6 EUT Operation during Test

The EUT was programmed to be in continuously transmitting mode.

3.5.7 Results of Radiated Emissions (9kHz~30MHz)

Final Test Date	Jan. 05, 2010	Test Site No.	03CH02-HY
Temperature	23	Humidity	54%
Test Engineer	Billy		

Freq. (MHz)	Level (dBuV)	Over Limit (dB)	Limit Line (dBuV)	Remark
-	-	-	-	See Note

Note:

The amplitude of spurious emissions that are attenuated by more than 20 dB below the permissible value has no need to be reported.

Distance extrapolation factor = $40 \log (\text{specific distance} / \text{test distance})$ (dB);

Limit line = specific limits (dBuV) + distance extrapolation factor.

3.5.8 Results of Radiated Emissions (30MHz~1GHz)

Final Test Date	Jan. 05, 2010	Test Site No.	03CH02-HY
Temperature	23	Humidity	54%
Test Engineer	Billy	Configuration	Normal Mode

Horizontal

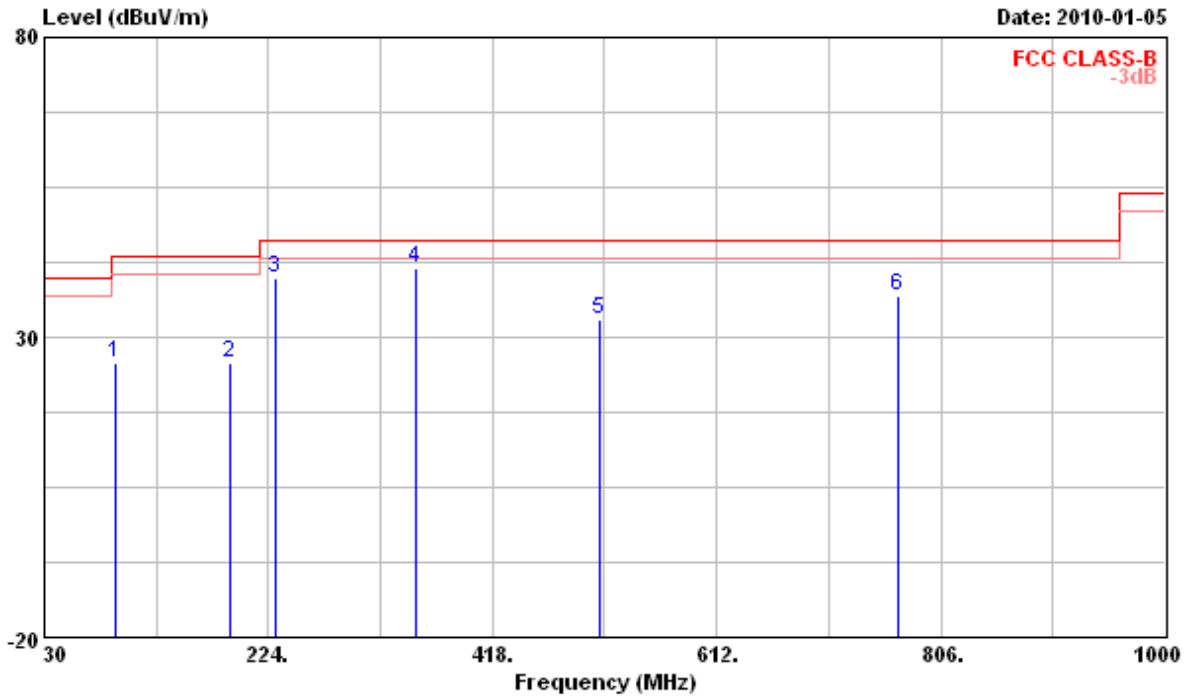

	Freq	Level	Over Limit	Limit Line	ReadAntenna Level	Antenna Factor	Cable Loss	Preamp Factor	Remark
	MHz	dBuV/m	dB	dBuV/m	dBuV	dB/m	dB	dB	
1	91.110	25.60	-17.90	43.50	44.80	9.67	1.93	30.80	Peak
2	191.020	25.76	-17.74	43.50	42.95	10.70	2.73	30.62	Peak
3	229.820	39.86	-6.14	46.00	55.09	12.33	2.98	30.54	Peak
4	351.070	41.37	-4.63	46.00	53.48	14.49	3.70	30.30	QP
5	510.150	32.96	-13.04	46.00	40.94	17.59	4.30	29.87	Peak
6	769.140	36.89	-9.11	46.00	40.72	19.83	5.40	29.06	Peak

Vertical

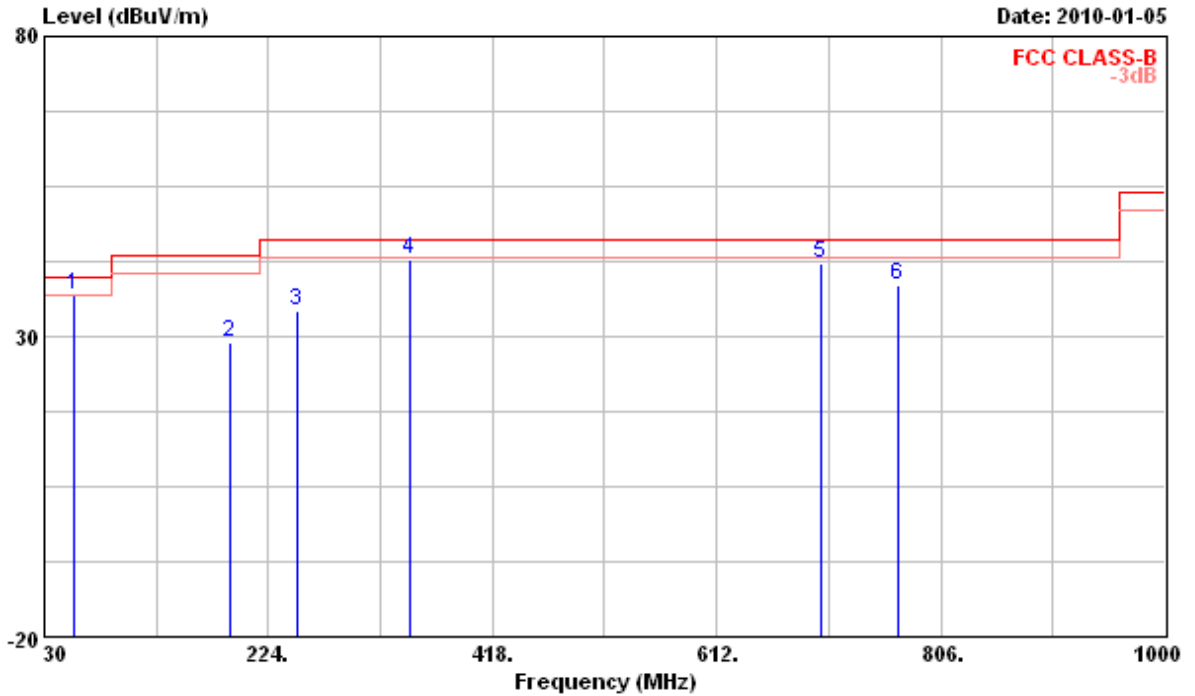

Freq	Level	Over Limit	Limit Line	ReadAntenna Level	Antenna Factor	Cable Loss	Preamp Factor	Remark
MHz	dBuV/m	dB	dBuV/m	dBuV	dB/m	dB	dB	
1	56.190	36.95	-3.05	40.00	58.16	8.05	1.54	30.80 QP
2	191.020	28.86	-14.64	43.50	46.05	10.70	2.73	30.62 Peak
3	249.220	34.20	-11.80	46.00	48.63	12.97	3.10	30.50 Peak
4	347.190	42.78	-3.22	46.00	54.97	14.43	3.69	30.31 Peak
5	703.180	42.24	-3.76	46.00	47.40	18.91	5.12	29.19 Peak
6	769.140	38.48	-7.52	46.00	42.31	19.83	5.40	29.06 Peak

Note:

The amplitude of spurious emissions that are attenuated by more than 20dB below the permissible value has no need to be reported.

Emission level (dBuV/m) = 20 log Emission level (uV/m).

Corrected Reading: Antenna Factor + Cable Loss + Read Level - Preamp Factor = Level.

3.5.9 Results for Radiated Emissions (1GHz~10th Harmonic)

Final Test Date	Dec. 09, 2008	Test Site No.	03CH03-HY
Temperature	23.9	Humidity	44%
Test Engineer	Eddie	Configuration	Mode 1 802.11b CH 1

Horizontal

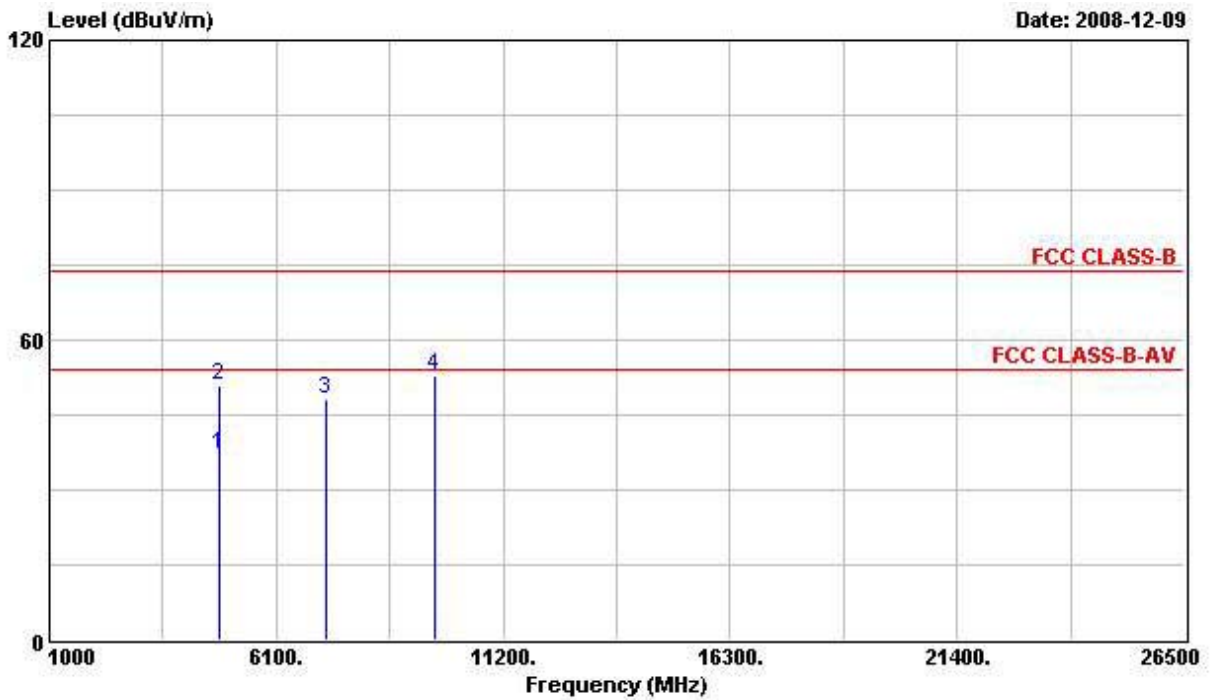

	Freq	Level	Over Limit	Limit Line	ReadAntenna	Cable	Preamp	Remark
	MHz	dBuV/m	dB	dBuV/m	dBuV	dB/m	dB	dB
1	4825.800	37.30	-16.70	54.00	32.69	33.06	4.03	32.47 AVERAGE
2	4825.800	51.05	-22.95	74.00	46.44	33.06	4.03	32.47 Peak
3	7232.000	48.27			41.62	35.78	3.67	32.80 PEAK
4	9644.000	52.96			42.33	38.38	5.21	32.95 PEAK

Note: An item 3 and 4 are on un-restricted band, so the limit is -20dB for the field strength of the fundamental emissions (see section 3.6.7).

Vertical

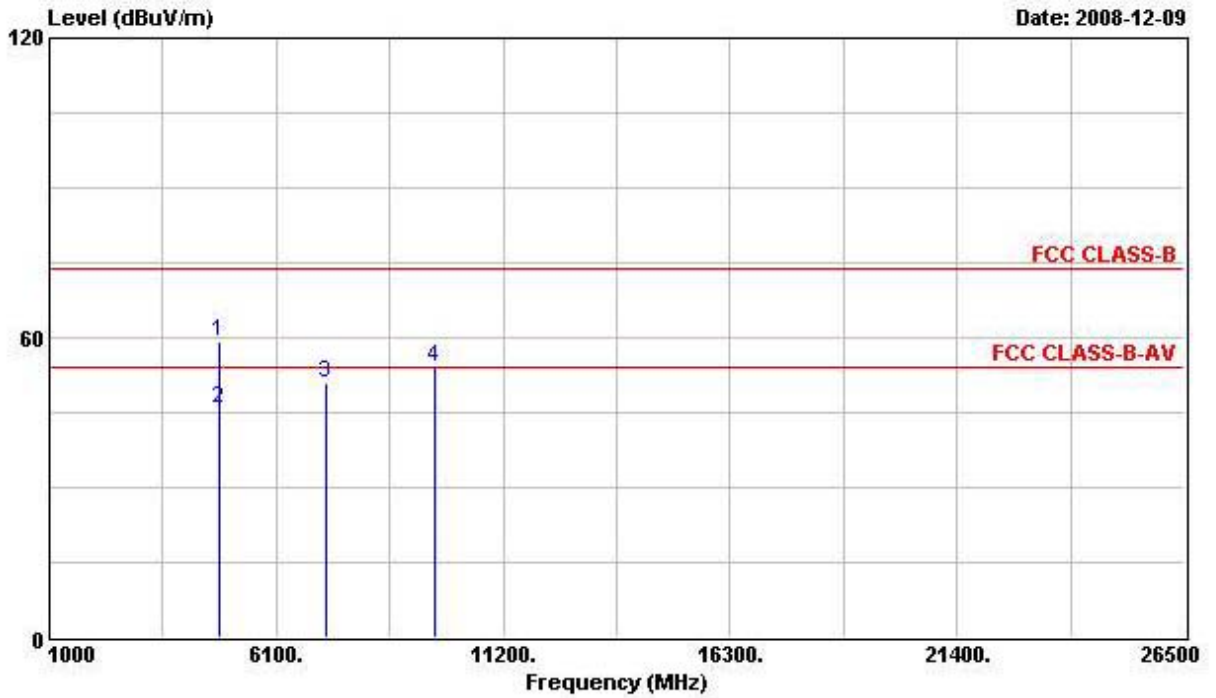

	Freq	Level	Over Limit	Limit Line	ReadAntenna Level	Antenna Factor	Cable Loss	Preamp Factor	Remark
	MHz	dBuV/m	dB	dBuV/m	dBuV	dB/m	dB	dB	
1	4823.900	59.05	-14.95	74.00	54.44	33.06	4.03	32.47	PEAK
2	4823.900	45.88	-8.12	54.00	41.27	33.06	4.03	32.47	Average
3	7236.000	50.97			44.34	35.78	3.67	32.82	PEAK
4	9652.000	54.00			43.33	38.41	5.21	32.95	PEAK

Note: An item 3 and 4 are on un-restricted band, so the limit is -20dB for the field strength of the fundamental emissions (see section 3.6.7).

Final Test Date	Dec. 09, 2008	Test Site No.	03CH03-HY
Temperature	23.9	Humidity	44%
Test Engineer	Eddie	Configuration	Mode 1 802.11b CH 6

Horizontal

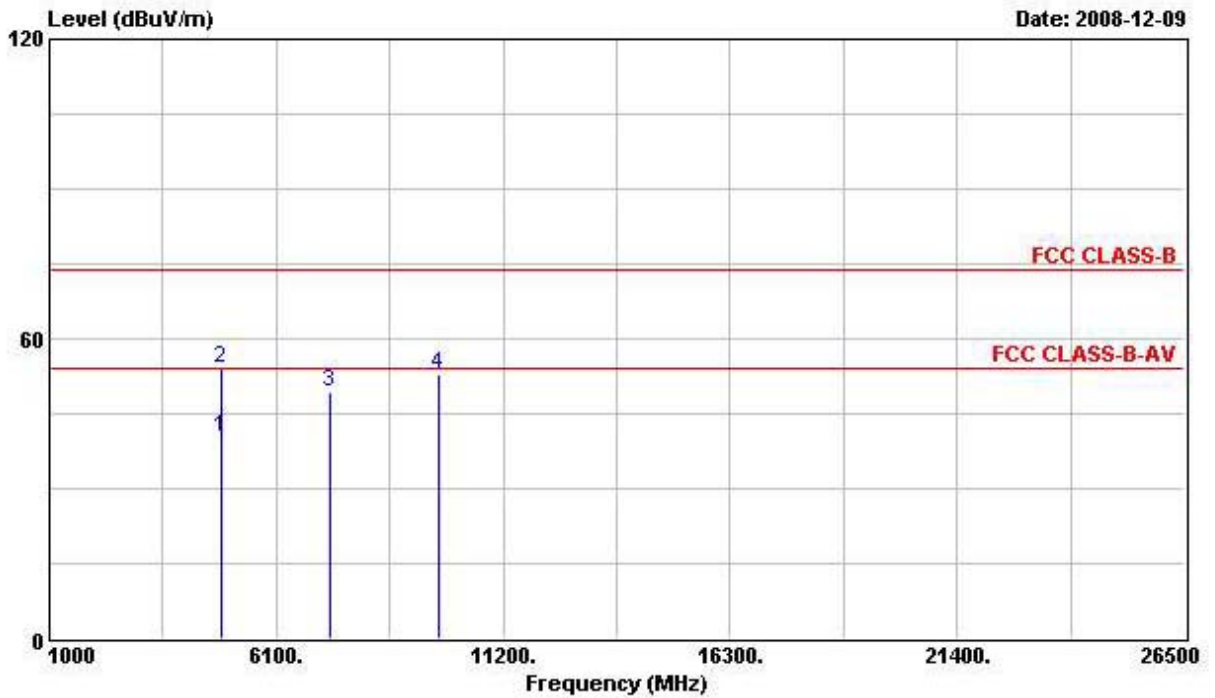

	Freq	Level	Over Limit	Limit Line	ReadAntenna Level	Antenna Factor	Cable Loss	Preamp Factor	Remark
	MHz	dBuV/m	dB	dBuV/m	dBuV	dB/m	dB	dB	
1	4876.000	40.17	-13.83	54.00	35.45	33.16	4.02	32.47	AVERAGE
2	4876.000	54.06	-19.94	74.00	49.34	33.16	4.02	32.47	Peak
3	7311.000	49.25	-4.75	54.00	42.24	35.94	3.91	32.85	PK
4	9744.000	52.86			41.88	38.58	5.31	32.92	PEAK

Note: An item 4 is on un-restricted band, so the limit is -20dB for the field strength of the fundamental emissions (see section 3.6.7).

Vertical

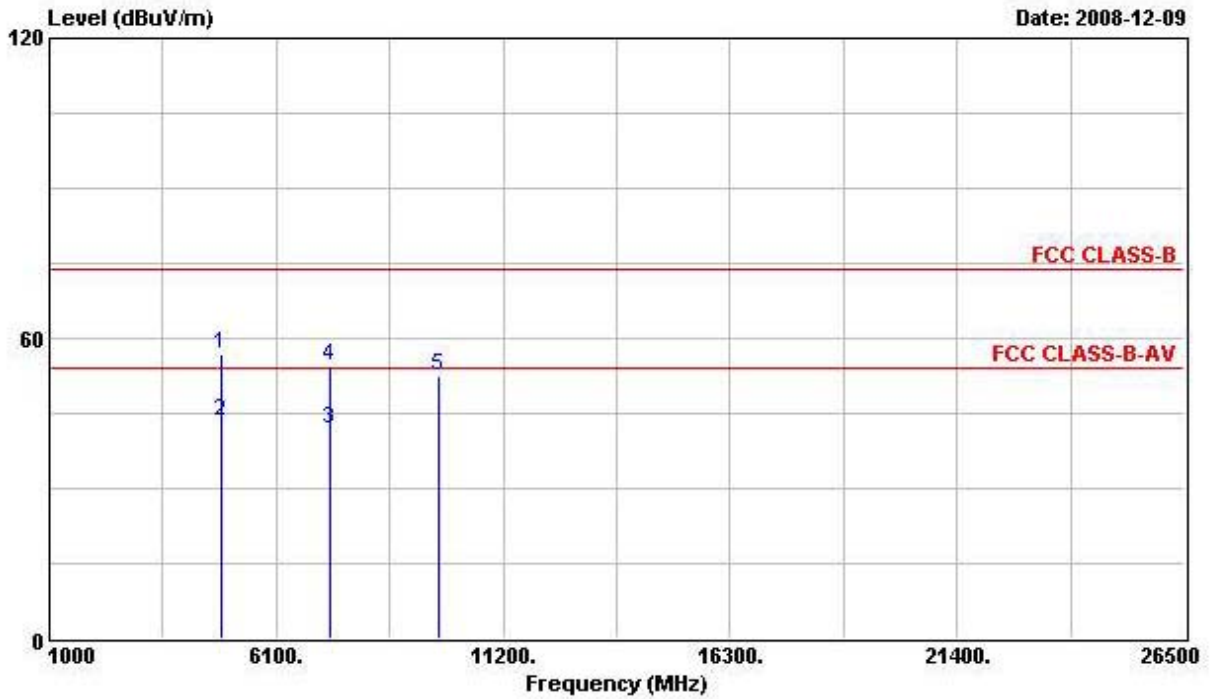

	Freq	Level	Over Limit	Limit Line	ReadAntenna Level	Antenna Factor	Cable Loss	Preamp Factor	Remark
	MHz	dBuV/m	dB	dBuV/m	dBuV	dB/m	dB	dB	
1	4872.000	56.74	-17.26	74.00	52.02	33.16	4.02	32.47	Peak
2	4872.000	43.32	-10.68	54.00	38.61	33.16	4.02	32.47	AVERAGE
3	7309.500	41.89	-12.11	54.00	34.88	35.94	3.91	32.85	AVERAGE
4	7309.500	54.64	-19.36	74.00	47.63	35.94	3.91	32.85	Peak
5	9744.000	52.60			41.63	38.58	5.31	32.92	PEAK

Note: An item 5 is on un-restricted band, so the limit is -20dB for the field strength of the fundamental emissions (see section 3.6.7).

Final Test Date	Dec. 09, 2008	Test Site No.	03CH03-HY
Temperature	23.9	Humidity	44%
Test Engineer	Eddie	Configuration	Mode 1 802.11b CH 11

Horizontal

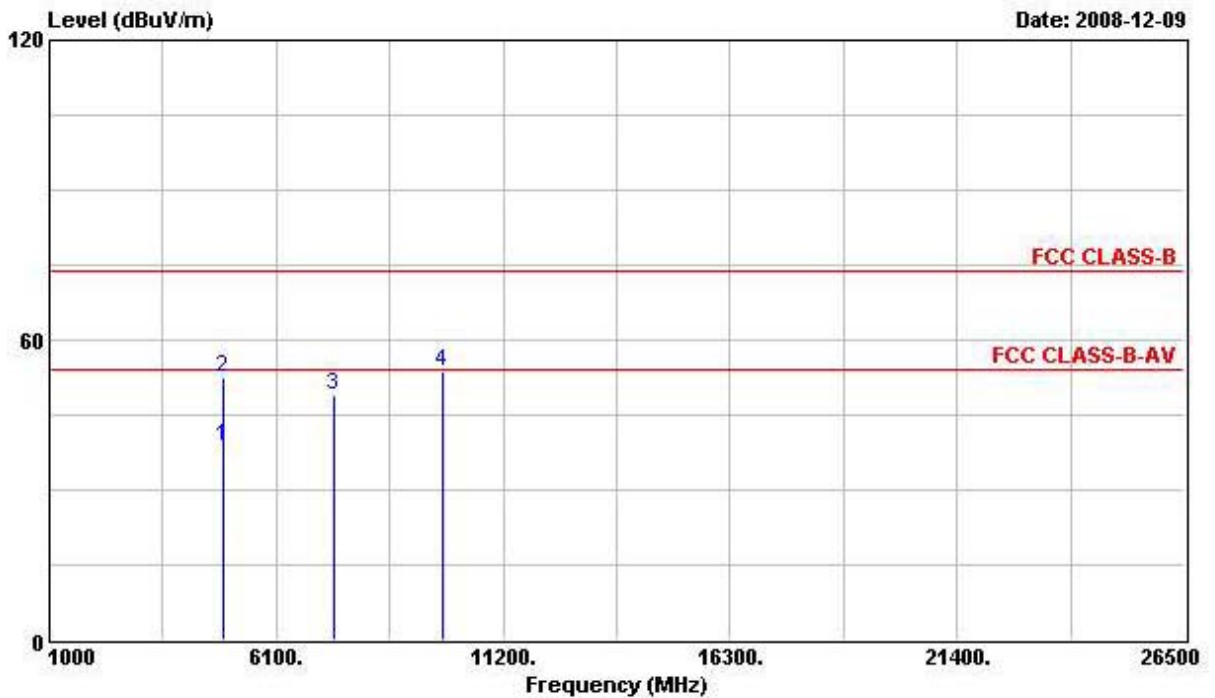

	Freq	Level	Over Limit	Limit Line	ReadAntenna Level	Antenna Factor	Cable Loss	Preamp Factor	Remark
	MHz	dBuV/m	dB	dBuV/m	dBuV	dB/m	dB	dB	
1	4921.900	38.79	-15.21	54.00	33.97	33.26	4.02	32.46	AVERAGE
2	4921.900	52.56	-21.44	74.00	47.75	33.26	4.02	32.46	Peak
3	7382.000	49.14	-4.86	54.00	41.78	36.11	4.16	32.90	PK
4	9852.000	53.50			42.10	38.82	5.47	32.89	PEAK

Note: An item 4 is on un-restricted band, so the limit is -20dB for the field strength of the fundamental emissions (see section 3.6.7).

Vertical

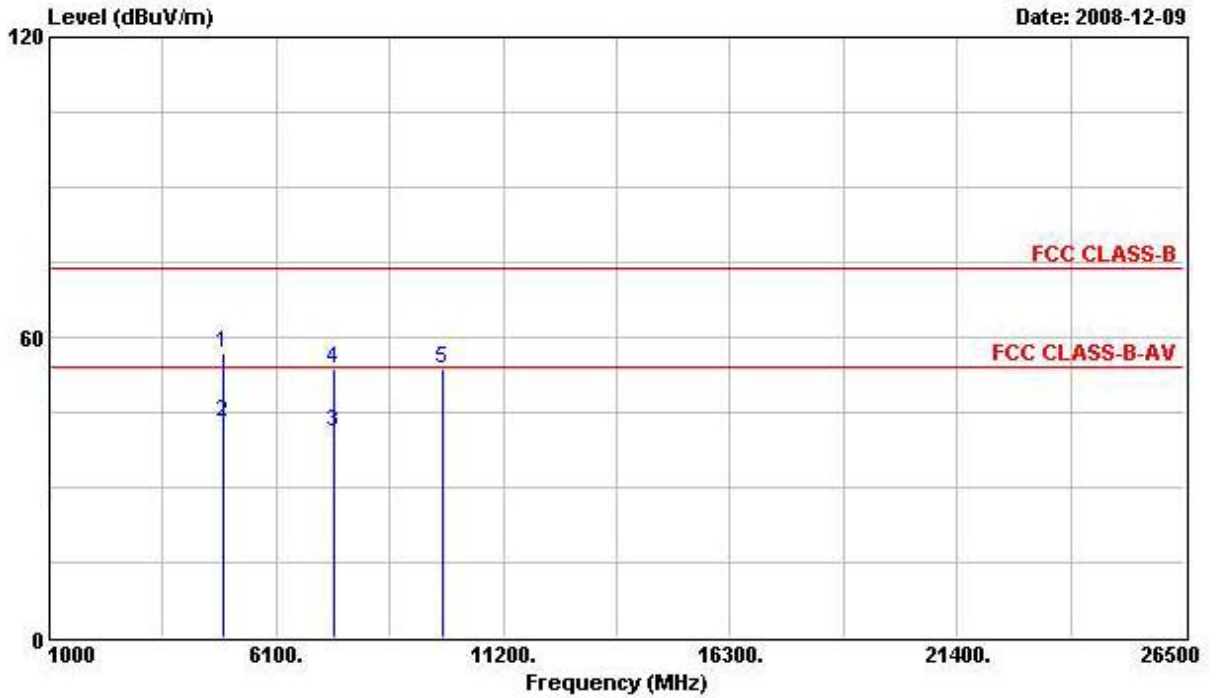

	Freq	Level	Over Limit	Limit Line	ReadAntenna Level	Antenna Factor	Cable Loss	Preamp Factor	Remark
	MHz	dBuV/m	dB	dBuV/m	dBuV	dB/m	dB	dB	
1	4922.100	56.80	-17.20	74.00	51.99	33.26	4.02	32.46	Peak
2	4922.100	43.13	-10.87	54.00	38.31	33.26	4.02	32.46	AVERAGE
3	7386.400	41.13	-12.87	54.00	33.72	36.15	4.16	32.90	AVERAGE
4	7386.400	53.74	-20.26	74.00	46.33	36.15	4.16	32.90	Peak
5	9848.000	53.52			42.16	38.79	5.47	32.89	PEAK

Note: An item 5 is on un-restricted band, so the limit is -20dB for the field strength of the fundamental emissions (see section 3.6.7).

Final Test Date	Dec. 08, 2008	Test Site No.	03CH03-HY
Temperature	23.9	Humidity	44%
Test Engineer	Eddie	Configuration	Mode1 802.11g CH 1

Horizontal

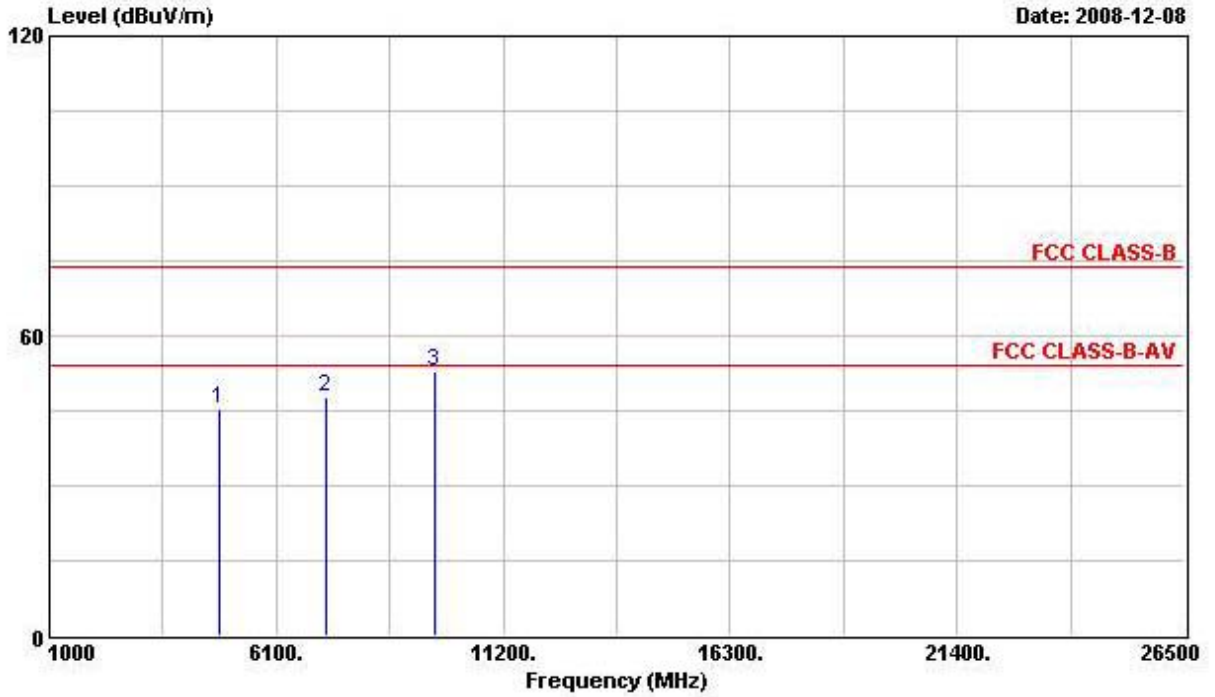

	Freq	Level	Over Limit	Limit Line	ReadAntenna Level	Antenna Factor	Cable Loss	Preamp Factor	Remark
	MHz	dBuV/m	dB	dBuV/m	dBuV	dB/m	dB	dB	
1	4820.000	45.47	-8.53	54.00	40.86	33.06	4.03	32.47	PK
2	7232.000	47.90			41.25	35.78	3.67	32.80	PEAK
3	9644.000	52.83			42.19	38.38	5.21	32.95	PEAK

Note: An item 2 and 3 are on un-restricted band, so the limit is -20dB for the field strength of the fundamental emissions (see section 3.6.7).

Vertical

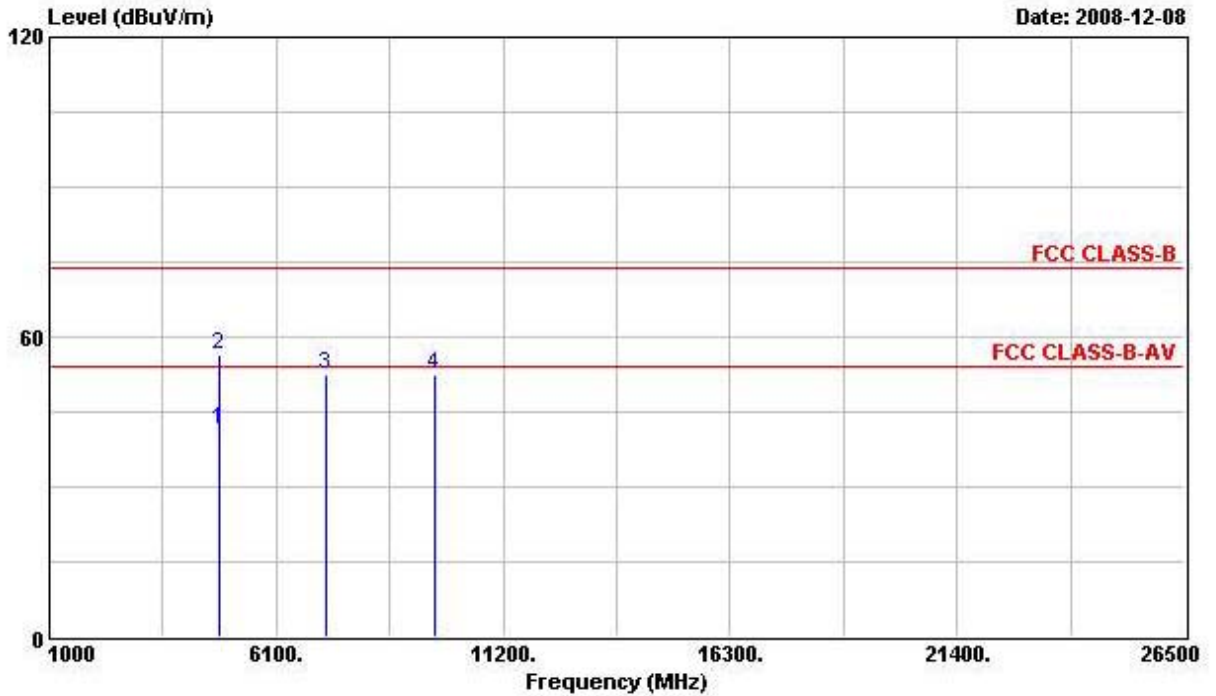

	Freq	Level	Over Limit	Limit Line	ReadAntenna Level	Antenna Factor	Cable Loss	Preamp Factor	Remark
	MHz	dBuV/m	dB	dBuV/m	dBuV	dB/m	dB	dB	
1	4824.200	41.26	-12.74	54.00	36.65	33.06	4.03	32.47	AVERAGE
2	4824.200	56.42	-17.58	74.00	51.81	33.06	4.03	32.47	Peak
3	7236.000	52.33			45.70	35.78	3.67	32.82	PEAK
4	9652.000	52.43			41.76	38.41	5.21	32.95	PEAK

Note: An item 3 and 4 are on un-restricted band, so the limit is -20dB for the field strength of the fundamental emissions (see section 3.6.7).

Final Test Date	Dec. 08, 2008	Test Site No.	03CH03-HY
Temperature	23.9	Humidity	44%
Test Engineer	Eddie	Configuration	Mode 1 802.11g CH 6

Horizontal

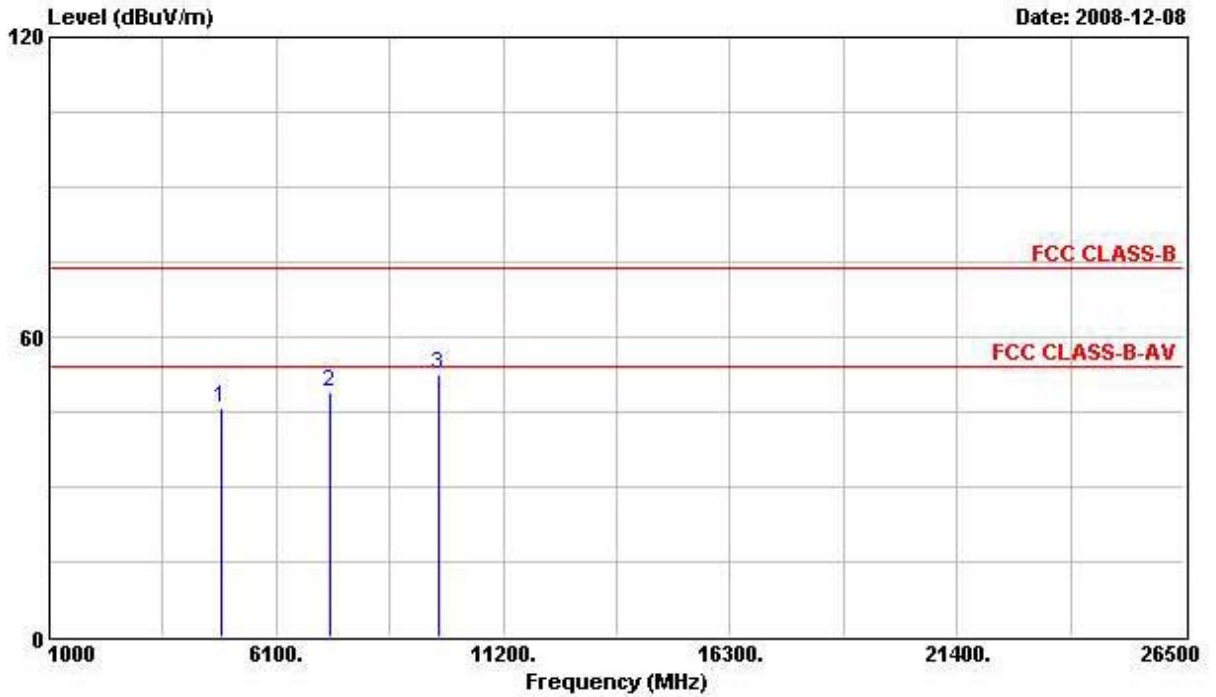

	Freq	Level	Over Limit	Limit Line	ReadAntenna Level	Antenna Factor	Cable Loss	Preamp Factor	Remark
	MHz	dBuV/m	dB	dBuV/m	dBuV	dB/m	dB	dB	
1	4878.000	45.74	-8.26	54.00	41.03	33.16	4.02	32.47	PK
2	7315.000	48.82	-5.18	54.00	41.83	35.94	3.91	32.87	PK
3	9752.000	52.50			41.49	38.62	5.31	32.92	PEAK

Note: An item 3 is on un-restricted band, so the limit is -20dB for the field strength of the fundamental emissions (see section 3.6.7).

Vertical

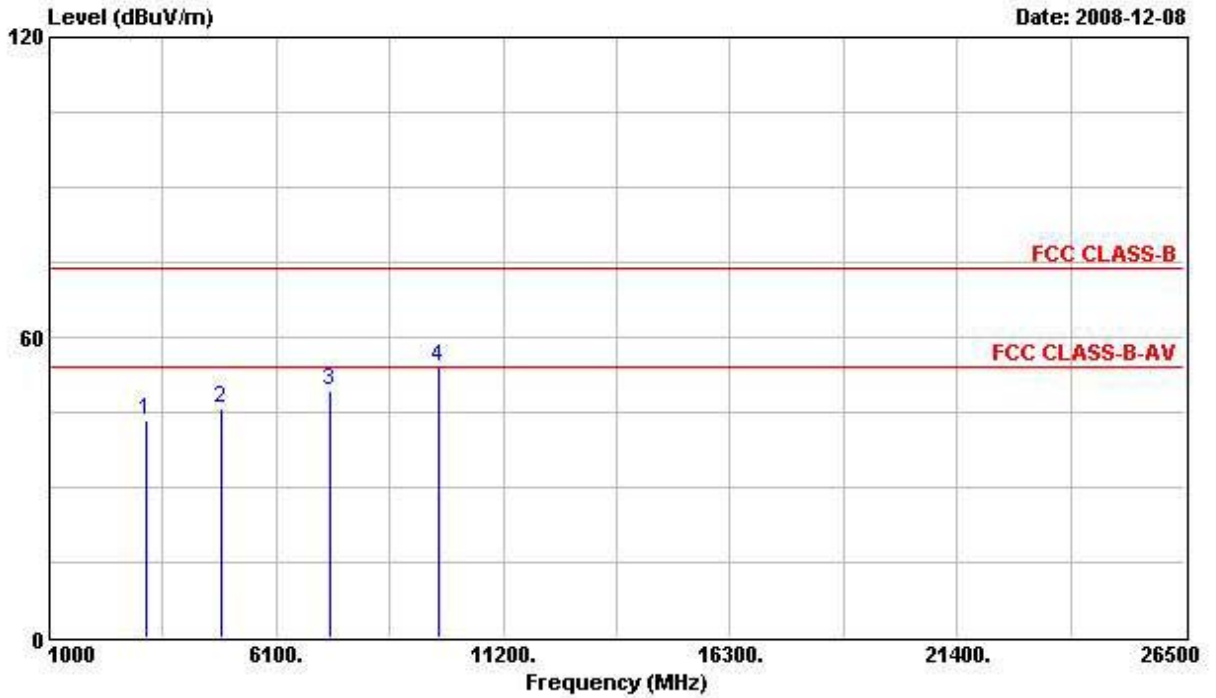

	Freq	Level	Over Limit	Limit Line	ReadAntenna Level	Antenna Factor	Cable Loss	Preamp Factor	Remark
	MHz	dBuV/m	dB	dBuV/m	dBuV	dB/m	dB	dB	
1	3192.000	43.53			43.48	30.48	2.47	32.91	PEAK
2	4870.000	45.92	-8.08	54.00	41.21	33.16	4.02	32.47	PK
3	7307.000	49.26	-4.74	54.00	42.25	35.94	3.91	32.85	PK
4	9752.000	54.08			43.08	38.62	5.31	32.92	PEAK

Note: An item 1 and 4 are on un-restricted band, so the limit is -20dB for the field strength of the fundamental emissions (see section 3.6.7).

Final Test Date	Dec. 08, 2008	Test Site No.	03CH03-HY
Temperature	23.9	Humidity	44%
Test Engineer	Eddie	Configuration	Mode 1 802.11g CH 11

Horizontal

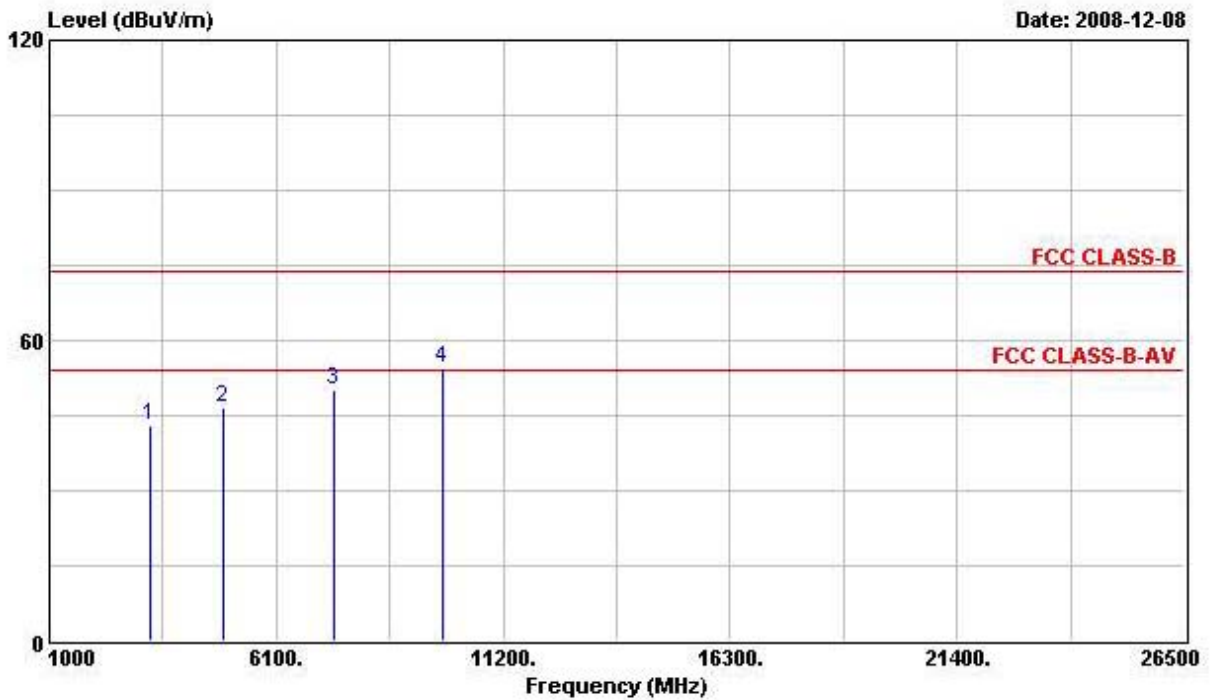

	Freq	Level	Over Limit	Limit Line	ReadAntenna Level	Antenna Factor	Cable Loss	Preamp Factor	Remark
	MHz	dBUV/m	dB	dBUV/m	dBUV	dB/m	dB	dB	
1	3280.000	43.21			42.99	30.65	2.48	32.91	PEAK
2	4924.000	46.68	-7.32	54.00	41.87	33.26	4.02	32.46	PK
3	7390.000	50.26	-3.74	54.00	42.87	36.15	4.16	32.92	PK
4	9852.000	54.29			42.89	38.82	5.47	32.89	PEAK

Note: An item 1 and 4 are on un-restricted band, so the limit is -20dB for the field strength of the fundamental emissions (see section 3.6.7).

Vertical

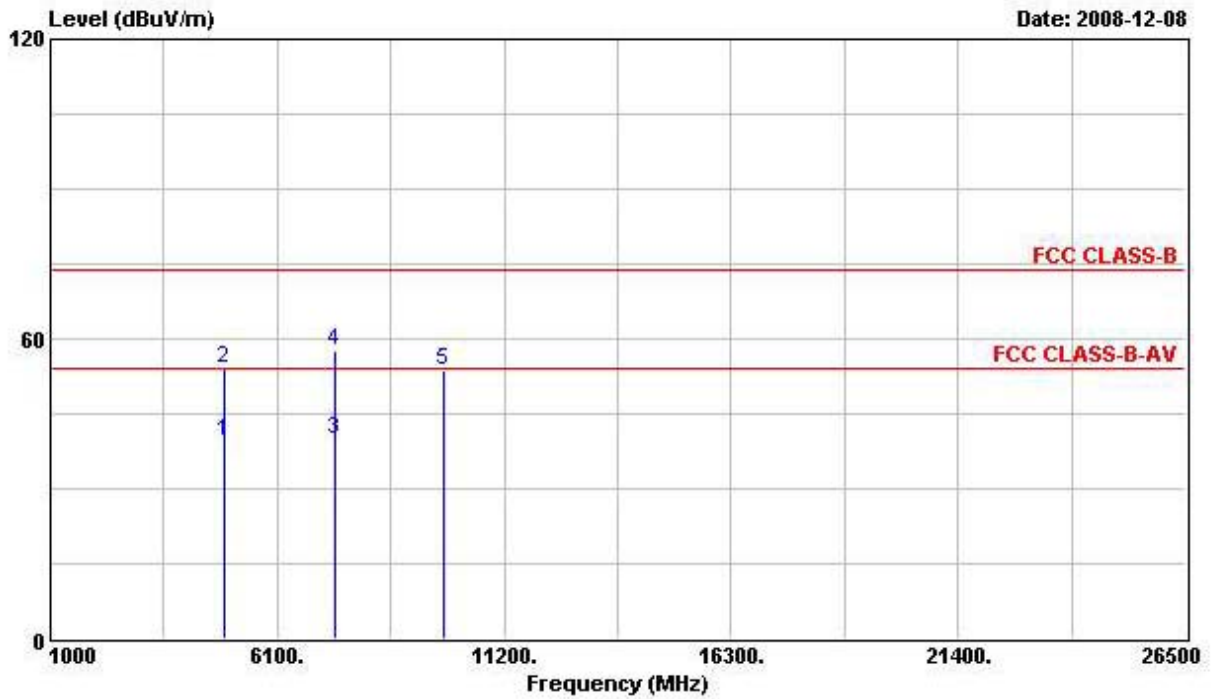

	Freq	Level	Over Limit	Limit Line	ReadAntenna Level	Antenna Factor	Cable Loss	Preamp Factor	Remark
	MHz	dBuV/m	dB	dBuV/m	dBuV	dB/m	dB	dB	
1	4924.200	39.45	-14.55	54.00	34.64	33.26	4.02	32.46	AVERAGE
2	4924.200	53.90	-20.10	74.00	49.09	33.26	4.02	32.46	Peak
3	7385.400	39.87	-14.13	54.00	32.47	36.15	4.16	32.90	AVERAGE
4	7385.400	57.53	-16.47	74.00	50.12	36.15	4.16	32.90	Peak
5	9844.000	53.81			42.45	38.79	5.47	32.89	PEAK

Note: An item 5 is on un-restricted band, so the limit is -20dB for the field strength of the fundamental emissions (see section 3.6.7).

Final Test Date	Mar. 18, 2009	Test Site No.	03CH02-HY
Temperature	26	Humidity	52%
Test Engineer	David	Configuration	Mode 2 802.11b CH 1

Horizontal

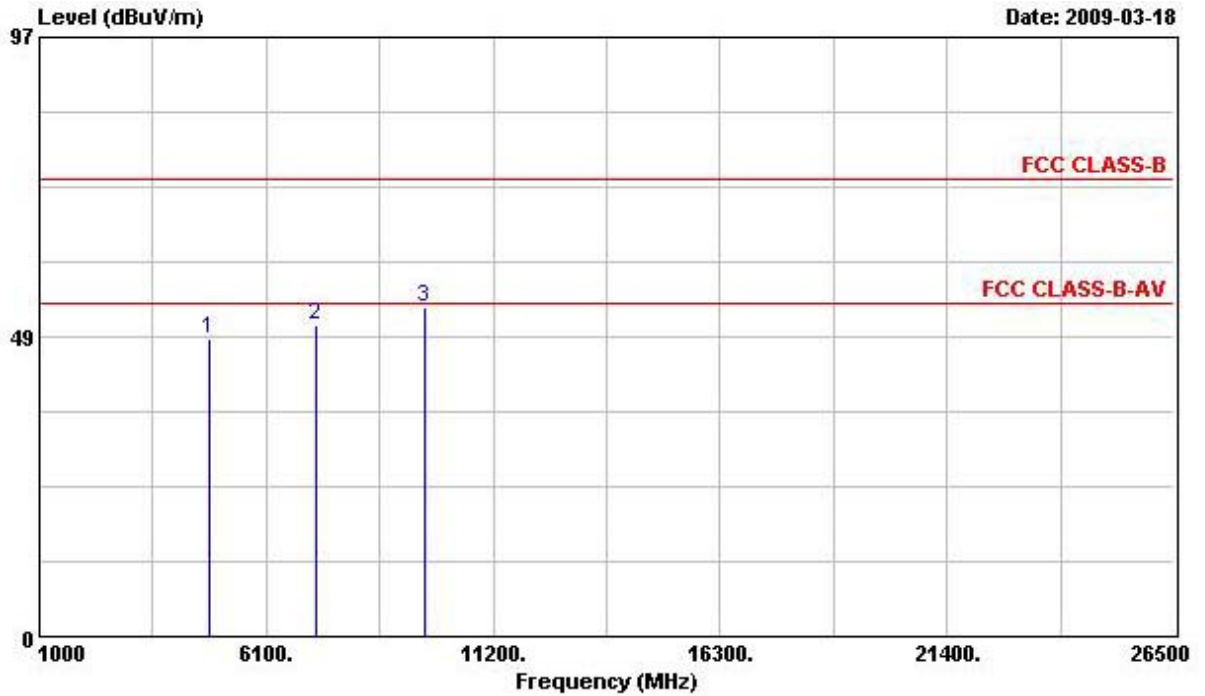

	Freq	Level	Over Limit	Limit Line	Read Level	Antenna Factor	Cable Loss	Preamp Factor	Remark
	MHz	dBUV/m	dB	dBUV/m	dBUV	dB/m	dB	dB	
1	4828.000	48.34	-5.66	54.00	42.92	35.76	4.59	34.94	PK
2	7236.000	50.56			42.34	37.85	5.63	35.25	Peak
3	9648.000	53.32			43.29	39.39	6.34	35.70	Peak

Note: An item 2 and 3 are on un-restricted band, so the limit is -20dB for the field strength of the fundamental emissions (see section 3.6.7).

Vertical

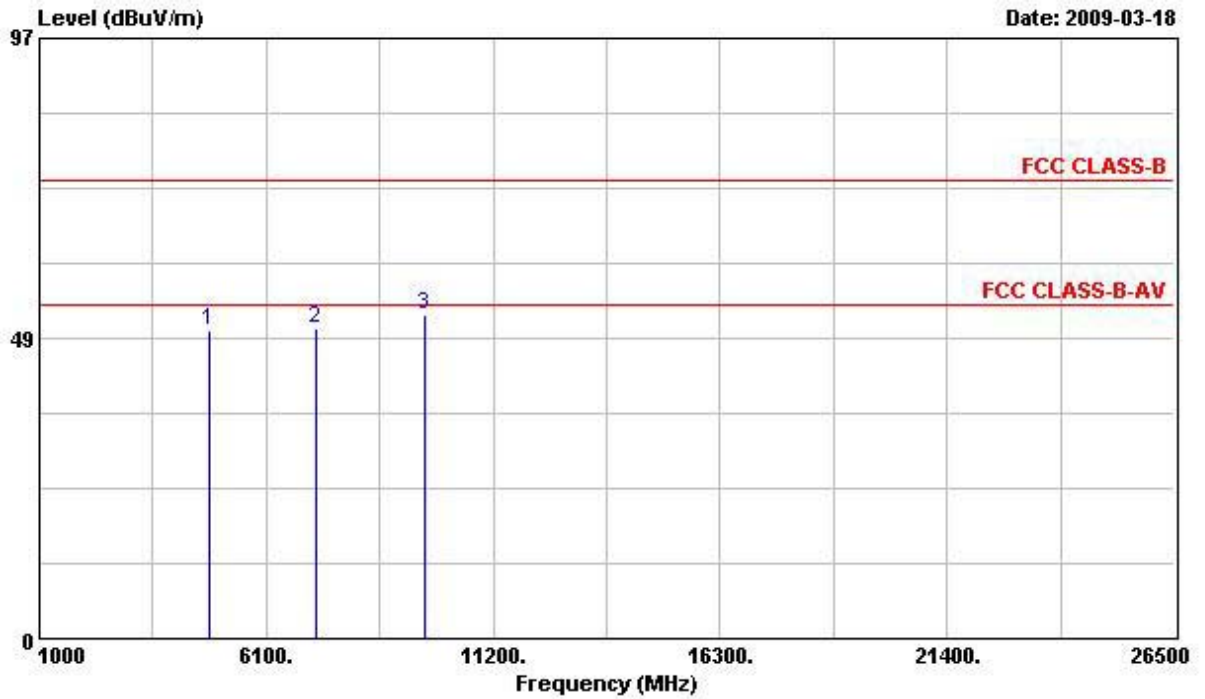

	Freq	Level	Over Limit	Limit Line	ReadAntenna Level	Antenna Factor	Cable Loss	Preamp Factor	Remark
	MHz	dBuV/m	dB	dBuV/m	dBuV	dB/m	dB	dB	
1	4828.000	49.63	-4.37	54.00	44.84	35.13	4.59	34.94	PK
2	7236.000	50.01			42.74	36.90	5.63	35.25	Peak
3	9652.000	52.40			43.17	38.59	6.34	35.70	Peak

Note: An item 2 and 3 are on un-restricted band, so the limit is -20dB for the field strength of the fundamental emissions (see section 3.6.7).

Final Test Date	Mar. 18, 2009	Test Site No.	03CH02-HY
Temperature	26	Humidity	52%
Test Engineer	David	Configuration	Mode 2 802.11b CH 6

Horizontal

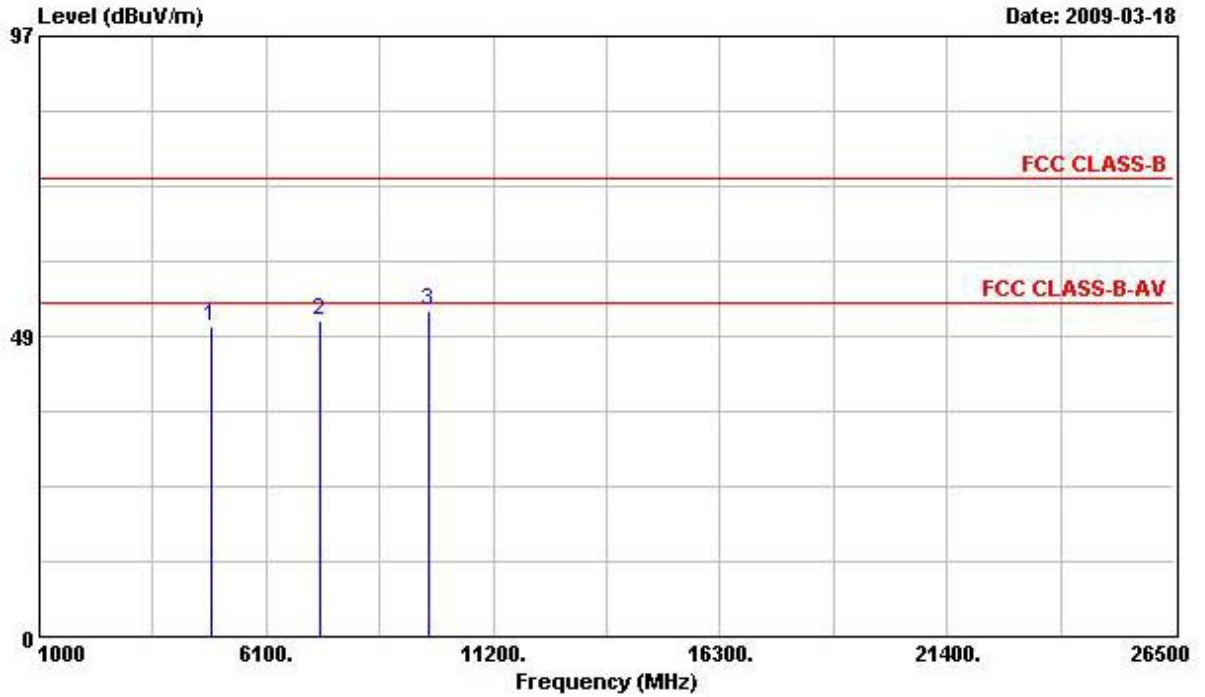

	Freq	Level	Over Limit	Limit Line	Read Antenna	Cable	Preamp	Remark
	MHz	dBuV/m	dB	dBuV/m	dBuV	dB/m	dB	dB
1	4874.000	50.11	-3.89	54.00	44.57	35.83	4.64	34.93 PK
2	7311.000	50.96	-3.04	54.00	42.71	37.86	5.64	35.26 PK
3	9744.000	52.74			42.59	39.49	6.36	35.70 Peak

Note: An item 3 is on un-restricted band, so the limit is -20dB for the field strength of the fundamental emissions (see section 3.6.7).

Vertical

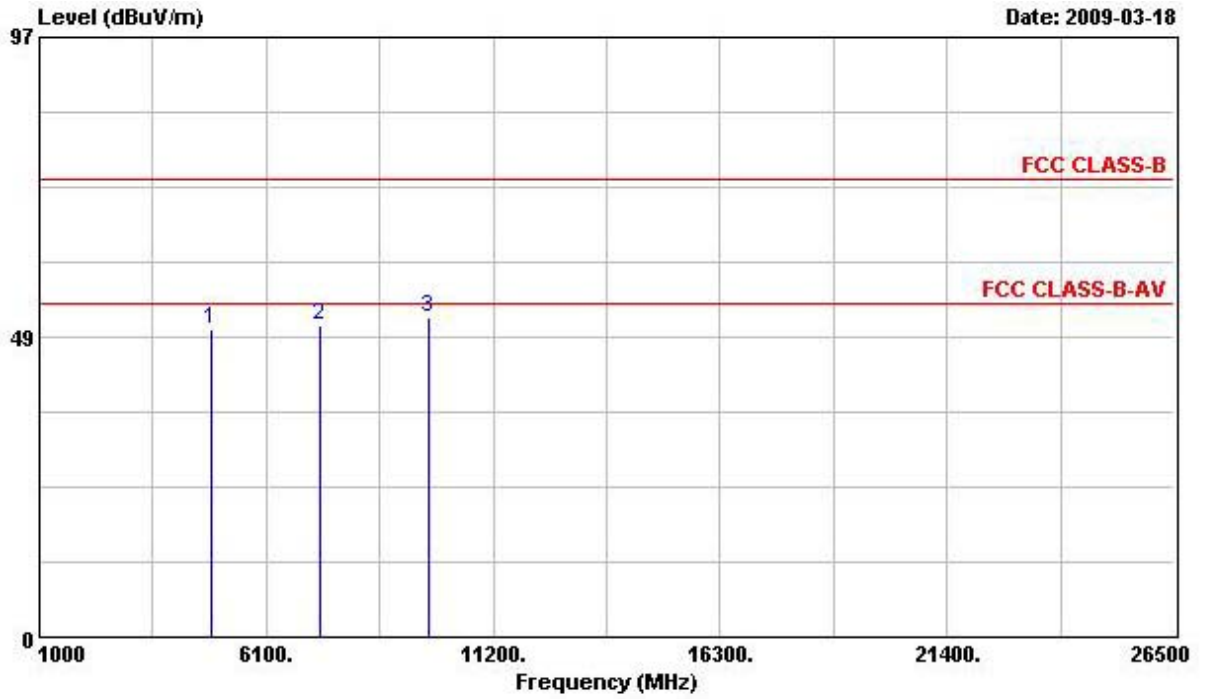

	Freq	Level	Over Limit	Limit Line	ReadAntenna Level	Antenna Factor	Cable Loss	Preamp Factor	Remark
	MHz	dBuV/m	dB	dBuV/m	dBuV	dB/m	dB	dB	
1	4874.000	49.72	-4.28	54.00	44.83	35.18	4.64	34.93	PK
2	7307.000	50.28	-3.72	54.00	42.98	36.92	5.64	35.26	PK
3	9748.000	51.59			42.22	38.71	6.36	35.70	Peak

Note: An item 3 is on un-restricted band, so the limit is -20dB for the field strength of the fundamental emissions (see section 3.6.7).

Final Test Date	Mar. 17, 2009	Test Site No.	03CH02-HY
Temperature	26	Humidity	52%
Test Engineer	David	Configuration	Mode 2 802.11b CH 11

Horizontal

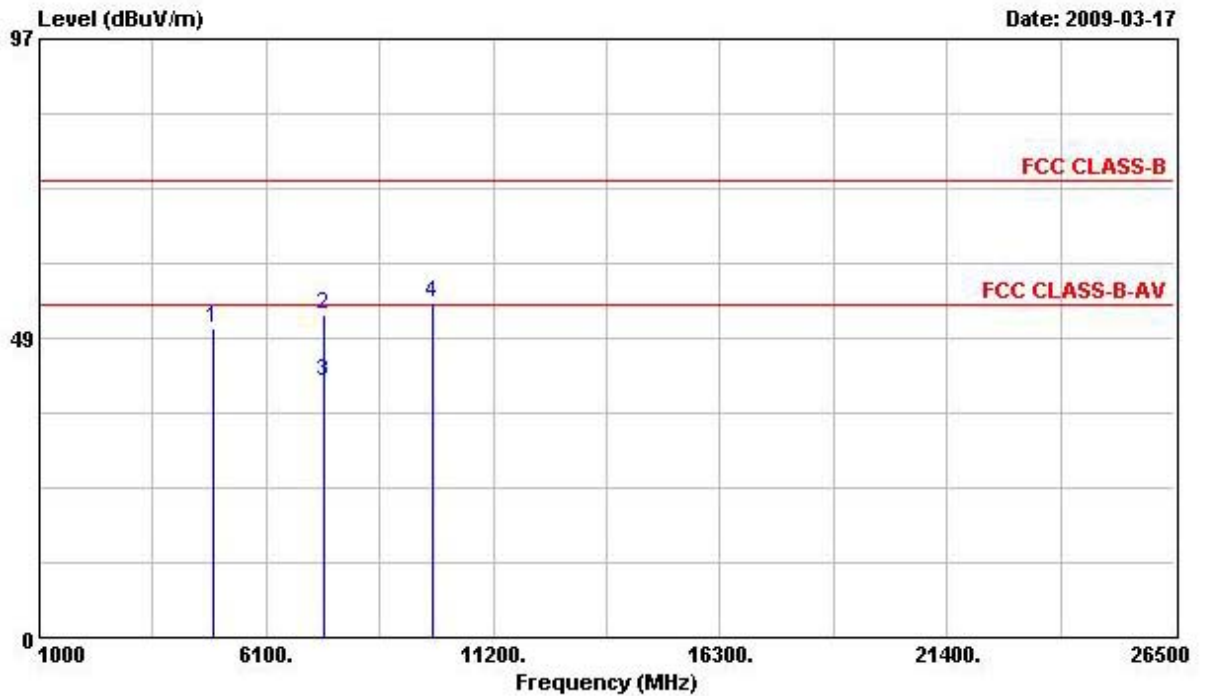

	Freq	Level	Over Limit	Limit Line	ReadAntenna Level	Antenna Factor	Cable Loss	Preamp Factor	Remark
	MHz	dBuV/m	dB	dBuV/m	dBuV	dB/m	dB	dB	
1	4924.000	50.00	-4.00	54.00	44.35	35.90	4.67	34.92	PK
2	7390.000	52.20	-21.80	74.00	43.95	37.88	5.65	35.28	PEAK
3	7390.000	41.37	-12.63	54.00	33.12	37.88	5.65	35.28	Average
4	9852.000	54.09			43.78	39.63	6.38	35.70	PEAK

Note: An item 4 is on un-restricted band, so the limit is -20dB for the field strength of the fundamental emissions (see section 3.6.7).

Vertical

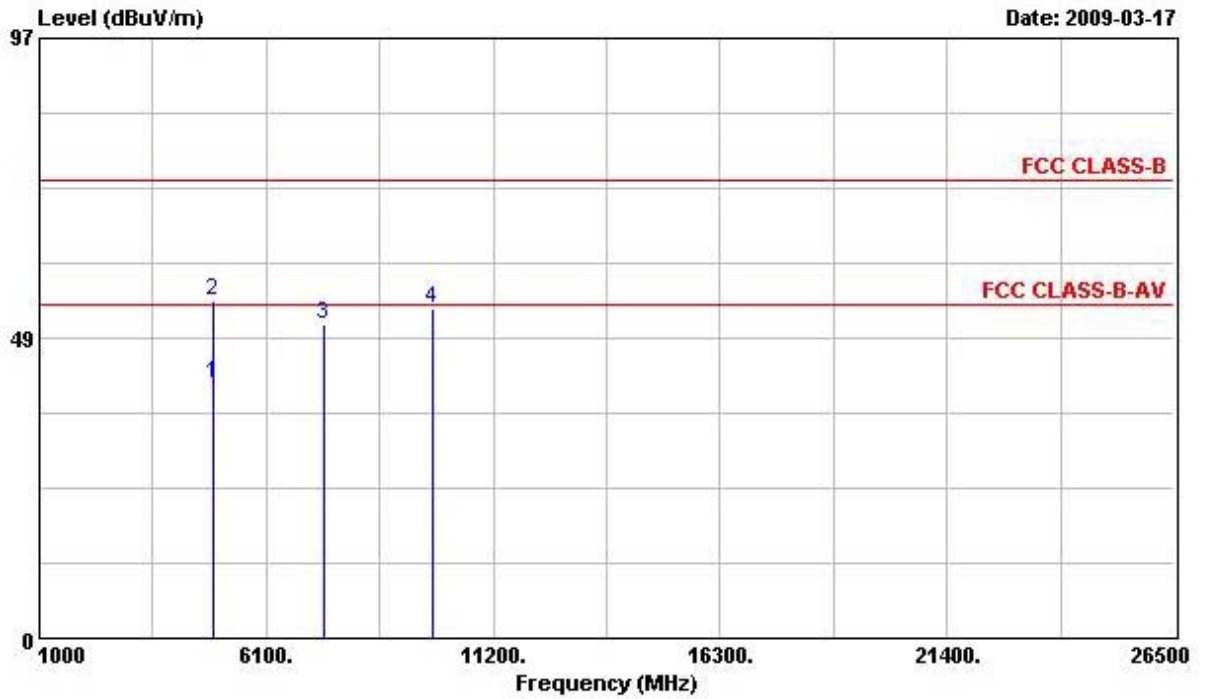

	Freq	Level	Over Limit	Limit Line	ReadAntenna	Cable Preamp	Loss Factor	Preamp	Remark
	MHz	dBuV/m	dB	dBuV/m	dBuV	dB/m	dB	dB	
1	4922.100	41.16	-12.84	54.00	36.17	35.23	4.67	34.92	Average
2	4922.100	54.64	-19.36	74.00	49.66	35.23	4.67	34.92	PEAK
3	7386.000	50.72	-3.28	54.00	43.39	36.96	5.65	35.28	PK
4	9848.000	53.30			43.81	38.81	6.38	35.70	PEAK

Note: An item 4 is on un-restricted band, so the limit is -20dB for the field strength of the fundamental emissions (see section 3.6.7).

Final Test Date	Mar. 16, 2009	Test Site No.	03CH02-HY
Temperature	26	Humidity	52%
Test Engineer	David	Configuration	Mode 2 802.11g CH 1

Horizontal

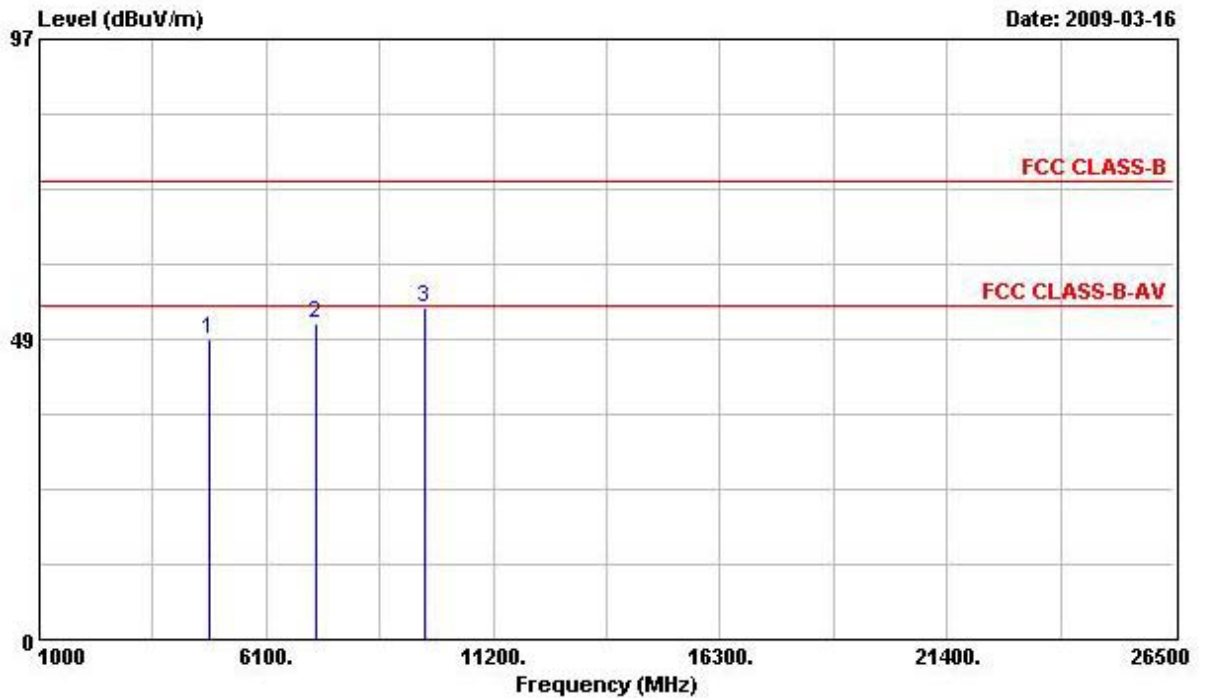

	Freq	Level	Over	Limit	ReadAntenna	Cable	Preamp	Remark
	MHz	dBUV/m	Limit	Line	Level	Loss	Factor	
			dB	dBUV/m	dBUV	dB/m	dB	dB
1	4828.000	48.49	-5.51	54.00	43.07	35.76	4.59	34.94 PK
2	7236.000	51.00			42.77	37.85	5.63	35.25 PEAK
3	9648.000	53.76			43.73	39.39	6.34	35.70 PEAK

Note: An item 2 and 3 are on un-restricted band, so the limit is -20dB for the field strength of the fundamental emissions (see section 3.6.7).

Vertical

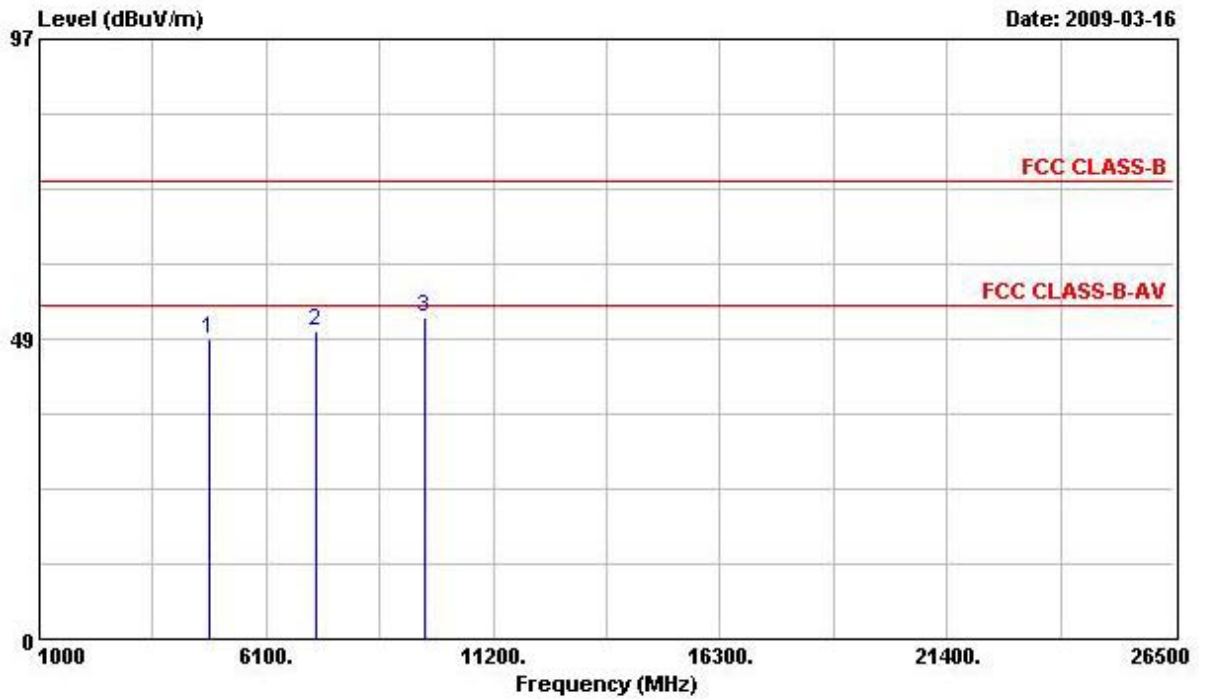

	Freq	Level	Over Limit	Limit Line	Read Level	Antenna Factor	Cable Loss	Preamp Factor	Remark
	MHz	dBuV/m	dB	dBuV/m	dBuV	dB/m	dB	dB	
1	4828.000	48.48	-5.52	54.00	43.69	35.13	4.59	34.94	PK
2	7236.000	49.93			42.65	36.90	5.63	35.25	PEAK
3	9648.000	52.03			42.80	38.59	6.34	35.70	PEAK

Note: An item 2 and 3 are on un-restricted band, so the limit is -20dB for the field strength of the fundamental emissions (see section 3.6.7).

Final Test Date	Mar. 17, 2009	Test Site No.	03CH02-HY
Temperature	26	Humidity	52%
Test Engineer	David	Configuration	Mode 2 802.11g CH 6

Horizontal

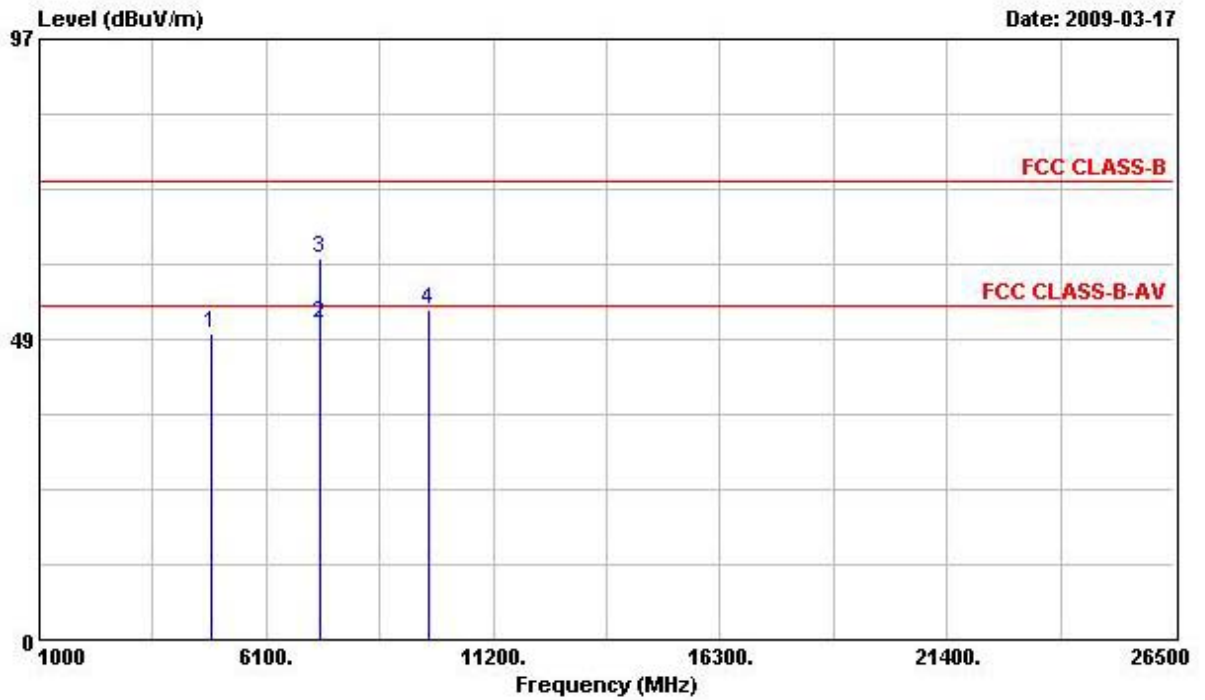

	Freq	Level	Over Limit	Limit Line	Read Level	Antenna Factor	Cable Loss	Preamp Factor	Remark
	MHz	dBuV/m	dB	dBuV/m	dBuV	dB/m	dB	dB	
1	4874.000	49.42	-4.58	54.00	43.87	35.83	4.64	34.93	PK
2	7307.000	50.95	-3.05	54.00	42.71	37.86	5.64	35.26	Average
3	7307.000	61.66	-12.34	74.00	53.42	37.86	5.64	35.26	Peak
4	9748.000	53.38			43.20	39.51	6.36	35.70	PEAK

Note: An item 4 is on un-restricted band, so the limit is -20dB for the field strength of the fundamental emissions (see section 3.6.7).

Vertical

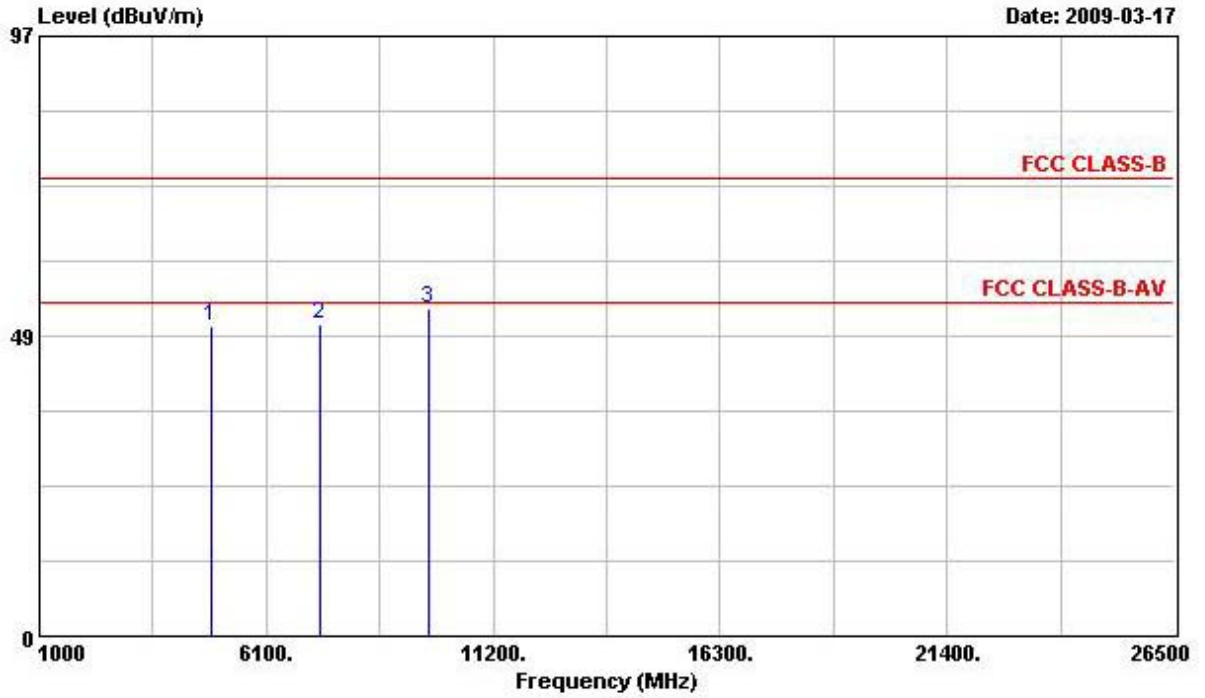

	Freq	Level	Over Limit	Limit Line	ReadAntenna Level	Antenna Factor	Cable Loss	Preamp Factor	Remark
	MHz	dBuV/m	dB	dBuV/m	dBuV	dB/m	dB	dB	
1	4878.000	50.03	-3.97	54.00	45.13	35.18	4.64	34.93	PK
2	7311.000	50.34	-3.66	54.00	43.04	36.92	5.64	35.26	PK
3	9748.000	52.82			43.45	38.71	6.36	35.70	PEAK

Note: An item 3 is on un-restricted band, so the limit is -20dB for the field strength of the fundamental emissions (see section 3.6.7).

Final Test Date	Mar. 18, 2009	Test Site No.	03CH02-HY
Temperature	26	Humidity	52%
Test Engineer	David	Configuration	Mode 2 802.11g CH 11

Horizontal

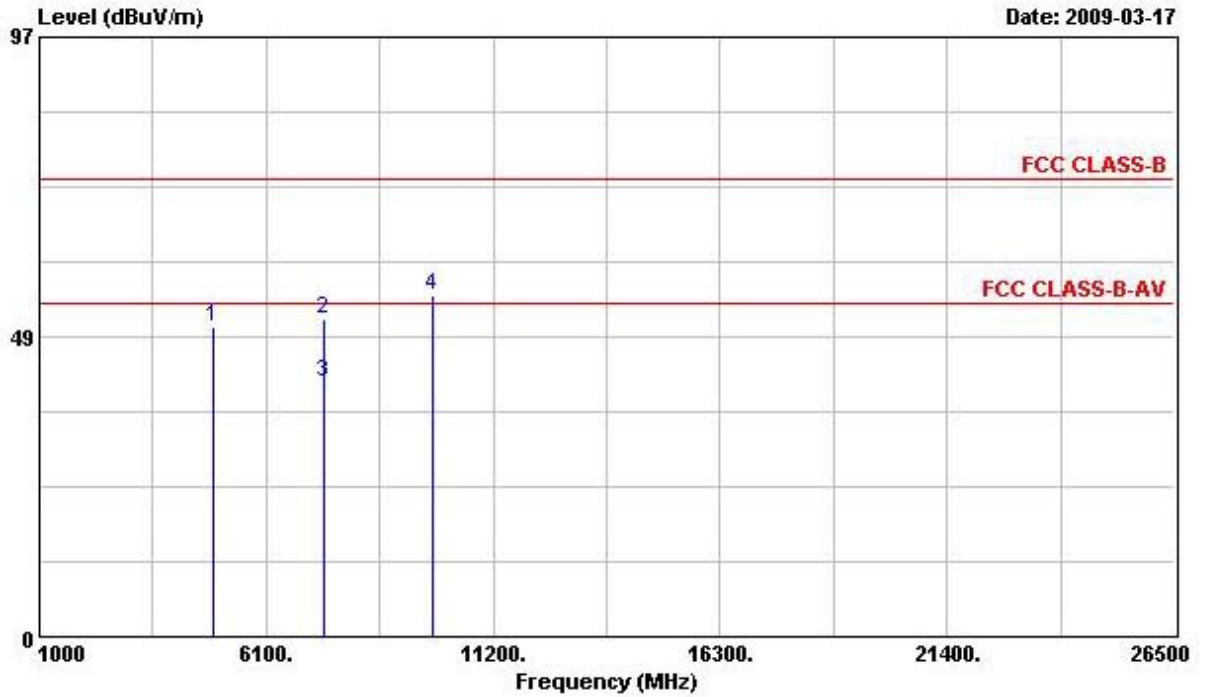

	Freq	Level	Over Limit	Limit Line	Read Level	Antenna Factor	Cable Loss	Preamp Factor	Remark
	MHz	dBuV/m	dB	dBuV/m	dBuV	dB/m	dB	dB	
1	4928.000	50.09	-3.91	54.00	44.44	35.90	4.67	34.92	PK
2	7386.000	51.42	-22.58	74.00	43.17	37.88	5.65	35.28	Peak
3	7386.000	41.03	-12.97	54.00	32.78	37.88	5.65	35.28	Average
4	9848.000	55.35			45.06	39.61	6.38	35.70	PEAK

Note: An item 4 is on un-restricted band, so the limit is -20dB for the field strength of the fundamental emissions (see section 3.6.7).

Vertical

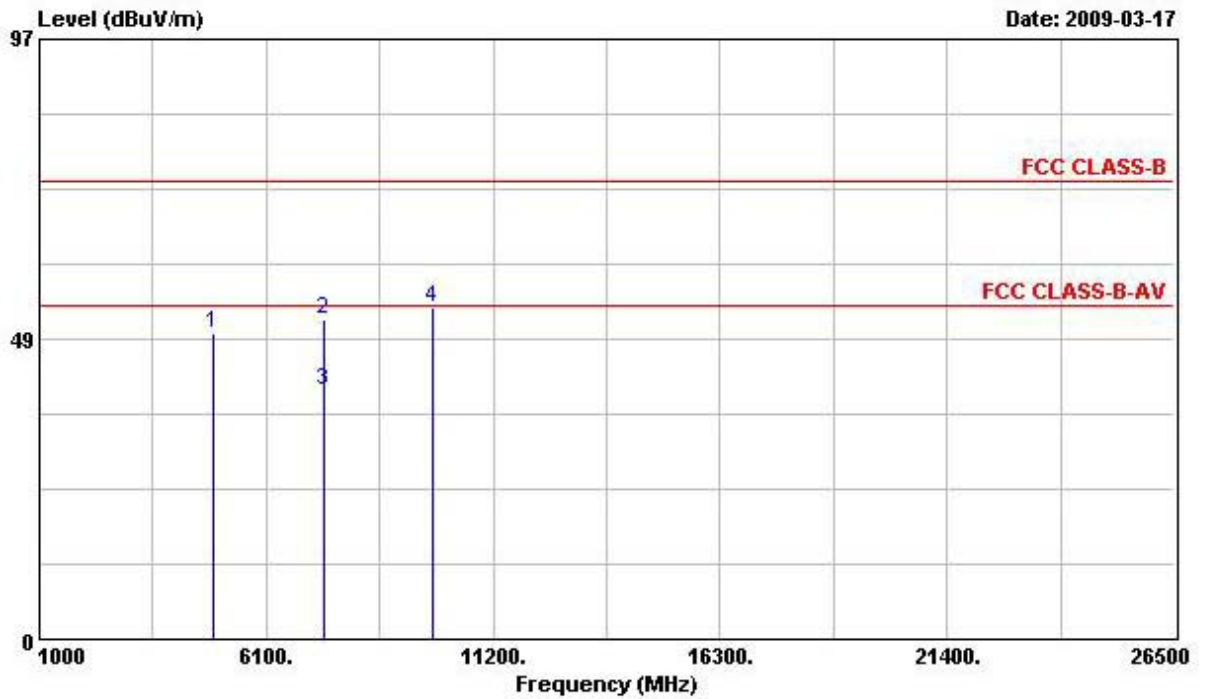

	Freq	Level	Over Limit	Limit Line	Read Level	Antenna Factor	Cable Loss	Preamp Factor	Remark
	MHz	dBuV/m	dB	dBuV/m	dBuV	dB/m	dB	dB	
1	4928.000	49.53	-4.47	54.00	44.55	35.23	4.67	34.92	PK
2	7390.000	51.77	-22.23	74.00	44.44	36.96	5.65	35.28	PEAK
3	7390.000	40.30	-13.70	54.00	32.98	36.96	5.65	35.28	Average
4	9848.000	53.51			44.02	38.81	6.38	35.70	PEAK

Note: An item 4 is on un-restricted band, so the limit is -20dB for the field strength of the fundamental emissions (see section 3.6.7).

The amplitude of spurious emissions that are attenuated by more than 20dB below the permissible value has no need to be reported.

Emission level (dBuV/m) = 20 log Emission level (uV/m).

Corrected Reading: Antenna Factor + Cable Loss + Read Level - Preamp Factor = Level.

3.6 Band Edge and Fundamental Emissions Measurement

3.6.1 Limit

20dBc in any 100 kHz bandwidth outside the operating frequency band. In case the emission fall within the restricted band specified on 15.205(a), then the 15.209(a) limit in the table below has to be followed.

Frequencies (MHz)	Field Strength (microvolt/meter)	Measurement Distance (meters)
0.009~0.490	2400/F(KHz)	300
0.490~1.705	24000/F(KHz)	30
1.705~30.0	30	30
30~88	100	3
88~216	150	3
216~960	200	3
Above 960	500	3

3.6.2 Measuring Instruments and Setting

Please refer to section 4 of equipments list in this report. The following table is the setting of the spectrum analyzer.

Spectrum Parameter	Setting
Attenuation	Auto
Span Frequency	100 MHz
RB / VB (Emission in restricted band)	1MHz / 1MHz for Peak, 1 MHz / 10Hz for Average
RB / VB (Emission in non-restricted band)	1MHz / 1MHz for Peak

3.6.3 Test Procedures

1. The test procedure is the same as section 3.5.3; only the frequency range investigated is limited to 100MHz around band edges.
2. In case the emission is fail due to the used RB/VB is too wide, marker-delta method of FCC Public Notice DA00-705 will be followed.

3.6.4 Test Setup Layout

This test setup layout is the same as that shown in section 3.5.4.

3.6.5 Test Deviation

There is no deviation with the original standard.

3.6.6 EUT Operation during Test

The EUT was programmed to be in continuously transmitting mode.

3.6.7 Test Result of Band Edge and Fundamental Emissions

Final Test Date	Dec. 08, 2008	Test Site No.	03CH03-HY
Temperature	23.9	Humidity	44%
Test Engineer	Eddie	Configuration	Mode 1 802.11b CH 1, 6, 11

Channel 1

	Freq	Level	Over Limit	Limit Line	ReadAntenna Level	Antenna Factor	Cable Loss	Preamp Factor	Remark
	MHz	dBuV/m	dB	dBuV/m	dBuV	dB/m	dB	dB	
1	2390.000	62.17	-11.83	74.00	31.69	28.29	2.19	0.00	Peak
2 @	2412.220	114.02			83.51	28.33	2.19	0.00	Peak
1 @	2390.000	47.64	-6.36	54.00	17.16	28.29	2.19	0.00	Average
2 @	2411.460	105.14			74.63	28.33	2.19	0.00	Average

An item 2 is Fundamental Emissions.

Channel 6

	Freq	Level	Over Limit	Limit Line	ReadAntenna Level	Antenna Factor	Cable Loss	Preamp Factor	Remark
	MHz	dBuV/m	dB	dBuV/m	dBuV	dB/m	dB	dB	
1 @	2438.060	115.09			84.48	28.40	2.22	0.00	Peak
1 @	2439.010	106.73			76.12	28.40	2.22	0.00	Average

An item 1 is Fundamental Emissions.

Channel 11

	Freq	Level	Over Limit	Limit Line	ReadAntenna Level	Antenna Factor	Cable Loss	Preamp Factor	Remark
	MHz	dBuV/m	dB	dBuV/m	dBuV	dB/m	dB	dB	
1 @	2458.770	112.45			81.80	28.43	2.22	0.00	Peak
2	2483.500	60.66	-13.34	74.00	29.95	28.47	2.25	0.00	Peak
1 @	2459.530	104.11			73.46	28.43	2.22	0.00	Average
2 @	2483.500	47.83	-6.17	54.00	17.12	28.47	2.25	0.00	Average

An item 1 is Fundamental Emissions.

Note:

Emission level (dBuV/m) = 20 log Emission level (uV/m).

Corrected Reading: Antenna Factor + Cable Loss + Read Level - Preamp Factor = Level.

Final Test Date	Dec. 08, 2008	Test Site No.	03CH03-HY
Temperature	23.9	Humidity	44%
Test Engineer	Eddie	Configuration	Mode 1 802.11g CH 1, 6, 11

Channel 1

	Freq	Level	Over Limit	Limit Line	ReadAntenna Level	Antenna Factor	Cable Loss	Preamp Factor	Remark
	MHz	dBuV/m	dB	dBuV/m	dBuV	dB/m	dB	dB	
1	2387.140	65.05	-8.95	74.00	34.57	28.29	2.19	0.00	Peak
2 @	2413.740	111.15			80.64	28.33	2.19	0.00	Peak
1	2359.780	47.04	-6.96	54.00	16.66	28.22	2.16	0.00	Average
2 @	2409.940	100.28			69.77	28.33	2.19	0.00	Average

An item 2 is Fundamental Emissions.

Channel 6

	Freq	Level	Over Limit	Limit Line	ReadAntenna Level	Antenna Factor	Cable Loss	Preamp Factor	Remark
	MHz	dBuV/m	dB	dBuV/m	dBuV	dB/m	dB	dB	
1 @	2438.250	113.14			82.53	28.40	2.22	0.00	Peak
1 @	2439.010	102.80			72.19	28.40	2.22	0.00	Average

An item 1 is Fundamental Emissions.

Channel 11

	Freq	Level	Over Limit	Limit Line	ReadAntenna Level	Antenna Factor	Cable Loss	Preamp Factor	Remark
	MHz	dBuV/m	dB	dBuV/m	dBuV	dB/m	dB	dB	
1 @	2458.580	112.00			81.35	28.43	2.22	0.00	Peak
2	2483.500	63.60	-10.40	74.00	32.89	28.47	2.25	0.00	Peak
1 @	2458.580	101.19			70.54	28.43	2.22	0.00	Average
2	2483.500	45.73	-8.27	54.00	15.02	28.47	2.25	0.00	Average

An item 1 is Fundamental Emissions.

Note:

Emission level (dBuV/m) = 20 log Emission level (uV/m).

Corrected Reading: Antenna Factor + Cable Loss + Read Level - Preamp Factor = Level.

Final Test Date	Mar. 16, 2009	Test Site No.	03CH02-HY
Temperature	26	Humidity	52%
Test Engineer	David	Configuration	Mode 2 802.11b CH 1, 6, 11

Channel 1

	Freq	Level	Over Limit	Limit Line	ReadAntenna Level	Antenna Factor	Cable Loss	Preamp Factor	Remark
	MHz	dBuV/m	dB	dBuV/m	dBuV	dB/m	dB	dB	
1	2389.420	64.99	-9.01	74.00	30.20	31.79	3.00	0.00	Peak
2 @	2412.980	115.63			80.75	31.86	3.02	0.00	Peak
1 @	2390.000	52.02	-1.98	54.00	17.23	31.79	3.00	0.00	Average
2 @	2409.370	107.34			72.46	31.86	3.02	0.00	Average

An item 2 is Fundamental Emissions

Channel 6

	Freq	Level	Over Limit	Limit Line	ReadAntenna Level	Antenna Factor	Cable Loss	Preamp Factor	Remark
	MHz	dBuV/m	dB	dBuV/m	dBuV	dB/m	dB	dB	
1 @	2438.060	116.33			81.30	31.99	3.04	0.00	Peak
1 @	2436.540	107.72			72.69	31.99	3.04	0.00	Average

An item 1 is Fundamental Emissions

Channel 11

	Freq	Level	Over Limit	Limit Line	ReadAntenna Level	Antenna Factor	Cable Loss	Preamp Factor	Remark
	MHz	dBuV/m	dB	dBuV/m	dBuV	dB/m	dB	dB	
1 @	2461.050	115.55			80.45	32.06	3.04	0.00	Peak
2	2483.500	64.02	-9.98	74.00	28.83	32.13	3.06	0.00	Peak
1 @	2459.530	107.71			72.61	32.06	3.04	0.00	Average
2 @	2483.500	52.66	-1.34	54.00	17.47	32.13	3.06	0.00	Average

An item 1 is Fundamental Emissions

Note:

Emission level (dBuV/m) = 20 log Emission level (uV/m).

Corrected Reading: Antenna Factor + Cable Loss + Read Level - Preamp Factor = Level.

Final Test Date	Mar. 16, 2009	Test Site No.	03CH02-HY
Temperature	26	Humidity	52%
Test Engineer	David	Configuration	Mode 2 802.11g CH 1, 6, 11

Channel 1

	Freq	Level	Over Limit	Limit Line	ReadAntenna Level	Antenna Factor	Cable Loss	Preamp Factor	Remark
	MHz	dBuV/m	dB	dBuV/m	dBuV	dB/m	dB	dB	
1	2390.000	68.53	-5.47	74.00	33.74	31.79	3.00	0.00	Peak
2 @	2408.420	114.25			79.37	31.86	3.02	0.00	Peak
1 @	2390.000	52.36	-1.64	54.00	17.57	31.79	3.00	0.00	Average
2 @	2407.660	103.65			68.77	31.86	3.02	0.00	Average

An item 2 is Fundamental Emissions

Channel 6

	Freq	Level	Over Limit	Limit Line	ReadAntenna Level	Antenna Factor	Cable Loss	Preamp Factor	Remark
	MHz	dBuV/m	dB	dBuV/m	dBuV	dB/m	dB	dB	
1 @	2435.210	114.15			79.21	31.92	3.02	0.00	Peak
1 @	2435.020	103.52			68.58	31.92	3.02	0.00	Average

An item 1 is Fundamental Emissions

Channel 11

	Freq	Level	Over Limit	Limit Line	ReadAntenna Level	Antenna Factor	Cable Loss	Preamp Factor	Remark
	MHz	dBuV/m	dB	dBuV/m	dBuV	dB/m	dB	dB	
1 @	2460.290	113.33			78.23	32.06	3.04	0.00	Peak
2	2483.500	68.86	-5.14	74.00	33.67	32.13	3.06	0.00	Peak
1 @	2459.530	103.00			67.90	32.06	3.04	0.00	Average
2 @	2483.500	53.00	-1.00	54.00	17.81	32.13	3.06	0.00	Average

An item 1 is Fundamental Emissions

Note:

Emission level (dBuV/m) = 20 log Emission level (uV/m).

Corrected Reading: Antenna Factor + Cable Loss + Read Level - Preamp Factor = Level.

For Emission not in Restricted Band

Final Test Date	Dec. 04, 2008	Test Site No.	TH01-HY
Temperature	28	Humidity	58%
Test Engineer	Tom	Configuration	Mode 1

Low Band Edge Plot on Configuration IEEE 802.11b / 2412 MHz

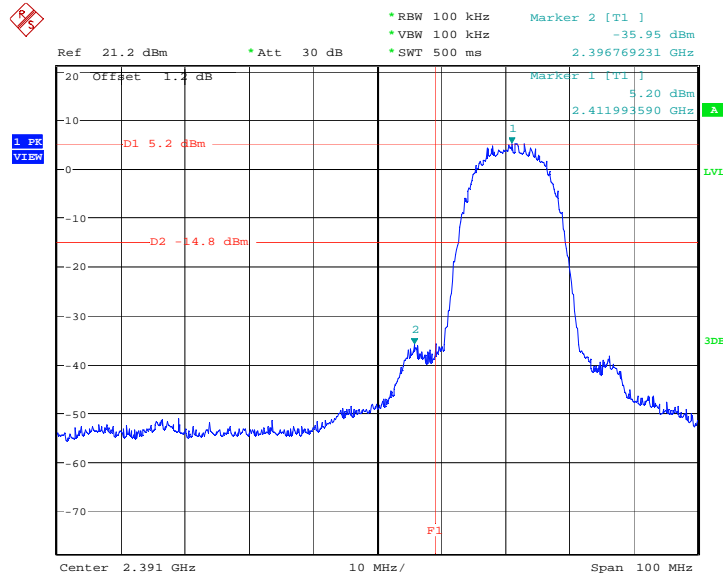

Date: 4.DEC.2008 05:55:06

High Band Edge Plot on Configuration IEEE 802.11b / 2462 MHz

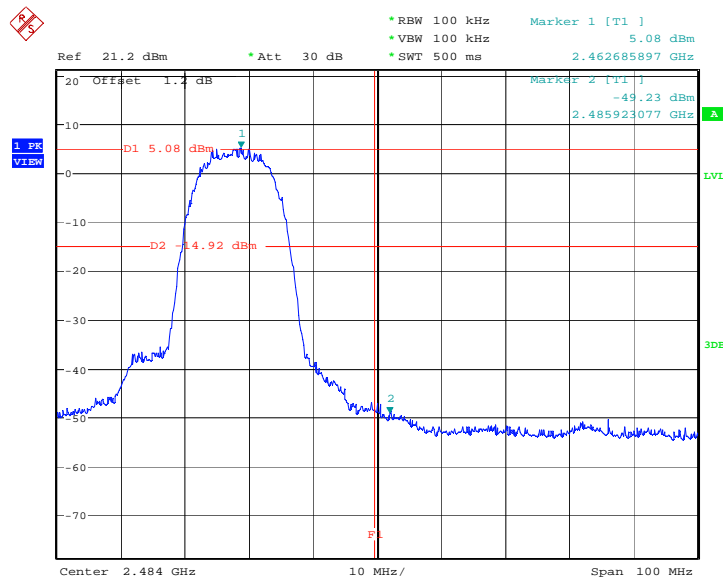

Date: 4.DEC.2008 06:10:56

Low Band Edge Plot on Configuration IEEE 802.11g / 2412 MHz

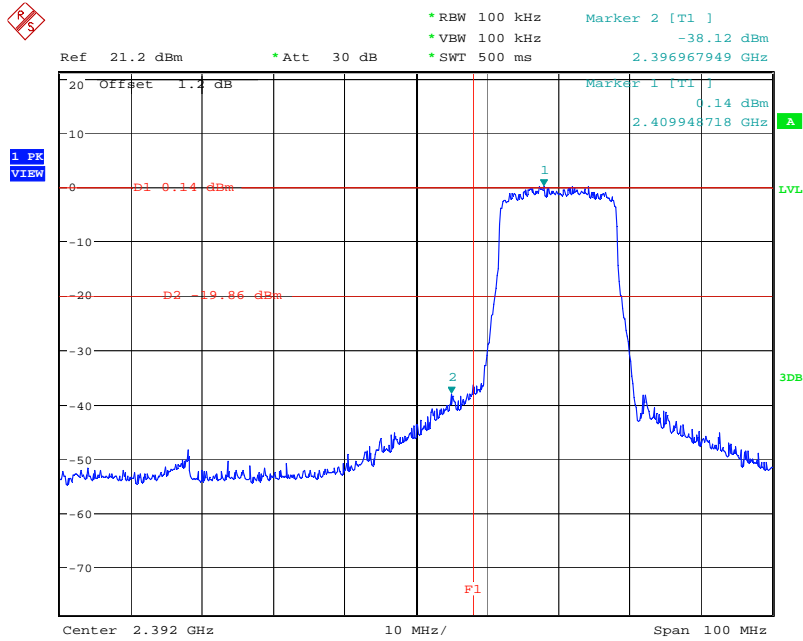

Date: 4.DEC.2008 06:30:32

High Band Edge Plot on Configuration IEEE 802.11g / 2462 MHz

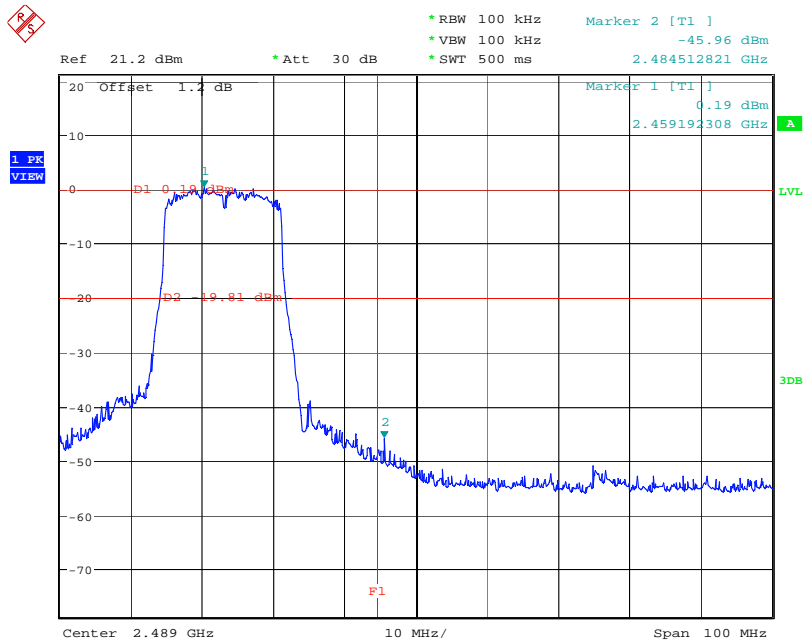

Date: 4.DEC.2008 06:42:21

Low Band Edge Plot on Configuration IEEE 802.11g / 2412 MHz

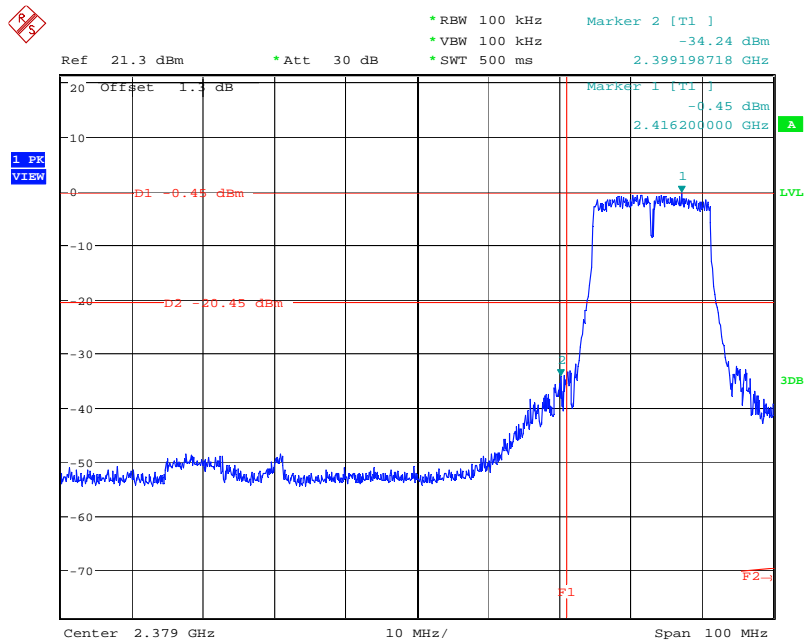

Date: 13.APR.2009 19:06:09

High Band Edge Plot on Configuration IEEE 802.11g / 2462 MHz

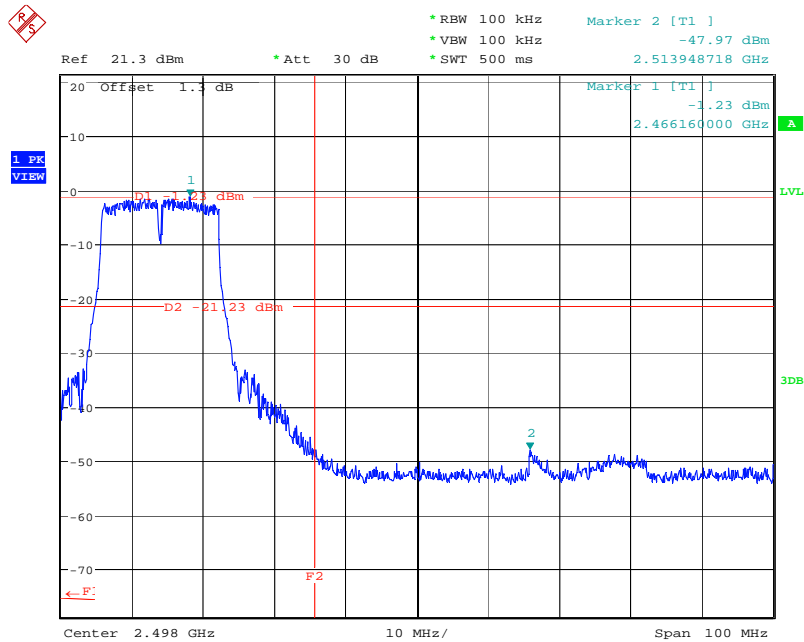

Date: 13.APR.2009 19:07:43

3.7 Antenna Requirements

3.7.1 Limit

Except for special regulations, the Low-power Radio-frequency Devices must not be equipped with any jacket for installing an antenna with extension cable. An intentional radiator shall be designed to ensure that no antenna other than that furnished by the responsible party shall be used with the device. The use of a permanently attached antenna or of an antenna that uses a unique coupling to the intentional radiator shall be considered sufficient to comply with the provisions of this Section. The manufacturer may design the unit so that the user can replace a broken antenna, but the use of a standard antenna jack or electrical connector is prohibited.

3.7.2 Antenna Connector Construction

Please refer to section 2.3 in this test report; antenna connector complied with the requirements.

4 LIST OF MEASURING EQUIPMENTS

Instrument	Manufacturer	Model No.	Serial No.	Characteristics	Calibration Date	Remark
EMC Receiver	R&S	ESCS 30	100174	9kHz – 2.75GHz	Apr. 15, 2009	Conduction (CO04-HY)
LISN	MessTec	NNB-2/16Z	99079	9kHz – 30MHz	Mar. 23, 2009	Conduction (CO04-HY)
LISN (Support Unit)	EMCO	3810/2NM	9703-1839	9kHz – 30MHz	Mar. 22, 2009	Conduction (CO04-HY)
RF Cable-CON	UTIFLEX	3102-26886-4	CB049	9kHz – 30MHz	Apr. 20, 2009	Conduction (CO04-HY)

Note: Calibration Interval of instruments listed above is one year.

Instrument	Manufacturer	Model No.	Serial No.	Characteristics	Calibration Date	Remark
Spectrum Analyzer	R&S	FSP40	100305/040	9 kHz - 40GHz	Feb. 04, 2009	Radiation (03CH02-HY)
3m Semi Anechoic Chamber	SIDT FRANKONIA	SAC-3M	03CH02-HY	30 MHz - 1 GHz 3m	May 11, 2009	Radiation (03CH02-HY)
Amplifier	Agilent	8447D	2944A11146	100 kHz – 1.3 GHz	Jul. 07, 2009	Radiation (03CH02-HY)
RF Cable-R03m	Jye Bao	RG142	CB020	30 MHz - 1 GHz	Dec. 16, 2009	Radiation (03CH02-HY)
Bilog Antenna	SCHAFFNER	CBL61128	2723	30 MHz - 2 GHz	Nov. 30, 2009	Radiation (03CH02-HY)
Turn Table	HD	DS 420	420/649/00	0 - 360 degree	N/A	Radiation (03CH02-HY)
Antenna Mast	HD	MA 240	240/559/00	1 m - 4 m	N/A	Radiation (03CH02-HY)

Note: Calibration Interval of instruments listed above is one year.

Instrument	Manufacturer	Model No.	Serial No.	Characteristics	Calibration Date	Remark
Loop Antenna	R&S	HFH2-Z2	860004/001	9 kHz - 30 MHz	Jul. 28, 2008*	Radiation (03CH02-HY)

Note: Calibration Interval of instruments listed above is two year.

Instrument	Manufacturer	Model No.	Serial No.	Characteristics	Calibration Date	Remark
Spectrum Analyzer	R&S	FSP30	100023	9kHz ~ 30GHz	Jan. 10, 2008	Conducted (TH01-HY)
Spectrum Analyzer	R&S	FSU26.5	100015	20Hz ~ 26.5GHz	Oct. 29, 2008	Conducted (TH01-HY)
Power Meter	R&S	NRVS	100444	DC ~ 40GHz	Jul. 11, 2008	Conducted (TH01-HY)
Power Sensor	R&S	NRV-Z51	100458	DC ~ 30GHz	Jul. 11, 2008	Conducted (TH01-HY)
Power Sensor	R&S	NRV-Z32	100057	30MHz ~ 6GHz	Jul. 11, 2008	Conducted (TH01-HY)
DC Power Source	G.W.	GPC-6030D	C671845	DC 1V ~ 60V	Mar. 13, 2008	Conducted (TH01-HY)
Temp. and Humidity Chamber	Giant Force	GTH-225-20-S	MAB0103-001	N/A	Jul. 18, 2008	Conducted (TH01-HY)
RF CABLE-1m	Jye Bao	RG142	CB034-1m	20MHz ~ 7GHz	Dec. 01, 2008	Conducted (TH01-HY)
RF CABLE-2m	Jye Bao	RG142	CB035-2m	20MHz ~ 1GHz	Dec. 01, 2008	Conducted (TH01-HY)

Note: Calibration Interval of instruments listed above is one year.

Instrument	Manufacturer	Model No.	Serial No.	Characteristics	Calibration Date	Remark
AC Power Source	HPC	HPA-500W	HPA-9100024	AC 0 ~ 300V	May 30, 2008*	Conducted (TH01-HY)

Note: Calibration Interval of instruments listed above is two year.

Mode 1

Instrument	Manufacturer	Model No.	Serial No.	Characteristics	Calibration Date	Remark
3m Semi Anechoic Chamber	SIDT FRANKONIA	SAC-3M	03CH03-HY	30 MHz - 1 GHz 3m	Jun. 14, 2008	Radiation (03CH03-HY)
Amplifier	Agilent	8449B	3008A02120	1 GHz - 26.5 GHz	Jul. 21, 2008	Radiation (03CH03-HY)
Spectrum Analyzer	R&S	FSP30	100023	9 kHz - 30 GHz	Oct. 08, 2008	Radiation (03CH03-HY)
Horn Antenna	EMCO	3115	6741	1GHz ~ 18GHz	Apr. 04, 2008	Radiation (03CH03-HY)
Horn Antenna	SCHWARZBECK	BBHA9170	BBHA9170154	15 GHz - 40 GHz	Jan.18, 2008	Radiation (03CH03-HY)
RF Cable-HIGH	SUHNER	SUCOFLEX 106	03CH03-HY	1 GHz - 40 GHz	Dec. 01, 2008	Radiation (03CH03-HY)
Turn Table	HD	DS 420	420/650/00	0 – 360 degree	N/A	Radiation (03CH03-HY)
Antenna Mast	HD	MA 240	240/560/00	1 m - 4 m	N/A	Radiation (03CH03-HY)

Note: Calibration Interval of instruments listed above is one year.

Instrument	Manufacturer	Model No.	Serial No.	Characteristics	Calibration Date	Remark
Amplifier	MITEQ	AMF-6F-260400	9121372	26.5 GHz - 40 GHz	Jan. 22, 2007*	Radiation (03CH03-HY)

Note: Calibration Interval of instruments listed above is two year.

Mode 2

Instrument	Manufacturer	Model No.	Serial No.	Characteristics	Calibration Date	Remark
3m Semi Anechoic Chamber	SIDT FRANKONIA	SAC-3M	03CH02-HY	30 MHz - 1 GHz 3m	May 12, 2008	Radiation (03CH02-HY)
Spectrum Analyzer	R&S	FSP40	100305/040	9 kHz - 40GHz	Feb. 04, 2009	Radiation (03CH02-HY)
Turn Table	HD	DS 420	420/649/00	0 - 360 degree	N/A	Radiation (03CH02-HY)
Antenna Mast	HD	MA 240	240/559/00	1 m - 4 m	N/A	Radiation (03CH02-HY)
Amplifier	Agilent	8449B	3008A02373	1GHz – 26.5 GHz	Jul. 16, 2008	Radiation (03CH02-HY)
Horn Antenna	ETS-LINDGREN	3117	00091920	1GHz~18GHz	Oct. 22, 2008	Radiation (03CH02-HY)
RF Cable-HIGH	SUHNER	SUCOFLEX106	03CH02-HY	1GHz~40GHz	Dec. 17, 2008	Radiation (03CH02-HY)

Note: Calibration Interval of instruments listed above is one year.

5 TEST LOCATION

SHIJR	ADD : 6Fl., No. 106, Sec. 1, Shintai 5th Rd., Shijr City, Taipei, Taiwan 221, R.O.C. TEL : 886-2-2696-2468 FAX : 886-2-2696-2255
HWA YA	ADD : No. 52, Hwa Ya 1st Rd., Kwei-Shan Hsiang, Tao Yuan Hsien, Taiwan, R.O.C. TEL : 886-3-327-3456 FAX : 886-3-318-0055
LINKOU	ADD : No. 30-2, Dingfu Tsuen, Linkou Shiang, Taipei, Taiwan 244, R.O.C TEL : 886-2-2601-1640 FAX : 886-2-2601-1695
DUNGHU	ADD : No. 3, Lane 238, Kangle St., Neihu Chiu, Taipei, Taiwan 114, R.O.C. TEL : 886-2-2631-4739 FAX : 886-2-2631-9740
JUNGHE	ADD : 7Fl., No. 758, Jungjeng Rd., Junghe City, Taipei, Taiwan 235, R.O.C. TEL : 886-2-8227-2020 FAX : 886-2-8227-2626
NEIHU	ADD : 4Fl., No. 339, Hsin Hu 2 nd Rd., Taipei 114, Taiwan, R.O.C. TEL : 886-2-2794-8886 FAX : 886-2-2794-9777
JHUBEI	ADD : No.8, Lane 724, Bo-ai St., Jhubei City, HsinChu County 302, Taiwan, R.O.C. TEL : 886-3-656-9065 FAX : 886-3-656-9085

6 TAF CERTIFICATE OF ACCREDITATION



Certificate No. : L1190-090318

財團法人全國認證基金會
Taiwan Accreditation Foundation

Certificate of Accreditation

This is to certify that

Sporton International Inc.

EMC & Wireless Communications Laboratory

No.52, Hwa Ya 1st Rd., Hwa Ya Technology Park, Kwei-Shan Hsiang, Tao Yuan Hsien,
Taiwan, R.O.C.

is accredited in respect of laboratory

- Accreditation Criteria : ISO/IEC 17025:2005
- Accreditation Number : 1190
- Originally Accredited : December 15, 2003
- Effective Period : January 10, 2007 to January 09, 2010
- Accredited Scope : Testing Field, see described in the Appendix
- Specific Accreditation Program : Accreditation Program for Designated Testing Laboratory for Commodities Inspection
Accreditation Program for Telecommunication Equipment Testing Laboratory
Accreditation Program for BSMI Mutual Recognition Arrangement with Foreign Authorities

Jay-San Chen
President, Taiwan Accreditation Foundation
Date : March 18, 2009

P1, total 19 pages

The Appendix forms an integral part of this Certificate, which shall be invalid when use without the Appendix