

**FCC 47 CFR PART 15 SUBPART C &  
INDUSTRY CANADA RSS-247**

**TEST REPORT**

**For**

**Konftel Ego**

**Model: 910101081**

**Trade Name: Konftel**

*Issued to*

**Konftel AB**

**PO Box 268 901 06 Umea SWEDEN**

*Issued by*

**Compliance Certification Services Inc.**

**No.11, Wugong 6th Rd., Wugu Dist.,  
New Taipei City 24891, Taiwan. (R.O.C.)**

**<http://www.ccsrf.com>**

**[service@ccsrf.com](mailto:service@ccsrf.com)**

**Issued Date: March 28, 2016**



---

**Note:** This report shall not be reproduced except in full, without the written approval of Compliance Certification Services Inc. This document may be altered or revised by Compliance Certification Services Inc. personnel only, and shall be noted in the revision section of the document.

**Revision History**

Rev.	Issue Date	Revisions	Effect Page	Revised By
00	March 28, 2016	Initial Issue	ALL	Kelly Cheng
01	April 27, 2016	Modify test procedure	P.17	Kelly Cheng

## TABLE OF CONTENTS

<b>1. TEST RESULT CERTIFICATION.....</b>	<b>4</b>
<b>2. EUT DESCRIPTION.....</b>	<b>5</b>
<b>3. TEST METHODOLOGY.....</b>	<b>6</b>
3.1 EUT CONFIGURATION .....	6
3.2 EUT EXERCISE .....	6
3.3 GENERAL TEST PROCEDURES .....	6
3.4 FCC PART 15.205 RESTRICTED BANDS OF OPERATIONS.....	7
3.5 DESCRIPTION OF TEST MODES .....	8
<b>4 INSTRUMENT CALIBRATION.....</b>	<b>9</b>
4.1 MEASURING INSTRUMENT CALIBRATION .....	9
4.2 MEASUREMENT EQUIPMENT USED .....	9
4.3 MEASUREMENT UNCERTAINTY .....	10
<b>5 FACILITIES AND ACCREDITATIONS.....</b>	<b>11</b>
5.1 FACILITIES.....	11
5.2 EQUIPMENT .....	11
5.3 TABLE OF ACCREDITATIONS AND LISTINGS.....	12
<b>6 SETUP OF EQUIPMENT UNDER TEST.....</b>	<b>13</b>
6.1 SETUP CONFIGURATION OF EUT .....	13
6.2 SUPPORT EQUIPMENT .....	13
<b>7 FCC PART 15.247 REQUIREMENTS &amp; RSS-247 REQUIREMENTS.....</b>	<b>14</b>
7.1 99% BANDWIDTH.....	14
7.2 6DB BANDWIDTH.....	17
7.3 PEAK POWER .....	20
7.4 AVERAGE POWER.....	21
7.5 BAND EDGES MEASUREMENT.....	22
7.6 PEAK POWER SPECTRAL DENSITY.....	32
7.7 RADIATED EMISSIONS.....	35
7.8 POWERLINE CONDUCTED EMISSIONS.....	47
<b>APPENDIX I PHOTOGRAPHS OF TEST SETUP .....</b>	<b>50</b>

# 1. TEST RESULT CERTIFICATION

**Applicant:** Konftel AB  
 PO Box 268 901 06 Umea SWEDEN

**Manufacturer:** Lite-On Network Communication (Dongguan) Limited  
 30#Keji Rd., Yin Hu Industrial Area, Qingxi Town, DongGuan  
 City, Guangdong, China

**Equipment Under Test:** Konftel Ego

**Model Number:** 910101081

**Trade Name:** Konftel

**Date of Test:** March 3 ~ 18, 2016

APPLICABLE STANDARDS	
STANDARD	TEST RESULT
FCC 47 CFR Part 15 Subpart C Industry Canada RSS-247 Issue 1	No non-compliance noted
Deviation from Applicable Standard	
N/A	

**We hereby certify that:**

The above equipment was tested by Compliance Certification Services Inc. The test data, data evaluation, test procedures, and equipment configurations shown in this report were made in accordance with the procedures given in ANSI C63.10: 2013 and the energy emitted by the sample EUT tested as described in this report is in compliance with the requirements set forth in the above standards.

The test results of this report relate only to the tested sample EUT identified in this report.

*Approved by:*

*Reviewed by:*





---

Miller Lee  
 Manager  
 Compliance Certification Services Inc.

---

Angel Cheng  
 Section Manager  
 Compliance Certification Services Inc.

## 2. EUT DESCRIPTION

<b>Product</b>	Konftel Ego
<b>Model Number</b>	910101081
<b>Trade Name</b>	Konftel
<b>Model Discrepancy</b>	N/A
<b>Received Date</b>	March 4, 2016
<b>Power Rating</b>	1. Powered from Li-ion BATTERY : Rating: 3.7V, 1000mAh, 37Wh 2. Powered from host device via USB Cable
<b>Frequency Range</b>	2402MHz ~ 2480MHz
<b>Transmit Power</b>	1.89 dBm
<b>Modulation Technique</b>	BT 4.0 LE mode, GFSK (1Mbps)
<b>Number of Channels</b>	40 Channels
<b>Antenna Specification</b>	Walsin / RFPCA191506IMAB301 PCB Antenna / 1.97 dBi

**Remark:**

1. The sample selected for test was engineering sample that approximated to production product and was provided by manufacturer.
2. This submittal(s) (test report) is intended for FCC&IC ID: **SNNKTEGO** & **2408A-KTEGO** filing to comply with FCC Part 15C, Section 15.207, 15.209 and IC RSS-247 & RSS-GEN.

### **3. TEST METHODOLOGY**

The tests documented in this report were performed in accordance with ANSI C63.10: 2013 and FCC CFR 47 Part 15.207, 15.209, 15.247, KDB 558074 D01 DTS Meas Guidance v03r03.

The tests documented in this report were performed in accordance with IC RSS-247, IC RSS-Gen and ANSI C63.10:2013.

This submittal(s) (test report) is intended for IC Certification with Industry Canada RSS-247.

#### **3.1 EUT CONFIGURATION**

The EUT configuration for testing is installed on RF field strength measurement to meet the Commissions requirement and operating in a manner that intends to maximize its emission characteristics in a continuous normal application.

#### **3.2 EUT EXERCISE**

The EUT was operated in the engineering mode to fix the TX frequency that was for the purpose of the measurements.

According to its specifications, the EUT must comply with the requirements of the Section 15.207, 15.209 and 15.247 under the FCC Rules Part 15 Subpart C and RSS-247 Annex 1.

#### **3.3 GENERAL TEST PROCEDURES**

##### **Conducted Emissions**

According to the requirements in ANSI C63.10: 2013 Conducted emissions from the EUT measured in the frequency range between 0.15 MHz and 30MHz using CISPR Quasi-peak and average detector modes.

##### **Radiated Emissions**

The EUT is placed on a turn table, which is 1.5 m above ground plane. The turntable shall rotate 360 degrees to determine the position of maximum emission level. EUT is set 3m away from the receiving antenna, which varied from 1m to 4m to find out the highest emission. And also, each emission was to be maximized by changing the polarization of receiving antenna both horizontal and vertical. In order to find out the maximum emissions, exploratory radiated emission measurements were made according to the requirements in ANSI C63.10: 2013.

### 3.4 FCC PART 15.205 RESTRICTED BANDS OF OPERATIONS

(a) Except as shown in paragraph (d) of this section, only spurious emissions are permitted in any of the frequency bands listed below:

MHz	MHz	MHz	GHz
0.090 - 0.110	16.42 - 16.423	399.9 - 410	4.5 - 5.15
<sup>1</sup> 0.495 - 0.505	16.69475 - 16.69525	608 - 614	5.35 - 5.46
2.1735 - 2.1905	16.80425 - 16.80475	960 - 1240	7.25 - 7.75
4.125 - 4.128	25.5 - 25.67	1300 - 1427	8.025 - 8.5
4.17725 - 4.17775	37.5 - 38.25	1435 - 1626.5	9.0 - 9.2
4.20725 - 4.20775	73 - 74.6	1645.5 - 1646.5	9.3 - 9.5
6.215 - 6.218	74.8 - 75.2	1660 - 1710	10.6 - 12.7
6.26775 - 6.26825	108 - 121.94	1718.8 - 1722.2	13.25 - 13.4
6.31175 - 6.31225	123 - 138	2200 - 2300	14.47 - 14.5
8.291 - 8.294	149.9 - 150.05	2310 - 2390	15.35 - 16.2
8.362 - 8.366	156.52475 -	2483.5 - 2500	17.7 - 21.4
8.37625 - 8.38675	156.52525	2655 - 2900	22.01 - 23.12
8.41425 - 8.41475	156.7 - 156.9	3260 - 3267	23.6 - 24.0
12.29 - 12.293	162.0125 - 167.17	3332 - 3339	31.2 - 31.8
12.51975 - 12.52025	167.72 - 173.2	3345.8 - 3358	36.43 - 36.5
12.57675 - 12.57725	240 - 285	3600 - 4400	( <sup>2</sup> )
13.36 - 13.41	322 - 335.4		

<sup>1</sup> Until February 1, 1999, this restricted band shall be 0.490-0.510 MHz.

<sup>2</sup> Above 38.6

(b) Except as provided in paragraphs (d) and (e), the field strength of emissions appearing within these frequency bands shall not exceed the limits shown in Section 15.209. At frequencies equal to or less than 1000 MHz, compliance with the limits in Section 15.209 shall be demonstrated using measurement instrumentation employing a CISPR quasi-peak detector. Above 1000 MHz, compliance with the emission limits in Section 15.209 shall be demonstrated based on the average value of the measured emissions. The provisions in Section 15.35 apply to these measurements.

### 3.5 DESCRIPTION OF TEST MODES

The EUT (model: 910101081) had been tested under operating condition.

Software used to control the EUT for staying in continuous transmitting mode was programmed.

After verification, all tests were carried out with the worst case test modes as shown below except radiated spurious emission below 1GHz and power line conducted emissions below 30MHz, which worst case was in normal link mode only.

#### BT 4.0

Tested Channel	Frequency (MHz)
Low	2402
Mid	2440
High	2480

The field strength of spurious emission was measured in the following position: EUT stand-up position (Z axis), lie-down position (X, Y axis). The worst emission was found in lie-down position (X axis) and the worst case was recorded.



## 4 INSTRUMENT CALIBRATION

### 4.1 MEASURING INSTRUMENT CALIBRATION

The measuring equipment, which was utilized in performing the tests documented herein, has been calibrated in accordance with the manufacturer's recommendations for utilizing calibration equipment, which is traceable to recognized national standards.

### 4.2 MEASUREMENT EQUIPMENT USED

#### Equipment Used for Emissions Measurement

*Remark: Each piece of equipment is scheduled for calibration once a year and Loop Antenna is scheduled for calibration once three years.*

Conducted Emissions Test Site				
Name of Equipment	Manufacturer	Model	Serial Number	Calibration Due
Spectrum Analyzer	Agilent	E4446A	US42510252	12/07/2016
Thermostatic/Humidity Chamber	TAICHY	MHG-150LF	930619	10/07/2016
AC Power Source	EXTECH	6205	1140845	N.C.R
DC Power Supply	ABM	8301HD	D011531	N.C.R
Power Meter	Anritsu	ML2495A	1012009	07/07/2016
Power Sensor	Anritsu	MA2411A	0917072	07/07/2016
Spectrum Analyzer	ROHDE&SCHWARZ	FSV40	101073	07/19/2016

Wugu 966 Chamber A				
Name of Equipment	Manufacturer	Model	Serial Number	Calibration Due
Spectrum Analyzer	Agilent	E4446A	US42510268	02/14/2017
EMI Test Receiver	R&S	ESCI	100064	06/03/2016
Bilog Antenna	Sunol Sciences	JB3	A030105	08/05/2016
Horn Antenna	EMCO	3117	00055165	02/23/2017
Horn Antenna	EMCO	3116	26370	01/14/2017
Turn Table	CCS	CC-T-1F	N/A	N.C.R
Antenna Tower	CCS	CC-A-1F	N/A	N.C.R
Controller	CCS	CC-C-1F	N/A	N.C.R
Pre-Amplifier	MITEQ	1652-3000	1490939	08/09/2016
Pre-Amplifier	EMC	EMC 012635	980151	06/04/2016
Pre-Amplifier	MITEQ	AMF-6F-260400-40-8P	985646	01/13/2017
Coaxial Cable	Huber+Suhner	102	22470/2	01/11/2017
Coaxial Cable	Huber+Suhner	102	29406/2	01/11/2017
Test S/W	EZ-EMC (CCS-3A1RE)			

Conducted Emission Room # B				
Name of Equipment	Manufacturer	Model	Serial Number	Calibration Due
EMI Test Receiver	R&S	ESCI	101073	09/08/2016
LISN	R&S	ENV216	101054	06/06/2016
LISN	SCHWARZBECK	NSLK 8127	8127-541	11/22/2016
Capacitive Voltage Probe	FCC	F-CVP-1	100185	03/08/2017
Test S/W	CCS-3A1-CE			

### 4.3 MEASUREMENT UNCERTAINTY

PARAMETER	UNCERTAINTY
Powerline Conducted Emission	+/- 1.2575
3M Semi Anechoic Chamber / 30M~200M	+/- 4.0138
3M Semi Anechoic Chamber / 200M~1000M	+/- 3.9483
3M Semi Anechoic Chamber / 1G~8G	+/- 2.5975
3M Semi Anechoic Chamber / 8G~18G	+/- 2.6112
3M Semi Anechoic Chamber / 18G~26G	+/- 2.7389
3M Semi Anechoic Chamber / 26G~40G	+/- 2.9683

**Remark:** This uncertainty represents an expanded uncertainty expressed at approximately the 95% confidence level using a coverage factor of  $k=2$ .

## 5 FACILITIES AND ACCREDITATIONS

### 5.1 FACILITIES

All measurement facilities used to collect the measurement data are located at

No.199, Chunghsen Road, Hsintien City, Taipei Hsien, Taiwan, R.O.C.

Tel: 886-2-2217-0894 / Fax: 886-2-2217-1029

No.11, Wugong 6th Rd., Wugu Dist., New Taipei City 24891, Taiwan. (R.O.C.)

Tel: 886-2-2299-9720 / Fax: 886-2-2298-4045

No.81-1, Lane 210, Bade 2nd Rd., Lujhu Township, Taoyuan County 33841, TAIWAN, R.O.C.

Tel: 886-3-324-0332 / Fax: 886-3-324-5235

The sites are constructed in conformance with the requirements of ANSI C63.7, ANSI C63.10: 2013 and CISPR Publication 22.

### 5.2 EQUIPMENT



Radiated emissions are measured with one or more of the following types of linearly polarized antennas: tuned dipole, biconical, log periodic, bi-log, ridged waveguide, horn and/or Loop. Spectrum analyzers with pre-selectors and quasi-peak detectors are used to perform radiated measurements.

Conducted emissions are measured with Line Impedance Stabilization Networks and EMI Test Receivers.

Calibrated wideband preamplifiers, coaxial cables, and coaxial attenuators are also used for making measurements.

All receiving equipment conforms to CISPR Publication 16-1, "Radio Interference Measuring Apparatus and Measurement Methods."

### 5.3 TABLE OF ACCREDITATIONS AND LISTINGS

Country	Agency	Scope of Accreditation	Logo
USA	FCC	3M Semi Anechoic Chamber (FCC MRA: TW1039) to perform FCC Part 15 measurements	 FCC MRA: TW1039
Taiwan	TAF	LP0002, RTTE01, FCC Method-47 CFR Part 15 Subpart C, D, E, RSS-210, RSS-310 IDA TS SRD, AS/NZS 4268, AS/NZS 4771, TS 12.1 & 12.2, ETSI EN 300 440-1, ETSI EN 300 440-2, ETSI EN 300 328, ETSI EN 300 220-1, ETSI EN 300 220-2, ETSI EN 301 893, ETSI EN 301 489-1/3/7/17 FCC OET Bulletin 65 + Supplement C, EN 50360, EN 50361, EN 50371, RSS 102, EN 50383, EN 50385, EN 50392, IEC 62209, CNS 14958-1, CNS 14959 FCC Method -47 CFR Part 15 Subpart B IEC / EN 61000-3-2, IEC / EN 61000-3-3, IEC / EN 61000-4-2/3/4/5/6/8/11	 Testing Laboratory 1309
Canada	Industry Canada	3M Semi Anechoic Chamber (IC 2324G-1 / IC 2324G-2) to perform	 IC 2324G-1 IC 2324G-2

\* No part of this report may be used to claim or imply product endorsement by A2LA or any agency of the US Government.

## 6 SETUP OF EQUIPMENT UNDER TEST

### 6.1 SETUP CONFIGURATION OF EUT

See test photographs attached in Appendix I for the actual connections between EUT and support equipment.

### 6.2 SUPPORT EQUIPMENT

No	Equipment	Brand	Model	Series No.	FCC ID	Data Cable	Power Cord
1	Notebook PC	ASUS	M5200AE	5BN0AG019631	PD9WM3B2100	N/A	AC I/P: Unshielded, 1.8m with a core DC O/P: Unshielded, 1.8m

**Remark:**

1. All the equipment/cables were placed in the worst-case configuration to maximize the emission during the test.
2. Grounding was established in accordance with the manufacturer's requirements and conditions for the intended use.

## 7 FCC PART 15.247 REQUIREMENTS & RSS-247 REQUIREMENTS

### 7.1 99% BANDWIDTH

#### Test Configuration

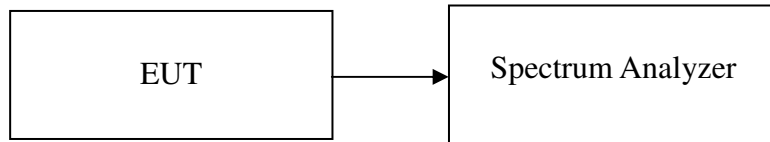

#### TEST PROCEDURE

The resolution bandwidth shall be set to as close to 1% of the selected span as is possible without being below 1%. The video bandwidth shall be set to 3 times the resolution bandwidth. Video averaging is not permitted. Where practical, a sampling detector shall be used since a peak or, peak hold.

#### TEST RESULTS

*No non-compliance noted.*

#### Test Data

##### For GFSK

Channel	Frequency (MHz)	99% Bandwidth (MHz)
Low	2402	1.2764
Mid	2440	1.2764
High	2480	1.2764

**Test Plot**

**99% Bandwidth (CH Low)**

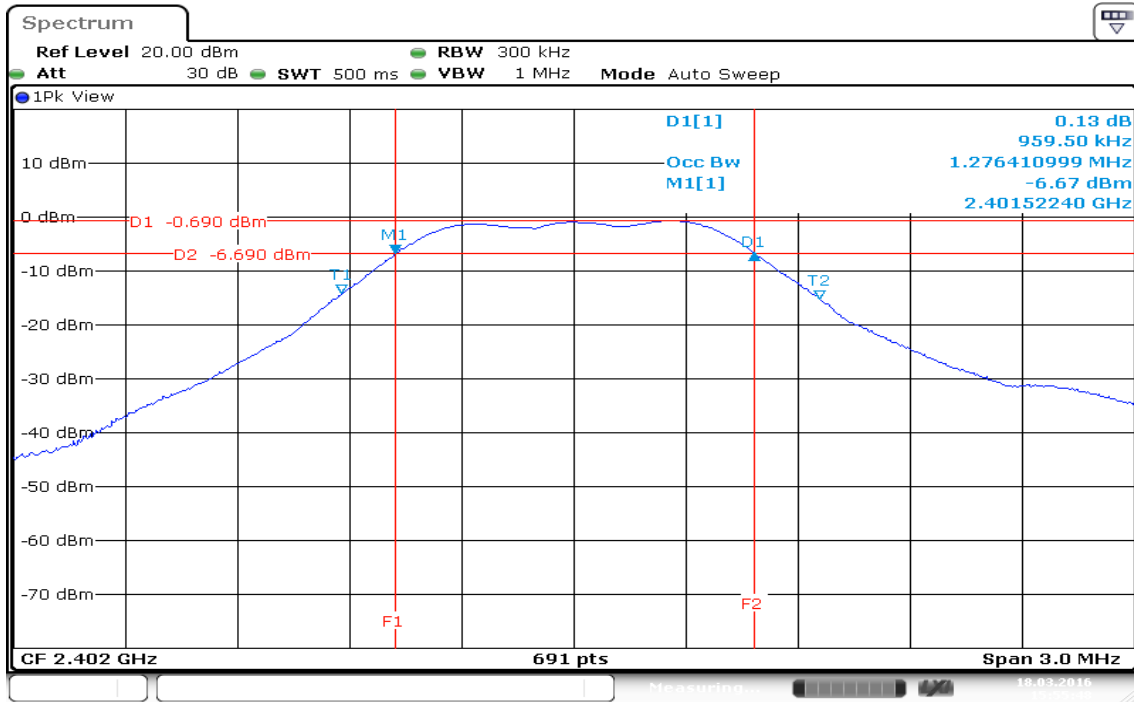

**99% Bandwidth (CH Mid)**

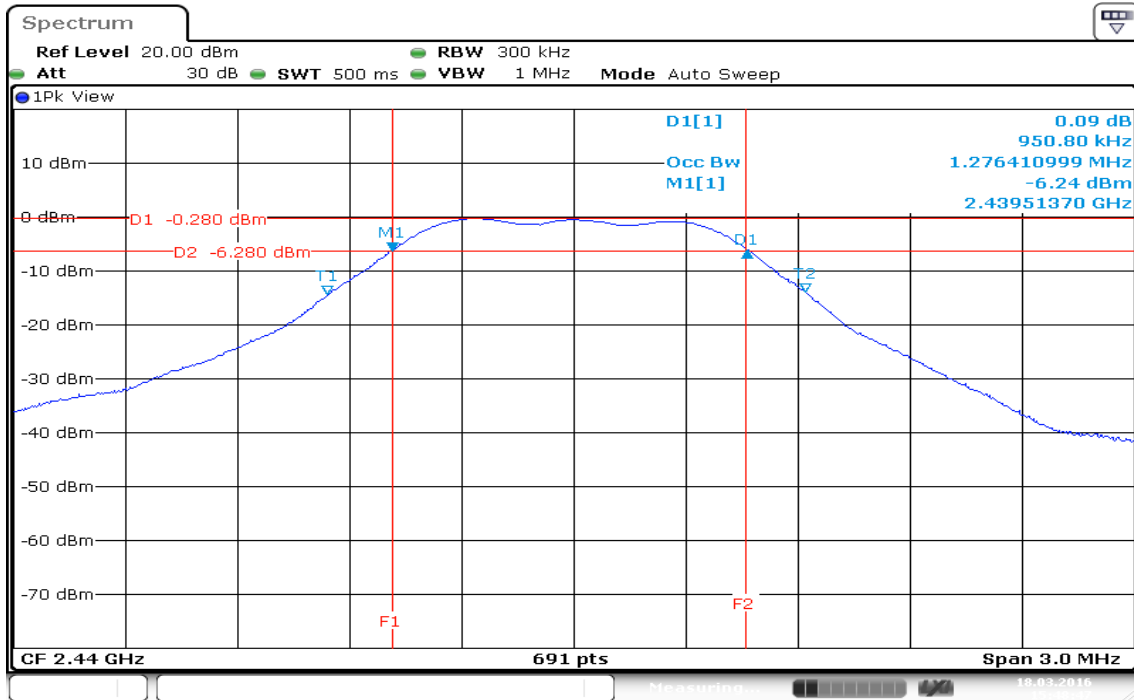

### 99% Bandwidth (CH High)

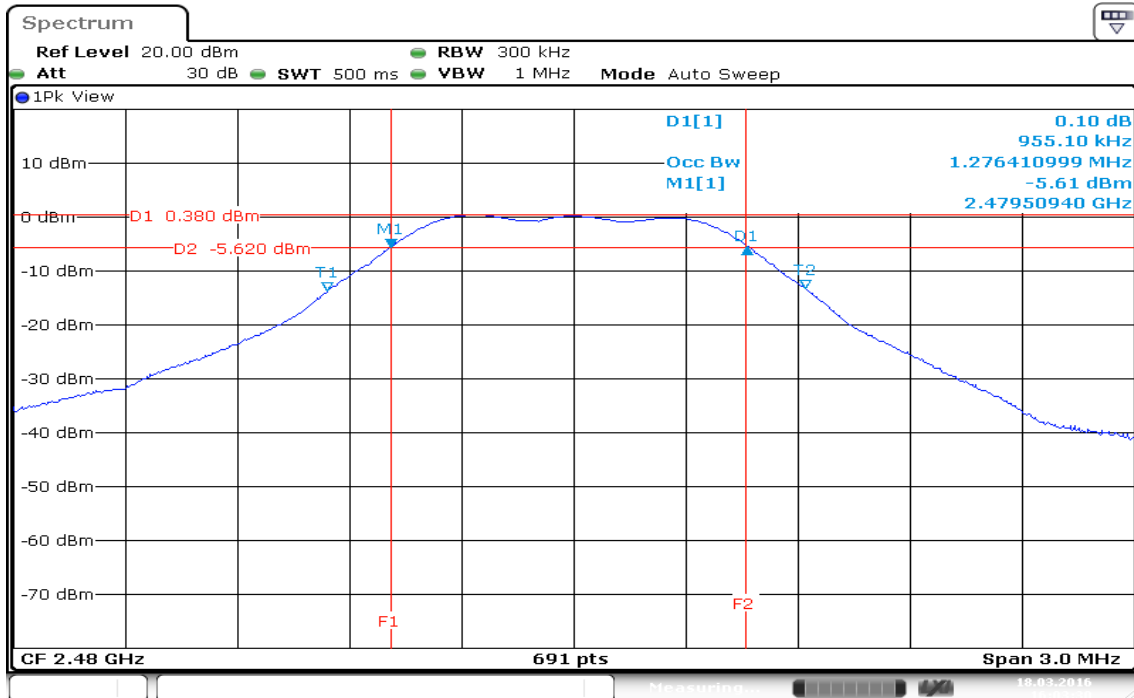

Date: 18.MAR.2016 16:03:31



## 7.2 6DB BANDWIDTH

### LIMIT

According to §15.247(a)(2) & RSS-247, systems using digital modulation techniques may operate in the 902 - 928 MHz, 2400 - 2483.5 MHz, and 5725 - 5850 MHz bands. The minimum 6dB bandwidth shall be at least 500 kHz.

### Test Configuration

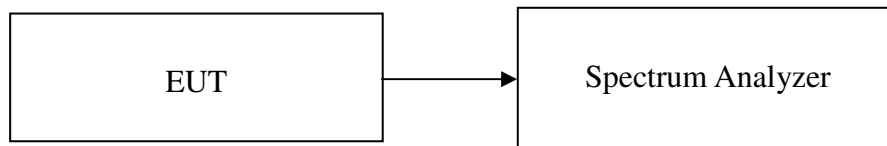

### TEST PROCEDURE

The transmitter output is connected to the spectrum analyzer. Set the RBW = 100kHz, VBW  $\geq 3 \times$  RBW, Detector = Peak, Trace mode = max hold, Sweep = auto couple. Measure the maximum width of the emission that is constrained by the frequencies associated with the two amplitude points (upper and lower) that are attenuated by 6dB relative to the maximum level measured in the fundamental emission.

### TEST RESULTS

*No non-compliance noted*

### Test Data

Channel	Frequency (MHz)	6dB Bandwidth (kHz)	Limit (kHz)	Test Result
Low	2402	959.50	>500	PASS
Mid	2440	950.80		PASS
High	2480	955.10		PASS

**Test Plot**

**6dB Bandwidth (CH Low)**

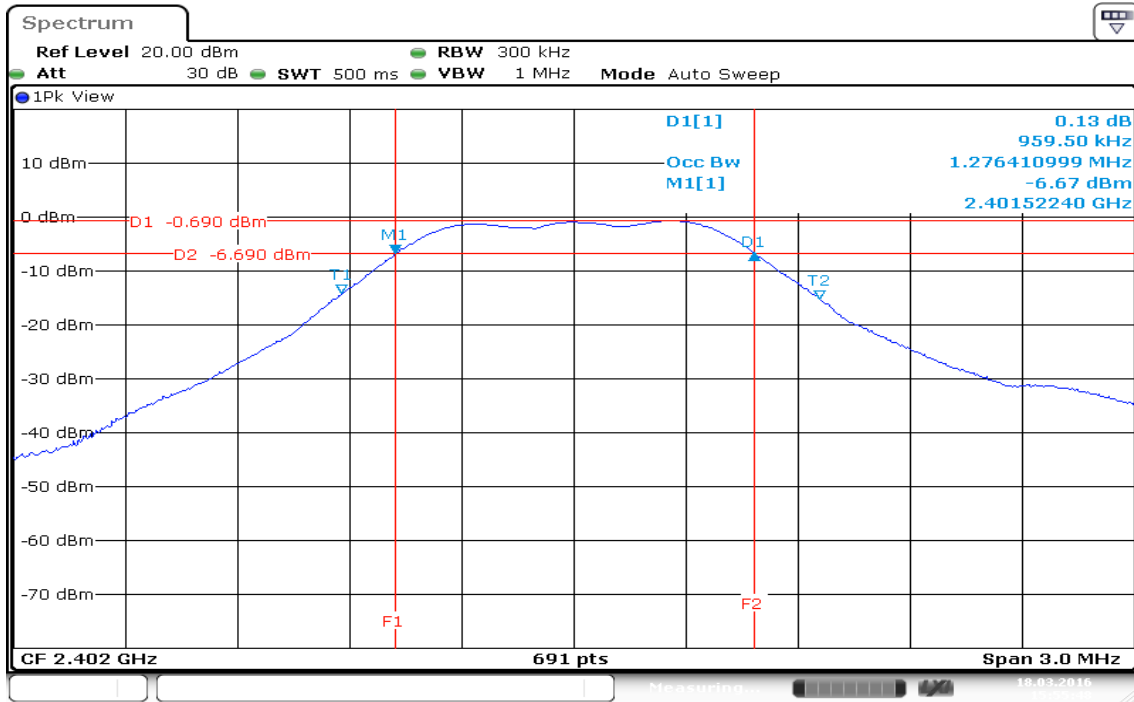

**6dB Bandwidth (CH Mid)**

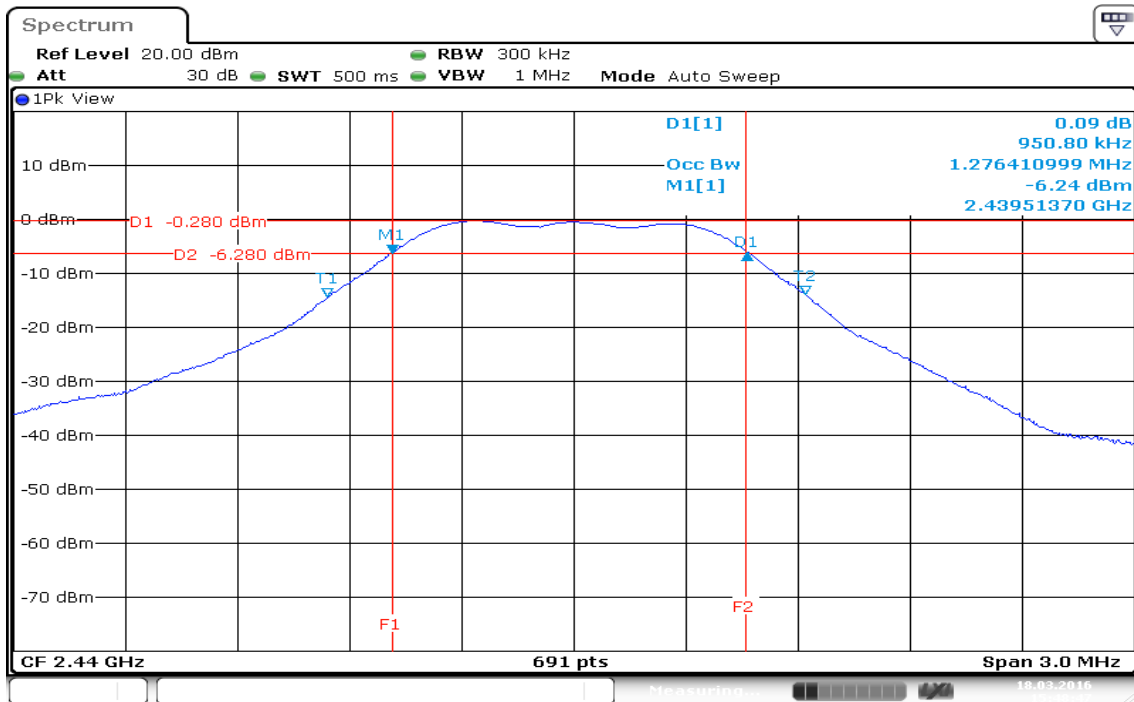

### 6dB Bandwidth (CH High)

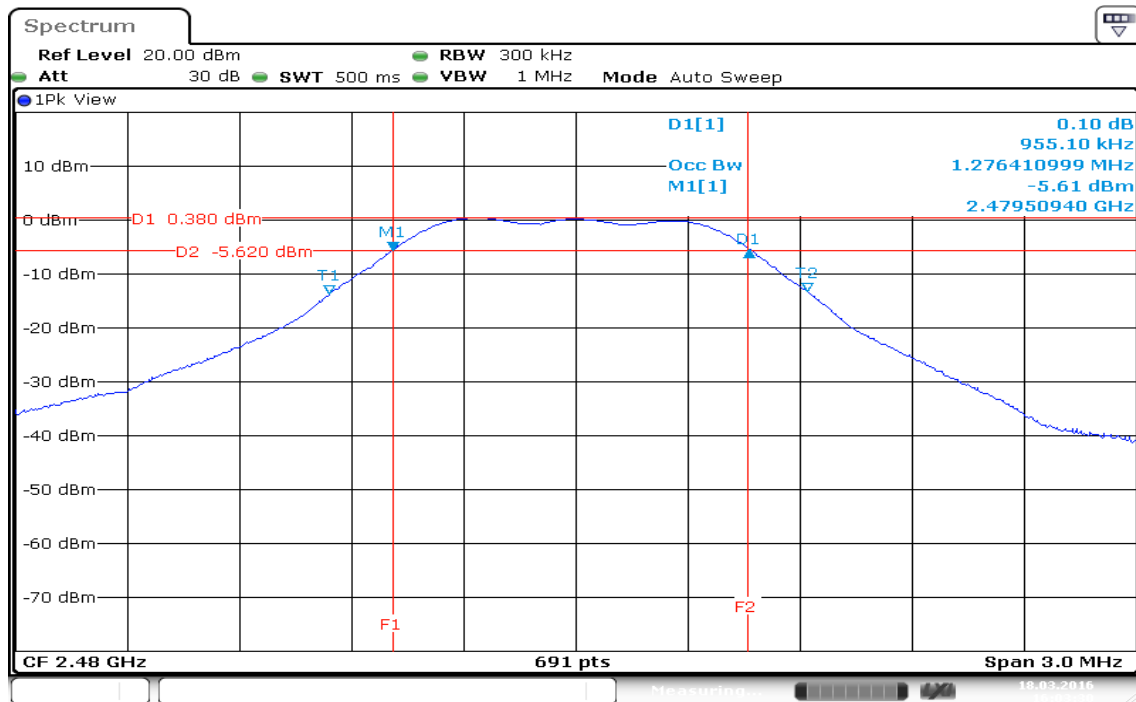

Date: 18.MAR.2016 16:03:31

### 7.3 PEAK POWER

#### LIMIT

The maximum peak output power of the intentional radiator shall not exceed the following:

1. According to §15.247(b)(3), for systems using digital modulation in the bands of 902-928 MHz, 2400-2483.5 MHz, and 5725-5850 MHz: 1 Watt.
2. According to §15.247(b)(4), the conducted output power limit specified in paragraph (b) of this section is based on the use of antennas with directional gains that do not exceed 6 dBi. Except as shown in paragraph (c) of this section, if transmitting antennas of directional gain greater than 6 dBi are used, the conducted output power from the intentional radiator shall be reduced below the stated values in paragraphs (b)(1), (b)(2), and (b)(3) of this section, as appropriate, by the amount in dB that the directional gain of the antenna exceeds 6 dBi.
3. According to RSS-247, for systems employing digital modulation techniques operating in the bands 902-928 MHz, 2400-2483.5 MHz and 5725-5850 MHz, the maximum peak conducted output power shall not exceed 1 W.

#### Test Configuration

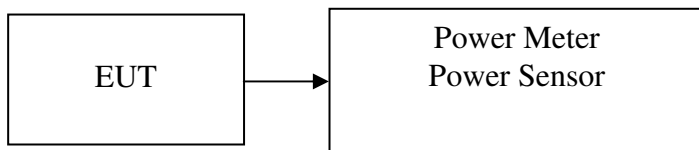

#### TEST PROCEDURE

The transmitter output is connected to the Power Meter. The Power Meter is set to the peak power detection.

#### TEST RESULTS

*No non-compliance noted*

#### Test Data

Channel	Frequency (MHz)	Output Power (dBm)	Output Power (W)	Limit (W)	Test Result
Low	2402	0.74	0.0012	1	PASS
Mid	2440	1.32	0.0014		PASS
High	2480	<b>*1.89</b>	0.0015		PASS

## 7.4 AVERAGE POWER

### LIMIT

None; for reporting purposes only.

### Test Configuration

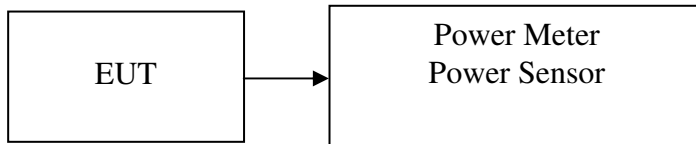

### TEST PROCEDURE

The transmitter output is connected to the Power Meter. The Power Meter is set to the average power detection.

### TEST RESULTS

*No non-compliance noted.*

### Test Data

Channel	Frequency (MHz)	Output Power (dBm)	Output Power (W)
Low	2402	-0.54	0.0009
Mid	2440	0.07	0.0010
High	2480	0.75	0.0012

## 7.5 BAND EDGES MEASUREMENT

### LIMIT

According to §15.247(d) & RSS-247, in any 100 kHz bandwidth outside the frequency bands in which the spread spectrum intentional radiator is operating, the radio frequency power that is produced by the intentional radiator shall be at least 20 dB below that in the 100 kHz bandwidth within the band that contains the highest level of the desired power, based on either an RF conducted or a radiated measurement, provided the transmitter demonstrates compliance with the peak conducted power limits. In addition, radiated emissions which fall in the restricted bands, as defined in §15.205(a), must also comply with the radiated emission limits specified in 15.209(a) (see Section 15.205(c)).

### Test Configuration

#### For Radiated

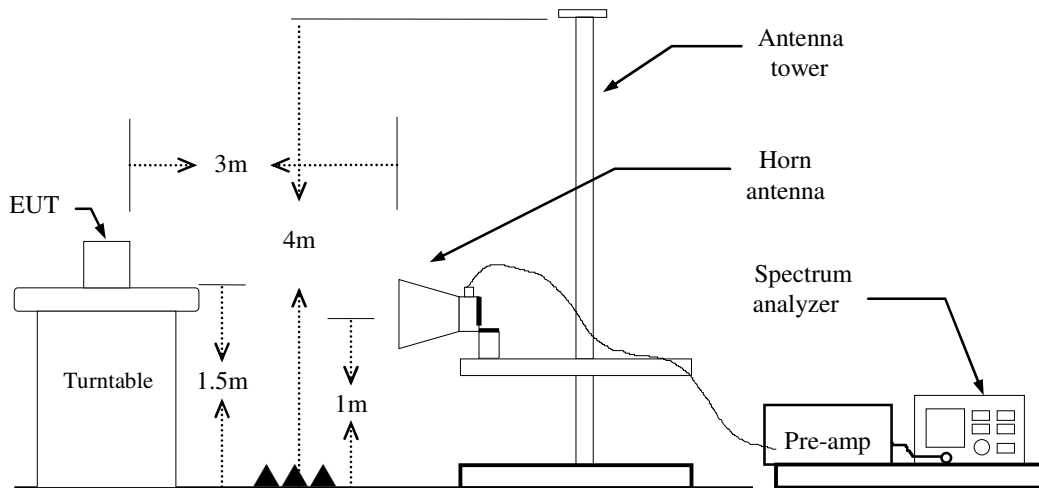

## **TEST PROCEDURE**

### **For Radiated**

1. The EUT is placed on a turntable, which is 1.5m above the ground plane.
2. The turntable shall be rotated for 360 degrees to determine the position of maximum emission level.
3. EUT is set 3m away from the receiving antenna, which is varied from 1m to 4m to find out the highest emission.
4. Set the spectrum analyzer in the following setting in order to capture the lower and upper band-edges of the emission:
  - (a) PEAK: RBW=1MHz / VBW=3MHz / Sweep=AUTO
  - (b) AVERAGE: RBW=1MHz,  
if duty cycle  $\geq$  98%, VBW=10Hz.  
if duty cycle < 98% VBW=1/T.  
**BT4.0**=72%, VBW= 2KHz
5. Repeat the procedures until all the PEAK and AVERAGE versus POLARIZATION are measured.
6. Result = Spectrum Reading + cable loss(spectrum to Amp) - Amp Gain + Cable loss(Amp to receive Ant)+ Receive Ant

### **For Un-restricted Band Emissions**

The peak output power procedure is used to measure the fundamental emission power to demonstrate compliance to requirements, then the peak conducted output power measured within any 100 kHz outside the authorized frequency band shall be attenuated by at least 20 dB relative to the maximum measured in-band peak PSD level.

## **TEST RESULTS**

Refer to attach spectrum analyzer data chart.

**Band Edges (CH Low)**

**Detector mode: Peak**

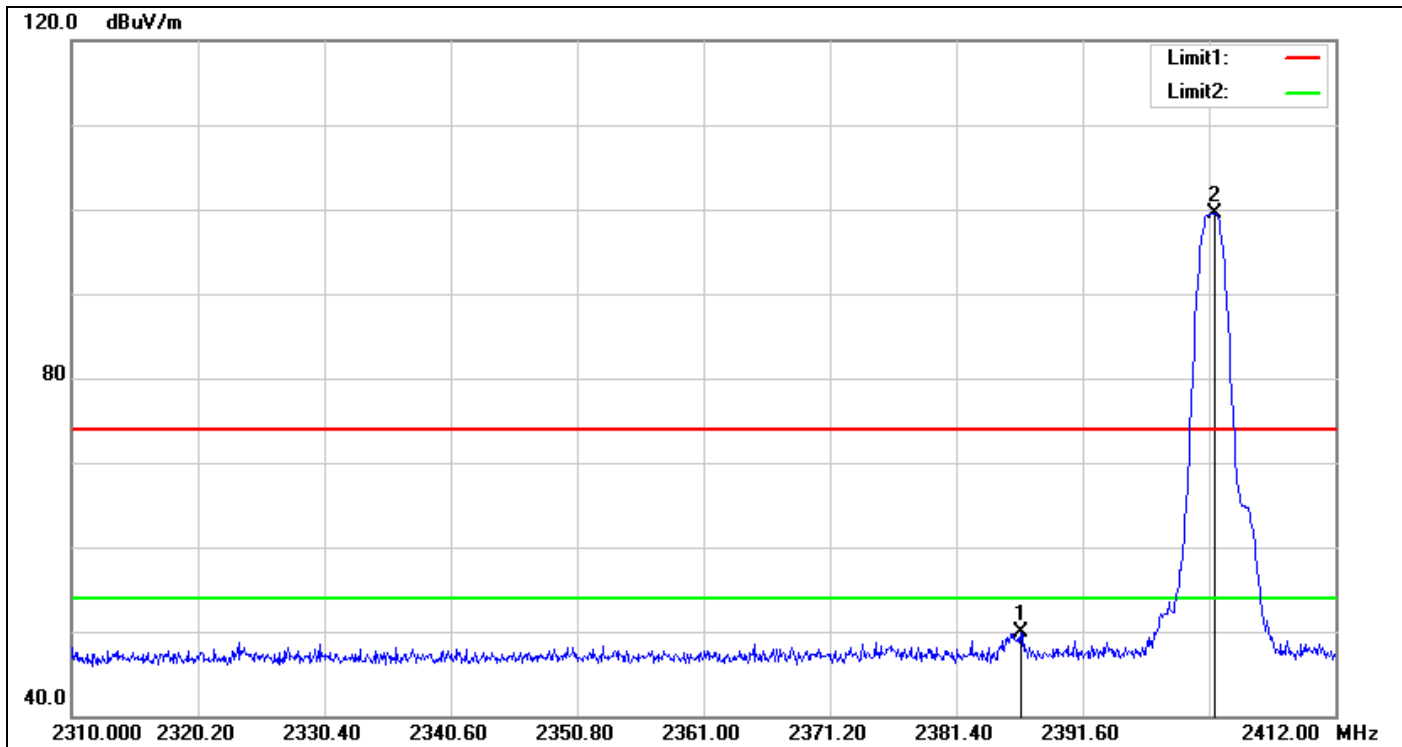

No.	Frequency (MHz)	Reading (dBuV)	Correct Factor(dB/m)	Result (dBuV/m)	Limit (dBuV/m)	Margin (dB)	Remark
1	2386.602	52.34	-2.52	49.82	74.00	-24.18	peak
2	2402.310	101.97	-2.41	99.56	74.00	25.56	peak



**Detector mode: AVG**

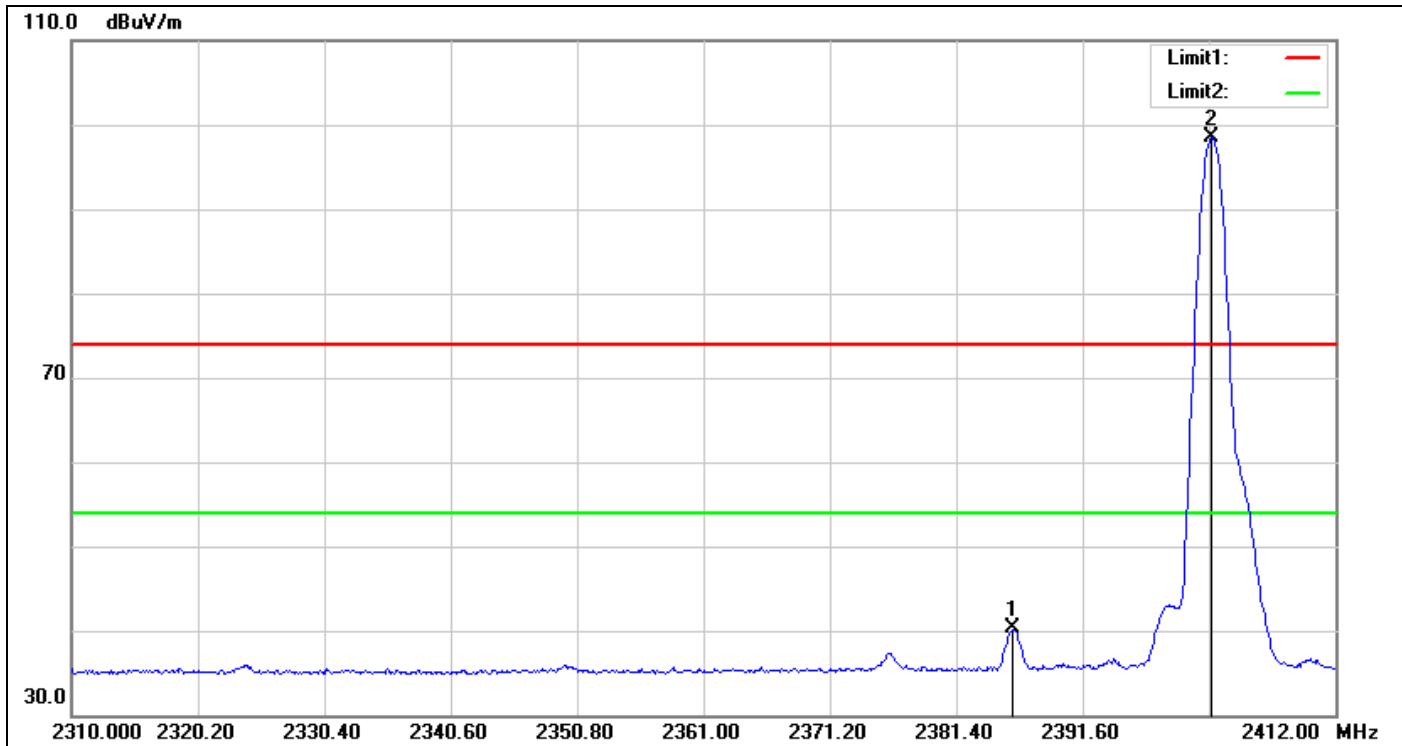

No.	Frequency (MHz)	Reading (dBuV)	Correct Factor(dB/m)	Result (dBuV/m)	Limit (dBuV/m)	Margin (dB)	Remark
1	2385.990	42.73	-2.53	40.20	54.00	-13.80	AVG
2	2402.004	100.85	-2.41	98.44	54.00	44.44	AVG

**Band Edges (CH Mid)**

**Detector mode: Peak**

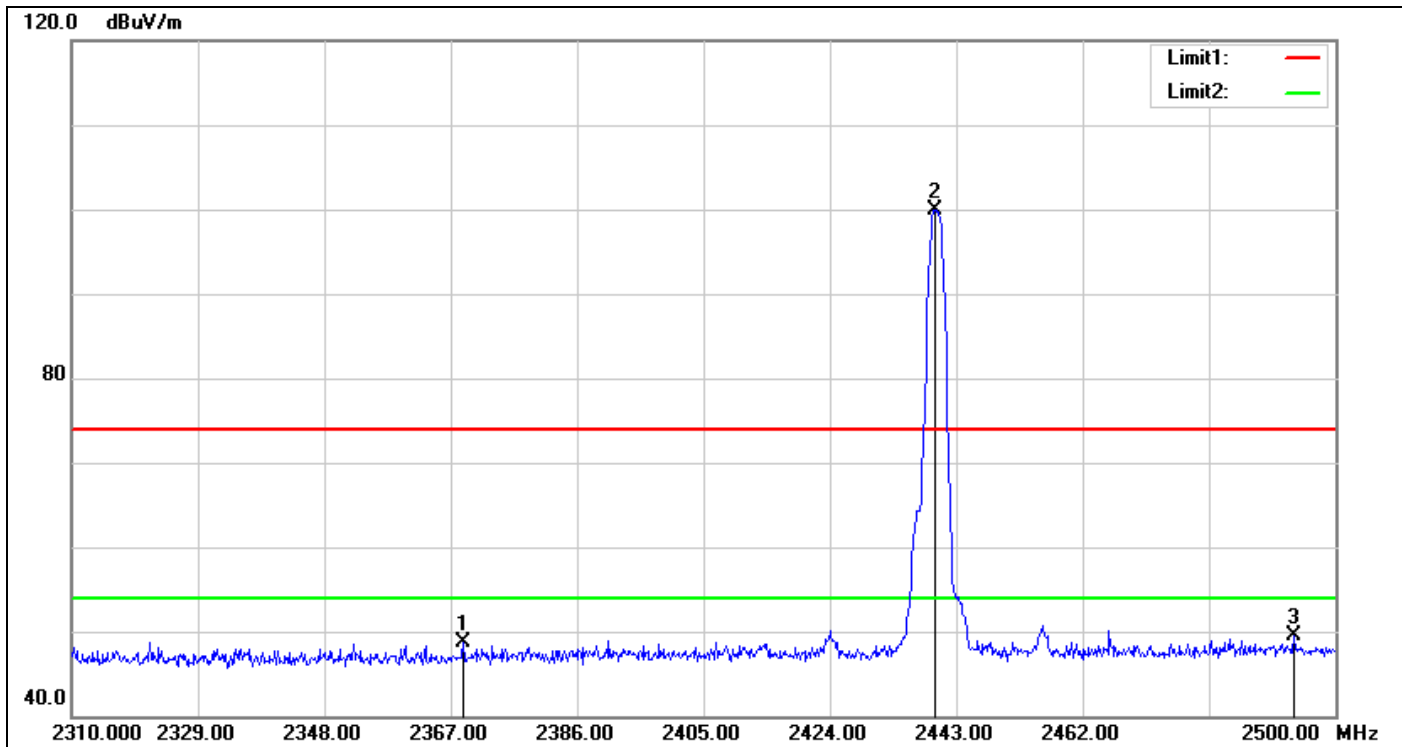

No.	Frequency (MHz)	Reading (dBuV)	Correct Factor(dB/m)	Result (dBuV/m)	Limit (dBuV/m)	Margin (dB)	Remark
1	2368.900	51.29	-2.67	48.62	74.00	-25.38	peak
2	2439.770	102.08	-2.21	99.87	74.00	25.87	peak
3	2493.730	51.38	-1.90	49.48	74.00	-24.52	peak

**Detector mode: AVG**

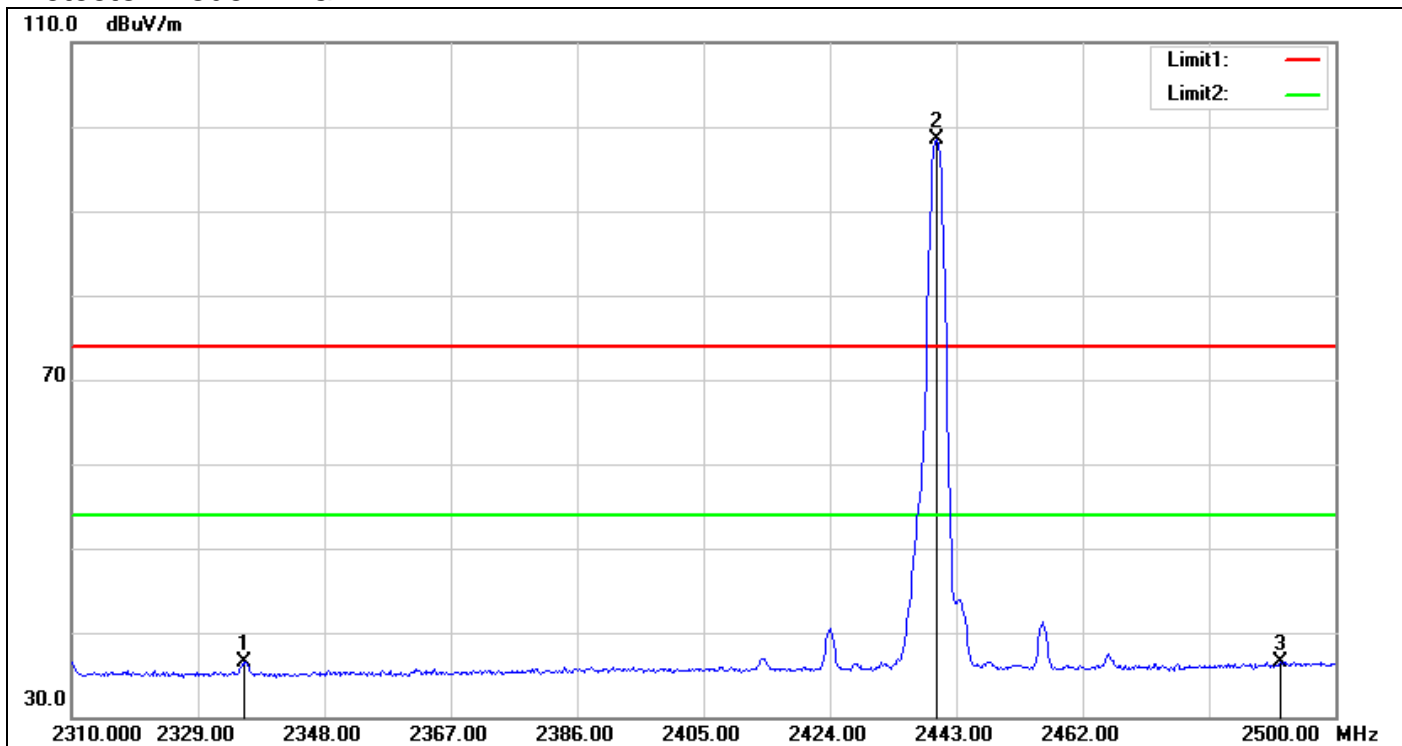

No.	Frequency (MHz)	Reading (dBuV)	Correct Factor(dB/m)	Result (dBuV/m)	Limit (dBuV/m)	Margin (dB)	Remark
1	2335.840	39.47	-2.95	36.52	54.00	-17.48	AVG
2	2439.960	100.77	-2.21	98.56	54.00	44.56	AVG
3	2491.640	38.42	-1.92	36.50	54.00	-17.50	AVG

**Band Edges (CH High)**

**Detector mode: Peak**

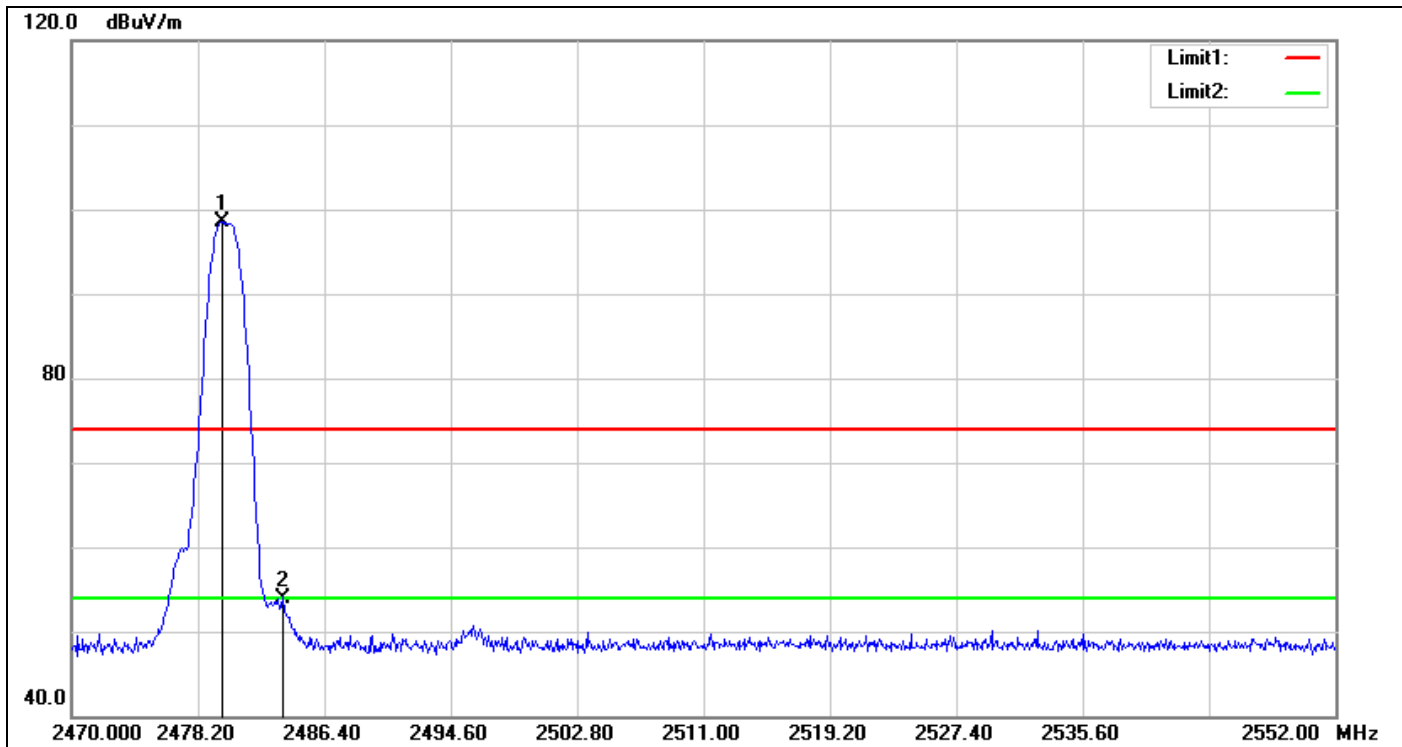

No.	Frequency (MHz)	Reading (dBuV)	Correct Factor(dB/m)	Result (dBuV/m)	Limit (dBuV/m)	Margin (dB)	Remark
1	2479.758	100.48	-2.03	98.45	74.00	24.45	peak
2	2483.694	55.99	-1.99	54.00	74.00	-20.00	peak

**Detector mode: AVG**

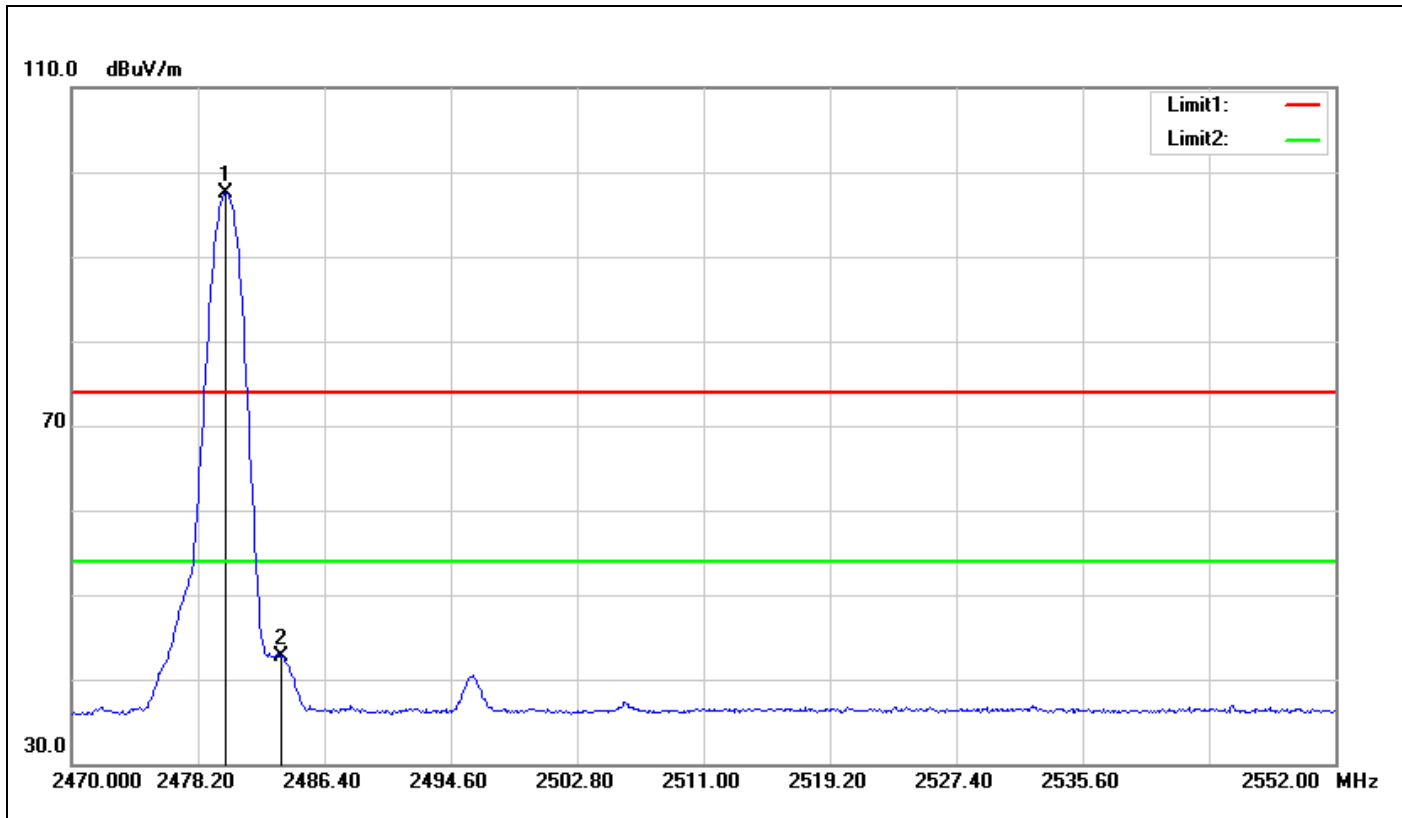

No.	Frequency (MHz)	Reading (dBuV)	Correct Factor(dB/m)	Result (dBuV/m)	Limit (dBuV/m)	Margin (dB)	Remark
1	2480.004	99.52	-2.03	97.49	54.00	43.49	AVG
2	2483.612	44.76	-1.99	42.77	54.00	-11.23	AVG

**Test Plot**

**Un-restricted Band Emissions (CH Low)**

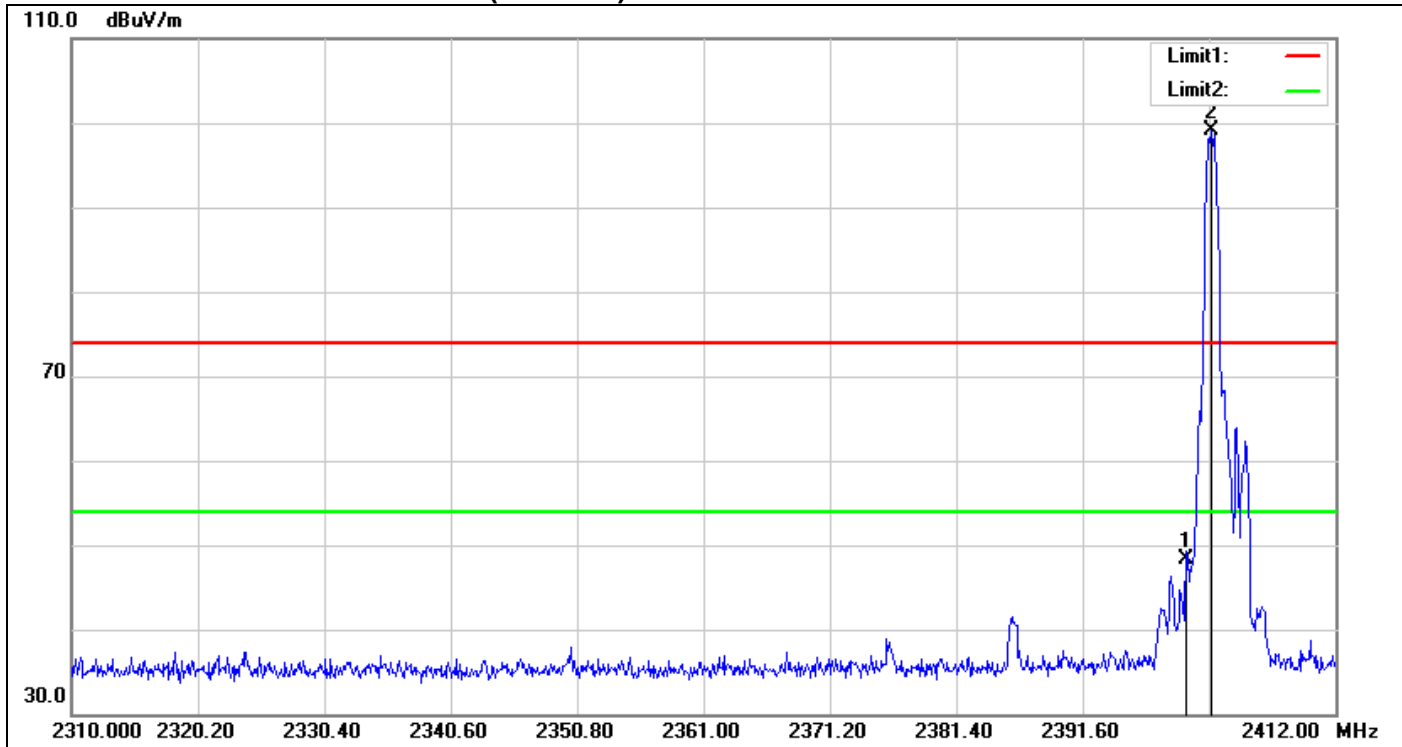

No.	Frequency (MHz)	Reading (dBuV)	Correct Factor(dB/m)	Result (dBuV/m)	Limit (dBuV/m)	Margin (dB)	Remark
1	2400.000	50.81	-2.41	48.40	74.00	-25.60	peak
2	2402.004	101.56	-2.41	99.15	74.00	25.15	peak

**Un-restricted Band Emissions (CH High)**

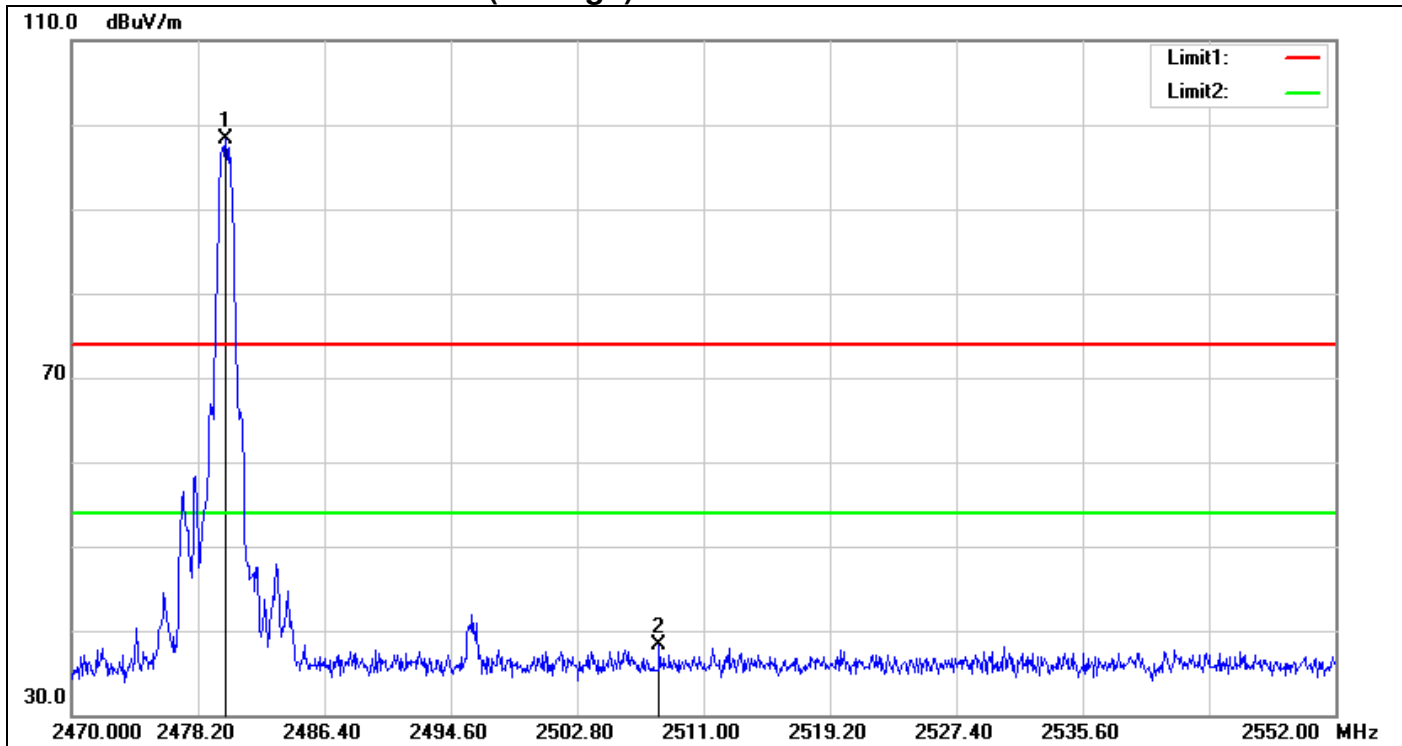

No.	Frequency (MHz)	Reading (dBuV)	Correct Factor(dB/m)	Result (dBuV/m)	Limit (dBuV/m)	Margin (dB)	Remark
1	2480.004	100.24	-2.03	98.21	74.00	24.21	peak
2	2508.130	40.04	-1.84	38.20	74.00	-35.80	peak

## 7.6 PEAK POWER SPECTRAL DENSITY

### LIMIT

1. According to §15.247(e) & RSS-247, for digitally modulated systems, the power spectral density conducted from the intentional radiator to the antenna shall not be greater than 8 dBm in any 3 kHz band during any time interval of continuous transmission.
2. According to §15.247(f) & RSS-247, the digital modulation operation of the hybrid system, with the frequency hopping turned off, shall comply with the power density requirements of paragraph (d) of this section.

### Test Configuration

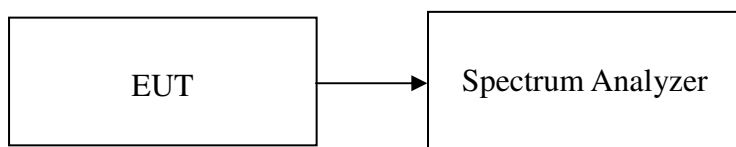

### TEST PROCEDURE

The transmitter output is connected to a spectrum analyzer. Set the RBW = 3 kHz, VBW = 30 kHz, span to 1.5 times the DTS bandwidth, Detector = peak, Trace mode = max hold, Sweep = auto couple. Use the peak marker function to determine the maximum amplitude level within the RBW.

### TEST RESULTS

*No non-compliance noted*

### Test Data

Channel	Frequency (MHz)	PPSD (dBm)	Limit (dBm)	Result
Low	2402	-15.88	8.00	PASS
Mid	2440	-15.00		PASS
High	2480	-14.52		PASS



### Test Plot

#### PPSD (CH Low)

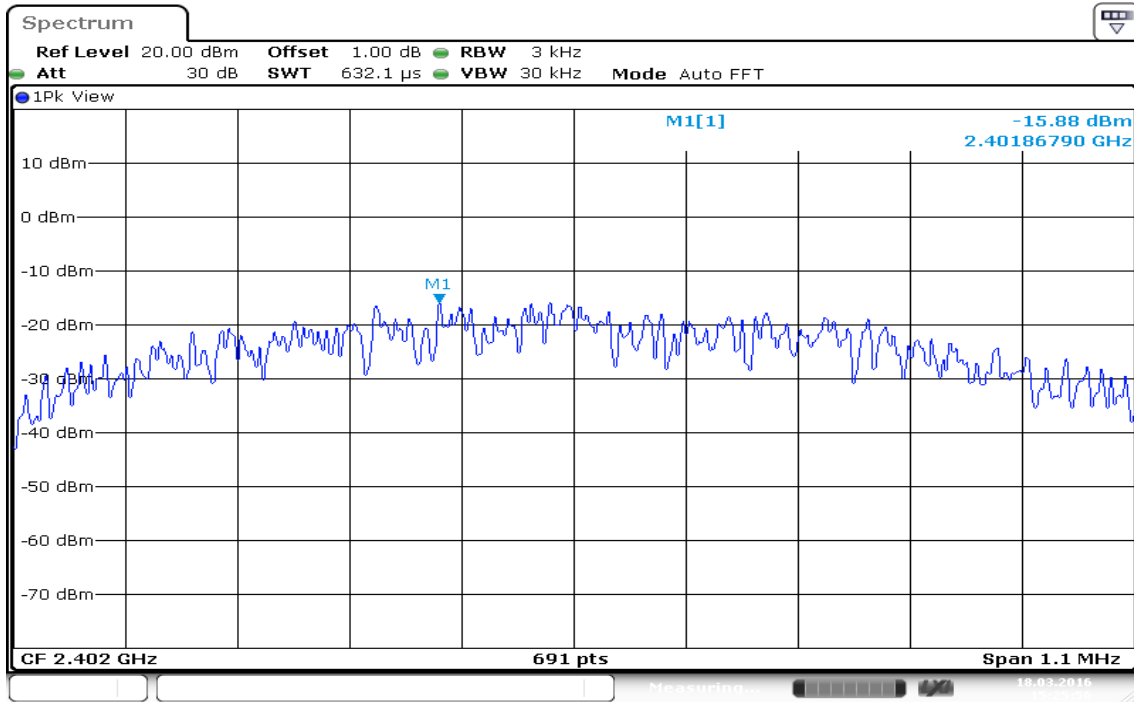

#### PPSD (CH Mid)

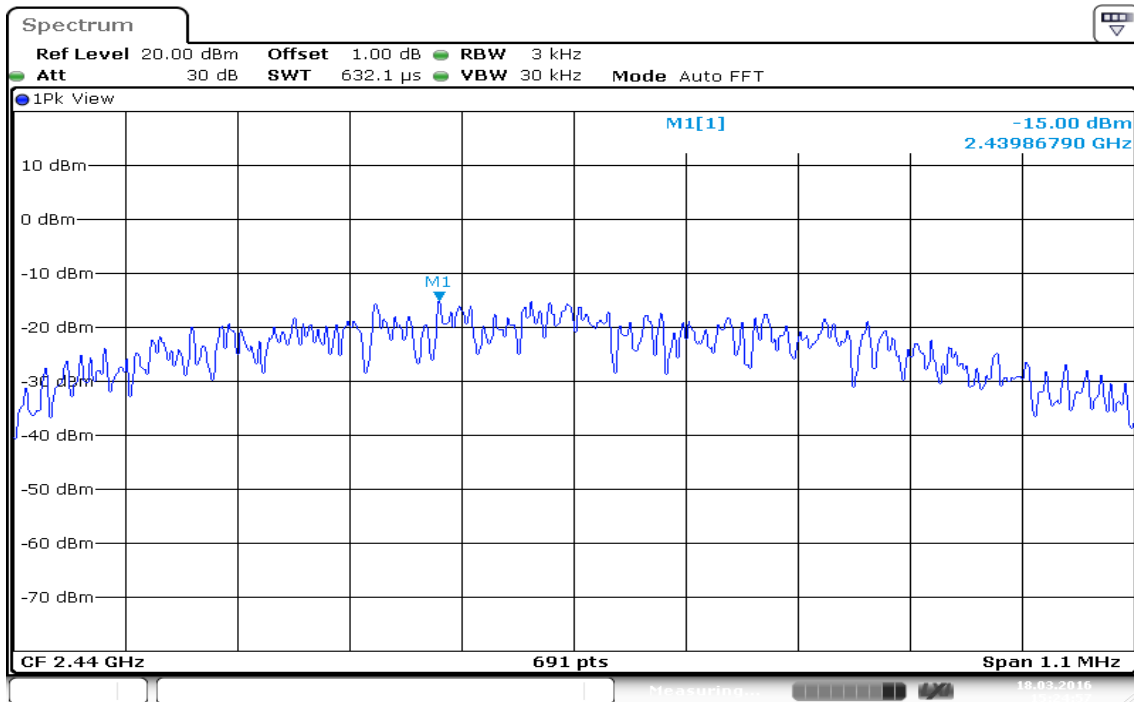

### PPSD (CH High)

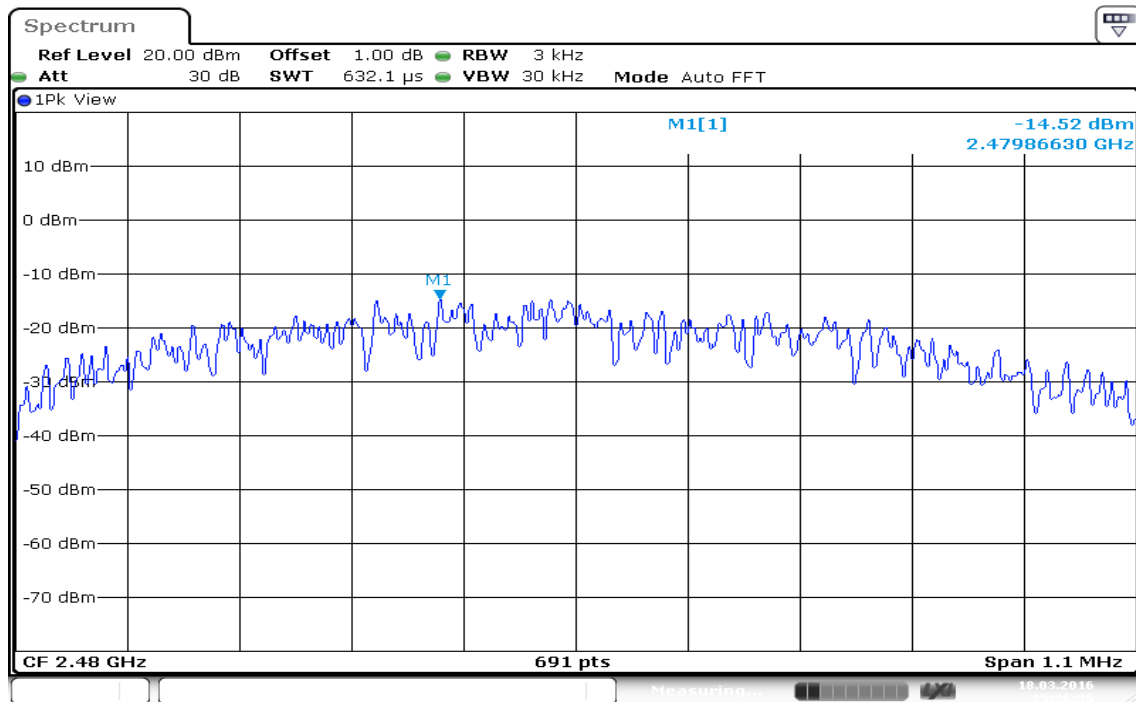

Date: 18.MAR.2016 15:26:36

## 7.7 RADIATED EMISSIONS

### LIMIT

All spurious emissions shall comply with the limits of §15.209(a) and RSS-Gen Table 2 & Table 5.

### RSS-Gen Table 2 & Table 5: General Field Strength Limits for Transmitters and Receivers at Frequencies Above 30 MHz <sup>(Note)</sup>

Frequency (MHz)	Field Strength microvolts/m at 3 metres (watts, e.i.r.p.)	
	Transmitters	Receivers
30-88	100 (3 nW)	100 (3 nW)
88-216	150 (6.8 nW)	150 (6.8 nW)
216-960	200 (12 nW)	200 (12 nW)
Above 960	500 (75 nW)	500 (75 nW)

**Note:** \*Measurements for compliance with limits in the above table may be performed at distances other than 3 metres, in accordance with Section 7.2.7.

Transmitting devices are not permitted in Table 1 bands or, unless stated otherwise, in TV bands (54-72 MHz, 76-88 MHz, 174-216 MHz, 470-608 MHz and 614-806 MHz).

### RSS-Gen Table 6: General Field Strength Limits for Transmitters at Frequencies Below 30 MHz (Transmit)

Frequency	Field Strength (microvolts/m)	Magnetic H-Field (microamperes/m)	Measurement Distance (metres)
9-490 kHz	2,400/F (F in kHz)	2,400/377F (F in kHz)	3000
490-1,705 kHz	24,000/F (F in kHz)	24,000/377F (F in kHz)	30
1.705-30 MHz	30	N/A	30

**Note:** The emission limits for the bands 9-90 kHz and 110-490 kHz are based on measurements employing an average detector.

**Test Configuration**

**9kHz ~ 30MHz**

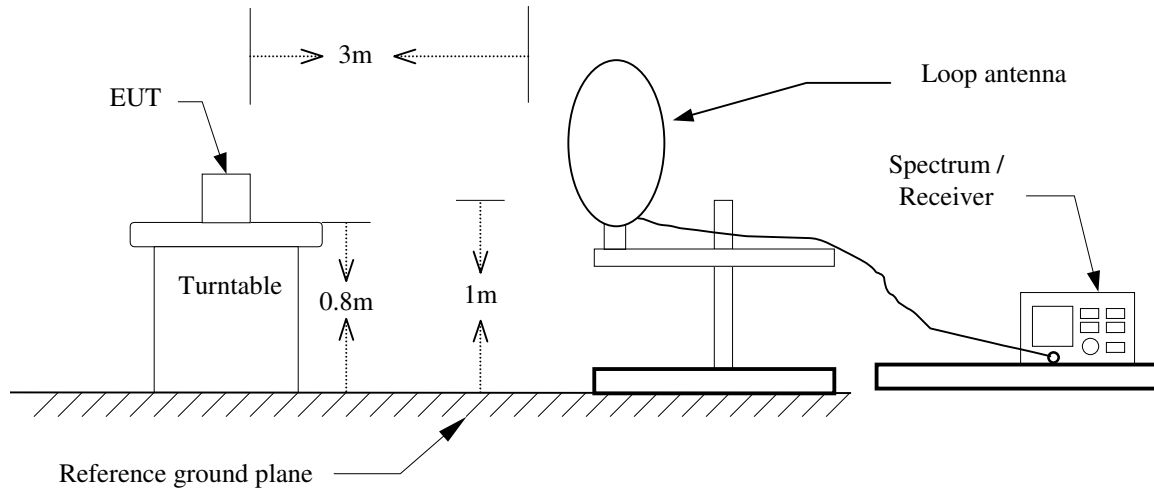

**30MHz ~ 1GHz**

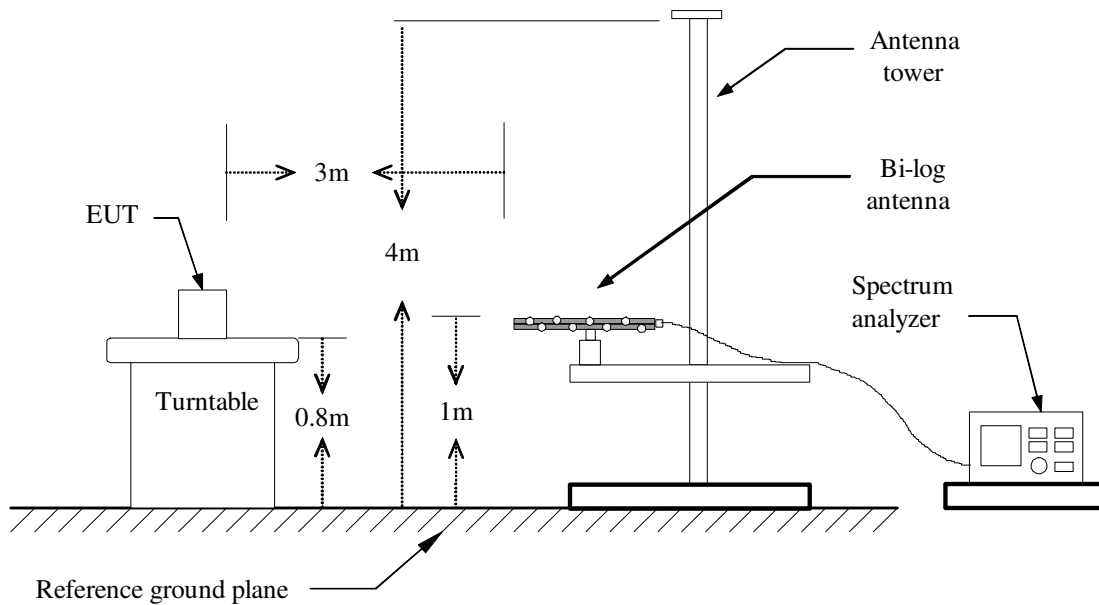

**Above 1 GHz**

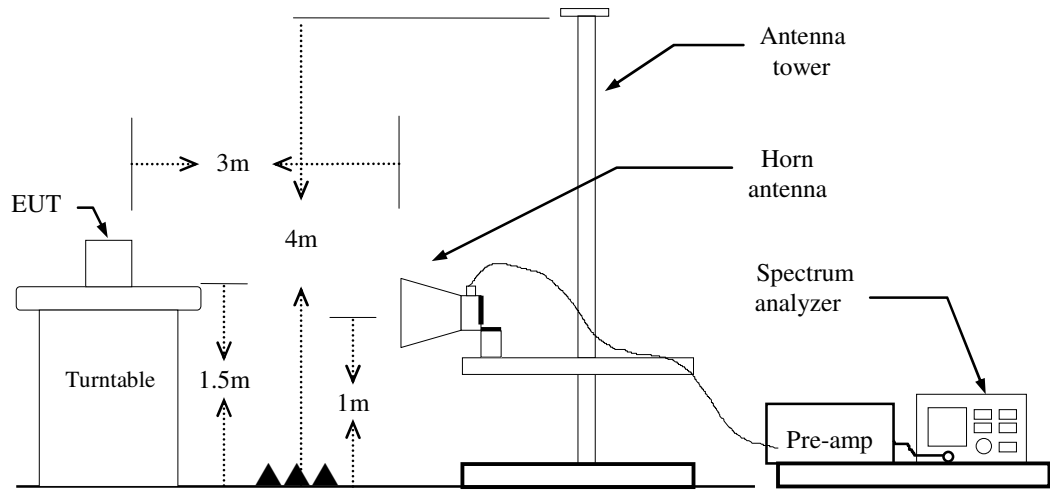

## **TEST PROCEDURE**

1. The EUT is placed on a turntable, Above 1 GHz is 1.5m high and below 1 GHz is 0.8m high above ground plane.
2. The turntable shall be rotated for 360 degrees to determine the position of maximum emission level.
3. EUT is set 3m away from the receiving antenna, which is varied from 1m to 4m to find out the highest emissions.
4. Maximum procedure was performed on the six highest emissions to ensure EUT compliance.
5. And also, each emission was to be maximized by changing the polarization of receiving antenna both horizontal and vertical.
6. Set the spectrum analyzer in the following setting as:

Below 1GHz:

RBW=100kHz / VBW=300kHz / Sweep=AUTO

Above 1GHz:

(a) PEAK: RBW=1MHz / VBW=3MHz / Sweep=AUTO

(b) AVERAGE: RBW=1MHz,  
if duty cycle  $\geq$  98%, VBW=10Hz.

if duty cycle < 98% VBW=1/T.

**BT4.0=72%, VBW= 2KHz**

7. Repeat above procedures until the measurements for all frequencies are complete.
8. Result = Spectrum Reading + cable loss(spectrum to Amp) - Amp Gain + Cable loss(Amp to receive Ant)+ Receive Ant

**Note:** We checked every harmonics frequencies from Fundamental frequencies with reduced VBW, and we mark a point to prove pass or not if we find any emission. For this case, there are no emissions hidden in the noise floor.

**Below 1GHz**

**Operation Mode:** Normal Link

**Test Date:** March 9, 2016

**Temperature:** 27°C

**Tested by:** Jason Lu

**Humidity:** 53% RH

**Polarity:** Ver.

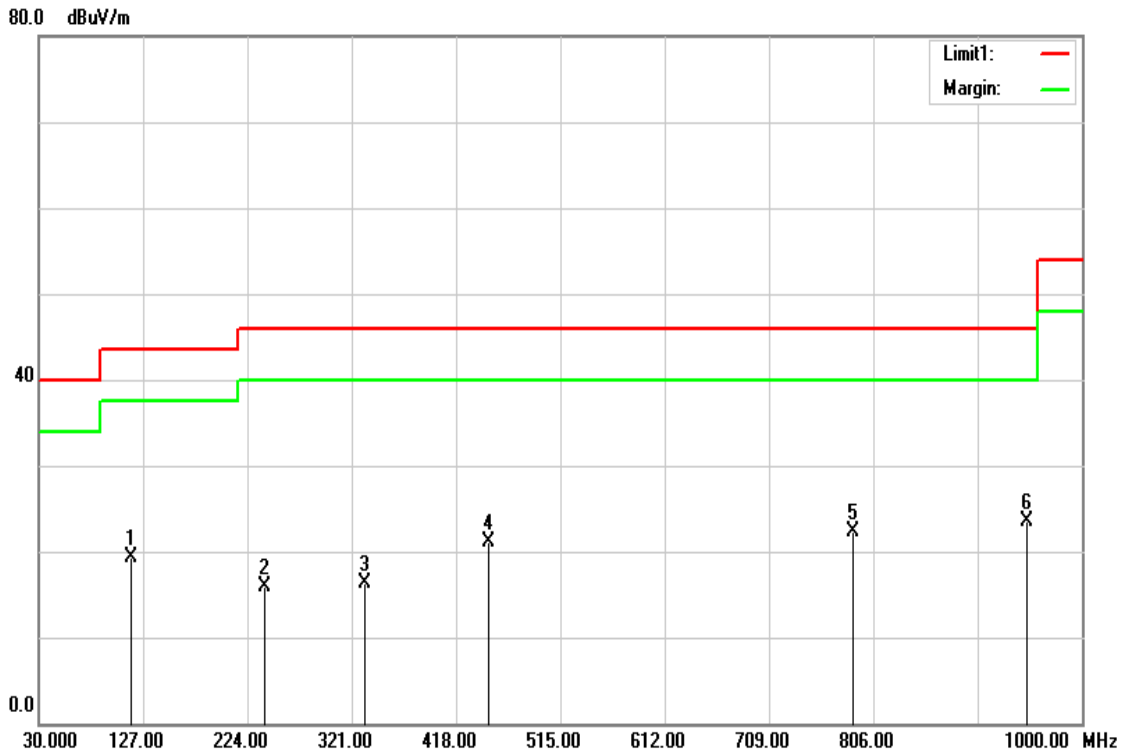

Frequency (MHz)	Reading (dBuV)	Correction Factor (dB/m)	Result (dBuV/m)	Limit (dBuV/m)	Margin (dB)	Remark	Ant. Pol. (H/V)
116.3300	35.41	-16.15	19.26	43.50	-24.24	peak	V
239.5200	32.42	-16.52	15.90	46.00	-30.10	peak	V
333.6100	29.63	-13.33	16.30	46.00	-29.70	peak	V
448.0700	31.42	-10.25	21.17	46.00	-24.83	peak	V
787.5700	26.94	-4.60	22.34	46.00	-23.66	peak	V
948.5900	26.01	-2.42	23.59	46.00	-22.41	peak	V

**Remark:**

1. Measuring frequencies from 30 MHz to the 1GHz.
2. Radiated emissions measured in frequency range from 30 MHz to 1000MHz were made with an instrument using peak/quasi-peak detector mode.
3. Quasi-peak test would be performed if the peak result were greater than the quasi-peak limit or as required by the applicant.
4. Measurements above show only up to 6 maximum emissions noted, or would be lesser, with " N/A " remark, if no specific emissions from the EUT are recorded (ie: margin>20dB from the applicable limit) and considered that's already beyond the background noise floor.
5. Margin (dB) = Result (dBuV/m) – Limit (dBuV/m).

**Operation Mode:** Normal Link

**Test Date:** March 9, 2016

**Temperature:** 27°C

**Tested by:** Jason Lu

**Humidity:** 53% RH

**Polarity:** Hor.

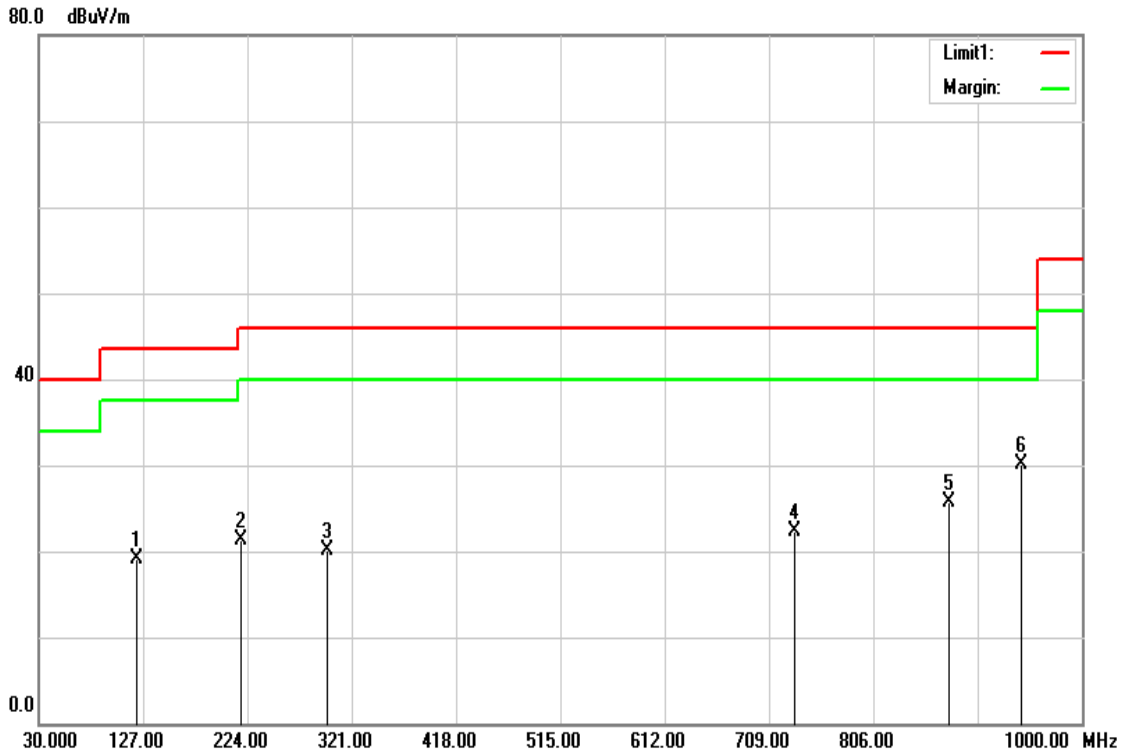

Frequency (MHz)	Reading (dBuV)	Correction Factor (dB/m)	Result (dBuV/m)	Limit (dBuV/m)	Margin (dB)	Remark	Ant. Pol. (H/V)
121.1800	34.69	-15.52	19.17	43.50	-24.33	peak	H
218.1800	38.08	-16.83	21.25	46.00	-24.75	peak	H
297.7200	34.32	-14.28	20.04	46.00	-25.96	peak	H
732.2800	27.57	-5.33	22.24	46.00	-23.76	peak	H
875.8400	29.19	-3.48	25.71	46.00	-20.29	peak	H
943.7400	32.59	-2.50	30.09	46.00	-15.91	peak	H

**Remark:**

1. Measuring frequencies from 30 MHz to the 1GHz.
2. Radiated emissions measured in frequency range from 30 MHz to 1000MHz were made with an instrument using peak/quasi-peak detector mode.
3. Quasi-peak test would be performed if the peak result were greater than the quasi-peak limit or as required by the applicant.
4. Measurements above show only up to 6 maximum emissions noted, or would be lesser, with " N/A " remark, if no specific emissions from the EUT are recorded (ie: margin>20dB from the applicable limit) and considered that's already beyond the background noise floor.
5. Margin (dB) = Result (dBuV/m) – Limit (dBuV/m).



**Above 1 GHz**

**GFSK / TX / CH Low**

**Polarity: Vertical**

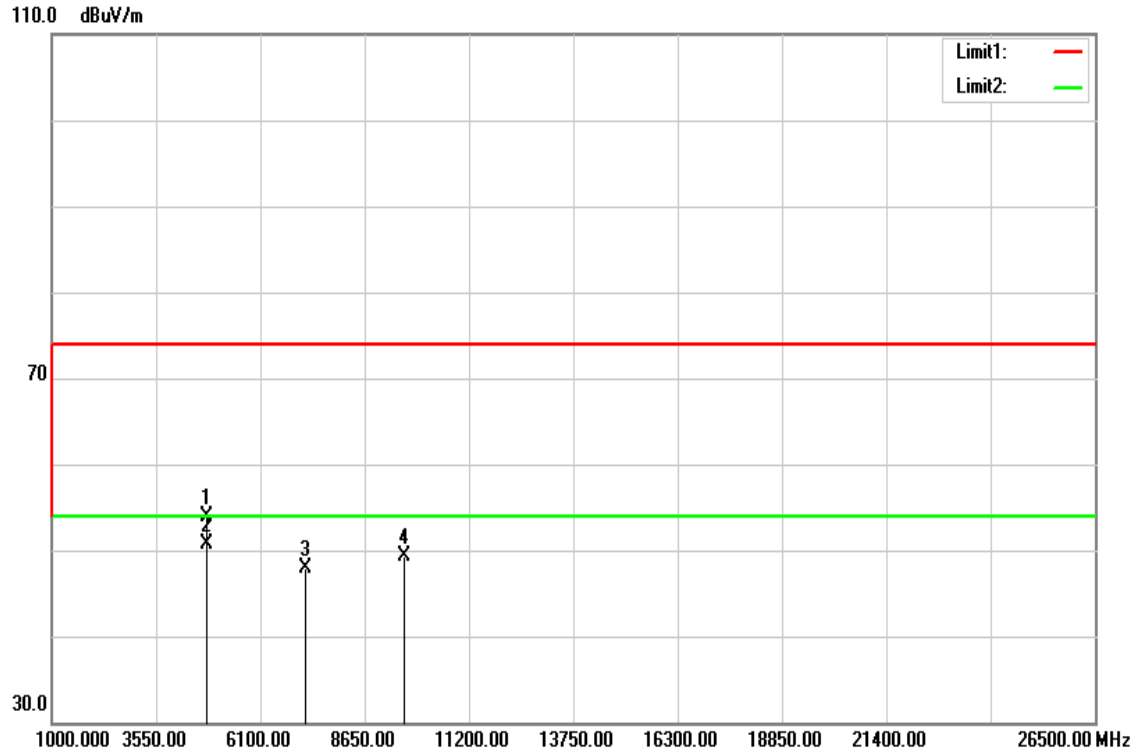

**Polarity: Horizontal**

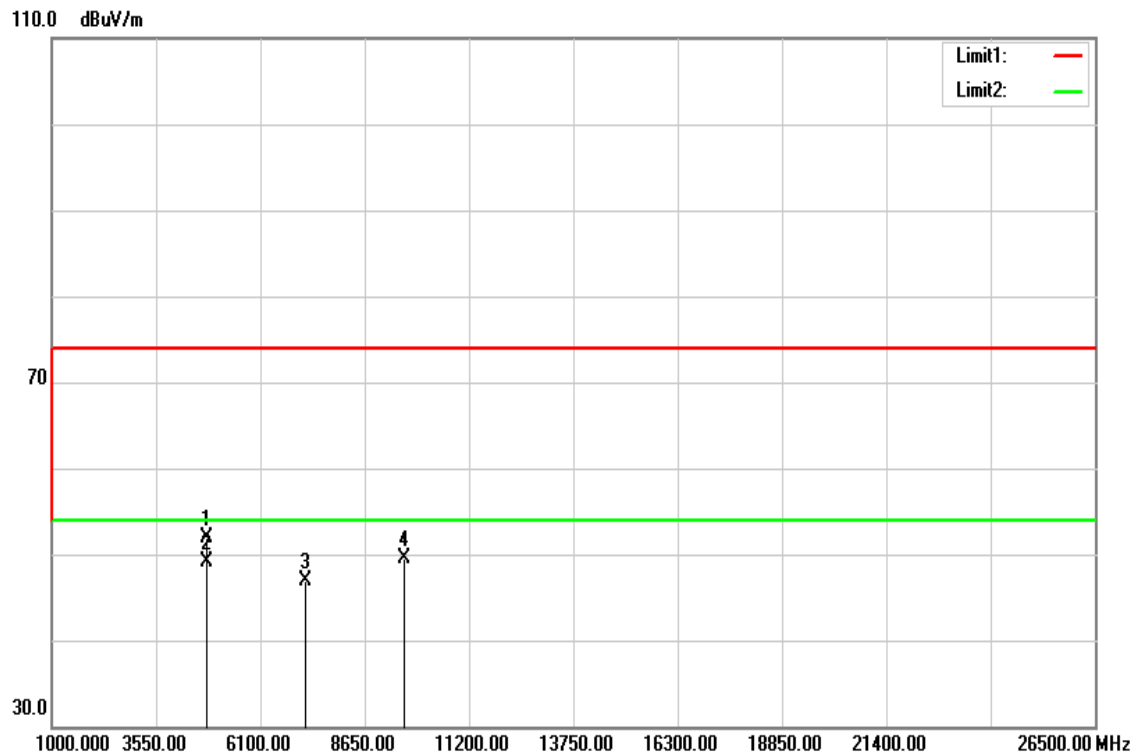

**Operation Mode:** GFSK / TX / CH Low    **Test Date:** March 3, 2016  
**Temperature:** 27 °C    **Tested by:** Jason Lu  
**Humidity:** 53 % RH    **Polarity:** Ver. / Hor.

Frequency (MHz)	Reading (dBuV)	Correction (dB/m)	Result (dBuV/m)	Limit (dBuV/m)	Margin (dB)	Remark	Ant.Pol. (H/V)
4806.000	48.76	5.05	53.81	74.00	-20.19	peak	V
4806.000	45.74	5.05	50.79	54.00	-3.21	AVG	V
7206.000	35.31	12.62	47.93	74.00	-26.07	peak	V
9608.000	31.63	17.60	49.23	74.00	-24.77	peak	V
N/A							
4806.000	46.83	5.05	51.88	74.00	-22.12	peak	H
4806.000	44.14	5.05	49.19	54.00	-4.81	AVG	H
7206.000	34.33	12.62	46.95	74.00	-27.05	peak	H
9608.000	31.99	17.60	49.59	74.00	-24.41	peak	H
N/A							

**Remark:**

1. Measuring frequencies from 1 GHz to the 10th harmonic of highest fundamental frequency.
2. Radiated emissions measured in frequency above 1000MHz were made with an instrument using peak/average detector mode.
3. Average test would be performed if the peak result were greater than the average limit or as required by the applicant.
4. Data of measurement within this frequency range shown " --- " in the table above means the reading of emissions are attenuated more than 20dB below the permissible limits or the field strength is too small to be measured.
5. Measurements above show only up to 6 maximum emissions noted, or would be lesser, with " N/A " remark, if no specific emissions from the EUT are recorded (ie: margin>20dB from the applicable limit) and considered that's already beyond the background noise floor.
6. Margin (dB) = Remark result (dBuV/m) – Average limit (dBuV/m).

**GFSK / TX / CH Mid**

**Polarity: Vertical**

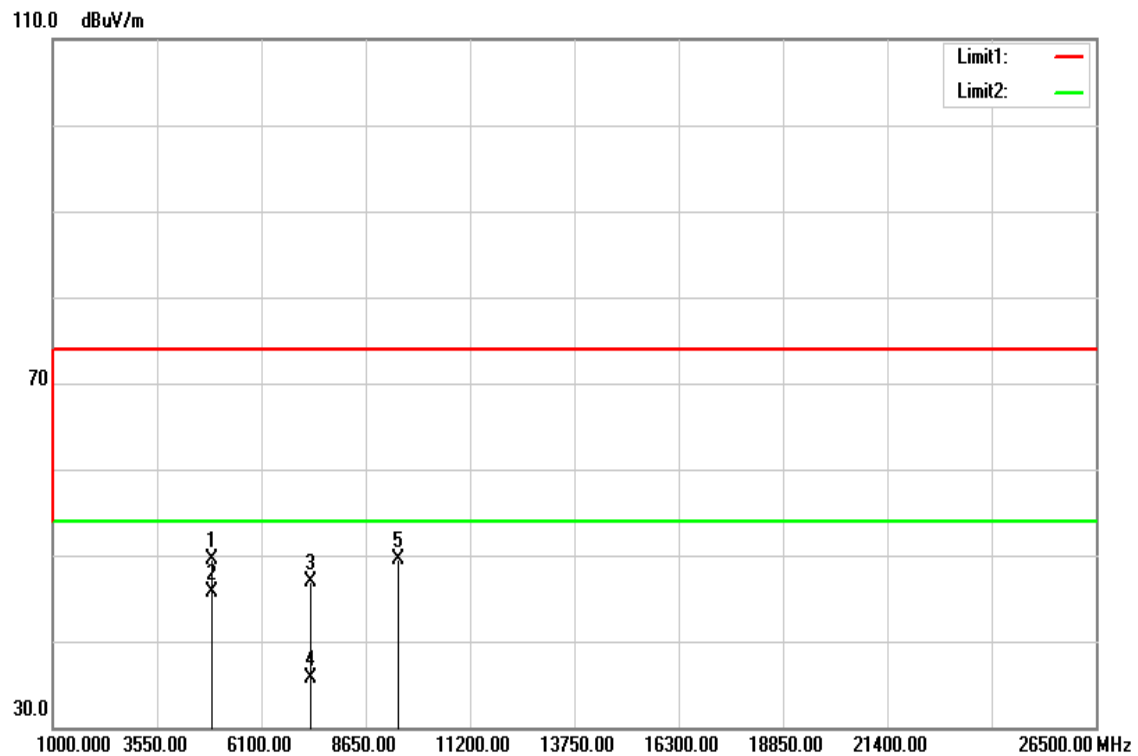

**Polarity: Horizontal**

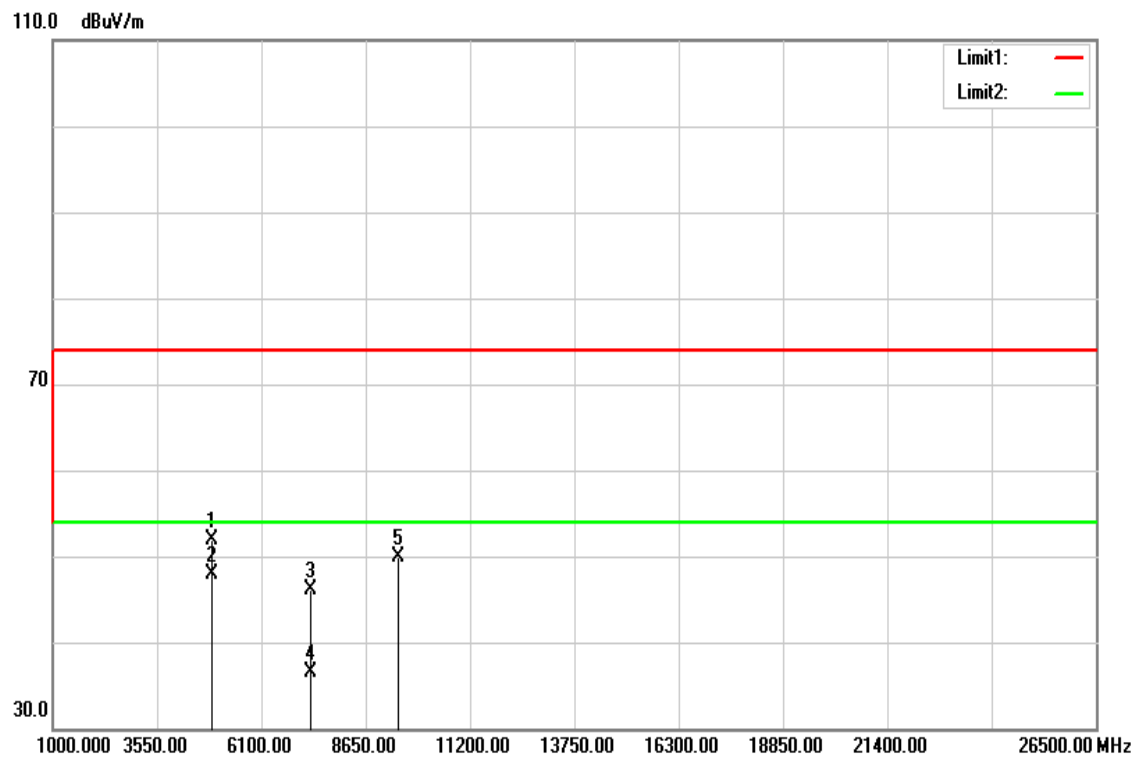

**Operation Mode:** GFSK / TX / CH Mid    **Test Date:** March 3, 2016  
**Temperature:** 27°C    **Tested by:** Jason Lu  
**Humidity:** 53 % RH    **Polarity:** Ver. / Hor.

Frequency (MHz)	Reading (dBuV)	Correction (dB/m)	Result (dBuV/m)	Limit (dBuV/m)	Margin (dB)	Remark	Ant.Pol. (H/V)
4880.000	44.35	5.25	49.60	74.00	-24.40	peak	V
4880.000	40.53	5.25	45.78	54.00	-8.22	AVG	V
7320.000	33.95	12.97	46.92	74.00	-27.08	peak	V
7320.000	22.72	12.97	35.69	54.00	-18.31	AVG	V
9460.000	31.97	17.47	49.44	74.00	-24.56	peak	V
N/A							
4880.000	46.62	5.25	51.87	74.00	-22.13	peak	H
4880.000	42.73	5.25	47.98	54.00	-6.02	AVG	H
7320.000	33.11	12.97	46.08	74.00	-27.92	peak	H
7320.000	23.47	12.97	36.44	54.00	-17.56	AVG	H
9460.000	32.50	17.47	49.97	74.00	-24.03	peak	H
N/A							

**Remark:**

1. Measuring frequencies from 1 GHz to the 10th harmonic of highest fundamental frequency.
2. Radiated emissions measured in frequency above 1000MHz were made with an instrument using peak/average detector mode.
3. Average test would be performed if the peak result were greater than the average limit or as required by the applicant.
4. Data of measurement within this frequency range shown " --- " in the table above means the reading of emissions are attenuated more than 20dB below the permissible limits or the field strength is too small to be measured.
5. Measurements above show only up to 6 maximum emissions noted, or would be lesser, with " N/A " remark, if no specific emissions from the EUT are recorded (ie: margin>20dB from the applicable limit) and considered that's already beyond the background noise floor.
6. Margin (dB) = Remark result (dBuV/m) – Average limit (dBuV/m).

**GFSK / TX / CH High**

**Polarity: Vertical**

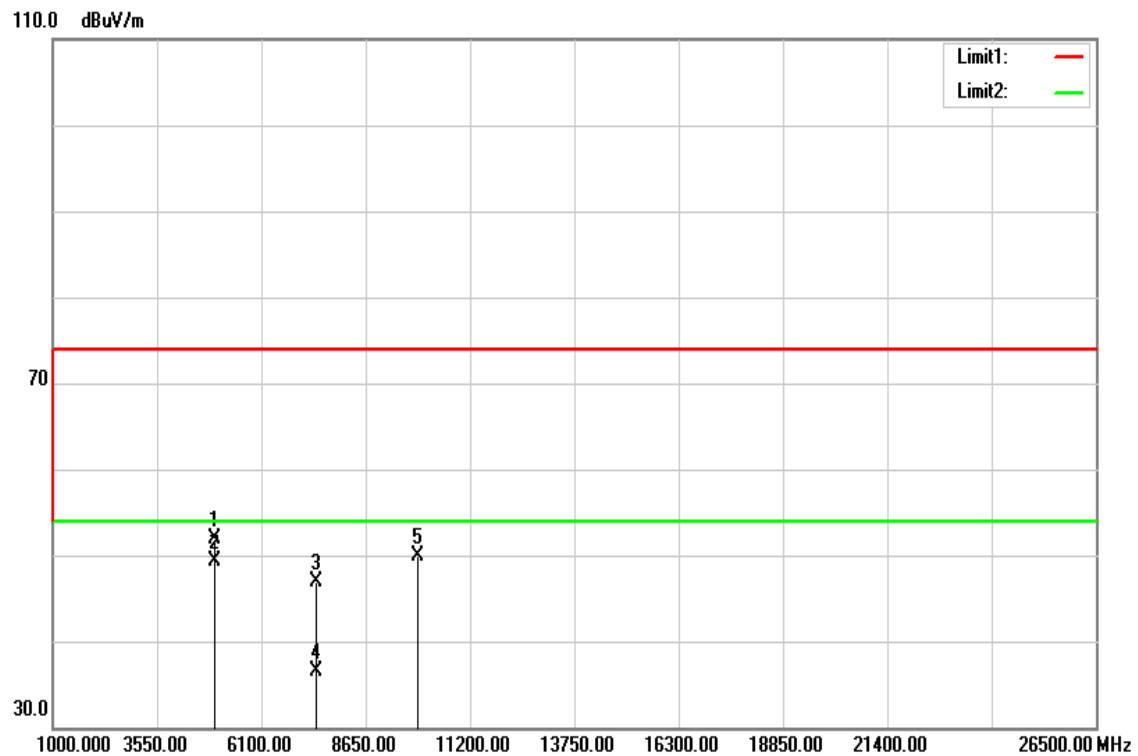

**Polarity: Horizontal**

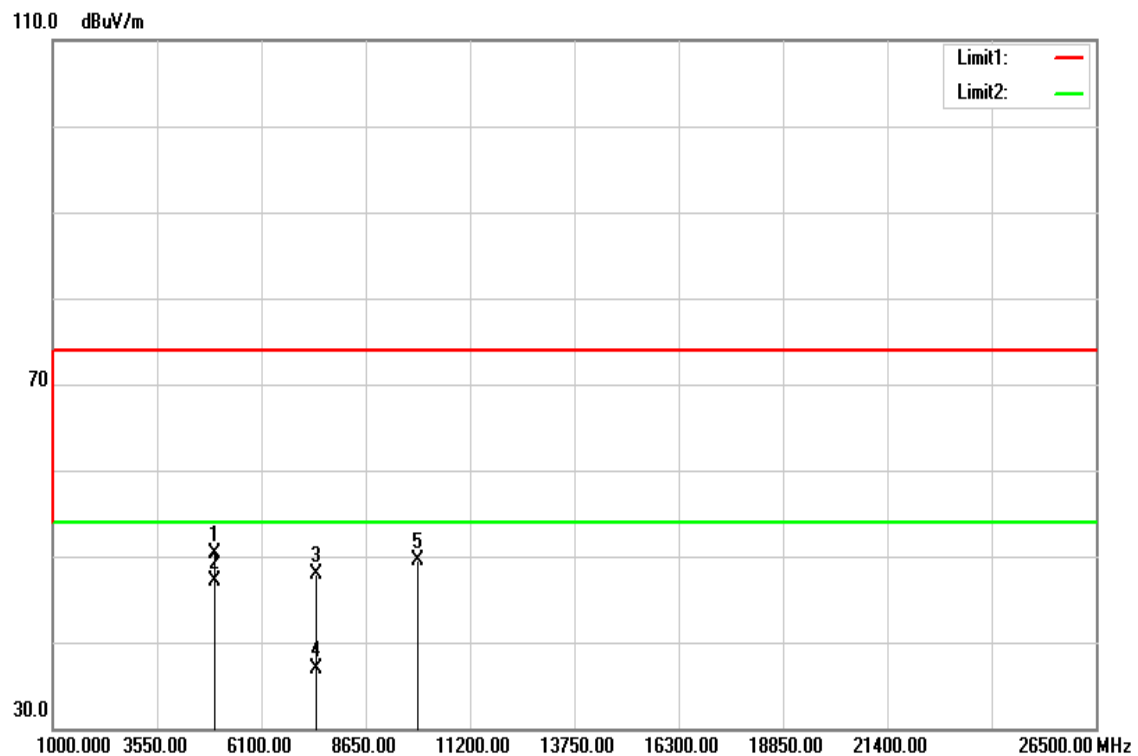

**Operation Mode:** GFSK / TX / CH High    **Test Date:** March 3, 2016  
**Temperature:** 27°C    **Tested by:** Jason Lu  
**Humidity:** 53 % RH    **Polarity:** Ver. / Hor.

Frequency (MHz)	Reading (dBuV)	Correction (dB/m)	Result (dBuV/m)	Limit (dBuV/m)	Margin (dB)	Remark	Ant.Pol. (H/V)
4960.000	46.52	5.46	51.98	74.00	-22.02	peak	V
4960.000	43.84	5.46	49.30	54.00	-4.70	AVG	V
7440.000	33.66	13.33	46.99	74.00	-27.01	peak	V
7440.000	23.11	13.33	36.44	54.00	-17.56	AVG	V
9920.000	32.37	17.60	49.97	74.00	-24.03	peak	V
N/A							
4960.000	44.80	5.46	50.26	74.00	-23.74	peak	H
4960.000	41.63	5.46	47.09	54.00	-6.91	AVG	H
7440.000	34.67	13.33	48.00	74.00	-26.00	peak	H
7440.000	23.48	13.33	36.81	54.00	-17.19	AVG	H
9920.000	31.96	17.60	49.56	74.00	-24.44	peak	H
N/A							

**Remark:**

1. *Measuring frequencies from 1 GHz to the 10th harmonic of highest fundamental frequency.*
2. *Radiated emissions measured in frequency above 1000MHz were made with an instrument using peak/average detector mode.*
3. *Average test would be performed if the peak result were greater than the average limit or as required by the applicant.*
4. *Data of measurement within this frequency range shown " --- " in the table above means the reading of emissions are attenuated more than 20dB below the permissible limits or the field strength is too small to be measured.*
5. *Measurements above show only up to 6 maximum emissions noted, or would be lesser, with " N/A " remark, if no specific emissions from the EUT are recorded (ie: margin>20dB from the applicable limit) and considered that's already beyond the background noise floor.*
6. *Margin (dB) = Remark result (dBuV/m) – Average limit (dBuV/m).*

## 7.8 POWERLINE CONDUCTED EMISSIONS

### LIMIT

According to §15.207(a) & RSS-Gen §7.2.4, except as shown in paragraphs (b) and (c) of this section, for an intentional radiator that is designed to be connected to the public utility (AC) power line, the radio frequency voltage that is conducted back onto the AC power line on any frequency or frequencies within the band 150 kHz to 30 MHz shall not exceed the limits in the following table, as measured using a 50  $\mu$ H/50 ohms line impedance stabilization network (LISN). Compliance with the provisions of this paragraph shall be based on the measurement of the radio frequency voltage between each power line and ground at the power terminal. The lower limit applies at the boundary between the frequency ranges.

Frequency Range (MHz)	Limits (dB $\mu$ V)	
	Quasi-peak	Average
0.15 to 0.50	66 to 56*	56 to 46*
0.50 to 5	56	46
5 to 30	60	50

### Test Configuration

See test photographs attached in Appendix II for the actual connections between EUT and support equipment.

### TEST PROCEDURE

1. The EUT was placed on a table, which is 0.8m above ground plane.
2. Maximum procedure was performed on the six highest emissions to ensure EUT compliance.
3. Repeat above procedures until all frequency measured were complete.

## **TEST RESULTS**

The initial step in collecting conducted data is a spectrum analyzer peak scan of the measurement range. Significant peaks are then marked as shown on the following data page, and these signals are then quasi-peaked.

### **Test Data**

**Operation Mode:** Normal Link                      **Test Date:** March 14, 2016  
**Temperature:** 24 °C                                      **Tested by:** Dennis Li  
**Humidity:** 50% RH

Freq. (MHz)	QP Reading (dBuV)	AV Reading (dBuV)	Corr. factor (dB/m)	QP Result (dBuV/m)	AV Result (dBuV/m)	QP Limit (dBuV)	AV Limit (dBuV)	QP Margin (dB)	AV Margin (dB)	Note
0.1500	48.61	36.93	9.69	58.30	46.62	65.99	56.00	-7.69	-9.38	L1
0.1780	31.31	6.47	9.68	40.99	16.15	64.57	54.58	-23.58	-38.43	L1
0.2220	37.41	28.17	9.68	47.09	37.85	62.74	52.74	-15.65	-14.89	L1
0.2940	32.59	22.52	9.68	42.27	32.20	60.41	50.41	-18.14	-18.21	L1
3.5980	19.67	9.87	9.81	29.48	19.68	56.00	46.00	-26.52	-26.32	L1
23.9380	28.15	20.30	9.95	38.10	30.25	60.00	50.00	-21.90	-19.75	L1
0.1500	47.67	36.07	9.64	57.31	45.71	65.99	56.00	-8.68	-10.29	L2
0.1860	29.91	9.69	9.64	39.55	19.33	64.21	54.21	-24.66	-34.88	L2
0.2180	37.04	28.18	9.64	46.68	37.82	62.89	52.89	-16.21	-15.07	L2
0.2940	32.11	22.21	9.64	41.75	31.85	60.41	50.41	-18.66	-18.56	L2
3.4420	23.63	17.56	9.76	33.39	27.32	56.00	46.00	-22.61	-18.68	L2
23.9420	26.17	18.38	9.98	36.15	28.36	60.00	50.00	-23.85	-21.64	L2

**Remark:**

1. Measuring frequencies from 0.15 MHz to 30MHz.
2. The emissions measured in frequency range from 0.15 MHz to 30MHz were made with an instrument using Quasi-peak detector and average detector.
3. The IF bandwidth of SPA between 0.15MHz and 30MHz was 10 kHz; the IF bandwidth of Test Receiver between 0.15MHz and 30MHz was 9 kHz;
4. L1 = Line One (Live Line) / L2 = Line Two (Neutral Line)



**Test Plots**

**Conducted emissions (Line 1)**

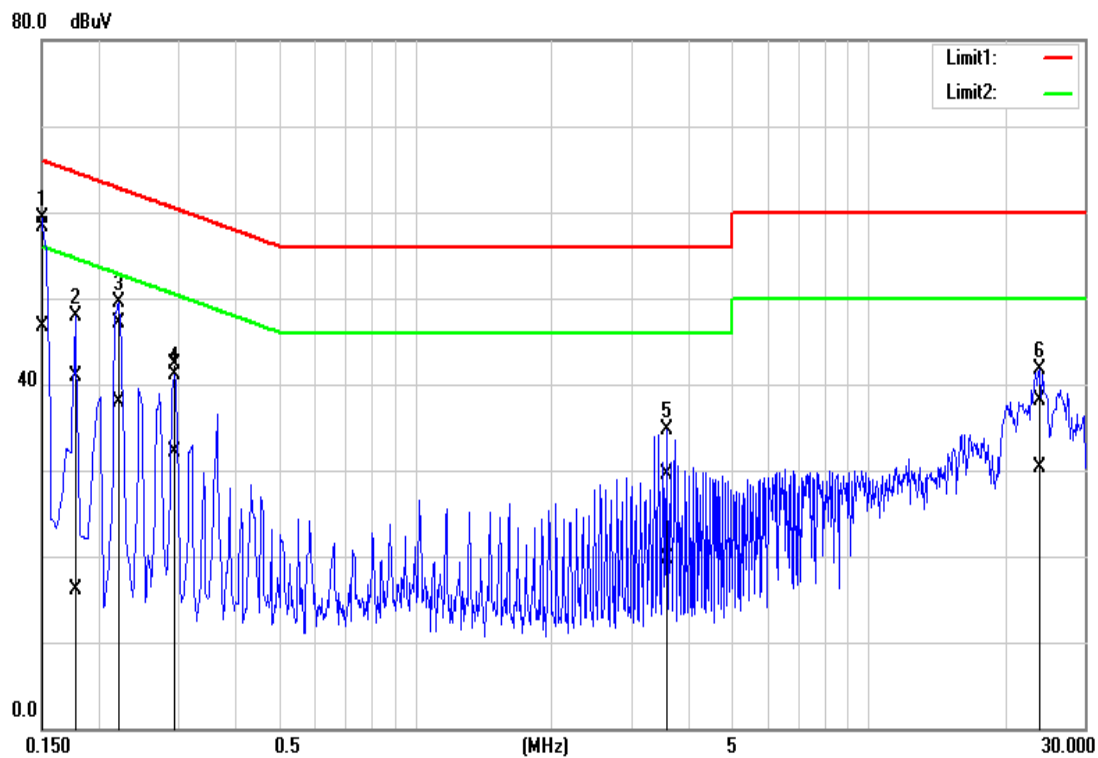

**Conducted emissions (Line 2)**

